



# FREE PUBLIC LIBRARY

## DUNSTABLE, MASS.

---

---

Class, 790 B

When Placed in Library.....Rebound 19 27

---

---

### Abstract of Library Rules



The Library will be open on Wednesdays from 2 to 4 p. m., and on Saturdays from 7 to 8.30 p. M., except on legal holidays and the first week in March.

All books must be returned to the Library on or before the last Library day in February, under a penalty of twenty-five cents for each book not so returned.

Books may be kept from the Library three weeks, unless otherwise directed by the Librarian.

Books that have been in the Library one year may be once renewed. Unbound magazines may be kept one week only.

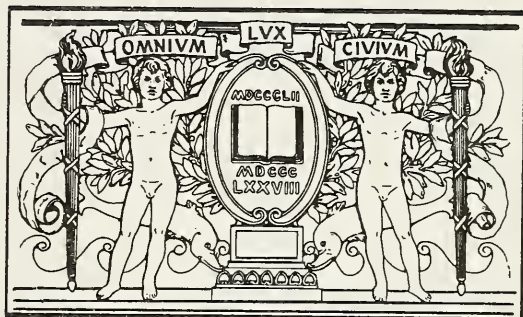

**BOSTON  
PUBLIC  
LIBRARY**







8847<sup>2</sup> 12

THE JACK OF ALL TRADES

OR

NEW IDEAS FOR AMERICAN BOYS

*BOOKS BY DANIEL C. BEARD*

THE JACK OF ALL TRADES; or, NEW IDEAS  
FOR AMERICAN BOYS. Profusely Illustrated by  
the Author. Square 8vo. \$2.00.

THE OUTDOOR HANDY BOOK, FOR PLAY-  
GROUND, FIELD AND FOREST. With 300 Illus-  
trations by the Author. *New Edition.* Square  
8vo. \$2.00.

THE AMERICAN BOY'S HANDY BOOK;  
or, WHAT TO DO AND HOW TO DO IT. With  
more than 300 Illustrations by the Author.  
Square 8vo. \$2.00.

---

*BY THE MISSES BEARD*

THE AMERICAN GIRL'S HANDY BOOK;  
or, HOW TO AMUSE YOURSELF AND OTHERS.  
With more than 300 Illustrations. *New and  
Enlarged Edition.* Square 8vo. \$2.00.



New  
Ideas  
for  
American  
Boys

· THE : JACK ·  
· OF : ALL : TRADES ·

BY

D.C. Beard  
New York

Charles  
Scribner's  
Sons.

1907

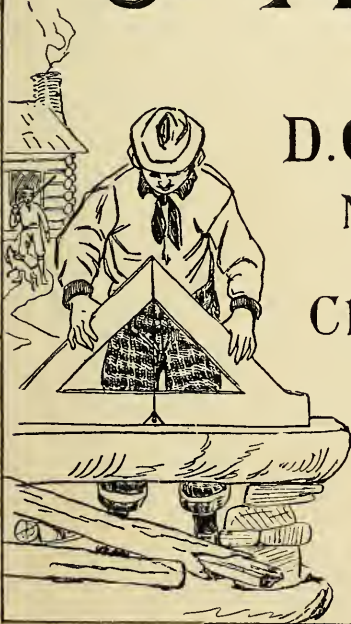

JORDAN  
TT160  
.B36

COPYRIGHT, 1900, BY  
CHARLES SCRIBNER'S SONS  
3164

SPECIAL NOTICE

The publishers hereby give warning that the unauthorized printing of any portion of the text of this book, and the reproduction of any of the illustrations or diagrams, are expressly forbidden.

## PREFACE.

IT was not the author's original intention to produce a series of boys' books. On the contrary, he expected that his work in this line would begin and end with "The American Boy's Handy Book."

The great popularity of that book is a constant source of gratification and pleasure to the author; but he was not a little surprised and embarrassed when he discovered that in place of satisfying the lads he had only whetted their appetite for more material in the same line. Letters from boys in many parts of the British Provinces, and from all over the United States, convinced the writer that he had yet work to do for them, and the revised and enlarged edition of "The American Boy's Handy Book" was issued. After a brief period of time the quaintly worded letters in boyish handwriting began again to increase the mail left at the author's studio, and this time he laid aside his brush and pencil to produce "The Outdoor Handy Book."

It is hoped that the present demand for new ideas for boys will be fully satisfied by "The Jack of All Trades." To the best of the author's knowledge and belief there is not a thing described in this book which has not been proved practical by the experiments of himself or some boy

or boys. Parts of this book have appeared in various periodicals, but all these chapters have been revised and enlarged.

It is now a generally accepted truth that the so-called skill of the hand is in reality the skill of a trained mind. The necessity, in work or play, of constantly overcoming new obstacles and solving new problems, develops a strong and normal mind and body. There can be little doubt that the rude schooling and hard knocks of a pioneer's life rejuvenated our race and developed those qualities in the characters of Americans, without which Washington would have been but a country gentleman and Lincoln a village store-keeper. Had little Abe Lincoln been reared under the care of a foreign woman with cap and ribbons (*i.e.* a French nurse), his strong manly character would never have been developed and our country would have lost one of its grandest patriots and history its most unique figure.

Aside from these vitally important facts, art demands that our youth should be encouraged to do things for themselves, to produce things by their own labor. The most finished product of the machine cannot appeal to the heart of a real artist as does some useful and homely object which still bears the marks of its maker's hands.

For these reasons the author hopes that parents will allow their boys to be boyish boys; and in order to keep them out of mischief they will cater to the lads' natural and healthy desire for entertainment by encouraging them in all rational projects and supplying them with tools and



---

materials, so that the boys may all become juvenile Jacks of All Trades.

It is the object of the author, in the chapters devoted to animal life, to teach the boys to look upon all animals with the same thoughtful kindness with which they might view their own undeveloped brothers.

To Harper & Brothers, and to *The Ladies' Home Journal* the thanks of the author are due for the careful preservation and return of such original drawings as were used by them in their respective publications, and without which this work would be incomplete.

D. C. B.

FLUSHING, June 1, 1900.





# CONTENTS.

---

## PART I.

### FAIR WEATHER IDEAS.

#### CHAPTER I.

	PAGE
TREE-TOP CLUB HOUSES.....	3
The River Rats, 5; A Tree-top Retreat, 6; The Secret Grape-vine Route, 7; A Club-house in the Tree-tops, 8; A Two-tree House, 9; How to Build the Foundation, 14; The One-tree House, 16; A Three- and Four-tree Foundation, 18.	

#### CHAPTER II.

HUNTING WITHOUT A GUN.....	19
How to Capture and Trap Small Live Animals, 19; Rodents or Gnawers, 21; A Smudge, 22; Flying Squirrels, 23; White-footed Mice, 25; Short-tailed Meadow-rats, 26; Jumping Mice, 27; Woodchucks, 27; A Box Trap, 30; Musk-rats, 31.	

#### CHAPTER III.

THE BACK-YARD ZOO.....	33
The Study of Living Animals, 33; Size of Lot, 35; Galvanized Iron Wire Cloth or Netting, 36; The Mesh, 36; To Make a Cage of Galvanized Wire Netting, 39; The Door, 40; The Doors for the Runway, 40; Toads, 43; Frogs, 44; Peepers, 44; The Tree-frog, 45; The Anderson Frog, 45; Lizards, 45.	

## CHAPTER IV.

	PAGE
A BACK-YARD FISH-POND.....	48
How to Make a Fish-pond, 48; By Sinking a Wooden Tank in the Ground, 49; Best Form for Such a Tank, 49; To Prevent Wood from Decay, 50; When to Stock, 52; Fresh-water Clams, 53.	

## CHAPTER V.

PIGEON LOFTS AND BANTAM COOPS.....	54
A Pigeon Loft and Bantam Coop, 55; Lumber, 56; Pigeon-loft Floor, 56; Shutter Frames, 56; Roofing Material, 57; Doors, 58; The Shutters, 59; Cleanliness, 59; The Hen's Nest, 59; The Pigeon's Nest, 60; For a Hen Roost, 60; Drinking Troughs, 61; Flying Cage, 62.	

## CHAPTER VI.

HOW TO MAKE A BACK-YARD AVIARY.....	63
Birds' Nests in Washington's Coat, 63; Nests in Speaking Horn, 63; A Woodpecker's House, 64; Martin Houses, 66; The Wren House, 66; Tin-can Bird-house, 68; A House of Straw, 68; A Barrel for a Martin House, 68.	

## CHAPTER VII.

A BOY'S BACK-YARD WORKSHOP.....	72
How to Make Buildings Plumb and Level, 72; Tools, 73; A Level, 74; A Foundation, 76; How to Build the House, 77; Corner Posts, 81; The Window, 82; Side Plate, 82; The Rafters, 84; Machine-Shop, 85; Tool Rack, 86.	

## CHAPTER VIII.

HOW TO BUILD AN UNDERGROUND CLUB-HOUSE.....	89
A Doorway at the Top, 89; The Trap-door, 90; Dimensions of House, 90; New Lumber, 92; Framing, 92; Passageway, 93; Windows, 94; The Roof, 94; A Ventilator, 95; Dangerous Caves, 96.	

CHAPTER IX.

	PAGE
A. BOYS' CLUB-HOUSE ON THE WATER.....	97
Crusoe Clubs, 97; Foundation of Club-house, 97; The Building Material, 98; The Foundation Posts, 100; The Bottom of the Pond, 101; Temporary Diagonal Braces, 103; An Artificial Island, 104.	

CHAPTER X.

HOW TO HAVE FUN ON A PICNIC.....	105
Joggling Board, 105; Turnpike Loo, 106; Dinner Box, 106; Rhode Island Clam Bake, 107; Pennsylvania Pond Stew, 107; Burgoo, 107; How to Cook a Burgoo, 108; A Game of Jack Fagots, 110; Old Dan Tucker, 110; Pitch-peg-pin Pitching, 112; Lawn Hab-enihan, 114.	

CHAPTER XI.

HOW TO BUILD AND HOW TO FURNISH A DANIEL BOONE CABIN.....	116
The Ghosts of the Fireplace, 116; The Log House, 118; Suitable Timber, 118; The "Skid," 118; The Foundation, 120; Floor Joists, 120; Floor Supports, 120; Log Rolling, 121; Door and Window Openings, 121; The Fireplace, 122; The Roof, 123; The Bunks, 123; A Lincoln Bed, 124; The Door, 125; The Lamp, 127; The Chimney, 130; A Table, 131; General Camp Notes for Old Boys, 132; How the Women Should Dress, 133; The Requirements for a Camp, 133; Making the Shack, 135; The Brush Covered Lean-to, 136; Tents with Roofed Verandas, 136; What is needed for Table and Larder, 137.	

CHAPTER XII.

FLAT-BOTMAN'S HORN.....	137
Whittling, 137; Wooden Bugles, 141; The Old Wooden Horn of Captain Bob Collins, 142; The Wabash Horn, 143; How to Make a Wabash Horn, 144; The Mouth-piece, 144.	

## CHAPTER XIII.

	PAGE
THE AMERICAN BOY'S HOUSE-BOAT.....	146
Building Material, 150; The Centre-piece, 151; The Sides, 151; The Bottom, 154; The Cabin, 157; Deck-ribs, 157; The Keel, 159; Flooring, 159; The Hatch, 160; Upper Deck, 160; The Rafters, 160; The Rudder, 163; Rowlocks, 163; Ash Poles, 164; The Locker, 164; Canvas-cabinéd House-boat, 166; The Cost of House-boats, 167; For People of Limited Means, 168.	

## CHAPTER XIV.

A BACK-YARD SWITCHBACK.....	170
The Wheels, 170; The Flange, 171; The Axles, 172; The Bottom of the Car, 172; Starting Platform, 173; The Track, 178; A Curved Track, 178; Cross-ties or Sleepers, 179; Ticket-chopper's Box, 180.	

## CHAPTER XV.

HOW TO BUILD A TOBOGGAN-SLIDE IN THE BACK-YARD.....	182
Slipperies, 182; A War-time Slippery, 182; Tropical Toboggan-slide, 184; A Frame, 185; A Toboggan Room, 186; Packing the Slide or Chute, 186.	

## PART II.

## RAINY DAY IDEAS.

## CHAPTER XVI.

A HOME-MADE CIRCUS.....	191
The Bath-tub as a Receiving-tank, 191; A Water-wheel, 192; The Shaft, 192; Paddles, 193; Hanging-bars, 194; Figures which Move, 198.	

## CHAPTER XVII.

GOOD GAMES WITH TOOTHPICKS AND MATCHES.....	201
A Simple Toothpick Example, 203; To Lift Three Safety-matches with One Toothpick, 203; A Spring-bed, 204; Artificial Water, 206; A Bridge of Matches, 206; The Piers, 207; The Approaches, 207; The Roof, 207; A Pioneer Settlement, 208; The Chimneys, 208.	

CHAPTER XVIII.

	PAGE
FUN WITH SCISSORS AND PASTEBOARD AND PAPER.....	210
<p>How to Make the Sleigh, 211; How to Make the Horses, 212; To Cut out the Horse, 213; The Pole, 213; The Driver's Whip, 215; Pasteboard Soldiers, 215; Stirrups, 216; How to Make the Soldiers, 216; To Make an Army, 217; Grandmother's Reticule, 218; To Cut a Five-pointed Star with One Clip of the Scissors, 220; To Make a Cross Into a Square with Two Cuts, 221.</p>	

CHAPTER XIX.

HOW TO PREPARE AND GIVE A BOYS' CHALK-TALK.....	222
<p>The Name Chalk-talk, 224; Drawing-board, 225; Size of Board, 226; Height of Easel, 226; The Drawings Themselves, 227; How to Begin, 227; A Stationary Object, 229; Motion, 230; Evolution of the Ape, 234.</p>	

CHAPTER XX.

A CHRISTMAS NOVELTY FOR BOYS.....	237
<p>How to Build and Decorate a Fireplace for Santa Claus, 237; The First Start, 237; Back of the Chimney, 238; The Front Frame, 240; The Covering, 243; To Line the Inside of the Fireplace, 243; Our American St. Nicholas, 243; Costume for Santa Claus, 245; How to Put on the Clothes, 246.</p>	

CHAPTER XXI.

HOW TO MAKE TWO BOYS INTO ONE SANTA CLAUS.....	248
<p>How the Legs are Made, 249; The Wig and Beard, 249; The Curtains, 249; The Sleigh, 250; The Signal for Legs, 251; The Distribution of the Presents, 251.</p>	

CHAPTER XXII.

A CIRCUS IN THE ATTIC.....	253
<p>How to Make the Horses and Other Animals, and How to Make the Costumes, 253; The Goat, 253; The Arab Steed, 254; The Neckbones, 255; The Ribs, 255; The Frame, 256; The Reins, 256; To Make the Giant Bird of New Zealand, 257; The Manicora, 257; The Ring-master and his Costume, 259; Making Up, 262.</p>	

## CHAPTER XXIII.

	PAGE
A BOYS' STAG-PARTY.....	263
Target Shooting, 263; To Make the Target, 263; Carpet Tacks as Darts for the Blow-gun, 264; Vegetable Bonbon Boxes, 265; A "Fake" Cake, 266; The Shooting, 267; The Spread, 268; The Explosion of the "Fake" Cake, 268.	

## CHAPTER XXIV.

A WILD WEST SHOW IN THE HOUSE.....	270
How to Reproduce the Patterns, 270; Making the Cowboy, Horse, and Indian, 273; For a Bridle, 274; The Indian Horseman, 275; The Buffalo, 276; The Stage, 277.	

## CHAPTER XXV.

HOW TO HAVE A PANORAMA SHOW.....	278
Choice of Subject, 278; Hunting Suitable Pictures, 279; Colored Fig- ures, 280; The Works of the Panorama, 281; The Stage, 282; Foot- lights, 282; How the Panorama Box is Built, 283; The Rollers, 284; Show-bills, 286; The Lecture, 287.	
INDEX.....	289



**PART I.**

**FAIR WEATHER IDEAS.**

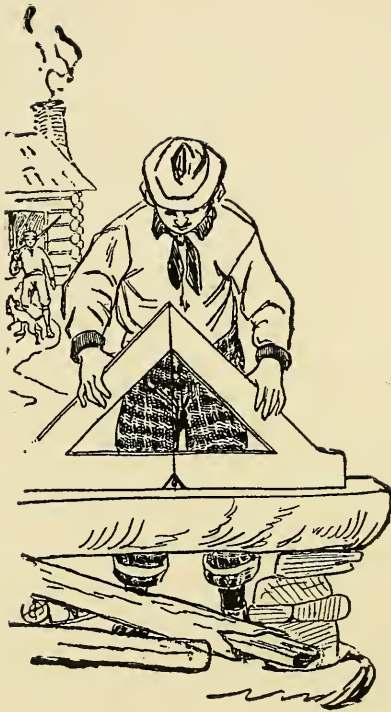

# The Jack of All Trades.

---

## CHAPTER I.

### TREE-TOP CLUB HOUSES.

IT is now over thirty years since the writer was first initiated into the delights of a boys' club-house in the tree-tops, and it happened in this way:

The war of the Rebellion was over; for four years the fathers, big brothers, teachers, and policemen of the border States had had so much serious fighting on their own hands that little or no attention was paid to the growing generation of boys, and they were left to fight their own battles in their own way.

For four eventful years these boys were under practically no other restraint than the little their poor half-distracted mothers could enforce. The boys, however, did not appear to miss the discipline, nor desire it, and, as far as their physical health was concerned, they thrived and developed into lusty lads, though many of them recognized no law but that of physical force.

Gangs of young toughs, under the leadership of local bullies, frequented the play-grounds and roamed along the river-fronts, where they hunted down, pillaged, and beat every unprotected lad they could catch out of sight of his own home.

In spite of the fact that the river-fronts were the favorite resorts of the lawless element, those places presented so many attractions to the juvenile mind that they were the popular play-grounds of all the boys living within reach of their muddy banks and turbid waters.

About this time three boys of a Kentucky town, who were devoted to boating and bathing, put their curly heads together to devise a plan by which they might enjoy their favorite pastimes, and at the same time secure a safe place of refuge where they could hide when the enemy approached in numbers too strong for the three boys to resist.

After many conferences, and references to "Robinson Crusoe," "Swiss Family Robinson," "The Coral Islands," and other undoubted authorities, they decided to build an underground house,\* and armed with spades and shovels, they immediately began work right in the heart of the enemy's country.

They worked, as only boys can when they think their work is fun, and soon excavated a great hole in the river-bank. Not far off were the remains of a flat-boat, and to the heavy pieces of timber the boys harnessed themselves and hauled the lumber over the top of their cave to serve for a roof.

With spade and shovel they carefully concealed the timber by a thick layer of earth, leaving only a square hole with a trap-door as an entrance and exit. The dirt was then smoothed down, and drift-wood, dried weeds, and other rubbish scattered over in such a manner that no one, without careful inspection, would suspect that the bank had been tampered with.

But the enemy was alert, and spies had been stealthily

---

\* Chapter VIII. of this book tells how to build an underground club-house.

watching the work progress, and patiently waiting the completion of the secret hiding-place. No sooner was the last handful of rubbish strewn over the roof than, with wild yells and whoops of delight, the "River Rats" charged upon the surprised workers.

"Big Red" Resmere in the lead, with "Squinty" Quinn and "Spotty," the freckled-face, close behind, while the rear was brought up with a rabble of less noted characters, who more than made up for their own lack of courage by their terror-inspiring yells. It was too formidable a crowd for the three cave-diggers to parley with, so they ingloriously fled up the bank, leaving the product of their hard work in the hands of the despoilers.

### **The River Rats**

used the cave as headquarters, and for a long time afterward would suddenly sally forth from the concealment of the hole and surprise and beat any strange lad who was incautious enough to venture in the neighborhood unprotected by a company of friends. This adventure taught us several things, and one night, at the "dark of the moon," we met in a smoke-house and formed ourselves into a secret society. Over a bottle of strained honey we made solemn vows, and the secrets of the society have never been divulged until now.

The name, the purpose, and the fact of there being any society were the three great secrets. The name was "The Three Ancient Mariners." The object was to stand by each other to the crack of doom, and the seal, 3·A·M, was tattooed on each member's good right arm.

The vows were religiously kept, and many a bruised face and discolored eye proved our loyalty to each other, for the River Rats made constant war upon us, and our

peaceful plans for fun were often rudely upset by the sudden appearance of a bright red head, followed by a freckled face and a gang of retainers.

This persecution caused the production of

### **A Tree-top Retreat,**

which, I believe, has never yet been discovered by the enemy, nor any one else.\* To reach our secret camp and club-house we had to trudge along the dusty turnpike in the hot sun, with no shade but that afforded by our wide-brimmed straw hats. After passing an old-fashioned inn, with its swinging sign decorated with a picture of the battle of Buena Vista, we cut cross-lots over the forts and rifle-pits on the hill-side, built by the Union soldiers at the time of the Morgan raid. At the end of the lowest rifle-pit we slid down the cut to the railroad track, and followed it to the fence, with a hollow gate-post, where the bluebirds always built their nests. Here we left the railway and entered a cool belt of woods in which the dainty maidenhair-ferns grew on the damp rotten logs and the gray squirrels scolded us from the branches overhead. Following a private trail, we reached an immense beech-tree which had grown around a shaggy-barked hickory in such a manner that only the roots and branches of the hickory could be seen, the whole trunk being embedded and concealed by the smooth bark of the beech, giving it the novel appearance of a tree bearing two entirely different kinds of nuts.

Under the spreading branches of this compound tree we generally rested awhile and took a look about us, to be certain that the River Rats were not on our trail; then

---

\* Since the above was written the writer visited the place, found the woods gone and trolley cars running by the old camp.



diving into the hazel thicket, we emerged on the banks of a tributary to the Licking River. A giant tulip-tree stood on the bank of the creek, and a wild grape-vine, as thick as your arm, dangled from the branches, which spread like an umbrella sixty or seventy feet above us. The vine had been cut loose from its roots on the shore, and its severed end hung over a deep, dark pool.

### The Secret Grape-Vine Route.

No boy, outside the members of the 3·A·M's, would look twice at the great snake-like vine hanging over the "lick," and if he should, the vine was far out of reach, and would be passed by as suggesting no possibilities of fun.

Well, that is where he would make his mistake. Concealed in the underwood back of the tulip-tree was a long pole with a hook on one end, and by means of this implement we could grapple the grape-vine and pull the end within reach of our hands, and then one of us at a time would grasp the vine securely with both hands, and stepping back on the bank, give a short run, spring out into mid-air and sail away across the deep hole to drop with a thud upon the opposite bank.

Of course all this was unnecessary, for there were plenty of shallow riffis near by where we could wade across; but

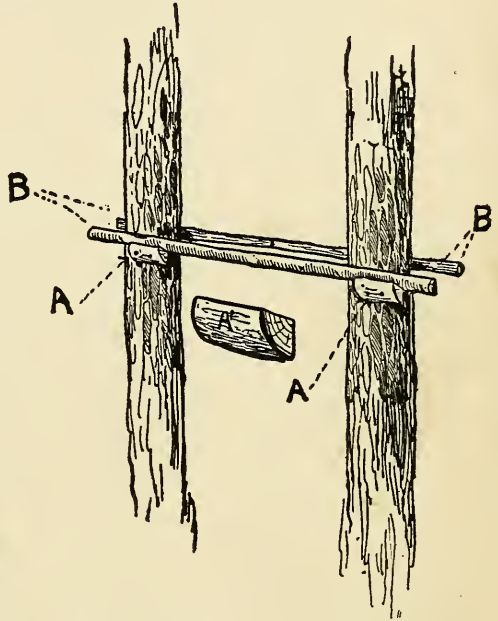

FIG. 1.—Beginning a Two-tree Foundation.



no lad with any romance in his soul would be guilty of such baby-work when he knew the secret of the grape-vine route.

Once across we would peer carefully around in the most approved Indian-scout fashion, and when satisfied the coast was clear we would crouch down and make a wide detour that would bring us to a large sycamore-tree, which had been uprooted by the wind and fallen so that its top rested in the fork of a towering oak-tree. The spreading roots of the fallen sycamore made a wall of clay fully fifteen feet high, which, with the surrounding underbrush and foliage, effectually concealed the fact that in the branches of the oak-tree rested a large and strange nest—a nest built by wingless birds, for it was the club-house of the Three Ancient Mariners! The leaning trunk of the uprooted tree made a firm though slippery substitute for a ladder, and here among the branches many a jolly day was passed, and many a meal of fried fish, fresh from the neighboring “lick,” was devoured by three happy, sunburned boys.

### **Dangerous Toughs.**

Except in the neighborhood of large cities, there is nowadays not much danger from gangs of brutal, half-grown boys, but in those times the law seldom bothered any one.

However, even now, privacy and exemption from unwelcome interruption are desirable, and this can be best secured by

### **A Club-House in the Tree-tops,**

for when the ladder is pulled up no one, without the aid of “climbers,” such as line-men use, can hope to gain access to the cosey little house in the branches.

If you can find a tree with three or four strong spreading

branches, the problem of erecting a house is not a difficult one. If there are four straight trees the proper distance apart, it is a comparatively simple work to erect your house between their trunks, high enough to be out of reach of River Rats; but trees, as a rule, do not regulate their growth to suit any set of boys, and the boys must use their ingenuity to adapt their houses to the forms and growth of the available trees.

First choose your location, and see that it is a desirable one to all the club members; then, if there are any lofty trees at

### **The Desired Spot**

you will certainly find an opportunity for a four-tree, three-tree, two-tree, or one-tree house.

The tree or trees for the purpose must be so tall, that when the bottom ladder is pulled up the house will be out of reach of unwelcome callers, and big enough to prevent the wind from so swaying the house as to give a feeling of insecurity.

### **A Two-Tree House.**

Let us suppose that there are only two trees in the proper location which fulfil the requirements, and that these are tall pines with no branches of any importance below their feather-duster-like tops. This presents one of the most difficult problems to solve; but when you know how, you can erect a most enchanting "crow's-nest" away up the tall trunks, where the fresh breeze blows over the tops of the smaller trees, and where a good view can be had of the surrounding country, and the enemy, if there be one, may be seen while yet a long distance off, giving ample time to the club members to pull up the ground ladder and place themselves in position to laugh at the foe.

**How To Start.**

With an accomplished woodsman the whole edifice may be erected with the use of no other tool than an axe; but, as a rule, the more tools you have at your disposal the better you can do your work. If you possess a tape-line, measure the distance with it between the two tree-trunks. If you have no tape but have a two-foot ruler, make yourself a

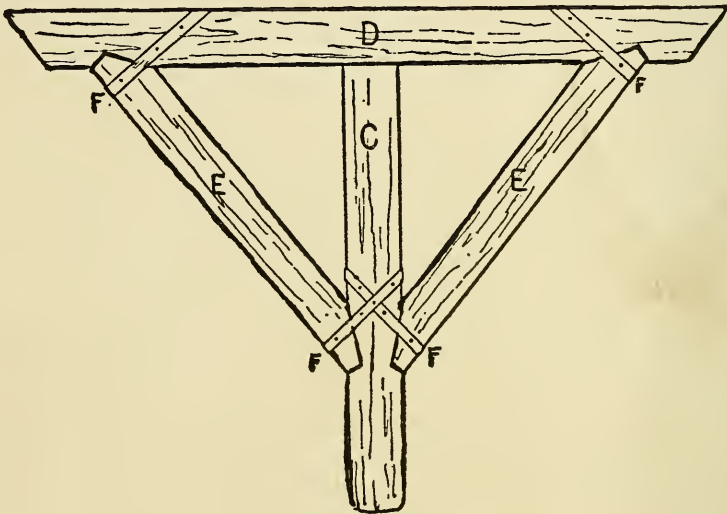

FIG. 2.—King Posts and Corbel.

longer measure by marking off the feet and half-feet upon a ten or twelve-foot pole, and use it to measure between the trees. If, however, you have neither, use your legs and pace the distance, and then cut two long, strong poles, and see that they are long enough to span the distance between the trees, leaving plenty of wood to project beyond each tree. Flatten one side of each pole as shown in the diagram B, B, Fig. 1. Next, select a sound log, a foot or so in diameter, quarter it, and make four

**A Blocks,**

each about two feet long. See A, A', and A<sup>1</sup>, Fig 1.

As it is best to have the bottom of your house level, you must manage to nail the A blocks the same distance above the ground on each side of each tree—that is, if the ground is level; if not, you must allow for the slant of the earth. Spike the blocks securely to the trees with six-inch nails, using about three nails to each block.

The foundation of the house may be higher than your ladder will reach. In this case cut two more poles and four more blocks, and at the point where the top of your ladder reaches spike on the blocks, and then rest

**The B Poles**

on them on each side of the two trees, as in Fig 1. Nail the B poles securely to the tree, and with plank or half-round sticks floor the space between the trees, and you will have a good landing below your house (see Fig. 5) from which a ladder may be run to the proposed foundation. After the upper rods have been nailed to the trees and a ladder adjusted, and for security nailed fast to

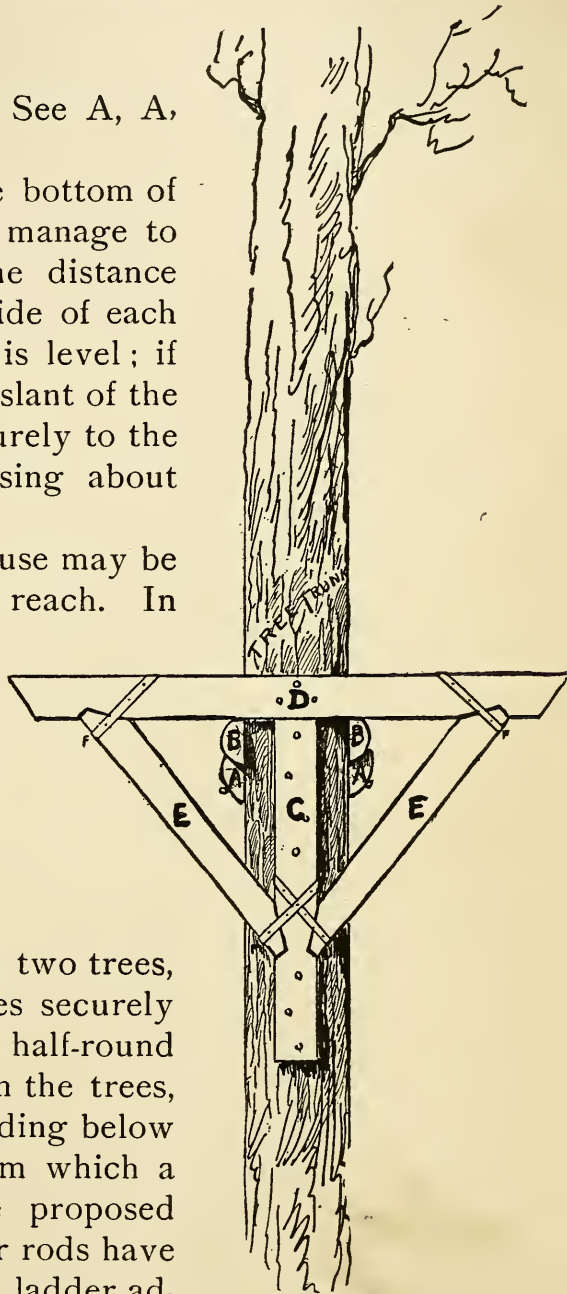

FIG. 3.—End View of Corbel Resting on B Sticks.



the tree and lower platform, you are ready to begin the serious work of building. Take a good strong plank, two inches thick, and cut two pieces about six feet long, and shaped as shown by

### The Corbel Piece D

in Fig. 2; then cut four struts (E, E, in Fig. 2) and two king-posts (C, Fig 2). Shave off the ends of the struts, as

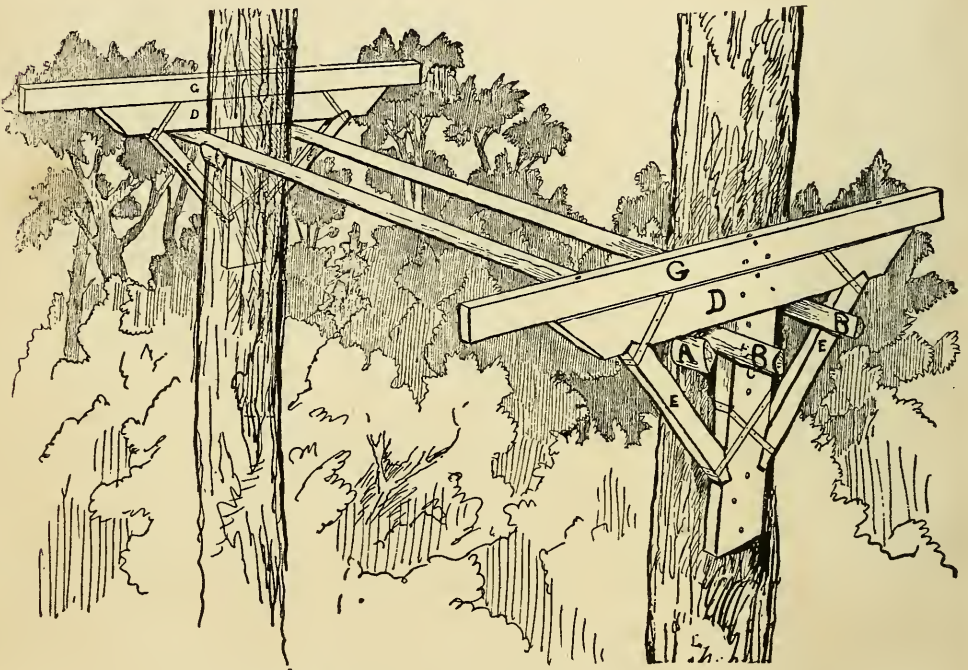

FIG. 4.—Perspective View of Corbels Resting on B Sticks.

shown in the diagram, to fit the notches cut in the corbel pieces and the king-posts.

It is not necessary to spike this frame together—the big nails might split the timber—they may be fastened together slightly with wire nails and strengthened by a piece of hoop-iron nailed on with small nails, as shown in Fig 2

## CHAPTER II.

### HUNTING WITHOUT A GUN.

#### How to Capture and Trap Small Live Animals.

A BOY who can spend part of his time out of town, and is the fortunate owner of a mongrel cur, forms a combination for enjoyment and fun hard to be beaten by anything in nature. A good yellow dog, unencumbered by any aristocratic ancestors, is an ideal companion in the wood, and field: it can scent a woodchuck leagues away, it knows just how to head a chipmonk off from its retreat, and there is not a trick known to the professional poacher which is not familiar to the real country plebeian cur.

#### Chipmonks and Woodchucks!

There is a potent charm in those words, which can iron the wrinkles out of an old brow, and soften the hard lines in the face of a careworn professional or business man.

Not long ago I attended a dinner given by the

#### Camp-Fire Club,

and there I found ranged around the table an array of veteran hunters. There were men there who had hunted the royal Bengal tiger in the jungles of India, men who had fought with rogue elephants, men who had followed the lions to their dens in Africa, men who had tracked the white

bear to its lair in the far frozen North. There were gentlemen who hunted for pleasure, cowboys and scouts—Coquina Shields, "Wolf" Thompson, "Curio" Brown, "Yellowstone" Kelly, Andrew J. Stone, and many others equally well-known in the forests or on the plains were seated at the big round table.\*

That they were real simon-pure sportsmen could be seen at a glance, and yet, when the after-dinner speeches were made, the sentiments which received the most enthusiastic applause were those which DENOUNCED THE KILLING OF MAN OR BEAST. It could readily be seen that these men only used the gun when it was necessary to procure food or in self-defence. They all indorsed the use of the camera for the hunt in place of the murderous gun; as one of them remarked, "With a kodak every good shot is registered with the click of the shutter, and an album of good shots is a thing of which any man may be proud."

With a little private zoo of captured live game you may have a living album, which attests the skill of the collector and his knowledge of woodcraft as accurately as any album of photographs.

The next chapter tells how to build a back-yard zoo, and now we must learn how to stock one. If the reader will

\* G. O. Shields, President of the League of American Sportsmen, editor of *Recreation*.

Ernest Seton-Thompson, naturalist to the Government of Manitoba, author of "Wild Animals I Have Known."

Capt. Luther S. Kelly, veteran of the War of '61 and Spanish War, Indian fighter, one of General Custer's scouts and hunters.

William Harvey Brown, African traveller, hunter and collector for the United States Museum, author of "On the South African Frontier."

A. J. Stone, field naturalist, arctic explorer, hero of a 3,000-mile sledge journey, discoverer of several American mammals new to science.



### **Flying-Squirrels,**

when tame, make the most gentle pets, but when wild, and rudely seized by hand, they have a vicious way of using their chisel-like teeth which induces more caution the next time. A smoke-stupefied squirrel is much more pleasant to handle than a wild one, frantic with fright.

If, however, you protect your hand with an ordinary bicycle or golf cap, you can seize almost any small animal with impunity. I caught nine flying-squirrels in one night, with no protection for my hand but an old cloth cap.

Do not try to throw the cap over the animal, or it will escape from beneath, but use the cap as a protection to your hand, then grasp the creature by a quick movement, closing your fingers tightly over its body, being careful not to squeeze hard enough to injure the terrified little squirrel. The advantage of this mode of capture is that, having the game in your hand, you can easily thrust it into the cloth bag you carry for that purpose.

### **The Cloth Bag**

is a most convenient thing; it is easy to carry, allows plenty of air, and the little creatures never think of gnawing out while you carry them.

I have carried

### **Short-Tailed Meadow-Rats**

and white-footed mice for miles, tied up in my handkerchief, and no attempt was made by my prisoners to use their teeth to assist them in escaping.

The gentle, graceful little jumping-mice, white-footed mice, short-tailed meadow-rats, and flying squirrels are all

to be found inside the city limits of Greater New York, and some of their relatives are to be found in almost any rural place in this country. These interesting little creatures can be captured with ordinary box-traps, figure fours, or the square or round wire mouse-traps. The white-footed mice or deer-mice may be found in the abandoned nests of other rodents, in hollow logs, in old corn-stacks, in holes in the fence-rails, and under clods of old ploughed fields, or beneath brush-heaps in the fence corners.

In the late autumn, before the first snow comes, they have a very pretty way of

### Utilizing Last Summer's Birds'-Nests

by filling them with the soft down from the cat-tails of a neighboring marsh, or with moss and wood fibres, thistle-down, or the silky feathers from the seed of the milk-weed. Like flying-squirrels, the little deer-mice bury themselves in the soft nests, and sleep away the day, emerging at night for food and exercise.

If the branch upon which the nest is located is but touched, the brown-backed, nimble-footed little squatter will poke his head from the middle of the nest, look inquiringly around, and if no danger appears the head is withdrawn, and the mouse resumes its slumbers; but if it is deemed that there is cause for serious alarm, it will spring from the nest, and with the agility of a squirrel run lightly up a branch, and from this point of vantage turn its

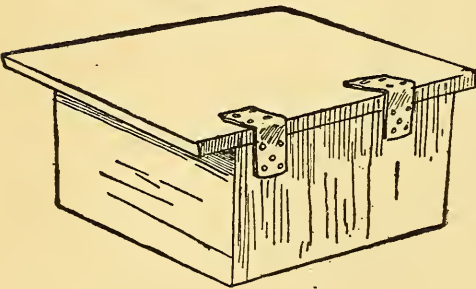

FIG. 12.

## CHAPTER III.

### THE BACK-YARD ZOO.

THE king of beasts and the royal Bengal tiger are neither of them able to inspire such universal terror among the wild creatures of the forest as does man.

Bitter experience and terrible examples of man's ferocious cruelty to all wild animals have taught even the most humble and inoffensive of them to dread the approach of the bloodthirsty two-legged destroyer.

It is high time that we redeem

#### Our Reputation among the Brutes.

It is time we ceased our wasteful, senseless slaughter of every wild thing to be met with in field and forest. It is time we began to study live animals, in place of uncanny dried skins and badly upholstered "specimens," so-called.

#### This Gory Method of Study

belongs to the past. A new era has commenced, and real naturalists now drop their dry bones and moth-eaten skins to enjoy the study of live, healthy animals.

The boy who is really fond of animals never ill-treats his pets, or abuses and makes a slave of his dog. On the contrary, his dog is his companion and playmate.

The boy knows that a dog's master is a god in the eyes of the poor brute, and is

### **Worshipped with Canine Devotion,**

which again and again has been proved faithful unto death. Such knowledge makes the boy just and kind. But a dog is only a domesticated wolf, and the wolf is not the only wild creature which can be domesticated; neither is the wolf the only animal which

### **Can Appreciate Kindness.**

The same care which transforms a red-mouthed wolf into a faithful dog can transform other undomesticated beasts into useful creatures. As soon as an animal learns that you are contributing to its comfort, you may notice it will greet you with a milder expression. As soon as you can make the wildest and fiercest beast understand that the use of jaws, claws, or sting is unnecessary, it will refrain from using them. It is not always possible to come to this understanding with the larger beasts, and such animals are not fitted for back-yard zoos.

A lad who loves his pets will bestow upon the little creatures that affection which shows itself in a sympathy which can understand their wants and necessities. Such a lad can perform wonders; birds will come at his call, the small beasts of the field will follow at his heels, and no child will fear him.

Unfortunately, in spite of the amount of land on this continent, it is difficult for any but the very wealthy to have access to much of it, hence many readers will say, "We have no yard in which to keep pets," or, "Our yard is too small." Of course, if you are living in a flat you must go without a zoo, but if you have a yard it will probably not be less than twenty-five feet wide, and Fig. 22 shows how a very com-



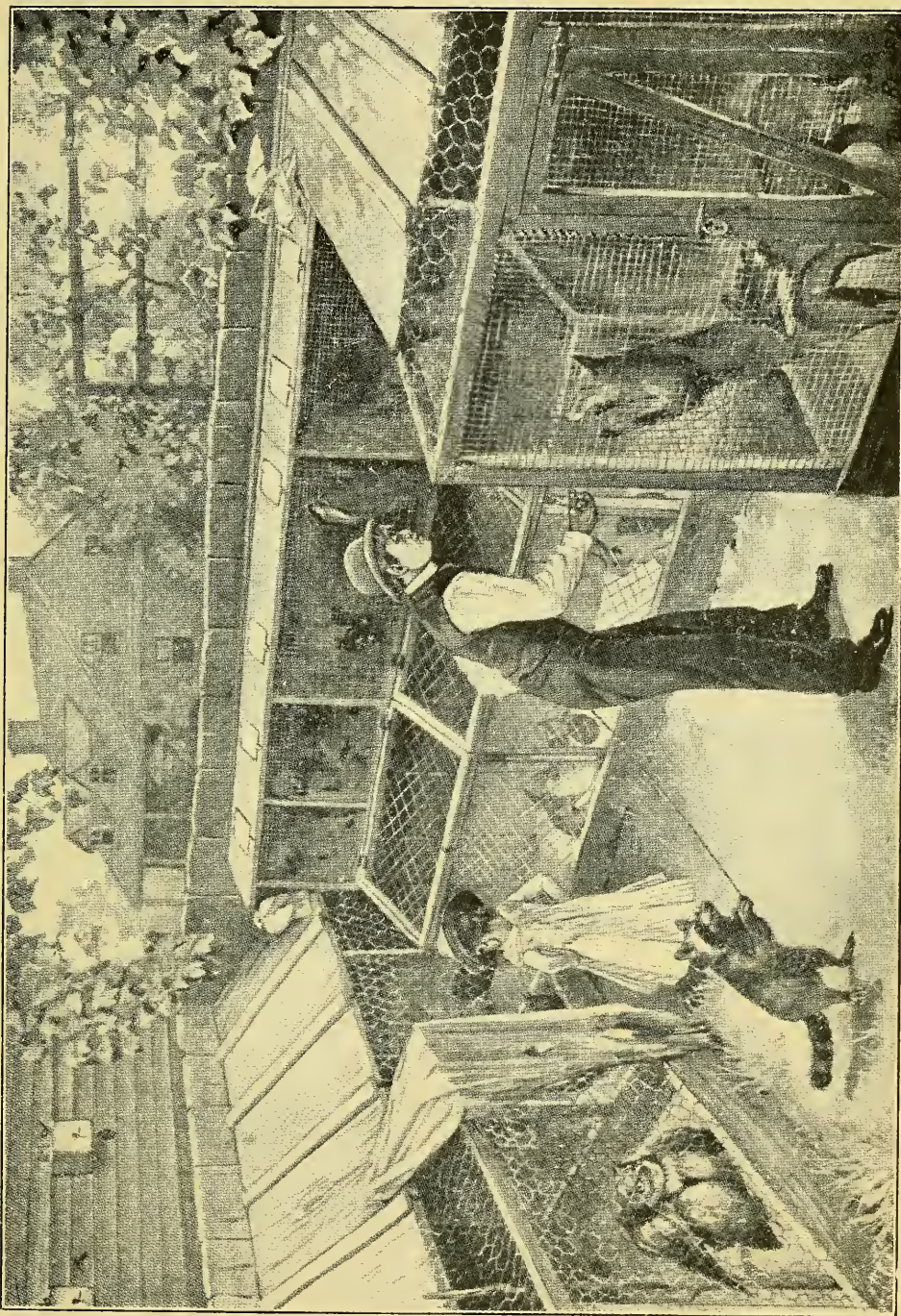

Visiting the Animals.





prehensive zoo can be placed in the rear of a twenty-five foot lot, without materially interfering with such domestic matters as the drying of clothes on wash-day. A city

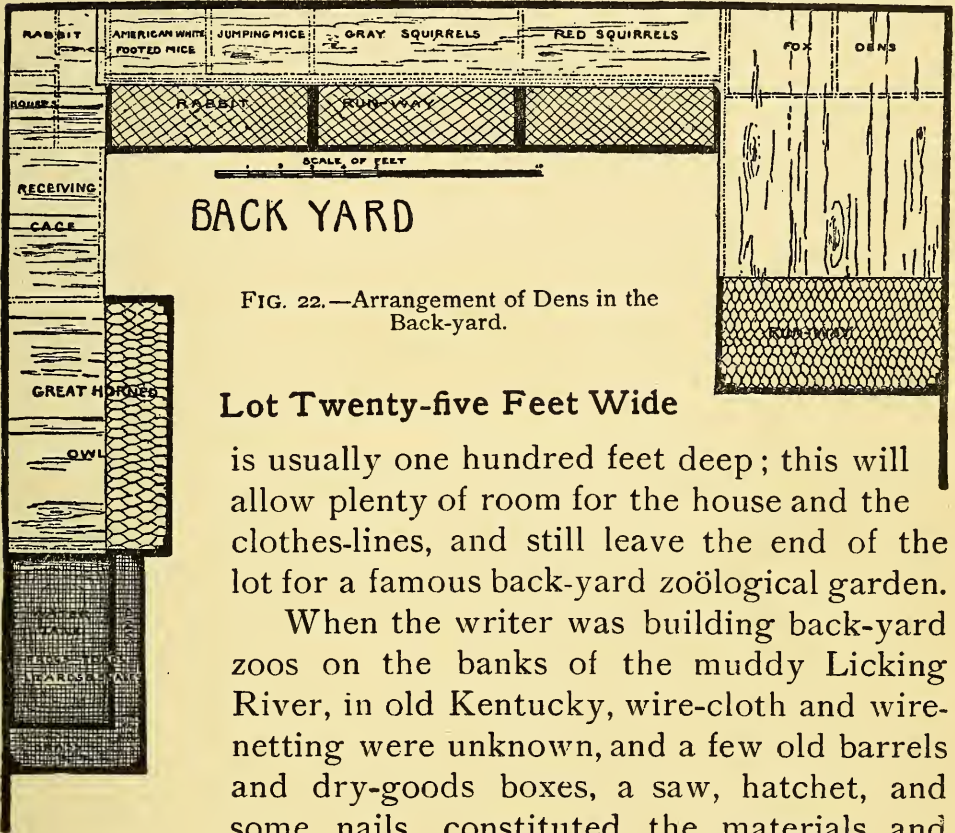

FIG. 22.—Arrangement of Dens in the Back-yard.

**Lot Twenty-five Feet Wide**

is usually one hundred feet deep ; this will allow plenty of room for the house and the clothes-lines, and still leave the end of the lot for a famous back-yard zoölogical garden.

When the writer was building back-yard zoos on the banks of the muddy Licking River, in old Kentucky, wire-cloth and wire-netting were unknown, and a few old barrels and dry-goods boxes, a saw, hatchet, and some nails, constituted the materials and tools with which he and his playmates made cages for pets, frog-ponds, and dove-cots.

The writer's

**Crow and Dog did the Bossing**

of the work, and incidentally learned all the weak spots in the structures, a knowledge which they were not slow to use when the sheds and coops were finished, and occupied by creatures fascinatingly interesting to crows and dogs.

But you boys are lucky fellows! Everything that youth wants is now on the market at reasonable prices. Wire-cloth and galvanized wire-netting with double-twisted selvages, with meshes of any size to suit the occasion, and wire of any dimensions to suit the purpose, are now manufactured especially for the building of cages.

### Galvanized Iron Wire-Cloth or Netting

comes in rolls, with either square or hexagonal mesh; in other words, the openings between the wires are in the form of a square, or are six-sided.

Wire is numbered from the very heavy, No. 000, which is over a third of an inch in diameter, to No. 40, which is only .00725 of an inch in diameter. It is not very likely that you will use either of these wires, unless your collection includes some very large and strong beasts and some very small insects.

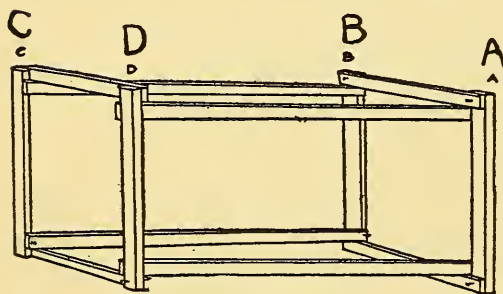

FIG. 23.—Temporary Frame of Cage.

The wires which you will probably need will be between No. 14 and No. 22. No. 14 is eighth-tenths of an inch in diameter, and No. 22 is a little more than two-tenths of an inch in diameter.

### The Mesh

is the distance from *centre to centre* of the wire. No. 5 mesh means five meshes to the lineal inch—that is, a piece of netting five inches long will contain twenty-five meshes. The “space” means the opening between the wires—that is, the distance from *wire to wire*.

This is explained because some of the readers may not live near any dealer in wire-goods, and will be compelled to order what they want by letter. To do this intelligently they should understand the trade terms. Galvanized wire-netting, used for small bird-cages, comes in one-half, five-eighth and three-quarter-inch mesh, and is made of from No. 18 to No. 22 wire. The width of this netting varies from two feet to four feet. One-and-one-quarter-inch mesh is used for pigeon-houses, and the netting is from two feet to six feet wide. One-inch mesh is used for quail, ruffed grouse, pheasants, prairie-chickens, etc. A two-inch mesh is usually used for chicken-coops.

As a rule, the mesh which has square spaces is called wire-cloth, and that which has six-sided spaces is called netting. For mice, rats, chip monks, flying-squirrels, gray and red squirrels, use about No. 2½ square mesh of No. 17 galvanized wire.

For woodchucks and musk-rats use a rather small mesh and pretty heavy wire, for their teeth are strong chisels, and you will be surprised to see what skilled mechanics they are in the use of the tools with which nature has supplied them. For rabbits, a two-inch mesh or any of the nettings used

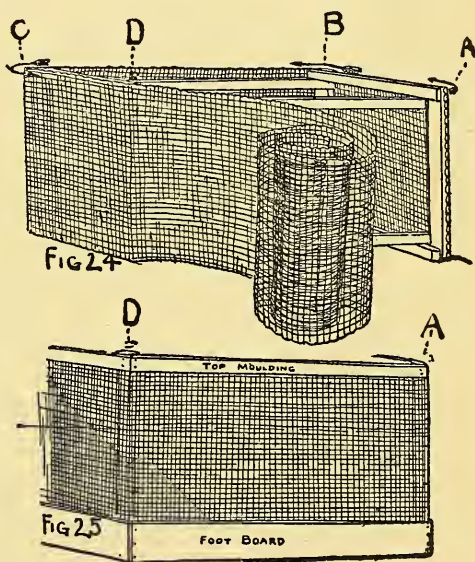

FIGS. 24 and 25.

for poultry answers all purposes; but for foxes, if you use a two-inch mesh, be careful to have it of heavy wire. The writer's Skye terrier pup gnawed its way through the

chicken-coop wire-netting on various occasions, and a fox has all the energy of a terrier, coupled with a most surprising amount of ingenuity and skill in jail-breaking.

### **A Pair of Foxes**

I once owned could undo any knot or catch that I could invent with which to fasten them, and I was only made aware of the fact from the complaints of lost chickens which came from our neighbors.

While the neighbors were protesting, Faust and Mrs. Faust lay in front of their den, staring innocently at us with their great brown eyes, but investigation proved that the chains which apparently confined them were attached to nothing but their collars; and, furthermore, when I pushed the foxes aside with my foot, sundry quills and feathers, protruding from the fresh earth of their bed, showed only too plainly that our neighbors were not without reason in suspecting my innocent-looking rascally pets. I at last solved the problem by chaining the foxes together, and in spite of all their cunning, they never learned to go through the same opening in the fence, but each chose a different exit, and both were then held by their chain.

### **Each Cage**

the reader makes will, of necessity, be of a form peculiar to his purpose and the location where it is placed. If it is for a fence-corner there will be but two sides to cover with wire-netting; if it be against the fence there will be three sides of netting: the fence forming the other side. In a hundred different ways will the surroundings modify the form of the cages, so, to simplify matters, we will suppose the proposed pen is to stand in the centre of the yard. In this case,



### To Make a Cage of Galvanized Wire-Netting,

you first decide upon the wire and the mesh which are needed for this particular coop, next decide what are to be the dimensions; then, with a hand-saw, cut four wooden uprights exactly the same length, and fasten these posts together, temporarily, as shown in Fig. 23, A, B, C, D.

The strips connecting the uprights, and forming a box-like frame, should be only secure enough to keep the frame in shape. The nails in the strips must be driven just far enough to hold, leaving the head and enough of each nail above-board to render it a simple task to withdraw the nails when you wish to remove the strips.

When the temporary frame or mould is finished (Fig. 23), fasten the end of the wire-netting securely to the front of the upright A with staple tacks, then pass the roll to B (Fig. 24), draw it tight, and with more staple tacks secure it to this upright; continue the same process at C and D, ending at A, as shown in Fig. 24. The arrows show the direction to be observed in passing the netting around the uprights.

When all is snug and fastened firmly, nail a footboard and top moulding on, as shown in Fig. 25, after which remove the temporary inside strips, and your coop is done. It has no roof or floor as yet, but the roof can be made of

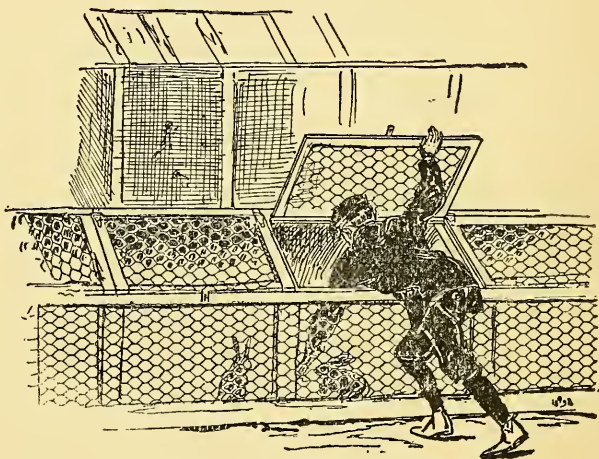

FIG. 26.—Cages and Runway.

wood or netting, as the occasion may require; the floor may be of wood or earth, to suit the purposes for which it is to be used. In large cages the doors must be framed and set in, as shown in the picture of fox-dens in the illustration of the back-yard zoo, but in small cages a small hole may be cut in the netting—this can be done with an old pair of shears. The square piece of netting from the cut can then be used as a door by fastening one edge with loops of wire to the edge of the opening just made. Picture-wire and copper wire are best for such purpose, because they are pliable and easily handled.

### **The Door**

can, if desired, be made very neat by the following method: Cut some tin into strips of the proper dimensions, then fold the strips on their centre, lengthwise. Punch a series of holes by placing the folded strips of tin on a block of wood and driving a nail through. Slip the folded tin over the exposed edges of the wire-netting, and sew it in place by threading a fine wire through the holes. Bind the edges of the door in the same manner, then put a loop of wire on the door for a hasp, and a smaller one on the cage near the edge of the doorway for a staple, and the door may be fastened with a peg of wood or a nail; or, better still, wire a hook on the door in place of a hasp, and arrange it so as to hook into the loop on the cage.

It is often handy to have doors in the roof of a cage, as in the roofs of the gnawers' cages, over the rabbit runway, in the illustration.

### **The Doors for the Runway**

to the rabbit-house are on top, and open like a door to a bin, as shown in the illustration and in Fig 26. While we



are at the rodents', or gnawers', quarters, it is well to remember certain peculiarities about the habits of these animals. Rats, mice, squirrels, and their kind, will invariably seek a crack, angle or corner to commence work for a hole; knowing this, it is well to protect all such places by pieces of metal or tin, and none of the little fellows will make his escape, unless the door is left open.

Rabbits will seldom gnaw out, but if they have an opportunity they will tunnel out.

To prevent diggers from escaping, allow your wire-netting to extend a foot and a half underground, below the foot-board.

### **A Reptile House**

need not be more than three feet high. It is not shown in the illustration, but may be built as described and shown in Figs. 23, 24, and 25, after which a roof of wire-cloth must be added.

Into this house you put your turtles, frogs, toads, lizards, and snakes, and as most, if not all, of these require water in considerable quantity, it is well to have a tank for their use. But as every boy does not know how to build the tank, he may learn by following the directions in the following chapter, describing a back-yard fish-pond.

Be careful to set the tank level and pack it around with good hard earth. It is well to sod the ground on three sides, and cover the earth on the remaining side with clean sand and gravel.

There should be a strip of land at least two feet wide all around the tank, as a runway. When this is all arranged spread a layer of sand all over the bottom of the tank, fill it with water, and place the cage over all. You should have

### An Old Piece of Canvas,

or some similar covering, for the cage, to be used when your sand is in danger of being washed away by a down-pour of rain.

Everything is now ready, and you can turn loose in the enclosure

### Your Whole Collection

of frogs, toads, lizards, and snakes, and they will soon make themselves at home. You must not be surprised if your pets in this cage feed upon one another. I once owned an old bull-frog who would attempt to swallow anything that moved, with the exception of snakes. This frog swallowed two live mice in one day, but he did not get hungry again for two weeks.\*

There are but few poisonous snakes in our country, and in the Northern States we have but two kinds—copperheads and rattlesnakes. Neither of these will add to the interest of your collection, and must be left out and let alone.†

There are many beautiful and harmless little snakes to be found in every field. They abound within the city limits of New York.‡ I saw two sunning themselves on a neighbor's lawn, and discovered their home in the gate-post.

You will be surprised at the many varieties of frogs you can find when you start to collect these comical little creat-

\* An account of this frog is in "The American Boy's Handy Book."

† The South has also the venomous water-moccasin or cotton-mouth, and the poisonous but timid coral and harlequin-snakes.

‡ Snakes in neighborhood of New York: Dangerous—Banded rattlesnake, copperhead. Harmless, can be domesticated—Black-snake, worm-snake, ringnecked-snake, black pilot-snake, green-snake, water-snake, brown-snake, hognosed-snake (adder), milk-snake, garter-snake, ribbon-snake.

ures. Some of them are very difficult to catch, and they often turn up in the oddest of places. I found a big toad in the top of a tree which I had climbed after young crows. It was a common hop-toad, not a tree-frog.

### **Silly Superstitions of Hoop-Snake Age.**

It is high time that the American boys, in the dawn of the twentieth century, should forget all the fabulous stories of snakes with the power to "charm" persons, toads with death-dealing breath, deadly swifts and venomous lizards. All such yarns are handed down to us by our superstitious

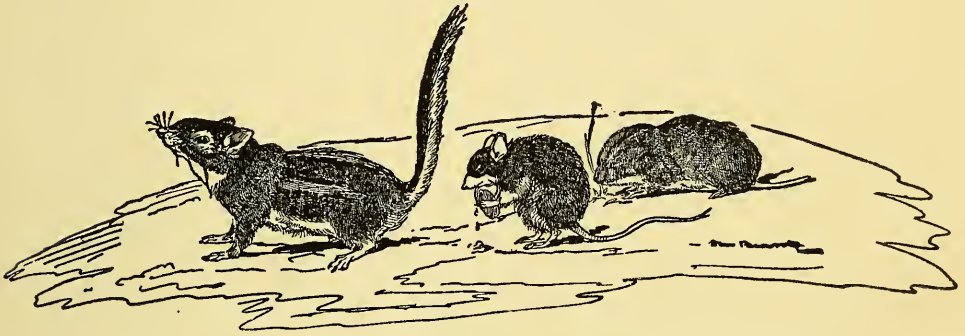

Chipmonk. White-footed Mouse. Short-tail Meadow-Rat.

ancestors, and are a part of the witch belief of the old Salem folk. There are people living now who will tell you that they have seen a hoop-snake with his tail in his mouth, rolling down hill, and these people really believe what they say; but so did the Salem folks believe in witches.

### **Toads : Useful and Harmless.**

If our comical, insect-destroying toads were venomous, the hand which pens these lines would have perished while it was still a chubby, dimpled, baby's hand.

### Neither Do Toads Make Warts;

otherwise the writer's hands would be far too warty to wield either a pen or a brush; but in spite of the hundreds of toads handled by the writer he never was afflicted with warts on either hands or body.

In Pennsylvania there is a toad which has occupied the same back-dooryard for over ten years, and he will eat his own weight in "bugs" in a very short time.

The funniest toad ever owned by the writer was a Kentucky hop-toad with five well-developed legs, and the largest frog the writer ever caught was a New York bull-frog, which weighed one pound.

### Frog Market.

St. Paul and Minneapolis are the great frog markets of the world. The receipts there last year, according to the daily papers, were something over six million frogs!

In the neighborhood of New York City one of the earliest frogs is the little brown cricket-frog. Next come the mysterious and shrill-voiced peepers, which make each marshy spot fairly shriek with their high-keyed notes.

### Peepers

are hard to capture, because you can seldom see them. A dip-net run through the water where you have heard peepers will generally reward you with two or three little dusky imps, who, when captured, will sing in your coat-pocket, and the writer has had them sing while imprisoned in his hands.

A loud, coarse trill announces the appearance of



### **The Tree-Toad,**

and this batrachian makes a most interesting addition to the collection. It is said that the tree-toad has the power of changing color, varying from ash-white, dull-gray or a brown to a bright-green hue.

You must look for the hermit-frogs or spade-frogs where they hide in holes in the ground, and in the damp wood you can hunt the lean-flanked, beautifully-spotted leopard-frog, his cousin, the pickerel-frog, and the brown wood-frog.

The bright-green-tree specimen, known as

### **The Anderson Frog,**

is considered by frog-hunters as a great prize, and specimens can only be captured at rare intervals. When you secure a rare frog do not put him in the same place with larger frogs, for the latter will swallow their smaller companions the first time they feel hungry.

### **The Frog Has Teeth.**

Put your finger in a frog's mouth and you can distinctly feel a number of fine, sharp teeth, but if you put your finger in a toad's mouth you will find no teeth; a frog grabs his prey with his jaws, a toad snips it up with his tongue.

Besides the common, funny old hop-toad, there are the Rocky Mountain hop-toads, the Southern hop-toads, and the hop-toads from Northeastern Massachusetts, which differ sufficiently from the common hop-toad to be classed by naturalists as sub-species.

### **Lizards.**

With the exception of the Gila Monster *there are no poisonous lizards known*, and although many of the little

creatures will try to bite you, their teeth are as harmless as so many needle points, and cannot be felt through a glove. Put on an old glove when handling them and you can hold them better; but be very careful and not be rude, or you may be surprised to find you have a stump-tailed lizard in your hand while the caudal appendage will be twisting around in a most astonishing manner at your feet.

Many beautiful and interesting lizards may be captured in all parts of the Union.

That it is not cruel to capture and confine wild animals is proved by the fact that almost all wild creatures, after they have become thoroughly familiar with their quarters, will not voluntarily leave their artificial homes for any protracted period. I have had wild pigeons return after giving them their freedom, and have had foxes return after securing their own freedom, by skill and cunning superior to that exercised by me in confining them. As for crows, coons, squirrels, and numerous other creatures possessed by me at different times, only death or forcible detention ever prevented them from returning to the place where plenty of food and kindness awaited them.

It is not necessary, or even desirable, to build all your cages at one time, for it is hardly possible that you will know just what you need until you have secured the creatures you wish to keep confined in the proposed pens and enclosures.

### **The Receiving-Cage.**

Allow your cages to grow naturally, by adding additions or new ones as the occasion requires. Acting upon this plan the receiving-cage will be the first to be erected, and it should be strong enough to securely confine the largest of your captives, while the mesh of the wire-cloth should



be fine enough to prevent the escape of the smallest pocket-mouse. The angles and corners should be well protected with metal, to resist the teeth of the gnawers, and the bottom protected with wire-cloth, to defeat the attempts of the diggers.

This cage will, at different times, furnish lodging for all the varieties of beasts or birds which are from time to time included in your ever-growing collection. Your new animals are first put in the receiving-cage, and must live there until suitable quarters are built for them.

### **The Value of Room.**

Build all your cages as roomy as your available space and material will allow, and study to make their interiors as like the natural haunts of the imprisoned animals as is practicable. Avoid all attempts at ornamenting the cages, for no cage looks better and more artistic than the strictly practical one, built solely with a view to usefulness.

Clean sand will be found very useful for spreading over the floors of the wooden-bottomed cages, and a large box of it, kept in a dry place, will add greatly to your ability to keep things tidy.

Be particular about the nesting of your mice and squirrels; frequently remove the old nests and burn them, at the same time supplying the little creatures with a fresh lot of clean cotton, wool, fine grass, or even paper, and they will arrange a new bed for themselves out of the fresh material.

You will soon discover that all beasts prefer to keep clean, and have methods of their own by which they endeavor to keep themselves neat and presentable, without the use of soap. Any disagreeable odor proceeding from their cages simply means neglect on the part of the keeper of the zoo.

## CHAPTER IV.

### A BACK-YARD FISH-POND.

ALTHOUGH the writer has made frequent journeys to the wonderful dreamland of his boyhood, and has ruthlessly taken and brought to earth many of its air-castles for the use of the boys of the present day, there are still a number of things left, and among the latter is the back-yard fish-pond, which we shall now seize, and, bringing the idea down to your back-yard, make it water-tight, so that you can stock it with real live fish.

#### A Shallow Pond,

with a broad surface exposed to the air will support, in health many more inhabitants than a deep hole, with small exposed surface. Remember that it is easier to keep a fish alive in a shallow basin than it is in a bottle holding exactly the same amount of water.

#### If You Dig a Hole

in your yard and fill it with water, it will be a mud-hole, in which no self-respecting fish will live: besides which the soil will soon soak up the water and leave the mud to bake in the hot summer sun.

#### By Sinking a Wooden Tank

in the ground and filling it with water a pond may be made. But any old box will not answer, for, unless you are a much

better mechanic than the writer was at your age, you will not be able to prevent an ordinary box from leaking.

However, if you really want a back-yard fish-pond, you may make a box or tank which will hold water, and the

### Best Form for Such a Tank

is that of a wide, flat-bottomed scow. This scow may be of any dimensions you choose to build it, but I would advise

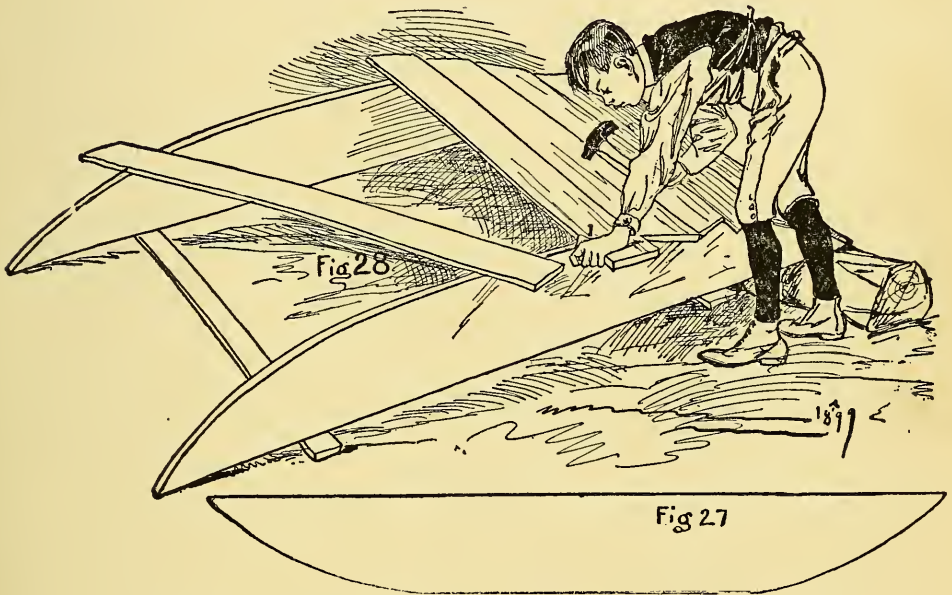

FIGS. 27 and 28.—The Side-boards must be Duplicates.

you to make your first one not more than six feet long by four feet wide, and two feet deep.

In selecting lumber for the scow, pick out pieces which are comparatively free from knots or blemishes. Reserve two one-and-a-half-inch planks, and keep the half-inch boards for the bottom.

A saw, a plane, and a sharp hatchet are necessary, but

other tools, if not absolutely needed, should not on that account be ignored, as they may come in very handy at times.

Trim off your two side-boards to exactly the same length—say six feet; they should then be six feet by two feet. On the edge which is to be the bottom measure toward the centre from each end of each board two feet, and mark the points; then rule a line diagonally from each of these points to the corners of the boards on the upper edge; this will mark out a sort of double-ended sled-runner, as shown in the illustrations, and when you saw off the triangular pieces marked on the boards you will have

### **Two Runners.**

Set these runners side to side, on their long edges, and round off the angles with your plane, until the boards look like rockers (see Fig. 27). The side-boards must be exact duplicates of each other (Fig. 28).

Set the two side-pieces four feet apart and nail two or three temporary cross-pieces across their top (longest) edges to hold them in position; then turn them over and nail on the bottom-boards (Fig. 28).

You must use the greatest care in fitting the bottom-boards edge to edge, but you need not trouble yourself about the ends of the boards; allow them to project upon each side, as chance may direct. After the boards are all securely nailed to the bottom the ends may be sawed off flush with the sides of the scow (Fig. 29).

### **To Prevent the Wood from Decay**

it is well to melt some tar over a fire, and, with a small mop made of rags tied to the end of a stick, paint the bottom of



the scow with hot tar, being careful to see that all the cracks and crevices are thoroughly filled.

### In the Shadiest Spot

you can find in the back-yard dig a hole for your tank. Make the bottom level. Set your tank in place and pack the earth well around the edges. Cover the bottom of the pond with about one inch depth of sand, and the surface of



FIG. 29.—The Ends may be Sawed off Flush.

the sand with a coating of gravel; then carefully fill the tank, without disturbing the sand, and allow the water to settle; after which a few aquatic plants may be introduced and a wire fence built around the pond to keep out intruders of the two-footed and four-footed kind. If you have a few small frogs and turtles the mesh of the wire in the fence must be small.



**When to Stock.**

After the water has stood for three or four days, and the aquatic plants have started to grow in their new quarters, you can stock the pond with sunfish, rock-bass, dace, small

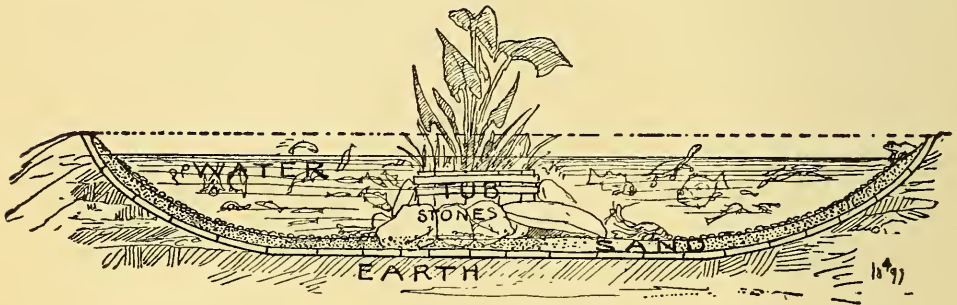

FIG. 30.—Cross-section of Tank.

catfish, crawfish, carp, and goldfish. The two last-named are the most stupid of the fish, and the rock-bass is one of the most intelligent fish I have ever kept in captivity.

**Handy for the Pets.**

The inclined ends of the scow-shaped tank give two sloping shores (Fig. 30), which will be appreciated by the crawfish, turtles, and frogs; and if you build a little rockery in the centre the more timid fish will thank you for your thoughtfulness in providing them a safe retreat.

If it is possible for you to

**Catch Your Own Fish**

do not waste your money buying stupid goldfish. The fun of hunting for other small fish, capturing them and taming them, is more than half the pay for the work, in the pleasure it will afford you. However, if you are so situated that

you cannot go fishing yourself, the aquarium stores in the big cities will supply you with almost any sort of aquatic creature.

### **Fresh-Water Clams**

or mussels will live in confinement, and a few make an interesting addition to a collection. Water-snails act as scavengers for the under-water settlement, and a handful of them may be added to form a sort of street-cleaning department. Caddice worms and the little fresh-water shrimp which you find among the water-plants make excellent food for your fish.

### **Avoid Salt-Water Sand,**

stones, and shells, for the salts they contain are injurious to fresh-water creatures. Do not change the water in the tank after it is in running order; but as it evaporates replenish with fresh water.

## CHAPTER V.

### PIGEON-LOFTS AND BANTAM-COOPS.

THE best place in the world for boys is out-doors, breathing good fresh air, and the best place in the world for pigeons and chickens is out-doors, breathing good fresh air. Our modern environments too often limit the amount of out-door space which boys can occupy, and also limit the supply of fresh air they can furnish their pets.

In making designs for the latter we must take into consideration the limited space of a city back-yard, as well as the fact that during the extreme cold weather pigeons, chickens, and boys, all need some warm retreat where they may roost or sleep.

Indeed, chickens really

#### Need Shelter

more than either boys or pigeons; the former have been known to thrive and grow lusty and strong when living like the wild animals of the forests, and every boy knows of some location where pigeons have taken up their abode with no better shelter than that afforded by an open shed, or the overhanging eaves of a house.

#### Chickens,

coming originally from tropical woods, will thrive better where their delicate combs and toes are not liable to be frost-bitten, and one is more certain not to lose his fantails,

pouters, ruff-necks, tumblers, and homing pigeons, if he has a suitable loft in which to confine his pets. These considerations lead to the designing of a combined pigeon-house and bantam-coop suitable for the limited space of the diminutive city back-yards, or even appropriate for the roof of a rear extension, where there is no back-yard to the dwelling.

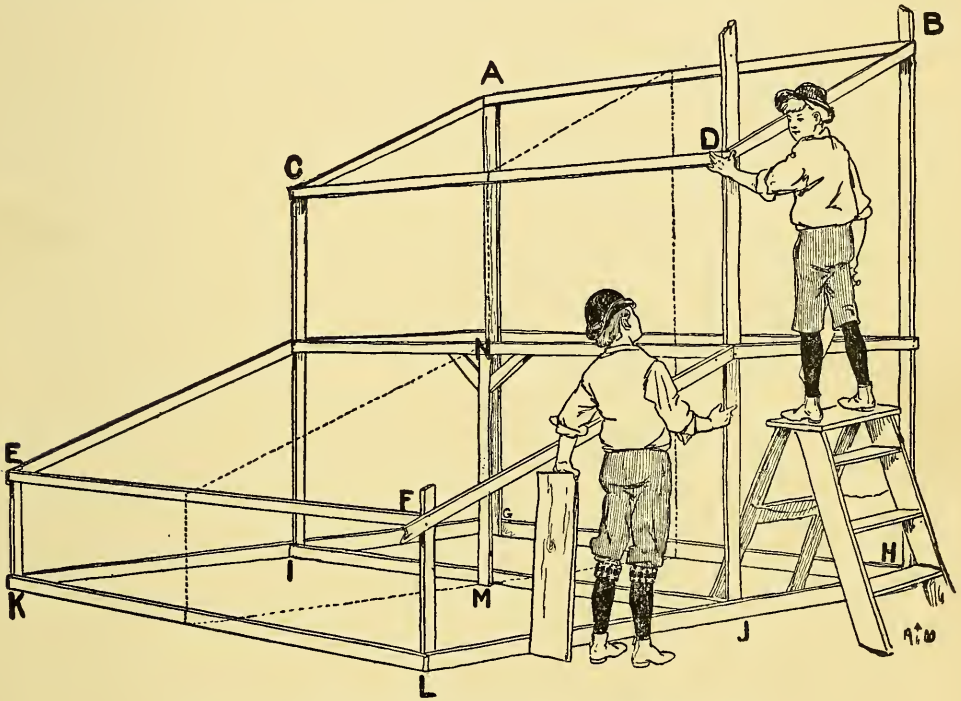

FIG. 31.—Frame of Bantam-Coop and Pigeon-Loft.

By referring to Fig. 31 you will see two boys at work upon the frame of

### **A Pigeon-Loft and Bantam-Coop**

which is capable of holding with comfort enough pets to gladden the heart of any healthy boy.

The longest posts, A G and B H, are supposed to be about nine or ten feet high and nailed fast to the back

fence. The dotted line, which cuts the frame in half, is to show that a building half the size of the one in the drawing will be plenty large enough for quite commodious quarters for the birds. After the frame has been nailed together and the protruding ends of the timbers all sawed off even with the rest of the frame, a floor must be laid to the pigeon-loft and securely nailed in place.

### **Rough Lumber Will Answer.**

It is not even necessary to have smoothed lumber for the flooring or any part of the house, but matched and planed boards will make a much neater piece of work. The uprights and all the frame are supposed to be built of "two-by-four" (two inches thick by four inches wide), but even this is not necessary, and in the country, where trimmed lumber is scarce, the whole frame may be built of poles cut in the woods.

When the

### **Pigeon-Loft Floor**

is nailed down, set the door-jambs in place, between D J and B H, and the window-jambs between D J and F L, as shown by Fig. 32. Nail the jambs fast to the rest of the frame, toenailing the loft door-jamb to the floor of the loft, and the coop jamb to the ceiling of the coop, also the two horizontal jambs of the window-frame to the two upright jambs of the same.

### **Shutter Frames.**

Over the top-piece, C D, and the bottom piece, N, nail two boards, each about six inches wide (R and S, Fig. 32), and upon the inside of the loft erect three boards, one at each end and one in the middle (facing the roof of the coop), each of the same width as the top and bottom-boards. This



is to make a framework for the shutters, with which to close the loft in bad weather. Over the uprights just erected nail the strips, Q, O, and P (Fig. 32). Repeat this with the front end of the coop, E, F, K, and L, of Fig. 31, and you will have it as represented by Fig. 32.



FIG. 32.—Framed and Roofed.

### Roofing Material.

There are several cheap kinds of tar and gravel-paper sold which make neat and durable roofings, not only for coops and sheds, but even for more ambitious structures. In case these are not easily obtainable, roof the loft and coop with ordinary boards, using another lot of boards to cover the cracks between the first layer (Fig. 32).

It is now only necessary to nail on your sidings, and your loft-coop is finished, all but the doors and windows.

Dimensions are not given for these, because it often happens that there is some old window or hot-bed sash lying around the place, and the jambs can be made to fit the sash. The sash is held in place by nails, for it is not intended to open the window, the sash only being used to let light into the lower bantam-coop.

The open face of the pigeon-loft and bantam-coop are to

FIG. 34.

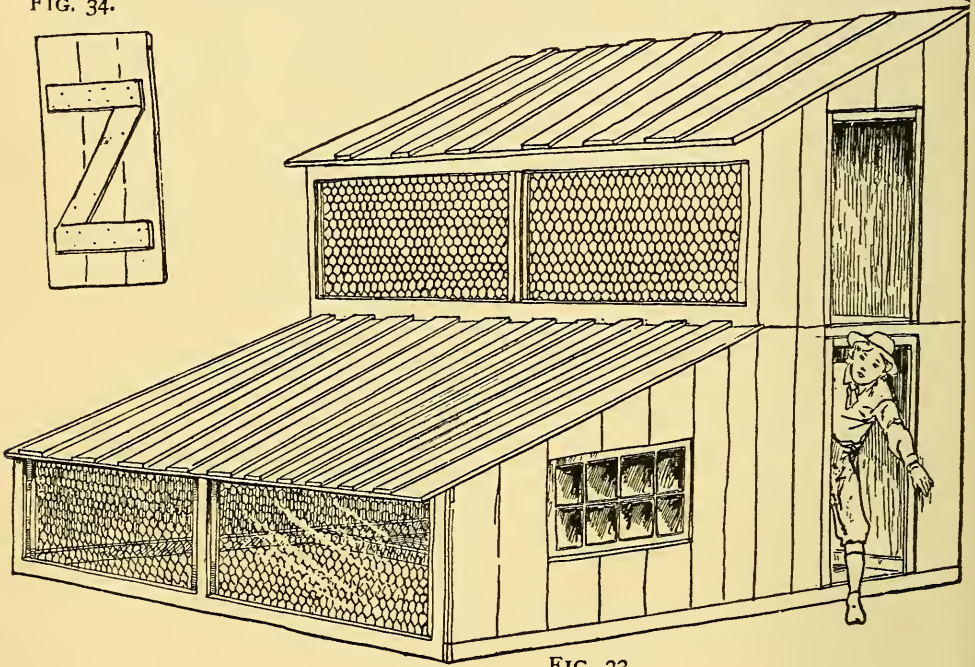

FIG. 33.

FIGS. 33 and 34.

be covered with wire-netting, fastened securely with staple tacks, inside the coop and loft, as shown by Fig. 33.

### Doors.

Fig. 34 shows how to make the doors of boards, fitted together and secured by two cross-battens and one diagonal-batten.

When the doors are hung upon their hinges the house is finished, but not furnished. It is not necessary to have any protection for the screen fronts during the summer, but when winter comes four shutters, made to fit these openings, it will be found, will keep out the storms and protect the inmates from the cold.

### **The Shutters**

may be made in the same manner as the doors, and hinged on to the lower sill of the loft, so that when open, during fair weather, they will rest securely upon the roof of the coop. The coop-shutters may be hinged in the same manner or simply fitted into place and held there by props of some sort, which, with the shutters, may be removed in fair weather, to admit the air and sunshine so dearly loved by your pets.

### **Keep Clean.**

I take it for granted that you know how to care for the chickens and pigeons; that you know that no being, not even man, can keep himself clean and healthy when confined to a small room. The keeper must attend to all household duties.

If your pets are untidy, soiled in appearance, and their abode infested with parasites, it will be because of the cruel thoughtlessness of their keeper. To facilitate house-cleaning, Fig. 35 shows the internal arrangement and furniture of the coop-loft, all of which may be removed in a few moments and the whole place cleaned and whitewashed.

### **The Hen's-Nest**

box is made with a steep slanting roof, which will prevent the chickens from roosting on the box. The latter has no

bottom to it; the nests rest upon the earth, so that you may pick up the box at any time, turn it upside down, and turn the hose on it, or plentifully plaster it with clean, wholesome whitewash.

### **Pigeon-Nests.**

A cleat nailed to the inside wall of the loft, near the door, serves as a rest for one end of the pigeon-nests. The other end is supported by a piece of wood about four inches wide which is hinged to the back wall, and its upper end held in place by a long hook made of a piece of telegraph wire.

If this hook is unfastened the wooden support falls down and the box of nests slips off the cleat into your arms.

Pigeons are not good at perching upon twigs or sticks. Their feet are adapted for walking upon flat surfaces, and they need a broad surface for a roost. Fig. 40 shows how to make a pigeon-roost, which may be hung up against the wall by slipping the two holes bored in the top of the back board over a couple of nails in the wall.

### **For a Hen-Roost,**

nail a narrow strip of wood, with its flat side upon the thin edge of another similar strip. The end will then look like a T, Fig. 38.

Round off the edges of the perch with a plane or knife until it is of the form of the right-hand diagram.

Fig. 37 shows a roost of this kind. Fig. 36 shows the adjustable side-rail, with slots for the perch to fit, and Fig. 39 shows a cleat to nail against the wall for the other end of the roost. As may be seen, the perch will fit in the slot in the cleat.



Drinking-Troughs.

Figs. 41 and 42 are drinking-troughs, arranged so that the birds will not soil the water.

The jug-trough was made by a farm hand, friend of the writer. He made a hole near the bottom of the jug by first nicking off a piece of the hard glazed surface with the corner of a hatchet, and then drilling the hole with a sharpened nail. When the jug was filled with water, a stopper was put in and it was set in an old dish; the water remained above the hole in the jug, but rose no higher.

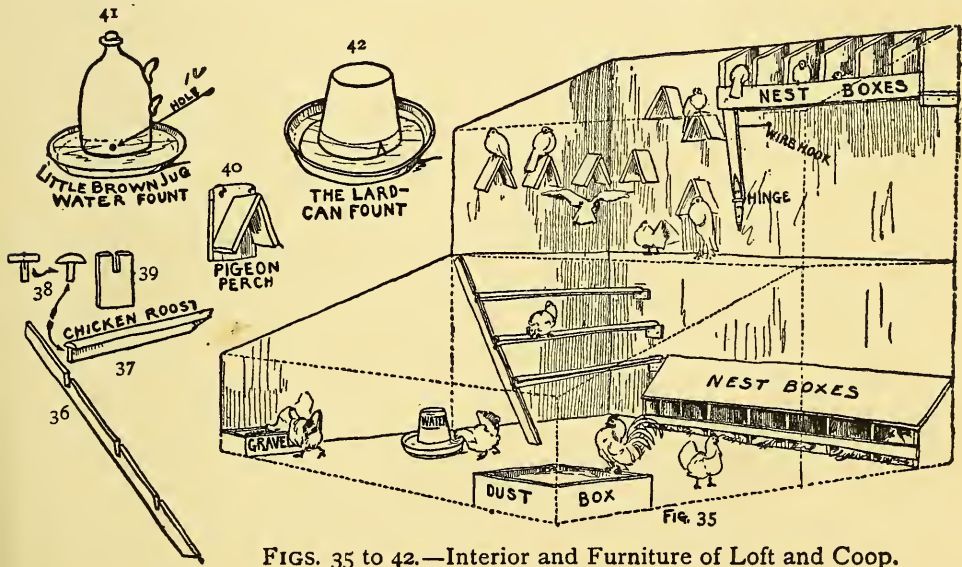

FIGS. 35 TO 42.—Interior and Furniture of Loft and Coop.

Fig. 42 is an

Old Lard-Can,

with a triangle cut in the edge. Fill the can with water and place a dish over the top, hold the dish in place, and turn the can upside down, and the water will fill the dish and keep it filled to the top of the cut in the can as long as there is water in the can.



### Flying-Cage.

By erecting posts at or near the lower end of the bantam-coop and stretching wire netting from post to post, and thence to pigeon-loft, a space can be enclosed and roofed over with netting, which will allow your pigeons room to exercise their wings. This arrangement does not necessarily use up a foot more ground space.

There are many other simple arrangements which these few will help to suggest to the reader, and which will add to the comfort and happiness of his pets.

## CHAPTER VI.

### HOW TO MAKE A BACK-YARD AVIARY.

IT was before the directors of the Brooklyn Institute had met with success in their silly work of introducing the house-sparrow (known here as the English sparrow) to this country, and long before these foreign pests were spread over the length and breadth of the United States, that the court-house in Covington, Ky., was surmounted by a wooden image of George Washington.

#### **Bird's-Nests in Washington's Coat.**

All boys know that Washington loved his country, but few know that he was a bird-fancier. That the father of our country loved the native birds is attested by the fact that they built nests in the wooden wrinkles of his sleeves and in the hollow ends of the roll of parchment which he held in his hand. His favorite bird was the red-headed woodpecker. He had it on the brain, and although each year a brood of little red-headed birds were hatched in his head, the dear old patriot never made a wry face, but with a benign smile he gazed over the roof of the livery stable across the street.

#### **Bird's-Nests in Speaking-Horn.**

Upon the same lot with the court-house stood the fire-engine-house, with its old-fashioned lookout tower. On the top of the tower was a weather-vane, made of a great fire-

man's horn, but the only voices which ever issued from this old speaking-trumpet were the voices of the purple martins, singing their bubbling love songs, the twittering of their mates, or the impatient piping of the young birds inside their revolving home.

It was in the swinging, moving weather-vane of the engine-house that these birds each year built their nests and reared their young.

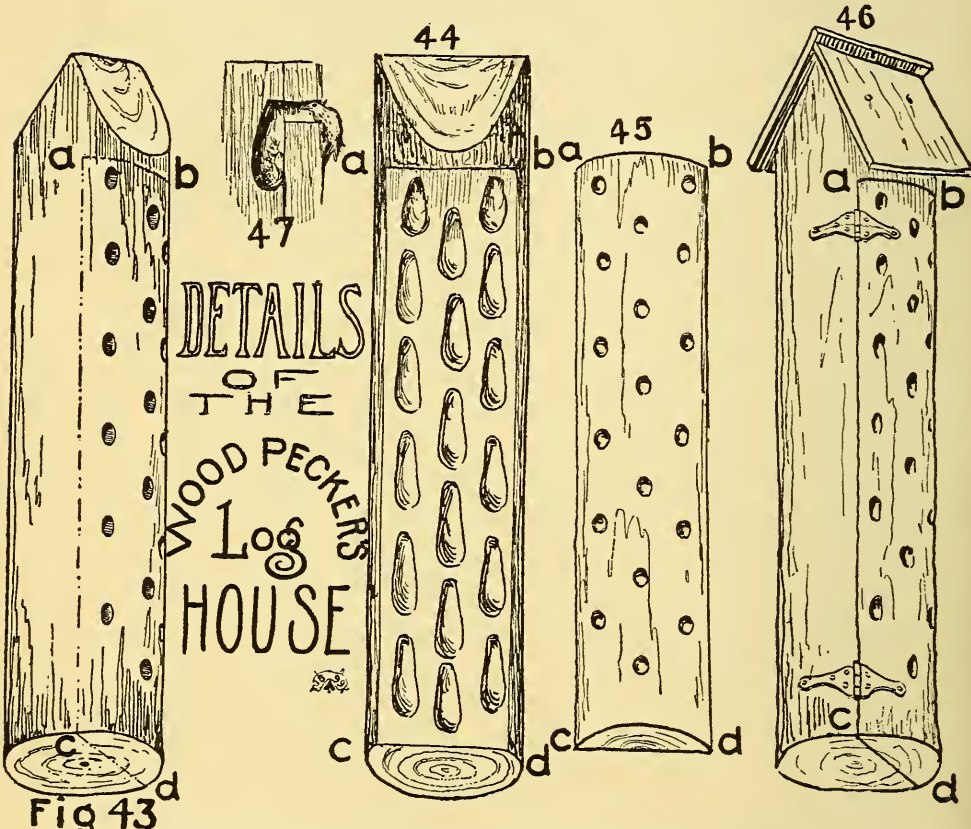

FIGS. 43 to 47.—The Log may be Rounded or Square.

A Woodpecker's House.

There is an army of interesting birds called creepers, sapsuckers, and woodpeckers, which no one has, apparently,

thought of providing with homes, yet it is not difficult to suit the woodpeckers with houses.

A substitute for their favorite rotten tree or stump may be made of a sound piece of timber. The log may be squared or rounded, as in nature (Fig. 43). Saw off the bottom so that the log may set upright, then trim off the top end wedge-shaped, to shed the rain or to receive a roof, which will still further protect it from the weather.

Next saw a deep cut as shown by the dotted line, A, B. With a large-sized auger bore a number of holes in the face of the log; these holes must be bored deep enough to leave a slight indentation in the main part of the log after the piece, **a, b, c, d**, has been removed.

After the holes are bored begin at **c, d** and saw to **a, b** (Fig. 43), and lift off the piece **a, b, c, d** (Fig. 45).

With chisel and gouge cut out the nest holes. Make them about eight inches deep, as shown in Fig. 44. Fig. 47 gives a cross-section of the hole, showing it to be of the same form as those made by the birds themselves, in George Washington's head, or the old stump in the woods.

### **The Perforated Door**

may now be replaced and spiked to the log, and the roof (Fig. 46) nailed on the top, which will complete the woodpecker's home.

A better plan than spiking the door in place is to hang it on hinges, as shown in Fig. 46.

### **The Hinged Door**

should be supplied with a padlock, as a safeguard against children and too-curious grown people. A handful of sawdust thrown into the bottom of each nest-hole will supply



the place of the absorbent rotten wood to which these birds are accustomed.

It is claimed that the English sparrow will not nest in a swinging or moving house. If this is true we may

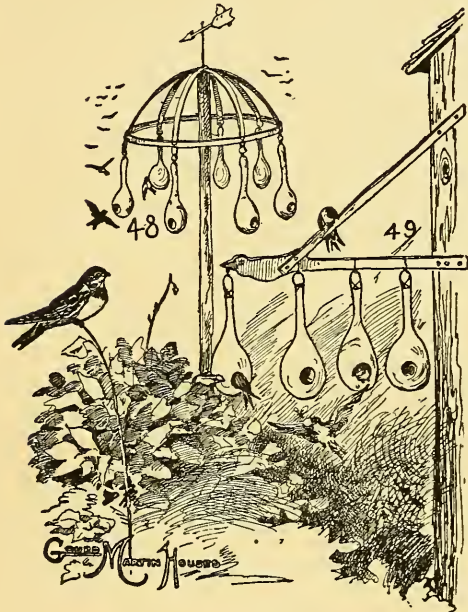

FIGS. 48 and 49.—Bottle Gourds Hung to Brackets.

**Bring the Martins Back**  
by supplying them with swinging houses made of dipper and bottle gourds, hung to brackets or to hoops and poles (Figs. 48 and 49).

### The Gourds for Bird's Houses

must be thoroughly dried, and doorways cut in each, near the bottom of the bowl. Never make the entrance to any sort of a bird-house on a line with the bottom of the house, for the nest will block the doorway.

### Paint the Gourds

bright red, green, blue, and yellow, and fasten the small ends to the supports with copper wire, as shown in Figs. 48 and 49.

### The Wren-House

shown in Fig. 50 is made of a grape-basket, and will not stand rough weather, but if put in a sheltered place it will last a long time. Wrens love to build under a roof of any sort.



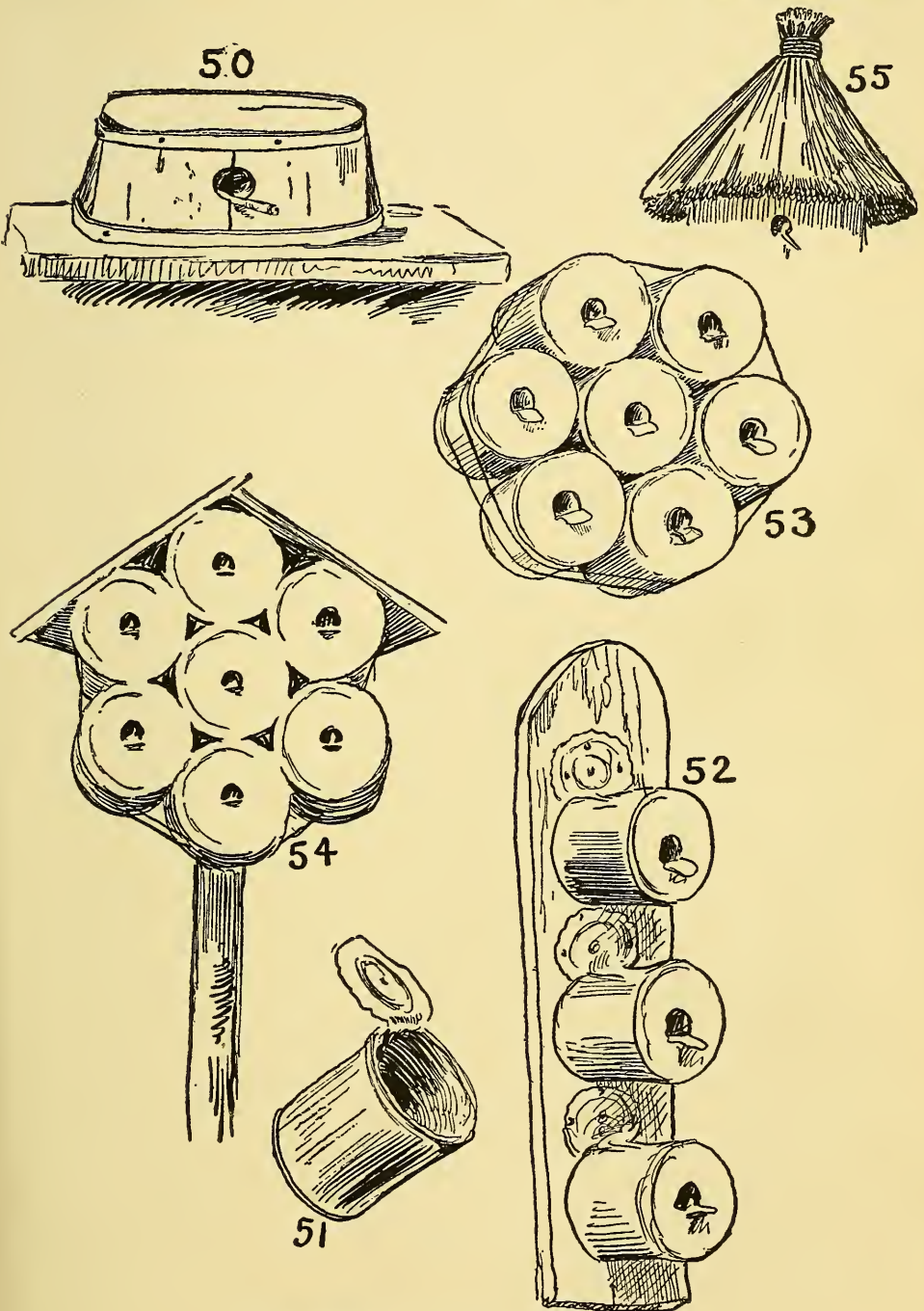

FIGS. 50-55.—Made from Fruit-Cans.

**Tin-Can Bird-Houses.**

Fig. 51 is an old fruit-can. Fig. 52 is the same nailed to a board. These tin cans may not appear beautiful when nailed to tree or shed, but if neatly painted and wired together (Fig. 53) they will present a most attractive appearance. Fig. 54 is a nest of cans, roofed. If a bunch of straw is bound firmly together, and the opposite ends spread over the bird-house (Fig. 55), it will make a very attractive thatched roof.

**A House of Straw.**

A pretty and durable house may be made by binding straw around hoops, and roofing the structure thus made with a bunch of straw.

Figs. 56, 57, and 58 explain the structure of

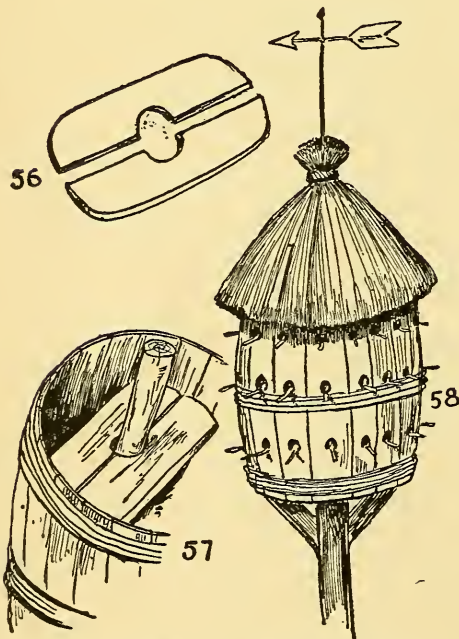

FIGS. 56-58.—A Thatched Barrel.

**A Barrel for a Martin-House** which, when neatly made and thatched with straw, is decidedly ornamental, and will be duly appreciated by your bird friends.

If we can keep the English sparrows away, the bluebirds will nest in any sort of a sheltered hole.

Earthenware flower-pots, as shown in Fig. 59, may be used for bird-houses if you enlarge the holes in their bottoms to serve as doorways, and enclose the upper

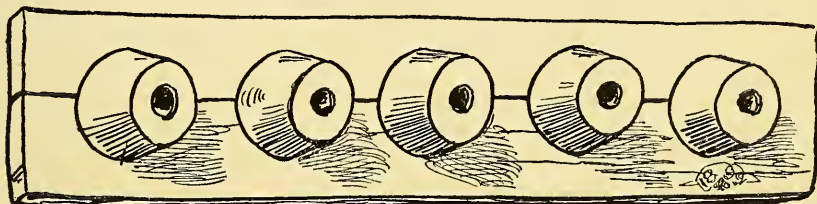
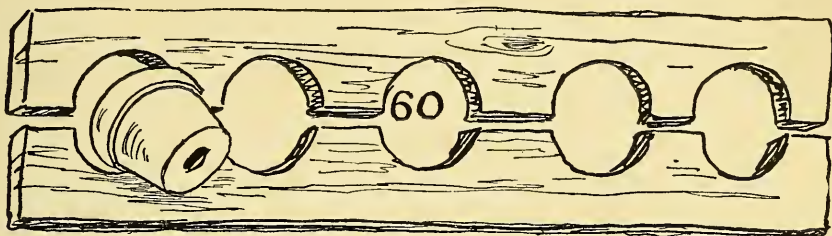

61

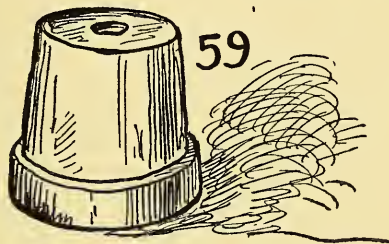

59

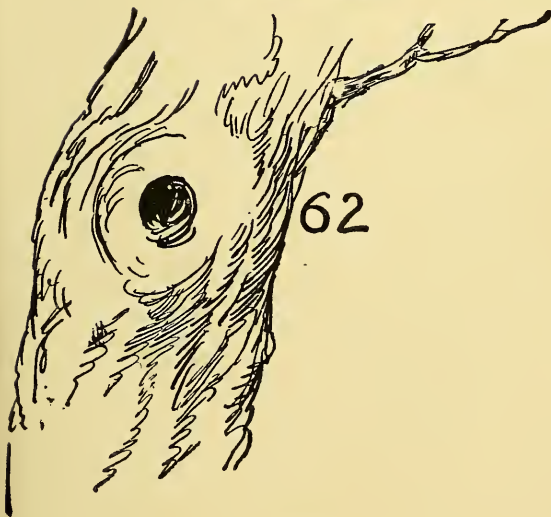

62

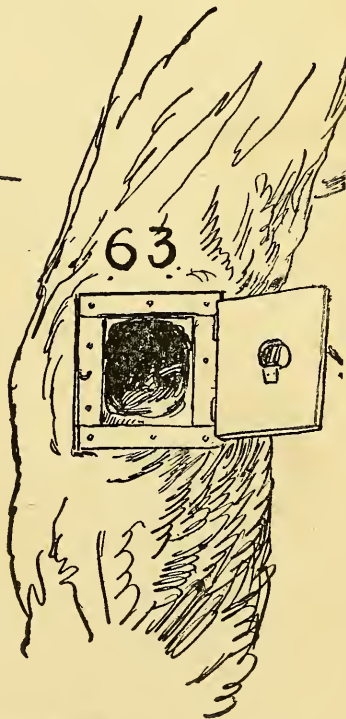

63

FIGS. 59-63.—From Earthenware Pots.

part between two boards (Figs. 60 and 61) which have previously had places cut out to receive the pots. If any of your shade or fruit-trees have

### **Old Knot-holes**

in them (Fig. 62), the rotten wood can be cleaned out, a frame nailed around the opening, and a neat little door (Fig. 63) put on the frame.

The door should have a hole through it, with a perch or stick attached, and this will make an ideal bird-house.

### **An Available Supply of Moist Clay**

will often induce the cliff-swallows to plant a colony in your neighborhood, and holes made in the gable ends of your stable will invite the social barn-swallow to build under the protecting roof.

Do not fail to keep fresh water, in shallow pans or earthenware dishes, on your lawn, for bird baths.

At my suggestion Samuel Jackson, my young brother-in-law, set out baths upon the lawn last summer, and the photograph on the opposite page is one which he took of a wild robin enjoying his free bath.

There is another

### **Little Native American**

friend which the noisy sparrows are doing their best to drive away. This is the house-wren: as interesting and busy a little mite as ever protected a garden from noxious insects. If you make your wren-house door the size of a silver quarter of a dollar no robber sparrow can enter to despoil the nest.

Of our seven common species of swallows, four are availing themselves of the opportunity offered by the barns for nesting.





Wild Robin at His Bath.

*Photographed from life by Samuel Jackson.*





---

Barn-swallows build under roofs; cliff-swallows, under eaves; the white-bellied-swallow and martin, in boxes set up for that purpose, when these shelters are not preëmpted by the English sparrows.

The native swallows destroy an amount of noxious insects beyond calculation, and almost beyond imagination. Without birds this world would, because of insects, be uninhabitable, yet each year two hundred millions of them are sacrificed *for women's hats and bonnets*. Aside from the inexcusable barbarity of this practice is its menace to our trees, our crops, and our very existence.

## CHAPTER VII.

### A BOY'S BACK-YARD WORKSHOP.

#### How to make Buildings Plumb and Level.

By a workshop is meant a place where a boy can build a boat, sled, box-kite, man-kite,\* mend a golf-club, a broken bicycle, his mother's rocking-chair, his aunt's umbrella, or build a paper-balloon.† It is a room, house, or shed, where a boy can do what pleases him, without being in everybody's way; a place where he can retire and idly whittle a stick, or seriously work out some youthful invention; a place where he can entertain his young friends during the rainy or stormy days of winter, and where they can talk over the new football team, baseball or golf club, without being oppressed with the knowledge that their loud talk is annoying the older folks.

The late war has demonstrated to the whole world the wonderful skill and pluck of the young American, and the world must not suppose these qualities to be suddenly acquired, but must know them to be a matter of education—an education acquired during boyhood, at the boy's own school, with boy professors.

#### The Success of Americans

is not on account of any peculiarity of the blood which flows in their veins, but because they live under a govern-

---

\* For description and diagrams see "The Outdoor Handy Book,"

† "The American Boy's Handy Book."

ment which teaches independence, and the boys on the play-ground become self-reliant, resourceful lads, developing their skill by building kites, sleds, and boats, and developing their pluck on the baseball and football field.

To such youths it is unnecessary to enumerate the advantages of a workshop; neither is it essential to point out to them the fact that they may commence their collection of tools with a serviceable pocket-knife.

### **A Good Oil-stone,**

to keep the knife sharp, is a prize, and for its protection from dust or injury it should be set into a block of wood so that about one-eighth of an inch of the stone projects above the block. A similar block, with a space the size of the stone and one-eighth of an inch deep cut out of its centre, should be made for a cover.

### **A Hatchet**

is not a difficult thing to procure, and a saw, a screw-driver, a gimlet, and a three-cornered file can be added to the collection as opportunity offers. Next a chisel or two, and you will have a kit of tools with which, if skilfully used, you can build anything from a three-legged stool to a flying-machine.

### **Use the Best Tools You Can Get.**

With an axe or hatchet, an auger and a sheath-knife, the whole race of pioneers, including Daniel Boone, Davy Crockett, and the parents of Abraham Lincoln, built their homes and made their household furniture.

It is not to be supposed that any boy, in his right mind, will prefer an old dull auger, blunt axe, and a butcher-knife

to a chest of bright, new, modern tools, but unless a boy belongs to the Miss Nancy, Little Lord Fauntleroy type, he will do his best with the implements at hand, and acquire better ones as the occasion offers. In this manner the contents of his tool-chest will grow gradually, and keep pace with the development of his skill as a mechanic.

Such a lad, when in need of

### A Level,

will make himself one, probably using three pieces of board, a string, and a weight, as shown in Fig. 64. The

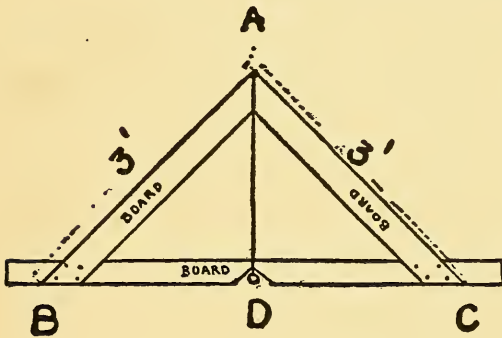

FIG. 64.

two side-pieces of wood being exact duplicates in all dimensions, the angles at the bottom are necessarily equal, and a line from the apex (A) to the centre of the bottom-piece must be a plumb line. After sawing out his side-boards and joining them at their top edges, he nails a straight piece to the bottom-ends, using the utmost care to have the lower edge of the bottom-board exactly the same distance from A on each arm; that is, A B must be exactly the length of A C, and B D must equal D C. He next cuts a small notch at A, so that he can fit a string at the crack between the two arms, A B and A C. A notch is also cut at D, to allow the weight play-room. When the lower edge of the bottom-board is placed upon a level, and the string ceases to vibrate, it will be found that, the bullet hanging free, the string exactly covers a line which has been previously ruled across the bottom-board. The line was ruled by placing a



straight-edge, or rule, at A and D. The slightest incline of the base-board will throw the string to one side or the other, and show the base to be out of level.

This implement is a simple thing to construct, is as serviceable as a spirit-level, and as reliable.

For buildings, a large-sized level, with side-pieces three feet long, is useful. Smaller ones are handy in the shop.

### **A Convenient, Home-Manufactured Plumb**

is made by dividing a straight piece of board with a black line, exactly in the centre, extending from end to end. This piece is notched at one end in the same manner as the previous one, and a string and weight attached, as shown by Fig. 65. By placing the edge of this against a wall it can be determined whether it is in or out of plumb.



FIG. 65.

The boy who can manufacture these two tools can, with the aid of other boys, build himself

### **A Workshop ;**

and it is possible he can do it alone, but when it comes to lifting heavy lumber he will be glad of the assistance of some of his friends.

If the reader is the happy possessor of some old locust fence-posts, he has the best sort of material for a foundation. Lacking locust, chestnut posts will make a good substitute. Lacking chestnut, some carefully laid and levelled stones or bricks will answer all purposes. I have seen many an old house resting upon four heaps of rough stones, the latter having faithfully supported the edifice for years, and prevented the sills from rotting from contact with the damp earth.

Even the ground will answer for

### A Foundation,

if the dirt is properly packed and drained. All through certain sections of this country there are hundreds of humble dwellings built upon "mud-sills"—in other words, with no other foundation or floor but the bare ground.

I will, however, suppose that you have secured some posts about two feet six inches long and with good flat ends.

The better the material you can obtain, the trimmer and better will be the appearance of your house; but a house

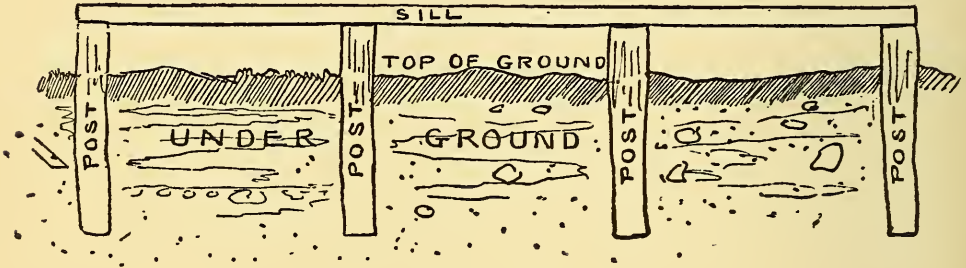

FIG. 66.

which will protect you and your tools may be made of the roughest of lumber.

The plans drawn here will answer for common or fine material, but we will suppose that medium material is to be used. It will be taken for granted that the reader is able to procure enough two-by-four-inch timber to supply studs, ribs, purlins, rafters, beams, and posts, for the frame shown in Fig. 69. Two pieces of four-by-four-inch timber, each fifteen feet long, should be procured for sills. If this is inaccessible, two pieces of two-by-four nailed together will make a four-by-four sill. Add to this some tongue-and-grooved boarding for sides and roof, some enthusiasm and good American pluck, and the shop is almost as good as built.

### How to Build the House.

First lay out the foundation, eight feet by fifteen; see that the corners are square—that is, at right angles; test this with a tape or string, by measuring diagonally from corner to corner both ways, and if it measures exactly the same you are all right, and may proceed to dig your post-holes. The outside of the posts should be flush, or even, with the outside edges of the sills and end-beams of the house, as shown in Fig. 66. There are to be four posts on each of the long sides of the house, at equal distances apart—a little less than five feet from centre to centre of each post.

Dig the holes two feet deep, allowing six inches of the posts to protrude above ground. If you drive two stakes a short distance beyond the foundation, in line with your foundation lines, and run a string from the top of one stake to the top of the other, you can, without much trouble, get

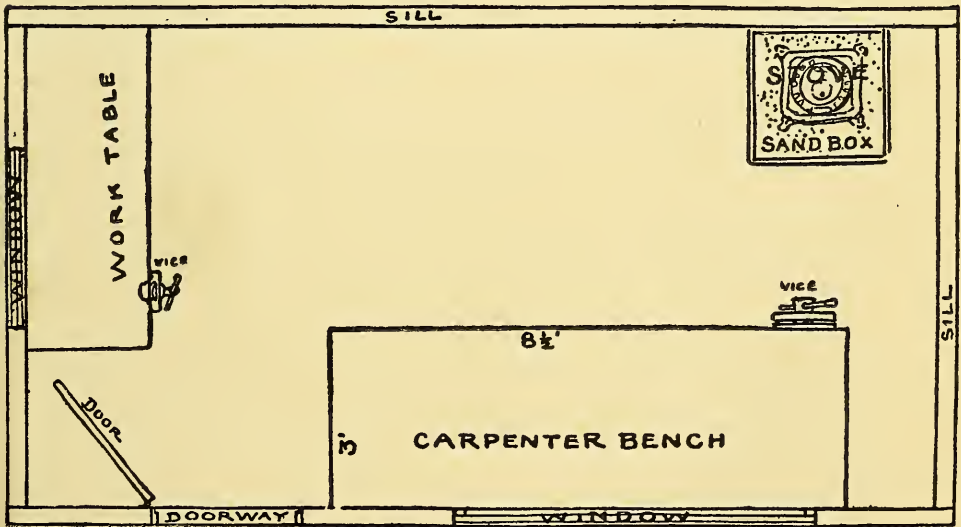

FIG. 67.

it upon a perfect level by testing it with your home-made level, and adjusting the stakes until the string represents the level for your sill. When this is done,

### Set Your Posts

to correspond to the level of the string, then place your sill on top of the posts, and test that with your level. If found to be correct, fill in the dirt around the posts and pack it firmly, then spike your sill to the posts. Go through the same operation with the opposite set of posts and sill.

The first difficult work is now done, and, with the exception of the roof, the rest only needs ordinary care, and what old-fashioned people used to term "gumption."

It is to be supposed that you have already sawed off and prepared nine two-by-four-inch beams, each of which is exactly eight feet long. Set these on edge from sill to sill, equal distances apart, the edges of the end-beams being exactly even with the ends of the sills (Figs. 66 and 69). See that the beams all cross the sills at right angles, and



FIG. 68.

toe-nail\* them in place.

You may now neatly

### Floor the Foundation

with one-inch boards; these boards must be laid length-wise with the building and crosswise with the beams.

---

\* Toe-nailing, or foot-nailing, consists in driving the nails diagonally or slantingly down through the ends of the beams to the sill, in place of nailing through from the top down to the sill.



When this is finished, you will have a beautiful platform on which to work, where you will be in no danger of losing your tools, and you may use the floor as a table, on which to measure and plan the sides and roof.

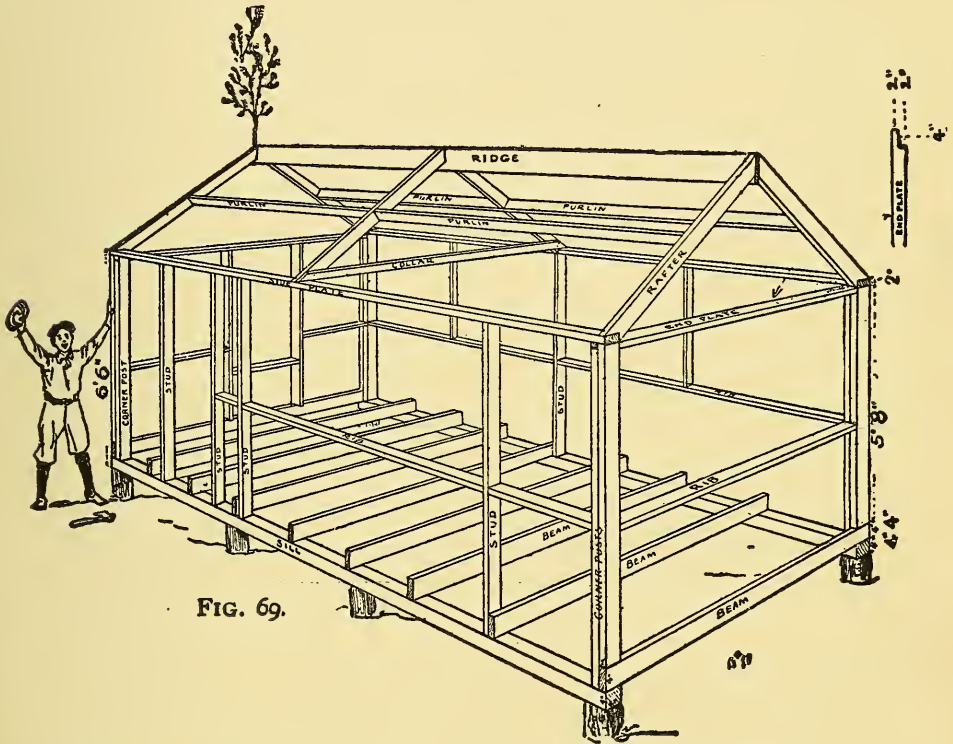

FIG. 69.

It is a good idea to

### Make Your Ridge-Plank and Rafters

now, while the floor is clear of rubbish.

Lay out and mark on the floor, with a carpenter's soft pencil, a straight line, four feet long (A B, Fig. 70). At right angles to this draw another line, three feet six inches long (A D, Fig. 70). Connect these points (B D, Fig. 70), with a straight line, then complete the figure A B C D (Fig. 70). Now allow two inches at the top for the ridge-plank at B,



and two by four for the end of the side plate at D. You then have a pattern for each rafter with a "plumb-edge" at B and a "bird's-mouth" at D. The plumb-edge must be parallel with B C, and the two jaws of the bird's-mouth (Fig. 71) parallel with D C and A D, respectively. Make six rafters of two-by-four-inch wood, one ridge-plank of two-by-six or seven-inch wood.

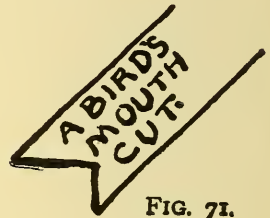
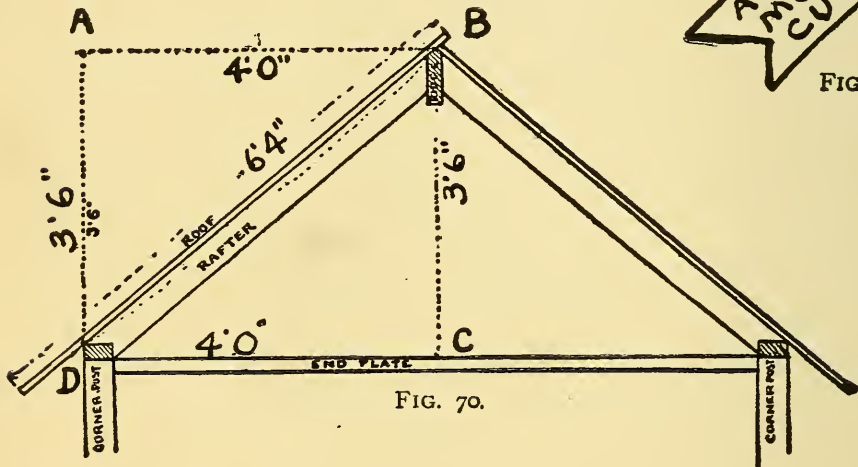

### The "Purlins" and "Collar"

can be made and fitted after the roof is raised. Set your roof-timber carefully to one side, and clear the floor for the studs, ribs, and plates. First prepare the end-posts, and make them of two-by-four. Each post is of two pieces (see Fig. 69). There will be four outside pieces which rest on the end-beams. These will be each five feet eight inches in length, and four inside pieces, each six feet in length; this allows two inches at the top for the ends of the end-plates to rest upon.

### **Examine the Corner-Posts**

in Fig. 69, and you will see that the outside two-by-four rests partly upon the top of the end beam, and the side-plate rests directly upon it. You will also observe that the inside two-by-four rests directly upon the sill, which would make the former four inches longer than the outside piece, if it extended to the side-plate; but you will also notice that there is a notch in the end-plate for the outside corner-piece to fit in, and that the end of the end-plate fits on top the inside piece of the corner-posts, taking off two inches, which makes the inside piece just six feet long. This is a very simple arrangement, as may be seen by examining the diagram. Besides the corner-posts, each of which, as we have seen, is made of two pieces of two-by-four, there are four studs for the front side, each six feet two inches long, and one stud for the rear wall, six feet two inches long. The short studs shown in the diagram (Fig. 69), on the rear side, are unnecessary, and are only shown so that they may be put in as convenient attachments for shelves and tool-racks.

### **The First Stud**

on the front is placed two feet from the corner-post, and the second one about six feet six inches from the first, to allow a space for a six-foot window over the carpenter's bench; the next two studs form the door-jambs, and must be far enough from the corner to allow the door to open and swing back out of the way. If you

### **Make Your Door**

two and one-half feet wide—a good size—you may set your last stud two feet from the corner-post, and leave a space

of two feet six inches for the doorway. Now mark off on the floor the places where the studs will come, and cut out the flooring at these points to allow the ends of the studs to enter and rest on the sill. Next make four ribs—one long one to go beneath

### **The Window,**

one short one to fit between the corner-post and the door-stud (not shown in diagram), another to fit between the door-stud and the window-stud, and another to fit between the window-stud and the first corner-post (the nearest corner in the diagram Fig. 69). Next make your

### **Side-Plate**

exactly fifteen feet long. Fit the frame together on the floor, and nail the pieces together, toe-nailing the ribs in place. A lot of boys may now raise the whole side-frame, and the ends of the studs can be slipped into their respective slots, the end-posts made plumb, and temporarily held in place by a board, one end of which is nailed to the top end of the post and the other to the end-beam. Such a diagonal board at each end will hold the side in place until the opposite side is raised and similarly supported.

It is now a simple thing to slip the end-plates in place under the side-plates, until their outside edges are even with the outside of the corner-posts and their notched ends under the side-plates, and resting snugly upon the tops of the inside pieces of the corner-post. A long wire-nail driven through the top-plates and end-plates down into the posts at each corner will hold them securely in place. Toe-nail a rib between the two nearest end-posts, and make two window-studs and three ribs for the opposite end. The framing now needs only the roof-timbers to complete

**The Skeleton of Your Shop.**

Across, from side-plate to side-plate, lay some loose boards, for a platform; then, standing on these boards, let your assistant lift one end of the ridge-plank, while with one nail to each rafter you fasten the two end-rafters on to

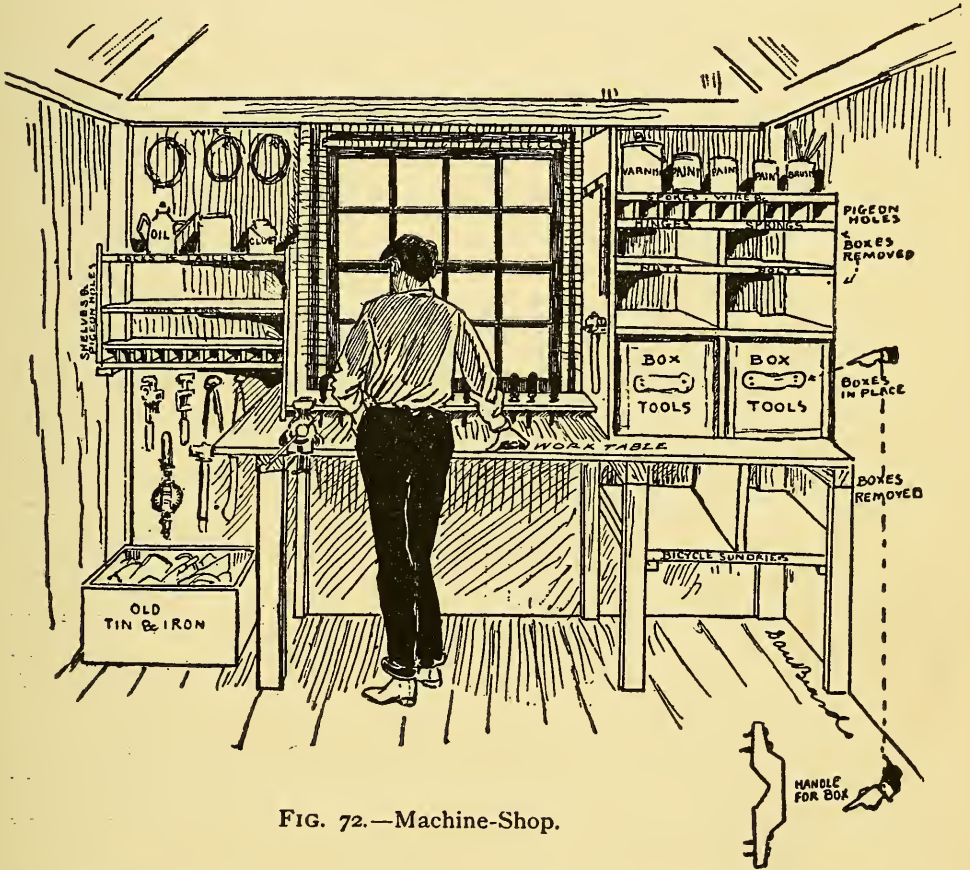

FIG. 72.—Machine-Shop.

the ridge-plank, fit the jaws of the bird's-mouth cuts (Fig. 71) over the ends of the side-plates, and hold them temporarily in place with a "stay-lath"—that is, a piece of board temporarily nailed to rafter and end-plate. The other end of the ridge is now resting on the platform at the other end



of the house, and this may be lifted up, for the single nails will allow movement and play to the posts.

### **The Rafters**

are next nailed in place, with one nail each, and a stay-lath fastened on, to hold them in place. Now test the ends with your plumb-level, and when they are found to be correct, nail all the rafters securely in place; stiffen the centre pair with a piece called a collar (see Fig. 69). Add four purlins (Fig. 69), set at right angles to the rafters, and take off your hats and give three cheers.

But do not forget to

### **Nail a Green Bough to your Roof-tree,**

in accordance with the ancient and time-honored custom. The sides of the house may be covered with the cheapest sort of lumber, and roofed with the same material, but if you can secure good stuff, use  $13 \times \frac{7}{8} \times 9\frac{1}{4}$ -inch tongue and grooved, one side planed so that it may be painted; you can make two side-boards out of each piece six feet six inches in length. Nail the sides on, running the boards vertically, leaving openings for windows and doors at the proper places.

If you have made a triangular edge to your ridge-stick, as in Fig. 70, it will add to the finish, and the roof may be neatly and tightly laid, with the upper edge of one side protruding a couple of inches over the opposite side and thus protecting the joint from rain. Additional security is gained by nailing what are called picket-strips ( $\frac{7}{8} \times 1\frac{3}{4}$  inches) over each place where the planks join. Lack of space forbids me to go into many details, such as the manufacture of the door and the arrangement of windows, but these small



problems you can easily solve by examining doors and windows of similar structures.

Figs. 67, 72, and 73 show the arrangement of the interior of the shop. Near the door and against the window is a work-bench with shelves, boxes, and tool-racks. This end of the room is called

### **The Machine-shop,**

for here are the metal working-tools, wire springs, locks, bolts, nuts and all the odds and ends that are useful for mending anything, from a bicycle to an umbrella. Under the six-foot window is the carpenter's bench for carpenter-work.

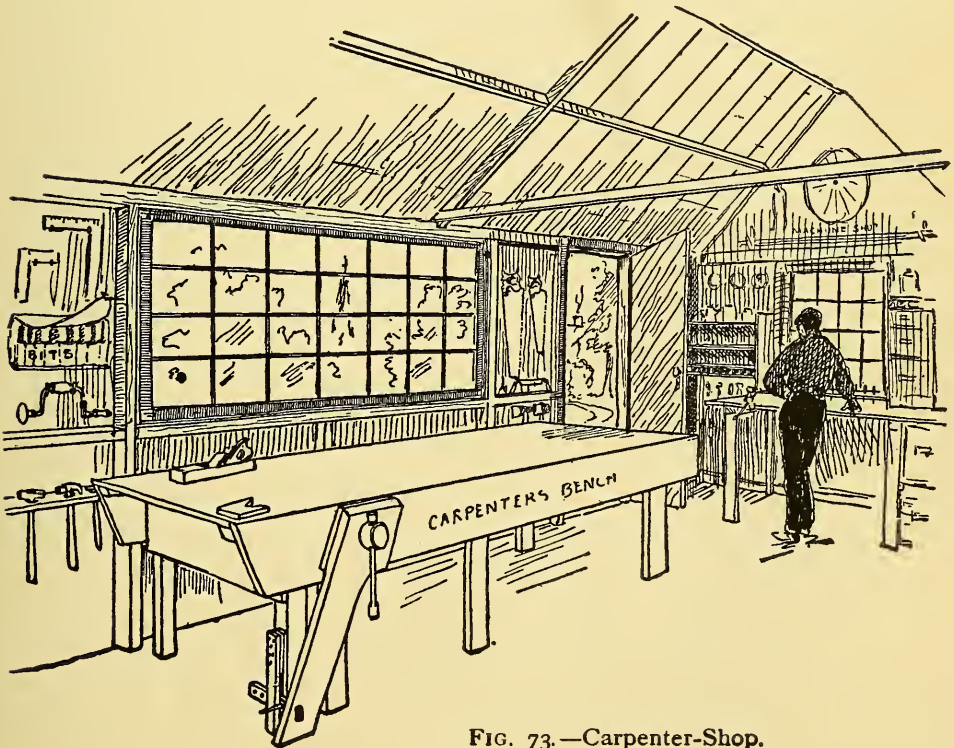

FIG. 73.—Carpenter-Shop.

In Fig. 72 there is a

### Tool-rack

across the front of the window for files, chisels, etc., but this is only a place to thrust the tools you happen to be using at the time. On account of the danger of rain from the open window, tools should not be left in the rack after the work is finished. In place of drawers, wooden boxes are made to fit loosely into compartments prepared for them. These boxes have wooden handles, as shown in the diagram, and they will be found very convenient. There is plenty of room under this work-table for more boxes when the accumulation of materials renders

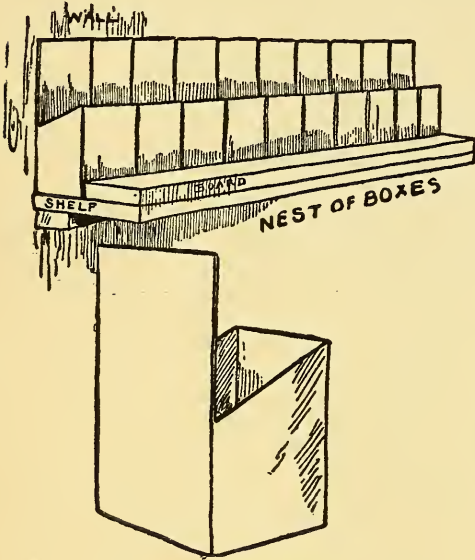

FIG. 74.—A Box.

additional storing-room necessary. Sets of deep pigeon holes are very convenient for extra bicycle spokes and similar objects. Fig. 73 shows

additional storing-room necessary. Sets of deep pigeon holes are very convenient for extra bicycle spokes and similar objects. Fig. 73 shows

### The Carpenter's Bench,

and a few tools stored on the wall. A board with holes bored in it makes a good rack for hammers; saws should always hang in an accessible place, and ordinary brass or iron hooks may be used for this purpose.

### To Protect your Auger-bits

from danger of rust, tack a piece of thick cloth or soft piece of leather to the wall, using sufficient material to allow a

flap to hang down and cover the bits. Under the flap is a number of pockets, divided by stitching the front to the back-piece, or by tacking the division lines to the walls. (See the left-hand upper corner of Fig. 73.)

### Care of Shavings.

A barrel or large box or basket should always be near the carpenter's bench to receive the shavings, and the stove must be set in a box of sand or earth, to prevent any danger of hot coals falling amid the easily ignited materials in the carpenter-shop. (Fig. 68.) The hole in the roof, where the stove-pipe goes through, must be protected by a sheet-iron ring or collar.

### A Place for Tool-racks.

The blank wall, opposite the carpenter's bench, may be covered with tool-racks, shelves, and other arrangements for the convenience of the young workmen.

### To Keep Small Things.

A number of old square tin boxes, such as certain firms use for packing cocoa, mustard, and various other food material, may be utilized by simply cutting off three sides, as shown in Fig. 74, and making a shelf with a depression for them to fit into, as shown in the sketch.

This makes a most convenient nest of boxes for screws, staples, and similar objects. Each box may be lifted out of



FIG. 75.—Rack Stick.

the rack by its long back and set where it is handy, until you are through with it; then it may be replaced in exactly the same spot, without trouble or annoyance.

Figs. 75 and 75a show

### A Famous Old Rack,

which is familiar to all who have lived in the woods. It can be made of the branch of any shrub or tree, with the aid of a pocket-knife, and nailed to the wall as shown in Fig. 75a.

Moulding, boards, and picket-strips can be stored over-

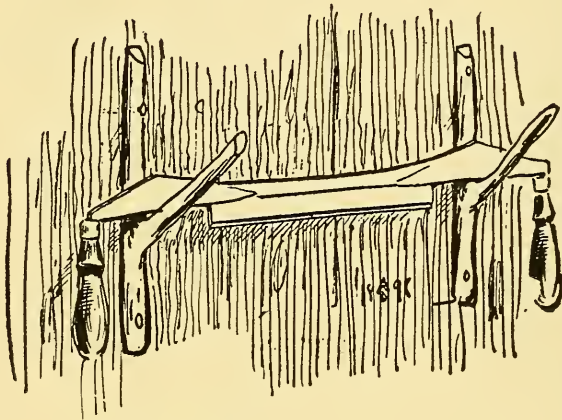

FIG. 75a.—The Famous Old Rack.

head, resting on the end-plates and the rafter-collar in the middle of the roof.

This workshop has been planned so as not to crowd a small back-yard, and if it is built of lumber which presents a smooth outside it may be neatly painted, and will not injure the appearance of the yard in the least. Vines may be trained over the walls of the shop and flowers planted around the outside, without in any manner interfering with its convenience as a workshop, or lowering the dignity of the young artisans who make it their head-quarters.



## CHAPTER VIII.

### HOW TO BUILD AN UNDERGROUND CLUB-HOUSE.

THE muffled sound of voices, interrupted by peals of hollow laughter, issuing from the apparently solid earth, is a sufficiently startling phenomenon of itself; but when a group of boys and a dog suddenly emerge from the ground it is calculated to induce the most prosaic of persons to believe that the gnomes of fairy stories are, after all, living realities. For the peace of mind of all who may hear the mysterious voices and see the apparitions just described, it may be well to state that the gnomes are human and are members of the Bank-Swallows' Club, and if you hear their voices under your feet it is because you happen to be standing on the roof of their underground club-house.

These

#### American Gnomes

use only such magic as their healthy brains and sturdy arms can supply, and if they "cast a charm" upon you it will be one of the most delightful of all spells—the charm of boyhood!

The club-house may be built with

#### A Doorway at the Top

of the bank, concealed by a trap-door, or with an entrance from the hillside, as shown in the diagrams. If the reader chooses the first style he has simply to follow the diagrams



here given, and reversing the proportions of the ventilator and entrance (Fig. 79), make an entrance of the vent and a vent of the entrance.

### The Trap-Door

must be placed high enough above the surface of the ground to prevent the water from running into the house in wet weather, and a ladder should be provided, by which the boys may climb in and out of the house with ease.

### Dimensions of the House.

The house should be big enough to allow room for a table and some chairs, stools, or benches, and the roof be so arranged that the tallest boy in the crowd may stand erect, with no fear of bumping his head.

The furniture must be placed inside the frame as soon as the floor is laid, because after the house is finished the entrance is too small to admit the passage of any object of more bulk than a creeping boy.

The hardest work is digging the foundation in the hill-side, but if six or seven boys take a

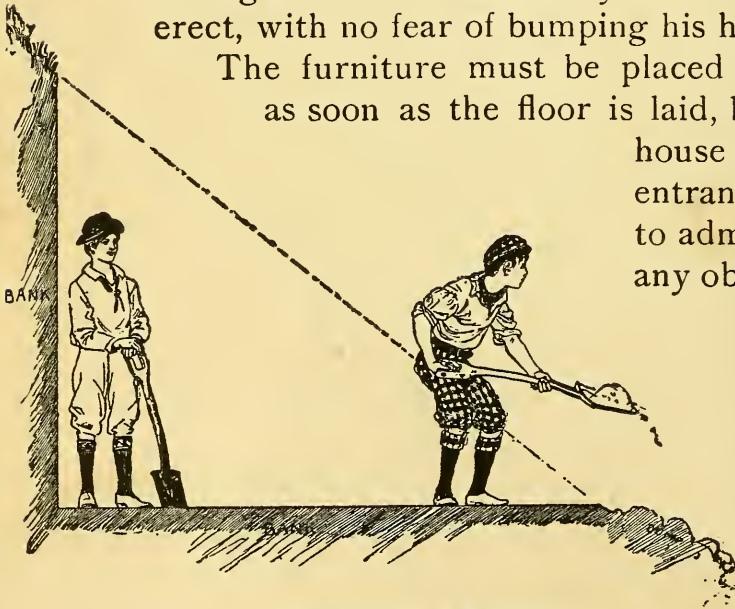

FIG. 76.—Cross-Section of Excavation.

hand at this, "for the fun of the thing," the work is soon done.



Bank Swallows at Work.



**A Cross-Section**

is a picture showing how half an object looks. Fig. 76 is a cross-section of the excavation shown in Fig. 76a. The latter shows the finished foundation.

In Fig. 79 a cross-section of the earth-bank and



FIG. 76a.—The Excavation.

**The Boys' Underground Club-House**

is given, affording an idea of the proper proportions of the cave. When the foundation is entirely finished, collect your building material.



If you have

### **New Lumber,**

use it ; if not, use old lumber, and if you are building in the woods the house may be built of logs and roofed with poles, covered with bark and boughs. The better the material the stronger will be the house. Secure some good sound planks and a supply of long strips two inches thick and four inches wide. Use two-by-fours for the frame of the house.

To give a

### **Pitch to the Roof,**

to allow the water which filters through the dirt above to drain off at the eaves, make the rear posts, A, B and C, D (Fig. 77), exactly equal in length, but considerably longer than E, F and G, H, as in Fig. 79.

To add strength, erect another post midway between A, B and C, D.

### **Framing.**

Cut the sticks A, C and B, D exactly equal in length and nail them to the uprights A, B and C, D, as in Fig. 77, using one nail at each corner ; this will adjust the frame and make the four corners square, after which you may secure them in position by diagonal pieces similar to those shown on the end, A, E, B, F, Fig. 77. The corners may then be nailed. In nailing a temporary piece it is only necessary to drive the nails far enough to hold for the time.

Next make the frame E, G, H, F, and in the middle of this frame nail on the two door-jambs I, J, and K, L. While some of the boys hold the front and rear frames in an upright position and the proper distance apart, others can nail on diagonals at the two ends, and, after all is square and plumb, the two string-pieces, A, E and C, G, may be se-



curely nailed in place, and the rafter M, O nailed to M, N and O, P. This finishes the framework proper, for the club-house.

**Passageway.**

To make the frame for the underground hall or passageway, first nail Q, S across the door-jambs, to form the top to the doorway, after which put in the supports Q, R and S, T. Next build the frame U, V, X, W, and join it to Q, S

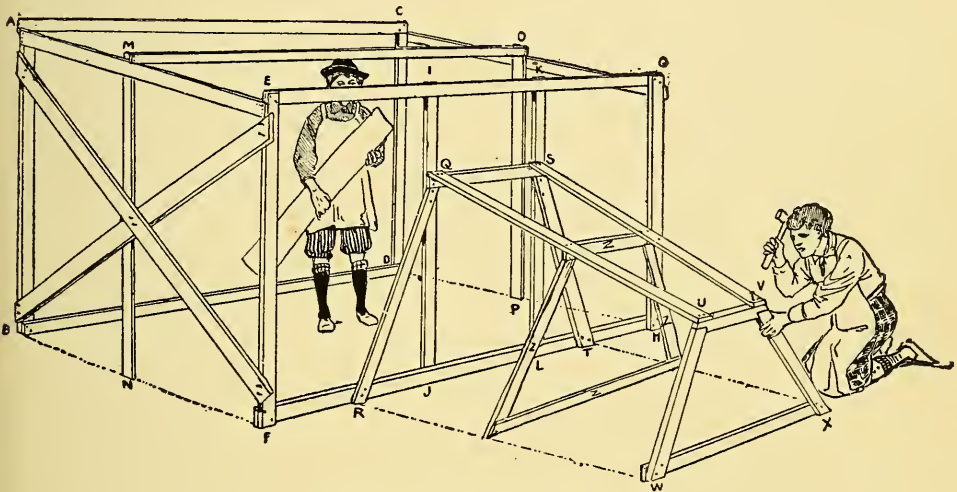

FIG. 77.—The Frame.

by the two pieces, Q, U and S, V, and put in the middle frame-support marked Z, Z, Z.

The passageway should be about six feet long, and the front doorway (U, V, X, W, Fig. 80) of just sufficient size to enable you to creep through with comfort. The bottom-piece, W, X, can be nailed to a couple of stakes driven in the ground for that purpose. The next thing in order is the floor, and to make this firm you must lay a number of two-by-fours, parallel to B, D and F, H and see that they are level. You will need a number of shorter

pieces of the same material, to run parallel to F, H and W, X for the hall floor, as may be seen in Fig. 79. Across these nail your floor securely, as shown in Fig. 79.

### **There Are No Windows**

to the underground house, and but two openings: one in the roof for the ventilator, and the doorway, Q, S, L, J, Fig. 77. Since the outside of the wall of this sort of a house is hidden by earth, it is not necessary to remove the diagonal braces upon the ends or sides, but the inside should be neatly finished, and the four sides must be boarded up from the inside, after which the side-walls to the passage-way may be nailed on from the outside, the boards running from the floor to the string-pieces, Q, U and S V, as shown in Fig. 79. When this is finished, roof the house, laying the boards parallel with A, E and C, G, and allowing them to project front and rear and overlap at the sides. Over each crack in the roof nail another plank, as shown in Fig. 79.

### **The Roof**

may be made without the overlapping boards and the cracks covered with strips of tar-paper or old oil-cloth, or the roof may be preserved and the cracks filled by treating the whole to a coating of hot tar, daubed on with a brush made from rags tied to the end of a stick. Any sort of roof which will keep out the rain will answer the purpose.

### **Gumtion.**

The plans given may be, and are expected to be, altered to suit requirements. If you use this roofing you must use substantial supports, in the way of rafters, and put them close together. In all cases, use your common-sense.

Don't put much earth on a frail roof ; it is only necessary to cover the boards with sufficient earth or sod to conceal the wood.

Make a long box, of four boards (Fig. 82), for

**A Ventilator,**

and set this over a square hole cut in the roof for this purpose. The ventilator should project at least one foot and a half above ground, and the top or vent be protected by wire-netting or cross-pieces, nailed on as shown in Fig. 82. Now spread small brush over the boards, and dry leaves or straw over the brush, then shovel the dirt back in the excavation until the club-house is entirely covered ; pack the soil firmly all around the house, leaving only the top of the ventilator and the front door uncovered.

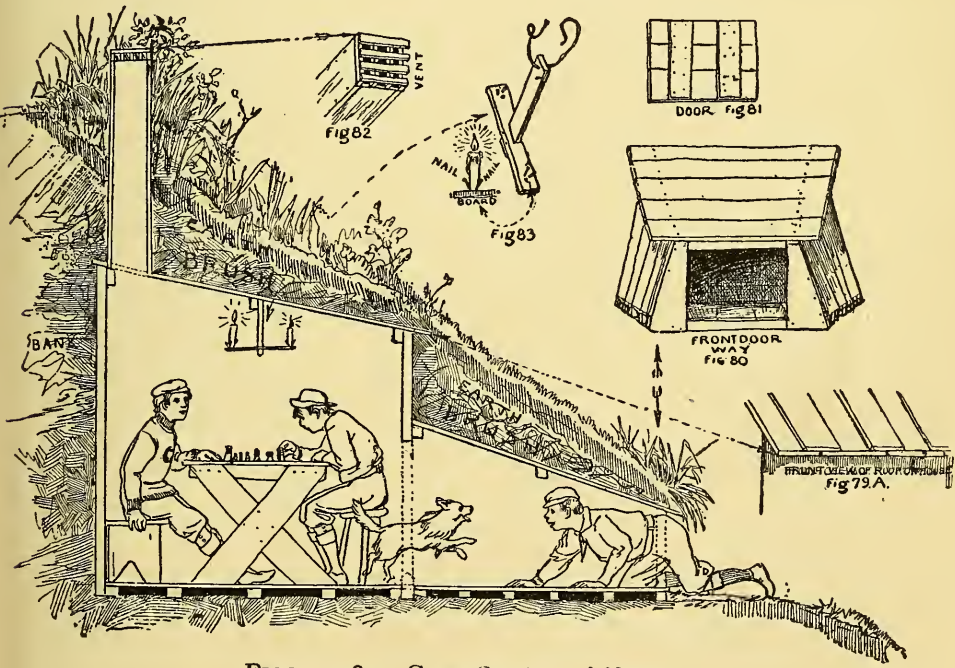

FIGS. 79-83.—Cross-Section of House.

When all is finished to your satisfaction, conceal the ventilator by brush or transplanted weeds or shrubs, and scatter grass and clover-seed over the new earth. Make a strong door, after the plan in Fig. 81, and fasten it on the front entrance with good hinges and a padlock, and place some brush or growing shrubs in front of the door.

### **After the Grass Begins to Grow**

there will be little to cause the passers-by to suspect that the green bank conceals a room well supplied with chess, checkers, boys' books, and everything to make a boy happy.

### **Dangerous Caves.**

There is an impulse implanted in all boys, which impels them to dig caves in every convenient bank, and these caves are always more or less dangerous from their liability to cave in upon the youthful miners. It not infrequently occurs that sad accidents do happen to youngsters, who, on account of lack of instruction, attempt to make underground retreats in some sandy bank, by boring a hole in the face of the hill. If, however, they make an excavation as here directed, and illustrated by Figs. 76 and 76a, their parents need feel no apprehension, for there is no more liability to accident than if they were digging in the home garden. Many of these houses have already been constructed.



## CHAPTER IX.

### A BOYS' CLUB-HOUSE ON THE WATER.

WE cannot all be Robinson Crusoes, and real desert islands are scarce, but with a little work we can build artificial islands, upon which Robinson Crusoe cabins of novel designs may be erected, and by forming

#### Crusoe-Clubs,

consisting of as many members as the island homes will accommodate, we shall have plenty of company. The President of such a club may be called "Robinson Crusoe"; the Secretary, "Man Friday"; the Treasurer, "The Goat," and the Captain, "The Parrot." In selecting a site for the club-house, choose a bar or shallow place in some small lake or pond.

Not only is the

#### Foundation of the Club-House Submerged,

but it must be built under water, and every foot of water adds to the difficulties. The following plans are made for foundations to be laid in water not much over waist-deep. For the convenience of the draughtsman, the bottom in the diagrams is supposed to be level.

#### The Building Material

necessary is such as the lumber-pile, the farm-yard, woodshed or forest will supply, and the necessary tools consist



of some mauls, a saw, auger, and hatchet. Make your own mauls, by sawing off the ends of hardwood posts and fitting handles in holes bored in the pieces of hardwood for that purpose. Fig. 84 shows a boy using a home-made maul.



FIG. 84.—Using a Home-made Maul.

which has previously had both its heads removed. If you have no barrels a box, similarly treated, will answer the purpose, and in case you have no boxes, cribs, made in the form of boxes open at the top and bottom, may be used. Should you be ambitious to build in

### **True Robinson Crusoe Style,**

drive a number of long stakes securely, in the form of a circle, in the bottom of the pond, as in Fig. 84, and then with grape-vines and other creepers weave a basket (Fig. 86). "Crusoe" should know how to

Should you be so fortunate as to be able to locate your house over

### **A Soft Bottom,**

make the corner piers by driving a number of stakes in a circle (Fig. 84), over which slip a barrel (Fig. 85)



FIG. 85.—Placing the Barrel.

do all these things. "The Parrot" should have charge of the transportation of material, and "The Goat" collect the lumber, cobblestones, stakes, and vines. All kinds of vines and creepers are good for basket-work, and almost any sort of stakes will answer, but "The Goat" must see that neither poison-sumac nor poison-ivy is used. Both of these plants must be avoided in any work of this kind, as they are extremely dangerous to comfort, and may cause an amount of irritation which will confine the victim to his bed for days.

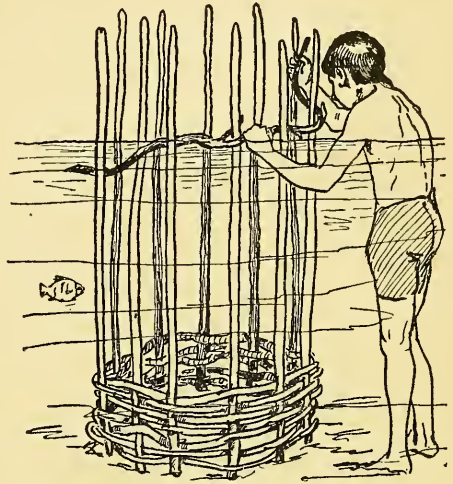

FIG. 86.—The Basket.

Where vines are scarce, almost any sort of green branches may be made to answer the purpose, willow being especially adapted for basket-work; but all the larger branches should be split in half to make them pliable enough to bend without breaking. You may now

### **Weave a Basket**

by passing the vine alternately inside and outside of the stakes in the circle (Fig. 86), and when the end of the first piece in hand is reached you must duck your head under water and push the vine to the bottom of the stakes. Beginning where the last piece ended, weave a second piece of vine and push it down to the bottom, and so on until the top of the water is reached. It is great fun to make these cribs, and not at all difficult work, and when they are done and filled with cobblestones they make fine piers for a club-house or an artificial island.

### The Foundation Posts

of the club-house should be four or five inches in diameter and sharpened at their lower ends, but even then you will probably find that the united strength of several boys is not sufficient to force them far enough into the bottom to

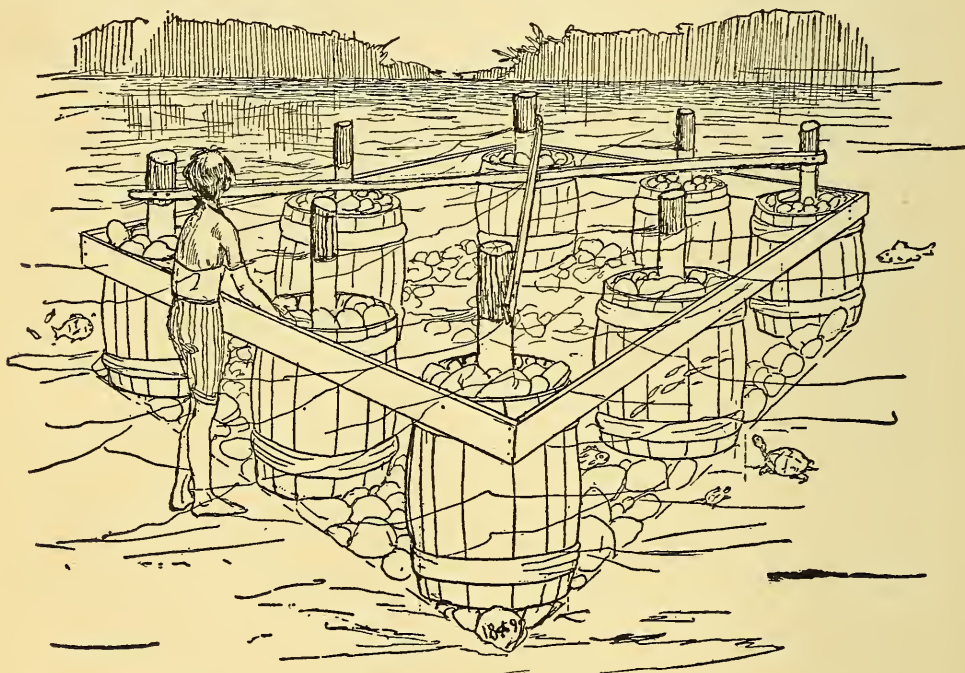

FIG. 87.—The Foundation.

prevent swaying. Drive your foundation posts in the middle of the basket-crib and then

### Fill the Crib with Stones.

When the cribs are full, as the barrels are in Fig. 87, they will form durable stone piers. Four such piers will support a house big enough for from two to four boys. In this case the foundation posts should be long enough to form the four corners of the house. To make the posts steady,



nail two diagonal binders on the posts, from corner to corner, crossing them in the centre (Fig. 87).

Let these diagonals be just above the water, and above these, and out of reach of waves, nail four

### More Binders,

in the form of a square, as A, B, C, D, in Fig. 88 are arranged. These form the support for the floor, and four

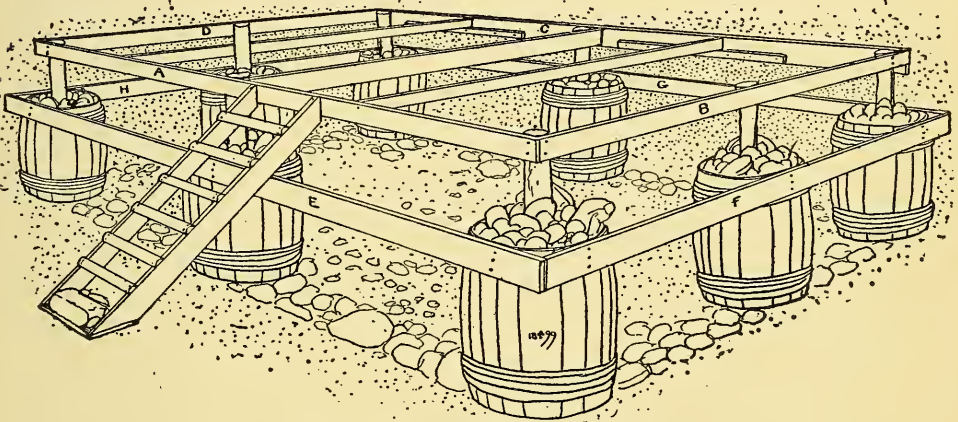

FIG. 88.—A Finished Foundation.

more at the top of the corner or foundation poles will make a support for the roof. The rest of the work is simple ; it is only necessary to lay a floor, put on a roof, and to board up the sides to have as snug a cabin as boys need want in summer-time. By using more piers you can make a foundation of any size.

When

### The Bottom of the Pond

is hard sand, or stones, the basket-cribs may be built on shore in the same manner as described, but in this case it is neither necessary nor advisable to drive the stakes far into



the earth. When finished the crib will hold together and may be removed from the land without dislocating the stakes, as the vines will hold them tightly in the structure.

You cannot possibly force your corner posts into the soil through hard sand or stones, and you must, therefore, be content to rest their lower ends upon the bottom, in which case make a stand for them by spiking two short boards, in the form of a cross, on the lower end of the posts, then slip your cribs over the posts (Fig. 89). While two boys hold the post and crib in place the others can fill the crib with cobble-stones, which will steady the post until it is made entirely secure by diagonal braces and the four binders, A, B, C, D. No

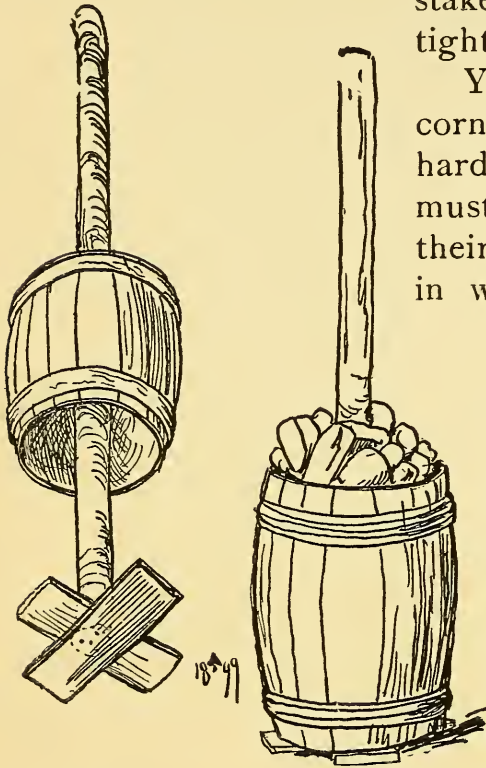

FIG. 89.—Barrel Cribs.

matter how uneven the ends of the posts may be at first, the top of the binders, A, B, C, D, must be exactly level.

The water, when calm, is

### **Always Level,**

and if you measure three feet from its surface, and mark the point on each post, you can make the binders exactly level by nailing them with their top edge exactly even with the three-foot mark on the corner posts. The posts may now be sawed off even with the binders (Fig. 88) and the floor laid

**In a Large Building,**

four extra binders nailed to the top of the crib (E, F, G, H, Fig. 88), will give finish to the structure, especially if they are floored over to the edge of the top floor, thus making a step at the surface or under the water. Stairs may be built, as shown in Fig. 88. On hard bottoms they are anchored at the lower end by a large stone placed upon a board, which joins the lower ends of the side-boards; but on soft bottoms the stairs may be first nailed to two stakes, which are afterward driven into the mud. Fig. 90 shows the platform finished, and skeleton house erected. To build this house place the two two-inch by four-inch strips, J, N and M, Q, on the platform at the required distance apart, and "toe-nail" them in place—driving the nails slanting from the sides into the floor (Fig. 92).

**Temporary diagonal Braces**

may be used until you have your skeleton house far enough advanced to fit in some horizontal cross-pieces between the uprights, and to "toe-nail" them in place. Put in two sets of braces on each side, one above and one below the window openings, and in the front frame, J, K, L, M, one over the pro-

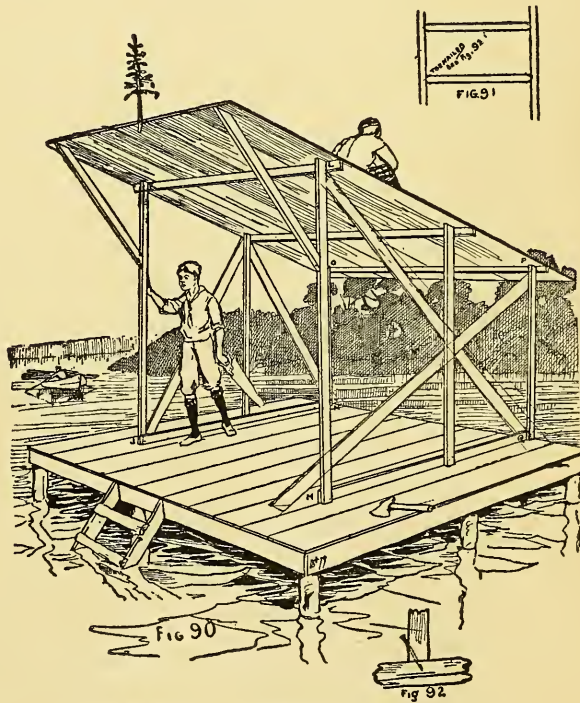

FIGS. 90-92.—Frame of House.

posed doorway, and two more in the rear frame, N, O, P, Q, the latter extending from the upright, N, O, to the upright P, Q, and parallel to N, Q, as explained by Fig. 91. When these braces are in place your frame will be stiff enough to nail on the sidings of slabs, boards or poles, and after they are in position the roof may be put on with no fear of the structure's falling. The roof may be made of boards, as described in the underground club-house.

### **An Artificial Island**

can be made, by erecting the corner cribs and bracing them, as described for the club-house, and then packing brush, loaded with stones, between the boundaries of the foundation.

Lay the brush with the stems pointing one way and place stones on top, one layer of weighted brush over another, until you have reached a level two feet above the water. Cover the top brush with hay, straw, or old leaves, and place a layer of sods over the leaves.

Upon this foundation you can place as much earth as your industry will permit, and you will have a substantial little island, upon which grass or plants will grow, and beneath which the little fishes can live amid the submerged brush.





Moving in for the Summer.



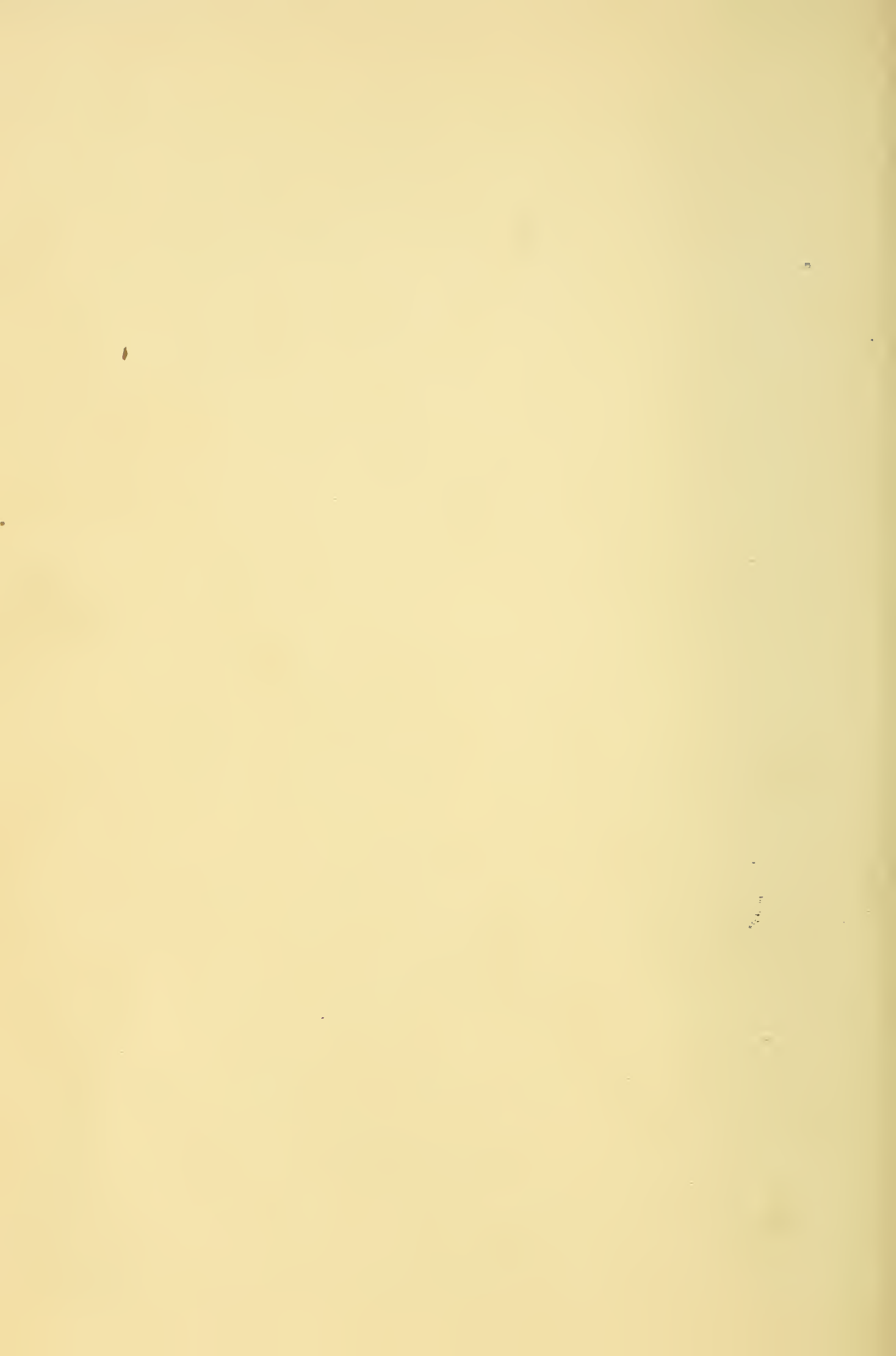

## CHAPTER X.

### HOW TO HAVE FUN AT A PICNIC.

IF feasible take hammocks and ropes for swings along with you and don't forget a

#### "Joggling-Board."

This is a very popular invention, from South Carolina, and consists of a pine or hemlock plank, one inch thick, one

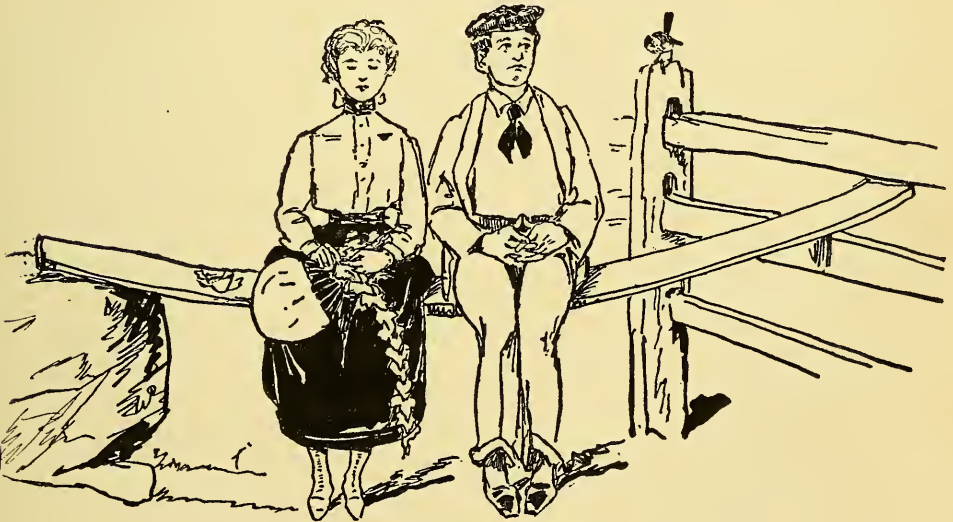

The Joggling Board.

foot wide and ten feet long, which, when supported at each end by solid supports, or ropes from the limb of a tree, forms

a seat which responds to every movement of the person sitting in the centre, with a gentle, delightful joggle.

If you use a wagon, stage, or omnibus, to reach the picnic ground, start a game of

### **Turnpike Loo.**

First divide your party into two sides, the lefts and the rights, including the driver. Each side names and counts all animals passed upon their respective sides—a dog, cat, sheep, pig, cow, horse, or domestic fowl, each counts one; a man, woman or child, five; an animal with a bell, fifteen; an animal looking out of a barn or stable window, twenty; and a dog, cat, or baby in a farm-house window counts fifty; the game is two hundred.

### **The Driver**

will endeavor to pass all animals upon his side; but the leader of the left will get out at times and thwart the driver, by chasing and coaxing the creatures to his side. The game is exciting, producing much mirth for the picnickers and amazement among the farmers and live-stock.

A great improvement upon the old-fashioned hamper of heavy dishes is the

### **Modern Pasteboard Box,**

cheap wooden pie-plates, and paper napkins. Wrap your sandwiches in a damp linen napkin and with an outside wrapper of confectioners' paraffine paper and pack them, and everything else you can, in pasteboard boxes. Salads and similar foods may be carried in wide-mouthed glass jars; mayonnaise dressing, sliced cucumbers and tomatoes in the same manner.

### **Pack the Ground Coffee,**

with an egg rolled in paper, in the coffee-pot. Make the egg into a bundle large enough to fit on top the coffee, with no room to roll or jolt about. The butter or other grease, left after the feast, may be melted and poured into the small paper or wooden boxes; a wick of twisted paper or rag, thoroughly soaked with the grease, will make a lamp. Name the lamps, set them afloat, and the light which goes out last is supposed to be your truest admirer.

### **The Rhode Island Clam-Bake,**

the Pennsylvania Pond-Stew, the Virginia Soup, and the Kentucky Burgoo, are about the jolliest forms of picnics known in this country.

Resting in the laps of the high hills and mountains of Pennsylvania are many small lakes. Here the picnickers spend the forenoon capturing what edible aquatic creatures their skill can procure, all of which are put into the stew-pan along with vegetables, thus making a sort of fresh-water chowder of the most appetizing nature.

### **Burgoo.**

In Virginia and Kentucky it was an old-time custom for the gentlemen to spend the forenoon hunting and fishing, and the slaves in the afternoon cooked the game and fish in great iron pots, hung over blazing wood fires, thus making a most savory dish for the ladies who joined the party toward evening. This is the origin of the Virginia Soup and the Kentucky Burgoo.

The latter is the most famous, and has been enjoyed by



all great Kentuckians, from Marshall, Clay, and Lincoln, to the present day.

Since the practical extermination of game, domestic fowls are used as a substitute for wild birds. When you have a Burgoo ask a certain number of guests to each bring a raw



The Burgoo.

dressed chicken, duck, or goose, and others to bring vegetables, peeled and ready for the pot. The head cook, or Burgoo-Master, brings herbs, salt, freshly ground black pepper, salt pork, olives, and lemons.

As a substitute for the old-fashioned, cumbersome iron kettle, take a large, pail-shaped

### **Clothes-boiler,**

bought new for the occasion. Build your fire between two green logs, and use the logs to support the boiler over the flames. Half fill the boiler with water and pour in all the vegetables and meats, and allow them to boil slowly until the bones settle to the bottom and the other ingredients are reduced to a pulp.

### **It Takes Time to Properly Cook a Burgoo,**

and the contents of the pot must be constantly stirred, especially when nearly cooked, in order to prevent the vegetables and meat from burning and imparting a scorched flavor to the soup.

The stirring is done with long-handled paddles, crudely whittled by the men. The young people who take turns in stirring, walk around the steaming caldron to the time of vocal music, and should any maid, by accident or design, click her paddle against one in the hands of a young man, the young man may claim a penalty.

### **When the Soup is Cooked**

it is seasoned to taste, and must be served hot. The olives are extracted from the olive jar, and one olive placed in each cup, with a slice of lemon. The olive liquid remaining in the jar is poured into the hot soup and then the soup is ladled out and poured over the lemon and olive in each cup. If the Burgoo-Master has attended strictly to his work the picnickers will find it one of the most delicious soups which they have ever tasted.

The preparation of the Burgoo does not employ all hands of a large party all the time, and the idle ones may amuse themselves with

### A Game of Jack-Fagots.

An armful of fagots is held a foot from the ground and allowed to fall, and then the first player, with a crooked stick, hooks out as many fagots as possible, without disturbing the remainder. The slightest movement of a fagot, not hooked, ends the turn, and, after counting the score, the fagots are bunched and allowed to fall for the next player. The sticks successfully removed by each player constitute the individual scores.



Jack Fagots.

In the afternoon all must join in some games—little folks, old folks, and young folks. Choose some of the games children play, such as

### Old Dan Tucker.

By lot, or by old-fashioned counting out verses, let chance decide who is to be "It," or Tucker, and let all the other males, big and little, select partners as they would for a dance, and form a ring around Tucker. At

a signal from "It" each player must face his partner and sing

"Hipperty-Hop, Hipperty-Hop!  
Joyfully now we sing,  
As we hop to the right and hop to the left,  
Around Dan Tucker's ring!"

Keeping time with the music the players go, with a hipperty-hop step, to the right of the first and to the left of the second, weaving in and out until the partners meet; then right-about-face and back again in the same manner to their places. Next all join hands and

### **Circle Around Tucker, Singing**

"Go round and round old Tucker,  
Go round and round old Tucker,  
Go round and round old Tucker,  
As we have gone before!"

When the couples are again back in their places the song is changed, and suiting the action to

### **The Words, They Sing**

"I put my right hand in,  
I put my left hand out,  
I give my right hand a shake, shake, shake,  
And turn myself about!"

Using the same verse the girls now sing, "I put my pretty face in," etc. Then their partners sing, "I put my 'ugly mug' in," etc. Then all sing "I put my right foot in," etc., and after the last shake of the right foot all again join hands and advancing and



**Crowding on Tucker**

from all sides, and back again to places, they sing

“ Go in and out the window,  
Go in and out the window,  
Go in and out the window,  
As we have done before.”

Changing the refrain, they next sing

**“Go Stand and Face Your Partner,”**

repeating three times, and ending with “as we have done before.” At the last word they face their partners and give them their right hand, their left hand to the next, and, giving hands right and left, sing “Hipperty-Hop Hipperty-Hop,” ending this time with

**“Now Let Old Tucker Join Us.”**

As soon as Tucker has secured the partner he wants he shouts

“ Get out of the way for old Dan Tucker,  
You're too late to get your supper,”

and the boy or man left without a partner is “It” for the next game. The tunes for the verses can be obtained from the children. This is all taken from children's games.

**Pitch-peg-pin Pitching**

is a great game for hilarious fun. The pegs are sticks, two feet long, sharpened at one end, and nine in number. Put the pointed ends in the ground, forming a diamond, with

each peg two feet from its nearest neighbor, and the one at one apex about twenty feet from a taw-line.

### **Let All the Girls,**

big, little, married, and unmarried, form one side, and an equal number of boys, old and young, form the other side. The boys then choose a First Lady, who is to lead their opponents, and the girls choose a First Gentleman, who is to command the men. With three short clubs in her hands the First Lady toes the taw-line and endeavors to knock all the pegs down, in three consecutive throws with the clubs.

The pegs are then reset, the score recorded, and

### **The First Gentleman Takes**

the clubs and his turn. When all have had a turn the individual scores are compared, and the right arm of each man or boy is bound with a pocket-handkerchief to the left arm of the girl, woman or matron whose score most nearly approaches his own, and the First Lady and First Gentleman choose up for sides, taking a couple at each choice. In the order of their score number, the couples now take their turn pitching clubs at the pins, the man, of necessity, using his left hand and the woman her right to throw the clubs, which they do simultaneously.

### **The Scores**

are again compared and the couples bound into fours, and the fours into sixes, until each side is bound into a continuous line, with only the left hand of the end man and the right

hand of the end woman to pitch-peg-pin with, and make the final score of the game.

### **Lawn Hab-enihan.**

Mark with a whitewash brush upon the grass, scratch with a stick upon the bare ground or hard sand of a shore, twelve concentric circles. Number the rings from the outside to the centre.

Supply each player with a dozen smooth stones, about the size of the palm of one's hand. If you can get flat, water-washed stones, with rounded edges, they make the best "Habs." Standing upon the taw-line at the distance from the target agreed upon, each player in turn pitches a hab at the target, or "Enihan," leaving a stone inside the circle struck. But if his hab rests upon a line which bounds the rings he loses his turn after the first shot. The player may remove a hab from the circle last struck, or set another hab in it, or, counting from where any one of his habs rests, can move that hab as many circles toward the centre as corresponds with the number of the circle last struck.

If this moves the hab to the centre and leaves some figures over he can place a new hab forward as many rings as correspond with the numbers left over. If any player can cast two habs into a circle occupied by some other player's hab, the successful player captures the other hab and removes it. The game consists of any specified number of points, and when any one of the players has no habs on the enihan the game is ended. Then each player counts the number of his habs in the centre and the number of captured habs, and whoever has the most adds to his or her individual score the number of habs left on the enihan. The players have three objects constantly in view: to protect his or

---

her habs from capture by getting more than one in the same circle, to work to the centre, and to capture the opponent's habs. This is an exciting outdoor game, which may be played with the material at hand, and when two players have each a hab in the same circle, and each hab is moving nearer and nearer the centre, the danger of a lucky shot and capture keeps them "guessing."



## CHAPTER XI.

### HOW TO BUILD AND HOW TO FURNISH A DANIEL BOONE CABIN.

IMAGINATION is a great thing and can do wonders ; it can surround the most commonplace objects with an atmosphere of romance, in which nothing is impossible or improbable. A whiff of smoke from the fireplace where wood is burning, means nothing but a faulty chimney ; yet, as the smell of burning wood reaches the nostrils, Association sets the wheels of

#### Imagination's Mill

whirring, and all unbidden come visions floating through our minds of camps, camp-fires, fish—pickerel, bass, and trout ; quail, rabbits, and venison-steaks, broiling over the hot coals. My, it makes a fellow hungry to think of such good things ! Roasted ears of sweet-corn, flapjacks, and corn-dodgers, “ piping hot,” pass in a procession before us, and, as the sparks fly up the chimney,

#### The Ghosts of the Fireplace

troop in: and a hale and husky lot of ghosts they are, with their coon-skin caps, buckskin clothes, and beaded moccasins. Each ghost wears a strap slung over his shoulder, from which hang a bullet-pouch and a curiously engraved cow-horn powder-flask ; as they file by, with their long

single-barrelled flint-lock rifles, we are not surprised to see among them the great Daniel Boone, his friend Simon Kenton, and the unique, dashing, Davy Crockett.

All in vain do the trucks thunder by our windows, and futile are the efforts of the clanging cable-car bells and the roar of the great city to recall us to the present humdrum



Home of Young Pioneers.

times. We are under the spell of the king of magicians, and our minds are wandering free in the wild woods; we can even hear the distant wolves howl, and the blood curdling yell of the painted savage. Is it a wonder that we love the generous old-fashioned fireplace? Is it strange that the log-cabin is dear to the hearts of American boys?

### **The Log-House**

saw the birth of our nation ; its rude interior sheltered our great men, and beneath its slabbed roof heroes were born. To-day it is still the most practicable, durable, and simply constructed house invented for a forest home, and any boy can build a log-house large enough to form a comfortable camp for vacation days. For muscles unaccustomed to such exercise it is hard work to cut down large trees, and, unless the young woodsman has served an apprenticeship on a farm or in a lumber-camp, it is dangerous work to fell big timber ; but any lad may cut down

### **Trees of a Smaller Growth,**

without danger to life or limb. Small-sized logs save much labor in chopping, sawing, rolling, and "snaking" to camp ; besides all this, logs of small diameter look best for a house of small dimensions.

Therefore, in selecting the material for your proposed house, choose only such trees as are best suited to the strength of the builders. There is no rule which fixes the diameter of a log or pole, so a log-house is a log-house, no matter whether the diameter of the log from which it is built be four inches or four feet. When a log is hauled by men, horses, or oxen, through the woods, it is called "snaking."

### **The "Skid "**

is two or more logs laid on the ground, upon and across which the other logs are piled up for use. Common-sense will direct you to select only the timber which comes nearest being straight, and also to cut the logs considerably longer than the length marked on the plan.

Fig. 93 shows the plan of a simple cabin, 6 feet wide by 10 feet long, inside measurement.

Fig. 95 is a rough sketch and plan of two such cabins under one roof, with a hallway, or "gallery," as they call it in the South, between them. Fig. 96 is a plan of the saddlebag. In this sketch you will see how your house may be

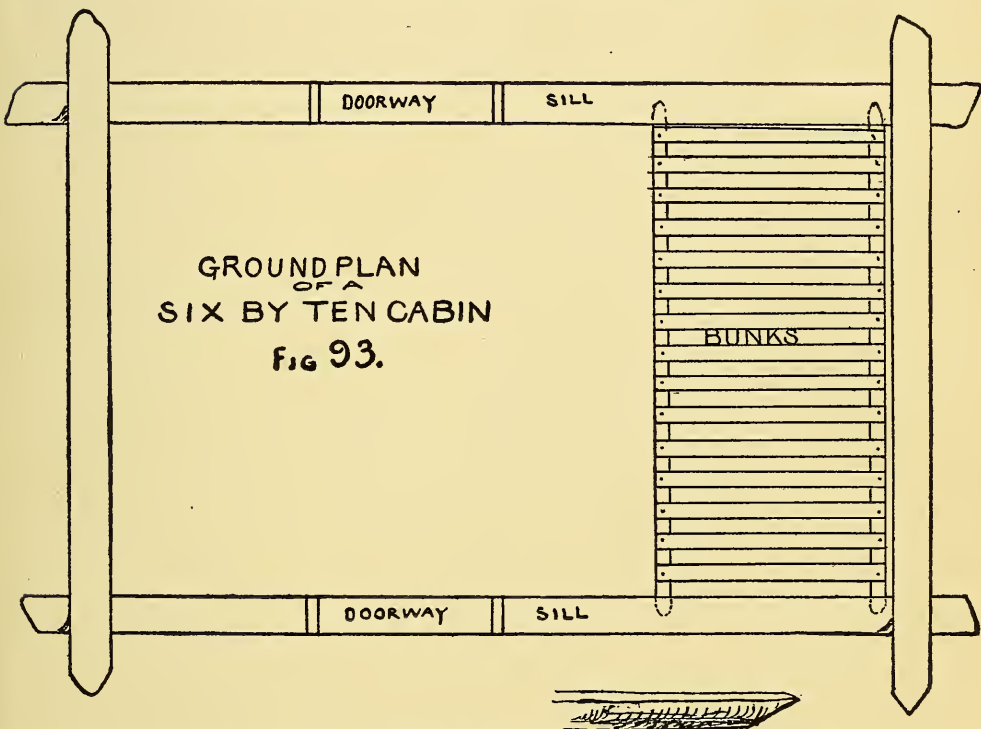

FIGS. 93 and 94.

enlarged, at any time, by the addition of a duplicate house, with a roofed space between the two.

First decide upon the exact spot where you intend to

### Locate Your Cabin,

then stake out the cabin according to your plans, and clear the ground for the house.



To facilitate rolling the logs as you need them, arrange some skids close by the site of the house, and allow them to slant toward the proposed cabin.

If there are any stones handy,

### Build a Foundation

by making a pile of stones a foot or two high, at each of the four corners, in such a manner that the logs resting on these supports will be at the same level at each end, level with each other, and exactly six feet apart.

### For Floor-Joists

take a number of strong poles, and, with a sharp hatchet, give them a flat side for the floor-boards to rest upon, and trim off each end, wedge-shaped, as shown by Fig. 94, the rough sketch at the bottom right-hand corner of Fig. 93.

You understand, of course, that

### The Floor-Supports

must be of sufficient length to reach from the front sill-log to the back sill-log. Nail each joist at each end to the sill-

logs, and place them about two feet apart. If it is thought that the flooring of the cabin makes too much work, you may build one with a "mud-sill," by using the hard earth for floor and foundation. Abraham Lincoln

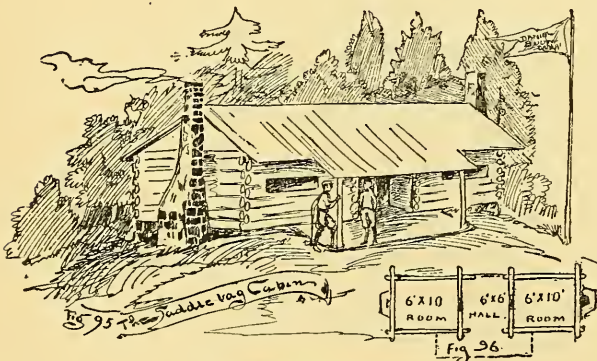

FIGS. 95 and 96.

lived in a "mud-sill" house, and there are hundreds of such houses in the Southern States.

With the exception of the sill-logs, all the logs are notched at both ends and on both sides (Figs. 97 and 98); the sill-logs are notched at both ends, but only on one side, as shown by Fig. 98. Logs of the same diameter as the sill-logs can be laid between them on the bare ground and used for joists, but the best plan is a stone foundation, and a plank floor at least a foot or two above the earth.

### **Log-Rolling.**

Now is the time to invite all your friends to a grand old-time log-rolling; ask the girls to come and cook the coffee and make the sandwiches.

The two end-logs may first be rolled down from the skids, notched and fitted in place across the ends of sill-logs (Fig. 93), and then the next two side-logs, and so on, alternating until the walls are built; but you must remember to allow for the doors, windows, and fireplace openings. When the walls are so high that it is a difficult task to lift the logs in position, put up a couple of skids and roll the logs up the incline, which is better than wasting your strength in trying to lift such burdens. When the walls have reached the height of the top of the lowest opening, nail some

### **Door and Window Opening**

planks, temporarily, close to the proposed opening on both sides of it, and on the inside and outside of the house; this is to hold the logs in position while the opening is being cut. A, in Fig. 99, shows a binder. After the binders are in place, saw the top log through at the proposed opening,

to allow room for the saw, and then proceed to build as before. See Fig. 98, showing opening over door and window; the binders are not shown in this diagram.

### A Fireplace

is by no means an absolute necessity for a summer cabin, but an open fire is a great addition to a house, and upon cool evenings, even in the summer-time, its genial warmth

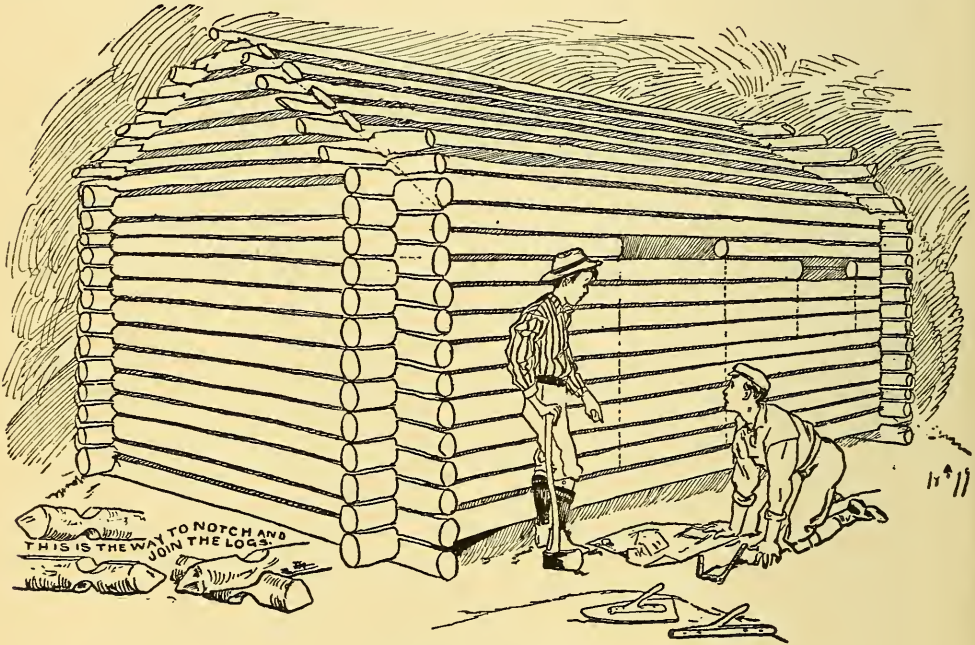

FIGS. 97 and 98.

is not to be despised. The protruding ends of the logs, at the four corners of the cabin, may be left as they happen to be until the house is finished, no matter how irregular their appearance. With a two-handed saw, and a boy at each end, the ends may be cut off evenly; this will give a finished appearance to the cabin. You can have

### **Any Sort of a Roof**

which suits your fancy ; it may be framed, as described in Chapter VII., or, by using round poles, it may be framed as shown by Fig. 98 and roofed with slabs or planks, as shown by Fig. 100, or the roof may be shingled with "clapboards," a name used for shingles or boards, about three feet long, and laid on as ordinary shingles are—first course at the eaves, second course breaking joints and overlapping the first, and so on, until the roof-tree is reached.

If shingles, clapboards, and planks are out of reach, the roof may be shingled with bark; if birch bark is used, it can be held in place by poles laid upon the outside of the roof, as I have often seen the hand-rived clapboards held in place where they use no nails in the construction of their homes.

### **The Most Essential Piece of Furniture**

for the house, if you are to live in it, is the bed or bunk. This can be made in various simple and effective patterns. At the Sportsmen's Show in New York there was an elaborately constructed bedstead, made of the rough branches of trees, but however ornamental this style of couch may be, it is not essential to comfort, and requires time and skill to manufacture, neither of which the average boy is willing to lavish on camp furniture.

### **The Bunks**

shown in the plan (Fig. 93), are made with two horizontal poles, flattened at the ends and upon one side, after the manner of the rough sketch at the Fig. 94. These poles extend from side to side of the cabin, and rest upon the logs of the wall, to which they are securely nailed. The ends



are further supported by a cross-plank, or pole, fastened to the walls, as a support for the side-rods of the bunk.

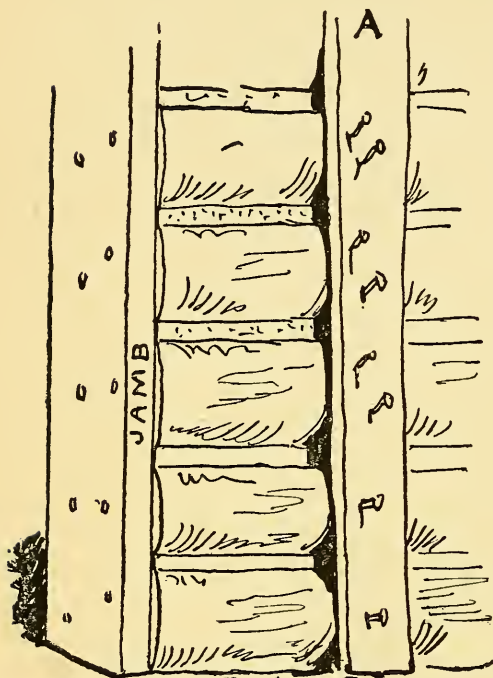

FIG. 99.—Binder and Jamb for Opening.

Slats are made of sticks split in half and nailed to the side-bars, as shown in the plan. One bunk is placed over another, until there is no room for more, and then the three or more bunks are filled with straw, hay, or spruce boughs, over which the blankets are spread, and the bed is made.

With a mud-sill house you can

### **Make a Lincoln Bed.**

Abraham Lincoln's father had no bedstead, and no means of getting one but to make it, and no tools but an auger and axe to make it with. A

stake was driven in the ground, near the corner of the cabin, about four feet from one of the walls, and six feet from the other. Auger-holes were then bored in the wall opposite, and poles driven into them, the other ends meeting on the stake; across these were laid laths rived from an oak, and upon them rested the straw-bed of our great President.

### **When Your House is Crowded,**

the floor offers space for sleepers, and you may "choose up," for first choice. As a rule the top berth is first choice, as in it you feel less cramped for breathing-space, for there

is nothing but the roof above you. Unless the boys are more than usually expert builders, there will be no lack of fresh air, even when your house is crowded. To prevent too much wind entering, it is well to

### **Stuff all the Spaces Between the Logs**

with mud or clay, mixed with moss, and while some of the boys are in the woods gathering the moss, and others mixing and dampening the clay, the more skilled mechanics can

### **Make the Door**

and hang it in the doorway, which, with the other proposed openings, may be now sawed out and heavy jambs nailed on, before the binders are removed. The wooden hinge of the door can be made of ash, hickory, or oak, and may be simply a straight stick or rod about six and a half feet long and two inches in diameter (Fig. 105). Bore a hole in the upper log over the doorway, about six inches deep; if the log is of less diameter than this, bore the hole through the log. Bore a hole in the lower, or sill-log, but make it only deep enough to securely hold one end of your hinge-rod, and then trim the rod to fit in this hole, making it a trifle shorter than the distance between the end of the top hole and the end of the sill hole. Flatten one side of the hinge-rod, so that it may fit neatly along the edge of the door, but do not fasten it on the door until after the rod is in place. Spring the rod in place by slipping the top end into the top hole as far as it will go, and then pushing the bottom end over the sill hole. When it slips in place set the door up, in the position it would be when wide open, and fasten it to the flattened edge of the hinge-rod, with good strong screws. Close the door and mark the edge on the jamb, then nail a narrow strip of wood along the line, to

prevent the door swinging any farther than it is necessary for it to swing when closed ; or make it as shown by Fig. 105, and hang it with iron hinges, as doors at home are hung.

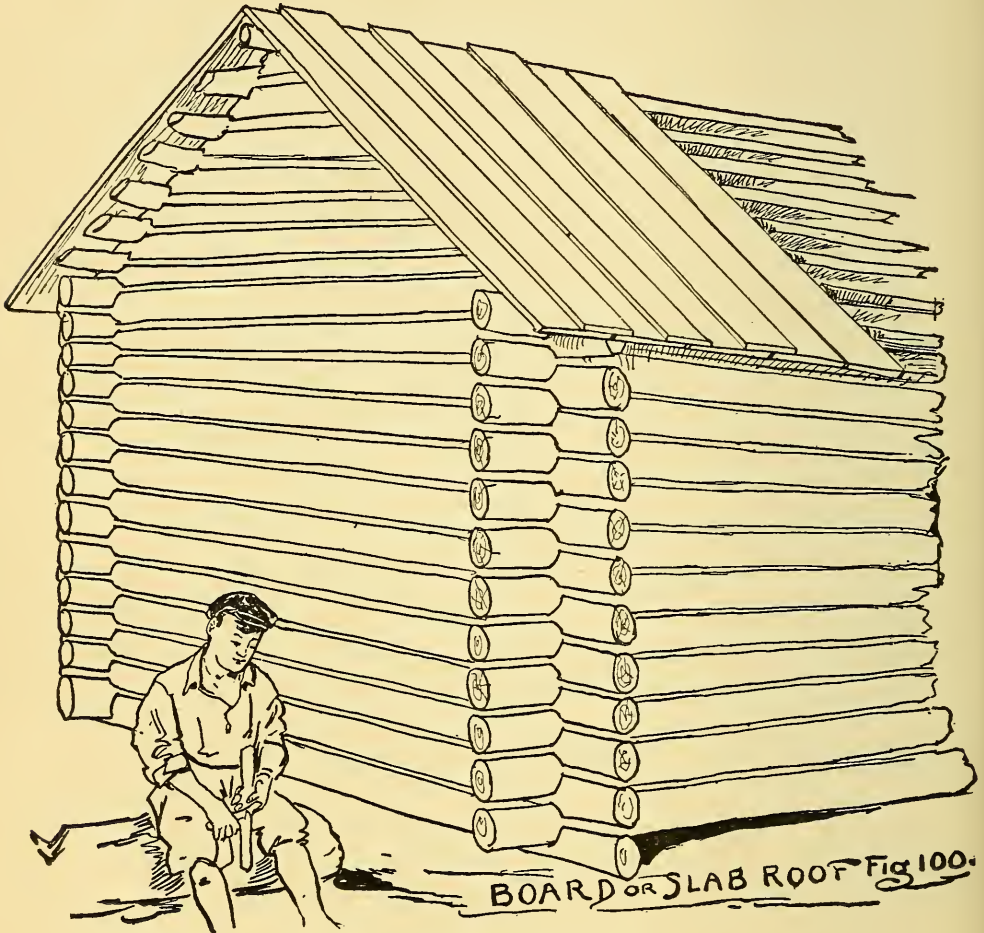

FIG. 100.—Board or Slab Roof.

### **If You Have Money to Spend,**

and men to work under your directions, you can have the regulation door, floor, and roof ; the cracks in the wall calked with mortar, and a stone or brick chimney and fire-place built. In fact, you can make a palace of logs, with

plate-glass windows, but *you will not have a log-cabin, and you will miss all the fun to be derived from creating something by your own labor*, which is the highest sort of joy—the joy of the artist! Any “chump,” with money, can hire men to build houses which would be impossible for his stupid brain and clumsy hands to accomplish. Besides which, the men he hired to do the work would be the only ones who derived any real pleasure from the construction of the houses.

You must not understand from this that you are to use

### **Oiled Paper for Glass, in Your Windows,**

if you can obtain real glass, but that in case you cannot, the paper makes a good substitute, and one which was used in many a pioneer's cabin. In Virginia there are log-houses, still occupied, which have not even a paper window—a hole, closed in bad weather by a wooden shutter, being the only opening besides the doors, and the moonshiners of the mountain districts seldom have windows at all, but depend upon a front and rear door to supply light for the house, and when these doors are closed the fire supplies the illumination.

### **The Lamps**

they use, when they have any, are small pans or saucers filled with melted fat, in which a piece of rag is placed, and furnishes a wick for this primitive light. In 1897 I was given one of these “Betty lights” by a mountain host, to light me to bed.

Every boy's log-house should be supplied with lanterns and candles, but the candles must be stored in tin boxes, otherwise

### **The Brownies Will Eat Them.**

Brownies are the wild wood-mice and flying-squirrels which will use your house during your absence, and not only



eat the 'candles, but anything else you may leave unprotected. They ate up my soap, and then, for dessert, went to the kitchen and ate up the stove-polish. In small houses you will probably not have stove-polish, or stoves.

After the opening in the wall of the cabin for the fireplace is sawed out, you may build up a good, strong wall, on the three outer sides of

### **The Fireplace**

(Figs. 106 and 107). Build these walls as you did the cabin walls, and fit the ends of the logs neatly against the cabin logs, and put "chunks" in between the logs at the cabin end, to level them. When the walls are as high as the opening in the cabin, you are ready to begin the work of building the inside clay-lining.

It will take a considerable quantity of clay to finish your fireplace and chimney, and a rough box, like the mortar-box used by builders, will be found most convenient for mixing the clay.

Saw off the ends of some sticks of wood and make some

### **Wooden Hammers, or Mauls,**

of them, by boring holes through the pieces you have sawed off and putting handles in the holes. These mauls may vary from three to five inches in diameter, and will be found to be the most convenient sort of tool for breaking the dry clay before it is dampened, and they will also be of great service in beating the clay down, for the fireplace and hearth. Make the floor to the fireplace and the hearth by spreading the damp clay over the space and hammering it down until it is hard; add more clay, and beat it until the hearth and fire-floor (Figs. 107 and 108) are level and firm. You may then put on enough water to make the surface slippery, and

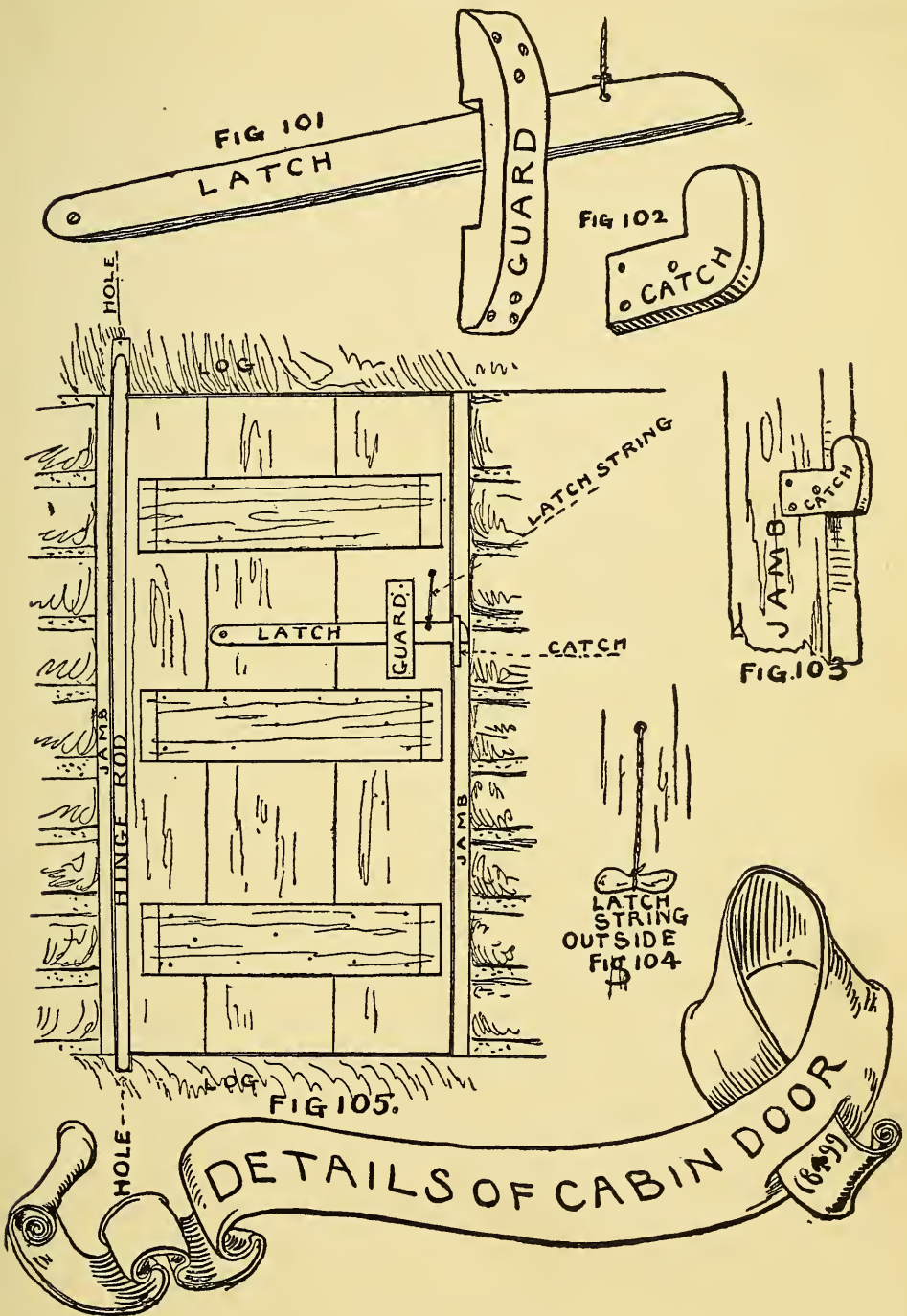

FIGS. 101-105.

smooth it off with a trowel made of a shingle and a branch, after the manner of the one shown in the foreground of Fig. 98.

### Next Build Your Clay Walls

on the inside, against the log outside walls, and extending to the inside of the cabin wall. Make the clay into the form of bricks and build up the jambs and lining, about one foot thick, to the top of the fireplace, using wet clay for mortar.

### For the Chimney

split some sticks and make them about one inch wide by one and one-half inch thick, and with clay for mortar build the

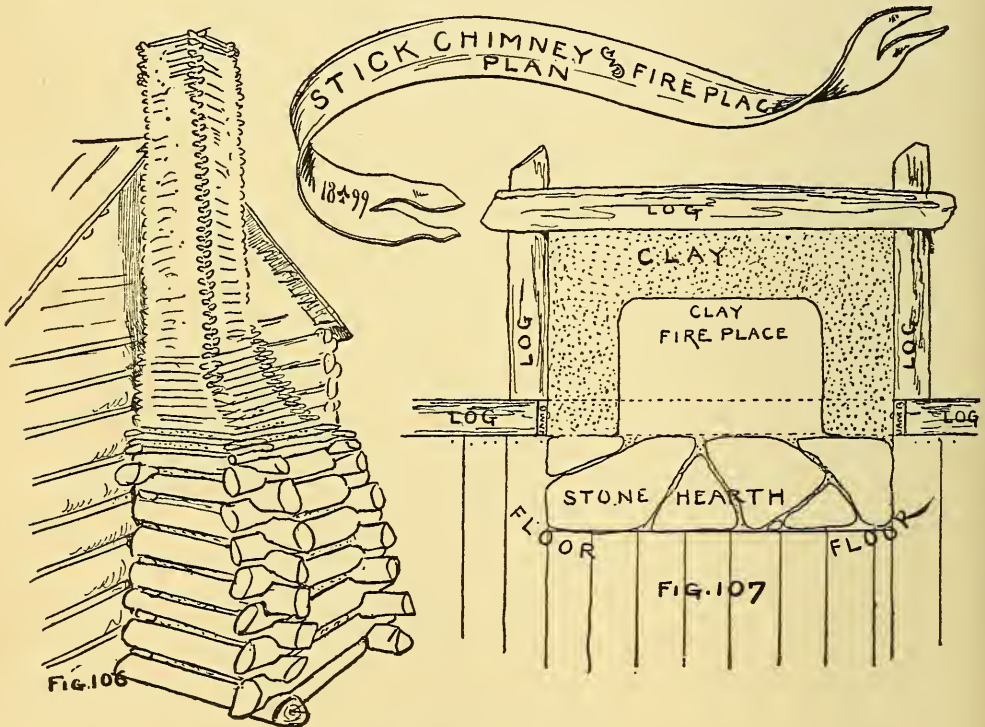

FIGS. 106 and 107.

chimney, log-cabin style (Fig. 106), to the required height, leaving a space between the chimney and outside wall of the

house. Plaster it well with clay, especially upon the inside, and be careful to keep it plumb.

A short time ago, while on a sketching trip through the mountains of East Tennessee and Kentucky, I saw hundreds of these

### **Stick Chimneys**

which have done service for years. Some of them were beautiful specimens of skill, while others had a decided list to port or starboard, as a sailor would say, and were apparently carelessly made.

In the mountains the fireplaces are lined with stones, in place of clay, but in Illinois, where stones are scarce and mud plenty, the old-time log-cabin hearth and fireplace were always made of clay.

Besides the berths or bunks already described, a table and some benches, or three-legged stools, will be found very useful articles of furniture. In a small house a

### **Table Takes Up Needed Room,**

and as it is principally used at meal-time, a contrivance that may be put away when not in use is most desirable; such a table can be made of two wooden horses, with boards laid across them. When the weather is fair the table may be set out-doors, and when the weather is foul it can be placed in-doors. The horses and boards may be kept on the porch, if you have one, or in a shed or on the rafters overhead.

### **Three-Legged Stools.**

A piece of two-inch plank, with three oak, ash, or hickory sticks driven into three holes bored for the purpose, makes a stool which will last a lifetime. Two such stools



have been in use for twelve or thirteen years in my Pike County (Pa.) cabin, and are just as good as new to-day.

Now, when your work is done and you balance yourself on a three-legged stool, and rest from your labors, remember you are sitting on what has before now proved to be the incipient Presidential chair.

### **General Camp Notes for Old Boys.**

If the boys suppose that their parents are not interested in out-door life, they are mistaken, for the author never fails to receive a batch of letters from grown-up people, whenever he publishes an out-door article for the boys. That the boys may answer the questions put to the author by the parents, and incidentally profit themselves by the information, the following suggestions to campers are given.

It will be observed that, when talking to the old people, the question of having sufficient funds is not taken as strictly into account as it is in all the plans for the boys themselves.

### **When You Start for Camp**

leave artificialities and fripperies behind, packed up in camphor, and bring only your free, untrammelled self with you, and ho! for a frolic, for flapjacks and coffee, sweet-scented spruce boughs, camp-fires, and the fireside song, and the music of the banjo. Let your first care be to secure cheerful, happy companions, as the most important articles for your camping outfit.

White flannel trousers and blazers are for the seaside and summer resorts, not for camp. You go to camp for health and fun, not for display; therefore leave your good clothes in your trunk at the last railroad station, to be called for when you quit the woods and once more enter

the land of creased trousers and starched shirts, of stocks, long skirts, and ties.

### **How the Women Should Dress.**

A woman's camp-dress should consist of a scant, short skirt, bloomers, leggings, and stout, broad-soled shoes, loose shirt-waist, and Norfolk jacket, the latter plentifully supplied with pockets. Whatever prejudice a woman may have against short skirts and bloomers is soon overcome after she has tried to climb fallen trees and rocks, or made her way through thick underbrush, encumbered with the absurd long skirts of the house or street, or after she has tramped to camp with a wet and bedrabbled skirt flapping around her ankles, caused by a walk in the dewy morning, or a paddle in a leaky boat. Women should have their dresses made of strong material, with "lots of pockets," like a man's hunting-clothes. They will find their capabilities for enjoyment greatly enhanced by this, and the men, at least, will think them just as bewitching and far better companions than they would be if they were dressed in city gowns, hats and feathers, and low shoes.

### **The Requirements for a Camp.**

Each person in camp should be supplied with a good, big-bladed jack-knife; a woodsman, or, what is about the same thing, a person with good common-sense, can supply himself with food and shelter, with no other ready-made tool than a good strong knife.

Salt, pepper, and sugar, must be put on the list; then flour in sack, oatmeal, cornmeal, rice, and lard; crackers, beans, coffee in tin, tea in bag, cocoa, condensed milk in cans, evaporated cream in cans, butter in pail, pickles, dried fruit

in bags, a bag of potatoes, molasses, pork, boneless bacon, and, if you are fond of it, a few jars of orange marmalade; sal-soda for sweetening "dubs," and ginger for medicinal purposes; several cakes of common soap for dish-washing, some dish-towels, and some soap for toilet purposes; also a tin coffee-pot, a long-handled frying-pan, a small griddle, a nest of tin pails, the smallest capable of holding a quart or less, and the largest a gallon or more; two or three paper pails or water-buckets, two or three iron kitchen spoons and forks, and a camp boiler, a firkin and a wooden spoon, also a strong axe and a hatchet.

#### **From the Stand-point of Health.**

It is presupposed that people who intend to spend their vacation in camp are lovers of the beautiful; consequently, in selecting a camping-place, a spot should be chosen which gives the finest possible view of mountains, lakes, or rivers, even if some inconvenience must be suffered in the selection. The camp must be dry and well-drained, so that in case of sudden storms there will be no danger of the water flooding the tents, wetting the bedding or spoiling the food. A gentle sloping ground is best. Avoid locating in the track or below the mouths of innocent-looking gullies or ravines, that may, in case of rain, be developed into torrents of muddy water, and sweep the camp like a cloudburst.

A supply of pure water contributes as much to the enjoyment of the campers as to the preservation of health. Common-sense will direct that the camp be selected within easy reach of some bubbling spring or fresh, uncontaminated brook of running water, but there is another thing of paramount importance, and that is a handy supply of fuel. The latter is of even more importance than that of

of planks are built in the shanties, one above the other, and, when filled with straw and covered with a blanket, make comfortable sleeping-quarters.

Portable houses are now manufactured of all forms and sizes, from a child's small playhouse to a two-story frame store. These buildings are made in sections; all parts are numbered and labelled, and may be put together and taken apart at will. Many of these houses are designed especially for camps, and may be shipped to the camping-ground with little trouble and erected with little loss of time. At the same factory may be purchased terra-cotta chimneys, in sections, ready to be stacked up for use. Some people prefer to build a chimney of stone or brick and leave it standing when the house is moved, others making stovepipe serve for a chimney.

### What is Needed for Table and Larder.

For table furniture select white blue-rimmed cups and saucers, and plates of granite-ware. The gray enamelled ware is not as good, for many reasons. These enamelled or granite-ware dishes are as easily cleaned as china, but, unlike china, they will not break. Nickel-plated teaspoons are in every way as good as silver for camp purposes, and should not cost more than three cents apiece. Knives and forks to match can easily be found. Be sure they are modern ones with three tines.

Lay in a supply of candles, and two or three common stable lanterns. You may add to these items as many

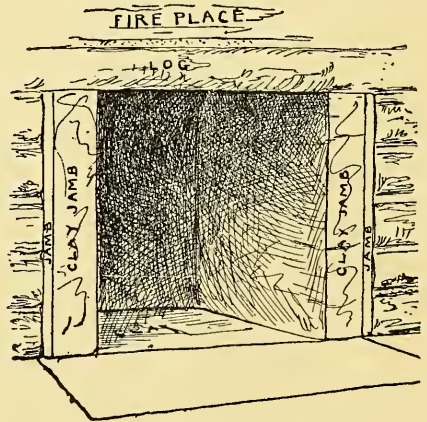
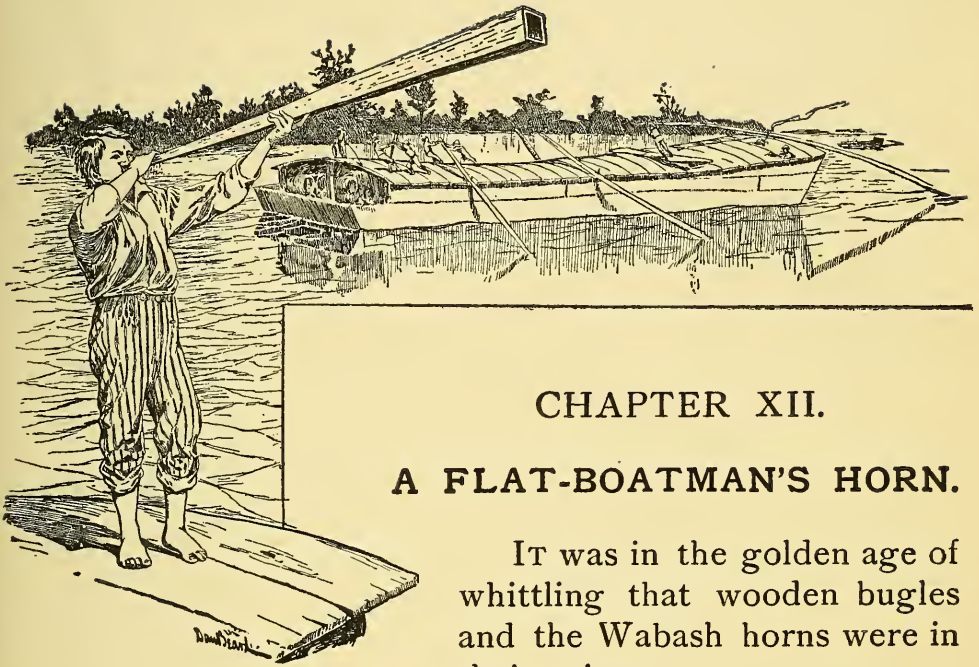

FIG. 108.



luxuries as your baggage will supply room for, or your purse or taste dictate. Fruit syrups, such as are used at reputable soda-water fountains, make very pleasant and healthful drinks when combined with good, cold spring-water. Lemons will keep in a cool, dry place for two weeks, and as a garnish for fish or soup not only give an appetizing look, which, as a rule, is unnecessary in camp food, but they add to the taste and relish, which is a property that persons blessed with good appetites appreciate, even when on a camping expedition.



## CHAPTER XII.

### A FLAT-BOATMAN'S HORN.

IT was in the golden age of whittling that wooden bugles and the Wabash horns were in their prime.

It is hardly an exaggerated figure of speech to say that the United States, with all its power and wealth, has been whittled out of the raw material by our ancestors, with their Barlow knives.

I think I have already told the readers, in one of my other books, that the practice of

#### Whittling

was not formerly confined to the youth of the country; lawyers, merchants, and statesmen, were adepts in the art, and on the counter of every well-regulated tavern was always to be found a heap of sweet-smelling cedar sticks for the guests to whittle, after meals.

Even as early as Puritan times the jack-knives were busy, and the little conscience-stricken Nathaniel Mathers

confesses that "of the manifold sins which then I was guilty of none so sticks upon me as that, being very young, I was *whittling on the Sabbath day*, and for fear of being seen I did it behind the door."

Times have changed since this poor little chap hid behind the door to whittle a stick, and some of the less conscientious descendants of the Puritans would not dare now to whittle on Sunday, or any other day, for fear of cutting their clumsy, untrained fingers. But the fingers of the readers of this book, I trust, are skilful in the use of a pocket-knife, and for them it will not be a difficult task to make a Wabash, or Flat-boatman's, wooden horn.

The wooden horn was the particular favorite of the jolly, reckless flat-boatmen. Its soft musical notes sounded especially sweet and mellow in the early morning, when the boatmen were casting loose their cables from their moorings. From Pittsburg to New Orleans the reveille of the boatmen's horns announced the dawn of another day.

Descriptions of these horns have come to us from our pioneer grandparents, and printed accounts can only be found by rummaging among old Western papers. The Frankfort (Kentucky) *Commonwealth*, in 1836, published some verses extolling the boatman's music:

Oh, boatman, wind that horn again!  
 For never did the joyous air  
 Upon its lambent bosom bear  
 So wild, so soft, so sweet a strain.

And this horn was made of the same material as the boat. They performed upon a wooden bugle of long conical shape, constructed of small wooden staves, which, according to all accounts, produced sounds of a wonderfully sweet tone. On a beautiful, clear and still morning the echoes of the

boatmen's trumpets, prolonged at a great distance through the neighboring woods and hills which bordered the river, are said to have possessed a charm and enchantment which none can realize but those who have heard them.

The Western boatmen were not the only ones who used

**Wooden Bugles,**

for there is an instrument of this kind still preserved in Kentucky, and is now, or was a few years ago, in the posses-



FIGS. 109 and 110.

sion of Mrs. Annie Mayhall, a granddaughter of Captain Robert Collins.

Colonel Richard Johnson made a famous charge in the war of 1812, and Captain Bob Collins sounded the charge on his home-made cedar horn.

If there are any illustrations of this charge, the bugler will no doubt be represented as blowing on the regulation brass instrument; but you must remember, boys, that the



artists were not in that fight. Artists have a way of doing things up fine, as may be seen by the pictures of our

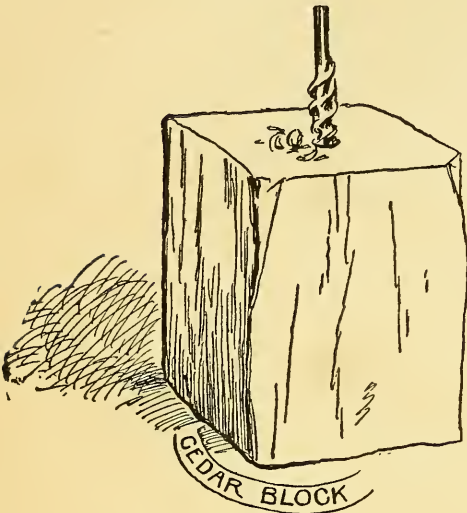

FIG. III.

### Revolutionary Soldiers,

all in regulation uniforms, when the truth is that there was scarcely a uniformed regiment in the army. The grand old fellows fought in their hunting garb, or the dress they wore on the farm, in the store, the church, or the tavern; and while they may not have used wooden horns, it is very probable that many a Continental bugler carried an old cow's-horn, with which to sound the reveille.

But the bugle which sounded the death-knell of the great Indian chief Tecumseh was

### The Old Wooden Horn of Captain Bob Collins.

It was made of two cedar slabs, three-sixteenths of an inch in thickness, and these were trimmed and bent so that when their edges were joined they formed a funnel-shaped instrument which was about four inches in diameter at the bell or larger end, and tapered down to a convenient size at the small end, or mouth-piece. The two cedar slabs were held in place by hoops made of cow's-horn.

Whether it was a habit acquired in the army, or whether Captain Bob was once a flat-boatman, is not recorded, but certain it is that the doughty Captain always sounded the reveille at sunrise, and it was not until 1864, when death called the old man home, that the neighbors, for miles

around, saw the sun rise unheralded by the notes of the quaint instrument.

To make a horn like Captain Bob's requires nice work in steaming, bending, and joining the cedar slabs, but Captain Bob belonged to the Barlow-knife age, and undoubtedly knew how to use one.

Fortunately for boys less skilful than this old pioneer, our ancestors have furnished us another kind of horn, which any boy can make. The original sketches, from which the accompanying diagrams are drawn, were made for the author by a very old gentleman who was himself once a flat-boatman and used the Wabash horn.

This instrument is known as

### **The Wabash Horn,**

(see illustration), for it was among the boatmen from that river that it was always found.

Since the introduction of the house-boat as a popular summer vacation boat, there is no reason why the Wabash horn should not be rescued from the legends of the West and hung under the eaves of every American boy's house-boat, to be used to summon the crew, as it was in the good old times before Fulton filled the waters with his steam-boats and the air with their ear-splitting whistles.

The Wabash horn is one of the most primitive affairs possible; it is simply a long box, open at both ends, and differs from an ordinary box in the fact that one end is very

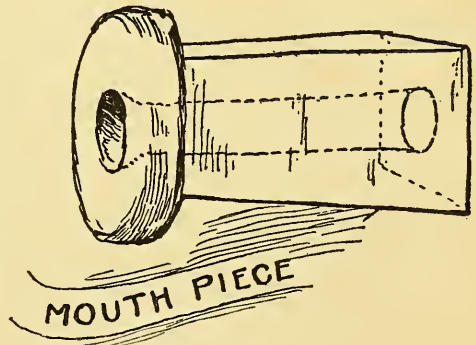

FIG. 112.

much smaller than the opposite end; the big end is the bell of the horn, and the small end is the part you put to your lips.

### **Among the Flat-boatmen**

these horns were made of pine, and sometimes they were as much as eight feet long; but five or six feet will be long enough for any ordinary boy.

Fig. 109 shows a six-foot slab, smoothed and trimmed into proper form. It should be less than a quarter of an inch thick, and made of red-wood, pine, or cedar, which is free from knots, cracks, or blemishes of any kind. Make it four or five inches wide at the big end and two inches wide at the small end, outside measurement. See that the edges are perfectly straight and true; otherwise your horn will leak, and not only be difficult or impossible to blow, but if you do succeed in making a noise with it the notes will be flat and unpleasant. The other three slabs are of the same form as the one described, but to make the openings square two sides must be of dimensions given, and with the other two you must allow for the thickness of the wood, and make them just that much narrower than the first two (Fig. 110).

### **For a Mouth-piece,**

to fit the end of the horn, take a cedar block (Fig. 111) of such dimensions that there will be no risk of splitting it with an auger, and bore a hole through its centre, after which it may be trimmed down to any required dimensions. Next put three sides of your box together and fasten them securely, with small brads.

You can now see the exact form of the small end, and can whittle your cedar mouth-piece (Fig. 112) to fit the little end of the box, and round off the protruding end, as shown in the diagram.

The diagrams of the block and mouth-piece are drawn on a much larger scale than those of the slab and box, that they may be better understood.

With a piece of sand-paper, wrapped around a pine stick, sand-paper the hole in the cedar mouth-piece until it is perfectly smooth. Put the mouth-piece in place, tack on the remaining side to the box, and your Wabash horn is finished.

You can now practise until you learn the bugle-calls, and then hang it under the eaves of your boat, with a just feeling of pride in the knowledge that you are not only a boatman, and a modern wide-awake boy of to-day, but that you lack neither the skill nor the self-reliance of the boy of the day before yesterday.



## CHAPTER XIII.

### THE AMERICAN BOY'S HOUSE-BOAT.

WHEN the great West of the United States began to attract immigrants from the Eastern coast settlements, the Ohio River rolled between banks literally teeming with all sorts of wild game and wilder men: then it was that the American house-boat had its birth.

The Mississippi, Ohio, and their tributaries furnished highways for easy travel, of which the daring pioneers soon availed themselves.

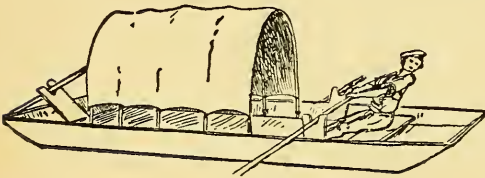

FIG. 113.

Lumber was to be had for the labor of felling the trees. From the borders of the Eastern plantations to the prairies, and below the Ohio to the Mississippi, and from the Great Lakes to the Gulf of Mexico, was one vast forest of trees. Trees whose trunks were unscarred by the axe, and whose tall tops reached an altitude which would hardly be believed by those of this generation, who have only seen second, third, or fourth-growth timber.

When the settlement of this new part of the country began it was not long before each stream poured out, with its own flood of water,

#### A Unique Navy.

There were keel-boats, built something like a modern canal-boat, only of much greater dimensions; there were

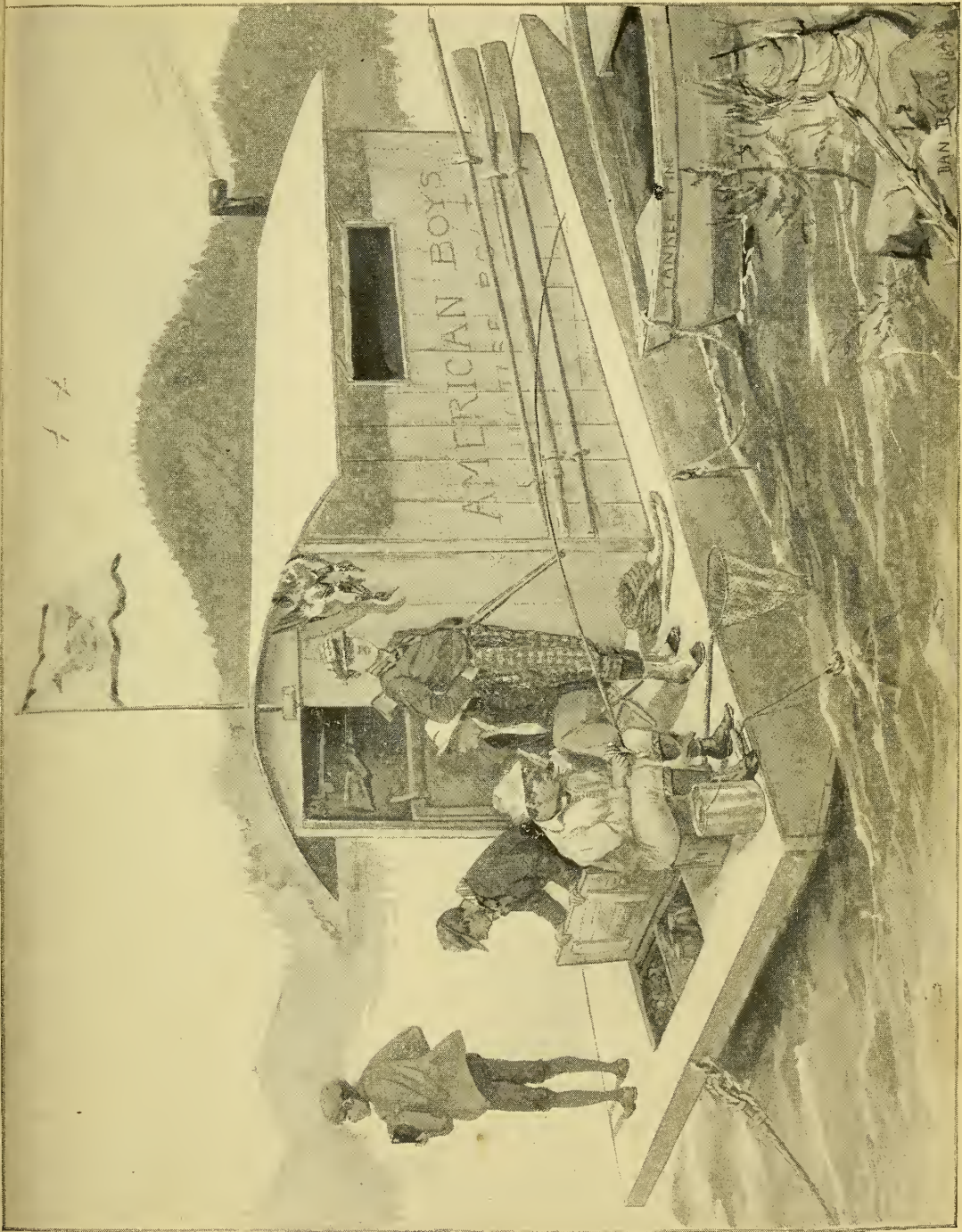

Bound for a Good Time.



broad-horns, looking like Noah's arks from some giant's toy-shop, and there were flat-boats and rafts, the latter with houses built on them, all recklessly drifting, or being propelled by long sweeps down the current into the great solemn, unknown wilderness.

Every island, had it a tongue, could tell of wrecks; every point or headland, of adventure.

The perils were great and the forest solemn, but the immigrants were merry, and the squeaking fiddle made the red man rise up from his hiding-place and look with wonder upon the "long knives" and their squaws dancing on the decks of their rude crafts, as they swept by into the unknown.

The advent of the steam-boat gradually drove the flat-boat, broadhorn, keel-boat, and all the primitive sweep-propelled craft from the rivers, but many of the old boatmen were loath to give up so pleasant a mode of existence, and they built themselves house-boats, and, still clinging to their nomadic habits, took their wives, and went to house-keeping on the bosom of the waters they loved so well.

Their descendants now form what might well be called a race of river-dwellers, and to this day their quaint little arks line the shores of the Mississippi and its tributaries.

### Some of These House-Boats

are as crudely made as the Italian huts we see built along the railroads, but others are neatly painted, and the interiors are like the prover-

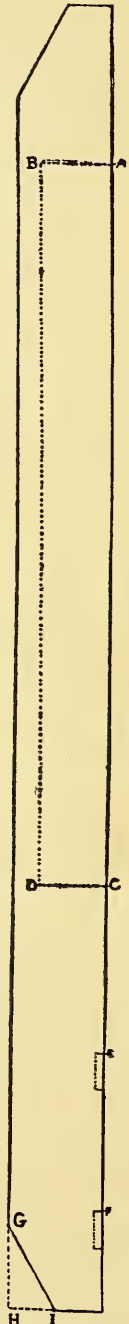

FIG. 114.



bial New England homes, where everything is spick-and-span.

Like the drift-wood, these boats come down the stream with every freshet, and whenever it happens that the waters are particularly high they land at some promising spot and earn a livelihood on the adjacent water, by fishing and working aboard the other river-craft, or they land at some farming district, and as the waters recede they prop up and level their boats, on the bank, with stones or blocks of wood placed under the lower corners of their homes.

The muddy waters, as they retire, leave a long stretch of fertile land between the stranded house and the river, and this space is utilized as a farm, where ducks, chickens, goats and pigs are raised, and where garden-truck grows luxuriantly.

From a boat their home has been transformed to a farmhouse; but sooner or later there will be another big freshet, and when the waters reach the late farm-house, lo! it is a boat again, and goes drifting in its happy-go-lucky way down the current. If it escapes the perils of snags and the monster battering-rams, which the rapid current makes of the drifting trees in the flood, it will land again, somewhere, down-stream.

Lately, while on a sketching trip through Kentucky, I was greatly interested in these boats, and on the Ohio River I saw several making good headway against the four-mile-an-hour current. This they did by the aid of

### **Big Square Sails,**

spread on a mast planted near their bows, thus demonstrating the practicability of the use of sails for house-boats.

The house-boats to be described in this article are much

better adapted for sailing than any of the craft used by the water-gypsies of the Western rivers.

For open and exposed waters, like the large lakes which dot many of our inland States, or the Long Island Sound on our coast, the following plans of the American boy's house-boat will have to be altered, but the alterations will be all in the hull. If you make the hull three feet deep it will have the effect of lowering the cabin, while the head-room inside will remain the same. Such a craft can carry a good-

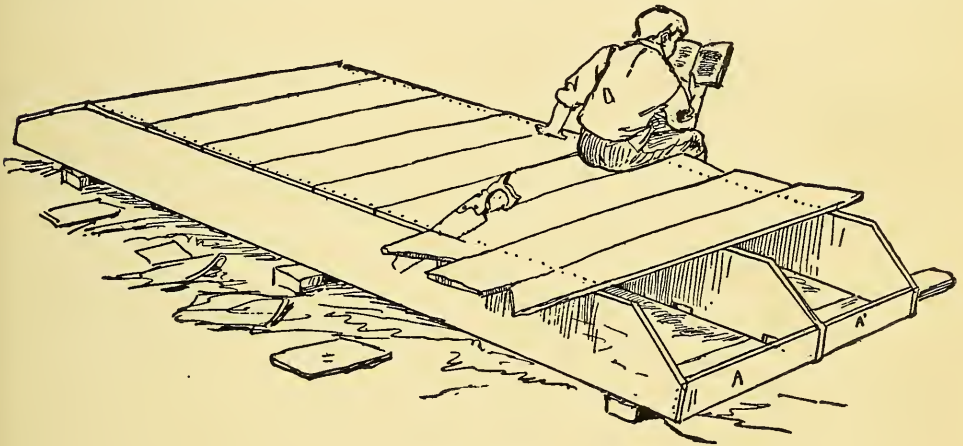

FIG. 115.

sized sail, and weather any gale you are liable to encounter, even on the Sound, during the summer months.

Since the passing away of the glorious old flat-boat days, idle people in England have introduced the

### **House-Boat as a Fashionable Fad,**

which has spread to this country, and the boys now have a new source of fun, as a result of this English fad.

There are still some nooks and corners left in every State in the Union which the greedy pot-hunter and the devouring saw-mill have as yet left undisturbed, and at such

places the boy boatmen may "wind their horns," as their ancestors did of old, and have almost as good a time. But first of all they must have a boat, and for convenience the American boy's house-boat will probably be found to excel either a broadhorn or a flat-boat model, it being a link between the two.

The simplest possible house-boat is a Crusoe raft,\* with a cabin near the stern and a sand-box for a camp-fire at the bow. A good time can be had aboard even this primitive craft. The next step in evolution is the long open scow, with a cabin formed by stretching canvas over hoops that reach from side to side of the boat (see Fig. 113).

Every boy knows how to build

### **A Flat-Bottomed Scow,**

or at least every boy should know how to make as simple a craft as the scow, but for fear some lad among my readers has neglected this part of his education, I will give a few hints which he may follow.

### **Building Material.**

Select lumber that is free from large knots and other blemishes. Keep the two best boards for the sides of your boat. With your saw cut the side-boards into the form of Fig. 114; see that they are exact duplicates. Set the two pieces parallel to each other upon their straight or top edges, as the first two pieces shown in Fig. 115. Nail on an end-piece at the bow and stern, as the bumper is nailed in Figs. 116 and 117; put the bottom on as shown in Fig. 115, and you have a simple scow.

---

\* See p. 100, "The American Boy's Handy Book."

### Centre-Piece.

In Fig. 115 you will notice that there are two sides and a centre-piece, but this centre-piece is not necessary for the ordinary open boat, shown by Fig. 113. Here you have one of the simple forms of house-boat, and you can make it of dimensions to suit your convenience. I will not occupy space with the details of this boat, because they may be seen by a glance at the diagrams, and my purpose is to tell you how to build the American boy's house-boat, which is a more elegant craft than the rude open scow, with a canvas-covered cabin, shown by Fig. 113.

### The Sides of the House-Boat

are 16 feet long, and to make them you need some sound two-inch planks. After selecting the lumber plane it off and make the edges true and straight. Each side and the centre-piece should now measure exactly 16 feet in length by 14 inches in width, and about 2 inches thick. Cut off from each end of each piece a triangle, as shown by the dotted lines at G, H, I (Fig. 114); from H to G is 1 foot, and from H to I is 7 inches. Measure from H to I, 7 inches, and mark the point. Then measure from H to G, 12 inches, and mark the point. Then, with a carpenter's pencil, draw a line from G to I, and saw along this line. Keep the two best planks for the sides of your boat, and use the one that is left for the centre-piece. Measure 2 feet on the top or straight edge of your centre-piece, and mark the point, A (Fig. 114). From A measure 8 feet 10 inches, and mark the point C (Fig. 114).

With a carpenter's square rule the lines A, B and C, D, and make them each 10 inches long, then rule the line, B,



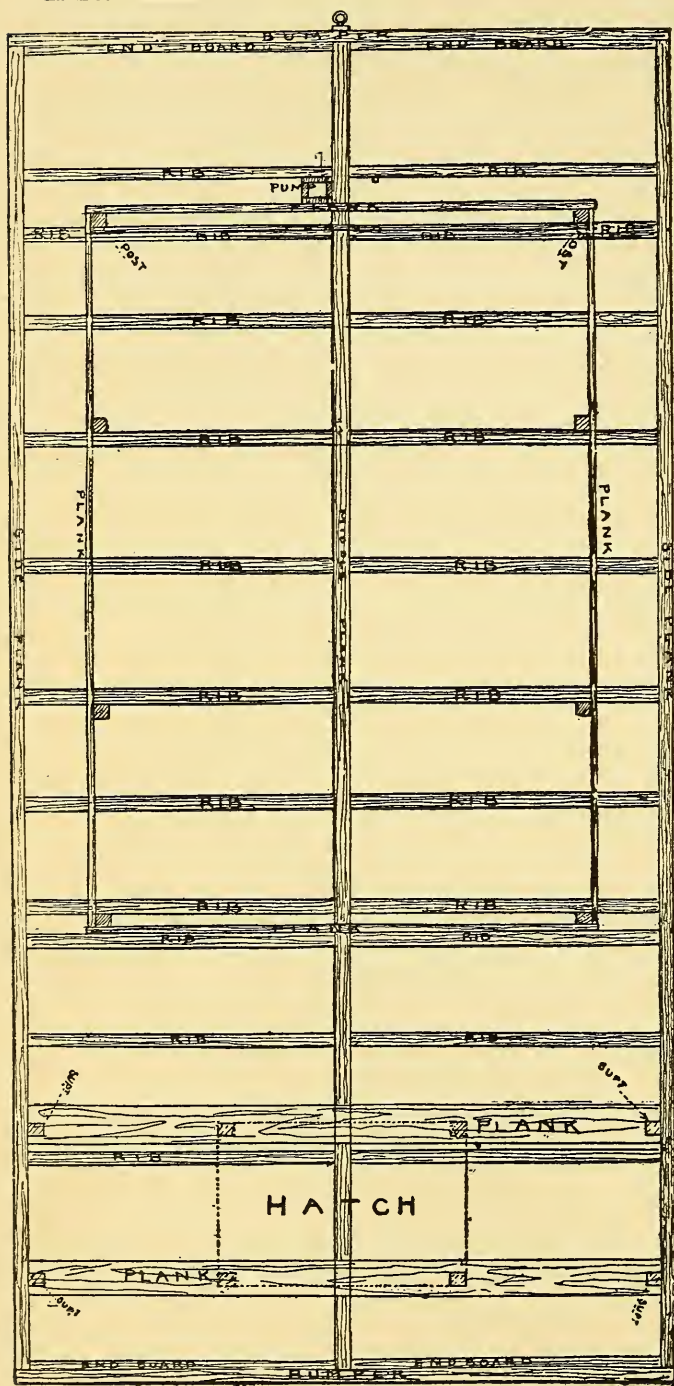

FIG. 116.

D (Fig. 114). The piece A, B, C, D must now be carefully cut out; this can be done by using the saw to cut A, B and D, C. Then, about 6 inches from A, saw another line of the same length, and with a chisel cut the block out. You then have room to insert a rip-saw, at B, and can saw along the line B, D until you reach D, when the piece may be removed, leaving the space A, B, D, C for the cabin of the boat (see Figs. 116 and 117).

At a point 9 inches from the bow of the boat make a mark on the centre-piece, and another mark 5 inches farther

away, at F (Fig. 114). With the saw cut a slit at each mark, 1 inch deep, and with a chisel cut out, as shown by the dotted lines; do the same at E, leaving a space of  $1\frac{1}{2}$  feet between the two notches, which are made to allow the two planks shown in the plan (Fig. 116), to rest on. These planks support the deck and the hatch, at the locker in the bow. The notches at E and F are not on the side-boards, the planks being supported at the sides by uprights, Figs. 116 and 117.

All that now remains to be done with the centre-piece is to saw some three-cornered notches on bottom edge, one at bow, one at stern, and one or two amidships; this is to allow the water which may leak in to flow freely over the whole bottom, and to prevent it from gathering at one side and causing your craft to rest upon an uneven keel.

Next select a level piece of ground near by and arrange the three pieces upon some supports, as shown in Fig. 115, so that from outside to outside of side-pieces it will measure just 8 feet across the bow and stern. Of 1-inch board

### **Make Four End-Pieces,**

for the bow and stern (see A, A', Fig. 115), to fit between the sides and centre-piece. Make them each a trifle wider than H, I, Fig. 114, so that after they have been fitted they can be trimmed down with a plane, and bevelled on the same slant as the bottom at G, I, Fig. 114. It being 8 feet between the outside of each centre-piece, and the sides and the centre-piece being each 2 inches thick, that gives us 8 feet — 6 inches, or  $7\frac{1}{2}$  feet as the combined length of A and A' (Fig. 115). In other words, each end-piece will be half of  $7\frac{1}{2}$  feet long—that is, 3 feet 9 inches long. After making the four end-pieces, each 3 feet 9, by 9 inches, fit the ends in place so that there is an inch protruding above and below. See that your bow and stern are perfectly square, and nail

with wire nails through the sides into A and A'; toe-nail at the centre-piece—that is, drive the nails from the broad side of A and A' slantingly, into the centre-piece, after which trim down with your plane the projecting inch on bottom, to agree with the slant of the bottom of the boat.

### Now for the Bottom.

This is simple work. All that is necessary is to have straight, true edges to your one-inch planks, fit them to-

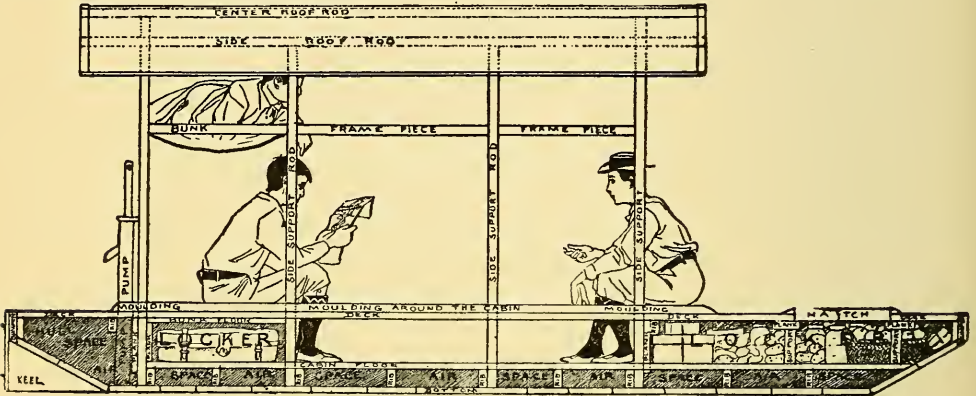

FIG. 117.—Cross-Section of Boat.

gether, and nail them in place. Of course, when you come to the slant at bow and stern the bottom-boards at each end will have to have a bevelled edge, to fit snugly against the boards on the flat part of the bottom of the boat; but any boy who is accustomed to shake the gray matter in his brain can do this. Remember, scientists say that thought is the agitation of the gray matter of the brain, and if you are going to build a boat or play a good game of football you must shake up that gray stuff, or the other boys will put you down as a "stuff." No boy can expect to be successful in building a boat, of even the crudest type, unless

he keeps his wits about him, so I shall take it for granted that there are no "stuffs" among my readers.

After the boards are all snugly nailed on the bottom, and fitted together so that there are no cracks to calk up, the hull is ready to have

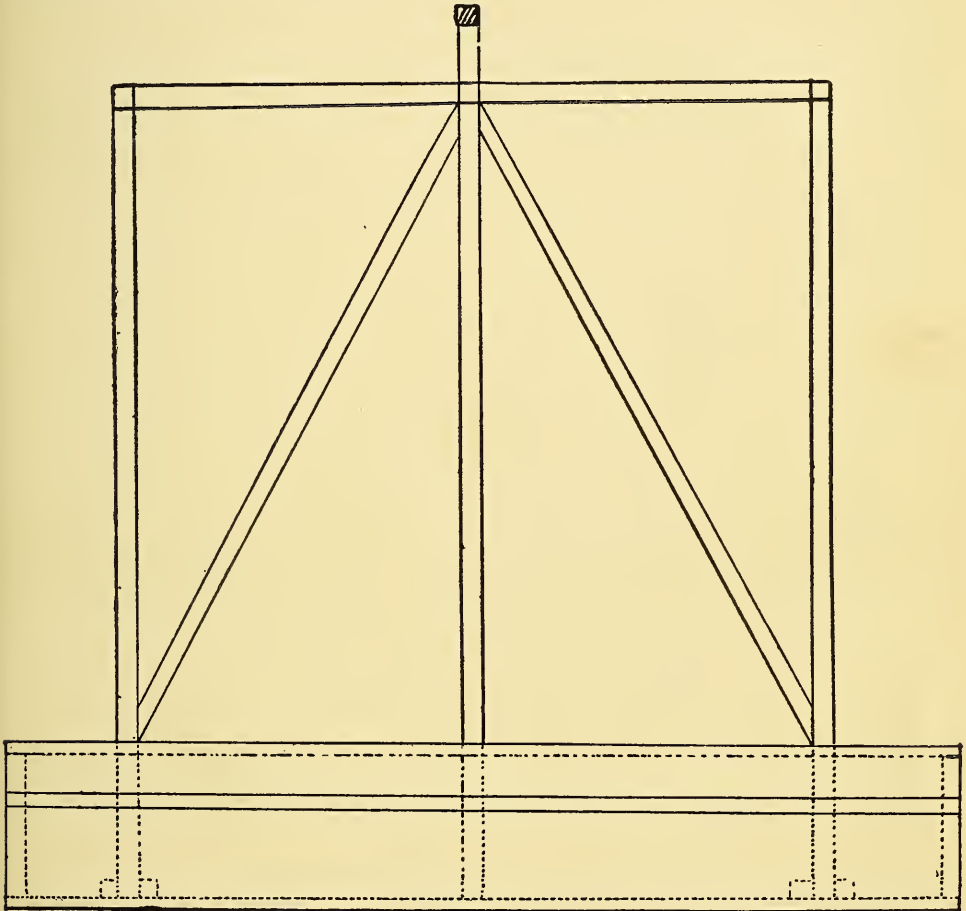

FIG. 118.

### The Bumpers

nailed in place, at bow and stern. See the plan, Fig. 116, and the elevation, Fig. 117. The bumpers must be made of 2-inch plank, 8 feet long by about 9 inches wide; wide



enough to cover A and A' of Fig. 115, and to leave room for a bevel at the bottom edge to meet the slant of the bow and stern, and still have room at the top to cover the edge of the deck to the hull (see Fig. 117).

### **The Hull May Now be Painted,**

with two coats of good paint, and after it is dry may be turned over and allowed to rest on a number of round sticks, called rollers.

If you will examine Fig. 116 you will see there

### **Twenty-odd Ribs.**

These are what are called two-by-fours—that is, 2 inches thick by 4 inches wide. They support the floor of the cabin and forward locker, at the same time adding strength to the hull.

The ribs are each the same length as the end-board, A and A' of Fig. 115, and are nailed in place in the same manner. Each bottom-rib must have a notch 2 inches deep cut in the bottom edge to allow the free passage of water, so as to enable you to pump dry. Commencing at the stern, the distance between the inside of the bumper and the first rib is 1 foot 6 inches. This is a deck-rib, as may be seen by reference to Figs. 116 and 117. After measuring  $1\frac{1}{2}$  feet from the bumper, on inside of side-board, mark the point with a carpenter's pencil. Measure the same distance on the centre-piece, and mark the point as before; then carefully fit your rib in flush or even with the top of the side-piece, and fasten it in place by nails driven through the side-board into the end of the rib, and toe-nailed to centre-piece. Do the same with its mate on the other side of centre-piece.

### **The Cabin of this House-Boat**

is to fit in the space, A, B, D, C of the centre-piece, Fig. 114. There is to be a 1-inch plank at each end (see Fig. 117), next to which the side-supports at each end of cabin fit. The supports are two-by-twos; so, allowing 1 inch for the plank and 2 inches for the upright support, the next pair of ribs will be just 3 inches from A B, Fig. 114, of the centre-piece (see Figs. 116 and 117). The twin ribs at the forward end of the cabin will be the same distance from D C, Fig. 114, as shown in the plan and elevation, Figs. 116 and 117. This leaves five pairs of ribs to be distributed between the front and back end of the cabin. From the outside of each end-support to the inside of the nearest middle-support is 2 feet 6 inches. Allowing 2 inches for the supports, this will place the adjoining ribs 2 feet 8 inches from the outside of the end-supports. The other ribs are placed midway between, as may be seen by the elevation, Fig. 117.

There is another pair of

### **Deck-Ribs**

at the forward end of the cabin, which are placed flush with the line D, C, Fig. 114 (see Figs. 116 and 117). The two pairs of ribs in the bow are spaced, as shown in the diagram. This description may appear as if it was a complicated affair; but you will find it a simple thing to work out if you will remember to allow space for your pump in the stern, space for the end-planks at after and forward end of cabin, and space for your uprights. The planks at after and forward end of cabin are to box in the cabin floor.

### The Boat May Now be Launched

by sliding it over the rollers, which will not be found a difficult operation.

### The Plans Show Three Lockers

—two in the bow under the hatch and one under the rear bunk—but if it is deemed necessary the space between-decks, at each side of the cabin, may be utilized as lockers. In this space you can store enough truck to last for months. A couple of doors in the plank at the front of the cabin opening, under the deck, will be found very convenient to reach the forward locker in wet weather.

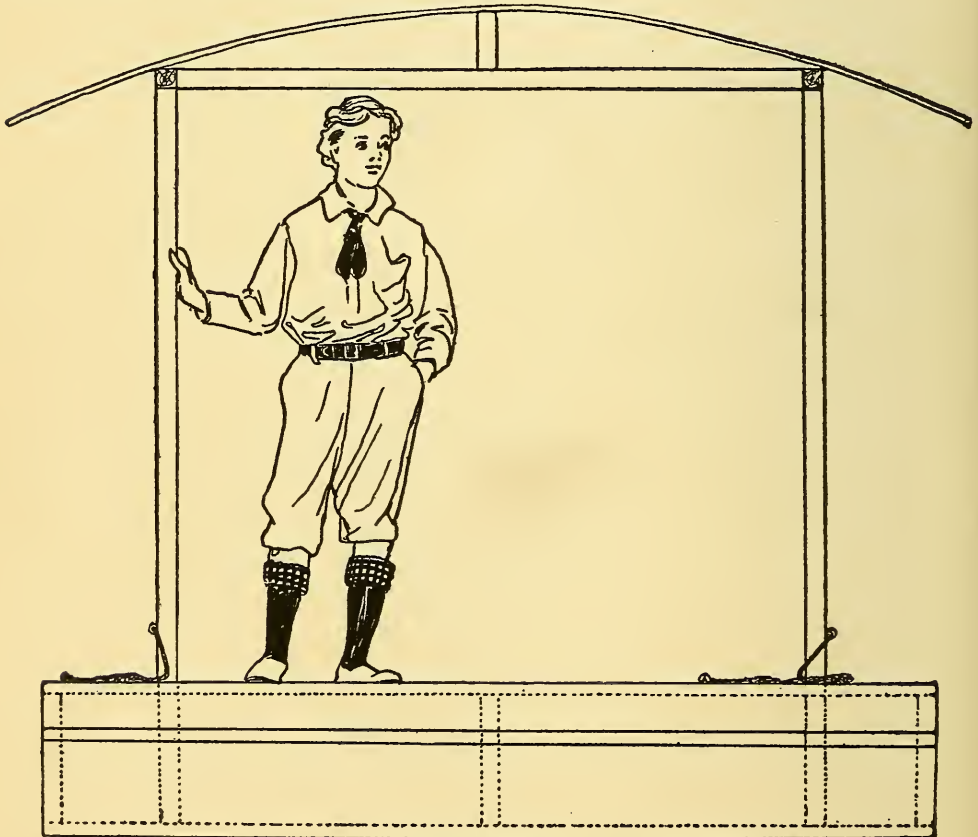

FIG. 119.

### **The Keel**

is a triangular piece of 2-inch board, made to fit exactly in the middle of the stern, and had best be nailed in place before the boat is launched (see Fig. 117). The keel must have its bottom edge flush with the bottom of the boat, and a strip of hard-wood nailed on the stern-end of the keel and bumper, as shown in the diagram. A couple of strong screw-eyes will support the rudder.

After the boat is launched the

### **Side-Supports for the Cabin May be Erected.**

These are "two-by-twos" and eight in number, and each 5 feet 9 inches long. Nail them securely at their lower ends to the adjoining ribs. See that they are plumb, and fasten them temporarily with diagonal pieces, to hold the top ends in place, while you nail down the lower deck or flooring.

Now fit and nail the two 1-inch planks in place, at the bow and stern-end of the cabin, each of which has its top one inch above the sides, even with the proposed deck (see dotted lines in Fig. 117).

### **Use Ordinary Flooring,**

or if that is not obtainable use  $\frac{3}{4}$ -inch pine boards, and run them lengthwise from the bow to the front end of the cabin and along the sides of the cabin. Then floor the cabin lengthwise from bow to stern. This gives you a dry cabin floor, for there are 4 inches of space underneath for bilge water, which unless your boat is badly made and very leaky, is plenty of room for what little water may leak in from above or below. The two side-boards of the cabin



floor must, of course, have square places neatly cut out to fit the uprights of the cabin. This may be done by slipping the floor-board up against the uprights and carefully marking the places with a pencil where they will come through the board, and then at each mark sawing two inches in the floor plank, and cutting out the blocks with a chisel.

### **The Hatch.**

Now take a "four-by-four" and saw off eight short supports for the two 1-inch planks which support the hatch, Figs. 116 and 117. Toe-nail the middle four-by-four to the floor in such a position that the two cross-planks (which are made to fit in the notches E and F, Fig. 114) will rest on the supports. Nail the four other supports to the side-boards of your boat, and on top of these nail the cross-planks, as shown in the diagrams.

The boat is now ready for its

### **Upper Deck**

of 1-inch pine boards. These are to be nailed on length-wise, bow and stern and at sides of cabin, leaving, of course, the cabin open, as shown by the position of the boys in Fig. 117, and an opening, 3 feet by 2, for the hatch (Fig. 116). The two floors will act as benches for the uprights of the cabin, and hold them stiff and plumb.

To further stiffen the frame, make two diagonals for the stern-end, as shown in Fig. 118, and nail them in place.

### **The Rafters,**

or roof-rods, should extend a foot each way beyond the cabin, hence cut them two feet longer than the cabin, and after testing your uprights, to see that they are exactly

plumb, nail the two side roof-rods in place (see dotted lines in Fig. 117). The cross-pieces at the ends, as they support no great weight, may be fitted between the two side-rods, and nailed there.

The roof is to be made of  $\frac{1}{2}$ -inch boards bent into a curve, and the ridge-pole, or centre roof-rod, must needs have some support. This is obtained by two short pieces of 2-by-4, each 6 inches long, which are toe-nailed to the centre of each cross-rod, and the ridge-pole nailed to their tops. At 3 feet from the upper deck the side frame-pieces are toe-nailed to the uprights. As may be seen, there are three two-by-fours on each side (Fig. 117).

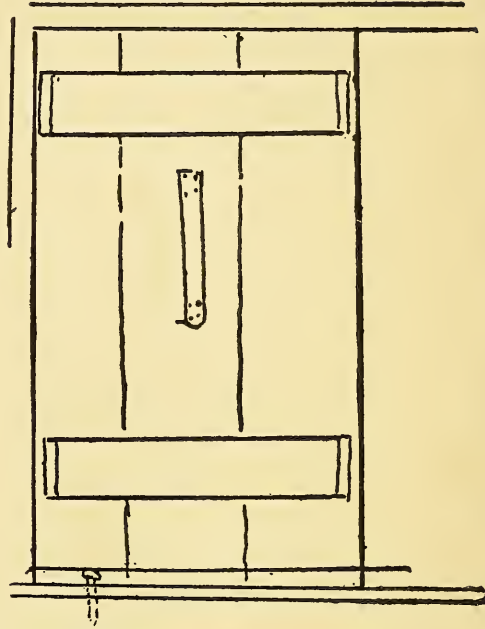

FIG. 120.—Inside View of Door.

The space between the side frame-pieces, the two middle uprights, and side roof-rods, is where the windows are to be placed.

Use  $\frac{1}{2}$ -inch (tongue and groove preferred) pine boards for sidings, and

### Box in your Cabin

neatly, allowing space for windows on each side, as indicated. Leave the front open. Of the same kind of boards make your roof; the boards being light you can bend them down upon each side and nail them to the side roof-rods, forming a pretty curve, as may be seen in the illustration of the American boy's house-boat.

### This Roof,

to be finished neatly and made entirely water-proof, should be covered with tent-cloth or light canvas, smoothly stretched over and tacked upon the under side of the projecting edges. Three good coats of paint will make it water-proof and pleasant to look upon.

The description, so far, has been for a neatly finished craft, but I have seen very serviceable and comfortable house-boats built of rough lumber, in which case the curved roof, when they had one, had narrow strips nailed over the boards where they joined each other.

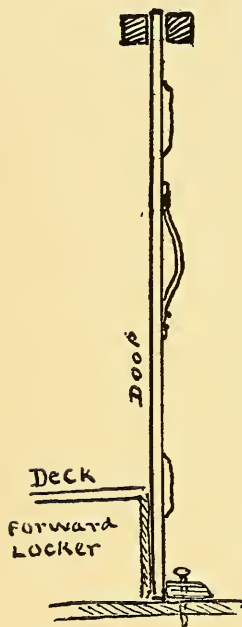

FIG. 121.—Side-View of Door.

### To Contrive a Movable Front

to your cabin, make two doors to fit and close the front opening, but in place of hanging the doors on hinges, set them in place. Each door should have a good strong strap nailed securely on the inside, for a handle, and a batten or cross-piece at top and bottom of inside surface. A two-by-four, run parallel to the front top cross-frame and nailed there, just a sufficient distance from it to allow the top of the

door to be inserted between, will hold the top of the door securely. A two-by-four, with bolt-holes near either end to correspond with bolt-holes in the floor, will hold the bottom when the door is pushed in place, the movable bottom-piece shoved against it and the bolts thrust in (see Fig. 120, view from inside of cabin. Fig. 121, side-view). It will be far less work to break in the side of the

cabin than to burst in such doors, if they are well made. These doors possess this advantage: they can be removed and used as table-tops, leaving the whole front open to the summer breeze, or one may be removed, and still allow plenty of ventilation. A moulding on deck around the cabin is not necessary, but it will add finish and prevent the rain-water from leaking in.

To lock up the boat you must set the doors from the inside, and if you wish to leave the craft locked you must crawl out of the window and fasten the latter with a padlock.

Fig. 122 shows the construction of

### **The Rudder,**

and also an arrangement by which it may be worked from the front of the boat, which, when the boat is towed, will be found most convenient.

The hatch should be made of 1-inch boards, to fit snugly flush with the deck, as in the illustration, or made of 2-inch plank, and a moulding fitted around the opening, as shown in Fig. 117.

### **A Pair of Rowlocks,**

made of two round oak sticks with an iron rod in their upper ends, may be placed in holes in the deck near the bow, and the boat can be propelled by two oarsmen using long "sweeps," which have holes at the proper places to fit over the iron rods projecting from the oaken rowlocks. These rowlocks may be removed when not in use, and the holes closed by wooden plugs, while the sweeps can be hung at the side of the cabin, under its eaves, or lashed fast to the roof.



### **Two or more Ash Poles,**

for pushing or poling the boat over shallow water or other difficult places for navigation are handy, and should not be left out of the equipment. The window-sashes may be hung on hinges and supplied with hooks and screw-eyes to fasten them open by hooking them to the eaves when it is desired to let in the fresh air, as shown in the illustration of the finished boat.

Two bunks can be fitted at the rear end of the cabin, one above the other, the bottom bunk being the lid to a locker (see Fig. 117).

### **The Locker**

is simply a box, the top of which is just below the deck-line and extending the full width of the cabin. It has hinges at the back, and may be opened for the storage of luggage.

Over the lid blankets are folded, making a divan during the day and a bed at night.

The top bunk is made like the frame of a cheap cot, but in place of being upholstered it has a strong piece of canvas stretched across it. This bunk is also hinged to the back of the cabin, so that when not in use it can be swung up against the roof and fastened there as the top berth in a sleeping-car is fastened. Four 4-by-4 posts can be bolted to the side-support at each corner of the bottom bunk; they will amply support the top bunk, as the legs do a table-top when the frame is allowed to rest upon their upper ends. This makes accommodation for two boys, and there is still room for upper and lower side bunks, the cabin being but six feet wide. If you put bunks on both sides you will be rather crowded, it is true, but by allow-

ing a 1-foot passage in the middle, you can have two side bunks and plenty of head room. This will accommodate four boys, and that is a full crew for a boat of this size.

On board a yacht I have often seen four full-grown men crowded into a smaller space in the cabin, while the sailormen in the fo'castle had not near that amount of breathing-room.

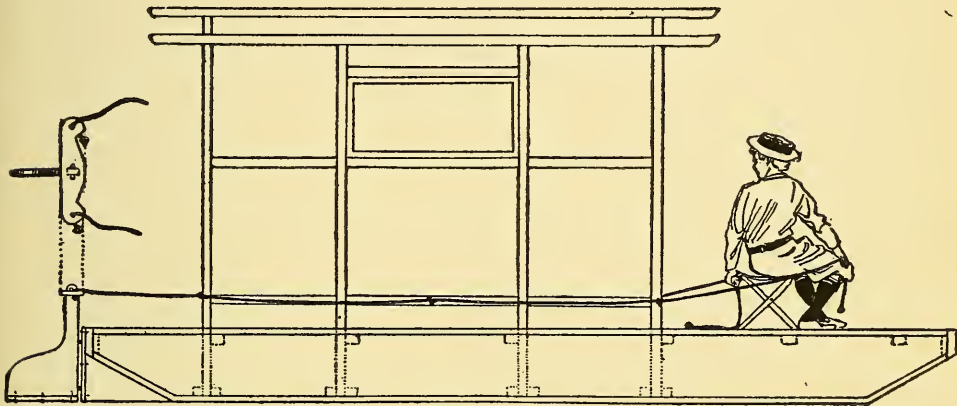

FIG. 122.

Figs. 118, 119, and 120 show

### **A More Simple Set of Plans.**

Here the cabin is built on top of the upper deck, and there are no bottom-ribs, the uprights being held in place by blocks nailed to the bottom of the boat, and by the deck of the boat. This is secure enough for well-protected waters, small lakes, and small streams. Upon the inland streams of New York State I have seen two-story house-boats, the cabin, or house, being only a frame-work covered with canvas. One such craft I saw in central New York, drifting down-stream over a shallow riff, and as it bumped along over the stones it presented a strange sight. The night was intensely dark, and the boat brightly lighted. The lights shone through the canvas covering, and this big

luminous house went bobbing over the shallow water, while shouts of laughter and the "plinky-plunk" of a banjo told in an unmistakable manner of the jolly time the crew were having.

### **Canvas-Cabined House-Boat.**

If you take an ordinary open scow and erect a frame of uprights and cross-pieces, and cover it with canvas, you will have just such a boat as the one seen in central New York. This boat may be propelled by oars, the rowers sitting under cover, and the canvas being lifted at the sides to allow the sweeps to work; but of course it will not be as snug as the well-made American boy's house-boat, neither can it stand the same amount of rough usage, wind, and rain as the latter boat.

In the illustration the reader will notice a stove-pipe at the stern; there is room for a small stove back of the cabin, and in fair weather it is much better to cook outside than inside the cabin. When you tie up to the shore for any length of time, a rude shelter of boughs and bark will make a good kitchen on the land, in which the stove may be placed, and you will enjoy all the fun of a camp, with the advantage of a snug house to sleep in.

For the benefit of boys who doubt their ability to build a boat of this description, it may be well to state that other lads have used these directions and plans with successful results, and their boats now gracefully float on many waters, a source of satisfaction and pride to their owners.

### **Information for Old Boys.**

On all the Western rivers small flat-boats or scows are to be had at prices which vary in accordance with the mercantile instincts of the purchaser, and with the desire of the seller to dispose of his craft. Such boats are propelled by

“sweeps,” a name used to designate the long poles with boards on their outer edges that serve as blades and form the oars. These boats are often supplied with a deck-house, extending almost from end to end, and if such a house is lacking one may be built with little expense. The cabin may be divided into rooms and the sleeping apartments supplied with cheaply made bunks. It is not the material of the bunk which makes it comfortable—it is the mattress in the bunk upon which your comfort will depend. The kitchen and dining-room may be all in one. An awning spread over the roof will make a delightful place in which to lounge and catch the river breezes.

### **The Cost of House-Boats.**

The cost of a ready-made flat-bottomed house-boat is anywhere from thirty dollars to one or more thousands. In Florida such a boat, 40 by 20 feet, built for the quiet waters of the St. John's River or its tributaries, or the placid lagoons, will cost eight hundred dollars. This boat is well painted outside and rubbed down to a fine oil finish inside; it has one deck, and the hull is used for toilet apartments and state-rooms; the hull is well calked and all is in good trim. Such expense is, however, altogether unnecessary—there need be no paint or polish. All you need is a well-calked hull and a water-tight roof of boards or canvas overhead; cots or bunks to sleep in; chairs, stools, boxes or benches to sit on; hammocks to loll in, and a good supply of provisions in the larder.

House-boats for the open waters are necessarily more expensive. As a rule they need round bottoms that stand well out of the water, and are built like the hull of a ship. These boats cost as much to build as a small yacht. From twelve to fifteen hundred dollars will build a good house-



boat, with comfortable sleeping-berths, toilet-rooms, and store-rooms below; a kitchen, dining-room and living-room on the cabin deck, with wide, breezy passageways separating them.

If a bargain can be found in an old schooner with a good hull, for two or three hundred dollars, a first-class house-boat can be made by the expenditure of as much more for a cabin. The roofs of all house-boats should extend a foot or more beyond the sides of the cabin.

### **For People of Limited Means.**

For people with little money to spend, these expensive boats are as much out of reach as a yacht, but they may often be rented for prices within the means of people in moderate circumstances. At New York I have known a good schooner-yacht, 84 feet over all, to be chartered for two weeks, with crew of skipper and two men, the larder plentifully supplied with provisions and luxuries for six people and the crew, making nine in all, at a cost of thirty-six dollars apiece for each of the six passengers. An equally good house-boat should not cost over twelve dollars a week per passenger for a party of ten. In inland waters, if a boat could be rented, the cost should not exceed seven or eight dollars a week per passenger.

A canal-boat is a most excellent house-boat for a pleasure party, either on inland streams or along our coast.

### **Street-Car Cabins.**

Since the introduction of cable and trolley cars the street-car companies have been selling their old horse-cars, in some instances at figures below the cost of the window-

glass in them ; so cheap, in fact, that poor people buy them to use as woodsheds and chicken-coops.

One of these cars will make an ideal cabin for a house-boat, and can be adapted for that purpose with little or no alterations. All it needs is a good flat-boat to rest in, and you have a palatial house-boat.

## CHAPTER XIV.

### A BACK-YARD SWITCHBACK.

THE back-yard affords an opportunity to build a summer toboggan slide, or its equivalent, commonly known as a

#### “Switchback,”

the difference being that, in place of toboggans, cars are used, and in place of ice and snow you coast down a railroad track.

#### The Wheels

of the back-yard “switchback” car must be made of thick, sound wood, and if there is a wood-working factory in your neighborhood it will save you time and trouble to go there and have the wheels sawed out with the machinery which they have built for that kind of work. But if you must do it yourself, then select a piece of two-inch plank, and after driving a tack in the centre, fasten a string to the tack and attach a soft pencil to the opposite end of the string. With this describe a circle about nine inches in diameter, or measuring about four and a half inches from the tack to the pencil.

With a hand-saw roughly cut out the wheel, using great care to only touch the circle with the saw, but in no case to cut through the circumference. You will now have an irregular wheel, with a number of flat surfaces for its edge (Fig. 123 A).

In this way you may continue to saw off the triangular corners until you reduce the wheel to a condition where it only needs the application of a sharp knife to round the edge until it corresponds with the pencil circle.

CAR WHEEL

Fig 123

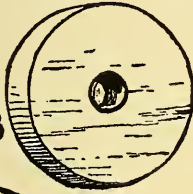

INSIDE VIEW OF FLANGE

Fig 124

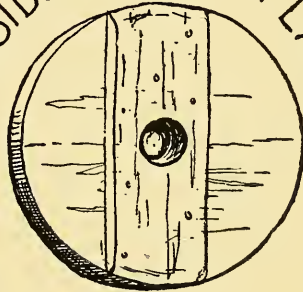

CAR WHEEL WITH FLANGE

Fig 125

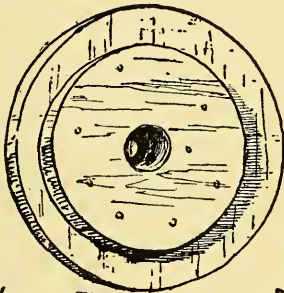

SIDE VIEW OF FLANGED WHEEL

Fig 126

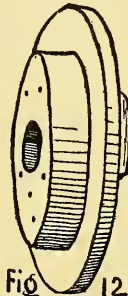

FIGS. 123-126.—The Wheel.

What is called

### The Flange

of the wheel is practically another wheel, made of thinner material (Fig. 124), which is securely nailed to the first wheel (Figs. 125 and 126), with the grain of the wood of the flange crossing the grain of the wood of the wheel proper at right angles. The flange is made of one-inch



board, and to prevent its splitting is reënforced by a strip of wood fastened on across the grain, with screws, as shown in Fig. 124.

When the four wheels are finished, and a hole large enough for a good strong axle is bored in the exact centre of each, you will be ready to begin work upon the car.

### Set the Car-Bed Low.

The smallest boy will understand that the lower the bed of the car is put the less the danger of an upset, so instead of putting the axle, under the car, run them through the bed, as shown by Fig. 128.

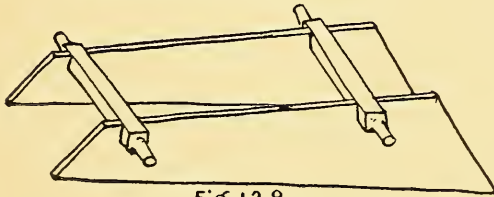
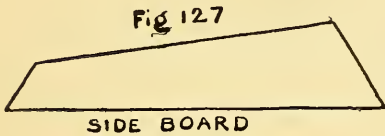

Fig. 128  
FIGS. 127 and 128.

### Build the Axles

of four-by-four timber, and by the aid of a drawing-knife or a good, strong, sharp jack-knife, trim off the ends of the timber to

the form shown in the diagram.

When the ends are small enough to allow the wheels to revolve freely, saw out places in the side-boards of the car (Figs. 127 and 128), into which the square part of the axle will snugly fit.

### The Bottom of the Car

may be made of half-inch boards, which can be joined and nailed on to the car, with their irregular ends protruding, after which, with a hand-saw, cut off the ends even with the side-boards, as in Fig. 129.

Then nail in place the head and tail-boards, and in the same manner saw off their protruding ends, even with the side-boards (Fig. 129). To finish your car it is only necessary to slip the wheels upon the axles. The wheels may be held in place by pegs of hard-wood driven through holes in the hub, made for that purpose, as shown in Fig. 130. You will then have a car, but no track to run it upon. However, if you build the toboggan slide which is described in the next chapter, you may lay rails, made of two-

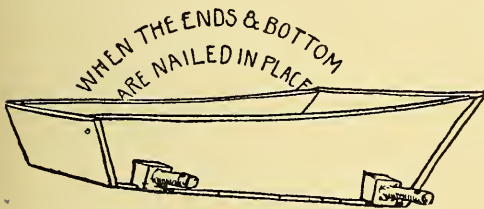

FIG. 129.

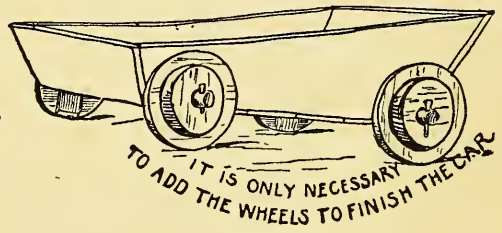

FIG. 130.

by-four timber, down your toboggan slide and thus transform it into a back-yard "switchback."

But if you have no toboggan slide you will have to build a tramway for your car against the back fence, wood-shed, or any other suitable place.

In the diagram (Fig. 135) here given, the slide is shown as it would be if built against the back fence, extending forward through the middle of the yard. But you must have a

### Starting Platform.

You will need four pieces of timber, seven feet long and two inches thick by four inches wide, for the uprights or corner-posts (A and B, Fig. 131), unless the posts and rails of the back fence are on your side of the yard, as in Fig. 132. In this case you need only two seven-foot sticks and two short ones, to fit on the top rail of the fence. The tops of

these short posts should be just seven feet from the ground. Nail them securely in place, about five feet apart, as in Fig. 132, and then see that the fence-boards, to which the posts

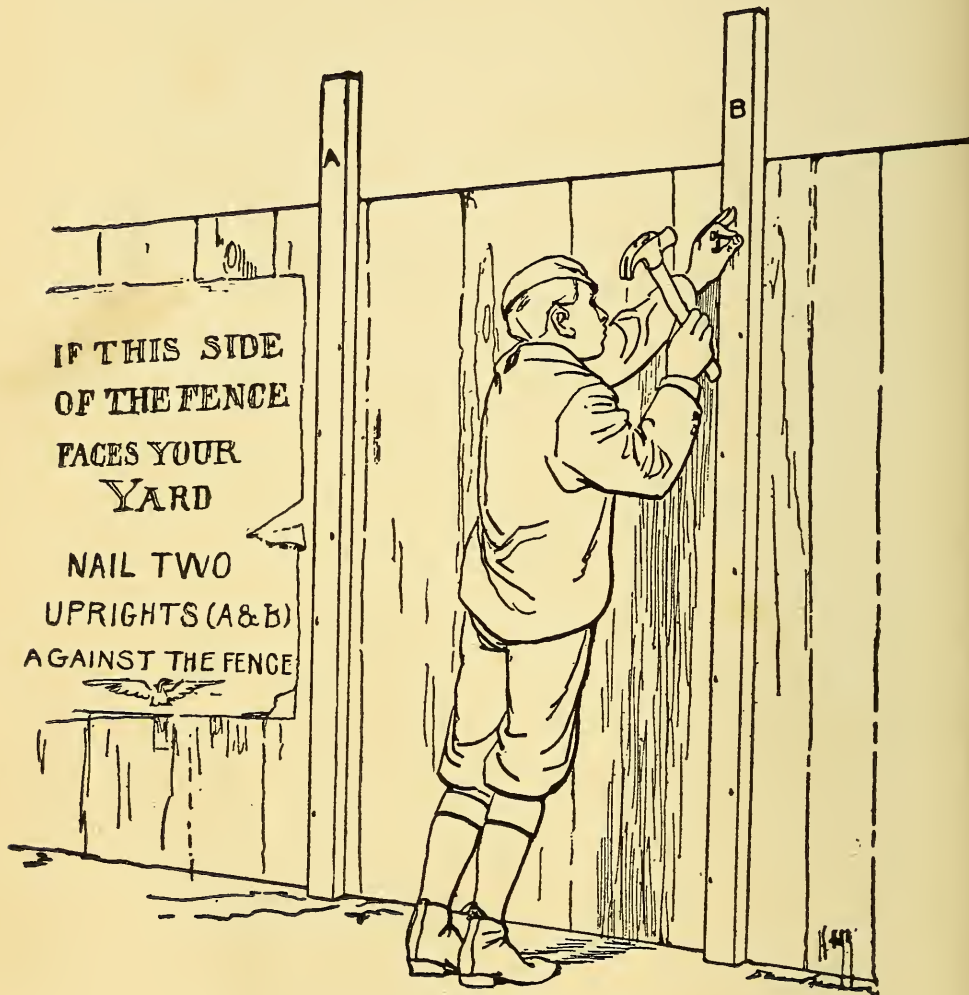

FIG. 131.

are nailed, are secure. If they are not secure, climb over the fence and put in a few good wire nails, for if the fence is not strong your structure will be weak. Additional strength may be gained by making each of the uprights of

two pieces of two-by-four, nailed together, thus making the posts four-by-four.

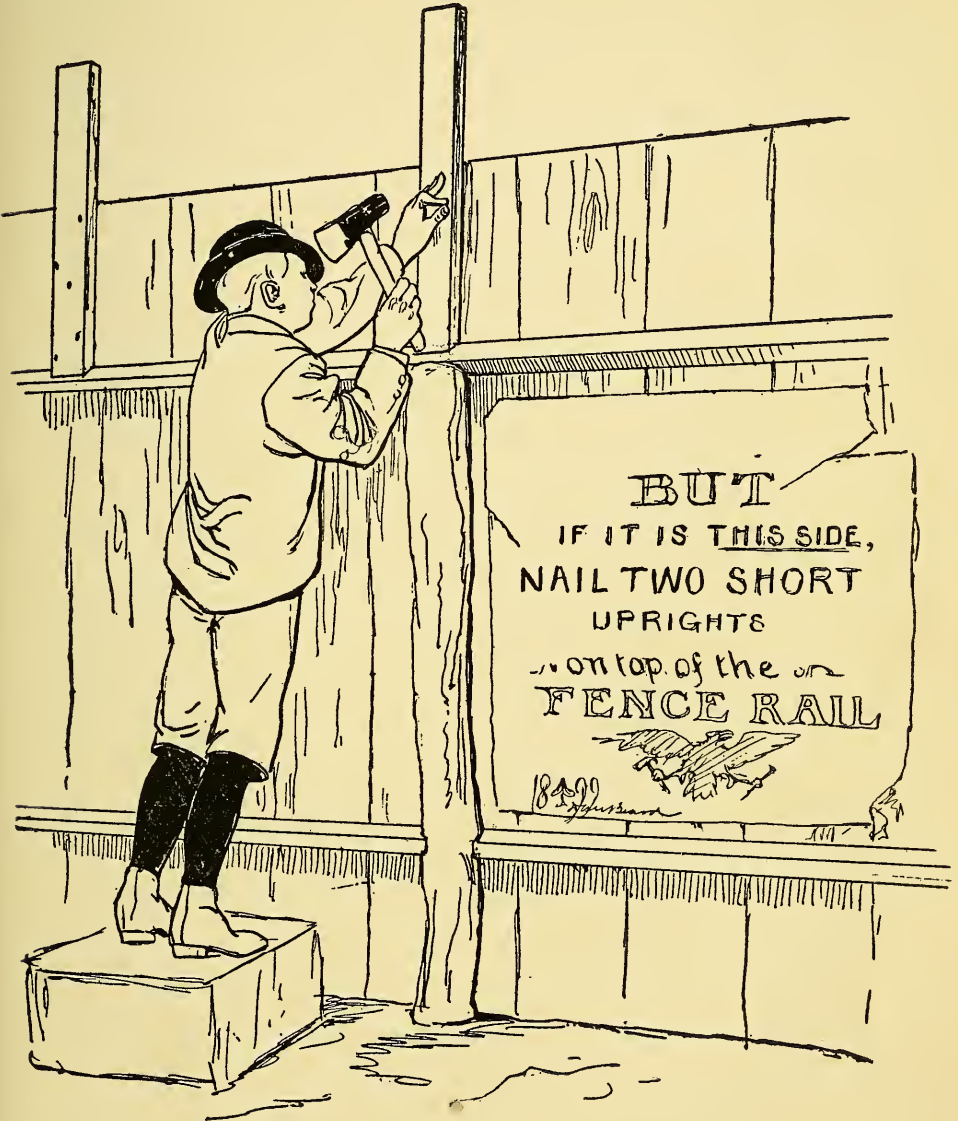

FIG. 132.

It is a good plan to erect one of the posts directly over one of the fence-posts; this will add strength and stiffness



to the structure. If you have any doubts about the ability of the fence to support the platform, erect two seven-foot posts, as in Fig. 131, and spike them to the top and bottom rail of the fence. Next take two pieces of two-by-four and notch them, as E and F are notched in Fig. 133. Nail F to

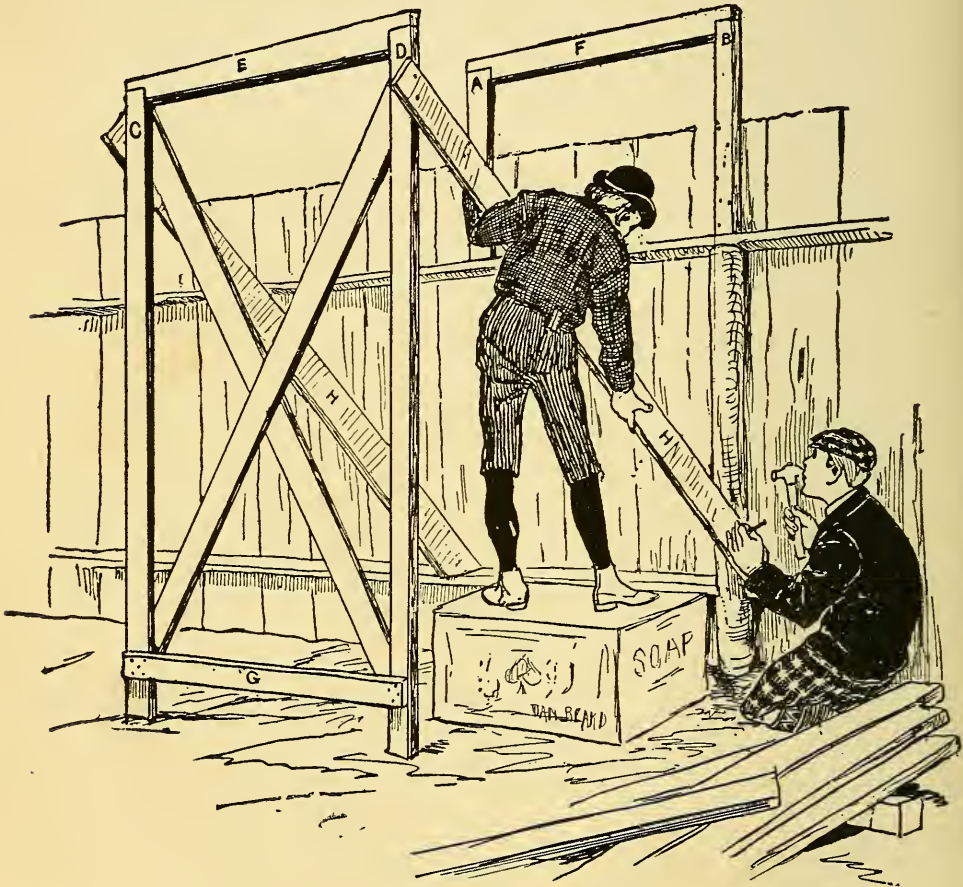

FIG. 133.

the top of A and B, and E to the ends of C and D, the two seven-foot posts of two-by-four. Near the other ends of these last posts nail a cross-piece (G, Fig. 133), and then, to stiffen the frame, turn it over and nail on two diagonal pieces of lighter material.

Erect this frame about five or six feet from the fence and secure it in place by the two diagonals, H and H (Fig. 133),

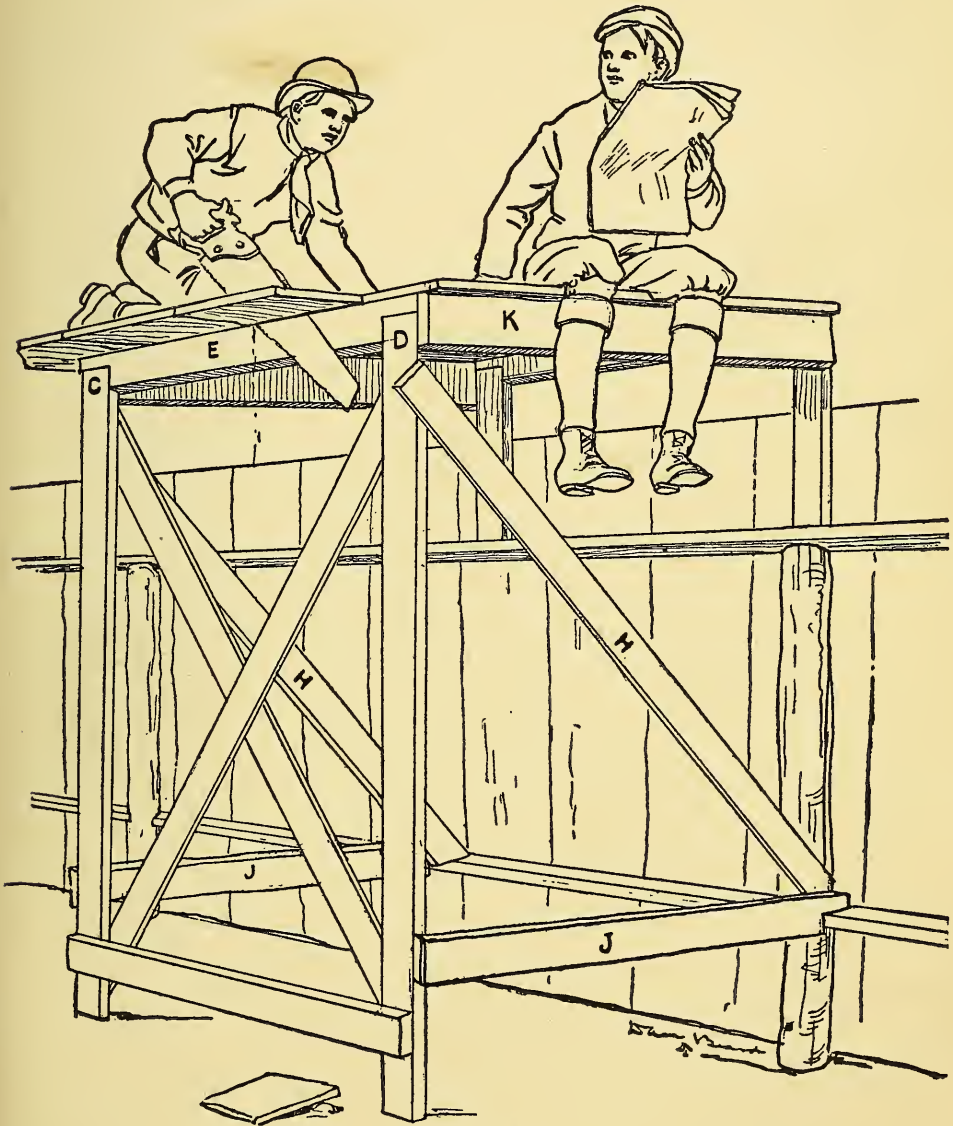
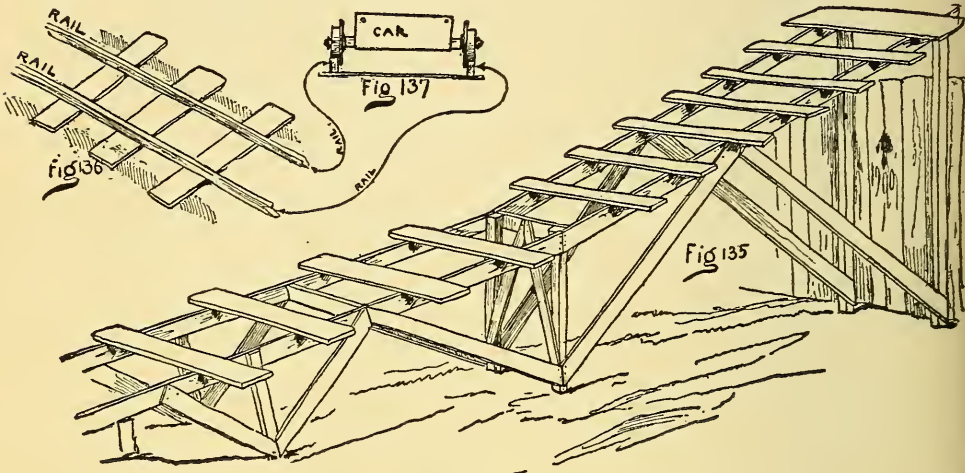

FIG. 134.

which are nailed near the top of C and D, and "toe-nailed" to the bottom rail of the fence.

From the bottom rail of the fence, and level with it, run the two J pieces of board to C and D, and nail them securely, as in Fig. 134; then nail on the two top side-pieces, K and K, and the framework of the starting platform is ready for its floor. Nail boards across the top, from E to F, and saw off the protruding ends, as in Fig. 134.



FIGS. 135, 136, and 137.

### The Track

must be a "straight-away," which means no curves to round, hence you must build it in the position which will give the longest run for your trouble.

### A Curved Track

means more difficult work on the tramway and cars, for the car must have a movable axle in order to be able to round the curve. But with a straight track the play of the wheel upon the hub should allow enough freedom of motion to overcome the little inaccuracy which may occur in the rails. Experiment will teach you just what is needed. I cannot

give exact rules, because the material and location will differ with each builder, and I have found that when I give positive rules, the rules are followed, even when the material and location are entirely unsuited to the directions given. For this reason it is best for each boy to experiment for himself.

### **Erect the Uprights**

first, and brace them with the diagonal boards, as shown in the diagram (Fig. 135). When you are certain the structure is firm and can stand the strain and weight of a loaded car, lay the two-by-four rails upon the ground, and fit them to the car-wheels by pushing the car over them, to see that they are just the right distance apart. If you make your track too wide the car-wheels will slip off the rails and run between them, and if you lay your track with too narrow a gauge the rails will pinch the flanges of the wheels so tightly that the car will stop, or the rails spread.

When one section of the track is laid and it is found that the car runs freely upon it, nail cross-ties of ordinary boards across from rail to rail, like a ladder. Then take the ladder, and turning it over so that the rails are on top (Fig. 136), adjust it to the tramway (Fig. 135), and fasten it securely, by nailing the cross-ties to the side-boards of the tramway.

In Fig. 135

### **The Cross-ties, or Sleepers,**

are put in position, to show how they will look when the track is laid, but in reality the cross-ties must be nailed to the rails while the latter are upon the level ground, as I have already stated.



When each section of track is fastened in place, from the top of the tramway to the ground, and as much farther as your space or lumber will admit, load your car with stones, or some equally heavy freight, and start it down the "switchback."

If the car reaches its journey's end with no mishap, you can with safety get in the car for the next trip and coast down yourself and a jolly good coast it will be.

The plans (Figs. 135 and 136) may be altered so that the car will run down one hill and mount another not quite so high, and many other improvements will suggest themselves to the young civil engineers who build this "switchback," but the first track you erect should be as simple as is consistent with strength and safety, and the improvements left to some future time.

### **Ticket-Chopper's Box.**

You may then take a square box, with a lock and key attached, and bore a hole in one end large enough to admit a good-sized marble; use this as the railroad and ferry-men use a ticket-chopper's box, let every boy who wants a ride drop a marble in the box.

Some thirty years ago a certain boy built a "switchback" in his back-yard, very much like the one here described, and great fun he had with it; but as he was not rich, and the lumber cost him something, he issued a number of tickets at one cent each, every ticket entitling the holder to three rides on the "switchback." In this way he was soon repaid all the expense he had been under during the erection of his wonderful railroad.

This is what that boy told the writer, and as the former young engineer is now no longer a lad, but a grave D.D.,



Under Full Headway.



---

who wears solemn black clothes and preaches long sermons, the writer believes him.

But whether you charge a cent, a marble, or nothing, for a ride, you and your friends are bound to have a rollicking good time on the back-yard "switchback."



## CHAPTER XV.

### HOW TO BUILD A TOBOGGAN-SLIDE IN THE BACK-YARD.

TOBOGGANS and sleds are not always used on snow and ice, neither is coasting confined to winter weather.

At most of the summer resorts you may coast down an artificial hill, upon real toboggans, over a slide of hard-wood rollers, and end with a whoop and a splash in the water of the bathing-pool.

#### Slipperies.

All through the southwestern part of this country the summer drought causes the rivers to subside, leaving more or less high mud or clay banks, which are utilized by the youngsters as mud-slides, and called by them "slipperies." The boys use neither sled nor toboggan, but make a slide by pouring water over the dry mud until they have a long, slippery track, down which they coast, ending with a splash in the river.

#### A War-Time Slippery.

A good many years ago a battalion of Union soldiers were camped on the river-bank, near where some Kentucky boys were having fun on a long slippery, and one day, before the lads knew what had happened, two thousand naked men suddenly made their appearance, jostling each other, for a slide down the mud-track. It was a great sight to

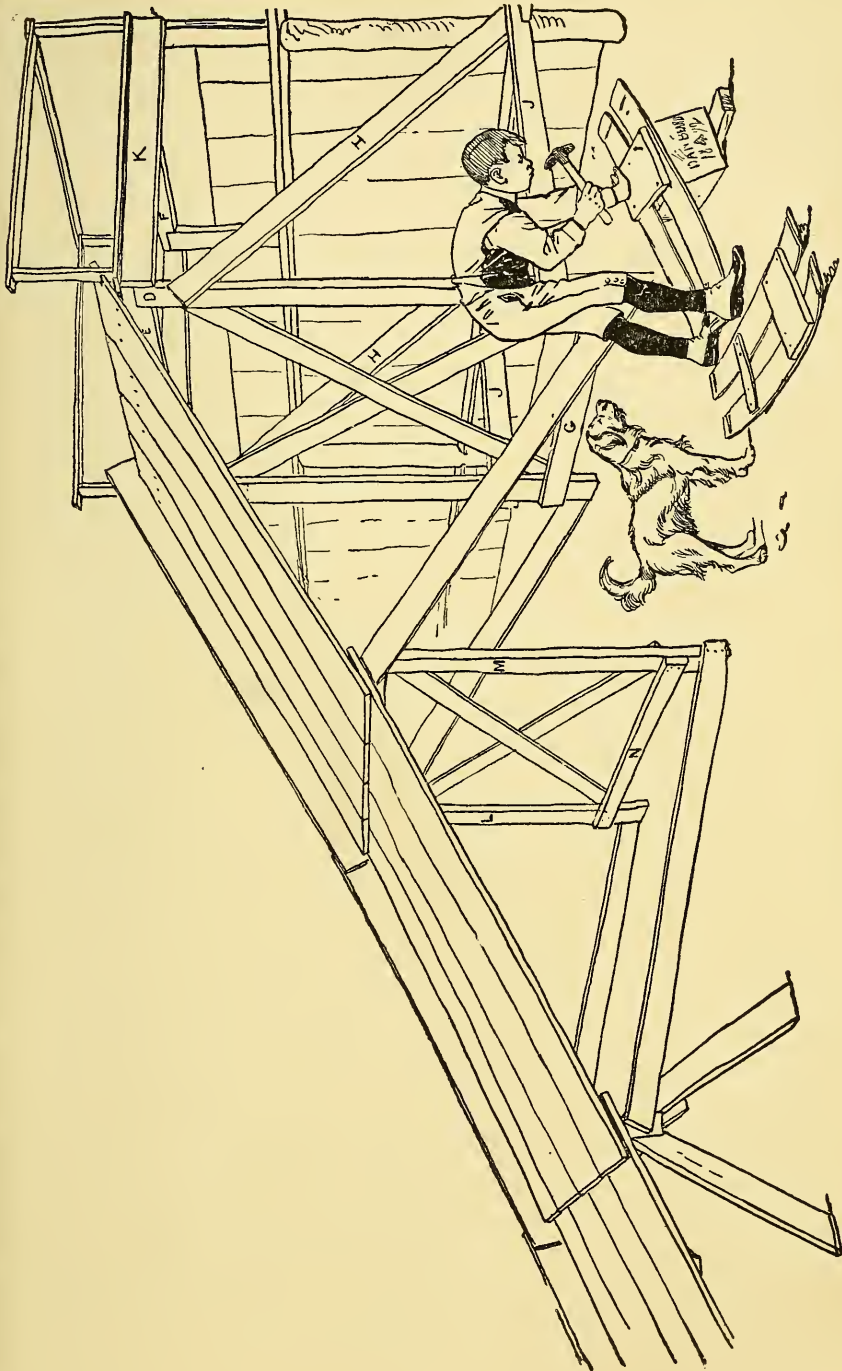

FIG. 138.—The Toboggan-Slide.

see these men-children coasting down the mud-bank, and the show the soldiers made for them repaid the boys for their labor in building the slide.

### **Tropical Toboggan-Slide.**

Under the torrid zone, away out on the Islands of the Pacific Ocean, the natives coast down-hill, in the hottest weather, on the dry grass, and where that does not exist they build themselves toboggan-slides, with slabs of smooth lava. Hundreds of these tracks line the mountain-sides near the native villages. The sled these daring coasters use is from seven to twenty feet long, and as narrow in proportion as a shell-boat, there being only a few inches of space between the very hard, polished wooden runners. It takes both skill and pluck to ride one of these cranky tropical sleds, or toboggans, but the natives possess both of these qualities, and without a thought of failure pick up their primitive machine, take a short, swift run, and throw the sled and themselves together, headlong down the lava-slide. There follows a wildly exciting and breathless ride down the incline, and a scoot over the level country, until gradually the queer sled slows up and comes to a stop; and then there is a long climb back, for another daring coast to the quiet valley below.

In the United States we have no smooth lava with which to build slides on our native hills, and if we did have the lava-slides only a few of our boys would have an opportunity to use them.

When the snow covers the ground it is not every boy who can find a convenient hill where he may enjoy the healthful fun of coasting. A great many boys live in a level country, and hundreds and thousands of others have their homes in cities and towns, where heavy carts, policemen,

and trolley-cars, make coasting a forbidden pleasure. However, with a real toboggan-slide in the back-yard, a boy may snap his fingers at a level country, lumbering carts, death-dealing cars, and meddlesome guardians of the peace.

In a day's time three boys can build a slide; but, of course, it cannot be built without some labor. If it could, it would be of no value. The labor consists only in sawing a few pieces of timber and driving a few nails to hold the frame together, and it is effort well-spent.

### **If Your Back-Yard is Wide**

enough you can run the toboggan-track alongside the back fence, with the starting platform built in the fence-corner, backing against the side fence. In this way your slide will occupy but little space.

### **But if Your Yard is Long and Narrow,**

build your platform against the back fence (as described in Chapter XIV.), and let the track run along one of the side fences.

The most difficult part of the work is now finished. Make

### **A Frame,**

on the pattern of C, E, D, G (Figs. 133 and 134, Chapter XIV.), and about half the height of the platform (see L, M, N, Fig. 138).

Erect this frame in front of the platform, and at such a distance from it as will allow your longest boards to span the intervening space, as in Fig. 138. Nail two diagonals—one at each top end of the frame M, L, N, and fasten the opposite ends of the diagonals to the bottoms of C and D.



Long boards may be laid from the ground to the top of M, N, L, and nailed securely to the frame, and other boards laid over the upper ends of the first, and the top of E, where they can be securely nailed, and the slide is ready for use.

### **The Incline May be Lengthened**

by using a carpenter's wooden horse for another frame, and allowing the boards from the ground to rest on this, and another set of boards run from this to L, M, N, as in Fig. 138, or as described for the switchback, in the preceding chapter.

With plenty of snow on the ground it will not hurt a strong boy to fall from this track. But there may not be much snow on the hard, frozen ground, or your little brothers and sisters may be fond of coasting. To prevent any mishap, a guard-rail, such as is shown on one side of the slide in Fig. 138, should be nailed on each side of the inclined plane, as shown in the diagram.

The posts for the railing around the platform are "toe-nailed" to the floor, and the rail is nailed on top of them. In case the rail seems weak, a diagonal or two, like those on the slide-frames, will make it sufficiently strong.

### **A Toboggan Room.**

By boarding up around the posts, under the platform, a small room will be made, at a trifling additional cost and labor, which can be kept warm, and will afford a means of shelter and a place to lock up the sleds.

An excellent plan for

### **"Packing" the Slide, or Chute,**

is to mix sawdust and snow together, in equal parts, using just enough water to cause it to pack solidly, as a founda-

tion for the top crust of snow or ice. This foundation will make the top ice or snow last much longer, in thawing weather, than it would if spread directly on the wooden bed of the slide. If the snow in the chute is properly and smoothly banked up on this composition foundation, moistened and frozen hard, with the addition of half an inch of fresh snow on top, the slide, in ordinary weather, will last all winter.

### **It is a Wise Plan**

to be ready for any emergency. You may have visitors who come without sleds, and who would have but a chilly time watching the others coast down the wonderful toboggan-slide. To prevent the chance of any such disagreeable occurrences, knock an old barrel to pieces and build yourself a supply of toboggans with the staves. Two barrel-staves, fastened together by a cross-bar in front and a piece of board for a seat in the rear, will make a most excellent toboggan.

The boy in the foreground of Fig. 138 is building toboggans of barrel staves, and a glance at this cut will tell you how they are made.



**PART II**

**RAINY DAY IDEAS**





## CHAPTER XVI.

### A HOME-MADE CIRCUS.

To the typical American boy every object he sees suggests to him possibilities of amusement, and to him an up-to-date bath-room is as full of such suggestions as a dictionary is of words. The great white tub affords an excellent sea for his gun-boats to do battle upon, or offers a straight-away course over which his home-made yachts may sail, while a fan fills their sails with everything from a light breeze to a ripping gale.

What boy has not discovered, for himself, that

#### **The Bath-tub is a Splendid Receiving-Tank**

for the occasional water-animals captured by him in creek or pond, or at the fish-market?

The laundry tubs are also useful and, not being in demand as frequently as the bath-tub, are for this reason often more convenient.

If the grown people would only let the bath-room alone, there is no end to the fun which an ingenious lad could have in that useful little room.

#### **As a Lake for His Fleet,**

and as a receiving-tank for his water-pets are only two of the uses which the bath-tub suggests to a bright boy. When he sees the faucet he realizes that this can afford him

power for all sorts of machinery, if he can arrange a water-wheel under it to transmit the power.

Every country boy knows how to make water-wheels, and every summer the springs and brooks all over the land turn these little wheels in exactly the same manner which the larger streams turn the big wheels for the factories and mills on their banks.

But there are thousands of boys in our great cities who have never seen

### A Water-wheel,

and for the use of these boys the accompanying illustrations were drawn.

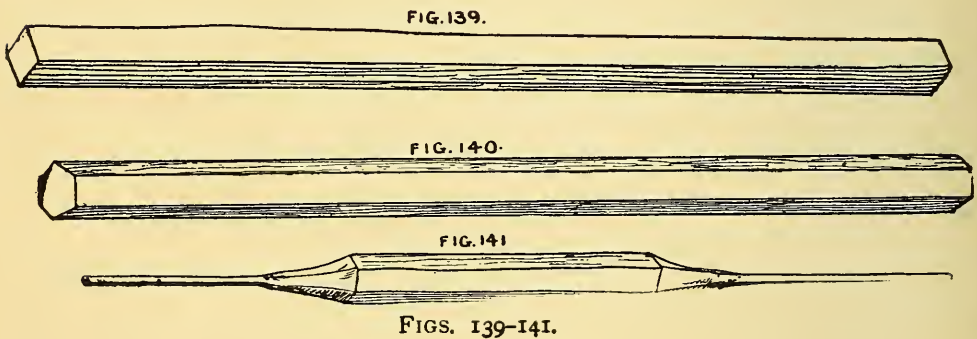

Fig. 139 shows a four-sided soft-pine stick, with square ends, and if you have a good sharp knife it requires but little work to trim off the four edges of this stick until it has the form of a six-sided lead-pencil (Fig. 140), after which but little skill is required to whittle the ends down to the size of the hole in a thread-spool (Fig. 141).

### The Shaft.

You will see, on examining the illustration, that the middle is left with the six sides untouched.

### An Old Cigar-Box

will not only furnish you with excellent wood for the paddles of your wheels (Fig. 142), but, if carefully taken apart, it will also furnish you with just the right sort of nails with which to fasten your paddles to the shaft.

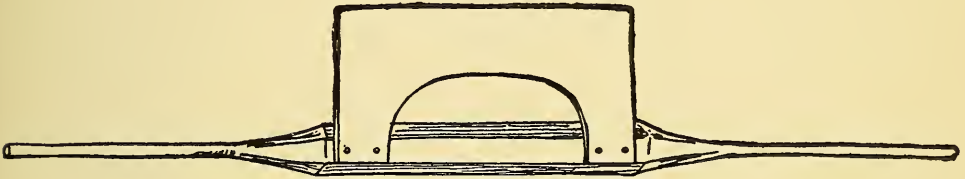

FIG. 142.

### Make Six Paddles,

all of the same size and same pattern, and nail one to one of the six sides of the shaft (Fig. 142).

Turn the shaft around to the next face or side, and nail

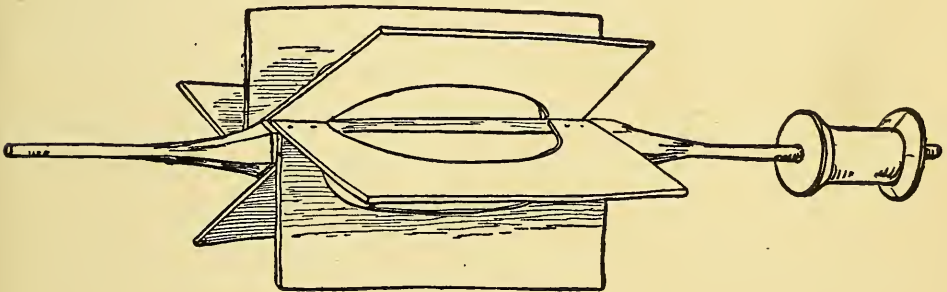

FIG. 143.

another paddle in place ; continue this work until you have the paddle-wheel shown in Fig. 143.

On to one or both ends of the shaft you may now slip wooden spools, pushing them up the stick until they fit tightly, and leave a projecting end of the shaft sticking out of the end of the spool.



**Hanging-Bars.**

Next take a lath or stick of some kind, which is of such length that it will rest securely when laid across from side to side of the bath-tub. To this stick tack two others, as shown in Fig. 144.

These hanging-bars must be long enough to allow the water-wheel to be suspended just below the faucet of the bath-tub. Strengthen your hanging-bars (Fig. 144) by two diagonal pieces.

Fig. 145 shows how to cut a notch near the lower end of

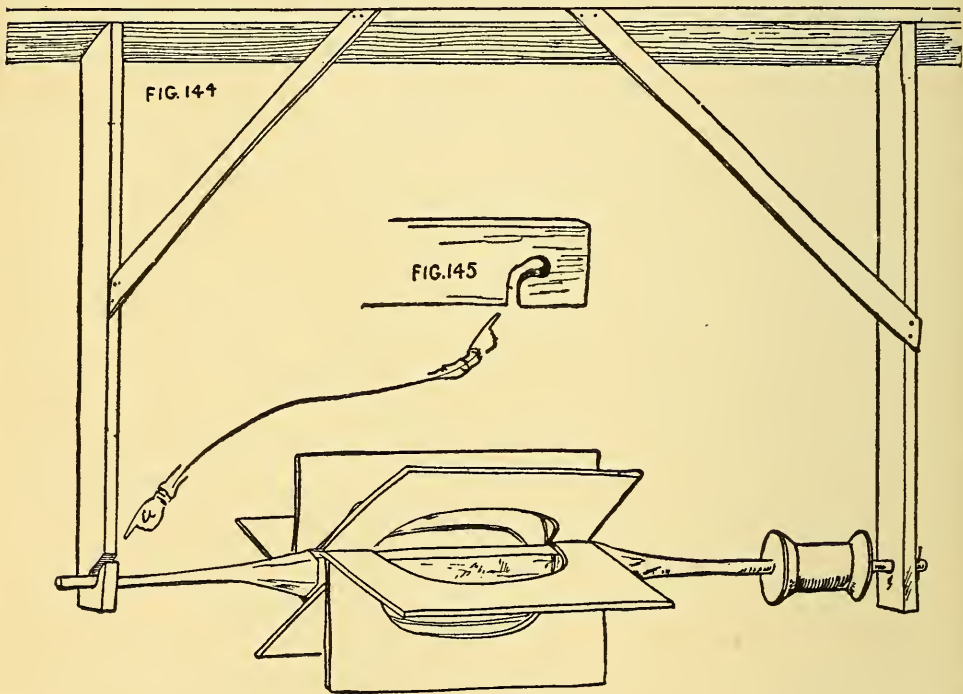

FIGS. 144 and 145.

one hanging-bar, and a hole is bored near the end of the opposite hanging-bar.

To adjust the wheel, place the top bar across the bath-tub and then slip the shaft in the hole in the hanging-bar,



FIG. 146.

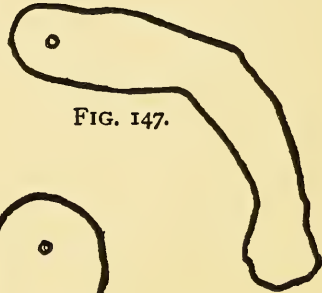

FIG. 147.

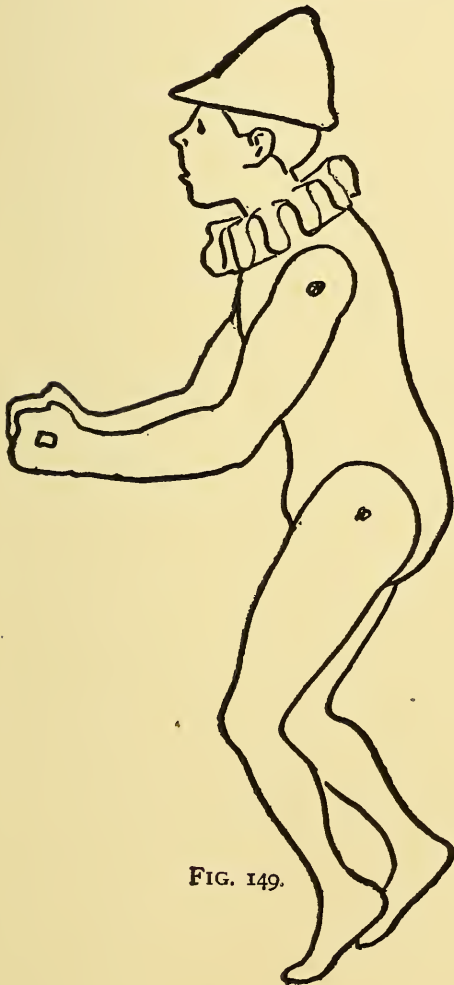

FIG. 149.



FIG. 148.

sliding the other end of the shaft into the slot shown in Fig. 145.

If the water is now allowed to run slowly from the faucet and fall upon the inside paddles it will set the

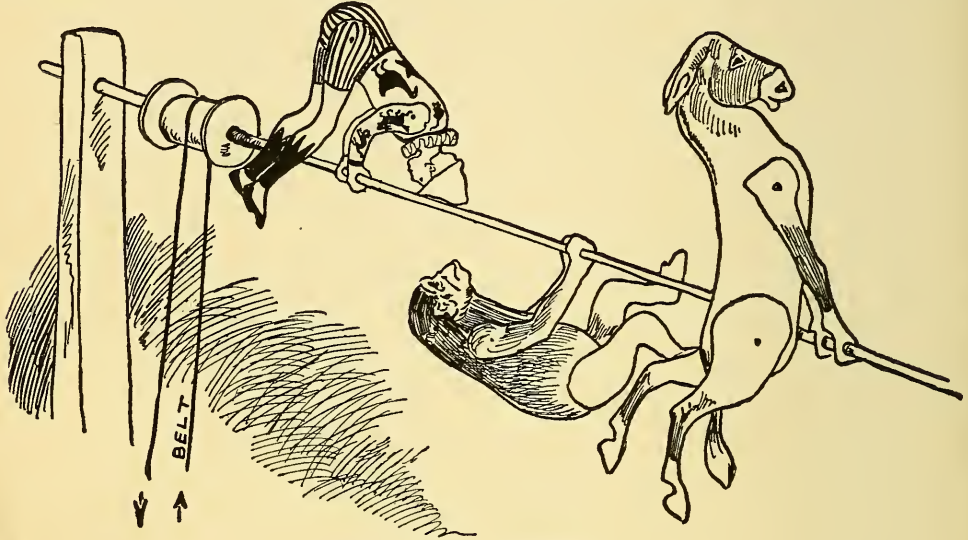

The Circus Performers.

wheel in motion, and this motion can be transmitted to any small and simple piece of machinery by means of a belt running from the spool which is attached to the wheel to a similar spool, attached to the machine.

### If you Make a Frame,

similar to that which holds the water-wheel, (Fig. 144) and make it with much shorter hanging-bars, it will not be necessary to support them with the diagonal pieces. This second frame can be reversed over the first frame, so that the hanging-bars will set upright upon the cross-bar, and when in that position a small horizontal bar may be made to revolve by connecting a spool placed upon this bar with the spool upon the wheel-shaft, by means of a string loop. If this string is not too loose, nor yet too tight, it will turn

the top spool as soon as the water sets the wheel and the bottom spool in motion. The illustration on page 196 shows how a number of funny animals and men can be made to do circus tricks on the bar, to the great delight of the spectators.

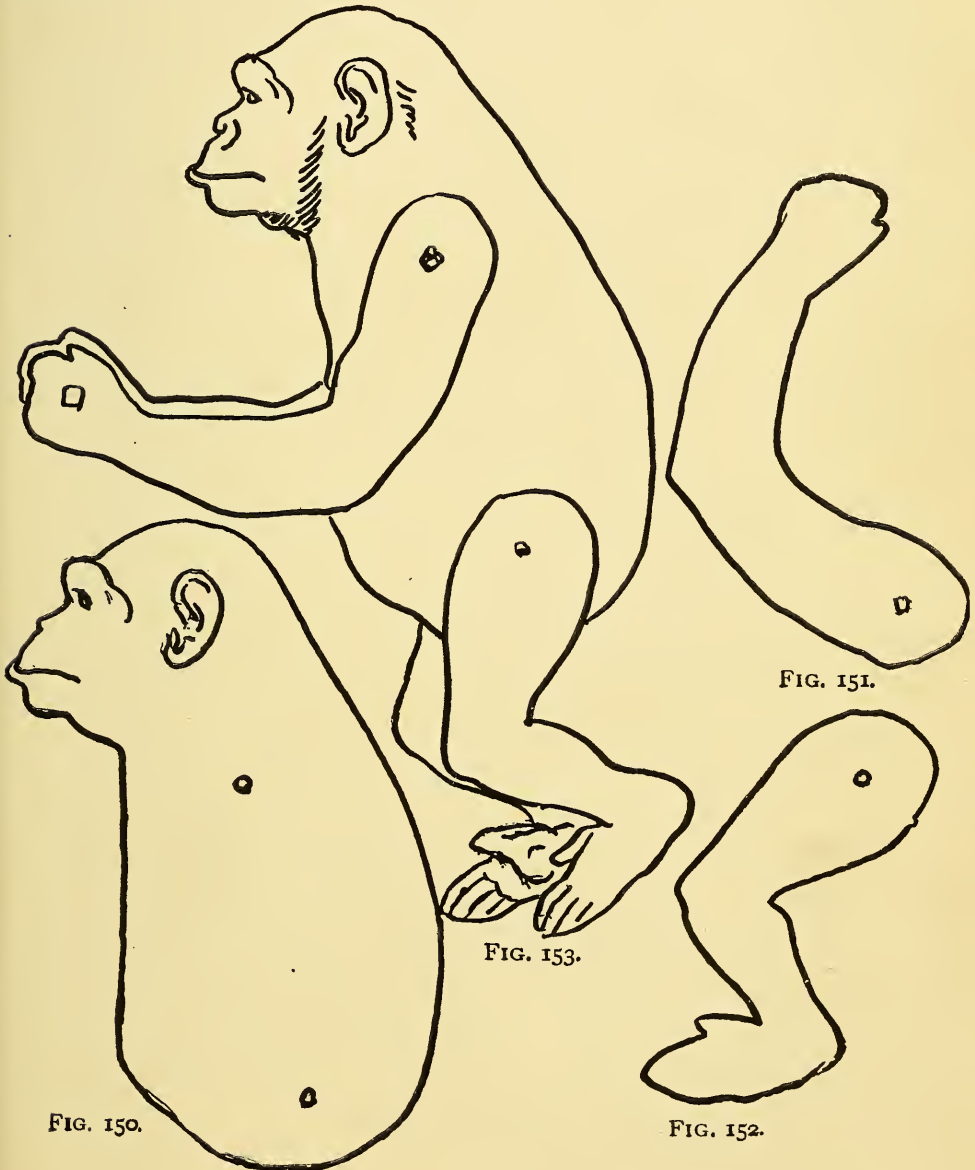

FIG. 150.

FIG. 153.

FIG. 151.

FIG. 152.



### Figures Which Move.

To make these figures so that they will move with comical, but natural, movements, place a piece of transparent paper over the diagrams and trace the outlines, then blacken another piece of paper, upon one side, with a soft pencil; next place a piece of clean card-board under these figures, over the card-board spread the paper, with the blackened side next to the card-board, and over this put the tracing paper, and then, holding it so that it will not slip, follow the lines of the clown, ape, and donkey, with the point of a hard pencil. When the card-board is removed the bodies of the clown, ape, and donkey will appear traced upon the white surface.\*

In the same manner make tracings of the legs and arms of the puppets, and with your scissors cut these figures out. Using the legs and arms cut from the card-board as patterns, trace around each of them upon another piece of card-board with a pencil, and cut these duplicates out. You will now have two each of Figs. 147, 148, 151, 152, 155 and 156.

With the point of your hard pencil, or a darning-needle, punch holes in all these parts, at the points marked by black dots.

Next take a small piece of string and make

### A Neat, Round Knot

in one end of it, and thread the other end through the clown's arm, at the dot in his shoulder; then thread the string through the dot in the clown's body, near his collar (Fig. 146). Now thread through the hole in the shoulder of the duplicate arm. When this much is done, place the

---

\* Another plan is described in Chapter XXIV.

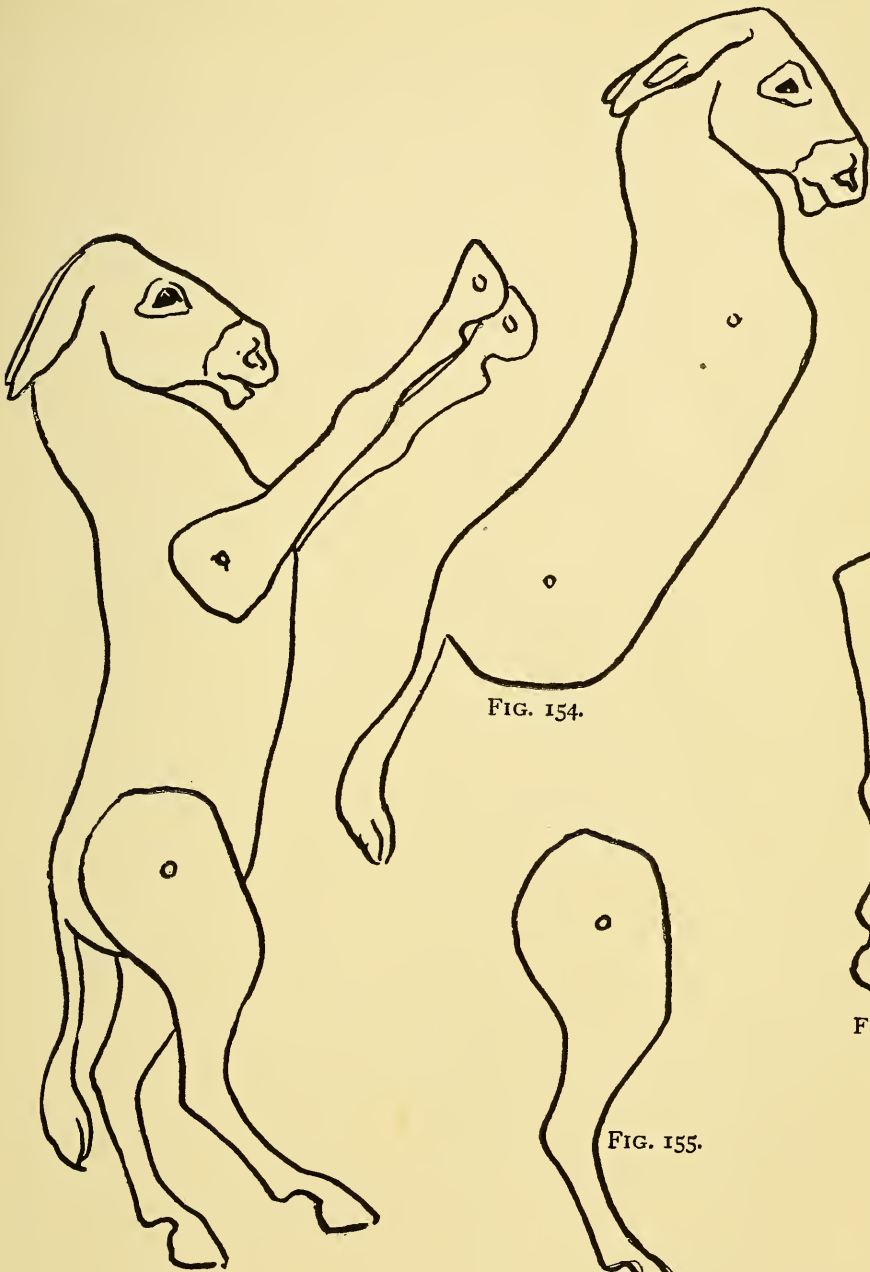

FIG. 154.

FIG. 156

FIG. 155.

FIG. 157.

FIGS. 154-157.

clown upon a table, with the knot underneath, and drawing the string up, while holding the clown's body down with your other hand, bring the knot snugly against the lower arm and tie another knot tightly against the upper arm. This last knot can be made by making a large loop, and then holding the string in place with one finger until the knot is slid down against the pasteboard arm and drawn tightly in place; a second and third knot, tied over this, will make it large enough for the purpose, and the arms will be found to move freely, up or down (See Fig. 289, Chapter XXIV.).

Attach the legs in the same manner; if you will now thrust a small stick through both the clown's fists you can make him take all the positions of a trained circus-man, by twirling the horizontal stick between your fingers.

When the water-wheel sets the bar twirling, the donkey, ape, and clown go through their "stunts," in a most laughable manner.

## CHAPTER XVII.

### GOOD GAMES WITH TOOTHPICKS AND MATCHES.

THE genuine American lad needs no costly toys with which to amuse himself, for he has inherited from a long



FIG. 158.—Rainy Day Fun.

line of pioneer ancestors a sturdy self-reliance. When the inclemency of the weather, or some slight illness, confines



him to his home, he can pass away the time with toys of his own construction.

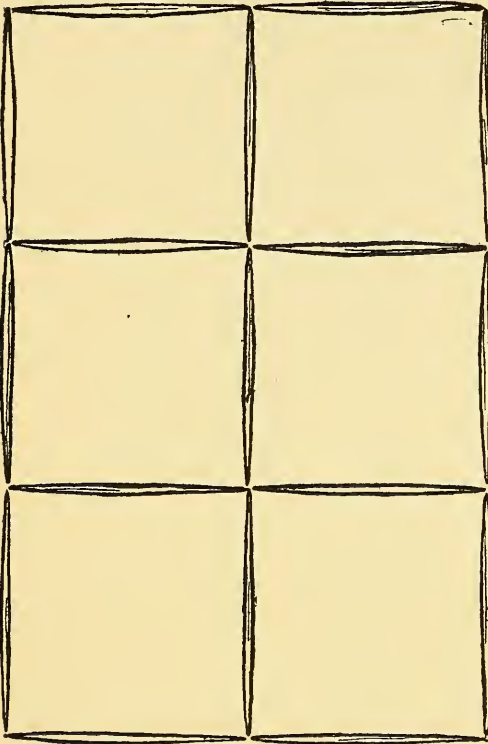

FIG. 159.—Toothpick Puzzle.

the younger members of the family are, consequently, confined indoors, with their youthful jaws tied up in bandages. If they have no ingenuity they will be fretful and annoying to their parents and themselves, but if they have inherited true Yankee grit and invention they will spend their enforced imprisonment in a very jolly manner.

**A Toy is a Plaything,**  
and a plaything is any old thing which chance throws in our way, with which to play.

### Wooden Toothpicks

offer many opportunities for amusement. I have seen grown men, in the reading-rooms of our great hotels, amuse themselves and companions for hours with only a handful of wooden toothpicks.

Suppose that mumps have invaded the household, and

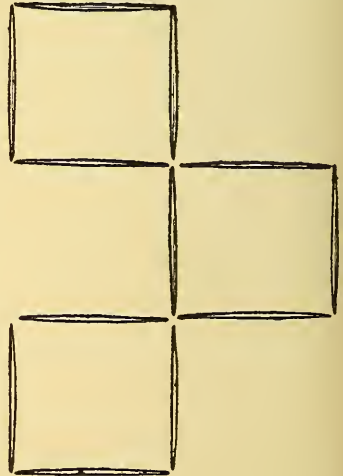

FIG. 160.—Solution.

the rocky crags, made of spelling-books, arithmetics and dictionaries; or you may be startled from your sleep by the crack of a match-gun and the answering boom of a spool-cannon; but these things will only make your sleep the more peaceful and refreshing.



FIGS. 175 and 176.—The Toothpick Bridge.

## CHAPTER XVIII.

### FUN WITH SCISSORS AND PASTEBOARD AND PAPER.

IN winter there are always some blustering, windy days, when the raw winds from off the ocean howl through our streets, making the lives of pedestrians miserable; or days when slush and sleet cause us to wish that we could stay in the house until winter was packed away in last year's almanac.

During such weather there is no fun to be had outdoors, and we must look for our amusement inside the four walls of our homes.

It is not every city boy who has an old-fashioned attic to romp in during bad weather, nor even a basement where he can seek to amuse himself building sleds or other outdoor appliances, for use when the weather will permit.

Many lads are confined in the narrow rooms of flats, and must needs fret and worry when the bad weather imprisons them in their narrow home-quarters:

But if such boys will stop quarrelling among themselves, and cease for a moment teasing the cat, or in other ways adding to the worries of their dear mamma, they may, by following the directions given here, find amusement and fun—not only for this particular bad day, but for all the stormy weather of the winter.

**How to Make the Sleigh.**

Fold a card or a piece of card-board in the middle, and with a pair of shears cut a curved piece off one end, as in Fig. 177.

Now take a sharp penknife and cut along the black lines

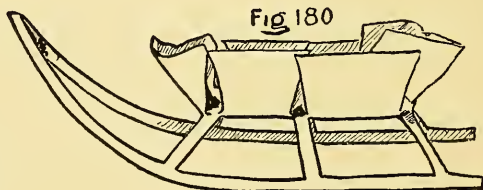
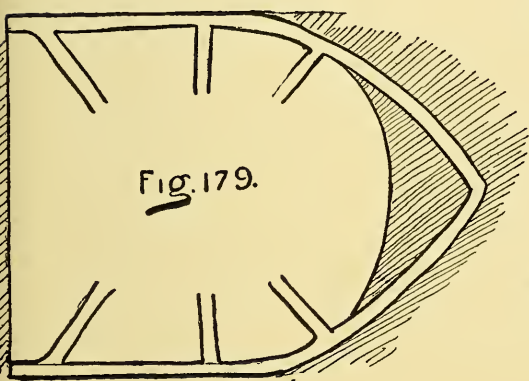
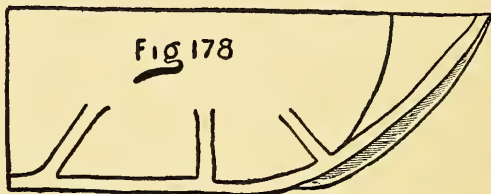
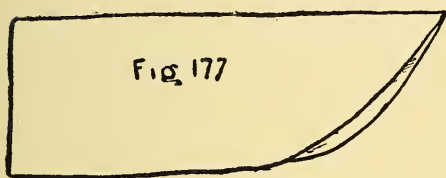

FIGS. 177-181.—The Card Sleigh.

of Fig. 178. When you spread out the card you will have Fig. 179, and if you bend up all the flaps and bend down the runners, giving the latter a pinch where they meet in the centre, you will have as dainty a little sleigh as old Santa Claus ever owned (Fig. 180).

The seats to the sleigh are simply made, being two strips of card-board with the corners bent down (Fig. 181).



**How to Make the Horses.**

The horses are more difficult to make, especially for boys who do not know how to draw a horse; but if such

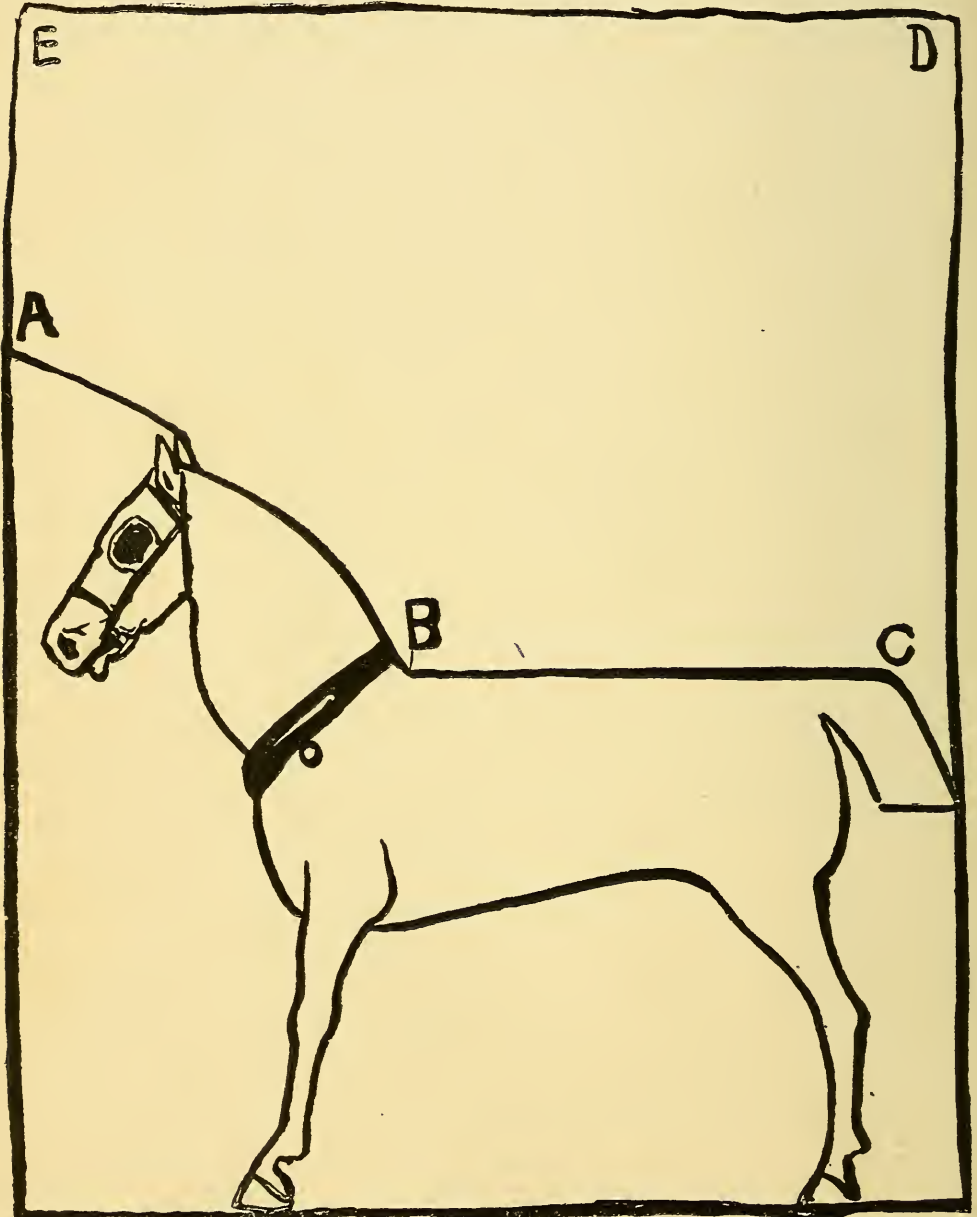

FIG. 182.

youngsters will read the preceding chapter it will tell them how to make a tracing, and they may make an exact reproduction of this horse by reversing the tracing and placing a clean piece of card-board underneath it, and then, with a lead-pencil, drawing over all the lines as they are in the illustration. When the card-board is removed they will find a faint outline of the horse upon the card-board.

### To Cut Out the Horse,

commence at A (Fig. 182), and cut down to B; then fold the card-board carefully along the line of the back of the horse, BC.

BC will now be the top fold and ED will be down to the feet of the horse, while AB will stand up above the back, because AB has not been folded.

The rest is not hard work, for any child can follow the outline with the scissors, and the result will be a paper horse with four legs, upon which it can stand (Fig. 183).

Figs. 184, 185, and 186 can be traced in the same manner as the horse, and afterward cut out, leaving a pointed piece of card-board hanging down, which we stick through slits cut in the seats (Fig. 181), and in this manner make the driver and the passengers sit firmly in the sleigh.

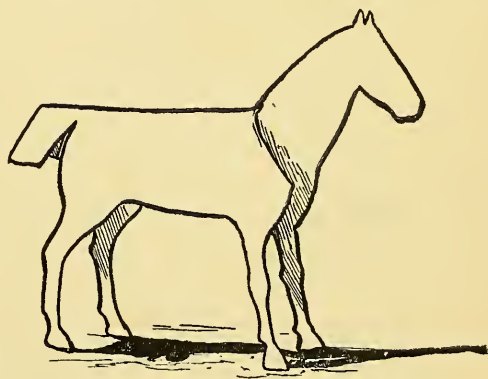

FIG. 183.—The Paper Horse.

### The Tongue, or Pole.

A small, smooth stick will answer for the pole to the sleigh, and it may be fastened with a piece of thread to the

FIG. 184.



FIG. 185.



FIG. 186.



FIG. 187.

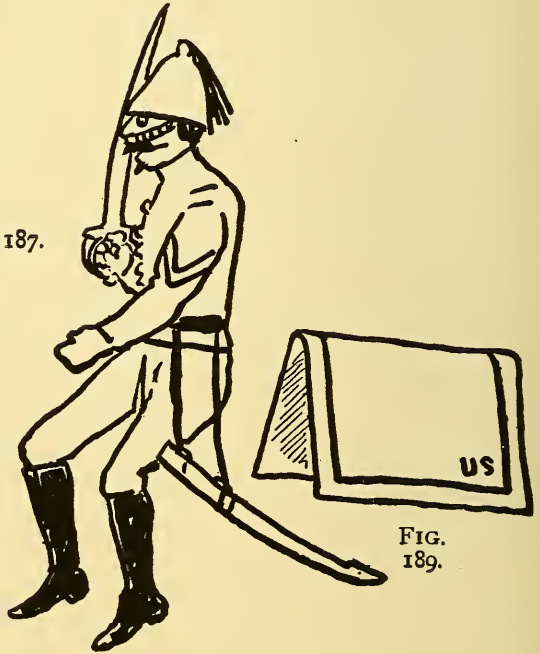

FIG. 188.

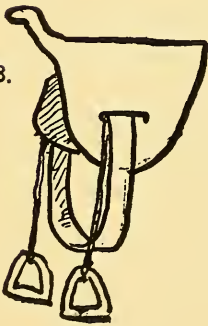

FIG. 189.

centre of a wooden toothpick which has been previously thrust through the front runners of the sleigh, as in Fig. 191. The harness and reins are simply strings tied to wooden whiffletrees and run through holes punched in the horses at the proper places.

A broom-straw, pushed through a hole in the driver's hand, will do service for a whip, and you may now have a grand spiked team of five horses, if you choose to make that number, or a simple two-horse or even one-horse sleigh, as you may choose to make it: the number of horses being limited only by the industry of their creators.



FIG. 190.

### The Pasteboard Soldiers.

For a bold soldier man, make the horse just as you made the sleigh horse, but a cavalryman needs a saddle, and if you cut out the protruding front of the saddle first and then

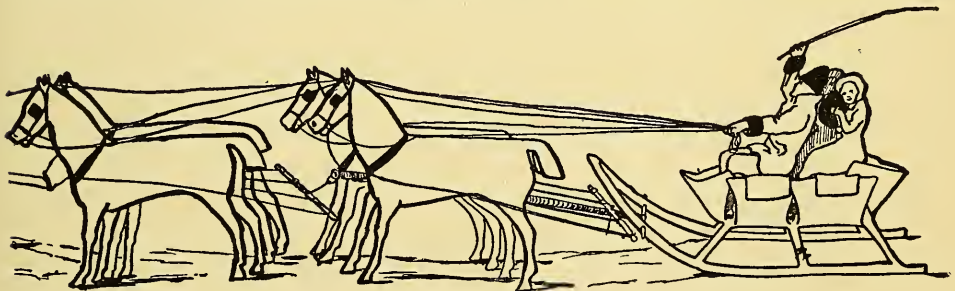

FIG. 191.

fold it as you did with the horse, you may make a saddle similar to Fig. 188. The girth and stirrups are put on after the saddle is cut out, the girth being a band of ribbon run



through slits in the saddle and fastened around the paper horse.

### The Stirrups

are cut out of card-board, and fastened to the saddle with short strings. The saddle-cloth, Fig. 189, is a piece of paper, folded as shown in the diagram.

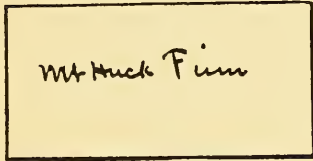

192



193

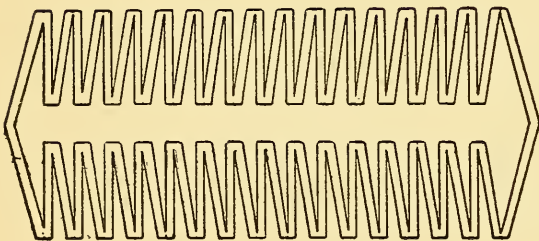

194

Trace the soldier, Fig. 187, in the manner already described, then cut him out and set him upon his saddled charger.

Make reins of string and run the string through a hole punched in the horse's mouth—where the bit should be—and through a hole punched in the soldier's hand. Put the cavalryman's feet in the paste-board stirrups and you have Fig. 190—a bold soldier man, ready for

a parade, or to fight with the English or against them. In fact, so perfect a soldier and

### Such an Ideal Soldier

is this pasteboard man, that he will never question your orders, but fight on any side you choose to put him, and when he is worn out in the service he will utter no complaint if he is buried in the waste-paper basket, or even used for the purpose of kindling the kitchen fire,

**Make an Army.**

If you are successful in making one soldier, with industry you may make a whole regiment of them, and then stand them in battle array and shoot them down with a pea-shooter.

Your conscience need not bother you in the least, if you slay a whole regiment, for the poor fellows won't care a cent, and they will leave no widows and orphans behind to mourn for them. In fact, you can bring them all to life again, the next time you want a battle, by simply setting them upright upon their horses once more.

It sometimes happens that boys tire of soldiers and their murderous weapons, although both the soldier and his arms be but harmless paper.

At such a time the reader can put away his paper warriors and proclaim to his play-mates that he is a wizard, and can

**Walk through the Centre of a Visiting Card.**

He may prove that this is no vain boast by folding the card, Fig. 192, across its centre (Fig. 193), and with scissors cutting slits where the lines are drawn on Fig. 193.

When the card is unfolded it will be found to resemble

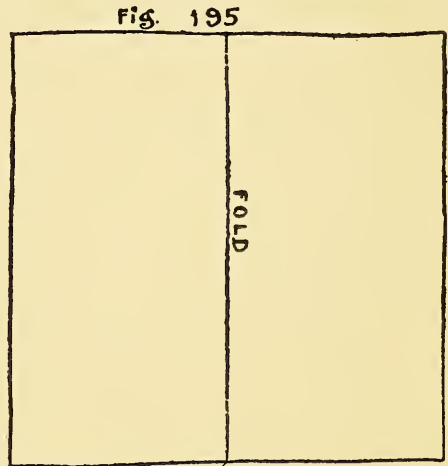

Fig 196

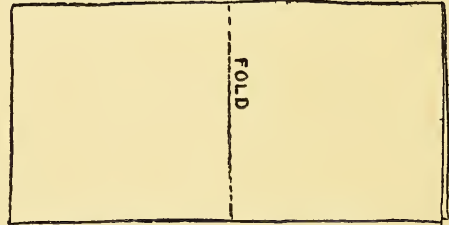

Fig 198

Fig 197

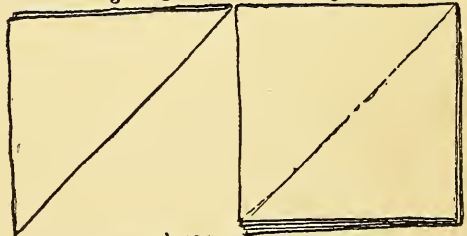

Fig 199

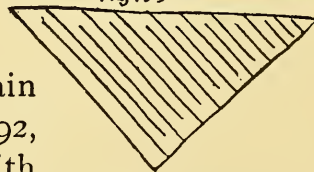

Fig. 194, and may be stretched carefully until it can be passed over the head, down over the body to the feet; then as the self-proclaimed wizard steps out of the card he may truthfully say that he has walked through a visiting card.

After this he may entertain his playmates by making a



FIG. 200.

### Grandmother's Reticule

of a square piece of paper (Fig. 195), which he folds at the dotted centre line (Fig. 196), and folds again across its centre (Fig. 197). The next fold is a diagonal one, from corner to corner (Fig. 198).

With the scissors he cuts Fig. 198, as shown by the ruled lines on Fig. 199.

Carefully unfolding the paper he puts a marble or some other weight in the centre, which stretches the paper to the form of a paper reticule, Fig. 200.

Speaking of grandmothers reminds us of old times, when above the open grate fireplace the mantel and panelling was painted a sombre black.

The boys then used to amuse themselves by folding pieces of paper in the form of Fig. 198, and then cutting

### “Any Old Thing”

out with the scissors—the result being that when the

paper was unfolded the meaningless "thing" resolved itself into a beautiful geometrical pattern, which showed to great advantage when stuck upon the black wood-work of the mantel.

Benjamin Franklin, Benjamin Harrison, and Thomas Lynch, Jr., were appointed a committee by the Continental Congress to design a national flag for the baby United States, and you all know that in the little old house, 239 Arch Street, Philadelphia, Betsey Ross made the

**First American Flag.**

You have also probably read the legend so frequently published, which tells us that the stars in the original design were six-pointed, and were only changed because some one showed how

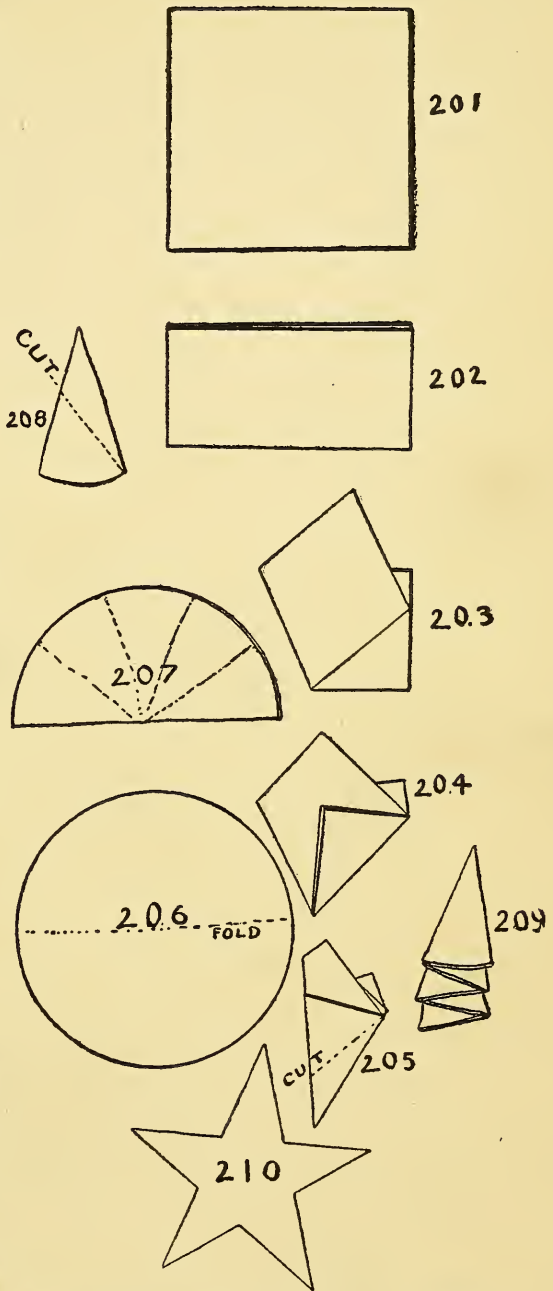

FIGS. 201-210.—Two Ways to Cut a Five-pointed Star.



**To Cut a Five-pointed Star with One Clip of the Scissors,** by folding Fig. 201 in the form of Fig. 202, and folding the latter in the form of Fig. 204, again folding in the shape of Fig. 205, and then making a cross-cut at the dotted line. When the paper was unfolded it appeared in the form of Fig. 210, a five-pointed star.

**Another Way to Cut a Five-pointed Star,**

is to fold a circular disk of paper (Fig. 206) across its diameter (Fig. 207), and fold this in the form of a fan (Fig. 209),

which when pressed down flat will be Fig. 208. One cut, where the dotted line is shown on Fig. 208, will produce the five-pointed star (Fig. 210). If, as according to the legend, it was because of the simplicity of this one clip of the scissors that the five-pointed star was adopted, the old legend needs revision, for

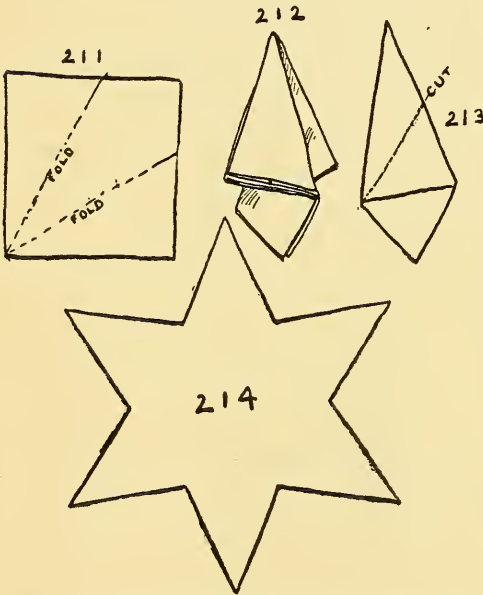

FIGS. 211-214.—A Six-pointed Star, with One Cut.

**A Six-pointed Star can be made with One Cut,**

with no more trouble than it takes to make the five-point.

Fold the paper as in Figs. 195, 196, and 197 (see Reticule). Fold the form (Fig. 197) fan-wise, at the dotted lines on Fig. 211, making the divisions equal (Fig. 212). Press the folds down until they are flat (Fig. 213), and make the cut at the place indicated by the dotted line. When the paper is unfolded you will have the six-pointed star, Fig. 214.

This is the star of the East, which guided the wise men to the lowly manger—the Star of Bethlehem, a grander and better symbol than the irregular five-pointed star. The six-pointed star stands for Peace on Earth, Good Will to Men. The magicians of old called the six-pointed star the “pentacle” of Solomon.

One of the oldest and most venerated symbols is

**The Cross,**

and if you make one of the proportions of five squares, each of the three arms of equal size, and equal to the square space in the middle, you may, by

**Two Cuts, make the Cross into a Square.**

This will, at first glance, look like an impossibility, but if you find the middle of the top end of the cross (Fig. 215), and lay a straight-edge from the middle point E, touching the corner F, and rule the line E F G, then rule a line from H to F, and cut where the lines are ruled, you will have four irregular pieces, A, B, C, and D, which you may fit together in the form of a square (Fig. 216).

This is amusement enough for one rainy day, and for the next one you may try something more artistic, and consequently more difficult and interesting.

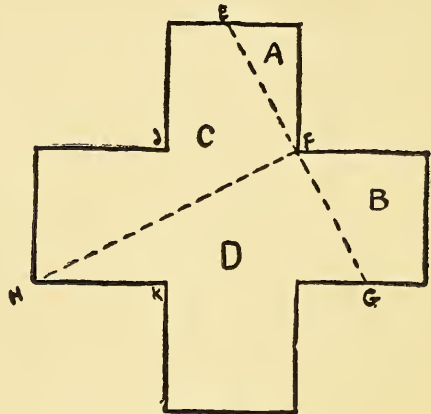

FIG. 215.

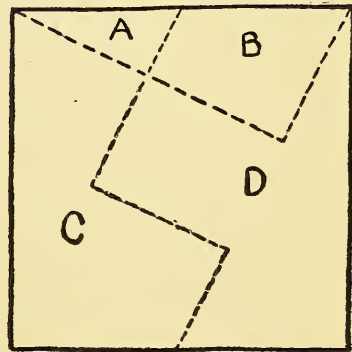

FIG. 216.

## CHAPTER XIX.

### HOW TO PREPARE AND GIVE A BOYS' CHALK-TALK.

A NATURAL taste or talent for art is almost universal. If any of my readers doubt this statement let them supply all the youngsters in their neighborhood with colored chalks and note the result.

My word for it, there will not be a paving-flag, wall or fence in the ward, which offers an opportunity for a picture, which will not be profusely decorated with brilliantly colored, grotesque figures.

#### We are all Born Artists.

The truth is that the ability and desire to draw, come just as natural to a child as its ability and desire to talk.

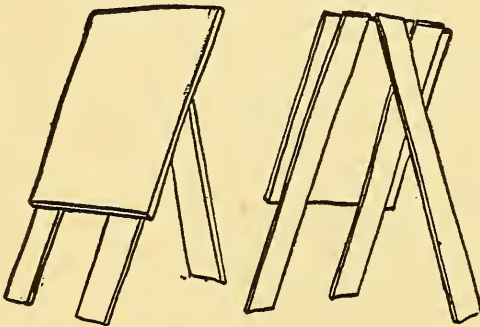

FIGS. 217 and 218.—The Drawing-board.

That almost all children learn to talk with more or less fluency, while few learn to draw with any approach to skill, is because talking is encouraged and systematically taught from earliest infancy, while drawing is discouraged, and has been ever since the days of old Sakya-Muni, 400 years before the Christian era. Sakya, the narrow-minded old heathen, thought it detrimental to progress in virtue to waste one's time with pencil or brush.

And to-day, in the gray light of the dawn of the twentieth century, boys are often forbidden to draw and few are encouraged in the practice, so that, in fear of punishment, the youngsters give vent to their artistic feelings by slyly decorating the flags, walls, and fences.

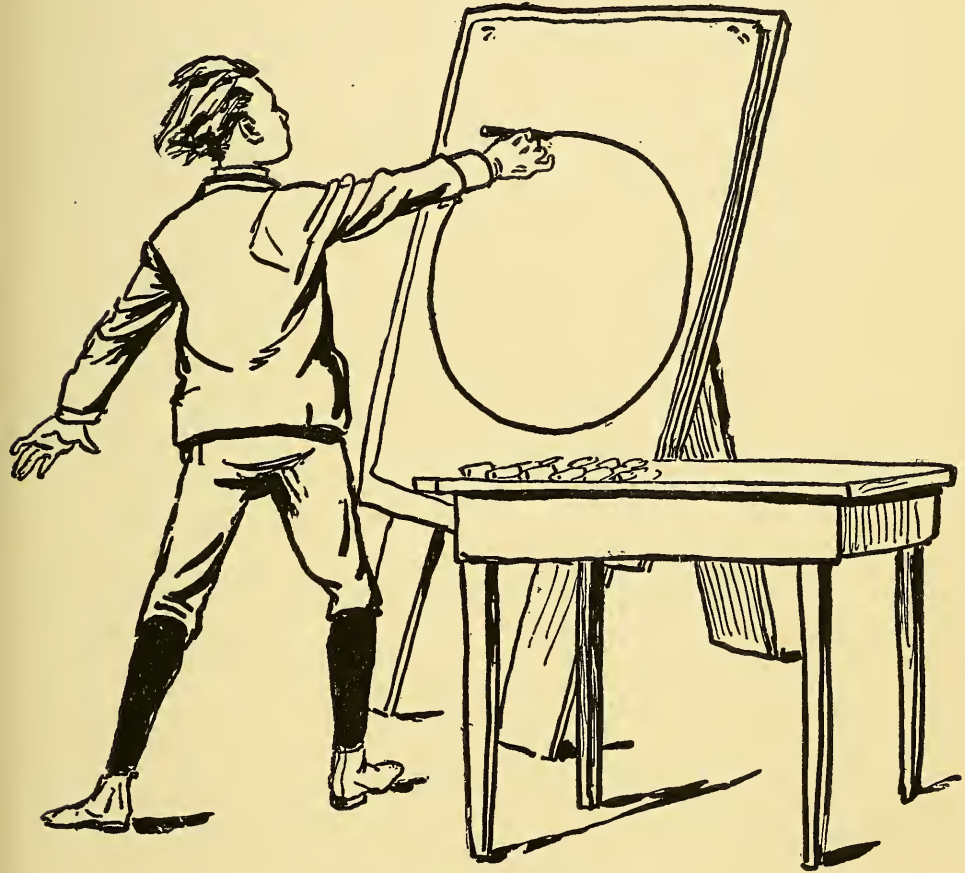

FIG. 219.—A Chalk-Talker.

Art will never reach the proper standard until these little "chalk-talkers" are encouraged, and taught to handle their chalk with the same skill with which they are taught to use their tongues.



### The Name Chalk-Talk

was invented by Frank Beard, D.D., the veteran cartoonist, lecturer, and college professor, and it is the title of his first public lecture, but since then it has grown to be a popular

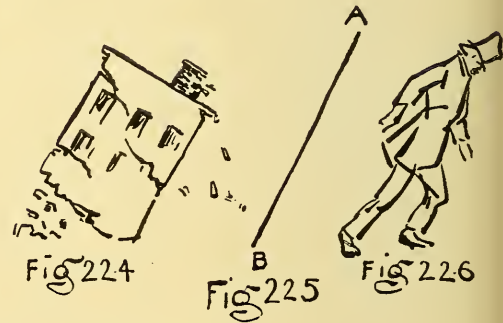
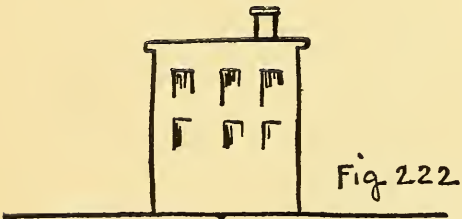
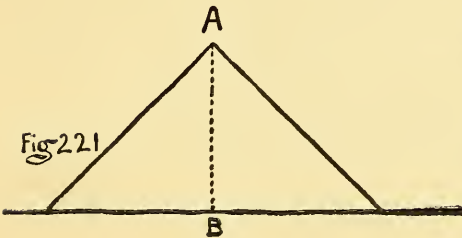
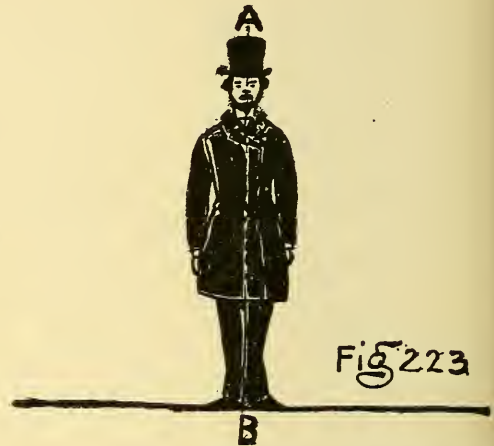
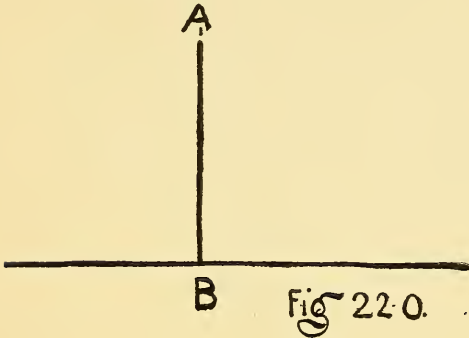

FIGS. 220-226.—The Character of Lines.

name, so that whenever a speaker illustrates what he has to say by pictures, drawn before the audience, the entertainment is called a chalk-talk.

Besides the ability to stand before an audience and talk, it is absolutely necessary to have some little knowledge of

drawing, before one can hope to make a success in this field.

However, any lad, with ordinary ability, can

**Learn by Practise**

to draw well enough to give an interesting show, suitable for the school-room, Sunday-school, or for a drawing-room entertainment.

For this a good blackboard and a few colored chalks are all the material necessary. The blackboard is a most ex-

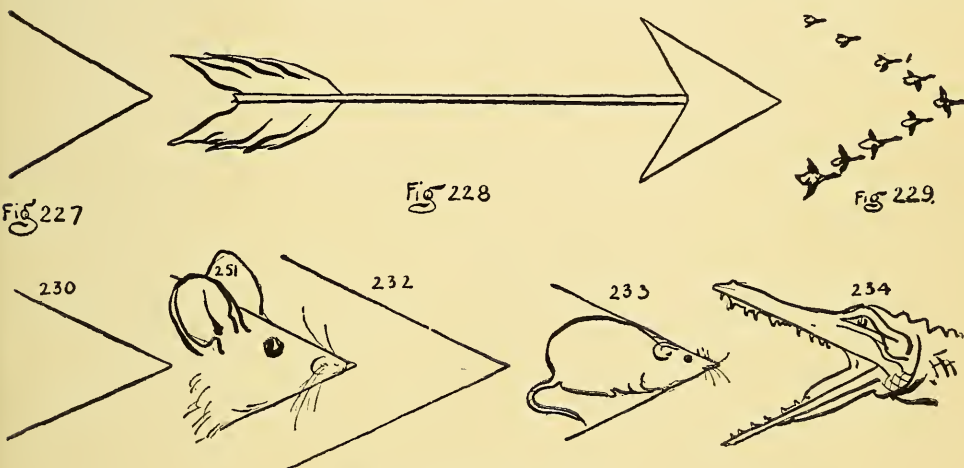

FIGS. 227-234.—Motion.

cellent thing upon which to practise, but it is much better to use large sheets of yellowish-brown paper. This paper is known as chalk-talk paper, and has "tooth" enough to retain the chalk, and make every stroke tell.

Figs. 217 and 218 show how to make a

**Drawing-Board,**

upon which to fasten the paper. Fig. 217 shows the front view. Fig. 218 the rear view. The drawing-board can be made of any size to suit the artist, but should always be large enough to give full sweep to the arm.

### **Size of Board.**

To get these proportions take a piece of charcoal in your hand and stand at arm's length from the wall, with your right side toward it, and without changing your position, or leaning forward, make a mark as high upon the wall as you can reach. In the same manner make a mark as low as you can reach, without stooping. Swing your arm from left to right, make two marks midway between and upon each side of the first marks. This will give you the full extent of your reach. It is well to allow a foot more, each way, for a margin. This will give the proper proportion for the drawing-board.

The board must be made of soft, smooth pine boards, so matched that there will be no cracks to annoy you while drawing.

### **The Height of the Easel**

can be obtained by measuring from the floor to the top mark on the wall, and allowing a foot more for the margin.

The easel is made by screwing two leg-boards on the back of the drawing-board (Fig. 217), and then, with a hinge in the middle of the top edge of the drawing-board, attaching the third or hind leg (Fig. 218).

### **Tack the Paper**

securely, at the top and bottom, to the drawing-board, spread your colored chinks out on the table, and group the colors so that they will be handy, and when you want any color you will waste no time seeking that particular lump of chalk (Fig. 219).

### **Keep a Sharp Knife**

handy, on the table, so that as soon as the audience has seen one picture you can run the point of the knife along

the bottom of the paper, just above the tacks, free the lower edge of the drawing, throw it up and over the top of the easel, without taking time to detach it at the top. You are then ready to begin upon a new drawing.

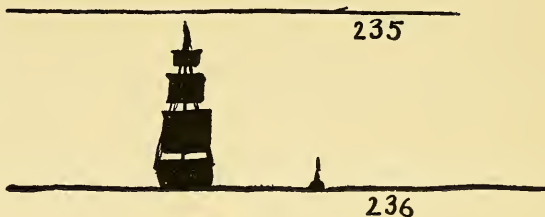

**The Drawings  
Themselves**

must be simple, but with practice some very effective designs can be made with a few rapid strokes, which at a distance will look like finished paintings. You may

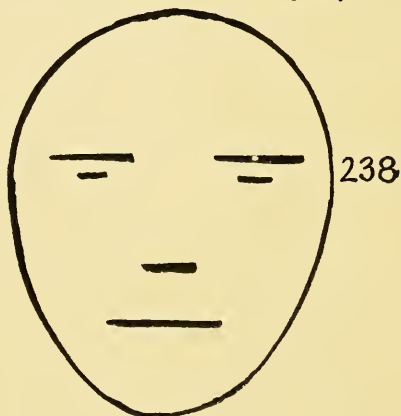

**Begin Your Talk**

by drawing a vertical line AB (Fig. 220). As soon as this is done you must *step aside, so that all the audience may see*

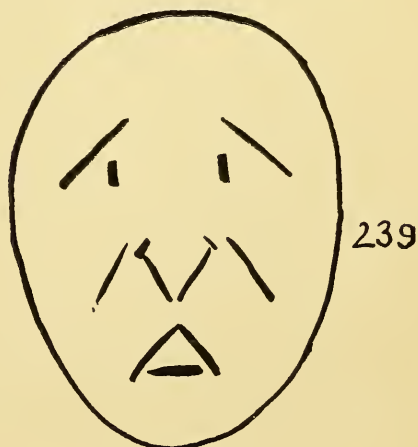





FIG. 240

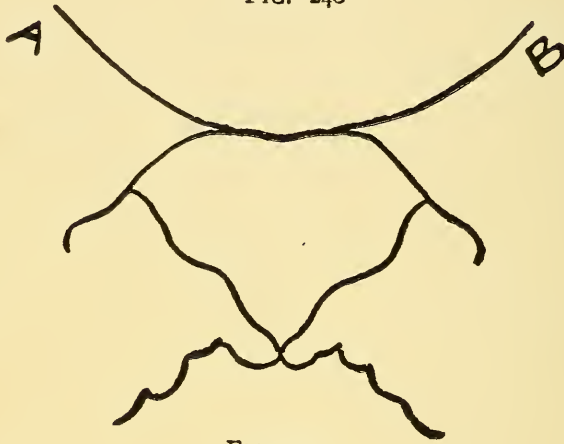

FIG. 241

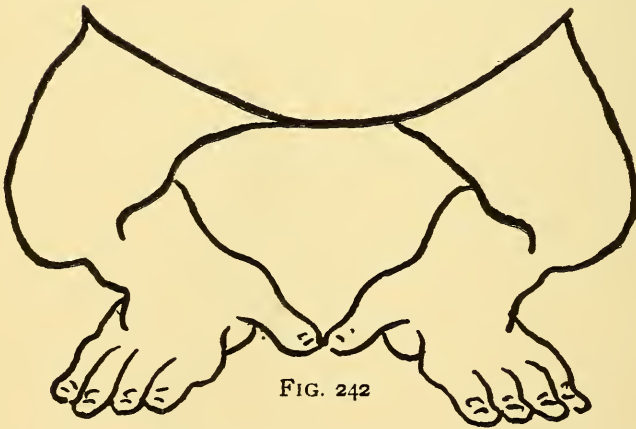

FIG. 242

what you have drawn, and while they are looking at the line tell them that you are going to give them a talk upon the character of lines, and what the lines represent.

AB conveys the idea of

### **A Stationary Object**

—a telegraph pole, a tree, a church steeple, etc. If there is one idea which it does not suggest, that idea is motion.

Draw two lines diagonally down from A to the base line (Fig. 221), and point out that this represents a pyramid, which when resting upon its base is the

### **Emblem of Stability.**

Upon another sheet of paper draw two AB lines, and

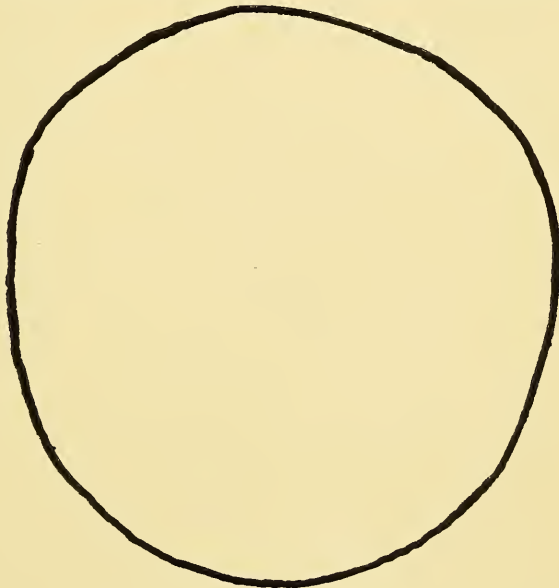

FIG. 243.

joining them at the top (Fig. 222), show that these lines still represent a stationary object—a house.

At this point you may work in any comic story of houses in a Western tornado, which, under a stress of weather are not stationary, but seem inclined to change their base and even to fly, etc. Fig. 243 shows how a man becomes a stationary object when the line AB divides him in the centre.

**Motion.**

But when you slant the AB lines they suggest motion (Figs. 224, 225, and 226).

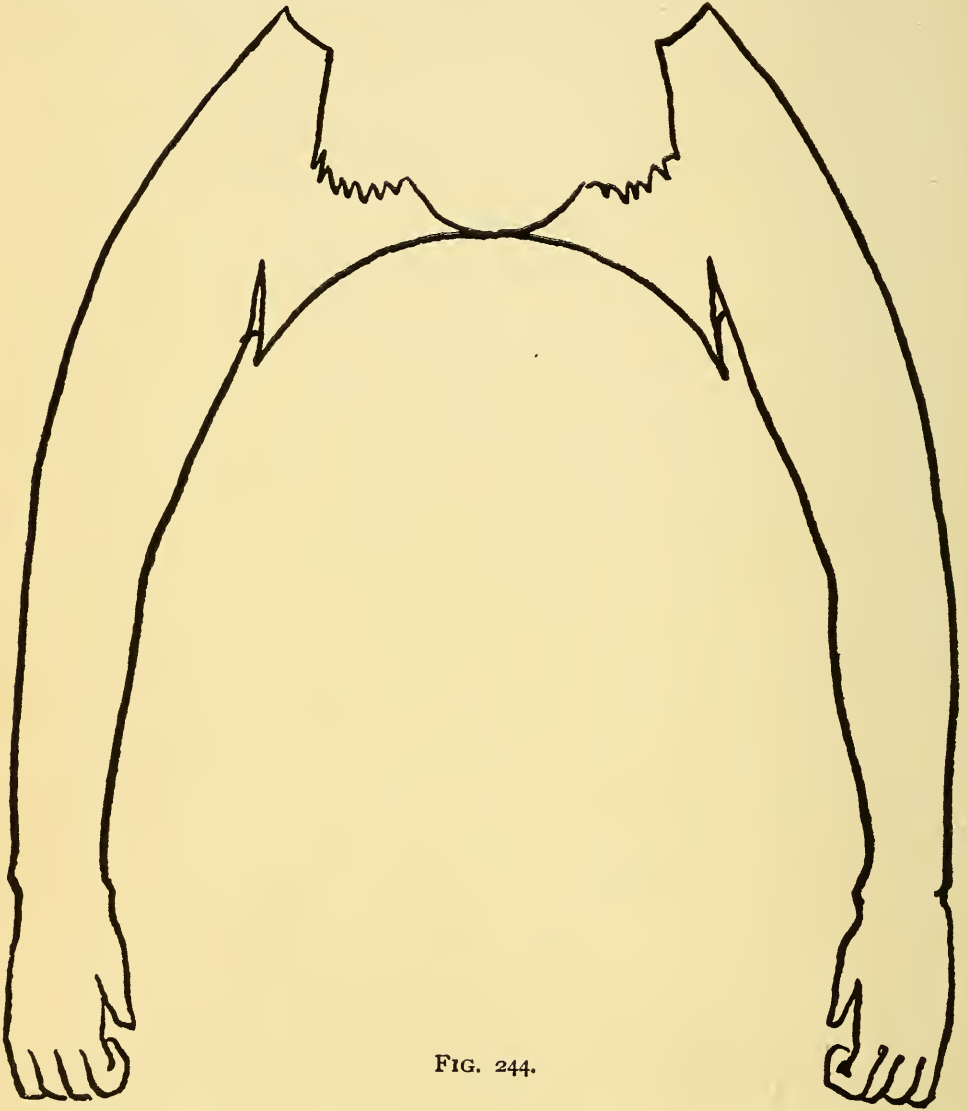

FIG. 244.

Although the pyramid is the emblem of stability, when resting upon its base—with the AB line dividing it in the centre—if you take the same form and point the apex in any

other direction it immediately suggests motion, as in Figs. 227, 228, and 229.

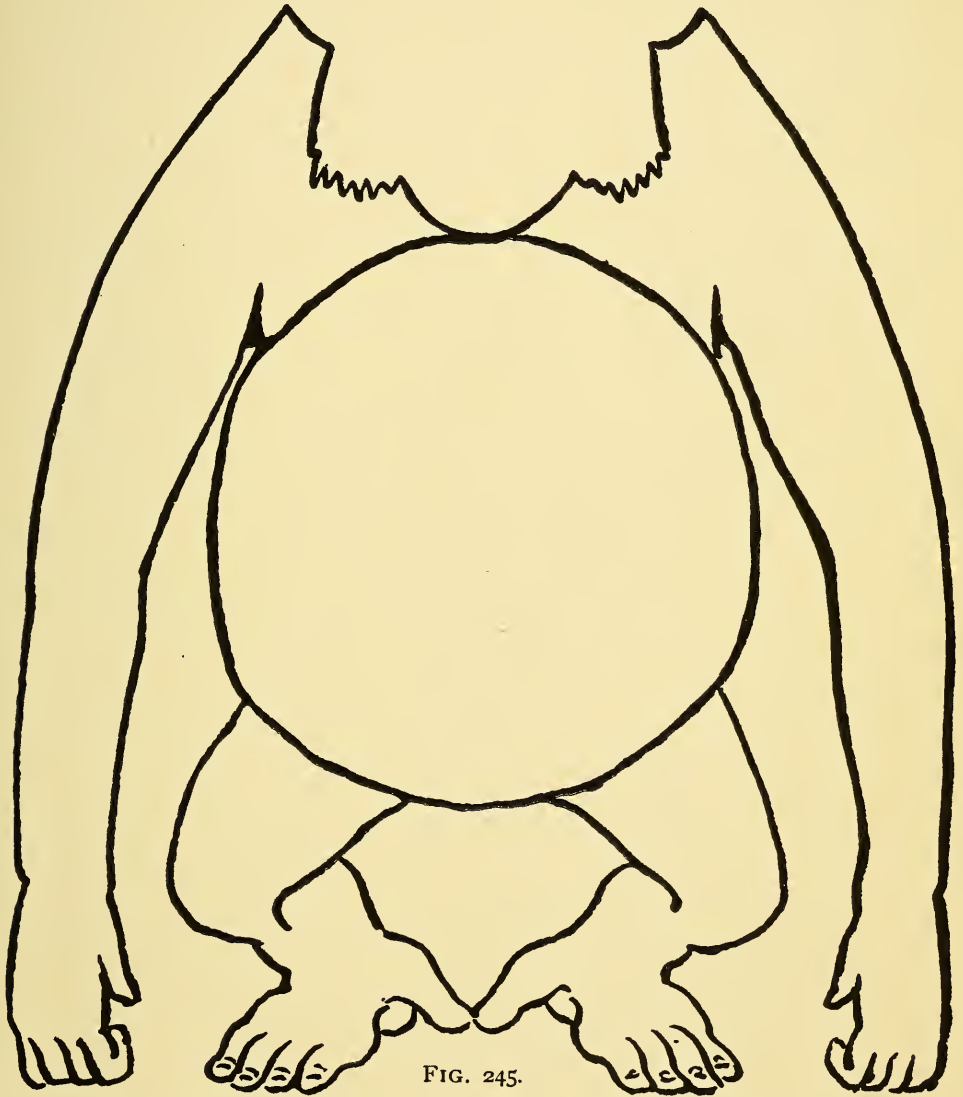

FIG. 245.

Not only does it suggest motion, but it tells the direction of the movement suggested. Any child can tell in which direction the arrow and the ducks are flying.



There is

### **Another Meaning**

to this figure. It is a wedge, and means cleaving—entering into—(Figs. 230, 231, 232, and 233). But when one views it from the opposite direction the meaning is just the opposite to a wedge. It now means reception (Fig. 234). The mouse is entering and the alligator is receiving.

### **Draw All Your Figures as Large as the Paper Will Permit**

you to make them; otherwise the audience, or some persons in the back part of the audience, will miss part of your talk, and that will spoil their enjoyment and diminish your applause.

Upon a new sheet of paper draw a horizontal line (Fig. 235), and explain that

### **This Line Means Repose.**

It is the position a person assumes in sleep · it is the surface of the ocean during a calm (Fig. 236).

Here we again have the upright line AB (of Fig. 220), in the mast of the becalmed and immovable ship of Fig. 236. When a squall comes up not only does AB change to a diagonal line (Fig. 237), but the horizontal line, indicating repose, is broken into a series of irregular points, showing noise, movement, and commotion. Figs. 238 and 239 show the same effect of lines.

### **Something Which Needs Practice,**

is the ape; but when you draw it carefully a few times and then practise on it, as you would upon a difficult feat in

FIG. 246.

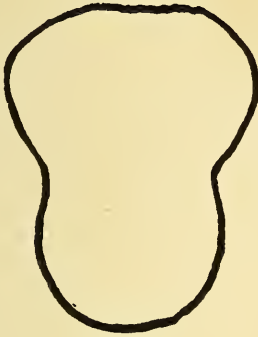

FIG. 249.

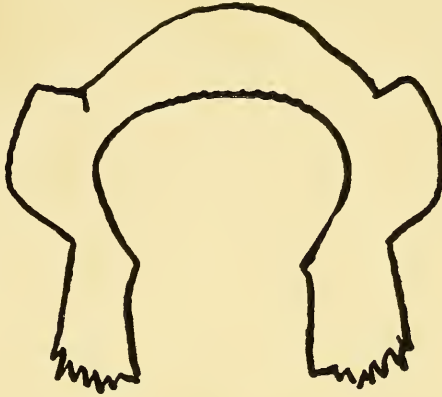

FIG. 247.

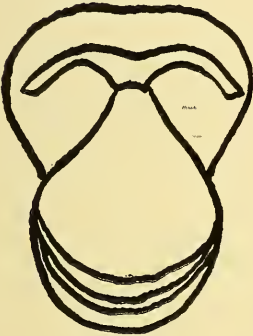

FIG. 250.

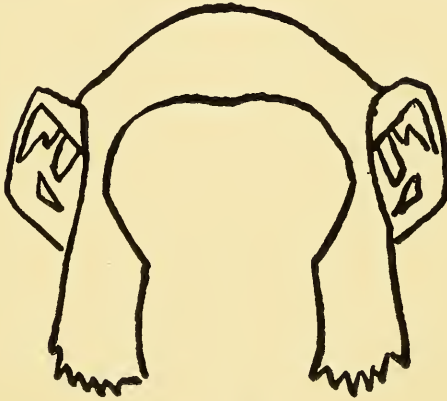

FIG. 248.



FIG. 251.



FIGS. 246-251.—Evolution of the Face.

skating, or any other sport, you can learn to draw the thing in less than a minute. The

### **Evolution of the Ape**

is its growth from a few simple lines. First draw Fig. 240, then add a curved line to the top of the first figure and some wiggles to the bottom (Fig. 241).

A few more strokes of the chalk and we have the comical short legs, long toes, and big thumbs (Fig. 242). Prolong the curve which you drew upon top of the legs until you have an irregular circle (Fig. 243), and on top of the circle fit Fig. 244, the arms of the ape. Make the knuckles rest upon the ground, each side of the feet. From Fig. 246 to Fig. 251, inclusive, is the evolution of the face; but

### **For Quick Work**

most all of the wrinkles shown in Figs. 248 and 251 may be left out. Simply draw the nose and eyes upon Fig. 247 and add the ears, hair, and whiskers (Fig. 250), and it will look ape-like enough to bring applause. When this is finished you have the late lamented Mr. Crowley, of Central Park Zoo (Fig. 252), which will gain sufficient applause to fully repay you for all the time spent in practising on the evolution of the ape.

This will be enough for one talk, and if interlarded with amusing stories and narrations, will not only hold and amuse your audience, but will teach them some real truths in the sign language of drawing, and give them the beginner's lesson in the meaning of lines.

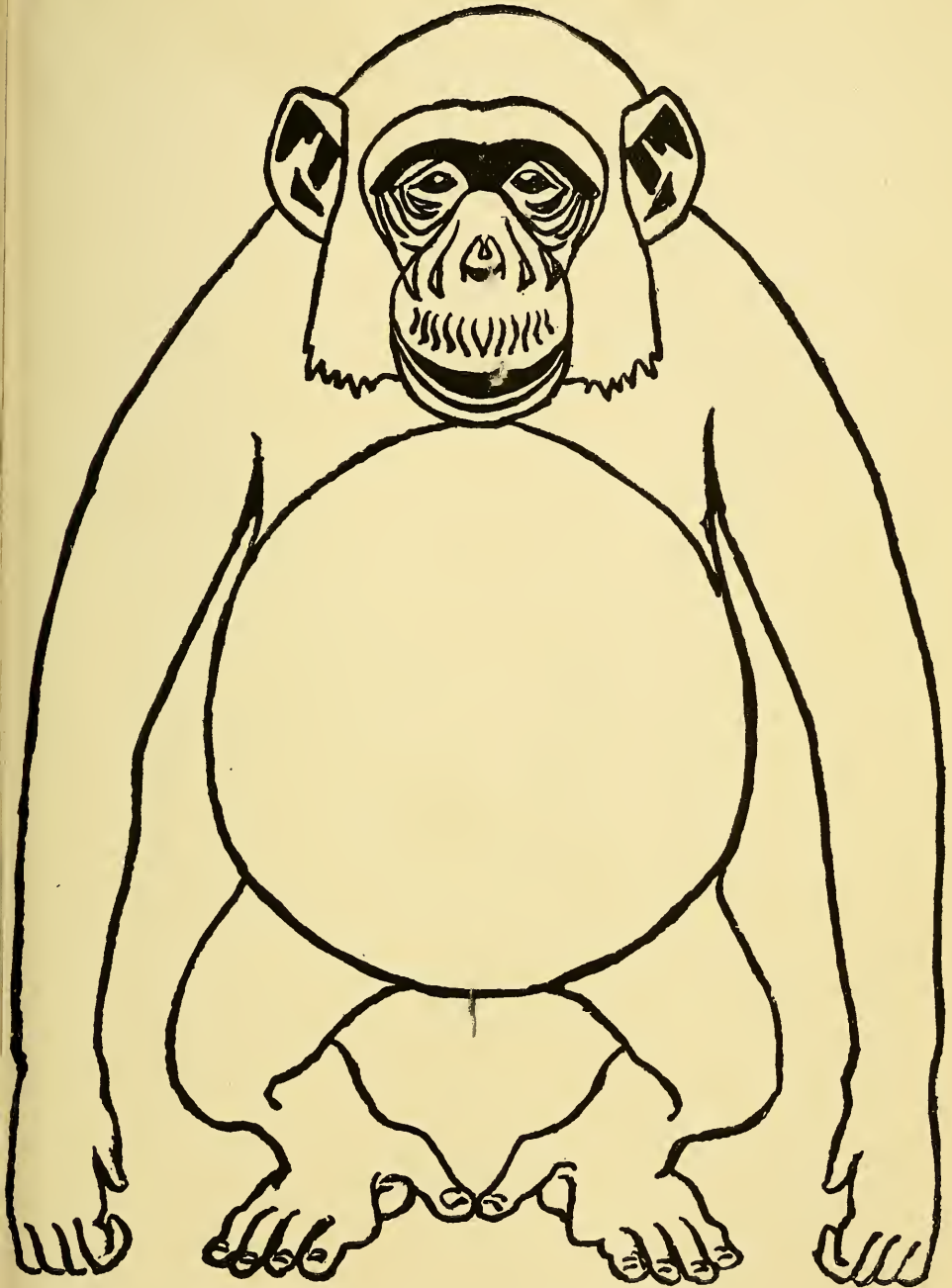

FIG. 252.—Mr. Crowley.





1876

## CHAPTER XX.

### A CHRISTMAS NOVELTY FOR BOYS.

#### How to Build and Decorate a Fireplace for Santa Claus.

To Mr. Clement C. Moore we are indebted for the creation of that jolly little gnome, the Americanized Santa Claus, Kris Kringle, or Saint Nicholas. When "The Night Before Christmas" was written our homes all possessed ample chimneys and spacious fireplaces, affording a most convenient entrance for the merry little saint; but now he is without doubt sorely puzzled by our modern houses, and experiences great discomfort and difficulty in entering the hot-air chamber of the furnaces, and squeezing his corpulent little body and his pack of gifts through the registers.

A deep sense of gratitude for many favors received, induces me to offer a few suggestions which will help the friend of my boyhood to come, as of old, through the chimney.

Fig. 253 shows

#### The First Start

for the framework, which is made of smooth or rough pine strips,  $\frac{1}{2}$  inch thick by 2 inches in width. Make the frame about 5 feet 4 inches high by 4 feet 6 inches wide; the top and lower pieces 4 feet 5 inches (A, B, and C, D, Fig. 253) long, thus allowing  $\frac{1}{2}$  inch at each end, to fit the ends of the side-pieces (R and S, Fig. 256). The diagonals, X and Y (Fig. 253), are temporary braces, to keep the frame in shape, and

are nailed at each end in such a manner that the nails may be easily withdrawn when it is necessary. The illustration is so clear that there should be no difficulty in following its lines.

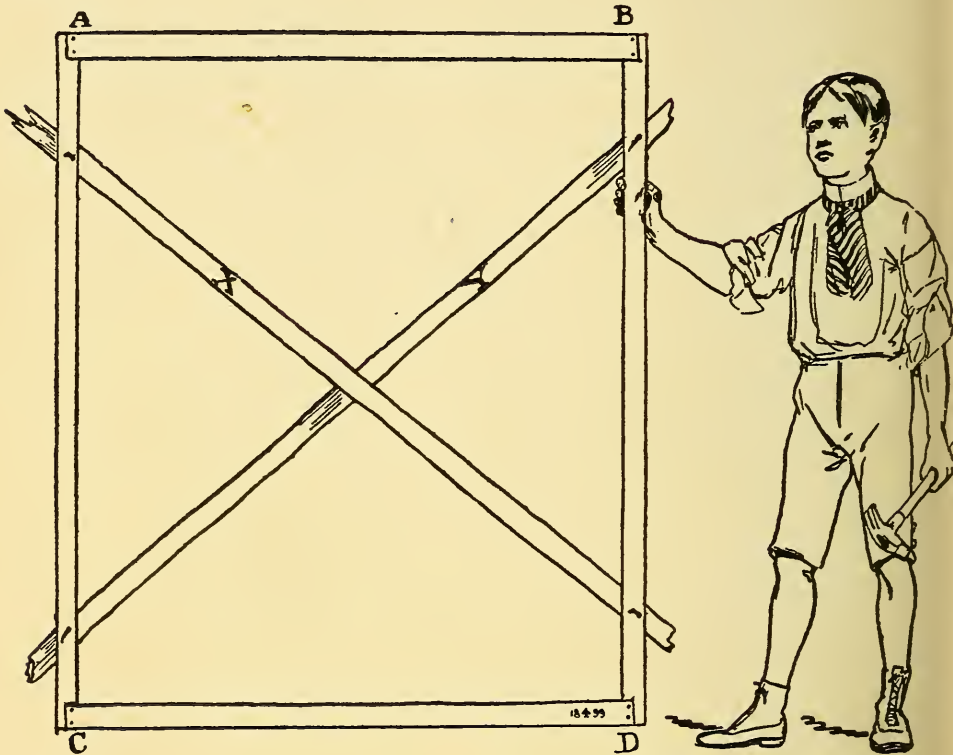

FIG. 253.—Beginning the Framework.

The frame, A, E, F, B (Fig. 254), is the

### Back of the Chimney,

and should reach to the ceiling of the room in which the fireplace is to be built. Set the frame, A, B, C, D (Fig. 253), against the wall; then take Z (Fig. 254) and raise it up until it touches the ceiling, and drive a nail at the intersection of X and Y into Z, and another exactly in the centre of A, B; drive them far enough to hold Z in an upright position,

but leave enough of the nail-heads protruding to make it easy to redraw them and remove the temporary braces, X, Y, and Z (Fig. 254), when the whole frame will be finished and ready to use.

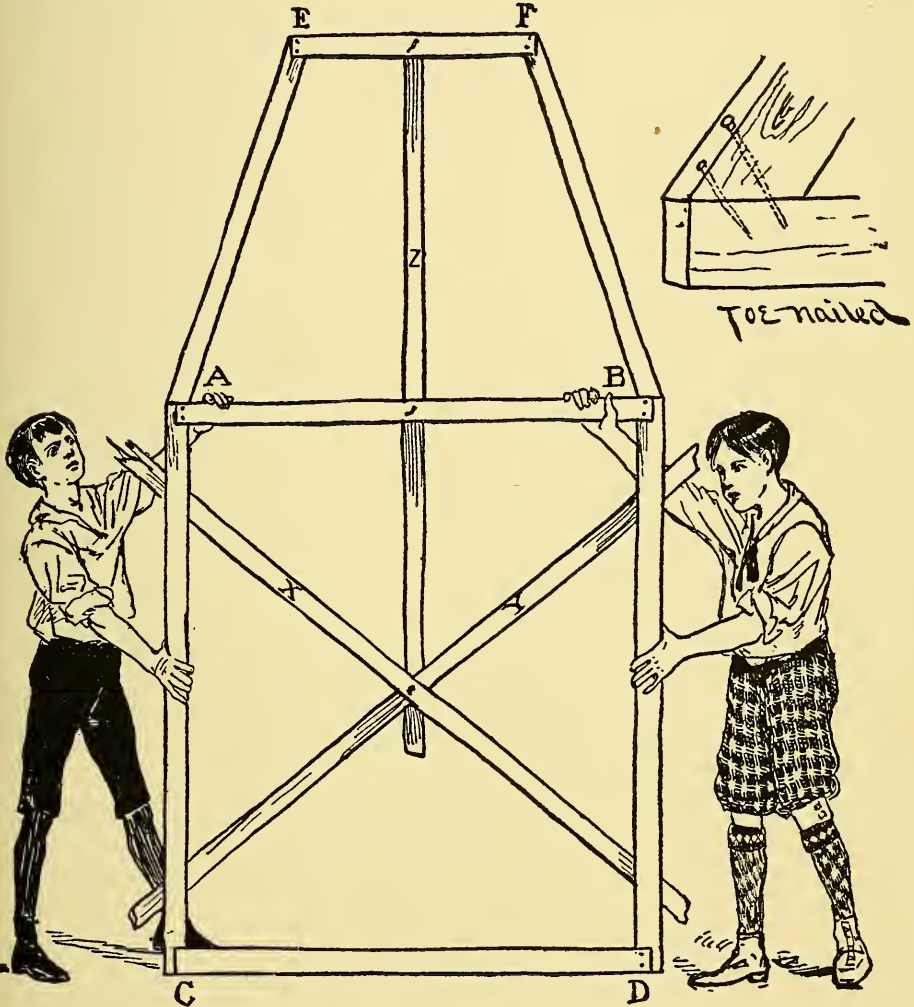

FIG. 254.—The Back of the Chimney.

Take a stick half the length of A, B (E, F, Fig. 254), and nail the end of Z exactly to the centre of E, F. By pushing up one end or the other you may put E, F exactly at right



angles, or "square" with Z. When the stick, E, F, is found to be square, cut two more sticks, A, E and F, B, each a trifle longer than the distance from A to E; cut the ends of these sticks to fit on the top of A, B, and "toe-nail" them in place, as is shown in the small diagram in the upper right-hand corner of Fig. 254. Allow the upper ends of A, E, and F, B to slip under the ends of the stick, E, F, as in the illustration, and nail them securely in place; then saw off the protruding ends even with E, F, and the back of your frame is finished.

### **The Front Frame**

(Fig. 255) is of the same width as A, B, Fig. 253, but it is the width of the strips R and S, Fig. 256 (two inches), shorter than the back. The side-pieces, G, N, and H, Q (Fig. 255), are set with their edges facing the front, and the top-piece, G, H (Fig. 255), is fitted in with its broad surface facing the front and flush with the tops and front edges of the side-pieces, G, N, and H, Q; it is held in place by nails driven through the side-pieces in the ends of G, H.

The piece J, K, is exactly the same length as G, H, and forms the top of the fireplace, but unlike G, H, the piece J, K, has its thin edge flush with the front. It is held in place by nails which are driven through from the outside of the two uprights, G, N, and H, Q. All these pieces must be cut and fitted with exactness, or the framework will be of no use.

Fig. 256 shows how

### **The Remaining Pieces,**

LO, MP, NO, and PQ, are placed, and the figure of the young workman gives an idea of their proportions which cannot be given in figures, for the reason that the opening

for the fireplace must be made to suit the size of the boy who is to be Santa Claus.

To finish the framework is now

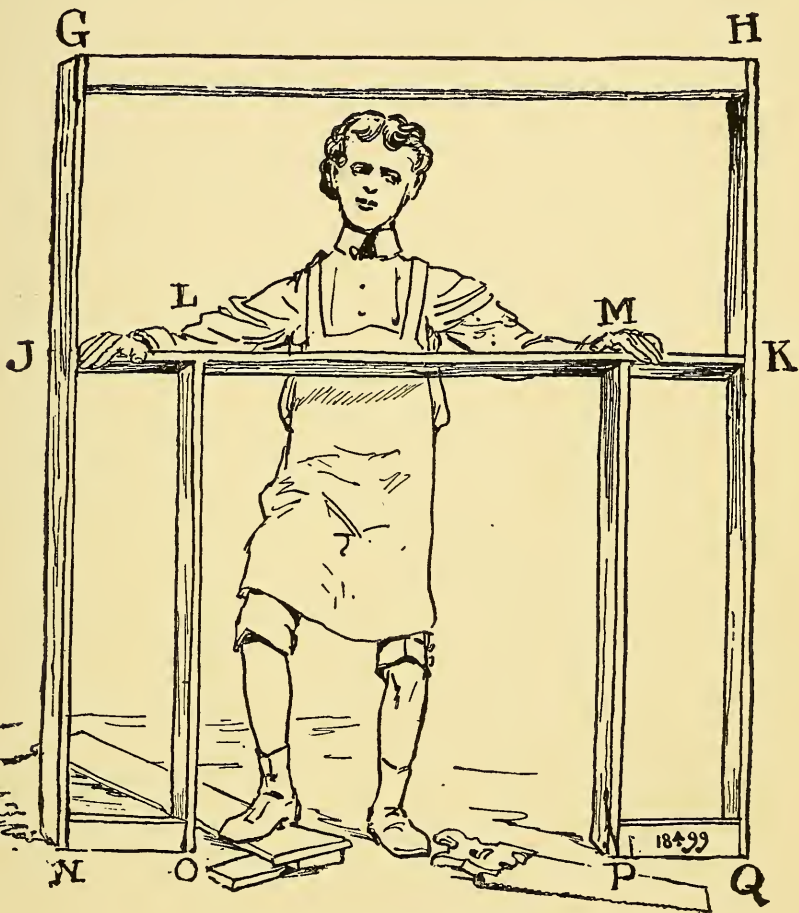

FIG. 255.—The Front Frame.

### A Simple Task.

Make two bottom side-bars (C, N, and D, Q, Fig. 256), each about two and one-half feet long, and nail them in place, "toe-nailing" at the front. The two top-bars (R and S, Fig. 256) must extend out a foot in front, as a support for

the mantel-piece. After these are securely nailed in place the roof-sticks, *a* and *d*, may be fitted in place, and notched to fit over the mantel supports, as shown in Fig. 256. You now have a strong but light frame, which must be neatly

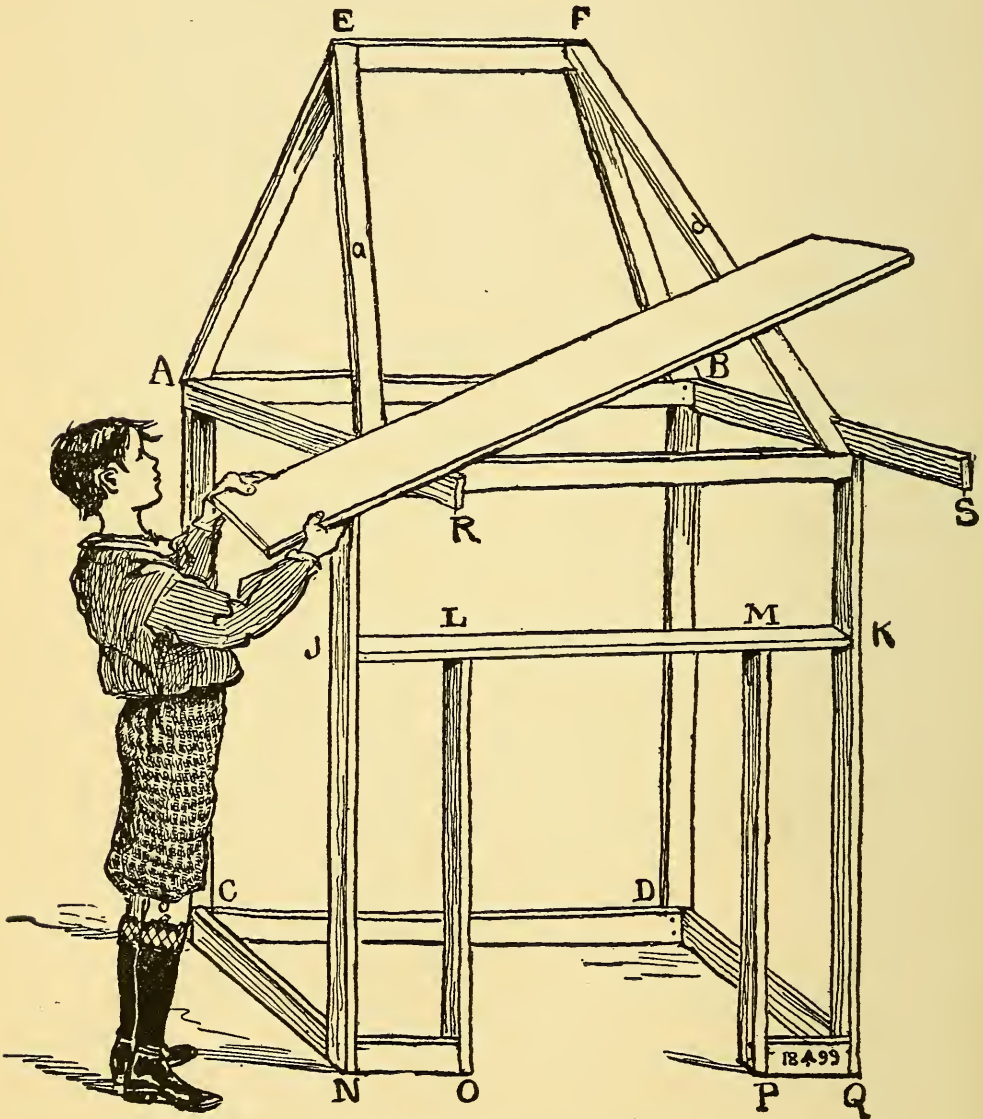

FIG. 256.—The Finished Frame.

covered with gray-colored paper muslin, Manila paper, or building paper.

### **The Covering**

must be stretched, and securely tacked to the framework, so that no wrinkles shall betray its frail nature.

Some black paper muslin is now needed

### **To Line the Inside of the Fireplace.**

Tack the ends of two pieces of the black stuff on the uprights, LO, and MP, and extend one piece back to B, D, and the other to A, C, and tack them to the back frame; also stretch a piece of black muslin from A, C, to B, D. This will make the interior of the fireplace dark and mysterious.

Next take a pot of white paint and a small brush, and rule white horizontal lines all around the fireplace and chimney; then paint upright lines, as shown in the illustration (Fig. 257). This will give the effect of stonework with white plaster between.

Place a smooth board upon the projecting supports, R and S, for the mantel, and the work will be done. If you can secure some old-fashioned brass candlesticks and an antique clock, for your mantel, they will add greatly to the effect. A pair of andirons, with some charred sticks of wood, will give a realistic touch which will win applause (Fig. 257).

### **Our American St. Nicholas**

is a jovial little fellow, with a very red nose, white hair, white beard, short pipe, fur-trimmed clothes, and a little round belly—which shakes when he laughs, like a bowl full of jelly. Every youngster also knows that he comes in a



little sleigh, drawn by eight tiny reindeer; but in spite of this universal knowledge among the children of America of Santa Claus' personal characteristics, the long-legged saint of Europe still fills our illustrated papers, each year as heretofore, and badly upholstered giants are made to

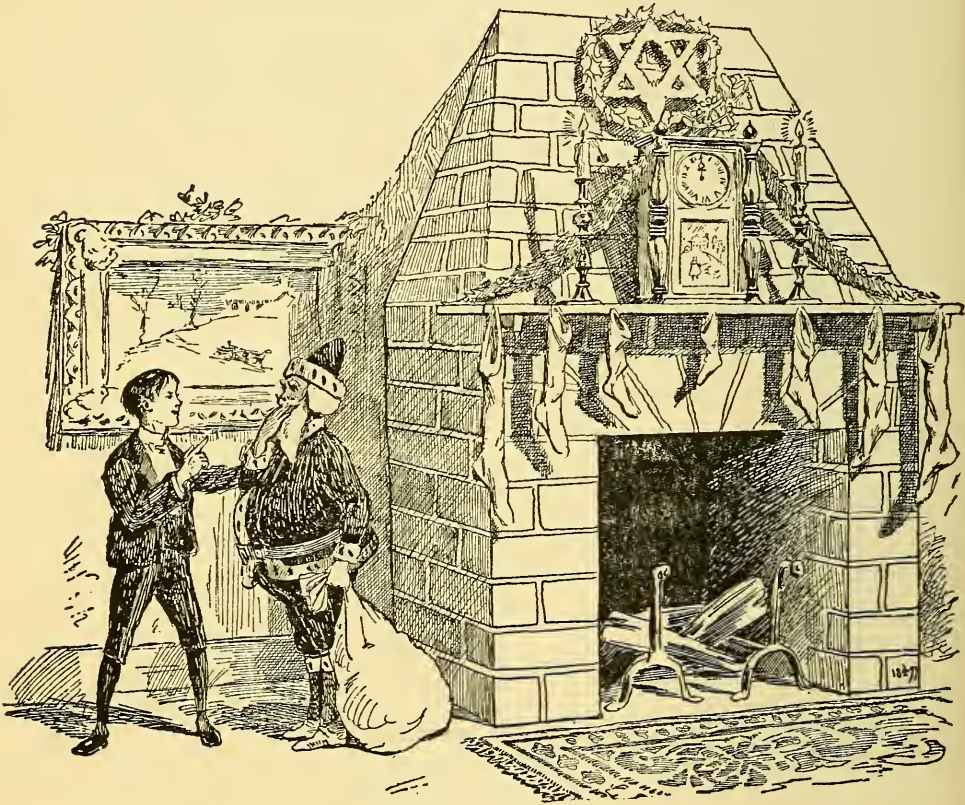

FIG 257.—Ready for Christmas.

stand for the saint in all the shop-windows, and frighten the children out of their seven senses. It is a fact that many of the little ones take these big ungainly giants for the ones which Jack the Giant-killer is supposed to have slain.

All American children love their little American Christmas saint, whose individuality was born with the verses beginning

“ It was the night before Christmas, and all through the house  
Not a creature was stirring, not even a mouse,” etc.

Any boy who has a box of tools, and is at all clever at carpentry, may make a framework similar to the one shown in the preceding illustrations, but when it comes to preparing the

### **Costume for Jolly Old Santa Claus**

he will more than likely find it convenient to call for some assistance from his sisters, though, of course, he will enjoy the whole thing better if he can make it a real surprise.

But it is not very difficult for the boys to make a good representation of St. Nick themselves.

### **The Coat.**

When making his costume secure a dark-colored sack coat which is much too large for the proposed Santa Claus, and turn back the sleeves at the cuffs until they are the proper length for Santa Claus's arms. Stitch the cuffs lightly to the sleeves, to keep them in place. Turn up the bottom of the coat all around, making it the proper length for the little man, and stitch the skirt in place; then, to represent fur, use white cotton-batting and cover the turned-back cuffs and skirt with this material, so as to conceal the alterations. Upon the white trimmings sew little tags of black cotton.

### Use a Fur Cap,

if you have one; if not, take any sort of a dark cloth one, and sew a piece of white cotton around the edge. Cover the legs, below the knees, with heavy woollen stockings and use big overshoes for the feet.

### How to Put on the Clothes.

When the boy who is to represent the jolly old saint is ready to dress, let him put on the knickerbockers first and stuff the bottom end of a pillow in the front of the breeches; then put on the coat, and button and belt the pillow inside. This will give him a jolly big paunch; next put on the stockings and the overshoes. Then let some one gum a pair of big white cotton eyebrows to his forehead, using common mucilage for the purpose; also a long white cotton mustache and beard. Press these appendages to the face until the mucilage is dry. The finishing touch is made by painting the nose a bright red, and then the brave old saint will be ready to hide in the spacious chimney, to descend and greet the company when he receives the signal that the proper time has come for his appearance.

If the false chimney and fireplace are set up against an open door, Santa Claus may enter from the other room, and when he lets himself down over the black cloth back of the fireplace it will appear to the audience—at least, to all the little folks—as if he came down the chimney.

In case no doorway is handy a strong board shelf, built in the false chimney, will serve as a seat and a place of concealment for the saint until the clock on the mantel strikes the hour of twelve, which should be the signal for the immediate appearance of the little man.

**The Clock,**

of course, should be set ahead of time, so that it will strike at the proper moment, when everything is in readiness, and the little folks are trembling with impatience.



## CHAPTER XXI.

### HOW TO MAKE TWO BOYS INTO ONE SANTA CLAUS.

If your time for preparation is limited, and you still wish to have a live Santa Claus, you may do so by dispensing with the artificial fireplace altogether, and allowing the old saint to hold a reception in the doorway between two rooms.



FIG. 258.—Legs.

The accompanying illustrations show how you can make another real live Santa Claus, in your own home. Many of you are familiar with the trick of the so-called German dwarf, and this Santa Claus is an adaptation of that trick for a Christmas entertainment.



FIG. 259.—Legs with Coat.

The first picture (Fig. 258) shows

### How the Old Saint's Legs are Made

by pulling a pair of golf stockings over the hands and arms, and then slipping the hands into the slippers.

It is necessary to choose a short coat, for otherwise the tails would hide the feet. With any old fur, or substitute which will look like fur, trim the coat, making it appear as if it buttoned up in the middle of the back.

Some one then puts the coat, "wrong-side fore," on to the boy who acts as legs (Fig. 259).

### The Wig and Beard

are now put on Mr. Legs, and his nose is then painted a bright red, after which a peaked cap, made of some bright material and trimmed with something to represent fur, is placed upon his head.

"Mr. Legs" is now ready for "Mr. Arms," and the illustration (Fig. 260) shows Mr. Arms after he has thrust his hands and arms through the sleeves of the fur-trimmed coat.



FIG. 260.—The Little Saint.  
Side-View.

### The Curtains

are securely pinned behind Legs' head in front of Arms' face, and brought down around the fur-trimmed coat, outside of Legs' real legs, and pinned under his arms, which are doing the part of the saint's legs, thus concealing all

but the little saint. The last illustration (Fig. 261) displays the jolly little saint distributing candy and small presents to the young people.

The more care you take in arranging your show, the greater will be the success of the entertainment. The eight little reindeer are not necessary, even if they were obtainable, for the old saint may be supposed to have unhitched his steeds for the time and stabled them on the roof; but



FIG. 261.—The Little Saint. Front View.

### The Sleigh

can be improvised from any ordinary coasting-sled. Select one which looks something like a sleigh.

When fat little Santa Claus comes down the chimney, we all know that he carries his

### Good Things in a Bag,

so if you secure a bag, and stuff it full of any sort of material, it will make a most appropriate load for the sleigh. A fur rug will add to the effect, but is not necessary.

If the sleigh and bag do not reach high enough for the saint to stand on, a stage must be made of some old box, covered by a white sheet or white canton-flannel cloth, to

represent snow, and on this stage set the sleigh and bag, as shown in the illustration on page 250.

A second bag should be procured, in which all the presents have been placed; each present should be carefully covered with enough paper to protect it from injury, as well as to conceal and make a mystery of the contents of the package.

### **When All is Ready**

have a curtain or screen set up before Santa Claus, turn down the lights and invite the company into the room, then make them keep very quiet and listen for Santa Claus.

In an adjoining room some one in the secret has a set of sleigh-bells, which are jingled very softly at first, gradually growing louder and louder, as if the sleigh was approaching nearer; when they stop a stamping of feet is heard.

This last is

### **The Signal for Legs,**

who cries out, in his deepest bass, "A pretty Christmas this! Company here, and all hiding behind a screen. What, ho! are ye afraid of Santa Claus?" At that the master of ceremonies removes the screen, and there before the eyes of the delighted company is a real live Santa Claus, who can move his legs and arms, and talk!

The entertainment is

### **Concluded**

by the old saint fishing the presents out of the bag and handing them to the master of ceremonies, who calls out the name found on each bundle and presents it to the claimant.

During the time devoted to the distribution of presents



Santa Claus can make plenty of fun, for as the arms belong to one boy and the legs and head to another, the legs and head never know exactly what the arms are about to do next, and if the arms take a handkerchief out of a pocket to wipe the face, there is always a mirth-provoking incident, and the face does not look happy until the handkerchief is put away.

## CHAPTER XXII.

### A CIRCUS IN THE ATTIC.

#### How to Make the Horses and Other Animals, and How to Make the Costumes.

IN all mimic circus performances the boys of a generation ago were sadly handicapped by the want of horses; sometimes goats and dogs were pressed into service, but these animals flatly refused to allow the youthful circus riders to mount their backs, and as substitutes for horses proved good for nothing but the creation of confusion.

When

#### The Goat

was supposed to canter around the ring, he had a way of standing on his hind legs and coming down head-first, which utterly demoralized our ring-master, and even caused the clown to do many "stunts" not down on the programme. The dog would wag his tail and bark in a manner very unlike a true circus horse.

It sometimes happened that one of the performers was the proud owner of a real live pony. Alas! even a pony had its objectionable features, for however willing the animal might be to climb the stairs, for reasons unaccountable to us, our parents put forth such strong objections that the pony had to be left out of the show.

#### Since the Writer's Circus Days

the safety bicycle has made its appearance, and as a consequence every boys' show may now be supplied with circus

horses which the boys can ride, and which will neither butt nor bark; furthermore, parents will not object to the presence in the attic of rubber-shod hoofs, which make no noise.

### The "Arab Steed"

is made by fastening a simple framework of sticks and hoops to an ordinary wheel. The head may be made of the

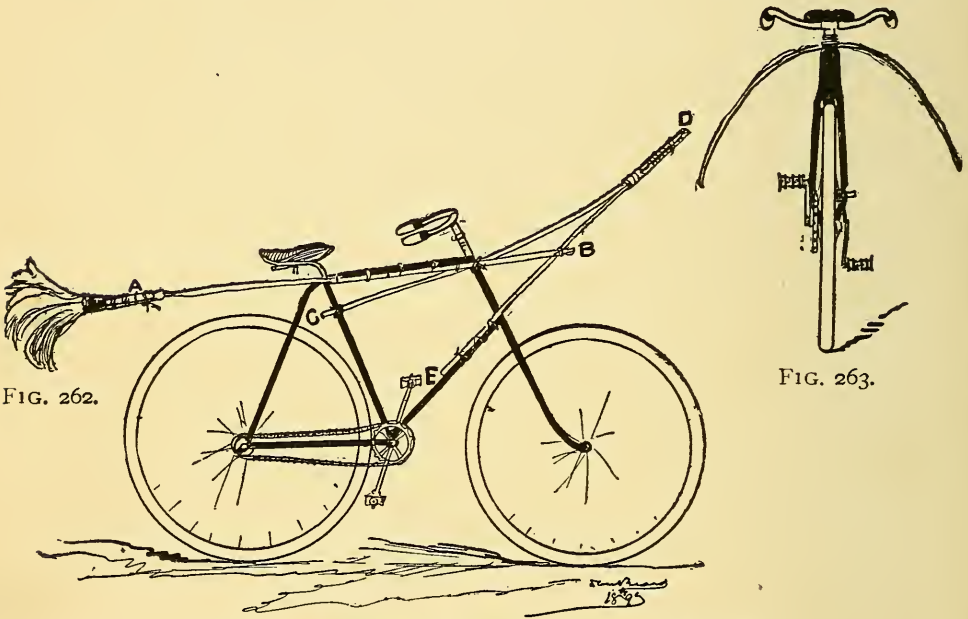

FIGS. 262 and 263.—Showing Skeleton of Horse.

canvas cover of a ham, stuffed with excelsior, or a piece of cloth sewed into the form of a ham-cover, and stuffed lightly with excelsior.

### A Feather-Duster May Do Service as a Tail.

Fig. 262 shows the wheel, with the backbone rod, A B, lashed to the top tube of the frame and the feather-duster made fast to the tail-end of the rod, A B.

### The Neck-Bones

are the two rods, C D and E D. The rod C D is bound to the saddle-post, below the point where the head and top tubes join under the handle-bar. The lower neck-bone, E

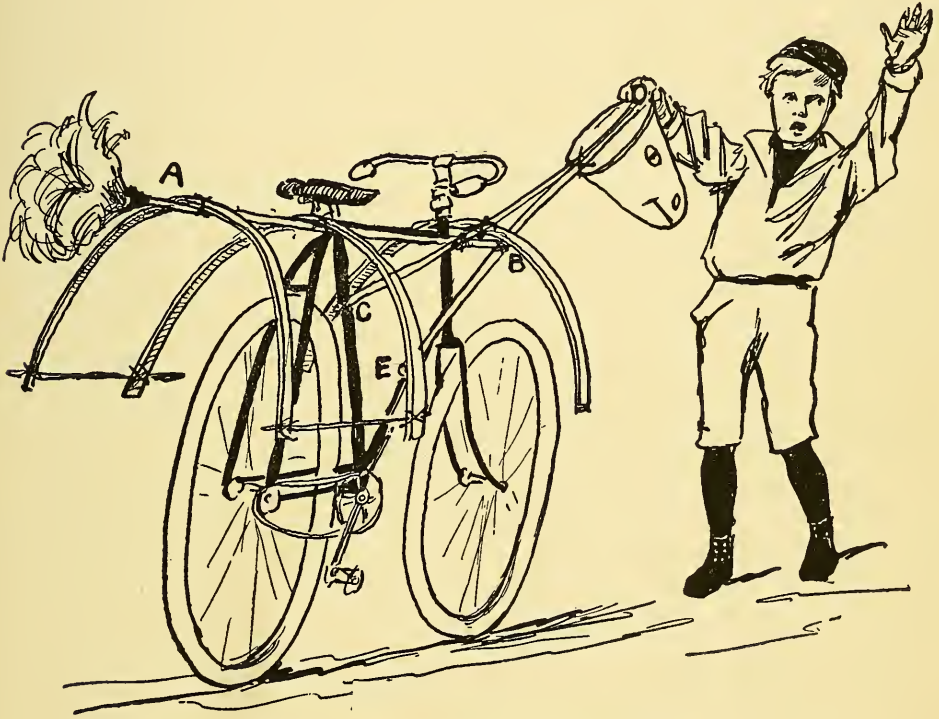

FIG. 264.—Ready for the Cover.

D, is lashed to the top of the bracket-tube at E, just out of reach of the pedals, and to the upper neck-bone, at D.

### The Ribs

are made from ordinary wooden barrel-hoops. Fig. 263 shows front-view of wheel, with one hoop in place. The first hoop is tied on the neck-bone, in front of the handle-bars, and the next two hoops are lashed to the backbone, behind



the saddle-bar, as shown in Fig. 264. The head is tied to the end of the neck-bones, at D, and eyes, mouth, and nostrils, painted on the ham-cover head.

### The Frame

now only needs to be covered with a cloth of some kind, to make a most speedy "Arab steed." The covering for the

horse may be gaudily colored paper muslin, with the addition, perhaps, of some quaint figures cut out of gold, red, or black paper, and pasted in place, as shown by the illustration. Two sheets may be made to do duty as a horse-cover; or two old shawls, properly draped and fastened to the skeleton or framework, will answer the purpose; but it is, on the whole, best to buy the paper muslin, as this may be cut and sewed at pleasure. Cut it so as to cover both head and neck, leaving eye-holes and holes for mouth and nose, also a large opening where the fear-

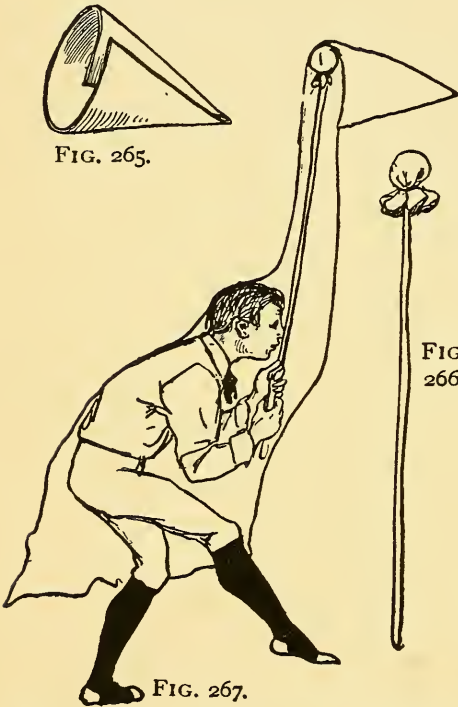

FIGS. 265-267.—The Inside of the Bird.

less circus rider is to sit and work the pedals.

### The Reins

may be made of ribbons and run from the mouth to the handle-bars. The horse's blanket should be stitched to the first hoop on the neck, and not allowed to hang loose, as it

would be certain to interfere with the free movement of the front wheel and bring the Arab steed into trouble not down on the programme, causing him to act more like a bucking Western bronco than a gentle, well-trained circus horse.

### **The Moa is the Giant Bird from New Zealand,**

and is simply made, as a glance at Figs. 265, 266, and 267 will prove. Fig. 265 shows a cone made of card-board, the edges of which are stitched or glued together, and the whole covered with white or yellow paper. Fig. 266 is the neck-bone, a stick with a pad of rags or paper tied over the upper end. A sheet, or other plain-colored cloth, is stitched to the cone in such a manner that the drapery will fall down and hide all but the feet and legs of the boy holding the neck-bone (Fig. 267). Some black paint or ink can be used to mark the eyes and mouth on the paper cone, and the only living example of the moa, the giant bird of New Zealand, is ready to be led around the ring before the eyes of the awe-struck spectators. For an extra charge the strange bird will even allow one of the smaller spectators to ride its back (the boy's shoulders) around the ring.

### **The Manicora**

is an imaginary beast, once thought to inhabit America. From all I can learn from old prints it was supposed to be a sort of lion, with a human face. If any of your circus company own a French poodle, or any sort of long-haired dog which can be shaved like a lion, he can make a beautiful manicora by sewing a skirt, long enough to reach below the dog's collar, on to a cheap false-face. With a little patient work the dog may be taught to walk around the ring with a false-face on. The mask is held in place by tucking the cloth under the dog's collar.

By using  
**A Little Ingenuity,**  
 any number of fierce and strange animals can be made, to

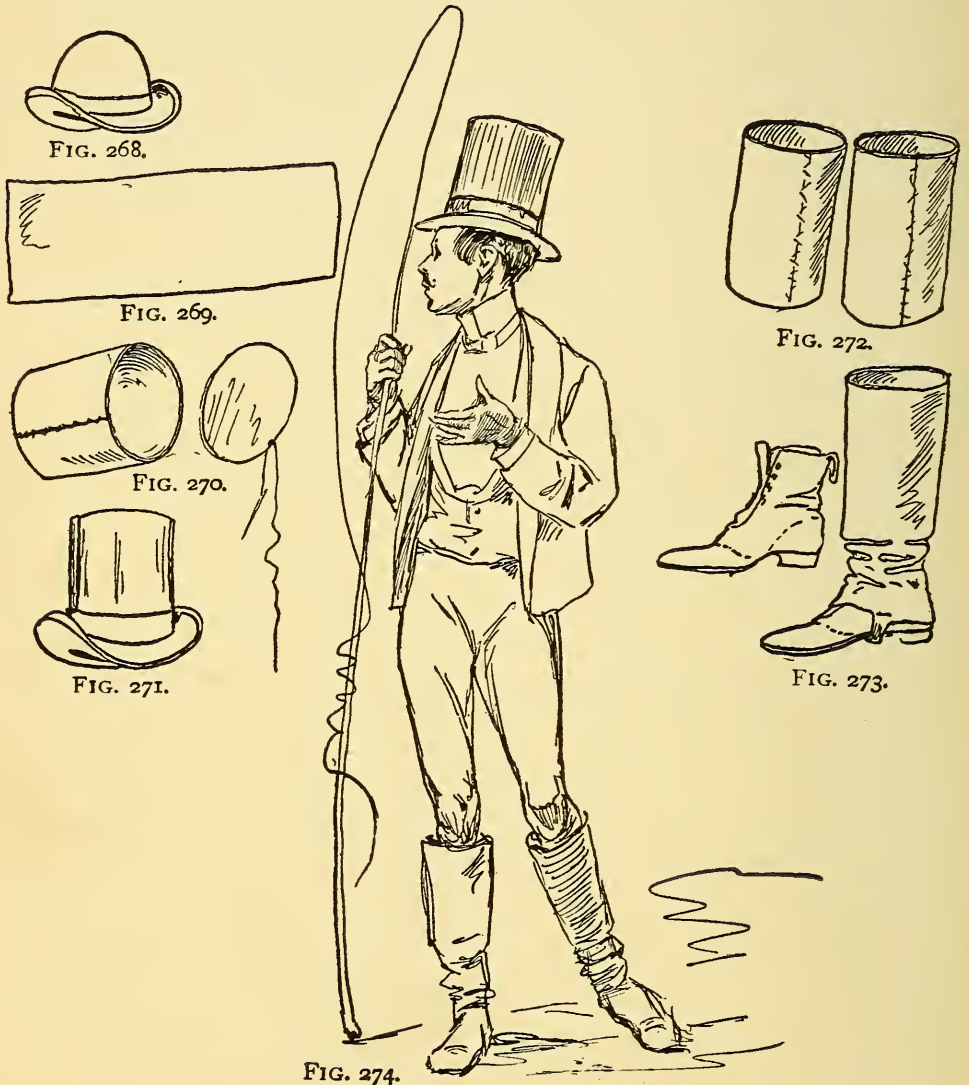

FIGS. 268-274.—Ring-master and His Costume.

astonish and please the audience; every boy knows how to make an elephant of two boys covered with a gray shawl,

and a giraffe can be made by adding another boy to the moa, so as to give it four legs; but the limited space at my disposal forbids my introducing more diagrams.

### **The Dignified and Self-sufficient Ring-master**

must dress in black, and have high boots, or at least what appear to be high boots. This appearance can be made with a few cents' worth of black paper muslin, sewed over two cylinders (Fig. 272) of pasteboard. These, when finished, will look like top-boots (Figs. 273 and 274.)

### **Tight-fitting Knee-breeches,**

black or some dark color, and a dark coat, will be all that is required for lower parts; but the head must be adorned with a high hat, and if an old silk hat of the proper size cannot be procured, you can make one by fitting a muslin-covered pasteboard top on to an ordinary black derby hat (see Figs. 268, 269, 270, 271, and 274.) A standing collar and a flashy or plain white necktie will finish the costume. Of course the ring-master must have a long whip, with which he makes believe to whip the clown when the latter tries one of his jokes at the ring-master's expense.

### **A Jersey or a Tight-fitting Undershirt**

will do duty for the circus rider's upper garment, and if he can induce some one to make him a pair of light-colored trunks he can appear in his underclothes, and no one will know but that he has on the regular showman's tights.

### **A Girl's Old Turban Hat,**

set jauntily on his head, will add to the effect, especially if this head-gear be decorated with a long, curling feather.





FIG. 275.



FIG. 276.



FIG. 277.



FIG. 278.

FIGS. 275-278.—The Clown.

If the reader is not fortunate in the possession of some accommodating female relative who will help him out by kindly making the trunks, he may take an old pair of loose-fitting

### **Knickerbockers,**

and cut the legs off, just below the thigh ; then cut slits near the bottom, through which he may run a piece of tape, as the pucker-string is run in the top of a marble-bag.

To put on these trunks he must turn them

### **Wrong Side Out**

and put them on upside down, then fasten the string as high up on his leg as it will go, after which he can reach down and turn the breeches up until they come to the proper place around his waist. It will then be seen that they are not only right side out, but that the cloth folds over and conceals the pucker-strings as neatly as if the trunks were made by a tailor.

### **Take an Old Soft Felt Hat**

(Fig. 275) and soak it well in warm or hot water, then put it over the blunt end of a bedpost, or any similar object, and firmly but steadily pull down the rim (Fig. 276), until the crown is given a conical form (Fig. 277). If you pull too hard you will run the post through the hat ; but with a little care you may shape any old soft felt hat into the typical head-gear of the clown (Figs. 277, 278).

Your father's, big brother's, or uncle's

### **Pajamas,**

will make an excellent suit of clothes for the clown. Hoist the pantaloons up under your arms and fasten them there ; then put garters around the ankles. Belt in the upper garments at the waist, and put elastic garters on your wrists. Persuade your sister, mother, or aunt, to make a ruff for your

neck, from a piece of stiff white muslin, and you will have as good a clown's suit as appears in the real circus, (Fig. 278).  
When

### Making-Up

for the ring, take some common flour and put it in a piece of mosquito-netting; with this, powder your hair, face, and neck, until all is as white as the driven snow, then wet a towel and mark out a big, laughing mouth.

You are now ready to caper into the ring and throw your peaked hat at the ring-master.



FIG. 279.—The Circus.

# A BOYS' STAG-PARTY

## CHAPTER XXIII.

THE only difference between the bald-headed, bearded boy and his younger brother in knickerbockers is that the latter is fond of fun and owns up to it, while the former is fond of fun and conceals the fact behind a solemn countenance and a severe and dignified frown.

But when the

### Old Boys

attend a stag-party the solemn faces and frowns are not there; they leave them with their overcoats in the hall.

When sending

### Invitations to a Boys' Stag-Party,

it should be suggested that the guests come in their old clothes, and not be late for the target-shooting. You must have some blow-guns and a target ready for them to use when they arrive.

### Make the Target

of a large sheet of Manila paper. Outline the rings by placing the paper on the floor, driving a tack in the centre of the paper, and then using a piece of string with a loop at one end and a very short pencil at the other end, place the loop over the tack and fasten the pencil to the string. In this way make a number of circles, and number them



from one to ten or fifteen, according to the number of guests you have invited to your stag-party.

When the target is finished lay it aside, and busy yourselves making darts for the blow-guns. Take a number of

### Carpet Tacks

and some bright-colored worsted ; tie the worsted string to the tack until the latter is covered, all but its point, then push all the ends of the strings back to the head of the tack and cut them off evenly, leaving them about a quarter of an inch long.

When one of these darts is shot through the blow-gun it will stick into anything it hits, unless the target be of stone or metal.

When the darts are all made lay them aside, with the blow-guns and the target, and go to the market and secure a basketful of an assortment of

### All the Large Vegetables

you can find—big turnips, the largest sweet potatoes, small squashes, field-beets, and compact cabbages. Some of the vegetables in this list may be out of season, but there will always be some that are in season.

Cut the top of each turnip, beet, potato, and squash, leaving a slanting or beveled edge

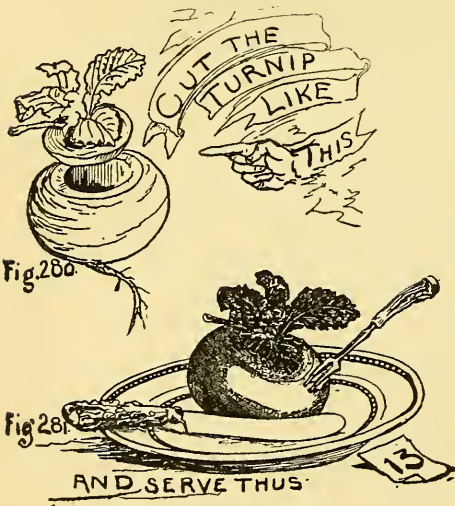

FIGS. 280 AND 281

to the lid (Fig. 280) ; then hollow out the vegetable until you have space enough to hold a fair-sized paper of candy.

Put the candy in oiled paper, place it in the hollow vegetable and fit the lid on the the top, where it can be secured by using wooden toothpicks as tacks (Fig. 281). If this work has been done with any sort of care, no one, not in the secret, will suspect that it is not a common vegetable.

### The Cabbage Bonbon Box

is made in the same manner, only in this case you must carefully peel off the first covering of leaves from the head of cabbage and then cut a hole for the bonbons, as in Fig. 282. After the candy is in place the leaves removed

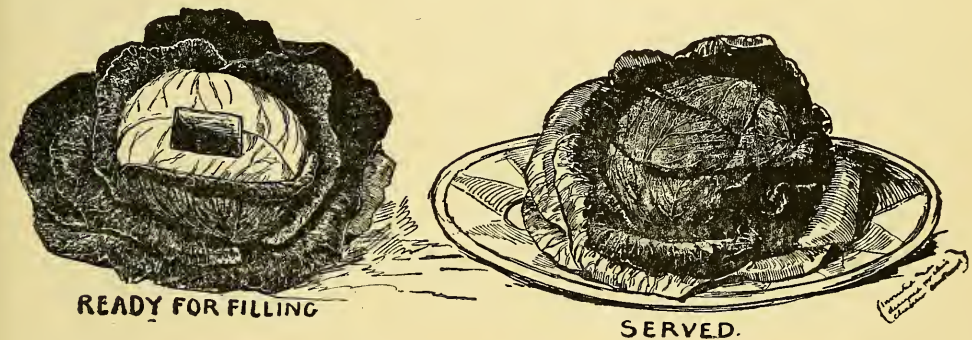

FIGS. 282 and 283.

from the cabbage must be carefully replaced, and fastened on with toothpicks, which are concealed by the surrounding leaves (Fig. 283).

When you have made one of these novel bonbon boxes for each guest, you can begin to make

### The Big Pie or Pudding

which is to grace the centre of the table. Buy a number of cheap toys, such as little china dolls (both black and white), whistles, rattles, etc., and to each one you attach a card with some comic verse or sentence written

on it; then you roll the toy up in a number of pieces of soft paper until the bundle assumes a ball-like form. The outside wrapper of each bundle should be of the brightest-

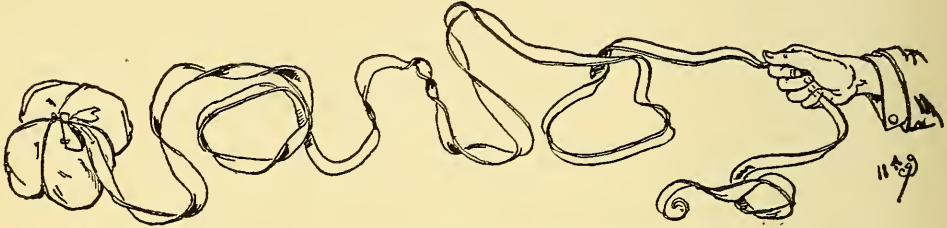

FIG. 284.—Attach a Bright Piece of Ribbon.

colored tissue-paper which can be found. After securely binding the bundles with twine attach a bright piece of tape or silk ribbon to each, as in Fig. 284.

When all the

### **Knick-knacks and Jokes**

are bundled up, and the ribbons attached, place them in a large earthen dish or wooden bread-bowl, and arrange them so that the ribbon to each parcel hangs outside. Then fill the bowl with bran and pat into a rounded surface, as shown in Fig. 285.

### **The Ribbons Must be Loosely Knotted**

at the sides, to keep them from harm, after which the surface of the "fake" cake is covered with a layer of wheat flour, to represent frosting, and the flour is ornamented with raisins, as in the illustration, while the top is decorated with a few sprigs of green or the ornaments from the top of a real cake, and the "fake" cake is then ready to serve.

### **Don't Disappoint the Boys.**

While both the boys in knickerbockers and the boys in long-tailed coats like fun, neither the old nor the young

boys enjoy being disappointed. You must, therefore, have some real pie, cake, and good things to serve, besides the make-believe cake, so as to keep all the guests good-humored.

### **The Shooting.**

When all the lads have assembled and the target is in place, give one prepared tack and the blow-gun to one boy, and let him have a shot at the target, and keep account of the number he comes nearest to with the dart.

When all the boys have had their turn at firing a shot, and

### **The Numbers are All Recorded,**

show them a list, with a penalty opposite each number; for instance, number one must wear two feathers in his hair; number two must have his face decorated with black circles; number three, face decorated with black stripes; number four, hair powdered white, with flour; number five, half face black, etc. Then tell them the list was made out by the Mad March Hare.

### **When All the Boys are Properly Decorated,**

with blackened or whitened faces, coats wrong side out, etc., let them march to the table in the order of their numbers, and take the numbered seat which corresponds with the number they struck on the target. When the boys are seated the maid should bring in

### **Great Trays, Heaped with Raw Garden-Stuff.**

This will cause a shout of surprise and disappointment; but after some lad has laboriously cut a great turnip in



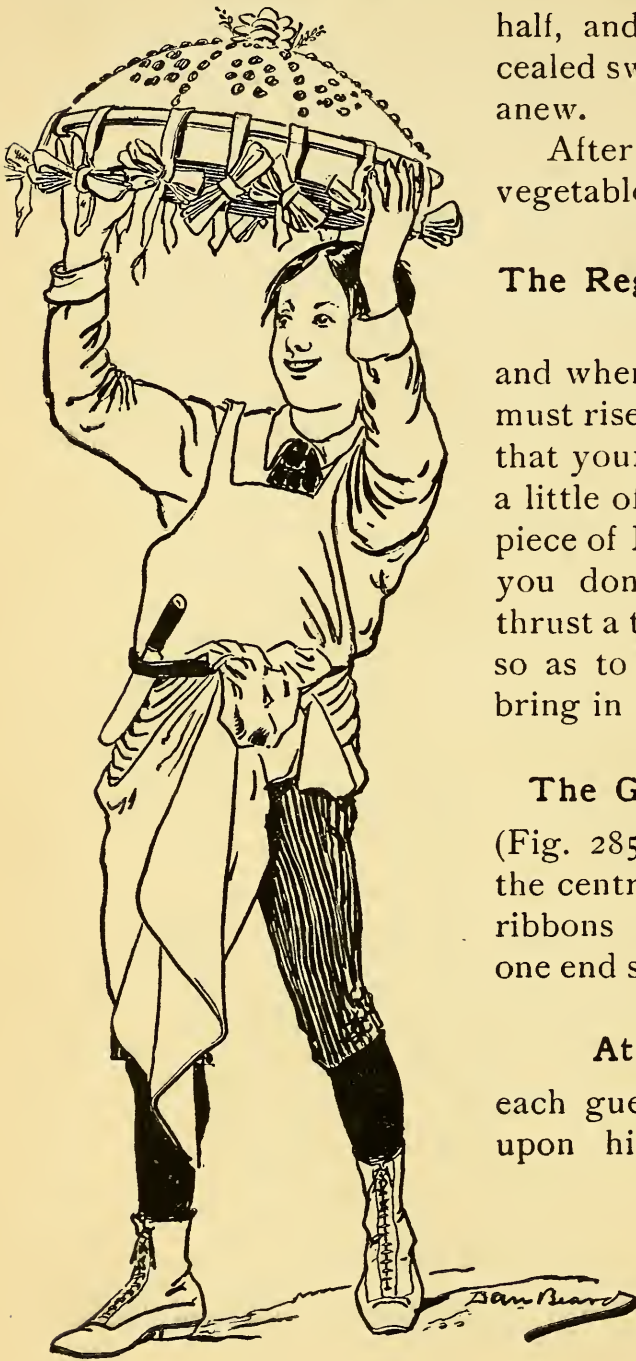

FIG. 285.—Bring in the Cake.

half, and discovered the concealed sweets, the fun will begin anew.

After this first course of vegetables

### **The Regular Spread May Be Served,**

and when all have finished you must rise and say that you hope that your guests have still kept a little of their appetites for a piece of March Hare pie. Then you don a big white apron, thrust a table-knife in your belt, so as to look like a cook, and bring in

### **The Great "Fake" Cake**

(Fig. 285). Place the cake in the centre of the table, with the ribbons carefully undone and one end stretched to each plate.

### **At a Given Signal**

each guest gives a sharp pull upon his line, and out pop all the brightly-colored parcels, while the bran and flour fly, as if an explosion had occurred.

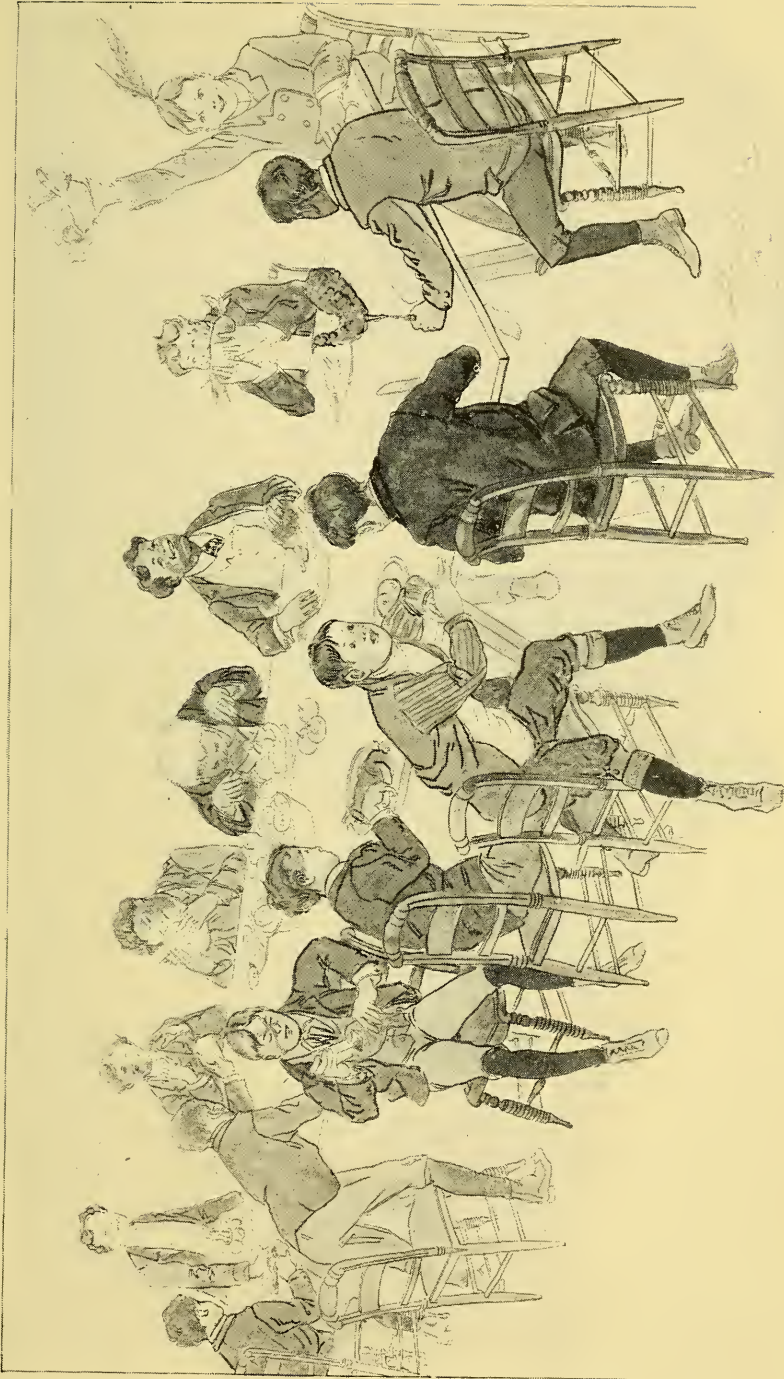

Feast of the Mad March Hare.



---

The success of this last act depends entirely upon the host. He must caution each boy not to gather in any of the slack of his ribbon, but only take a firm hold of the end and wait until the word is given to pull.

After the excitement and fun of demolishing the "fake" cake, then comes the fun of unrolling the bundles and reading the jokes attached to each trinket.



## CHAPTER XXIV.

### A WILD WEST SHOW IN THE HOUSE.

THERE are many boys to-day who have never seen an Indian, and while it is impossible for us all to view the real Wild West, it is not difficult for us to get up a little Wild West show of our own, at home.

#### Patterns Are Here Given,

which any intelligent boy can copy. The fields of the patterns given are divided into small squares, and the dividing lines are numbered and lettered along two sides of the pattern.

It is not hard to understand that, since every square, be it big or little, is exactly the same shape, by making the same number of larger squares you will have an enlarged field, similar to the one shown.

#### How to Reproduce the Patterns.

Place a clean piece of card-board on the table, and, with the aid of a straight-edged piece of board, rule a line close to the edge of the card-board and parallel to it.

By means of a two-foot measure, or tape-line, mark off with your pencil a point at each half-inch, to correspond with the numbered lines on the field (Fig. 286). Number the lines from one to thirty-three, as they are numbered in Fig. 286. Replace the straight-edged board along the line, take a large flat book (your geography will do), see that the

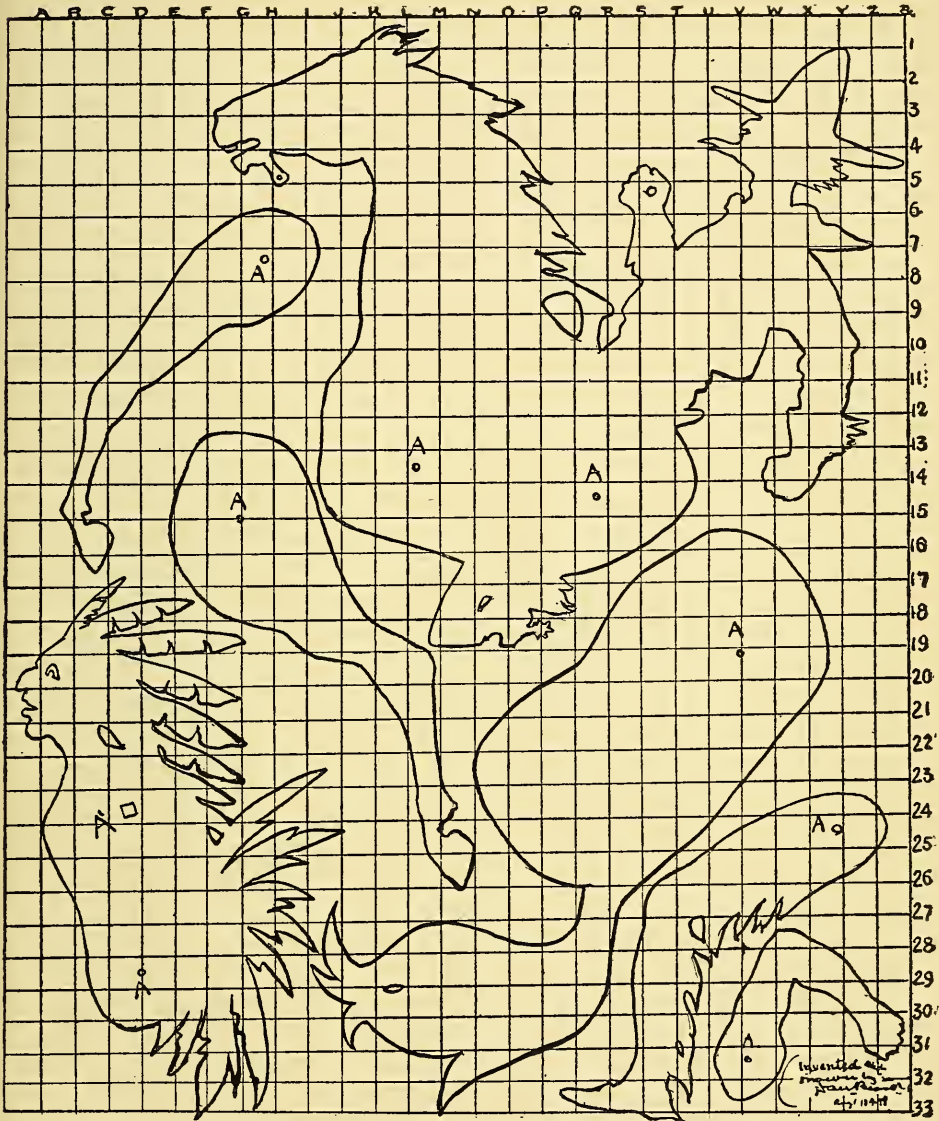

FIG. 286.—The Parts of Mounted Cowboy and Indian.

edge of the board is exactly parallel to the pencil line, and just far enough back of it to show the pencil dots, hold the board firmly in place, and slide the book along the edge of

the board, until the edge of the book is exactly at the first pencil dot.

### Rule the First Line

along the edge of the book, then move the book to the next

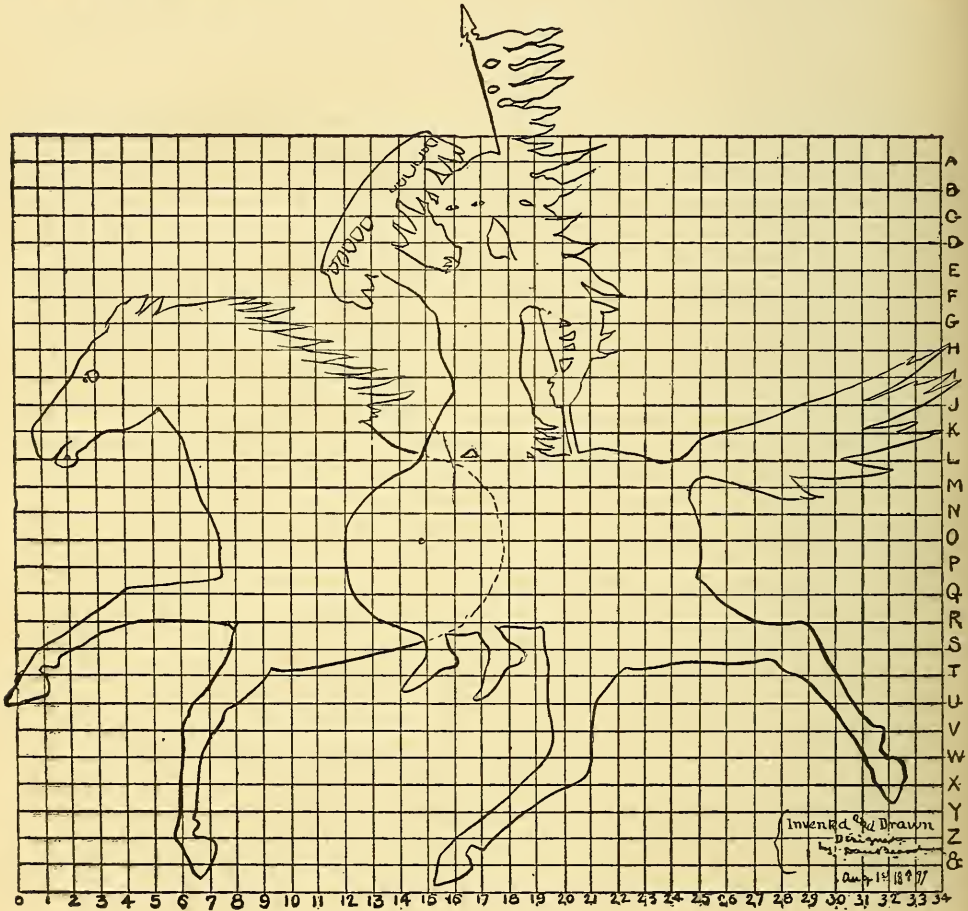

FIG. 287.—Mounted Indian.

dot and rule the line No. 1, then No. 2, and so on, until No. 33 is ruled.

### Again Take Your Two-foot

rule or tape measure, and mark off by pencil dots the points for the lines at A, B, C, D, etc.; do the same on the line

No. 33, and with your board ruler connect with lines the two sets of dots, and you will have a field of squares exactly similar to the one in Fig. 286, only much larger.

### **Next Trace Out the Cowboy,**

horse, and Indian, by drawing a line upon your enlarged field from point to point, as it is seen to cross the squares in the small pattern. In the pattern the Indian has but one leg and one arm, and the horse but one fore leg and one hind leg, but after these are cut out it is a simple matter to trace around them on card-board with a pencil, and thus supply all of the missing limbs.

### **After the Puppets Are Cut**

out, punch holes with a darning-needle at the points marked A; these are the joints, and the spots where the parts are joined by a piece of string.

### **Make a Round Knot**

in the end of a piece of string, so large that it will not pull through the needle-holes. Take the hind leg of the horse and thread the string through A, then through A upon the horse's hip, then through the hole in the other hind leg. Pull the string taut and, placing the puppet flat, tie a knot close to the leg ( Fig. 289).

### **How it is Done.**

To do this make a loose knot first, and with the forefinger of the left hand press the loop against the puppet while you slowly pull the free end taut (see Fig. 289). Tie it three or







A Bronco Buster.



and another piece to his head; then, by alternately pulling taut and allowing the thread to slacken, the horse will be found to jump, pitch, and buck, in a life-like and most approved Wild West manner. Fig. 290 (the page illustration) shows a photograph made from the puppet here described, and Figs. 291, 292, 293, and 294 are positions assumed by that puppet, and traced directly from the paper horse and rider.

### The Indian Horseman

(Fig. 287) shows how the body is joined; the dotted line indicates where the portion of the fore part of the body laps



under the hind part. In Fig. 287 the legs are not jointed as in Fig. 286. In drawing your pattern for this puppet make two fields of squares: one for the fore part and one for the hind part of the Indian and horse; and in Fig. 288 make three fields of squares, one for the hind legs, one for the body and one for the head. Both of the last diagrams are drawn on one field to save space; but you can easily understand how to reproduce them. For instance, in Fig. 287 make a field of squares from 0 to 18 for the fore part; make another field of squares from 12 to 34 for the hind quarters.

Make five or six duplicates of the Indian horseman;



make as many duplicates of the dancing Indians as may be required for your war-dance; do the same with

### The Buffalo,

until you have a herd of them. Paste the flat end of a stick to the buffalo's leg and fasten a thread to the neck and hind



FIG. 295.

legs, as shown by Fig. 288. With the stick you move the bison along, and with the string you make him throw up his head and hind legs in a most amusing and comical manner.

### A Piece of White Muslin,

stretched taut, with no wrinkles, will make your stage, and a light behind it will throw the shadows of your puppets on

the cloth. The stage should be surrounded with heavy curtains, to prevent the operators from being seen, and the light behind the stage from illuminating the room in front. A bicycle lamp or an ordinary candle will answer for the light. A sheet of smooth Manila paper makes a better stage than the white cloth; it may be tacked upon a frame, or the bottom edge be tacked to a kitchen table and the top to a rod, suspended from the ceiling. The table should be on the audience side of the screen, so that the showmen may have room to move their puppet-sticks along the inside edge of the table, and keep the puppets close to the screen of paper. By changing the cowboy's hat to a soldier's cap or helmet, and putting a sword or gun in his hand, you can make as many cavalymen from this pattern as you desire to have in the show.

## CHAPTER XXV.

### HOW TO HAVE A PANORAMA SHOW.

AFTER you have had a rollicking circus in the attic, and a roaring Wild West show in the basement, you can explain to your parents that a panorama is a show of a "highly moral" and most genteel character, and you may persuade them to allow you to have a panorama party in the dining-room.

#### A Good Panorama

is always a thing worth looking at, yet I promise you that there is more real enjoyment in making a panorama and exhibiting it, than there is in looking at twenty professional exhibitions.

#### The Subject

of the pictures must be your first thought. In their selection you have the widest possible range of choice, from the "Yankee in King Arthur's Court" to Roosevelt with the Rough Riders in Cuba, or from "The Pilgrim's Progress" to "Jack the Giant-killer," or "Mother Goose."

To those who have acquired the happy art of expressing their ideas with pencil and brush, the painting of an original panorama need not be explained; but the great majority of boys are unable to make pictures, either with pencil or with brush, and for them there remains still another method, which for beginners is equally, if not more effective.

**With Paste-pot and Shears,**

any boy, of ordinary ability, may make pictures galore by cutting the figures and even the backgrounds from illustrated papers, grouping and arranging them to suit himself, and pasting them neatly upon a long, strong strip or ribbon of paper, suited to winding and unrolling by means of two cylinders or rollers, as shown in Fig. 296.

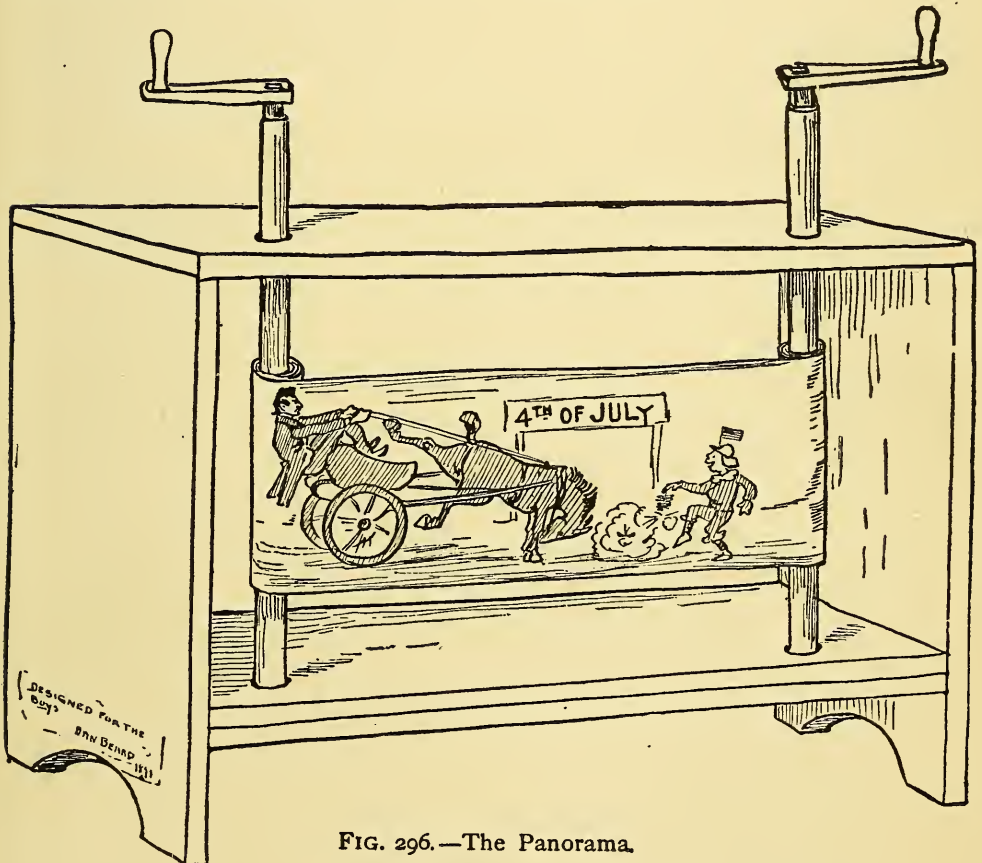

FIG. 296.—The Panorama.

**Select Your Topic**

first, then write out the number of illustrations you wish to make to tell the story; then hunt for a background here, a



foreground there, and houses and people wherever they may be found. Paste the background on your strip of paper first, then the foreground, and next add the necessary number of people, vehicles, animals, and other objects.

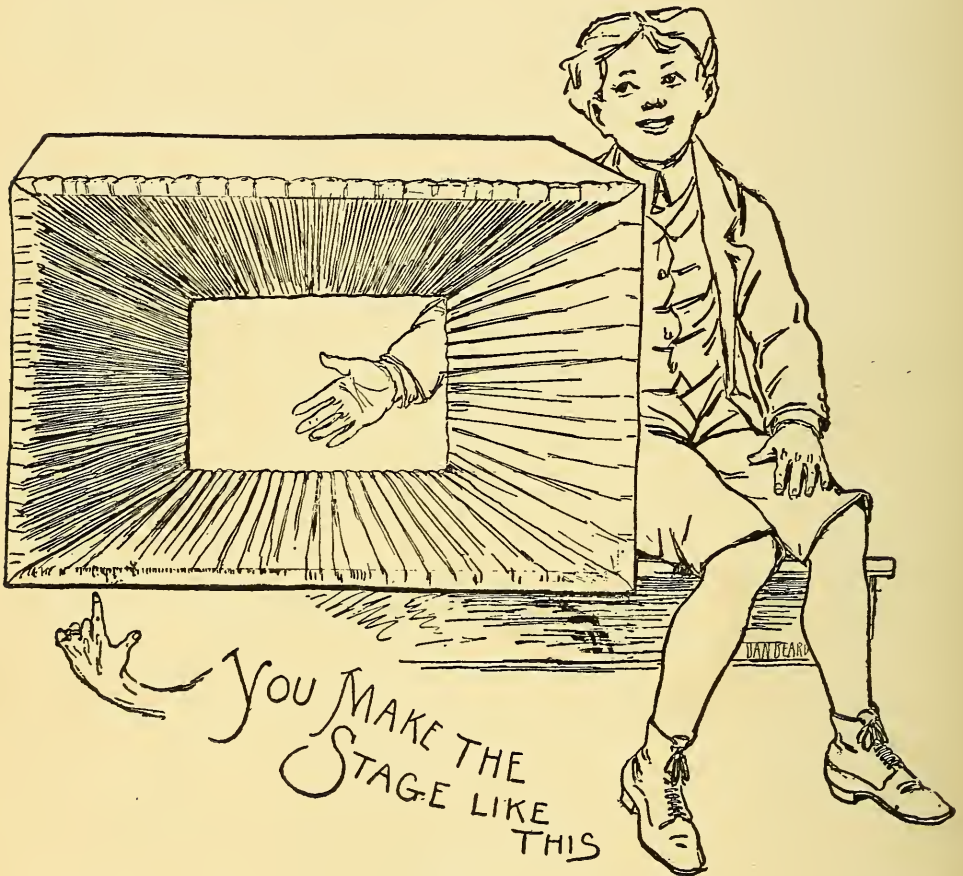

FIG. 297.

### Colored Figures,

upon a white background, will be found to be most effective. Giants may be made by taking large-sized prints of men, clipping off their heads and replacing the latter with heads of smaller men. Dwarfs may be made by using the small

prints of men, and substituting big heads for the ones originally belonging to the figures.

Fig. 296 shows

### **The Works of the Panorama,**

naked and unadorned. But the machinery should be concealed, and for this purpose make a box, similar to the one shown in Fig. 297, which is called the stage. It is simply a narrow box, as shown in Fig. 298, with drapery arranged from the outer edges to a small frame at the rear. Fig. 297 is the front of the finished stage; Fig. 298 is the rear of same, denuded of its drapery.

Hiding in the cellar, basement, attic, or woodshed, of almost every house, are a lot of packing-cases, but if from any cause these boxes should be absent from their accustomed places, you must go to your grocer for the material for your stage.

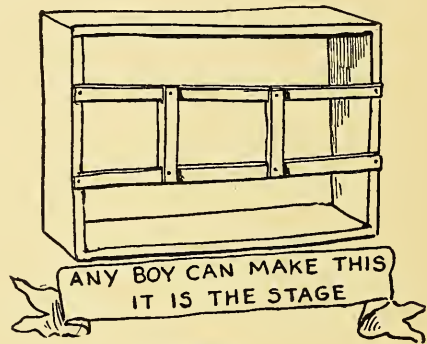

FIG. 298.

### **Build a Narrow Box,**

of about the proportions of Fig. 298, and make a frame of four sticks for the back of the box; notch the cross-sticks (Fig. 299) so that they will fit flush, or even, with the inside surface of the two long pieces (Fig. 300).

### **Cut Some Dark Red Canton Flannel**

into four pieces, to fit the four sides of your stage frame; plait the ends, and tack each plait as the drapery is tacked to the frame, as shown in Fig. 300.

After all four pieces of drapery are plaited and tacked fast, nail the frame to the back of the stage, as it is shown in



FIGS. 299 and 300.

Fig. 298; then, one piece at a time, spread the edges of the cloth over the front edges of the box of the stage and tack them there, as in Fig. 297. This will give you a dark-colored stage frame with a small opening at the back end for the panorama to slide by, as the crank of the roller is turned by the showman behind the curtain.

Curtains must be arranged to hang down on each side of the stage and be pinned together above and below it.

### The Stage

should rest upon a table, and be lighted by a row of small

Christmas-tree candles, or common candles cut off and made short.

Whatever lights are used, care should be taken to place them so that there will be no danger from fire.

Of course it is not absolutely necessary to use candles for

### Footlights.

Any sort of light which will illuminate the panorama without obstructing the view of the audience, will answer the purpose; but it is absolutely necessary to have no other

lights burning in the room while the panorama is being exhibited. All the light must be centred upon the pictures.

Fig. 301 shows

### How the Panorama Box

is built. There are two holes bored through the top board and through the upper bottom board, but not through the lower bottom board. A glance at the diagram will show you that there are two bottom boards, fitting closely together.

Before putting the panorama box together bore holes in the top board, at equal distances from the ends, and as near the front edge as you can conveniently bore them without danger of splitting the board. These holes are for the rollers, and should be of sufficient size to allow the

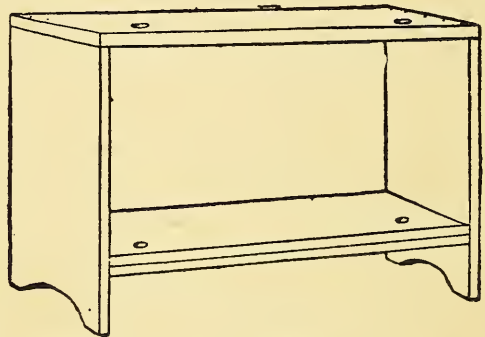

FIG. 301.—The Panorama Box.

rollers to revolve with little friction. In case you have no bit or auger which will make large holes, Fig. 302 shows how the difficulty may be overcome with a small bit, gimlet, or red-hot poker, by boring a number of small holes in a circle and then breaking out the centre-piece of wood; smoothing the inside with a sharp knife. In order that the holes in the bottom board shall be directly under those in the top, nail the bottom board to the top board with three wire nails, driving them in only just far enough to hold the boards together while the holes are being bored, as shown in Fig. 303. Since the

### Top Board

fits over the side-pieces, and the bottom boards fit between



the side-pieces, it is evident that the bottom boards are shorter than the top board by just the width of the two side-pieces. Be careful to allow for this width at the ends, when you nail the boards together, as shown in Fig. 303.

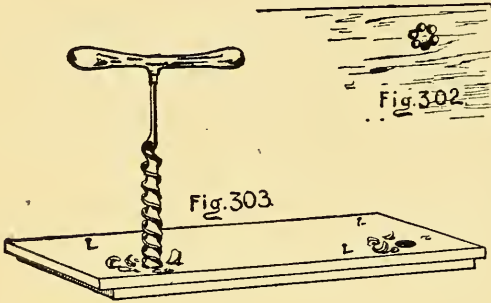

After the holes are bored through the two boards, nail the top board and bottom boards in place, as shown in Fig. 301.

You must, of course, put the bottom board with the holes in it, on top of the bottom board without the holes. This will give two sockets, in which to rest and turn the ends of the rollers.

### **Make the Rollers of Broomsticks,**

if you can secure nothing better, but if you can find some old window-shade rollers they will probably be an improvement on the broomsticks, as they have metal sockets in which they will turn with much less friction than in the wooden ones described above.

The rollers should both be of sufficient length to allow a convenient amount of stick to protrude from the top of the box, as is shown in Fig. 296.

### **A Crank or Windlass**

handle, of some kind, is necessary to turn the rollers, and Figs. 304 to 311 show how such handles may be made.

If you wish a comic panorama you have at your disposal a vast amount of material. The gorgeously-colored comic

prints of to-day lend themselves readily to the process of picture-making with paste-pot and shears, and all sorts of funny combinations can be produced, which will delight the

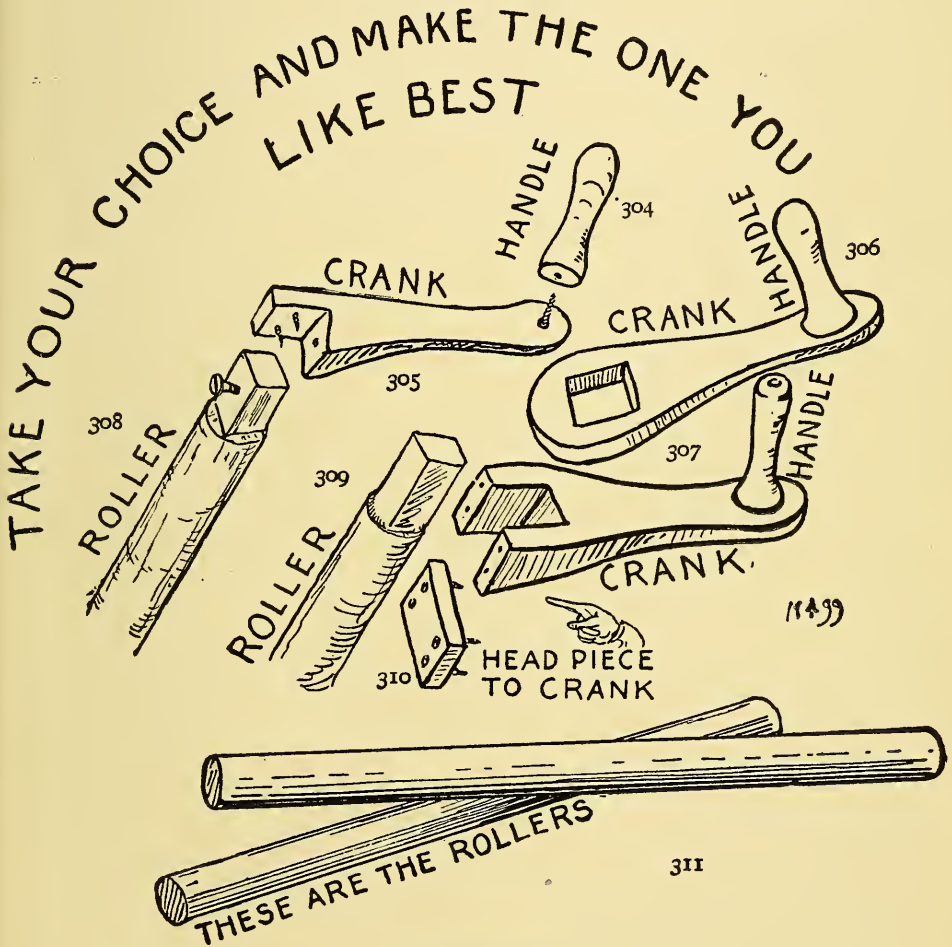

FIGS. 304-311.

audience, and, best of all, furnish indoor amusement and work for the reader when the weather is so boisterous, wet, and sloppy that there is no chance of fun out-of-doors, and

there are many such days, between January and May, each year.

When all is done, paint some

### Big Show-Bills,

to hang in the hallway, to be read and admired by the guests. Set the frame stage upon a small table, with the panorama box close against it; over the frame a small piece of dark cloth may be thrown, to be removed when the show begins.

The candles may be set upon a narrow strip of board, in front of the stage, and if you drive nails in groups of three, along the board, you will discover that the nails will hold

the candles secure, as shown in the arrangement of the footlights in Fig. 312.

In front of each candle set

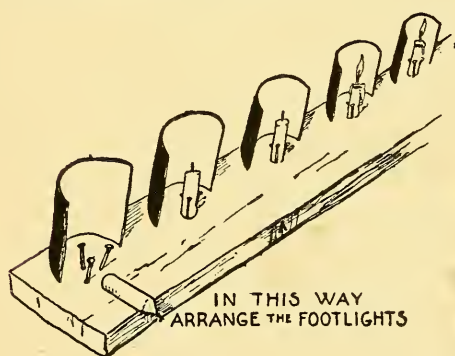

FIG. 312.

### A Square Piece of Tin

bent to a curve, and with the concave side next to the candle, to act as a reflector,

and the convex side next to the audience. The outsides should be painted dark red, to match the frame and conceal the light.

At the appointed time

### Turn Out All the Lights

in the room, light the footlights, and remove the cloth from the box, displaying the first scene.

---

One boy should stand in front, as lecturer, and explain the different pictures, and another boy stand behind the curtain, winding up the paper as directed by the lecturer. The audience will have a good time, in proportion to the fun the lecturer puts in his talk, and all will enjoy the show to

**THE END.**





# INDEX



# INDEX

## A

- Ancient mariners, 5
- Animals, kindness to, 33, 34
- Ape, evolution of, 234
- "Arab steed," how to make an, 254
- Army, to make a pasteboard, 217
- Artificial water, 206
- Aviary, how to make a back-yard, 63
- Axe, tree-top club-house built with, 10
- Axles, car-wheel, 172

## B

- Bantam coops, 55
- Beard, Frank, 224
- Beard, Santa Claus's, 249
- Bed, Daniel Boone cabin, 123; Lincoln, 124
- Binders, to make water club-house foundation, 101
- Birds, 63
- Bonbon box, the cabbage, 265
- Buffalo, to make a herd of, 276
- Bugles, wooden, 141
- Building material, house-boat, 150
- Bumpers, house-boat, 155
- Bunks, house-boat, 164
- Burgoo, Kentucky, 107; ingredients of a, 109; how to cook a, 109
- Burgoo master, 108, 109
- Bridge of matches, 206
- Bridle, to make a, 274

## C

- Cabin, how to build and furnish a Daniel Boone, 116; lumber for, 118; ground plan of 6 x 10, 119
- Cabin, house-boat, 157; street-car used as, 168
- Cage, to make a galvanized-wire netting, 39; receiving, 46
- Cake, the "Fake," 266, 268
- Camera, hunting with the, 20
- Camp dress, women's, 133
- Camping out. See Daniel Boone cabin, 116
- Carp, 52
- Carpet tacks as blow-gun darts, 264
- Cars, back-yard switchback, 170
- Catfish, 52
- Centrepiece, house-boat, 151
- Chalk talk, how to give a, 222
- Chestnut wood for foundation posts, 75
- Chickens, coops for, 54; need of shelter for, 54; material for coop, 56
- Chimney, Daniel Boone cabin, 130; stick, 131; Santa Claus's, 238
- Chipmonks, 19; how to trap, 26; food for, 26; wire cage for, 37
- Circus, a home-made, 191; in the attic, 253
- Clam-bake, the Rhode Island, 107
- Clams; fresh-water, in confinement, 53



Club-house, water, 97  
 Club-house, underground, 89  
 Club-house, a tree-top, 3; underground, 4; grape-vine approach to, 7; a two-tree, 9; selection of trees for, 10; how to build, 10; foundation of, 14; the vine-tree, 16; three- and four-tree foundation, 18  
 Coat, Santa Claus, 245  
 Cobblestones for bracing water club-house cribs, 102  
 "Collar," back-yard workshop, 80  
 Collins, Captain Bob, 141, 142  
 Cowboy, to make a, 273  
 Crank, panorama, 284  
 Crawfish, 52  
 Creepers, nests for, 65  
 Cribs, water club-house foundation, 100, 102  
 Crusoe clubs, 97  
 Crusoe raft, 150

## D

Dace, 52  
 Daniel Boone cabin, how to build and furnish a, 116; lumber for, 118  
 Darts, carpet-tacks as blow-gun, 264  
 Deck, house-boat, 160  
 Door, back-yard workshop, 82; underground club-house, 89, 95; back-yard zoo, 4; pigeon and bantam coop, 58; Daniel Boone cabin, 121, 125, 129  
 Drawing-board, chalk-talk, 225  
 Drinking-troughs for pigeons and bantams, 61

## E

Enihan. See Lawn hab-enihan, 114

## F

Feather-duster as a tail, 254  
 Fireplace, Daniel Boone cabin, 122, 128, 130; Santa Claus, 237, 243  
 First Gentleman. See Pitch-peg-pin pitching, 112  
 First Lady. See Pitch-peg-pin pitching, 112  
 Fish, food for, 53  
 Fish-pond, a back-yard, 48; how to stock, 52  
 Flat-boatman's horn, 139  
 Flooring, house-boat, 160  
 Floor-joists, Daniel Boone cabin, 120  
 Floor-supports, Daniel Boone cabin, 120  
 Flower-pots, bird-nests in, 68  
 Flying-cage for pigeons, 62  
 Flying-squirrel, trapping, 21, 23  
 Footlights, panorama stage, 282  
 Foundation, tree-top club-house, 9, 14, 18; back-yard workshop, 76; water club-house, 97, 99, 101; Daniel Boone cabin, 120  
 Foxes, wire cage for, 37; anecdote of, 38  
 Frame, tree-top club-house, 14; underground club-house, 92  
 Frogs, house for, 41; varieties of, 42; market for, 44; the Anderson, 45

## G

Games with toothpicks and matches, 201  
 Gnawers, 21; cages for, 37  
 Goldfish, 52  
 Gourds, martin nests in, 66  
 Grape basket, wren nests in, 66  
 Grandmother's reticule, 218

## H

- Hab. See Lawn hab-enihan, 114  
 Hanging-bars, 194  
 Hatch, house-boat, 160  
 Horn, flat-boatman's, 139; Captain Bob Collins's, 142; Wabash, 143; how to make a Wabash, 143; to make a Captain Bob Collins's, 142  
 House, how to make a pasteboard, 212  
 House-boat, canvas-cabined, 166  
 House-boat, how to build the American boy's, 146; cost of, 167 168

## I

- Indian, to make an, 273  
 Island, artificial, 104

## J

- Jack-fagots, 110  
 "Juggling board," 105  
 Johnson, Colonel Richard, 141

## K

- Kentucky burgoo, 107

## L

- Lamps for Daniel Boone cabin, 127  
 Lawn hab-enihan, 114  
 Lean-to, how to make a, 136  
 Level, a home-made, 74  
 Lizards, house for, 41, 46  
 Lockers, house-boat, 158, 164  
 Log house, how to build a, 116  
 Log-rolling, 121  
 Lumber for underground club-house, 92; for Daniel Boone cabin, 118

## M

- Machine shop, 83, 85  
 Making up, 262  
 Manicora, how to make the, 257  
 Matches, good games with, 201; a bridge of, 206  
 Mice, learning, 25; habits of, 27; white-footed, 24; as pets, 25; food for, 26  
 Mink, habits of, 31; how to trap, 31; author's anecdote of, 32  
 Moa, how to make the, 257  
 Motion, how to suggest, 230  
 Musk-rats, Captain John Smith's description of, 30; how to trap, 31; in captivity. 31; cage for, 37  
 Mussels, 53

## N

- Nails, frame of tree-top club-house fastened with, 12  
 Nests, pigeon and bantam, 60; birds'-nests in Washington's coat, 63; the speaking-horn, 63; woodpecker, 64; martin, 66; wren, 66; tin-can, 68

## O

- Oilcloth for underground club-house roof, 94  
 Oiled paper for glass, Daniel Boone cabin windows, 127  
 Oil-stove, 73  
 Old Dan Tucker, 110, 111, 112

## P

- Paddles, how to make, 193  
 Panorama box, how to make, 283  
 Panorama show, a, 218

Passageway, underground club-house, 93  
 Pattern, how to reproduce, for Wild West show, 270  
 Peepers, how to capture, 45  
 Pennsylvania pond stew, 107  
 Pheasants, cage for, 37  
 Picnic, how to have fun at a, 105  
 Picnic box, 106  
 Pigeons, lofts for, 54 ; material needed in making, 56 ; nests for, 60 ; drinking-troughs for, 61  
 Pitch-peg-pin pitching, 112  
 Plumb, a home-made, 75  
 Prairie chickens, cage for, 37  
 Purlins, back-yard workshop, 80

## Q

Quail, wire cage for, 37

## R

Rabbits, cage for, 37  
 Rafters of tree-top club-house, 14 ; back-yard workshop, 79 ; underground club-house, 94 ; house-boat, 160  
 Rat, 21 ; short-tailed meadow, 23, 26 ; wire cage for, 37  
 Receiving-cage, 21  
 Receiving-tank, bath-tub as, 191  
 Reins, Arab steed, 256  
 Reptiles, house for, 41  
 Ribs, house-boat, 156, 157 ; Arab steed, 255  
 Ridge-plank, how to make a, 79  
 Ringmaster, dress of, 259  
 River people, 147  
 River-rats, 5  
 Robinson Crusoe, 4

Rock bass, 52  
 Rodents, 21 ; cages for, 37  
 Rollers, panorama, 284  
 Roof, tree-top club-house, 14 ; underground club-house, 92, 94 ; Daniel Boone cabin, 123 ; house-boat, 162  
 Roost, pigeon and bantam, 60  
 Rowlocks, house-boat, 163  
 Rudder, house-boat, 162  
 Ruffed grouse, cage for, 37  
 Runway, doors for, 41

## S

Santa Claus, costume for, 245 ; how to make two boys into one, 248  
 Santa Claus fireplace, how to make a, 237  
 Sap-suckers, nests for, 65  
 Settlement, a pioneer, 208  
 Shack, how to make a, 135  
 Shanty, cost of a, 136  
 Show, a Wild West, 270 ; a panorama, 278  
 Show-bills, panorama, 286  
 Shutters for pigeon and bantam coops, 59  
 Sleigh, how to make a pasteboard, 211  
 Sleigh, Santa Claus's, 250  
 Slipperies, 182 ; war-time, 182  
 Smudge, capturing flying-squirrels with a, 22  
 Snakes, house for, 41 ; poisonous, 42 ; varieties of, 42 ; superstitions about, 43  
 Soldiers, to make pasteboard, 215  
 Speaking-horn, birds'-nests in, 63  
 Squirrel, cage for, 37  
 Stairs, water club-house, 103  
 Stability, emblem of, 229  
 Stage, panorama, 282

Stag-party, a boys', 263  
 Stars, to cut five- and six-pointed stars with one clip, 220  
 Starting platform, switchback railway, 173  
 Stool, cabin, 131  
 Street-car cabin, house-boat with, 168  
 Struts in tree-top club-house, 18  
 Sunfish, 52  
 Supplies, camp, 133  
 St. Nicholas, our American, 243  
 Swallows, 70, 71  
 Swiss Family Robinson, 4  
 Switchback, a back-yard, 170

## T

Table, log cabin, 131; supplies for, 137  
 Tank, back-yard fish-pond, 48, 49  
 Tar used on underground club-house roof, 94  
 Tents, cost of, 136  
 Ticket-chopper's box, 180  
 Toads, house for, 41; superstitions about, 43, 44  
 Toboggan room, 186  
 Toboggan slide, how to build a, 182; tropical, 184  
 Tools for building tree-top club house, 10; for making back-yard zoo, 35; for making back-yard fish-pond, 49; for back-yard workshop, 73; for making water club-house, 98; care of, 86  
 Tool-rack, 86, 88  
 Toothpicks, good games with, 201  
 Track, switchback railway, 178  
 Trap, mouse, 24, 25; the wooden box, 28; the tin-can, 29; a figure-4, 30  
 Trapping, 19

Tree-top club-house, 3  
 Turnpike zoo, 106  
 Turtles, house for, 41

## U

Underground club-house, 89

## V

Ventilation, underground club-house, 95, 96  
 Virginia soup, 107

## W

Wabash horn, 143  
 Walls, tree-top club-house, 14  
 Washington, birds'-nests in coat of, 63  
 Water-wheel, how to make a, 192  
 Wheels, switchback car, 170  
 Whittling, prevalence of, 139  
 Wig, Santa Claus's, 249  
 Wild West show, 270  
 Windlass, panorama, 284  
 Window, back-yard workshop, 82; Daniel Boone cabin, 121  
 Wire cloth, 36  
 Wire, galvanized iron, for back-yard zoo, 36; for pigeon loft and bantam-coop, 58  
 Wire netting, 36  
 Woodchucks, 19; as pets, 27; how to trap, 27; habits of, 30; cage for, 37  
 Woodpeckers, nests for, 65  
 Workshop, a boy's back-yard, 72; how to build, 77  
 Wren, nest for, 66

## Z

Zoo, a back-yard, 33





# The Jack of All Trades

## OR, NEW IDEAS FOR AMERICAN BOYS

By DANIEL C. BEARD

Profusely Illustrated. Square 8vo, \$2.00

“Every boy who is handy with tools of any sort will enjoy this book.”

—*Youth's Companion.*

“This book is a capital one to give any boy for a present at Christmas, on a birthday, or indeed at any time.”—*The Outlook.*

“Full of new ideas for active boys who like to use tools and see interesting things growing under their hands.”

—*N. Y. Tribune.*

“A perfect treasure-house of things that delight the soul of a boy and keep him happy and busy.”—*The Interior.*

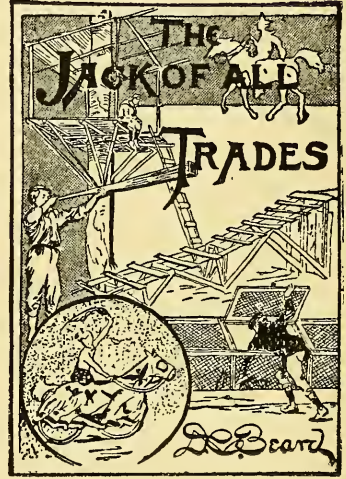

### CONTENTS

#### Part I. Fair Weather Ideas

Tree-Top Club-Houses—How to Capture and Trap Small Live Animals—The Back-Yard Zoo—A Back-Yard Fish-Pond—Pigeon and Bantam Coops—How to Make a Back-Yard Aviary—A Boy's Back-Yard Workshop—How to Build an Underground Club-House—A Boys' Club-House on the Water—How to Have Fun on a Picnic—How to Build and How to Furnish a Daniel Boone Cabin—Flat Boatman's House—The American Boy's House Boat—Back-Yard Switchback—How to Build a Toboggan Slide in the Back-Yard.

#### Part II. Rainy Weather Ideas

A Home-Made Circus—Good Games with Toothpicks and Matches—Fun with Scissors and Pasteboard and Paper—How to Prepare and Give a Boys' Chalk Talk—A Christmas Novelty for Boys—How to Make Two Boys into One Santa Claus—A Circus in the Attic—A Boys' Stag Party—A Wild West Show in the House—How to Have a Panorama Show.

---

CHARLES SCRIBNER'S SONS, Publishers

153-157 Fifth Avenue, New York

# The Outdoor Handy Book

FOR PLAYGROUND, FIELD AND FOREST

By DANIEL C. BEARD

With more than 300 Illustrations by the Author. Square 8vo, \$2.00

"It tells how to play all sorts of games with marbles, how to make and spin more kinds of tops than most boys ever heard of, how to make the latest things in plain and fancy kites, where to dig bait and how to fish, all about boats and sailing, and a host of other things which can be done outdoors. The volume is profusely illustrated and will be an unmixed delight to any boy."—*New York Tribune.*

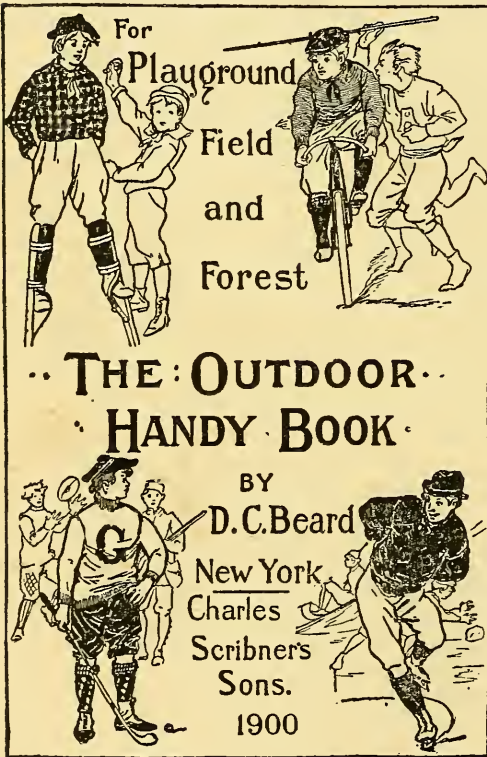

## SUMMARY OF CONTENTS

Marbles—Tops—Latest Things in Kites—Aerial Fish and Dragons—Hoops and Wheels—How to Make the Sucker—Up in the Air on Stilts—Bait, Live and Dead—Fishing—Aquatic Sports—Rigs of All Kinds for Small Boats—Shells and Canoes—Hints for Collectors—Honey-Bee Messengers—A "Zoo"—Choosing Up and "It"—Counting Out Rhymes—Swimming—Games of Tag—I Spy—Leap Frog—Various Sports for Hot Days—Tip Cat—Games of Ball—Mumbly Peg, Hop-Scotch, and Jack Stones—Hints for Bicyclists—Camping Out—Boy's Ballista—"Tally-ho!" and Other Cries—Indian Games for Boys—Football—Golf, Hockey, and Shinny—Turtle Hunting—Skating—Stunning Muskrats and Fish—Snowball Battle and Snow Tag—Sleds.

From CHARLES DANA GIBSON: "It makes a man of a boy and a boy of a man."

"This book is praiseworthy from end to end, and will find favor even with those who have long since passed to man's estate."—*The Nation.*

"It is one of the completest things of the kind ever written, and with it one can hardly conceive how a boy could be without pleasant and profitable amusement at any time. It treats of directions for every season of the year, in and out of doors, and on land and water. One of the best things about it is that it furnishes employment for a boy's ingenuity and mechanical skill. It seems as if this book must be destined to an immense popularity."

—*The Advance.*

# THE AMERICAN BOY'S HANDY BOOK

Or, What To Do and How To Do It

By DANIEL C. BEARD

One volume, 8vo, fully Illustrated by the Author, \$2.00

Mr. Beard's book tells the active, inventive, and practical American boy the things he really wants to know; the thousand things he wants to do, and the ten thousand ways in which he can do them, with the helps and ingenious contrivances which every boy can either procure or make. The author divides the book among the sports of the four seasons; and he has made an almost exhaustive collection of the cleverest modern devices, besides himself inventing an immense number of capital and practical ideas.

## SUMMARY OF CONTENTS

Kite Time—War Kites—Novel Modes of Fishing—Home-made Fishing Tackle—How to Stock, Make, and Keep a Fresh-water Aquarium—How to Stock and Keep a Marine Aquarium—Knots, Bends, and Hitches—Dredge, Tangle, and Trawl Fishing—Home-made Boats—How to Rig and Sail Small Boats—How to Camp Out Without a Tent—How to Rear Wild Birds—Home-made Hunting Apparatus—Traps and Trapping—Dogs—Practical Taxidermy for Boys—Snow Houses and Statuary—Winged Skaters—Winter Fishing—Indoor Amusements—How to Make a Magic Lantern—Puppet Shows—Home-made Masquerade and Theatrical Costumes—With many other subjects of a kindred nature.

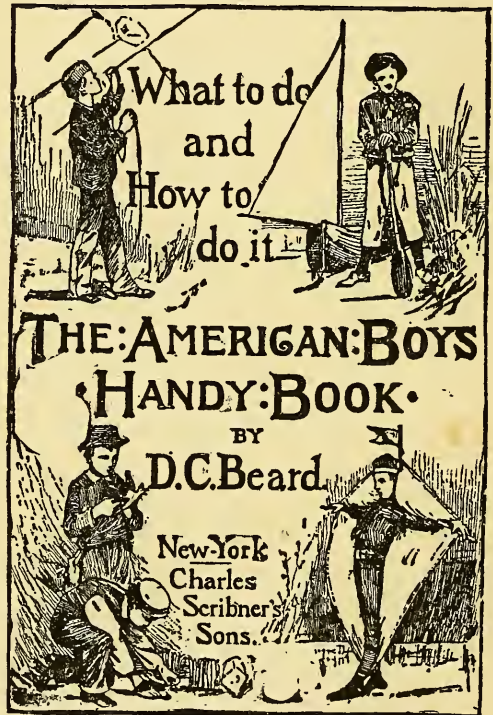

"It is an excellent publication, and is heartily recommended to parents."

—*The Brooklyn Eagle.*

"The book has this great advantage over its predecessors, that most of the games, tricks, and other amusements described in it are new. It treats of sports adapted to all seasons of the year; it is practical, and it is well illustrated."—*The New York Tribune.*

"It tells boys how to make all kinds of things—boats, traps, toys, puzzles, aquariums, fishing tackle; how to tie knots, splice ropes, to make bird calls, sleds, blow guns, balloons; how to rear wild birds, to train dogs, and do the thousand and one things that boys take delight in. The book is illustrated in such a way that no mistake can be made; and the boy who gets a copy of this book will consider himself set up in business."

—*The Indianapolis Journal.*



# THE AMERICAN GIRL'S HANDY BOOK

## HOW TO AMUSE YOURSELF AND OTHERS

By LINA and ADELIA B. BEARD

With nearly 500 Illustrations by the Authors

One volume, square 8vo, \$2.00

Eight new chapters have been added to the forty-two which have carried this famous book to the hearts of all the young people since its first appearance, and everything that the girls of to-day want to know about their sports, games, and winter afternoon and evening work, is told clearly and simply in this helpful and entertaining volume. The volume is fully and handsomely illustrated from drawings by the authors, whose designs are in the best sense illustrative of the text.

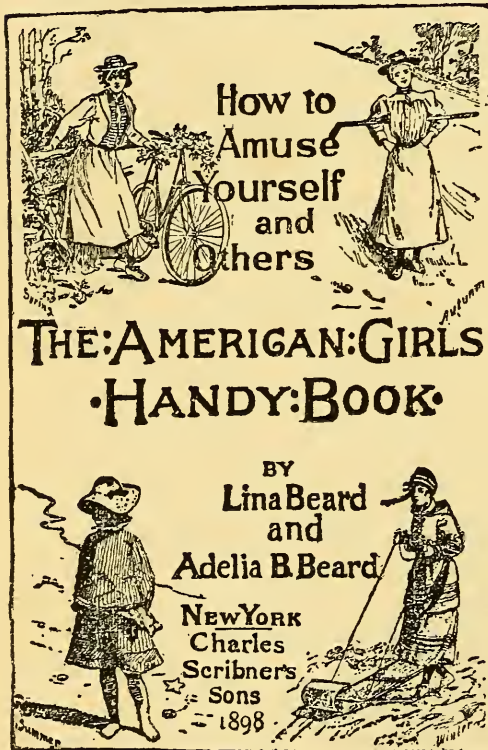

### SUMMARY OF CONTENTS

First of April—Wild Flowers and  
Their Preservation—The Walking  
Club—Easter-Egg Games—How to  
Make a Lawn Tennis Net—May-  
Day Sports—Midsummer - Eve  
Games and Sports—Sea-side Cot-  
tage Decoration—A Girl's Fourth  
of July—An Impression Album—  
Picnics, Burgooos, and Corn-Roasts  
—Botany as Applied to Art—Quiet  
Games for Hot Weather—How to  
Make a Hammock—Corn - Husk  
and Flower Dolls—How to Make  
Fans—All Hallow Eve—Nature's  
Fall Decorations and How to Use  
Them—Nutting Parties—How to  
Draw, Paint in Oil-colors, and  
Model in Clay and Wax—China  
Painting—Christmas Festivities,  
and Home-made Christmas Gifts—  
Amusements and Games for the  
Holidays—Golf—Bicycling—Swim-  
ming—Physical Culture—Girls'  
Clubs—A New Seashore Game—  
Apple Target Shooting—Water  
Fairies.

LOUISA M. ALCOTT wrote: "I have put it in my list of good and useful books for young people, as I have many requests for advice from my little friends and their anxious mothers. I am most happy to commend your very ingenious and entertaining book."

GRACE GREENWOOD wrote: "It is a treasure which, once possessed, no practical girl would willingly part with. It is an invaluable aid in making a home attractive, comfortable, artistic, and refined. The book preaches the gospel of cheerfulness, industry, economy, and comfort."



Beard  
Jack of

BOSTON PUBLIC LIBRARY



3 9999 06561 555 9

OCT 18 Feb 10 '60  
 NOV 28 Apr 27 60  
 NOV 10  
 DEC 8 Jun 29 60  
 FEB 9  
 MAR 9  
 JUN 22  
 JAN 9  
 AUG 10 Feb 7 '64  
 JAN 9 Feb 21 '64  
 JAN 30 Aug 26 '70  
 FEB 8 Jan 14 75  
 OCT 27  
 DEC 9  
 FEB 18  
 Feb 1 '56  
 Jan. 6 '59





