

Spitzer View of the Galactic Center

This new infrared mosaic from NASA's Spitzer Space Telescope offers a stunning view of the stellar hustle and bustle that takes place at our Milky Way galaxy's center. The picture shows throngs of mostly old stars, on the order of hundreds of thousands, amid fantastically detailed clouds of glowing dust lit up by younger, massive stars.

The Milky Way's core is indeed a very busy place. Stars are packed together like subway riders as they race around the supermassive black hole that lies at the very center. Our sun is located 26,000 light-years away in a more peaceful, spacious neighborhood, out in the galactic suburbs. It circles the galaxy about every 225 million years, which amounts to 20 trips over the course of its 4.5-billion-year lifetime. In contrast, stars at the galactic center complete one lap in only a few million years or less.

Viewing the center of the Milky Way from Earth can be difficult because the plane of the galaxy's spiral disk is filled with cold dust. Visible light coming from this distant region is virtually impossible to observe because dust dims it by a factor of one trillion. But infrared light can shine through this dust. The infrared light in this Spitzer view has wavelengths about 10 times longer than what the human eye can see, and is dimmed only about four times.

This infrared advantage, combined with Spitzer's superb image quality, has resulted in the deepest and sharpest view yet of an expansive stretch of the galactic center. The pictured region, located in the Sagittarius constellation, is 900 light-years across. It covers the same area on the sky that a grid of four by three full moons would occupy.

Features within the new mosaic include dust clouds of a dizzying variety, such as glowing filaments, wind-blown lobes flapping outward from the plane of the galaxy, and finger-like pillars. The Spitzer image also shows newborn stars just beginning to break out of their dark and dusty cocoons and exquisitely detailed dark clouds so dense they are opaque even in infrared wavelengths. Some of these features are located near the physical center of our galaxy, while others lie closer to Earth.

This Spitzer image is a three-color composite of infrared light, showing emission from wavelengths of 3.6 microns (blue), 4.5 microns (green), 5.8 (orange), and 8.0 microns (red). A micron is one millionth of a meter; a human hair is about 100 microns thick. The Jet Propulsion Laboratory, California Institute of Technology, manages the Spitzer Space Telescope for NASA.



Credit: Digitized Sky Survey (DSS)

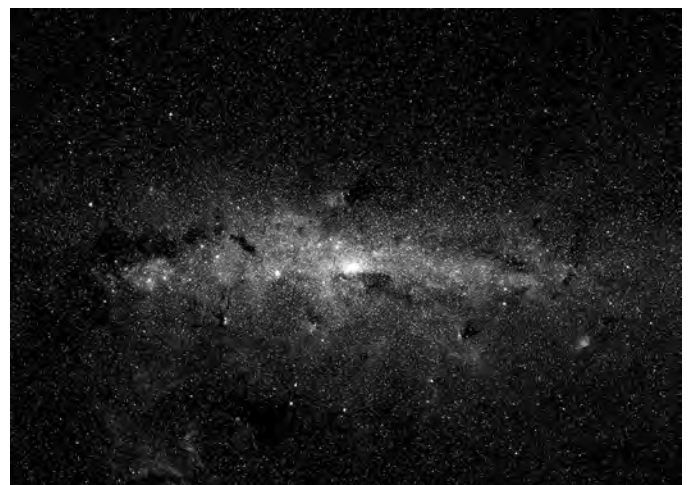

Credit: NASA/JPL-Caltech/S. Stolovy (SSC/Caltech)

In visible light (left), the center of the Milky Way is not visible because of dust that visible light cannot penetrate. Only stars between our Sun and the galactic center are visible. But in infrared light (right), the cluster of stars at the center of the galaxy can be seen.

What Is Infrared?

We learn much about the world around us by using our eyes. Think about all of the information you obtain and process by simply looking at the world around you. Our eyes are sophisticated detectors that have biologically evolved to "see" visible (or optical) light. There are, however, many other types of light – or radiation – which we cannot see without the aid of technology. Visible light is one of the few types of radiation that can penetrate our atmosphere and be detected on Earth's surface. We can only see a very small part of the entire range of radiation called the electromagnetic spectrum.

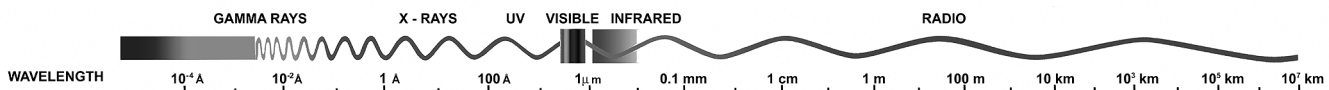

The electromagnetic spectrum includes gamma rays, X-rays, ultraviolet, visible, infrared, microwaves, and radio waves. The only difference between these different types of radiation is their wavelength or frequency. Wavelength increases and frequency (as well as energy and temperature) decreases from gamma rays to radio waves. All of these forms of radiation travel at the speed of light (186,000 miles or 300,000,000 meters per second in a vacuum). In addition to visible light, radio, some infrared, and a very small amount of ultraviolet radiation reaches Earth's surface from space. Fortunately for us, our atmosphere blocks out the rest, much of which is very hazardous for life on Earth.

Infrared radiation lies between the visible and microwave portions of the electromagnetic spectrum. Infrared waves have wavelengths longer than visible light and shorter than microwaves, and have frequencies which are lower than visible light and higher than microwaves. The primary source of infrared radiation is heat or thermal radiation. This is the radiation produced by the motion of atoms and molecules in an object. The higher the temperature, the more the atoms and molecules move and the more infrared radiation they produce. All objects put out some infrared radiation. Even objects that we think of as being very cold, such as an ice cube, emit infrared. When an object is not quite hot enough to radiate visible light, it will emit most of its energy in the infrared. For example, hot charcoal may not give off light but it does emit infrared radiation which we feel as heat. The warmer the object, the more infrared radiation it emits.

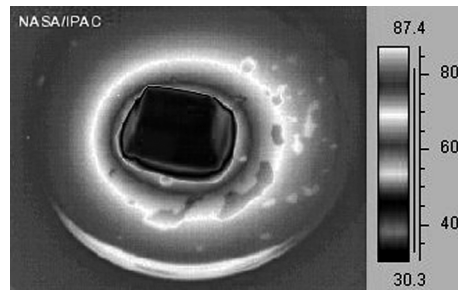
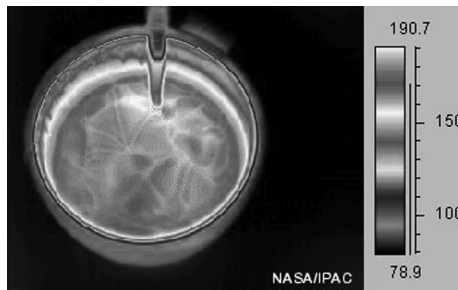

To the left (above) is an infrared image of a metal cup holding a very hot drink. Notice the rings of temperature showing heat traveling from the liquid through the metal cup. You can see this in the metal spoon as well. To the right is an infrared image of a melting ice cube. Notice the rings of different temperatures showing how the melt water warms as it travels away from the cube. Although the ice cube is cold, it still puts out heat. Infrared images give us valuable information about the heat being emitted by objects and how this heat is distributed. By using infrared telescopes, astronomers can detect and learn about objects that are too cold to be seen in visible light. This is useful in the hunt for planets outside of our solar system, the search for asteroids, and the study of regions of cool dust in space.

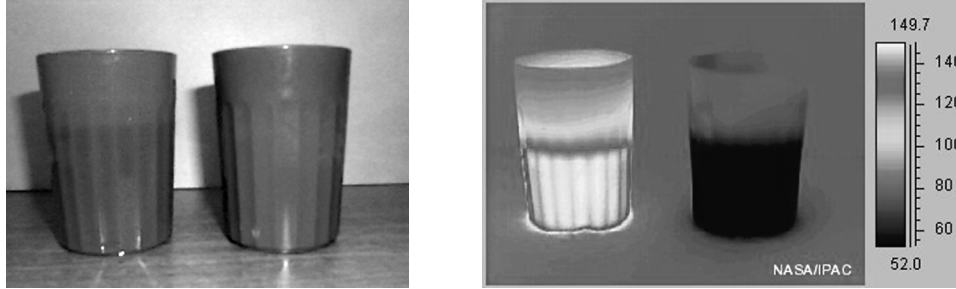

Above is a visible-light picture (left) and an infrared picture (right) of two cups. One cup contains cold water, while the other contains hot water. In the visible light picture we cannot tell which cup is holding cold water and which is holding hot water. In the infrared image, we can clearly "see" the glow from the hot water in the cup to the left and the dark, colder water in the cup to the right. If we had infrared eyes, we could tell if an object was hot or cold without having to touch it.

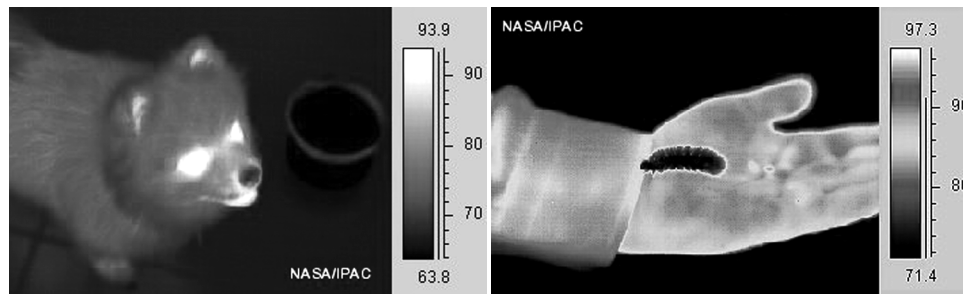

Above are infrared images of a warm-blooded dog (left) and of a warm-blooded human holding a cold-blooded caterpillar (right). Warm-blooded animals, like the dog shown above, make their own heat. In the infrared picture you can see how the dog's fur keeps some of this heat from escaping, keeping the dog warm. Insects are cold-blooded, which means that they cannot make their own body heat. Instead they take on the temperature of their surroundings. The cold-blooded caterpillar appears very dark (cool) in the infrared compared to the warm-blooded human who is holding it. Notice how the caterpillar is at about the same temperature as the surrounding air. Infrared images give us a unique view of the world and the universe around us.

Infrared light can travel through thick smoke, dust or fog, and even some materials. On the right is a visible (left) and infrared (right) view of a scientist's hand inside a black plastic bag. In the visible image, the hand cannot be seen. In the infrared image, however, the heat from the hand can travel through the bag and can be seen by a thermal infrared camera. Infrared light can pass through many materials which visible light cannot pass through. However, the reverse is also true. There are some materials which can pass visible light but not infrared. Notice the scientist's glasses! Infrared radiation cannot easily travel through glass. Since this person's body heat cannot travel through her glasses, they appear dark. Because infrared light can pass through dust, astronomers use infrared telescopes to study objects in space, like newly forming stars, which are hidden behind thick clouds of dust and gas. These new stars cannot be seen by visible light telescopes.



We experience infrared radiation every day. The heat that we feel from sunlight, a fire, a radiator, or a warm sidewalk is infrared. Our bodies emit infrared radiation at a wavelength of about 10 microns (a micron is one millionth of a meter). The development of infrared detectors has allowed us to see the world and our universe in this new light, leading to numerous benefits and discoveries. From search and rescue, medicine, and navigation, to the study of weather, oceans, and the cosmos, the ability to "see" in the infrared has not only saved lives, but has opened up a whole, new world to explore.

Infrared Astronomy

Objects in space emit many types of electromagnetic radiation which cannot be detected by optical telescopes. Each type of radiation (or light) brings us unique information. To get a complete picture of the Universe we need to see it in all of its light, using each part of the electromagnetic spectrum! Technological developments over the past seventy years have led to electronic detectors capable of seeing light that is invisible to human eyes. In addition, we can now place telescopes on satellites and on high-flying airplanes which operate above the obscuring effects of Earth's atmosphere. This combination has led to a revolution in our understanding of the Universe.

Infrared Astronomy involves the detection and study of radiation emitted from objects in the Universe in the infrared portion of the electromagnetic spectrum. All objects in the Universe emit infrared radiation. Only a few narrow bands of infrared light can be observed by ground-based observatories. To view the rest of the infrared Universe we need to use space based observatories or high-flying aircraft. Infrared is primarily heat radiation and special detectors cooled to extremely low temperatures are needed for most infrared observations. Since infrared can penetrate thick regions of dust in space, infrared observations are used to peer into star-forming regions and into the central areas of our galaxy. Cool stars and cold interstellar clouds which are invisible in optical light are also observed in the infrared. Many interstellar molecules (including organic molecules) can only be detected in the infrared. Infrared observations also give us valuable information about the early Universe.

Exploring the Hidden Universe

In space, there are many regions which are hidden from optical telescopes because they are embedded in dense regions of gas and dust. However, infrared radiation, having wavelengths which are much longer than visible light, can pass through dusty regions of space. This means that we can study objects hidden by gas and dust in the infrared, which we cannot see in visible light, such as the center of our galaxy and regions of newly forming stars. Infrared studies of star forming regions give us detailed information on how stars are born, and help us learn more about how our own Sun and solar system were formed.

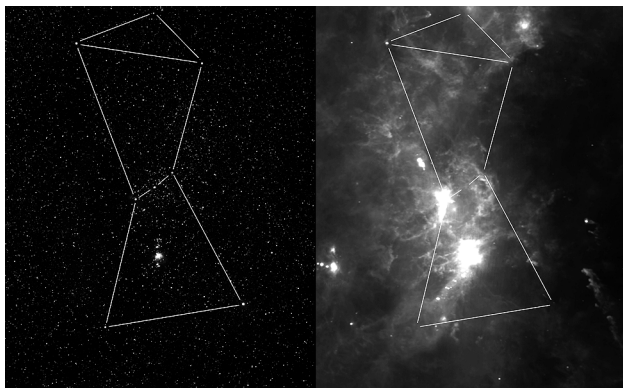

Credit: Visible: Courtesy of Howard McCallon; Infrared: NASA/IRAS

These two views of the constellation Orion, dramatically illustrate the difference between the familiar visible-light view (left) and the richness seen in the infrared (right) that is invisible to our eyes. The Orion Nebula is one of the nearest stellar nurseries where new stars are being formed.

The center of our galaxy is not visible at optical wavelengths because it is hidden behind extremely dense regions of gas and dust. However we can view the center of our galaxy in the infrared. The center of our galaxy is one of the brightest infrared sources in the sky. Infrared observations show that the center of our galaxy consists of a very dense crowding of stars, and that stars and gases near the center are orbiting very rapidly (probably due to the existence of a black hole).

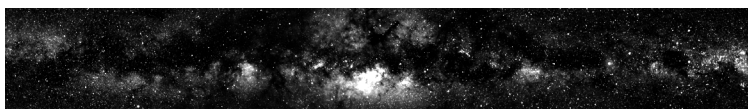

Credit: Visible: Axel Mellinger, University of Potsdam, Germany; Infrared: Two Micron All Sky Survey (2MASS)



The images above, of the central region of our own Milky Way Galaxy, show how areas which cannot be seen in visible light (left) can show up very brightly in the infrared (right). The visible light image shows us the light from billions of stars, particularly the largest, brightest ones. Note the dark bands where vast clouds of dust block our view of more distant objects. In the infrared image, we can see the "glow" from these visibly dark regions. The thick dust, which is colder than the coldest arctic night on earth, is still warm enough to emit the infrared radiation seen here.

The dusty, star-studded arms of a nearby spiral galaxy, Messier 81, are illuminated in the infrared image (right) from Spitzer. Much of the infrared emission comes from dustier parts of the galaxy where new stars are forming. The image shows the power of infrared telescopes to explore regions invisible in optical light (left), and to study star formation on a galactic scale.

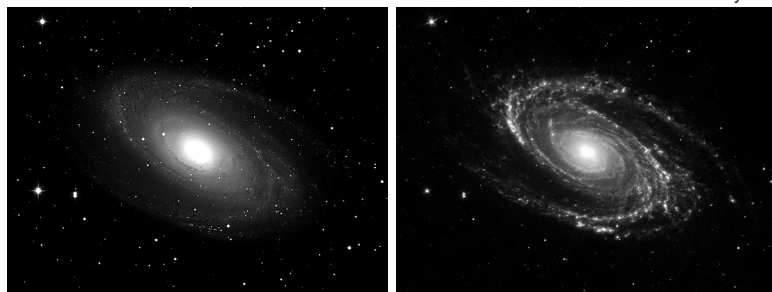

Credit: Visible: N.A. Sharp (NOAO/AURA/NSF); Infrared: NASA/JPL-Caltech/K. Gordon (University of Arizona) & S. Willner (Harvard-Smithsonian CfA)

Detecting Cool Objects - The Hunt for Planets

Many objects in the Universe which are much too cool and faint to be detected in visible light, can be detected in the infrared. These include cool stars, infrared galaxies, clouds of particles around stars, cool interstellar clouds, interstellar molecules, brown dwarfs and planets. In the 1980s, astronomers using the first infrared telescope in space, IRAS, discovered about two dozen stars which had infrared-emitting dust surrounding them. This discovery inspired astronomers to make more detailed observations of these stars. What they found around these stars were flat, disk-shaped, areas of dust in which planets had formed or could be forming. These findings have led the way to one of the most exciting new areas of research in astronomy – the search for planets around other stars. The

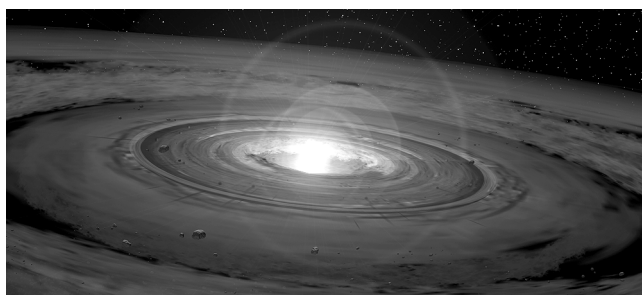

discovery of these disks provided the first significant evidence that other solar systems might exist. Since then, infrared observations have led to the discovery of many more planet-forming disks. The visible light from a planet is hidden by the brightness of the star that it orbits. In the infrared, where planets have their peak brightness, the brightness of the star is reduced, making it possible to detect a planet in the infrared. Future infrared telescopes are planned which will have the resolution needed to image possible extrasolar planets directly.

Exploring the Early Universe

In the infrared, astronomers can gather information about the Universe as it was a very long time ago and study the early evolution of galaxies. As a result of the Big Bang (the tremendous explosion which marked the beginning of our Universe), the Universe is expanding and most of the galaxies within it are moving away from each other. Astronomers have discovered that all distant galaxies are moving away from us and that the farther away they are, the faster they are moving. This recession of galaxies away from us has an interesting effect on the light emitted from these galaxies. When an object is moving away from us, the light that it emits is “redshifted.” This means that the wavelengths get longer and are shifted towards the red part of the spectrum. This effect, called the Doppler effect, is similar to what happens to sound waves emitted from a moving object. For example, if you are standing next to a railroad track and a train passes you while blowing its horn, you will hear the sound change from a higher to a lower frequency as the train passes you by. As a result of this Doppler effect, at very large redshifts, much of the visible and ultraviolet light from distant sources is shifted into the infrared part of the spectrum by the time it reaches our telescopes. This means that the only way to study this light is in the infrared. To understand how the first stars and galaxies were formed in the early Universe, it is essential to probe at infrared wavelengths. Infrared astronomy can provide valuable information about how and when the Universe was formed and about what conditions in the early Universe were like.

Adding To Our Knowledge Of Visible Objects

Objects which can be seen in visible light can also be studied in the infrared. Infrared astronomy can not only allow us to discover new objects and view previously unseen areas of the Universe, but it can add to what we already know about visible objects. To get a complete picture of any object in the Universe we need to study all of the radiation that it emits. Infrared Astronomy has added, and will continue to add, a great deal to our knowledge about the Universe and the origins of our Solar System.

The Spitzer Space Telescope

The Spitzer Space Telescope was launched into space by a Delta rocket from Cape Canaveral, Florida on August 25, 2003. During its mission, Spitzer will obtain images and spectra by detecting the infrared energy, or heat, radiated by objects in space between wavelengths of 3 and 160 microns (1 micron is one-millionth of a meter).

Consisting of an 85-centimeter telescope and three cryogenically-cooled science instruments, Spitzer is the largest infrared telescope ever launched into space. It will give us a unique view of the Universe and allow us to peer into regions of space which are hidden from optical telescopes. Many areas of space are filled with vast, dense clouds of gas and dust which block our view. Infrared light, however, can penetrate these clouds, allowing us to peer into regions of star formation, the centers of galaxies, and into newly forming planetary systems. Infrared also brings us information about the cooler objects in space, such as smaller stars which are too dim to be detected by their visible light, extrasolar planets, and giant molecular clouds. Also, many molecules in space, including organic molecules, have their unique signatures in the infrared.



Because infrared is primarily heat radiation, the telescope must be cooled to near absolute zero (-459 degrees Fahrenheit or -273 degrees Celsius) so that it can observe infrared signals from space without interference from the telescope's own heat. Also, the telescope must be protected from the heat of the Sun and the infrared radiation put out by the Earth. To do this, Spitzer carries a solar shield and was launched into an Earth-trailing solar orbit. This unique orbit places Spitzer far enough away from the Earth to allow the telescope to cool rapidly without having to carry large amounts of coolant. This innovative approach has significantly reduced the cost of the mission.

Why Send Telescopes into Space?

The amazing variety of objects in our Universe send us light all across the electromagnetic spectrum. However, much of this light (or radiation) does not reach us at ground level here on Earth. Why? Because we have an atmosphere which blocks out certain types of radiation, while letting other types through. Fortunately for life on Earth, our atmosphere blocks out harmful high-energy radiation like x-rays, gamma rays and most of the ultraviolet rays. The atmosphere also absorbs most of the infrared radiation which reaches Earth from space. On the other hand, our atmosphere is transparent to visible light, most radio waves, and small windows within the infrared region.

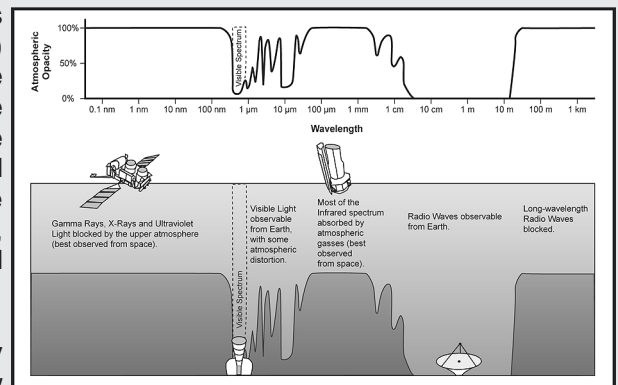

Most of the infrared light coming to us from the Universe is absorbed by water vapor and carbon dioxide in Earth's atmosphere. Only in a few narrow wavelength ranges, can infrared light make it through (at least partially) to a ground-based infrared telescope. Earth's atmosphere causes another problem for infrared astronomers. The atmosphere itself radiates strongly in the infrared, often putting out more infrared light than the object in space being observed.

So the best view of the infrared universe from ground-based telescopes is at infrared wavelengths which can pass through Earth's atmosphere and at which the atmosphere is dim in the infrared. Ground-based infrared observatories are usually placed near the summit of high, dry mountains to get above as much of the atmosphere as possible. Even so, most infrared wavelengths are completely absorbed by the atmosphere and never make it to the ground. The only way to observe these wavelengths is to get high above the atmosphere.

For the most part, everything we learn about the Universe comes from studying the light (or electromagnetic radiation) emitted by objects in space. To get a complete picture of any object in the Universe, we need to examine it in all of its light, using the information sent to us at all wavelengths. This is why it is so important to send observatories, like the Spitzer Space Telescope, into space, to get above our atmosphere which prevents so much of this valuable information from reaching us. Spitzer's instruments are designed to study radiation between wavelengths of 3 and 180 microns. Most of this infrared radiation is blocked by Earth's atmosphere and cannot be observed from the ground.

Herschel Infrared Experiment

PURPOSE/OBJECTIVE: To perform a version of the experiment of 1800, in which a form of radiation other than visible light was discovered by the famous astronomer Sir Frederick William Herschel.

BACKGROUND: Herschel discovered the existence of infrared light by passing sunlight through a glass prism in an experiment similar to the one we describe here. As sunlight passed through the prism, it was dispersed into a rainbow of colors called a *spectrum*. A spectrum contains all of the visible colors that make up sunlight. Herschel was interested in measuring the amount of heat in each color and used thermometers with blackened bulbs to measure the various color temperatures. He noticed that the temperature increased from the blue to the red part of the visible spectrum. He then placed a thermometer just beyond the red part of the spectrum in a region where there was no visible light -- and found that the temperature was even higher! Herschel realized that there must be another type of light beyond the red, which we cannot see. This type of light became known as *infrared*. *Infra* is derived from the Latin word for "below." Although the procedure for this activity is slightly different than Herschel's original experiment, you should obtain similar results.

Figure 1

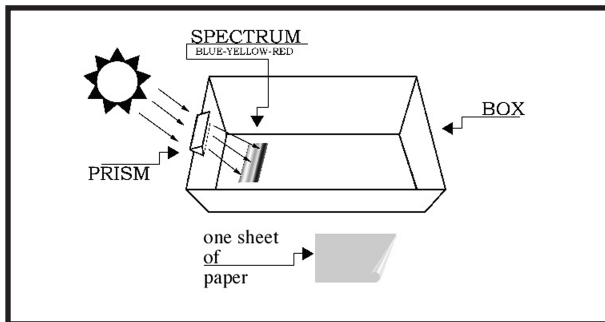

MATERIALS: One glass prism (plastic prisms do not work well for this experiment), three alcohol thermometers, black paint or a permanent black marker, scissors or a prism stand, cardboard box (a photocopier paper box works fine), one blank sheet of white paper.

PREPARATION: You will need to blacken the thermometer bulbs to make the experiment work effectively. One way to do this is to paint the bulbs with black paint, covering each bulb with about the same amount of paint. Alternatively, you can also blacken the bulbs using a permanent black marker. (Note: the painted bulbs tend to produce better results.) The bulbs of the thermometers

are blackened in order to absorb heat better. After the paint or marker ink has completely dried on the thermometer bulbs, tape the thermometers together such that the temperature scales line up as in Figure 2.

PROCEDURE: The experiment should be conducted outdoors on a sunny day. Variable cloud conditions, such as patchy cumulus clouds or heavy haze will diminish your results. The setup for the experiment is depicted in Figure 1. Begin by placing the white sheet of paper flat in the bottom of the cardboard box. The next step requires you to carefully attach the glass prism near the top (Sun-facing) edge of the box.

Figure 3

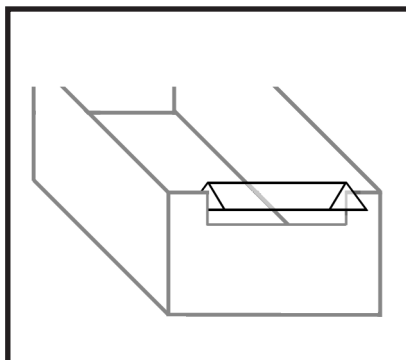

If you do not have a prism stand (available from science supply stores), the easiest way to mount the prism is to cut out an area from the top edge of the box. The cutout notch should hold the prism snugly, while permitting its rotation about the prism's long axis (as shown in Figure 3). That is, the vertical "side" cuts should be spaced slightly closer than the length of the prism, and the "bottom" cut should be located slightly deeper than the width of the prism. Next, slide the prism into the notch cut from the box and rotate the prism until the widest possible spectrum appears on a shaded portion of the white sheet of paper at the bottom of the box.

Figure 2

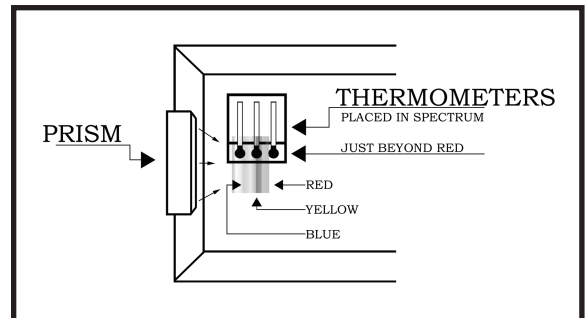



The Sun-facing side of the box may have to be elevated (tilted up) to produce a sufficiently wide spectrum. After the prism is secured in the notch, place the thermometers in the shade and record the ambient air temperature. Then place the thermometers in the spectrum such that one of the bulbs is in the blue region, another is in the yellow region, and the third is just beyond the (visible) red region (as in Figure 2).

It will take about five minutes for the temperatures to reach their final values. Record the temperatures in each of the three regions of the spectrum: blue, yellow, and "just beyond" the red. Do not remove the thermometers from the spectrum or block the spectrum while reading the temperatures.

DATA / OBSERVATIONS:

Temperature in the Shade	Thermometer #1	Thermometer #2	Thermometer #3
Temperature in the Spectrum	Thermometer #1 (blue)	Thermometer #2 (yellow)	Thermometer #3 (just beyond red)
After 1 min			
After 2 min			
After 3 min			
After 3 min			
After 5 min			

NOTE: Depending on the orientation of your prism, the color red could be at either end of the spectrum. Adjust the positions of your thermometers accordingly.

QUESTIONS:

What did you notice about your temperature readings? Did you see any trends?

Where was the highest temperature?

What do you think exists just beyond the red part of the spectrum?

Discuss any other observations or problems.



Herschel Discovers Infrared Light

Sir Frederick William Herschel (1738-1822) was born in Hanover, Germany and became well known as both a musician and as an astronomer. He moved to England in 1757 and, with his sister Caroline, constructed telescopes to survey the night sky. Their work resulted in several catalogs of double stars and nebulae. Herschel is famous for his discovery of the planet Uranus in 1781, the first new planet found since antiquity.

Herschel made another dramatic discovery in 1800. He wanted to know how much heat was passed through the different colored filters he used to observe sunlight. He had noted that filters of different colors seemed to pass different amounts of heat. Herschel thought that the colors themselves might be of varying temperatures and so he devised a clever experiment to investigate his hypothesis.

He directed sunlight through a glass prism to create a spectrum - the rainbow created when light is divided into its colors - and then measured the temperature of each color. Herschel used three thermometers with blackened bulbs (to better absorb the heat) and, for each color of the spectrum, placed one bulb in a visible color while the other two were placed beyond the spectrum as control samples. As he measured the individual temperatures of the violet, blue, green, yellow, orange and red light, he noticed that all of the colors had temperatures higher than the controls. Moreover, he found that the temperatures of the colors increased from the violet to the red part of the spectrum.

After noticing this pattern, Herschel decided to measure the temperature just *beyond* the red portion of the spectrum in a region apparently devoid of sunlight. To his surprise, he found that this region had the highest temperature of all.

Herschel performed additional experiments on what he called calorific rays (derived from the Latin word for *heat*) beyond the red portion of the spectrum. He found that they were reflected, refracted, absorbed and transmitted in a manner similar to visible light. What Sir William had discovered was a form of light (or radiation) beyond red light, now known as infrared radiation. (The prefix *infra* means below.) Herschel's experiment was important because it marked the first time that someone demonstrated that there were types of light that we cannot see with our eyes.

Recent developments in detector technology have led to many useful applications using infrared radiation. Medical infrared technology is used for the non-invasive analysis of body tissues and fluids. Infrared cameras are used in police and security work, as well as in military surveillance. In fire fighting, infrared cameras are used to locate people and animals caught in heavy smoke, and for detecting hot spots in forest fires. Infrared imaging is used to detect heat loss in buildings, to test for stress and faults in mechanical and electrical systems, and to monitor pollution. Infrared satellites are routinely used to measure ocean temperatures, providing an early warning for El Niño events that usually impact climates worldwide. These satellites also monitor convection within clouds, helping to identify potentially destructive storms. Airborne and space-based cameras also use infrared light to study vegetation patterns and to study the distribution of rocks, minerals and soil. In archaeology, thermal infrared imaging has been used to discover hundreds of miles of ancient roads and footpaths, providing valuable information about vanished civilizations.

New and fascinating discoveries are being made about our Universe in the field of infrared astronomy. The Universe contains vast amounts of dust, and one way to peer into the obscured cocoons of star formation and into the hearts of dusty galaxies is with the penetrating eyes of short-wavelength infrared telescopes. Our Universe is also expanding as a result of the Big Bang, and the visible light emitted by very distant objects has been red-shifted into the infrared portion of the electromagnetic spectrum.

REMARKS TO THE TEACHER: Have the students answer the above questions. The temperatures of the colors should increase from the blue to red part of the spectrum. The highest temperature should be just beyond the red portion of the visible light spectrum. This is the infrared region of the spectrum. Herschel's experiment was important not only because it led to the discovery of infrared light, but also because it was the first time that it was shown that there were forms of light that we cannot see with our eyes. As we now know, there are many other types of electromagnetic radiation ("light") that the human eye cannot see (including X-rays, ultraviolet rays and radio waves). You can also have the students measure the temperature of other areas of the spectrum including the area just beyond the visible blue. Also, try the experiment during different times of the day; the temperature differences between the colors may change, but the *relative* comparisons will remain valid.