



# Complete Streets

## Design Guidelines

.....

2020



**DENVER**  
THE MILE HIGH CITY

# Acknowledgments

**Thank you to the many City and County of Denver staff members and partners who contributed their time, ideas, and expertise to the creation of the Denver Complete Streets Design Guidelines.**

## Project Team

### Core Team

David Pulsipher, Department of Transportation & Infrastructure (DOTI)

Riley LaMie, DOTI

Kristofer Johnson, Community Planning & Development (CPD)

Brittany Price, DOTI

### Consultant Team

Toole Design

Short Elliott Hendrickson Inc.

StudioCPG

## Executive Management Team

Eulois Cleckley, DOTI Executive Director

Lesley Thomas, DOTI City Engineer/Deputy Director

Laura Aldrete, CPD Executive Director

Manny Almaguer, Denver Fire Department (DFD)  
Fire Prevention Division Chief

Matt Bryner, DOTI ROW Services Director

Emily Gloeckner, DOTI Design Director

Happy Haynes, Parks & Recreation Executive Director

Jennifer Hillhouse, DOTI Plan Director

Daniel Sadler, DFD Assistant Chief

## Complete Streets Steering Committee

Sarah Anderson, DOTI Office of Policy, Legislative Affairs and Special Initiatives (OPLASI)

Chris Baca, DOTI ROW Services

Scott Burton, DOTI Operations

Marco Cabanillas, DOTI ROW Services

Tony Caro, DFD

Chris Gleissner, CPD Development Services

Eric Huetig, Parks & Recreation Forestry

Angie Drumm, Colorado Department of Transportation  
Region 1

Nathan Lucero, City Attorney's Office

Doug Monroe, Regional Transportation District (RTD)

Jim Myer, Parks & Recreation Forestry

Chris Nevitt, CPD

Eric Osmundsen, DOTI ROW Services

Alex Paez, DFD

Cindy Patton, DOTI OPLASI

Gordon Robertson, Parks & Recreation Planning

Brian Roecker, DOTI Street Maintenance

Sarah Showalter, CPD

Michael Swanson, Parks & Recreation Forestry

Mark Tabor, Parks & Recreation Planning

Deb Turner, DOTI Build

Jyotsna Vishwakarma, RTD

Brian Wethington, DOTI OPLASI

## Community Stakeholder Group

Denver Regional Mobility & Access Council

Denver Streets Partnership

Downtown Denver Partnership

Mayor's Bicycle Advisory Committee

Mayor's Pedestrian Advisory Committee

## Developer and Freight Stakeholder Group

Brookfield Properties

Trammell Crow

Callahan Capital Properties

Colorado Motor Carriers Association

Colorado Restaurant Association

Continuum

Cushman & Wakefield

Focus Property Group

Gart Properties

McWhinney

Nichols Partnership

Red Peak

Sysco

Tavern Group

UPS

# Contents

<b>1. Introduction</b>	<b>2</b>	Residential Streets	29
Vision and Guiding Principles	3	Contemporary Parkways	31
Policy Framework	4	Local Streets	33
Purpose of the Guidelines	5	Shared Streets	35
Overview of the Guidelines	5	Overlays	36
<b>2. Street Types &amp; Design Framework</b>	<b>8</b>	<b>3. Street Design Details</b>	<b>42</b>
Street Zones	10	Chapter Sections	44
Street Priorities	11	Pedestrian Realm and Curbside Features	45
Public Space	11	Safe and Accessible Features	66
Safe Speeds	11	Green Infrastructure	95
Steps for Designing Denver Streets	14	Utilities	100
How to Use the Street Type Design Profiles	16	<b>4. Implementation and Maintenance</b>	<b>104</b>
Downtown Streets	19	Organizational Responsibilities	105
Main Streets	21	Project Types	106
Mixed-Use Streets	23	Design Exception Process	109
Commercial Streets	25	Maintenance Responsibilities	109
Industrial Streets	27		

# Glossary

**ADA:** Americans with Disabilities Act

**ADT:** Average daily traffic

**Blueprint Denver:** a citywide land use and transportation plan that was first adopted in 2002 and updated in 2019

**CDOT:** Colorado Department of Transportation

**Curb/corner radii:** the radius of an intersection corner or curb

**Curbspace:** a street subzone, part of the roadway zone, that can include vehicle and bicycle parking, freight loading, parklets, taxi and ride-hailing pick-up and drop-off, transit stop amenities, and other uses that activate the street

**Denver Moves plans:** a series of mode- and location-specific transportation plans developed by the City and County of Denver

**Design/posted/target speed:** the speed at which people are expected to drive; the target speed should match the design speed and posted speed limit; *see Chapter 2*

**DFD:** Denver Fire Department

**Dockless mobility vehicles:** shared bicycles and shared electric (e-) bikes, e-scooters, and e-skateboards; also known as micromobility

**DOTI:** Denver Department of Transportation & Infrastructure

**Functional classification:** a historical way to classify streets based on traffic volume and level of access

**General travelway:** a street subzone that includes general purpose driving lanes that can be shared by private motor vehicles, buses, commercial and freight vehicles, bicycles, and dockless mobility vehicles

**Green infrastructure:** a network of parks, open spaces, drainageways, and floodplains which help mitigate the impacts caused by impervious (hard) surfaces. Site-scale green infrastructure refers to smaller, engineered, structural practices which mimic larger natural systems and use vegetation, soils, and roots to slow and filter stormwater runoff; also referred to in Denver as Ultra-Urban Green Infrastructure

**Guidelines:** the Denver Complete Streets Design Guidelines are referred to as the Guidelines throughout this document. The Guidelines provide information about how to apply various street design treatments and practices. Applicable and related other guidelines include the Proposed Public Right-of-Way Accessibility Guidelines (PROWAG), Ultra-Urban Green Infrastructure Guidelines, Street Lighting Design Guidelines and Details, Small Cell Infrastructure Design Guidelines, RTD Design Guidelines, and Uncontrolled Pedestrian Crossing Guidelines. *See standards*

**Inside lane:** a general travelway lane that does not abut a curb and/or gutter

**Median:** a physical element between the two edges of a roadway to separate directions of travel and in some cases, to provide traffic calming or pedestrian or bicyclist refuge

**Mode-specific travelway:** where present, a street subzone that can include on-street dedicated bikeways, transit-only lanes, and turn lanes

**Outside lane:** a general travelway lane that abuts a curb and/or gutter

**Overlay:** a designation or set of designations that a street may have, along with its street type, that informs the design; the Guidelines include seven overlays; *see Chapter 2*

**Pedestrian realm:** the zone within a street that includes the Frontage Zone, Sidewalk Zone, and Amenity Zone; *see Chapter 3* for a detailed description of this zone and each subzone

**Right-of-way (ROW):** land owned or granted by easement to the City for transportation or utility purposes; this term is often used to refer to the public land outside of the roadway including the pedestrian realm

**Roadway zone:** the zone within a street that includes the General Travelway, Mode-Specific Travelway (when present), Curbspace (when present), and Median (when present)

**RTD:** Regional Transportation District

**Standards:** an enforceable set of design parameters often in the form of City and County of Denver Rules & Regulations. Applicable and relevant City standards include the Transportation Standards and Details for the Engineering Division, Transportation Design Signal, Sign & Marking Standards, the Bikeway Design Manual, and the Denver Fire Building and Code.

**Street type:** a defined typology (existing or future) in Denver used to describe the general design, function, and character of a street design; the Guidelines include 16 street types. *See Chapter 2*

**Vertical deflection:** a raised feature in the roadway, such as speed humps/cushions/tables and raised crossings, intended to slow motor vehicles

**Vision Zero:** an international strategy to eliminate all traffic fatalities and severe injuries, while increasing safe, healthy, equitable mobility for all

**Vulnerable users:** those most at risk in traffic; this typically includes those unprotected by a vehicle, including people walking, rolling, bicycling, scooting, and driving a motorcycle



Flickr photo by Geoff Livingston

# 1. Introduction

## Vision and Guiding Principles

Streets make up a substantial portion of Denver’s publicly owned land. How we design our streets reflects how we want to live.

The Complete Streets approach gives people walking, rolling, bicycling, taking transit, and scooting the same access to safe and comfortable streets as those driving a motor vehicle. Denver’s Complete Streets Design Guidelines (Guidelines) embody that approach and establish new, comprehensive design standards for our streets.

These Guidelines serve as a resource for furthering citywide goals of addressing historic inequities, reducing the impacts of climate change, decreasing single occupancy vehicle use, and supporting economic vitality and healthy living. These are the first steps to building the transportation system our community needs and desires, rather than perpetuating current travel patterns.

## The following principles will guide the design of Complete Streets in Denver:

- » **SAFETY:** Above all else, street design in Denver prioritizes the safety of people, with an emphasis on protecting vulnerable users—such as people walking, rolling, and bicycling. The City has a target of zero traffic deaths and serious injuries by 2030. The Guidelines are central to achieving that goal.
- » **ACCESSIBILITY AND INCLUSIVITY:** Accessible and inclusive streets ensure that people with mobility impairments can travel and access destinations with the same dignity as everyone else.
- » **EQUITY:** By identifying culturally sensitive solutions to Complete Streets, focusing improvements in neighborhoods with historic disinvestment or underinvestment, and building self-enforcing streets, street design can help repair systemic inequities in Denver. Equitable street design will guide all Denver projects.
- » **HEALTHY AND ACTIVE LIVING:** Complete Streets recognize that streets are more than channels for transportation; safe street design encourages healthy and active travel and lifestyle options.
- » **ENVIRONMENTAL SUSTAINABILITY/RESILIENCY:** Complete Streets support the environment by providing shade; reducing ground-level ozone; managing stormwater; making places more comfortable for people walking, rolling, and bicycling; and improving resiliency to climate change.
- » **COMMUNITY CHARACTER:** Streets that exhibit intentional urban design become ingrained into the identity of a community, defining its culture and encouraging public pride.
- » **ECONOMIC VITALITY:** Design that considers streets as places—not just transportation corridors—contributes to the economy: keeping and attracting residents, reducing the cost of transportation, improving property values, and increasing sales revenue.
- » **PUBLIC SPACE:** As the largest area of publicly-owned land in the city, it is critical that streets serve as useful and comfortable urban space for all users.
- » **ADAPTABILITY TO THE FUTURE:** The future will yield trends in transportation and technology beyond our current understanding and foresight; flexible designs increase the ability to be nimble when change occurs.
- » **MAINTAINABILITY:** Good street design promotes more efficient maintenance, repair, sweeping, and snow clearance. This includes providing and maintaining utilities as well.

## Policy Framework

Denver is rapidly growing, but its street network is largely built out, meaning that widening streets to add travel lanes is not a desirable or practical solution to meet mobility demands. Instead, the City accommodates travel demand by providing a mix of transportation choices and by emphasizing efficient, safe, and sustainable ways of moving around.

Denver’s modal hierarchy for its transportation system prioritizes people walking or using mobility devices first, because everyone does these things at some point during their trip, whether they are walking or using a mobility device to and from a parked vehicle, to the bus, or to get exercise. Bicycling and transit are prioritized next, because these modes move the largest amount of people in the smallest amount of roadway space. People walking, rolling, and bicycling are also the most vulnerable roadway users when it comes to risk of injury or death in the event of a crash. Therefore, space and protection for those walking, rolling, and biking will be prioritized above vehicle travel and storage space. Freight and goods movement are prioritized next, as the movement of goods is necessary to keep Denver’s thriving economy strong and growing. Finally, single occupancy motor vehicle trips are at the bottom of the modal hierarchy. These trips are the least efficient means of moving people, from a physical space perspective, and one of the largest contributors to air and water pollution.

**The implementation of the Complete Streets Design Guidelines establishes a paradigm shift so that Denver’s streets are designed from the outside in. This approach prioritizes the pedestrian and considers the uses and activities along the street edge in balance with travel demands.**

While the overall modal hierarchy applies to the entire transportation system in Denver, specific streets have individualized contexts and more nuanced priorities of uses. Chapter 2 includes guidance on which street uses have priority on various street types. In addition to these Guidelines, Denver’s suite of regulatory and policy tools, including *Blueprint Denver* and any neighborhood plans applicable should be consulted.

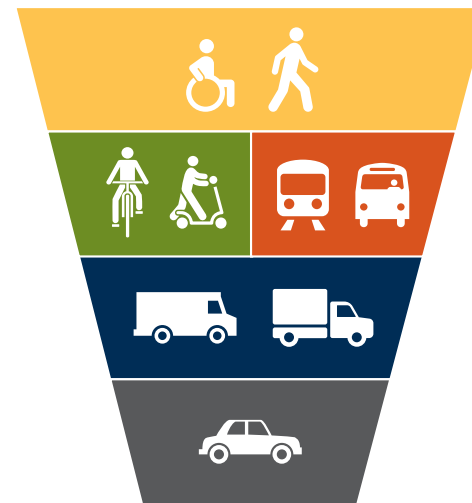

Pedestrian Priority: Complete multimodal networks prioritize the most vulnerable and efficient modes first. People walking and rolling are the heart of the transportation system.



### Street Design Can Help Save Lives

Traffic deaths are a preventable public health crisis that the City and County of Denver is working to eliminate. The *Denver Vision Zero Action Plan* commits to achieving zero traffic fatalities and serious injuries by 2030. Despite the alarming trend of rising traffic deaths in Denver and around the U.S., there are many things that government agencies can do to improve traffic safety; street design is one of those things.

Street design is one of the most powerful tools in achieving Vision Zero. By designing streets for the outcomes that we want—such as lower speeds, reduced conflicts, intuitive movements, and mobility options—we can protect all street users. By establishing clear and comprehensive street design guidance that includes proven treatments, the City can ensure that Vision Zero is embedded in every project.

The development of the Complete Streets Design Guidelines fulfills a major Vision Zero action and sets the City on a clear path to building safer streets for all Denverites.



## Purpose of the Guidelines

The Denver Complete Streets Design Guidelines provide a framework to guide the City and County of Denver, its partner agencies, and private developers in designing, constructing, and maintaining Complete Streets. The Guidelines describe and illustrate design guidance for future investments in our streets. They also provide specific information and parameters related to design, construction, and maintenance of Denver's streets.

The guidance presented herein should be implemented with engineering judgment. The Guidelines integrate design flexibility that supports all modes of transportation while meeting requirements mandated by local, state, and federal authorities. This document presents minimum, maximum, and recommended design criteria that vary by street type. Construction-ready design standards and details are not included, as these are provided in separate City and County of Denver documents.

The Guidelines include best practices to ensure consistency and quality as the City's transportation network develops over time. The information provided is compatible with the inherent flexibility provided in Federal Highway Administration (FHWA), American Association of State Highway and Transportation Officials (AASHTO), National Association of City Transportation Officials (NACTO), Manual on Uniform Traffic Control Devices (MUTCD), and Colorado Department of Transportation (CDOT) guidance. In some cases, the Guidelines include newer and more innovative designs and approaches than is currently addressed in the aforementioned guidance.

The Guidelines supplement existing City and County of Denver engineering practices by providing guidance on right-of-way decisions. **The Guidelines should be used by anyone advancing a street project in Denver, including City staff and private developers.** The Guidelines should be used for all types of street projects, including retrofits, maintenance projects, quick-build improvements, reconstruction, and new construction. *The Denver Bikeway Design Manual*, which contains detailed guidance and design standards associated with bikeway implementation, is a companion document to the Guidelines.

## Overview of the Guidelines

### Chapter 2: Street Types and Design Framework

This chapter provides a concise manual for designing streets based on their transportation function and land use context. It provides a practitioner's companion for carrying out Complete Streets principles for each street type based on surrounding land uses, transportation patterns, and other characteristics.

For each of the street types, Chapter 2 provides design parameters and priorities for the public right-of-way and direction on use of general design features, which are described in detail in Chapter 3.

### Chapter 3: Street Design Details

Chapter 3 provides greater detail on the street types found in Chapter 2. The chapter provides details on design elements that are to be implemented throughout Denver, remaining sensitive to the land use and street type context outlined in Chapter 2. As practitioners use the street type guidance found in Chapter 2, they should reference the details called out and provided in the Street Design Details chapter to ensure consistent use of methods and materials across the city. The elements of the chapter are organized into the following categories:

- » Pedestrian Realm and Curbside Features
- » Safe and Accessible Features
- » Green Infrastructure
- » Utilities

### Chapter 4: Implementation and Maintenance

Chapter 4 provides general guidance on the roles and responsibilities of City and County of Denver departments and its partner agencies for implementation and maintenance of Complete Streets. Maintenance considerations are an important part of the final design of each project. Chapter 4 explores methods and standards for seasonal maintenance.

# Complete Streets in Denver

Denver's streets are diverse. Some streets include many uses and some only include a few. The Complete Streets Design Guidelines will help practitioners consider these context-based uses and design accordingly.

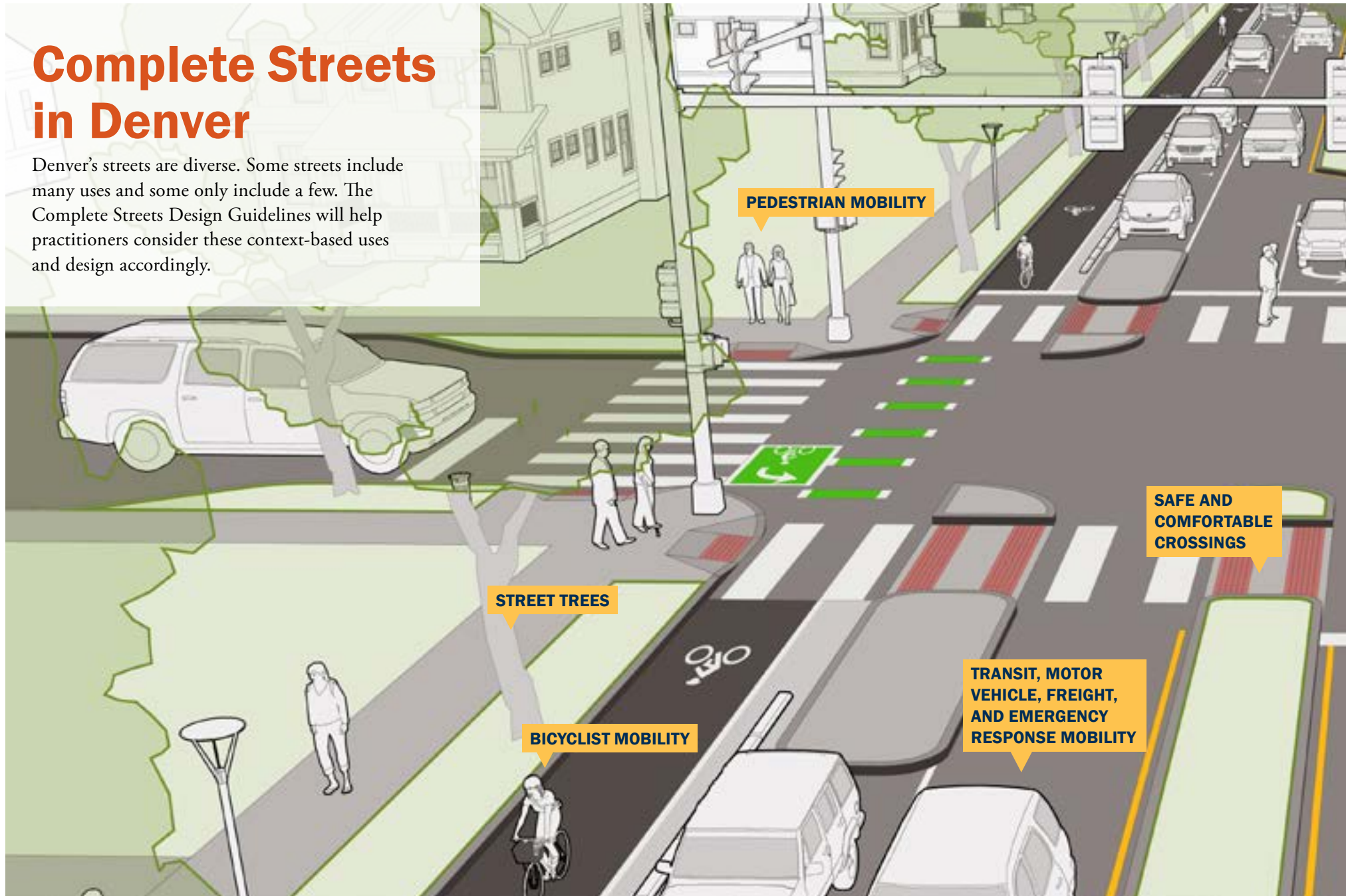

PEDESTRIAN MOBILITY

STREET TREES

BICYCLIST MOBILITY

SAFE AND COMFORTABLE CROSSINGS

TRANSIT, MOTOR VEHICLE, FREIGHT, AND EMERGENCY RESPONSE MOBILITY

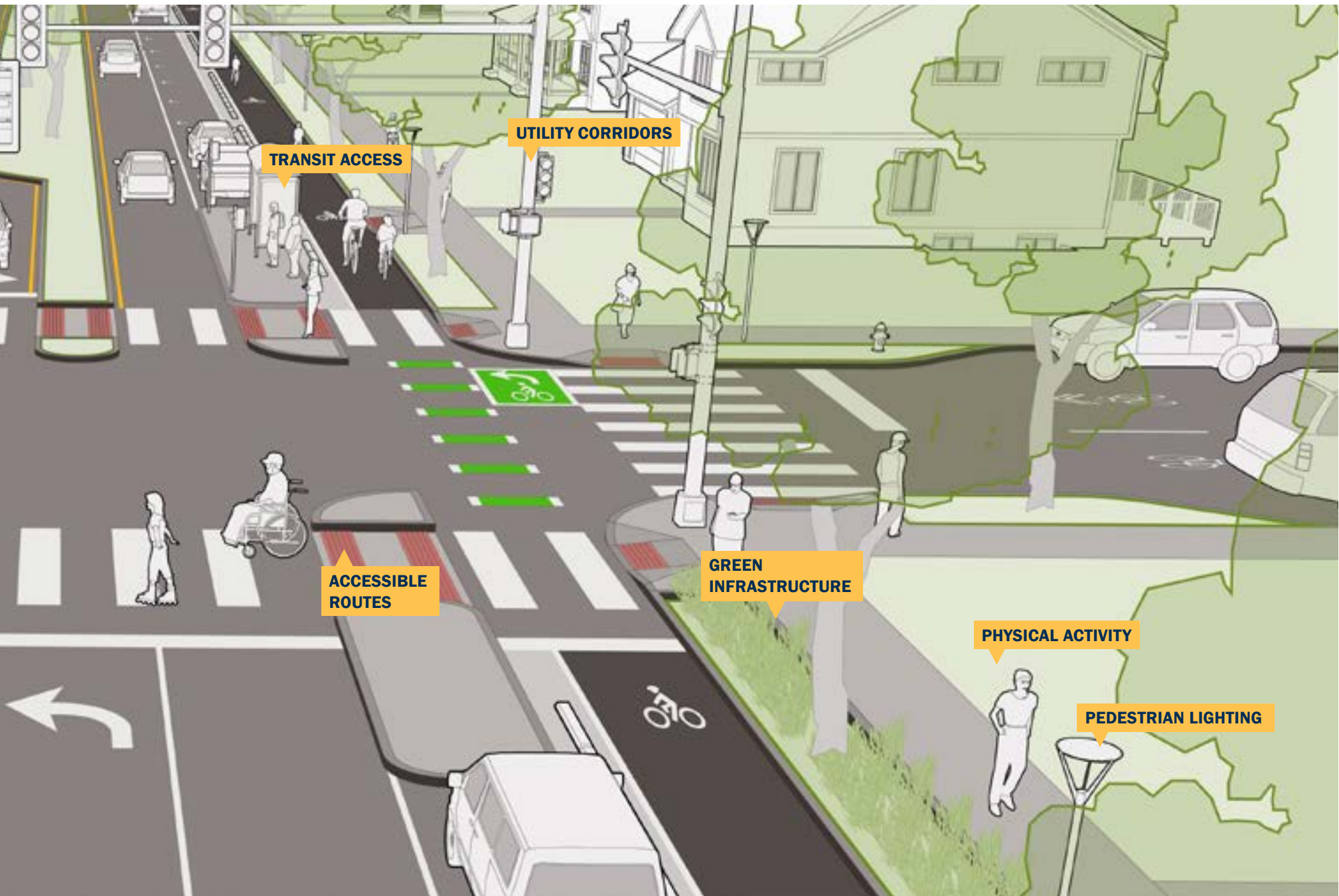



## 2. Street Types & Design Framework

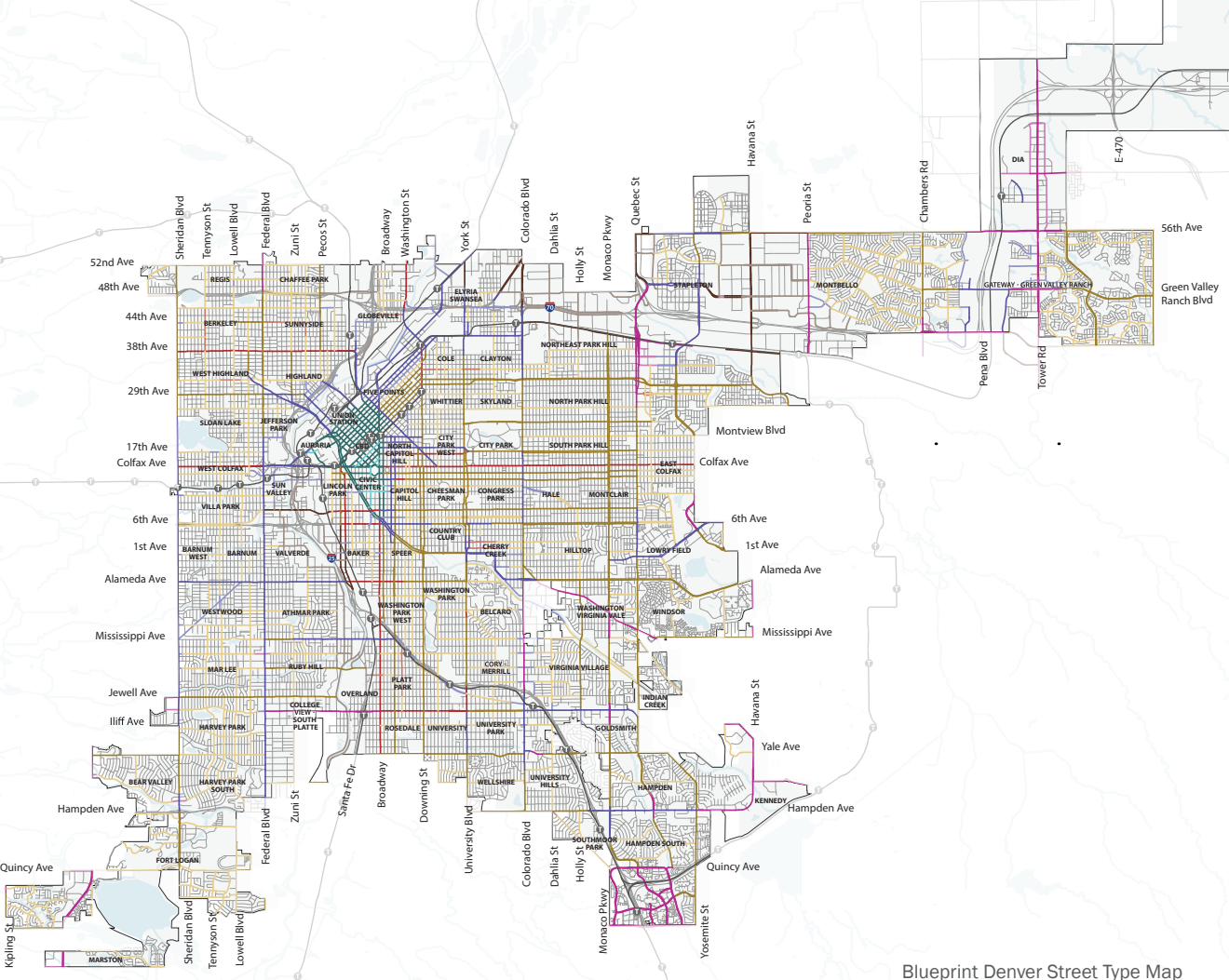

Blueprint Denver Street Type Map

**Denver's street types include:**

- » Downtown One-Way Arterials
- » Downtown Two-Way Arterials
- » Downtown Collectors
- » Main Street Arterials
- » Main Street Collectors
- » Mixed-Use Arterials
- » Mixed-Use Collectors
- » Commercial Arterials
- » Commercial Collectors
- » Industrial Arterials
- » Industrial Collectors
- » Residential Arterials
- » Residential Collectors
- » Contemporary Parkways
- » Local Streets
- » Shared Streets

Like cities around the U.S., Denver has historically classified its streets primarily by how they serve motor vehicles. This is no longer the case. *Blueprint Denver* includes a typology for describing streets by their adjacent land use and character, in addition to their transportation function. This typology is applied to arterials and collectors, which have the most variation depending on land use and neighborhood context. Local streets, which vary less and are often characterized by residential uses, are found in all neighborhood contexts. The application of this street typology can be found in the latest *Blueprint Denver Street Type* map.

From a transportation perspective, local streets are designed for the highest degree of property access and the lowest amount of through people movement. Arterial streets are designed for the highest amount of people movement and the lowest degree of property access. Collector streets are in between a local street and an arterial street; they collect movement from local streets and convey it to arterial streets.

Complementing Denver's street types, detailed in this chapter, are seven overlays:

- Pedestrian Priority
- Bicycle Priority
- Transit Priority
- Historic Parkways
- Ultra-Urban Green Streets
- School Zones
- Regular Closure and Festival Streets

These overlay networks must be considered when designing a street. The information described in the *Overlays* section on page 36 should be used alongside street type guidance to help set priorities, identify street design features, and create intuitive multimodal networks throughout Denver.

# Street Zones

Any street can be broken into two zones, including the **pedestrian realm** (which includes the **frontage zone**, **sidewalk zone**, and **amenity zone**), and roadway (which includes the **curbspace**, **mode-specific travelway**, **general travelway**, and **median**).

Each of these zones can contain different street elements depending on the street type, surrounding land use, and modal priority for that street. The **curbspace** isn't always adjacent to the curb and can include elements such as motor vehicle and bicycle parking, parklets, and freight and passenger loading. The **mode-specific**

**travelway** can contain on-street bikeways, transit-only lanes, and turn lanes. While the **mode-specific travelway** is sometimes located along the curb, it can also be located elsewhere within the roadway zone. The **general travelway** includes general purpose driving lanes, which may be shared between private motor vehicles, transit vehicles, commercial vehicles, and bicyclists. When present, **medians** should ideally contain landscaping and provide pedestrian refuge space at intersections. Chapter 3 of this document contains design details for the pedestrian realm and roadway that make a street safe and accessible, and information on how to incorporate green infrastructure and utilities into all street types.

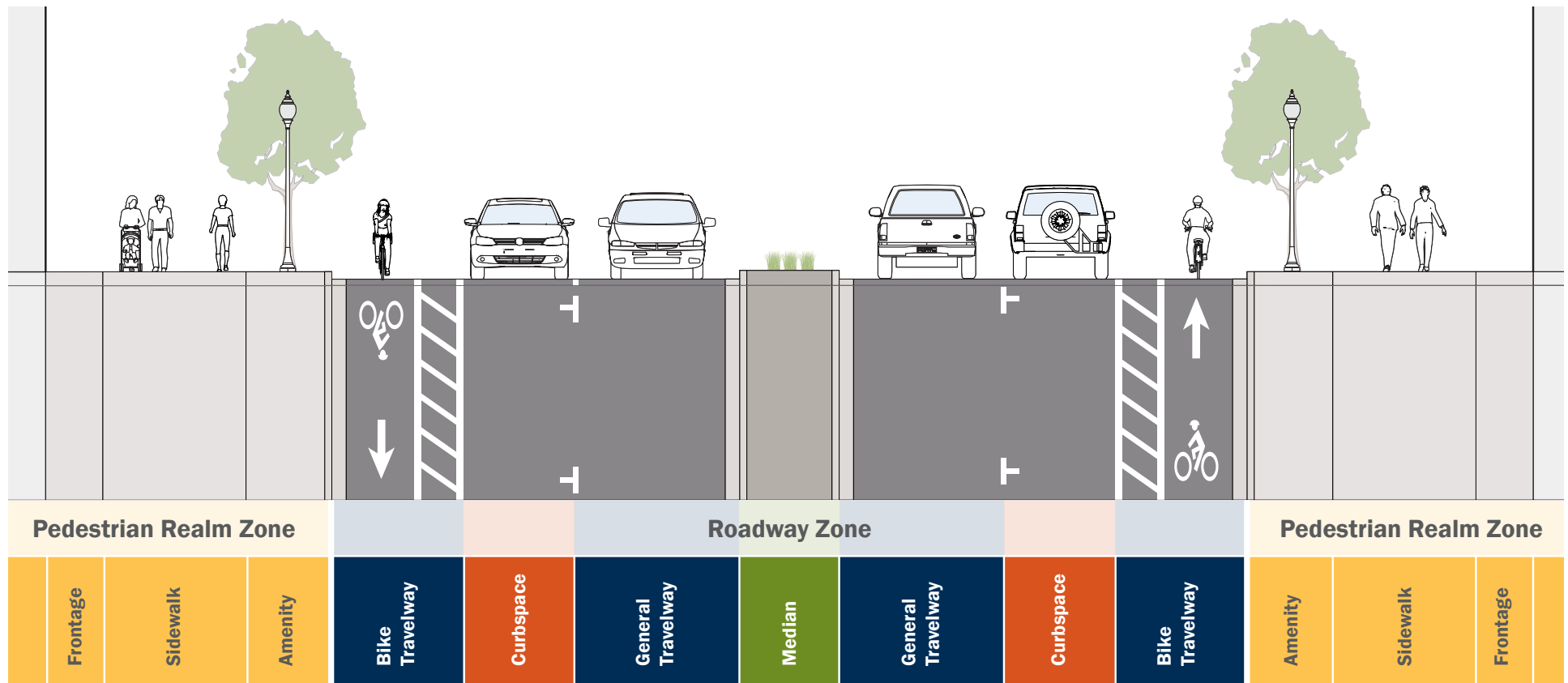

Street Zones

## Street Priorities

In most cases, street space is a fixed quantity, particularly in retrofit situations. For many Denver street projects, there are more demands than can fit in a given right-of-way, while others have more right-of-way than is needed, resulting in wide and dangerous streets. The Guidelines do not promote expanding right-of-way widths to accommodate all of these demands. Because of this, the Guidelines provide information on which street elements are most important for a given street type. This chapter describes when and where these priority street elements should exist, their minimum and preferred widths, and other design elements that can or should be included. In all cases, the preferred widths outlined in this document should be used. However, when trade-offs must be made, the right-of-way allocation priorities tables for each street type can be used to help designers identify which zones within a street can be reduced to narrower widths. DOTI should seek every opportunity, from regular maintenance activities to large capital projects, to implement Complete Streets elements and make Denver's streets safe and active spaces for all.

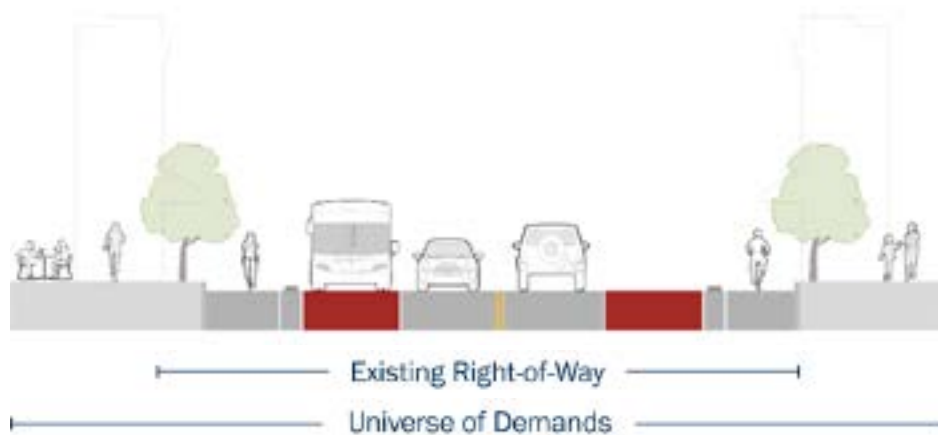

Because most streets cannot fit everything, this chapter includes relative priorities for each street type.

## Public Space

Collectively, streets are our largest and one of our most important public spaces. Designing from the outside in means starting with pedestrian and public space needs on the outer edges of the cross-section, then thinking about bikeways and curbside demands (including transit), and then allocating the remaining space to private automobiles. This Complete Streets approach ensures that many of the City's guiding principles will be realized including safety, accessibility, inclusivity, health, environmental sustainability/resiliency, community character, and economic vitality. This public space approach to street design helps prioritize space for street trees and other people-first elements.

## Safe Speeds

**A street is only as safe as its fastest traveling motor vehicle.** The relationship between traffic safety and motor vehicle speed is well documented: as motor vehicle speeds increase, the likelihood of a person surviving a crash decreases. For this reason, urban streets designed to encourage a mix of modes typically promote lower speeds. The *Denver Vision Zero Action Plan* emphasizes actions to create safe speeds throughout the city.



**TARGET SPEED = DESIGN SPEED = POSTED SPEED**

The practitioner should design a street according to the target speed—the speed at which you want a person to drive. Target speeds should balance the needs of all anticipated street users based on context. In order to match design to driver expectation, the target and design speed should match the posted speed limit. While this is a departure from conventional methods of establishing design speeds and speed limits, it is a core Vision Zero approach to street design.

## Design Speed

Design speed is a tool used to determine geometric features of the roadway. The following section describes how to approach design speeds.

### Lowering the Design Speed of Existing Streets

Existing roadway geometric features, signal timing, or other factors may result in a prevailing speed (the speed that most people are driving at or below) higher than the posted speed. In these cases, design measures should be considered to reduce the prevailing speed to match the posted speed. The Institute of Traffic Engineers (ITE) outlines 10 measures (not all of these are appropriate on every street) that can be used to lower speeds:

- » Using narrower travel lanes that cause motorists to naturally slow their speeds
- » Using physical measures such as curb extensions, vertical deflection (e.g., speed humps/cushions, raised crossings), and medians
- » Using design elements such as on-street parking, trees, and planting areas to create side friction
- » Minimal or no horizontal offset between the inside travel lane and median curbs
- » Eliminating superelevation (banking of the roadway)
- » Eliminating shoulders in urban applications, except for bicycle lanes
- » Smaller turning radii at intersections and elimination or reconfiguration of high-speed channelized right turns
- » Paving materials with texture (e.g., crosswalks, intersection operating areas) detectable by drivers as a notification of the possible presence of pedestrians

**Roadway and travel lane width have a measurable impact on the speed at which people feel comfortable driving. In order to manage speeds, designers should use the preferred or minimum travel lane widths recommended in this chapter.**

**This chapter includes recommended design speeds for each street type in Denver. Many of these include ranges. By default and whenever possible, designers should strive to base their designs on the lower end of design speed ranges to maximize safety for all road users.**

- » Proper use of speed limit, warning, and advisory signs and other devices to gradually transition speeds before and through a walkable area
- » Setting signal timing for moderate progressive speeds between intersections

### Managing Speeds with Traffic Signal Timing

Traffic signal operational changes can be a key Vision Zero strategy. Across the country, deliberate traffic signal timing and coordination has been used to successfully reinforce speed limits along streets by changing the time available to travel along a corridor uninterrupted. One complementary strategy to reducing motor vehicle speeds is implementing a bicycle “green wave” along a corridor. A “green wave” adjusts signal timing to prioritize the through travel to the speed of a bicyclist.

## Design and Control Vehicle

Streets and intersections should enable safe and efficient movement by a variety of different vehicle sizes and types. It is important to consider the size of vehicles that will reasonably be expected to move through the intersection, the frequency of these movements, and the City’s policy for lane encroachment.

### Design Vehicle

The design vehicle is the least maneuverable vehicle that routinely uses the street. Designers use a design vehicle to determine corner radii at intersections and should use this vehicle when completing analysis with turning analysis software.

Designers should select the smallest appropriate design vehicle to support safer pedestrian crossings, while still accommodating motor vehicle turns. If an intersection includes a bus route where buses make turns, an appropriately sized bus may be used as the design vehicle. The designer should be cognizant of the bus route and accommodate necessary turning movements through the intersection. If the bus route goes straight through the intersection, it is not necessary to make the bus the design vehicle.



In Denver, a standard box truck (SU-30) is the default design vehicle. DOTI has the discretion to use a larger design vehicle than the default for Industrial Arterials, certain Downtown One-Way Arterials, Mixed-Use Arterials, Commercial Arterials and other streets where larger vehicles are anticipated to comprise more than 8 percent of the turning movements at the intersection, and no alternate route exists that would accommodate larger vehicle turns without compromising pedestrian safety. Examples of typical turning templates for these unique conditions would include a WB-40, WB-50, WB-62, or in rare instances on Industrial Streets, a WB-67. Designers should be prepared to submit supporting documentation, including detailed turning analyses, to document a deviation from the default design vehicle and to demonstrate their evaluation of specific corner designs.

Conversely, in locations where vulnerable roadway users are frequent users of the street, smaller design vehicles than the default should be considered. Smaller design vehicles should be considered on Local and Shared Streets; in Pedestrian Priority, Bicycle Priority, and School Zone overlay areas; and near land uses such as parks and older adult housing.

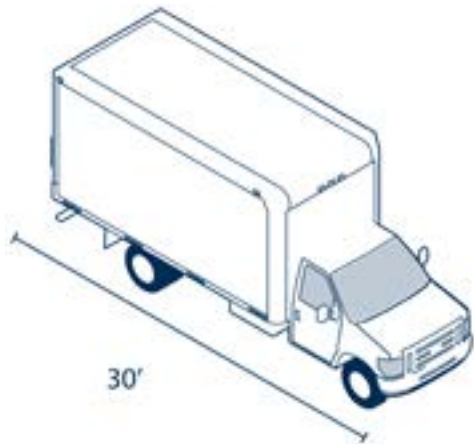

Denver's default design vehicle for all streets is a 30-foot single unit truck (SU-30) with a 42-foot minimum design turning radius.

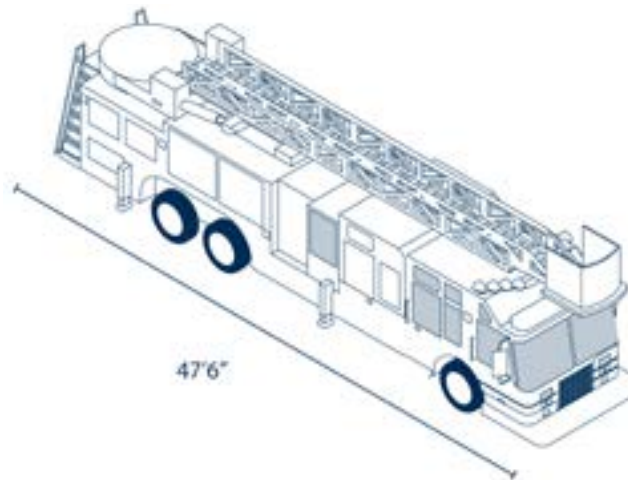

Denver's control vehicle is either a Denver Fire Truck (with a 50-foot turning radius) or a WB-50 truck (with a 45-foot minimum design turning radius). Fire Trucks are determined by the Denver Fire Department and are subject to modification. DOTI has discretion on which design and control vehicle should be used for various contexts.

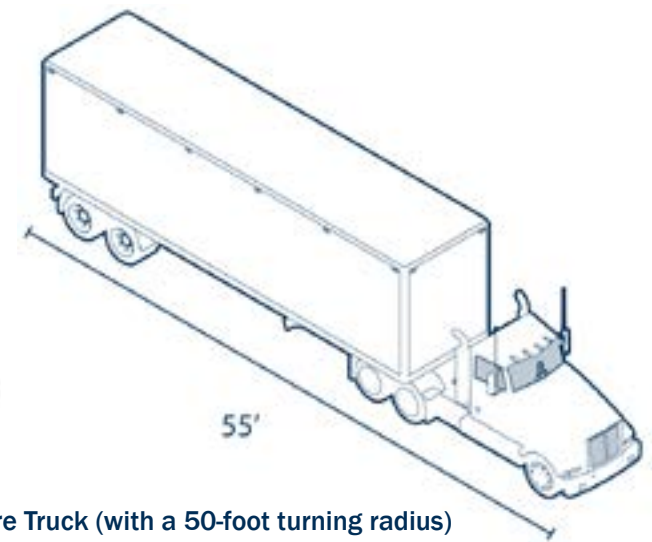

## Control Vehicle

The control vehicle is an infrequent but necessary user of the street. The control vehicle for intersection design in Denver can be either a WB-50 or a Denver Fire truck; DOTI has the discretion to decide which control vehicle to use based on context and engineering judgment. The control vehicle can be assumed to use all traversable parts of an intersection, including across centerlines, also known as full encroachment. Encroachment is the ability for a vehicle to use space outside of its designated travel lane, but within the roadway, to navigate a turning movement. Encroachment does not include tracking over curbs, bike facilities or onto the sidewalk area. Encroachment can occur on single lane and multi-lane roadways. Allowing large vehicles to encroach on adjacent travel lanes is an important consideration when designing intersections with shorter crossing distances for pedestrians and lowering turning speeds. Consultation should occur as needed with the current Fire Code and Fire Official.

# Steps for Designing Denver Streets

Designers should follow these steps when designing a street in Denver:

1. Identify the most appropriate street type based on *Blueprint Denver's* Street Types map and, if relevant, updated City plans or City direction.
2. Use the design profiles on the pages that follow to identify key dimensions, design parameters, street priorities, and appropriate design elements. Identify all relevant modal or context overlays from City plans or City direction (see the Overlays section on page 36) and adjust priorities and design parameters as necessary.
3. Use the street design details in Chapter 3 to fully develop the Complete Streets design.

## Reclassifying a Street

The next section of this chapter is organized by street type. The designer should consider reclassifying the street type in the following situations:

- » This chapter includes two street types that are not on the *Blueprint Denver* Street Type map: Contemporary Parkways and Shared Streets. If the goals and conditions of your project align with one of those street types, coordinate with City staff to determine if you should design the street using those parameters.
- » If the street you are designing has existing average daily traffic (ADT) volumes outside of the ranges shown in this chapter, you should consider requesting a street reclassification.

Street reclassifications happen through a collaborative process led by the Denver Department of Transportation & Infrastructure (DOTI). Denver's context-sensitive street types include and maintain arterial and collector functional classifications. These Complete Streets Design Guidelines provide guidance for ensuring that regardless of functional classification, each of Denver's streets are designed for people.

## Unique Streets

Denver's 16th Street Mall, the city's premier public realm and one of its busiest transit corridors, is a unique legacy street that does not fit into any of the designated street types. While unique streets like the 16th Street Mall have their own design guidelines and standards, the basic principles and many of the Street Design Details in the Guidelines will still apply.

THIS PAGE INTENTIONALLY LEFT BLANK.

# How to Use the Street Type Design Profiles

The design guidance for each street type is presented through a two-page design profile. The content on the profiles should be used as follows:

## Downtown Streets

Downtown streets are surrounded by the most intense land uses including hotels, street-level retail and office, residential, and mixed-use towers. They are pedestrian-oriented and have narrow setbacks and strong engagement of the street. Curb space is highly managed and pedestrian and bicycle connectivity is of high priority. Street trees and green infrastructure, café seating, enhanced hardscaping, pedestrian lighting, and public plazas make for a vibrant place on downtown streets. Along with Downtown Collectors, there are two types of Downtown Arterials: One-Way Arterials and Two-Way Arterials.



Downtown One-Way Arterial with Bicycle and Transit Overlays

	Frontage Zone	Sidewalk Zone	Amenity Zone	Curbspace	Outside Travel Lane	Inside Travel Lane
Preferred	-	12'	8'	8'	12'	10'
Minimum	0'	8'	5'	7'	11'	10'
Maximum	10'	-	12'	9'	12'	11'

**Example Streets**

- » Larimer Street
- » 14th Street

## Downtown Streets

### Right-Of-Way Allocation Priorities

Street Elements	Low	High
Overlays	←	→
Frontage Zone	←	→
Sidewalk	←	→
Amenity Zone	←	→
Curbspace	←	→
Drive Lanes	←	→
Medians	←	→



A One-Way Arterial  
B Two-Way Arterial  
C Collector

Denver's modal hierarchy prioritizes people walking, rolling, bicycling, and using transit. For this reason, relevant overlays should be the highest priority on any given street type. Consult the Overlays section for guidance on how to apply overlays.



### Design Parameters and Operational Characteristics

	Arterial	Collector
<b>Design Speed*</b>	20 - 25 mph	20 - 25 mph
<b>Typical Daily Traffic Volumes</b>	5,000 - 30,000	5,000 - 10,000
<b>Driveway Frequency</b>	Very low	
<b>Freight Loading/Unloading Location</b>	Alley and on-site accessed via alley (preferred) and on-street	

\*Designers should strive to use the lower range of design speeds whenever possible to ensure maximum safety for all road users. The design speed should match the posted speed.

### Appropriate Design Elements

Design Type	Most Appropriate Elements	Other Compatible Elements
<b>Pedestrian Realm and Curbside Features</b>	Pedestrian Lighting; Street Furniture; Street Trees and Supporting Infrastructure; Bicycle and Dockless Mobility Parking; Loading and Freight Zones; Mobility Hubs; Parking Meters/Pay Stations; Parklets; Transit Stops and Shelters	Electric Vehicle Charging Stations
<b>Safe and Accessible Features</b>	Crosswalks; Curb Extensions; Driveway Crossings; Hardened Centerlines; Transit Signal Priority; No Turn on Red; Pedestrian Signal Phasing; Raised Crossings (collector)	Accessible Parking & Loading Zones; In-Street Yield to Pedestrian Signs; Corner Islands and Turn Wedges
<b>Green Infrastructure</b>	Bioretention Facilities; Pervious Surfaces; Stormwater Tree Trenches	

**A** Each street type includes an illustrative image of an aspirational street. The caption on each image notes which overlays have been assumed. The images are not intended to include all Complete Streets elements.

**B** These tables include preferred, minimum, and maximum dimensions for each primary street element in the right-of-way. **Designers should use preferred widths as a default and whenever possible.** The designer should note the following about dimensions:

Regarding the **pedestrian realm zone width** (inclusive of the frontage zone, sidewalk zone, and amenity zone), 8 feet of clear walkway is required for pedestrian realms greater than 21 feet and for all sidewalks on arterial streets, regardless of street type.

**Bikeway widths** are not listed as they vary by type of facility and context. Please consult the *Denver Bikeway Design Manual* for preferred bikeway widths.

**Outside lane widths** are inclusive of gutter pans, which are typically 2-foot wide. Outside lanes are general travelway lanes that abut a curb and/or gutter. Inside lanes do not abut a curb and/or gutter. All streets will either have an outside or inside lane, or both. Some dimensions are shown with a “-” instead of a number. This means that **no dimension is specified** due to the varying nature of possible situations.

**C** The **Right-Of-Way Allocation Priorities** tables provide guidance for which cross-sectional elements to prioritize within the street right-of-way. The designer should use these tables to develop cross sections and plan view designs. By considering available right-of-way width or width between curbs, the width of each desired cross-sectional element, and the priorities of each element, designers can develop Complete Streets design options.

If a priority is not indicated for a particular street type, that means that the street element is not compatible for that street type. For example, medians are not compatible on Downtown One-Way Arterials or Collectors.

Designers should consult Chapter 3 for a description of many of the priority cross-sectional elements. These descriptions contain more information about uses, dimensions, and trade-offs.

For each street type, **overlays** will be the highest priority where applicable. The designer should consult the Overlays section of Chapter 2 for information on how to identify applicable overlays. For example, Denver has numerous planned bikeways; for these streets with Bicycle Priority Overlays, space for bike lanes and buffers should take priority over other street elements. The same is true for all overlays.

**D** The **Appropriate Design Elements** tables list the most appropriate design elements for a particular street type. Each of these has corresponding content in Chapter 3, which includes a description, in what contexts they should be used, design parameters, and other considerations.

**E** The **Design Parameters and Operational Characteristics** tables include key information on which design assumptions should be made. To maximize safety, the designer should use the lower range of specified design speeds whenever possible and as a default.

Apart from Local and Shared Streets, each street type includes two subtypes: arterials and collectors. Arterial streets typically have more general-purpose drive lanes and less curbside activity than collectors, but most design profile information is similar between the two. Information on the design profile pages applies to both arterial and collector streets equally unless otherwise noted.

# Downtown Streets

Downtown streets are surrounded by the most intense land uses including hotels, street-level retail and office, residential, and mixed-use towers. They are pedestrian-oriented and have narrow setbacks and strong engagement of the street. Curb space is highly managed and pedestrian and bicycle connectivity is of high priority. Street trees and green infrastructure, café seating, enhanced hardscaping, pedestrian lighting, and public plazas make for a vibrant place on downtown streets. Along with Downtown Collectors, there are two types of Downtown Arterials: One-Way Arterials and Two-Way Arterials.



Downtown One-Way Arterial with Bicycle and Transit Overlays

## Example Streets

- » Larimer Street
- » 14th Street

	Frontage Zone	Sidewalk Zone	Amenity Zone	Curbspace	Outside Travel Lane	Inside Travel Lane
Preferred	-	12'	8'	8'	12'	10'
Minimum	0'	8'	5'	7'	11'	10'
Maximum	10'	-	12'	9'	12'	11'

# Downtown Streets

## Right-Of-Way Allocation Priorities

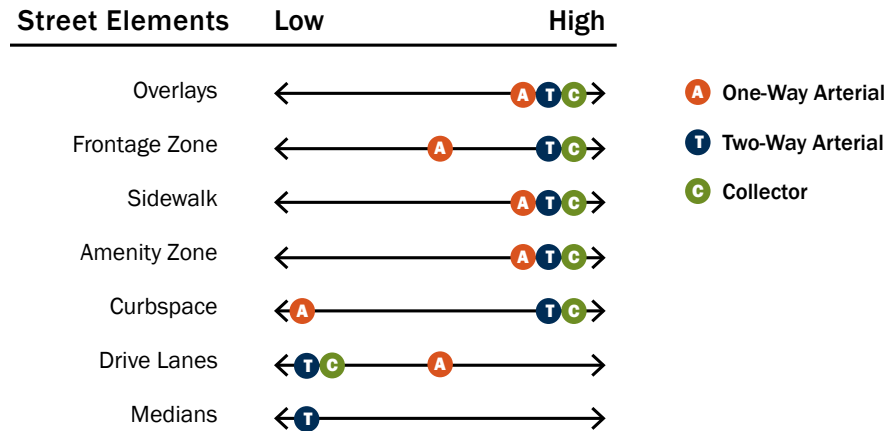

Denver's modal hierarchy prioritizes people walking, rolling, bicycling, and using transit. For this reason, relevant overlays should be the highest priority on any given street type. Consult the Overlays section for guidance on how to apply overlays.

## Design Parameters and Operational Characteristics

	Arterial	Collector
<b>Design Speed*</b>	20 - 25 mph	20 - 25 mph
<b>Typical Daily Traffic Volumes</b>	5,000 - 30,000	5,000 - 10,000
<b>Driveway Frequency</b>	Very low	
<b>Freight Loading/Unloading Location</b>	Alley and on-site accessed via alley (preferred) and on-street	

\*Designers should strive to use the lower range of design speeds whenever possible to ensure maximum safety for all road users. The design speed should match the posted speed.

## Appropriate Design Elements

Design Type	Most Appropriate Elements	Other Compatible Elements
<b>Pedestrian Realm and Curbside Features</b>	Pedestrian Lighting; Street Furniture; Street Trees and Supporting Infrastructure; Bicycle and Dockless Mobility Parking; Loading and Freight Zones; Mobility Hubs; Parking Meters/Pay Stations; Parklets; Transit Stops and Shelters	Electric Vehicle Charging Stations
<b>Safe and Accessible Features</b>	Crosswalks; Curb Extensions; Driveway Crossings; Hardened Centerlines; Transit Signal Priority; No Turn on Red; Pedestrian Signal Phasing; Raised Crossings (collector)	Accessible Parking & Loading Zones; In-Street Yield to Pedestrian Signs; Corner Islands and Turn Wedges
<b>Green Infrastructure</b>	Bioretention Facilities; Pervious Surfaces; Stormwater Tree Trenches	

# Main Streets

Main Streets are characterized by a mix of uses including retail, services, restaurants, and residential. Buildings are pedestrian-oriented, with little front setback, and high transparency. Street-level uses are highly activated, including café seating in the right-of-way. Sidewalks are generally wider with fewer driveways to prioritize people walking or rolling. Consistent street trees, streetside planters, café seating (sometimes within the street), bump-out stormwater planters, and ultra-urban green infrastructure facilities provide a buffer between people walking or rolling and traffic.



Main Street  
Collector

## Example Streets

- » E Colfax Avenue
- » Tennyson Street

	Frontage Zone	Sidewalk Zone	Amenity Zone	Curbspace	Outside Travel Lane	Inside Travel Lane
Preferred	-	12'	8'	8'	12'	10'
Minimum	0'	8'	5'	7'	11'	10'
Maximum	10'	-	12'	9'	12'	11'



# Main Streets

## Right-Of-Way Allocation Priorities

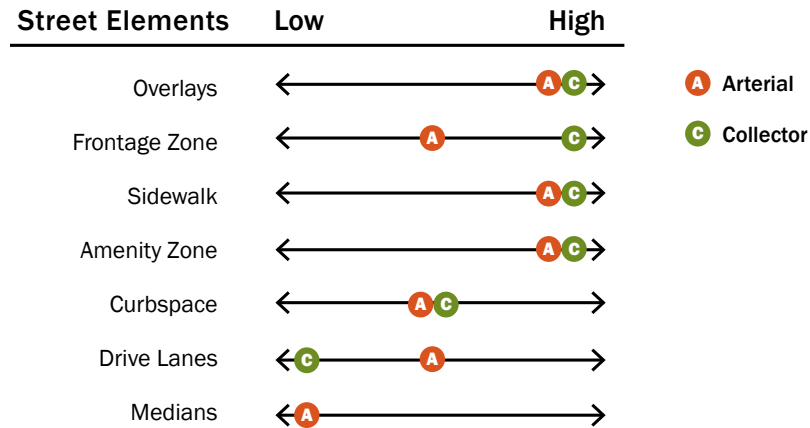

Denver's modal hierarchy prioritizes people walking, rolling, bicycling, and using transit. For this reason, relevant overlays should be the highest priority on any given street type. Consult the Overlays section for guidance on how to apply overlays.

## Design Parameters and Operational Characteristics

	Arterial	Collector
Design Speed*	25 - 30 mph	25 mph
Typical Daily Traffic Volumes	10,000 - 30,000	5,000 - 15,000
Driveway Frequency	Low	
Freight Loading/Unloading Location	Alley and on-site accessed via alley (preferred) and on-street	

\*Designers should strive to use the lower range of design speeds whenever possible to ensure maximum safety for all road users. The design speed should match the posted speed.

## Appropriate Design Elements

Design Type	Most Appropriate Elements	Other Compatible Elements
<b>Pedestrian Realm and Curbside Features</b>	Pedestrian Lighting; Street Furniture; Street Trees and Supporting Infrastructure; Bicycle and Dockless Mobility Parking; Loading and Freight Zones; Mobility Hubs; Parklets; Transit Stops and Shelters	Electric Vehicle Charging Stations; Parking Meters/Pay Stations
<b>Safe and Accessible Features</b>	Crosswalks; Curb Extensions; Driveway Crossings; Transit Signal Priority; Median Refuge Islands (arterial); No Turn on Red; Pedestrian Signal Phasing; Raised Crossings (collector)	Accessible Parking & Loading Zones; Hardened Centerlines; In-Street Yield to Pedestrian Signs; Corner Islands and Turn Wedges
<b>Green Infrastructure</b>	Bioretention Facilities; Pervious Surfaces; Stormwater Tree Trenches	

# Mixed-Use Streets

Mixed-Use Streets contain varied uses such as retail, office, residential, and restaurants. Buildings are pedestrian-oriented, typically multi-story, usually with high building coverage with a shallow front setback. Driveways are more frequent than on main streets but still limited to prioritize a friendly street for people walking or rolling and riding bicycles. Street trees within planting areas should include water quality features and elevated planters contribute to the streetscape. Some limited hardscaped areas with benches may be present, providing a buffer between people walking or rolling and traffic.

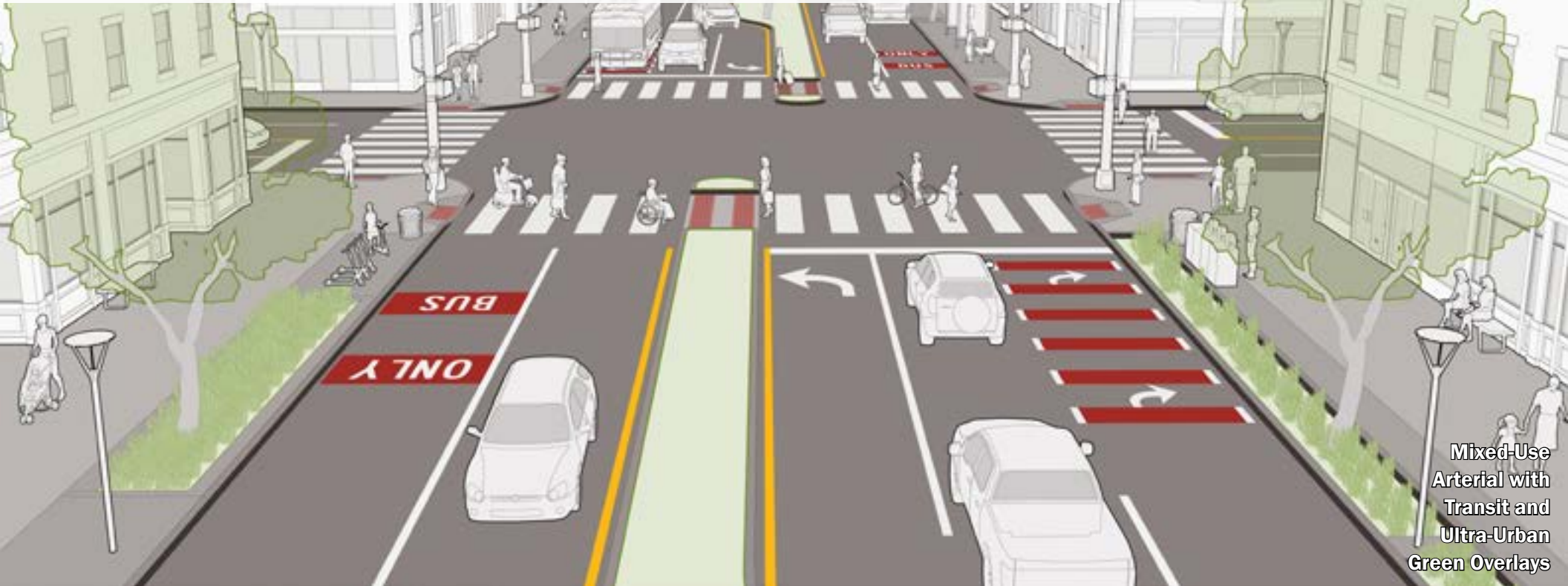

Mixed-Use Arterial with Transit and Ultra-Urban Green Overlays

## Example Streets

- » Federal Boulevard
- » Morrison Road

	Frontage Zone	Sidewalk Zone	Amenity Zone	Curbspace	Outside Travel Lane	Inside Travel Lane	Median
Preferred	-	10'	8'	8'	12'	10'	18'
Minimum	0'	8'	5'	7'	11'	10'	6'
Maximum	10'	-	12'	9'	12'	11'	-

# Mixed-Use Streets

## Right-Of-Way Allocation Priorities

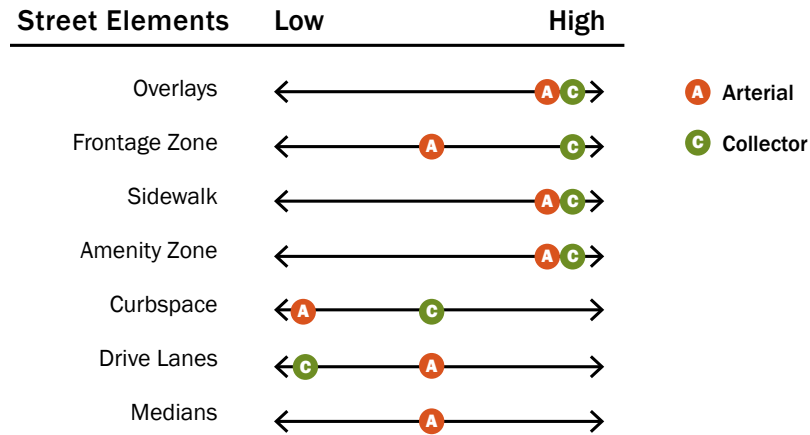

Denver’s modal hierarchy prioritizes people walking, rolling, bicycling, and using transit. For this reason, relevant overlays should be the highest priority on any given street type. Consult the Overlays section for guidance on how to apply overlays.

## Design Parameters and Operational Characteristics

	Arterial	Collector
Design Speed*	25 - 35 mph	25 - 30 mph
Typical Daily Traffic Volumes	10,000 - 40,000	5,000 - 15,000
Driveway Frequency	Low to moderate	
Freight Loading/Unloading Location	Alley and on-site accessed via alley (preferred) and on-street	

\*Designers should strive to use the lower range of design speeds whenever possible to ensure maximum safety for all road users. The design speed should match the posted speed.

## Appropriate Design Elements

Design Type	Most Appropriate Elements	Other Compatible Elements
<b>Pedestrian Realm and Curbside Features</b>	Pedestrian Lighting; Street Furniture; Street Trees and Supporting Infrastructure; Bicycle and Dockless Mobility Vehicle Parking; Mobility Hubs; Transit Stops and Shelters	Electric Vehicle Charging Stations; Loading and Freight Zones; Parking Meters/Pay Stations; Parklets
<b>Safe and Accessible Features</b>	Crosswalks; Curb Extensions; Driveway Crossings; Transit Signal Priority; Median Refuge Islands (arterials); Pedestrian Signal Phasing; Raised Crossings (collectors)	Accessible Parking & Loading Zones; Hardened Centerlines; In-Street Yield to Pedestrian Signs; Corner Islands and Turn Wedges; No Turn on Red
<b>Green Infrastructure</b>	Bioretention Facilities	Pervious Surfaces; Stormwater Tree Trenches

# Commercial Streets

Commercial streets typically contain commercial uses including shopping centers, auto services, and offices. Buildings are often set back with on-site parking. Commercial streets have more frequent driveways to provide auto access to properties, but still provide adequate sidewalk space for people to walk and roll. Consistent street trees within amenity zones may include water quality features and provide a buffer between people walking or rolling and traffic.



## Example Streets

- » Colorado Boulevard
- » Peoria Street

	Frontage Zone	Sidewalk Zone	Amenity Zone	Curbspace	Outside Travel Lane	Inside Travel Lane	Median
Preferred	-	6'	8'	8'	12'	10'	18'
Minimum	0'	5'	5'	7'	11'	10'	6'
Maximum	6'	-	12'	9'	12'	10'	-

# Commercial Streets

## Right-Of-Way Allocation Priorities

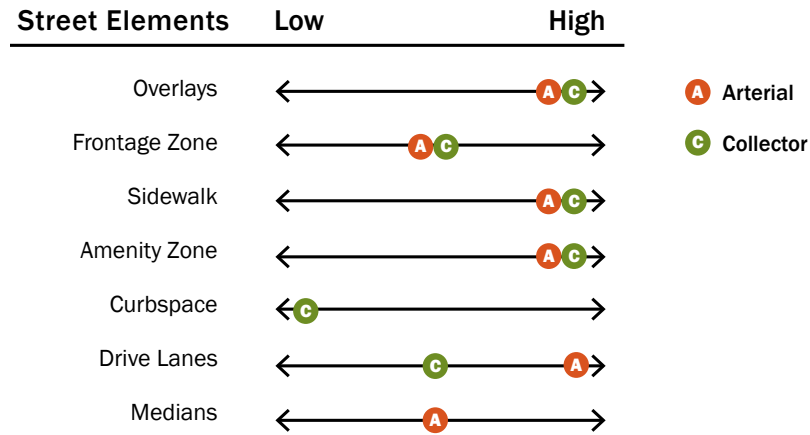

Denver's modal hierarchy prioritizes people walking, rolling, bicycling, and using transit. For this reason, relevant overlays should be the highest priority on any given street type. Consult the Overlays section for guidance on how to apply overlays.

## Design Parameters and Operational Characteristics

	Arterial	Collector
Design Speed*	25 - 35 mph	25 - 30 mph
Typical Daily Traffic Volumes	20,000 - 50,000	5,000 - 20,000
Driveway Frequency	Moderate to high	
Freight Loading/Unloading Location	On-site	

\*Designers should strive to use the lower range of design speeds whenever possible to ensure maximum safety for all road users. The design speed should match the posted speed.

## Appropriate Design Elements

Design Type	Most Appropriate Elements	Other Compatible Elements
<b>Pedestrian Realm and Curbside Features</b>	Street Trees and Supporting Infrastructure	Transit Stops and Shelters
<b>Safe and Accessible Features</b>	Crosswalks; Curb Extensions; Hardened Centerlines; Transit Signal Priority; Median Refuge Islands (arterials)	Driveway Crossings; In-Street Yield to Pedestrian Signs; Corner Islands and Turn Wedges; No Turn on Red; Pedestrian Signal Phasing; Uncontrolled Pedestrian Crossings
<b>Green Infrastructure</b>	Stormwater Tree Trenches	Bioretention Facilities

# Industrial Streets

Industrial streets are characterized by manufacturing but may contain other uses. Buildings are generally low-rise and may be set back to accommodate site specific needs. Adequate sidewalk space is provided, but driveway access is provided more frequently and streets may be wider to accommodate the movement of goods. Street trees within an amenity zone or stormwater planting area are used to separate people walking or rolling from motor vehicles and freight traffic. Green infrastructure helps reduce pollutants. While large vehicles are a critical user, workers arriving via transit and people walking and biking along these streets are also critical.



Industrial Collector

## Example Streets

- » Smith Road
- » Kalamath Street

	Frontage Zone	Sidewalk Zone	Amenity Zone	Curbspace	Outside Travel Lane	Inside Travel Lane
Preferred	-	6'	8'	9'	12'	11'
Minimum	0'	5'	5'	8'	11'	10'
Maximum	2'	-	12'	9'	12'	11'

# Industrial Streets

## Right-Of-Way Allocation Priorities

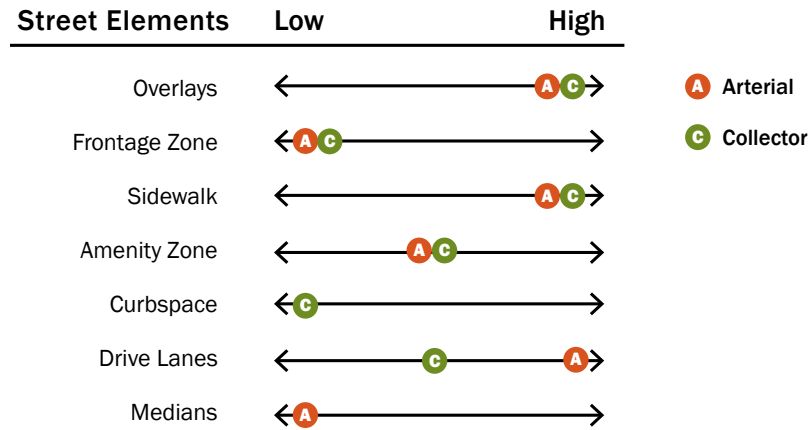

Denver's modal hierarchy prioritizes people walking, rolling, bicycling, and using transit. For this reason, relevant overlays should be the highest priority on any given street type. Consult the Overlays section for guidance on how to apply overlays.

## Design Parameters and Operational Characteristics

	Arterial	Collector
Design Speed*	30 - 35 mph	25 - 30 mph
Typical Daily Traffic Volumes	15,000 - 50,000	5,000 - 20,000
Driveway Frequency	Moderate to high	
Freight Loading/Unloading Location	On-site	

\*Designers should strive to use the lower range of design speeds whenever possible to ensure maximum safety for all road users. The design speed should match the posted speed.

## Appropriate Design Elements

Design Type	Most Appropriate Elements	Other Compatible Elements
<b>Pedestrian Realm and Curbside Features</b>	Street Trees and Supporting Infrastructure	Loading and Freight Zones; Transit Stops and Shelters
<b>Safe and Accessible Features</b>	Median Refuge Islands (arterials)	Crosswalks; Curb Extensions; Driveway Crossings; No Turn on Red; Pedestrian Signal Phasing; Uncontrolled Pedestrian Crossings
<b>Green Infrastructure</b>		Bioretention Facilities; Stormwater Tree Trenches

# Residential Streets

Residential Arterials and Collectors serve primarily residential uses, but may also include schools, civic uses, parks, small retail nodes, and other similar uses. Buildings on residential streets usually have a modest setback, which vary by neighborhood. Signalized crossings with high visibility markings provide ample crossing opportunities. Street trees within an amenity zone are used to separate people walking or rolling from traffic. These streets typically have higher traffic speeds and volumes than local streets and serve more land uses than just residential.

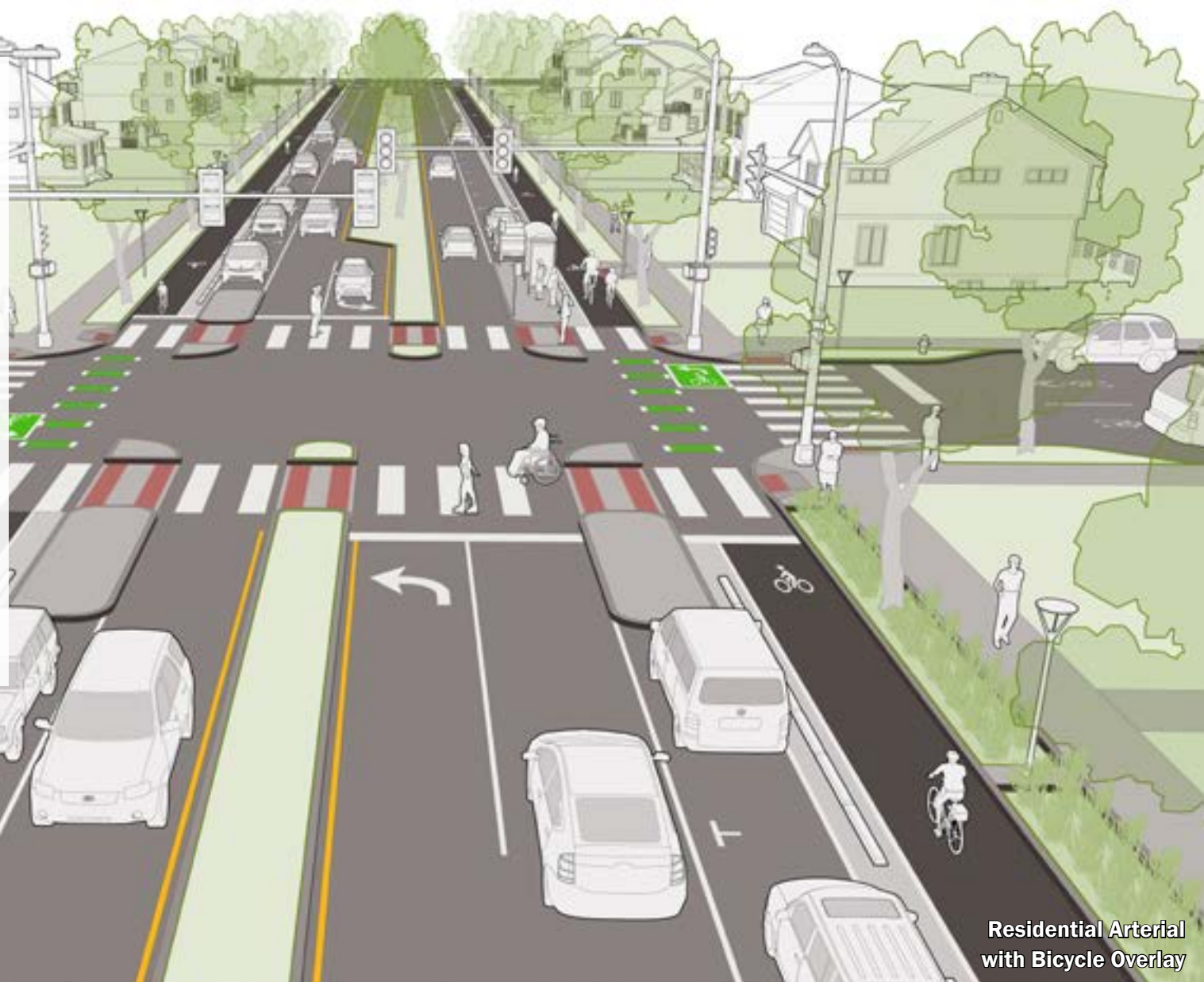

Residential Arterial with Bicycle Overlay

## Example Streets

- » E 14th Avenue
- » Martin Luther King Jr. Boulevard

	Frontage Zone	Sidewalk Zone	Amenity Zone	Curbspace	Outside Travel Lane	Inside Travel Lane	Median
Preferred	-	6'	8'	8'	12'	10'	10'-16'
Minimum	0'	5'	5'	7'	11'	10'	6'
Maximum	2'	-	12'	9'	12'	10'	18'



# Residential Streets

## Right-Of-Way Allocation Priorities

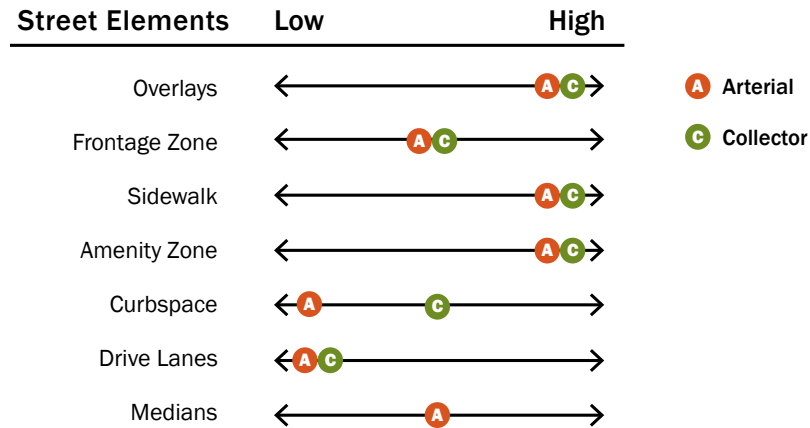

Denver's modal hierarchy prioritizes people walking, rolling, bicycling, and using transit. For this reason, relevant overlays should be the highest priority on any given street type. Consult the Overlays section for guidance on how to apply overlays.

## Design Parameters and Operational Characteristics

	Arterial	Collector
Design Speed*	25 - 30 mph	25 mph
Typical Daily Traffic Volumes	10,000 - 30,000	5,000 - 15,000
Driveway Frequency	Varies	
Freight Loading/Unloading Location	Alley and on-site accessed via alley (preferred) and on-street	

\*Designers should strive to use the lower range of design speeds whenever possible to ensure maximum safety for all road users. The design speed should match the posted speed.

## Appropriate Design Elements

Design Type	Most Appropriate Elements	Other Compatible Elements
<b>Pedestrian Realm and Curbside Features</b>	Street Trees and Supporting Infrastructure; Transit Stops and Shelters	On-Street Parking
<b>Safe and Accessible Features</b>	Crosswalks; Curb Extensions; Median Refuge Islands (arterials)	Access Control and Diverters; Chicanes and Pinch Points (collector); Driveway Crossings; In-Street Yield to Pedestrian Signs; Left-Turn Wedges; Neighborhood Traffic Circles (collector); No Turn on Red; Pedestrian Signal Phasing; Raised Crossings (collectors); Uncontrolled Pedestrian Crossings
<b>Green Infrastructure</b>		Bioretention Facilities; Stormwater Tree Trenches

# Contemporary Parkway

While Denver’s historic parkways play a significant role as civic space, they are not fully developed citywide. Opportunities exist to build new, contemporary parkways that embody the intent of the historic parkway system but include newer design elements. Some of Denver’s developing areas are excellent opportunities to expand the legacy of parkways, which could include creating new parkways or adapting existing roadways into parkways. Contemporary parkway design should include tree-lined sidewalks and ample green features. They should explore the integration of stormwater infrastructure, drought-tolerant plantings, high-efficiency and pedestrian-scale lighting, integrated bicycle and transit connections, and various material and paving treatments. See the Overlays section of this chapter for how to approach the retrofit of historic parkways.

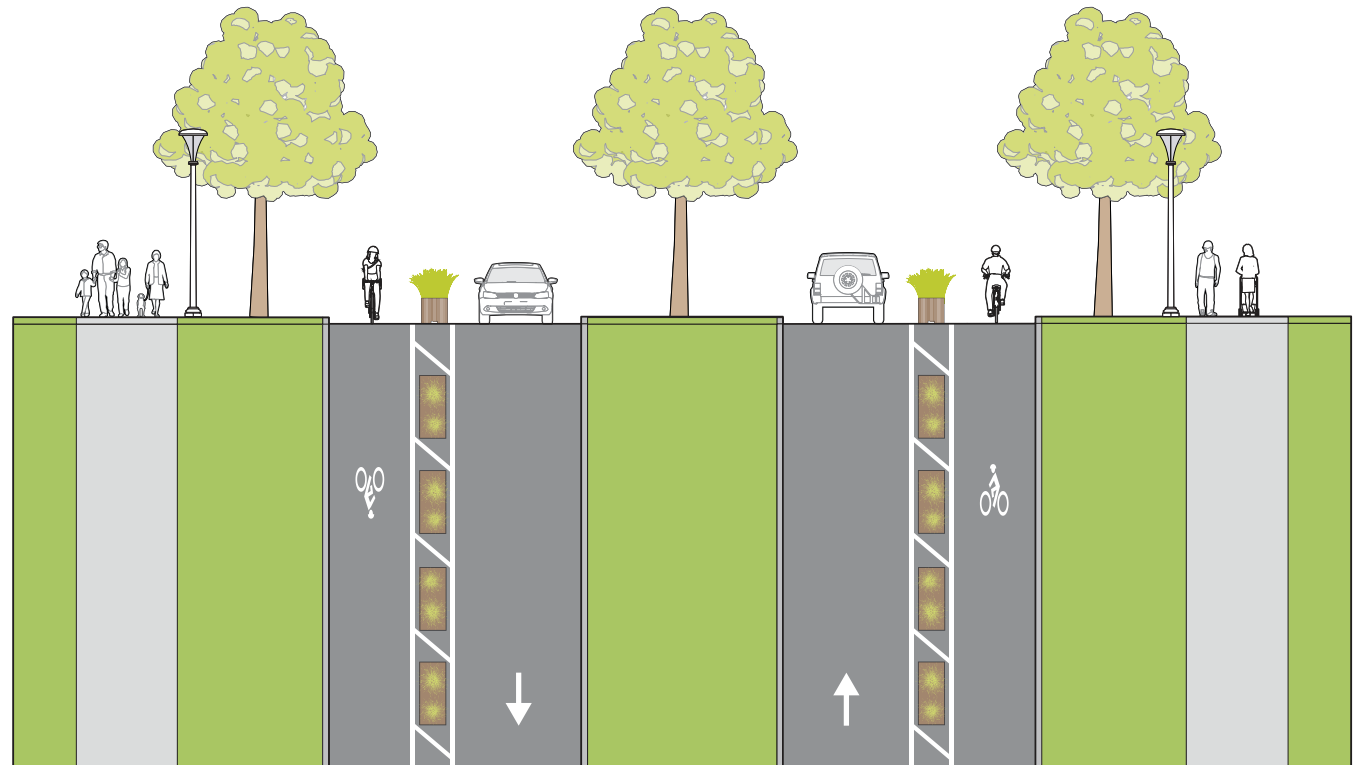

	Frontage Zone	Sidewalk Zone	Amenity Zone	Curbspace	Outside Travel Lane	Inside Travel Lane	Median
Preferred	-	8'	12'	8'	12'	10'	16'
Minimum	0'	6'	8'	7'	11'	10'	12'
Maximum	8'	-	-	9'	12'	10'	-

# Contemporary Parkway

## Right-Of-Way Allocation Priorities

Street Elements	Low	High
Overlays	←	→ <b>C</b>
Frontage Zone	← <b>C</b>	→
Sidewalk	←	→ <b>C</b>
Amenity Zone	←	→ <b>C</b>
Curbspace	← <b>C</b>	→
Drive Lanes	← <b>C</b>	→
Medians	←	→ <b>C</b>

**C** Contemporary Parkway



Denver’s modal hierarchy prioritizes people walking, rolling, bicycling, and using transit. For this reason, relevant overlays should be the highest priority on any given street type. Consult the Overlays section for guidance on how to apply overlays.

## Design Parameters and Operational Characteristics

Design Speed*	20-25 mph
Typical Daily Traffic Volumes	500 - 10,000
Driveway Frequency	Moderate
Freight Loading/Unloading Location	Alley and on-site accessed via alley

\*Designers should strive to use the lower range of design speeds whenever possible to ensure maximum safety for all road users. The design speed should match the posted speed.

## Appropriate Design Elements

Design Type	Most Appropriate Elements	Other Compatible Elements
<b>Pedestrian Realm and Curbside Features</b>	Pedestrian Lighting; Street Trees and Supporting Infrastructure	Street Furniture; Bicycle and Dockless Mobility Parking; On-Street Parking; Parklets
<b>Safe and Accessible Features</b>	Crosswalks; Curb Extensions; Median Refuge Islands	Accessible Parking and Loading Zones; Chicanes and Pinch Points; Driveway Crossings; Hardened Centerlines; Transit Signal Priority; Corner Islands and Turn Wedges; No Turn on Red; Pedestrian Signal Phasing; Raised Crossings; Speed Cushions, Humps, and Tables; Uncontrolled Pedestrian Crossings
<b>Green Infrastructure</b>	Bioretention Facilities; Pervious Surfaces	

# Local Streets

Local streets can vary in their land uses and are found in all neighborhood contexts. They are most often characterized by residential uses. Local streets provide the lowest degree of through travel for motor vehicles but the highest degree of property access. These streets also form the backbone for Denver's Neighborhood Bikeways by using traffic calming, including traffic circles, and curb extensions to encourage slower speeds and promote safety for all roadway users. Street trees within an amenity zone are generally used to separate people walking or rolling from traffic.



Local Street with Bicycle Overlay

## Example Streets

Local streets are the predominant street type in Denver.

	Frontage Zone	Sidewalk Zone	Amenity Zone	Curbspace	General Travelway*
Preferred	-	6'	8'	8'	16'
Minimum	0'	5'	5'	7'	16'
Maximum	2'	-	12'	9'	20'

\*Local streets typically do not have striped travel lanes, but instead a general travelway for both directions of travel.

# Local Streets

## Right-Of-Way Allocation Priorities

Street Elements	Low	High
Overlays	←	→ <b>L</b>
Frontage Zone	← <b>L</b>	→
Sidewalk	←	→ <b>L</b>
Amenity Zone	←	→ <b>L</b>
Curbspace	←	→ <b>L</b>
Drive Lanes	← <b>L</b>	→
Medians	<b>NOT COMPATIBLE</b>	

**L** Local



Denver’s modal hierarchy prioritizes people walking, rolling, bicycling, and using transit. For this reason, relevant overlays should be the highest priority on any given street type. Consult the Overlays section for guidance on how to apply overlays.

## Design Parameters and Operational Characteristics

Design Speed*	15 - 20 mph
Typical Daily Traffic Volumes	500 - 5,000
Driveway Frequency	High
Freight Loading/Unloading Location	Alley and on-site accessed via alley (preferred) and on-street

\*Designers should strive to use the lower range of design speeds whenever possible to ensure maximum safety for all road users. The design speed should match the posted speed.

## Appropriate Design Elements

Design Type	Most Appropriate Elements	Other Compatible Elements
<b>Pedestrian Realm and Curbside Features</b>	Street Trees and Supporting Infrastructure	On-Street Parking
<b>Safe and Accessible Features</b>	Crosswalks; Curb Extensions; Neighborhood Traffic Circles	Access Control and Diverters; Chicanes and Pinch Points; In-Street Yield to Pedestrian Signs; No Turn on Red; Pedestrian Signal Phasing; Raised Crossings; Speed Cushions, Humps, and Tables; Uncontrolled Pedestrian Crossings
<b>Green Infrastructure</b>		Bioretention Facilities; Pervious Surfaces

# Shared Streets

A shared street is a street that includes a shared zone where pedestrians, bicyclists, and motor vehicles mix in the same space. They can be one- or two-way streets. They prioritize pedestrian mobility over motorist mobility and frequently feature design elements that encourage low motor vehicle speeds and volumes. Shared streets are appropriate where pedestrian activity is high and motor vehicle and transit demand along the street is low. In downtown or mixed-use areas, shared streets often include café space, gathering areas, seating, art, and landscaping.

Shared street environments can be challenging for pedestrians with vision disabilities, because they often lack navigational cues such as curbs and defined crossings. Similarly, stormwater drainage on shared streets do not include curbs. Care must be taken to design shared streets that are accessible for all users, and designers should consult the Federal Highway Administration's 2017 *Accessible Shared Streets* guide.

The content in this section pertains to streets that are permanently designed to be shared. The Regular Closure and Festival Streets Overlay describes streets that are meant to be shared temporarily.



## Example Streets

- » Fillmore Plaza
- » E 39th Avenue

**Comfort Zone**  
(pedestrian access route)

**Amenity Zone**  
(space for greening/ activation)

**Shared Zone**  
(shared circulation for pedestrians, bicycles, vehicles)

	Comfort Zone	Amenity Zone	Shared Zone
Minimum	6'	5'	16'
Maximum	-	-	24'

# Shared Streets

## Design Parameters and Operational Characteristics

Design Speed		10 mph
Typical Daily Traffic Volumes		100-400
Driveway Frequency		Low
Primary Curbside Uses		N/A
Freight Loading/Unloading Location	Alley and on-site accessed via alley (preferred) and on-street	

Shared streets can either include curbs or be curbless (a.k.a. flush). Curbless streets are sometimes preferred to promote flexibility and access for events and to message that motor vehicles are the “guest.” If a shared curbless street is chosen, the designer should include detectable elements to prevent pedestrians with vision disabilities from inadvertently crossing into lanes shared with vehicles outside of designated crossings. Designers must ensure adequate stormwater drainage on shared streets.

## Appropriate Design Elements

Design Type	Most Appropriate Elements	Other Compatible Elements
<b>Pedestrian Realm and Curbside Features</b>	Pedestrian Lighting; Street Furniture; Street Trees and Supporting Infrastructure; Bicycle and Dockless Mobility Parking; Parklets	
<b>Safe and Accessible Features</b>	Access Control and Diverters; Chicanes and Pinch Points; In-Street Yield to Pedestrian Signs; Pedestrian Signal Phasing; Raised Crossings; Speed Cushions, Humps, and Tables	Crosswalks; Curb Extensions; Neighborhood Traffic Circles; No Turn on Red; Uncontrolled Pedestrian Crossings
<b>Green Infrastructure</b>	Bioretention Facilities; Pervious Surfaces; Stormwater Tree Trenches	

# Overlays

Complementing Denver’s street types are seven overlays. The overlays are pedestrian, bicycle, transit, historic parkway, ultra-urban green streets, school zone, and regular closure and festival street networks that must be considered when designing a street. These street designations can be combined with any street type. This section describes how to apply the overlays.

## Data Sources to Determine Street Overlays

Overlay	Source
Pedestrian Priority	Blueprint Denver
Bicycle Priority	Latest City GIS Database
Transit Priority	Denver Moves: Transit
Historic Parkways	Designated Parkways and Boulevards Design Guidelines
Ultra-Urban Green Streets	Denver Green Infrastructure Implementation Strategy
School Zones	Latest City GIS Database
Regular Closure and Festival Streets	DOTI data



## Pedestrian Priority

The City of Denver has identified Pedestrian Priority Areas as areas where land use, built environment, and demographic factors contribute to high levels of walking. Pedestrian Priority Areas are a tool to inform how a street’s design and operations should differ from standard design to serve high levels of walking. Pedestrian Priority Areas indicate places where a vibrant, green, and shaded streetscape is desired to support economic vitality and sense of place.

At a minimum within Pedestrian Priority Areas, more width should be allocated to the amenity zone, sidewalk zone, and frontage zone and streets should be operated so that pedestrian convenience is paramount (e.g., shorter cycle lengths at traffic signals). On these streets, designers should strive to use preferred or maximum amenity, sidewalk, and frontage zone widths for each street type. Other streetscape design features—such as pedestrian-scale street lighting, sidewalk café design, and wayfinding—should be prioritized in Pedestrian Priority Areas. Where design and operations trade-offs are needed, elements that promote pedestrian comfort should be given priority. These trade-offs may include removal of a general-purpose travel lanes or on-street parking, or siting new buildings with more generous setbacks.



## Bicycle Priority

Bicycle Priority streets, and those with designated bikeways, should be designed and operated to prioritize people riding bicycles over other modes. Existing and planned bikeways are shown in the City and County of Denver’s latest GIS database.

Bikeway designations are typically selected based on a street’s motor vehicle volumes, motor vehicle speeds, width, and number of travel lanes. More guidance on how to select a bicycle facility type as well as standard design treatments for bikeways can be found in the *Denver Bikeway Design Manual*.

Sometimes, building bikeways requires trade-offs to prioritize safety for people using all modes of transportation. In these instances, it may be appropriate to remove travel lanes and or on-street parking in order to build comfortable and convenient bikeways.

On streets with existing or planned bikeways, the following design criteria and street elements should be prioritized.

- » **Protected Intersections:** People biking are most vulnerable at intersections. Where space allows, protected intersections and adequate street buffers should be prioritized. Refer to the Bikeways at Intersections section of this document and the *Denver Bikeway Design Manual* for details on designing protected intersections.
- » **Bicycle Signals:** When space is limited and high turning volumes are anticipated, separate bicycle signal phasing should be considered.
- » **Bicycle Parking:** End-of-trip facilities are particularly important to encourage bicycling. Bicycle parking in the amenity zone or curbspace should be prioritized on most blocks.



## Transit Priority

*Denver Moves: Transit* identifies Transit Capital Investment Corridors where frequent service throughout the day and evening is supported by various levels of City-built improvements. Those investments ensure rapid, reliable, and comfortable service that make transit a convenient choice.

There are three tiers of Transit Capital Investment Corridors that make up a connected network of high to moderate capacity transit priority routes. High-Capacity Transit Corridors can be rail or full bus rapid transit (BRT) corridors. Medium-Capacity Transit Corridors are those with either a rapid bus or full BRT. Speed and Reliability Corridors benefit from investments like transit-priority signals and transit lanes at key locations. The table below from *Denver Moves: Transit x D: Transit-Friendly Streets Guide* shows general guidelines for designing for the three transit corridor types.

Where design and operations trade-offs are needed, transit reliability and access will be given priority on Transit Capital Investment Corridors. These trade-offs may include removal of a general-purpose travel lane or on-street parking. The following factors play a role in deciding when and where to make these types of trade-offs.

- » **Person Throughput:** Transit-only lanes are justified if the shift from general-purpose travel lanes to transit lanes increases the total number of people that can be carried through a corridor.
- » **Bus Volume:** Transit-only or BRT lanes are typically more useful when there are higher volumes of buses using the dedicated lanes. Refer to City policy to determine if bus volumes warrant use of dedicated transit lanes.
- » **Speed:** The transit-only or BRT lane provides an increase in transit operating speed (for the distance of the lane or in the corridor), improves the overall person speed through the corridor, or improves service reliability.
- » **Increased Reliability:** The transit-only or BRT lane dramatically improves reliability and reduces travel time on consistently delayed bus routes and formalizes existing bus operational patterns.

On Transit Capital Investment Corridors, the following design criteria and street elements should be prioritized, while providing space for vegetation.

- » **Travel Lane Width:** Outside travel lanes (alongside a curb) used by buses, including transit-only lanes, should be 12' wide, including the gutter pan. Inside travel lanes used by buses should be 11' wide.
- » **Wider Pedestrian Realm:** The pedestrian realm on frequent transit routes should be sufficiently wide to accommodate higher volumes of people walking and rolling, as well as space for transit stop amenities. When possible, designers should use the preferred amenity zone width of 8'.
- » **Floating Bus Stops:** Floating bus stops “float” between a protected bike lane and travel lane. They should be prioritized on streets with both transit and bicycle priority,
- » **Transit Signal Priority:** At key intersections, transit signal priority should be considered to increase speed and reliability of transit vehicles.

**Transit priority elements by corridor type**

Element	Corridor Type		
	High Capacity Transit	Medium Capacity Transit	Speed & Reliability Corridor
<b>Transit Priority</b>	<ul style="list-style-type: none"> <li>» Dedicated transit lanes, either center- of side-running</li> <li>» Running way treatments</li> <li>» Signal Priority</li> </ul>	<ul style="list-style-type: none"> <li>» Transit lanes (including bus-and-turn lanes) in strategic locations, at specific times, and/or in the peak travel direction</li> <li>» Running way spot improvements</li> <li>» Queue jumps/bypass lanes</li> <li>» Signal priority</li> </ul>	<ul style="list-style-type: none"> <li>» Queue jumps/bypass lanes in select locations</li> <li>» Signal priority in conjunction with queue jumps</li> </ul>
<b>Stop and Station Spacing</b>	1/3 to 1/2-mile	1/4 to 1/2-mile	1,000 feet to 1/4 mile

## Historic Parkway

Denver has a legacy of 35 unique streets that are formally designated parkways and boulevards. These streets were intended to be grand tree-lined avenues—part street, part park. While many of the parkways are wide, landscaped streets with park-like settings, some lack these characteristics. Existing designated parkways are individually distinct. While setbacks vary among parkways depending on individual design characteristics, they typically are ample with residential parkways having the deepest setbacks taken from the property line.

Designers should approach the retrofit of historic parkways with cross-departmental collaboration and integration of the design recommendations presented in Chapter 2 of the 2005 *Designated Parkways and Boulevards Design Guidelines*. Because Denver's existing historic parkways vary greatly in design and function, opportunities for redesign should respect each parkway's context while supporting the City's goals for traffic safety, multimodal infrastructure, green infrastructure, stormwater management, and travel behavior.

## Ultra-Urban Green Streets

Ultra-urban green streets provide stormwater management by incorporating vegetation, soils, pervious surfaces, and other methods to slow and cleanse stormwater runoff from paved surfaces. These methods of water filtration remove much of the pollutants that accumulate on roadways and protect water quality in streams and rivers, improve air quality, benefit public health, reduce energy demands, and create pleasant, inviting spaces.

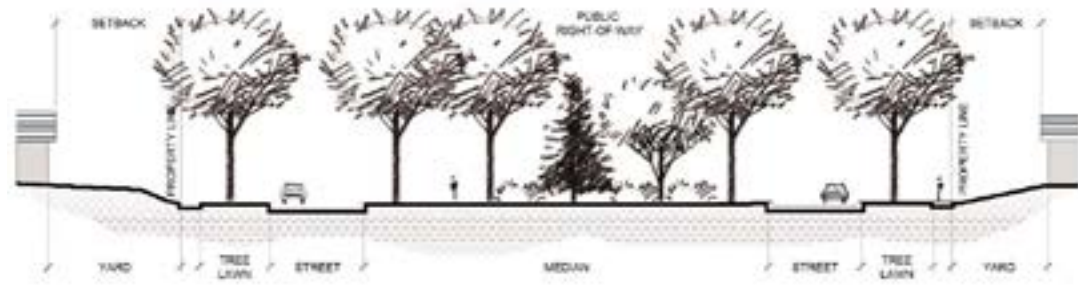

Image credit: Denver's Designated Parkways and Boulevards Design Guidelines

Denver's *Green Infrastructure Implementation Strategy* identifies high and medium priority streets and project recommendations for each in creating a network of green streets across Denver. This document should be consulted before beginning any project to identify opportunities for cross-department collaboration. Denver's *Ultra-Urban Green Infrastructure Guidelines* provide standard details and in-depth information about how to construct green street elements, such as streetside stormwater planters, green gutters, green alleys, and incorporating street trees. On streets with this designation, priority design elements include:

- » **Wide amenity zone:** Most green street elements are focused in wide amenity zones. Features like landscaping and bioretention facilities make these streets pleasant for walking, rolling, and bicycling.
- » **Medians:** Landscaped medians and traffic circles can enhance the vibrancy of a street while calming traffic. To accommodate tree planting, medians should be at least 8' wide and 40' long.

In downtowns, amenity zones may be ideal for ultra -urban applications as described. In residential and main street applications, where mature landscapes often exist, green infrastructure facilities are best placed at intersections where they can efficiently accept runoff from entire blocks.

## School Zones

Denver is home to numerous elementary, middle, and high schools located on all types of streets. Streets in school zones should be designed with slower speeds to allow students to safely walk, roll, bike, or scoot to and around the school grounds.

### School Zone Required Elements

In order to ensure that people driving, biking, and walking in school zones know how to behave safely, it is important that all school zones include some of the same elements, such as signage, pedestrian crossings, and standard speed limits. School zone speed limits are set according to City policy; please refer to this policy for more direction.

Signs let people know that they are entering a school zone and that they should drive with extra caution when children are present. On all streets that surround a school property, SCHOOL (S4-3) and speed limit signs should be placed within one to two blocks of the school to alert drivers.

All marked crosswalks in a school zone should be high-visibility (continental) to promote motorist yielding.

## Typical Engineering Treatments for School Zones

## Performance Objective

Treatment	Application	Reduce Vehicle Speeds	Increase Visibility	Reduce Pedestrian Exposure
<b>Along the Roadway</b>				
Roadway/Lane Narrowing (add Bike or Bus only lanes, sidewalks, medians, parking)	Arterial, Collector	✓		✓
Speed Cushions/Humps/Tables	Local	✓		
Chicanes	Local	✓		
Midblock Crossings	Arterial, Collector, Local		✓	✓
Raised Pedestrian Crossing (Midblock)	Collector, Local	✓	✓	✓
Median Refuge Island	Arterial, Collector	✓	✓	✓
Pedestrian Hybrid Beacon/ Rectangular Rapid Flashing Beacon	Arterial, Collector		✓	✓
<b>At Intersections</b>				
Parking Setbacks (daylighting)	Arterial, Collector, Local		✓	
Curb Extensions	Arterial, Collector, Local	✓	✓	✓
High-Visibility Crosswalks (Continental)	Arterial, Collector, Local		✓	
Advance Yield/Stop Lines	Collector, Local		✓	
In-Street Pedestrian Crossing Sign	Collector, Local	✓	✓	
Raised Intersection	Collector, Local	✓	✓	✓
Smaller Curb Radii	Arterial, Collector, Local	✓		
Hardened Centerlines	Arterial, Collector	✓		
Mini Traffic Circles	Local	✓		
Leading Pedestrian Intervals	Arterial, Collector		✓	✓
Right Turn on Red Restrictions	Arterial, Collector			✓
Pedestrian Scale Lighting	Arterial, Collector, Local		✓	

## Other School Zone Considerations

There are many engineering tools and designs that support safer streets, particularly around schools. Application of these elements vary depending on the problem being addressed, adjacent roadway context, speeds, and traffic volumes. Streets in school zones should be designed with a high degree of safety features for vulnerable users; the table at left shows the engineering treatments that are most appropriate for school zones (source: FHWA PEDSAFE). For detailed information on where these treatments apply, see Chapter 3 of the Guidelines.

In addition to coordinating education, enforcement, and encouragement activities in schools, Denver's Safe Routes to School program works with the community to identify engineering and landscaping solutions that promote safety around Denver schools. If the practitioner is designing a street within a school zone, they should coordinate with DOTI Safe Routes to School staff to ensure that any known issues are being addressed.

## Regular Closure and Festival Streets

Regular Closure Streets are closed to motor vehicle traffic at regularly scheduled times, and Festival Streets are only closed for special events like markets, concerts, or open space programming. While any street can be closed regardless of street type designation, streets designed as Shared Streets are most conducive because of their function in Denver's street network and unique design elements such as distinct pavement materials.

Street closures—regular or infrequent—require permits to be obtained through DOTI. Streets designed specifically to be Festival Streets should be able to accommodate periodic vendor booths, food trucks, performance stages, and other festival-related amenities by providing connections to electricity and access for loading and unloading. Flexibility is key: design features (e.g., furniture, stages) should be movable so that spaces can be reprogrammed for a variety of uses. Motor vehicle access may be restricted using removable or collapsible bollards, or traffic control with temporary barriers and police enforcement can be required in the permit application.

A Supplemental to this document (*Repurposed Streets Guide: Implementing Temporary Street Changes*) discusses temporary street interventions associated with the City's ongoing COVID-19 pandemic response. One of the street configurations discussed in the Supplemental are Temporary Recreation Streets (T-RECS). T-RECS are distinct from the Shared Street type identified here. While T-RECS are intended to simulate the shared street environment, no permanent design treatments are installed as part of T-RECS. The temporary street configurations covered in the Supplemental are also distinct from the Regular Closure and Festival Streets overlays, which provide guidance on event planning considerations related to street closures.

THIS PAGE INTENTIONALLY LEFT BLANK.



Photo credit: Streetsblog Denver

# 3. Street Design Details

This chapter is divided into four sections:

- » **Pedestrian Realm and Curbside Features:** This section provides details for elements that provide a safe and pleasing environment for people walking, as well as elements that are behind and adjacent to the curb such as bike and dockless mobility parking, parking meters and on-street parking, and transit stops.
- » **Safe and Accessible Features:** These details enhance the safety and ease of use for people using all modes of travel. They provide traffic calming by slowing motor vehicles, provide physical separation for and increase visibility of vulnerable roadway users, and enhance accessibility for users of all ages and abilities.
- » **Green Infrastructure:** These elements beautify streets and mitigate adverse environmental impacts from pollution, stormwater runoff, and heat island effect.
- » **Utilities:** This section provides guidance for utilities, including small cell towers and stormwater infrastructure.

Each street design detail provides a description and illustration depicting critical guidance including design components and dimensions. In addition, information is provided on the use, design, and considerations for most elements.

- » **Use:** Defines what the element achieves and where the element is appropriate.
- » **Design:** Identifies dimensional, placement, and other requirements for design features and elements.
- » **Considerations:** Describes opportunities for enhancements or alternative design features that practitioners should consider related to use, maintenance needs, and culture.

This chapter contains details about various street design treatments, including how to apply such elements. Chapter 2 noted which design elements would be appropriate for each street type; however, project-level conditions and goals, as well as engineering judgment, should dictate which street design elements are most appropriate.

This chapter does not include every detail or feature required for the design of streets and other City and County of Denver and national guides should be used as a supplement to the Guidelines.

## Chapter Sections

Within each category, street design details are generally organized alphabetically. Note that bikeway design parameters are not comprehensively covered in the Guidelines, as that information can be found in the *Denver Bikeway Design Manual*.

### Pedestrian Realm and Curbside Features

- » Accessible Pedestrian Zones
- » Bicycle and Dockless Mobility Vehicle Parking
- » Curbspace and Mode-Specific Travelway
- » Electric Vehicle Charging Stations
- » Irrigation: Tap, Backflow, Controller
- » Loading and Freight Zones
- » Materials
- » Metered Parking
- » Mobility Hubs
- » On-Street Parking
- » Parklets
- » Pedestrian and Street Lighting
- » Pedestrian Realm Zones
- » Street Furniture
- » Street Trees and Supporting Infrastructure
- » Transit Stops and Shelters

### Safe and Accessible Features

- » Access Control and Diverters
- » Accessible Parking & Loading Zones
- » Alleys
- » Bicycle Highways
- » Bikeways at Intersections
- » Bus and Bicycle Interactions
- » Chicanes and Pinch Points
- » Corner Islands and Turn Wedges
- » Corners and Curb Radii
- » Crosswalks
- » Curb Extensions
- » Curb Ramps
- » Driveway Crossings
- » Hardened Centerlines
- » In-Street Yield to Pedestrian Signs
- » Median Refuge Islands
- » Neighborhood Traffic Circles
- » No Turn on Red Restrictions
- » Pedestrian Signal Phasing
- » Raised Crossings and Intersections



- » Sight Lines and Visibility (Daylighting)
- » Speed Cushions, Humps, and Tables
- » Transit Priority at Intersections
- » Uncontrolled Pedestrian Crossings

### Green Infrastructure

- » Bioretention Practices
- » General Guidance
- » Pervious Surfaces
- » Stormwater Tree Trenches

### Utilities

- » General Guidance
- » Small Cell Towers



# Pedestrian Realm and Curbside Features

## Pedestrian Realm Zones

The pedestrian realm encompasses the sidewalk and street elements that directly influence the walking environment, including:

- » The frontage zone, which allows for detailed vertical adjustments between the sidewalk and the property line and can accommodate sidewalk dining, signage, and street furniture.
- » The sidewalk zone, which is the space that must be kept clear for people to walk and roll through.
- » The amenity zone, which provides a dedicated area for street trees and furnishings.

Pedestrians experience the pedestrian realm on the surface, but there are subsurface utilities, irrigation, tree roots, and water quality areas below grade that must be carefully coordinated to ensure that all systems function and adequate space is provided for tree roots to expand and thrive.

The width of each zone will vary given the street type, the available right-of-way, the scale and location of buildings abutting the right-of-way, and the intensity and type of existing and future uses and zoning along each street segment. It is the designer's responsibility to assign appropriate widths for each zone within the pedestrian realm based on the preferred, minimum, and maximum widths in the figure to the right.

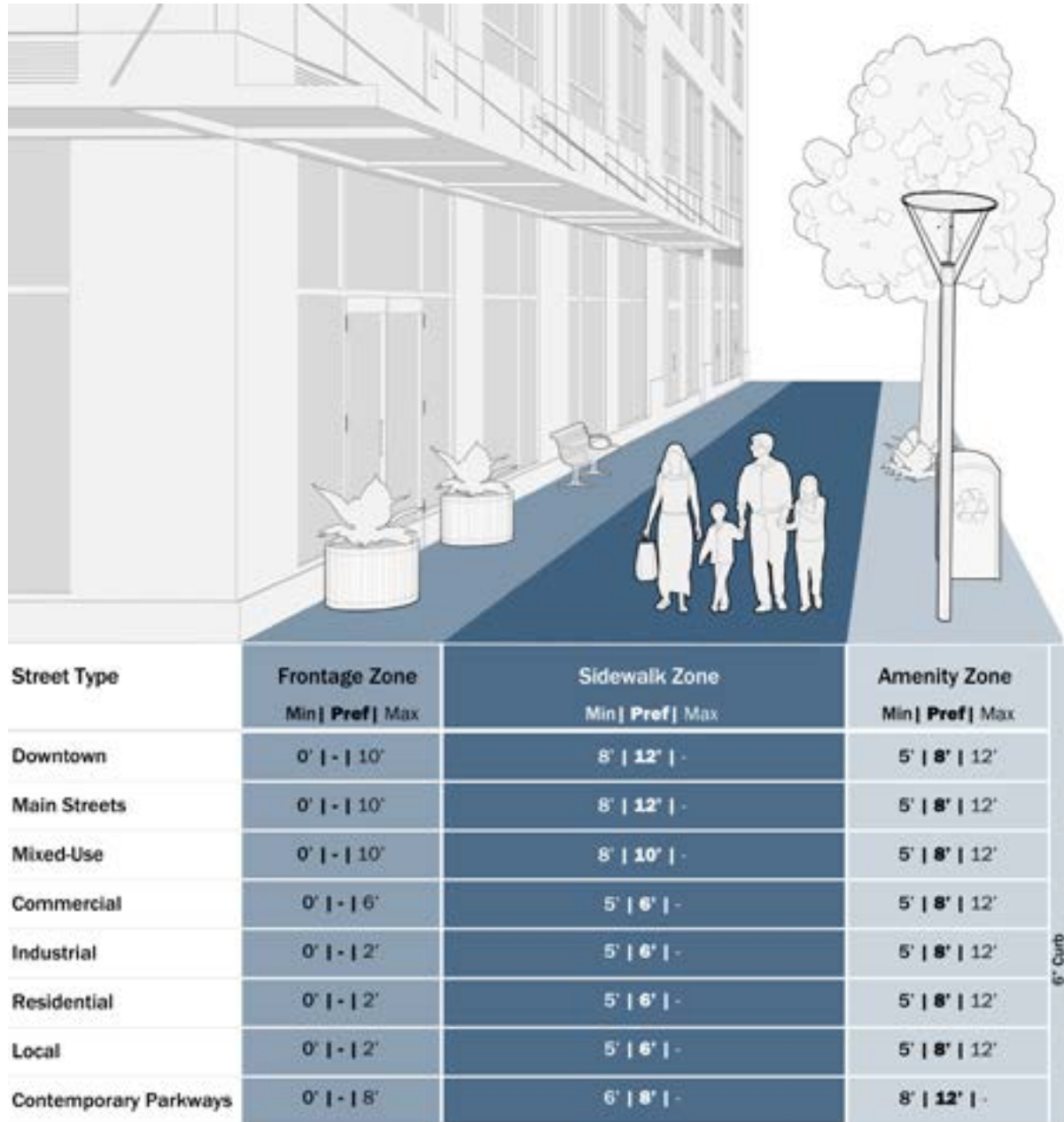

Pedestrian Realm Zone Widths

Notes: 8' of clear walkway is required for pedestrian realms greater than 21 feet and for all sidewalks on arterial streets, regardless of street type. All or a portion of the Frontage Zone may be accommodated on private property in coordination with setback and build-to standards.

When allocating space within the pedestrian realm, the most critical dimension is the sidewalk zone width with a 1.5% cross slope. While amenity zones can be as narrow as 5' for some street types in constrained situations, an 8' width minimum amenity zone is required to accommodate street trees and tree roots. Finally, the frontage zone must be wide enough to accommodate vertical grade change between the flow line as the road profile rises and falls and the given elevation at the right-of-way or front door that is not accommodated by the combined curb height, slope of the amenity zone, and the fixed cross-slope of the sidewalk. To accommodate sidewalk dining, the frontage zone should be 8' or wider. Alternatively, sidewalk dining may be partially or entirely located on private property.

A balanced approach for determining the width of pedestrian realm zones begins with an understanding of these conditions, but must also consider the character of the surrounding neighborhood, existing and anticipated pedestrian activities, and existing and anticipated land uses and zoning abutting the right-of-way. For example, a street flanked by ground floor retail or commercial uses that encourages window shopping and pedestrian access, or a street that connects a predominately residential neighborhood to a commercial district may require a wider pedestrian realm. The massing, scale, and height of adjacent buildings and what land uses and building mass are permitted under existing zoning, combined with the desired character of the street should influence pedestrian realm widths.

The width of the pedestrian realm should also be influenced by the street width, traffic volumes, and traffic speeds. Narrow sidewalks prevent pedestrians from being able to walk side-by-side or pass oncoming pedestrians, and they can be particularly limiting for people using mobility devices.

**The Guidelines establish that Denver's streets should be designed from the outside in.** This approach prioritizes the pedestrian and considers the uses and activities along the street edge in balance with travel demands. That said, many older streets in Denver have right-of-way constraints. In some cases, preferred zone widths may not be feasible, and design alternatives and trade-offs must be applied to achieve a comfortable and functional balance.

## Frontage Zone

The frontage zone is the area between the property line and the back edge of the sidewalk zone that primarily accommodates vertical grade changes in the pedestrian realm but can also provide additional space for outdoor dining areas, enhanced streetscape features, and transitions to interior uses. It can extend beyond the right-of-way and be contiguous with improvements on private property, especially when coordinated with setbacks and shifts in the building facade. All or a portion of the frontage zone may be accommodated on private property in coordination with setback and build-to standards as required by the Denver Zoning Code. In commercial and mixed-use zone districts, retail spillover and outdoor dining in the frontage zone can contribute to the vitality and character of a street. The frontage zone must not impact minimum clear sidewalk zone widths or degrade existing planting areas.

## Sidewalk Zone

Historically, most sidewalks in Denver's older, established neighborhoods are 5' wide, which is also Denver's current minimum sidewalk width for local and collector streets. While this dimension is often adequate for single-family neighborhoods on local streets, wider sidewalks are often necessary on Downtown, Main, Mixed-Use, and Commercial Streets that permit higher density multi-unit residential development, mixed-use development, as well as collectors and arterials. Eight feet of clear space is required for arterials and pedestrian realms 21' wide and greater. Widening of existing sidewalks and construction of new sidewalks are often cost prohibitive due to impacts to drainage, utilities, and existing, mature street trees. Sidewalk widths can be increased during street reconstruction projects, but they should be fully integrated with adjacent amenity zone, frontage zone, and curbspace uses.

The sidewalk zone must be clear of all obstructions such as utilities, traffic control devices, trees/plantings, furnishings, and bicycle and dockless mobility vehicle parking. Street reconstruction projects should locate all utility access points including electrical, telecommunication, and irrigation control access boxes outside of the sidewalk zone and tree planting areas as much as possible. Generally, sidewalk alignments should be straight and avoid meandering.

## Amenity Zone

The amenity zone serves multiple purposes. While the primary goal is to buffer pedestrians from both parked and moving motor vehicles, it also provides space for elements that define the overall character of the street. Elements typically located in amenity zones include street trees, bike parking, furnishings, bus stops, supplemental plantings, streetside stormwater planters, utilities including access boxes and overhead poles, pedestrian and vehicular lighting, and small cellular towers. The primary priority for this zone, however, is provision of street trees and vegetation, regardless of street type.

A step-out zone is a part of the amenity zone and allows for easy access from parked motor vehicles to the sidewalk and denotes access/egress points along the amenity zone. It is the space between the back of the curb and the more active amenity zone. When needed, this space must be kept clear of any obstructions per City requirements.

## Curbspace and Mode-Specific Travelway

Within the roadway and when present, the curbspace and mode-specific travelway are typically located in between the general travelway and the amenity zone. The image below shows one possible configuration, but the location of each subzone can vary depending on design goals and operational factors. Expectations for the use of this space are increasingly diverse. Among its many functions (as listed in the table on the following page), the curbspace can provide space for buses at bus stops, for parked cars or dockless mobility vehicles, for passenger pick-up and drop-off a passenger, for deliveries, for parklets, and for trees and green infrastructure. Given urban mobility demands, curbspace is highly valued in Denver. The curbspace should be designed and managed based on the highest and best uses that serve the greatest number of people. This is consistent with the City's goals of moving people—not just motor vehicles—on Denver's streets.

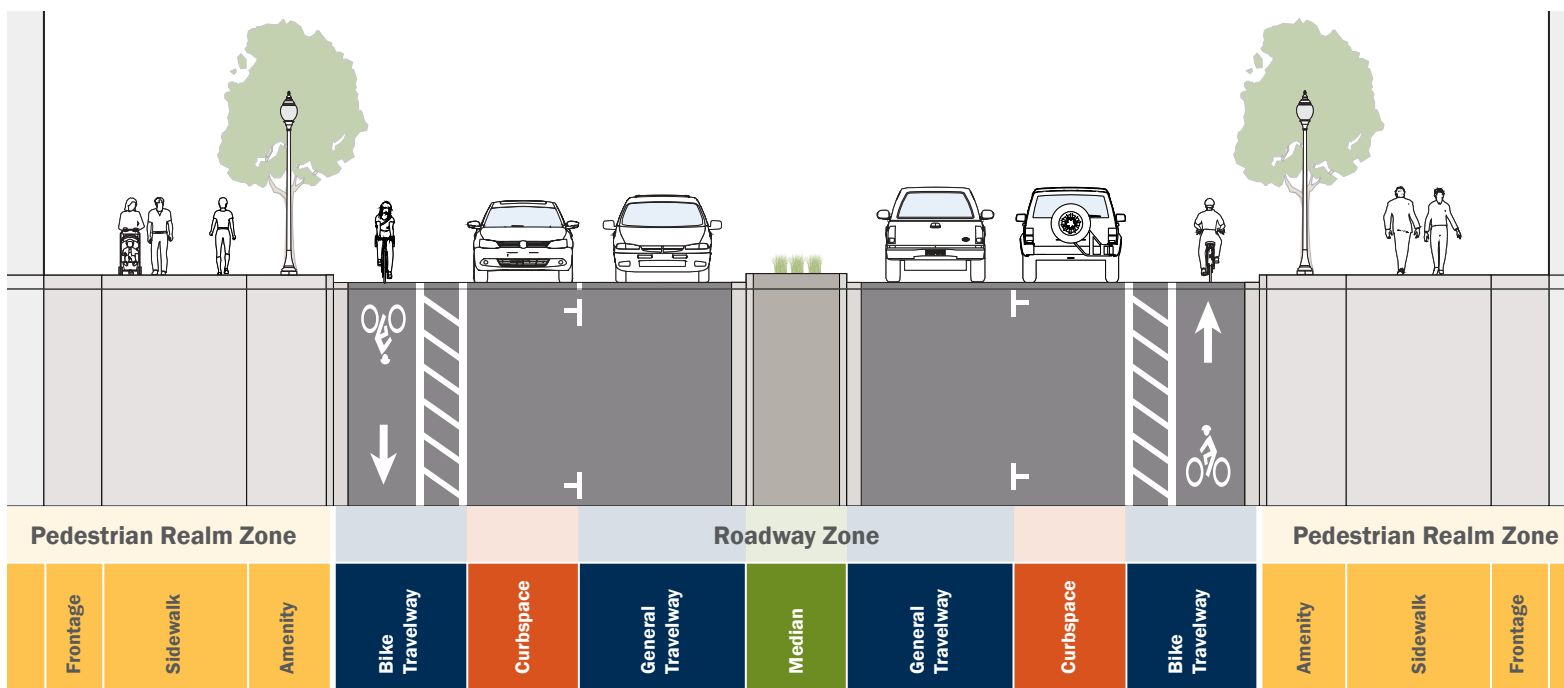

## Curbspace Functions and Uses

Curbspace Function	Example of Uses*
Access for People	» Transit stops
	» Bicycle and dockless mobility vehicle parking
	» Curb extensions or chicanes
	» Car share parking
	» Passenger loading zones (including taxis and ride-hailing)
Access for Commerce	» Valet zones
	» On-street parking (short-term)
Access for Commerce	» Commercial vehicle loading zone
Greening	» Street trees and supporting infrastructure
	» Green infrastructure
Activation	» Parklets
	» Food truck space
	» Public Art

\*Please see the relevant sections in Chapter 3 for a description of each use and its design considerations.

The designer should prioritize curbside uses to match intended outcomes and function to the street’s context. Curbspace should be highly prescribed and monitored on Downtown and Main Streets and generally, least prescribed and monitored on Commercial Streets. The following table shows the priority of curbspace functions.

## General Curbspace Priorities by Street Type

Street Type	Priority Functions
Downtown One-Way Arterials	Access for People, Activation, Greening
Downtown Two-Way Arterials, Downtown Collectors, Main Streets	Access for People, Activation, Greening, Access for Commerce
Mixed-Use Streets	Access for People, Greening, Activation, Access for Commerce
Commercial Streets	Access for Commerce, Access for People, Greening
Industrial Streets	Access for Commerce, Access for People, Greening
Residential and Local Streets	Access for People, Greening, Access for Commerce
Contemporary Parkways	Greening, Access for People
Shared Streets	Access for People, Greening, Activation

## Mode-Specific Travelway

The mode-specific travelway can include a variety of mobility uses including bicycle lanes, transit-only lanes, and turn lanes. It is often located alongside (“below”) the curb but can also be located in other places within the roadway zone. When present, like the curbspace, expectations for the use of this space are diverse. The mode-specific travelway should be designated to be consistent with relevant City modal plans (see the Overlays section in Chapter 2). The table below shows recommended width ranges for each type of mode-specific travelway use.

Type of Mode-Specific Travelway	Recommended Width*
Bike	Varies **
Transit	12'
Turn Lanes	9'-10'
Two-way Left-turn Lanes	10'-11'

\*When within an outside travel lane and alongside the curb, transit-only lanes and turn lanes are inclusive of gutter widths. When within an inside travel lane, transit-only lanes should be 11'.

\*\*Bicycle lane and buffer widths vary based on bikeway type and overall street design. Please see the *Bikeway Design Manual* for details.

## Accessible Pedestrian Zones

### Use

» All proposed improvements within the public right-of-way are required to comply with City requirements and the Americans with Disabilities Act (ADA) Accessibility Guidelines as defined by the United States Access Board. ADA is a federal civil rights law that requires providing access to people with disabilities. The Denver Office of Disability Rights coordinates the City and County Denver’s efforts to ensure compliance.

### Design

- » The City requires sidewalks to be 5’ minimum when the pedestrian realm width is less than 21’, and 8’ when pedestrian realm width is equal or greater than 21’.
  - » Minimum widths are only to be used in constrained situations for short sidewalk segments.
  - » Turns in travel paths must have a landing that is 5’ x 5’
  - » Curb ramps must be provided at crossings of pedestrian routes and must have detectable surfaces.
  - » Cross slopes on sidewalks and landings should be designed as 1.5% maximum, which allows for construction tolerance of up to 2%.
- » For more information on accessibility, consult City requirements, the *U.S. Access Proposed Guidelines for Accessible Rights-of-Way* (PROWAG) and Accessibility Guidelines.

### Considerations

- » Established, older commercial and mixed-use neighborhoods necessitate careful consideration during early design phases to ensure that outdated, non-compliant stoops, landings, and ramps—as well as existing infrastructure such as street trees and stormwater quality structures—are integrated into new grades and slopes of streetscape improvement projects.
- » Care should be taken to maintain existing street trees and stormwater structures if possible when upgrading pedestrian zones for accessibility.
- » If the pedestrian accessible route is disturbed, including crosswalks within 10 feet of a curb ramp, then the curb ramp must be brought to compliance.

## Bicycle and Dockless Mobility Vehicle Parking

Bike racks and on-street parking corrals provide structures for people to securely lock their bicycles. Bike racks may be located in the amenity zone, provided there is adequate width to maintain an unobstructed path of travel for people walking and rolling. In addition, bike corrals may be located in the curbside lane of streets or in daylighting areas at street corners in the shadow of parking where there is high bike parking demand and little available sidewalk space. Corrals can be delineated with pavement markings, curb stops, flexible delineator posts (flex posts), or other elements to clearly define the parking area. These spaces can also serve as parking spaces for dockless mobility vehicles, such as e-scooters. See Traffic Signal, Sign and Pavement Marking Standards standard drawings for bike rack and corral installation details.

### Use

- » Within the amenity zone and wide protected bike lane buffers.
- » Within daylighting areas or motor vehicle parking lanes to improve sight lines.
- » At park entrances and at points of interest along off-street trails.
- » At busy bus stops or transit hubs.
- » Bike corrals are allowed on Downtown Streets, Main Streets, Collector streets that are designated bikeways, and on Local Streets.
- » Consider use of bike corrals in busy locations.

### Design

- » Only City-approved racks can be installed within the public realm. Select racks that are versatile and intuitive, allowing bicycles of all shapes and sizes to be locked through the frame and at least one wheel.
- » Bike parking within amenity or frontage zones cannot encroach on the clear sidewalk zone when a bicycle is parked there. A minimum clear width of 5' must be preserved.

- » Bike racks within the amenity zone may be installed perpendicular, parallel, or at an angle to the curb.
- » Bike parking should be set back a minimum of 24" from the curb, with 36" being the preferred setback.
- » Bike parking should be sufficiently set back from the curb to ensure a bicycle of at least 6' in length will fit on the curb and will not be damaged by car doors within an adjacent parking lane.
- » When a group of bicycle racks are provided, 36" should be provided between bike racks. 48" - 60" of space should be allotted between parallel racks. A minimum clear distance of 3' should be provided between a bicycle rack and any other streetscape element.
- » Racks should be placed a minimum of 10' from all fire hydrants.
- » Racks should not be placed within 3' of a tree grate.
- » Racks should not be placed within 4' of the corner of any building.
- » On-street corrals should be clearly delineated with a vertical element such as a parking stop, concrete barrier, or flex post to prevent motor vehicle encroachment.

### Considerations

- » Place racks in visible, well-lit locations and within 50' of commercial/residential building entrance doors.
- » Ensure bike racks are installed on a flat surface where the rack may be bolted or securely fastened to the ground with tamper-resistant, anti-theft hardware.

## Electric Vehicle Charging Stations

Electric and other low emissions vehicles (EVs) are cleaner and more sustainable modes of transportation that are emerging in efforts to reduce greenhouse gas (GHG) emissions and combat climate change. In the City's 80 x 50 Climate Action Plan, Denver set the goal of reducing GHG emissions by 80% by 2050.

**The transportation sector is the second largest source of GHG emissions in Denver and the Climate Action Plan identifies electric vehicles as one of the key ways to reduce GHG coming from motor vehicles.** To achieve GHG reductions, Denver has a goal that by 2030, 30% of motor vehicles would be electric, and 100% of motor vehicles would be electric by 2050.

### Use

- » EV stations should be placed in the curbspace near utility feeder lines and transformers, clear from traffic, and away from flood zones. Refer to current DOTI policy as it relates to on-street electric vehicle charging and parking.
- » Where feasible, charging units should be incorporated in smart grids that use renewable sources such as solar or wind power.
- » Charging units should be installed in the amenity zone, directly on the pavement (similar to a bollard) or pole-mounted, placed at a minimum of 18" from the curb, and located to maximize access for different positions of the charging port on EVs. Coordinate with Office of the City Forester when placing adjacent to existing street trees.

### Design

- » Curbside charging stations should use a minimum Level 2 charger and when appropriate Direct Current (DC) Fast chargers. Level 2 charges operate at 220V to 240V, and a motor vehicle could receive a complete charge in as few as four hours from a 240V system. DC Fast chargers can recharge batteries in around 20 minutes. This could accommodate people living in apartments or at locations without private garage charging. EVs should use the industry-wide standard plug, the J1772 connector, which allows for faster battery charging times.
- » Curbs, bollards, and/or setbacks should be added to protect the station from motor vehicles mounting the curb.

- » Charging stations should be networked and equipped with smart features that allow users to track the location of their motor vehicle, real-time charging updates, and the ability to reserve charging stations online or via smart phones.
- » Signs should designate EV-only parking, instructions for use, time limits for charging, and positioned to meet all accessibility requirements.
- » On-street EV charging stations should have a cord management system to prevent tripping, cord wrap issues, and be functional in inclement weather.

### Considerations

- » Periodic testing of EV hardware and software should be conducted, and parts should be replaced as necessary. Stations should be connected to an online network in order to allow for software maintenance and user inquiries to be conducted remotely by an operator.
- » Charging stations that provide ports for multiple vehicles will require additional power supplies and coordination with the utility company.
- » New technology should be considered to allow for wireless charging of EVs, such as through inductive capabilities using an electromagnetic field to transfer energy between the car and a charging pad.
- » Programs to install charging stations on residential streets should be coordinated with neighborhood groups so that location and access-time is geared toward local needs.
- » Maintenance of the charging stations will depend on their ownership; this should be coordinated with the City.
- » Installation should be coordinated with street light and small cell installations to combine facilities and minimize raised encroachments in the right-of-way.

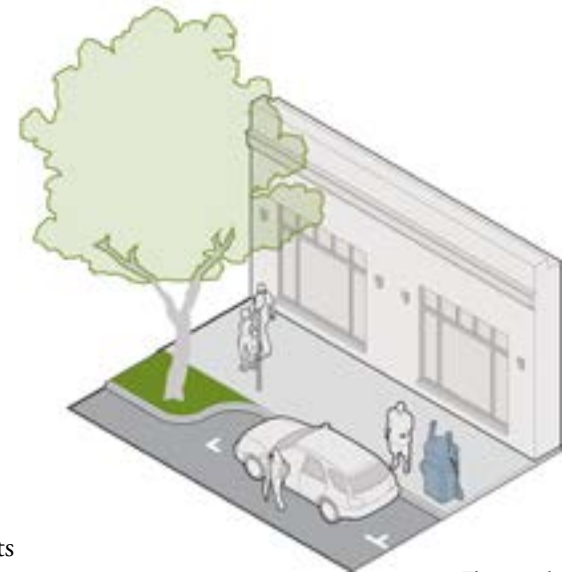

Electric vehicle charging station



## Irrigation: Tap, Backflow, Controller

### Use

- » Automatic irrigation systems are imperative to establishing and maintaining healthy plant material. All street trees, shrubs, annuals, and other vegetation should be irrigated.

### Design

- » Integrate low-water sprinkler heads and monitor availability of evolving water-saving technologies to improve water conservation.
- » Layout should minimize overspray onto hard surfaces and tree trunks.
- » Use drip irrigation whenever possible to reduce evaporation.
- » Select controller(s) with multiple functions and zoning capabilities that are weather- or sensor-based or that include rain shut-off options and remote access to runtime data and scheduling alerts.
- » Program automatic timers to complete watering before the sun and temperatures rise in mornings; ensure that routine maintenance includes resetting of timers to accommodate changes in temperature and weather conditions.
- » Streetscape irrigation systems require a point of service and a meter. Ensure there is sufficient space for the equipment that powers the controller.
- » Include irrigation sleeving for pipes and wiring to reduce future maintenance and repairs.

### Considerations

- » Phased street reconstruction projects and streetscape improvement projects should include sleeving to allow for efficient future expansion of the irrigation system.
- » Design to minimize damage/disturbance to existing trees.
- » Refer to the latest DOTI policy for guidance on maintaining streetscape features that extend across multiple properties.

## Loading and Freight Zones

Freight is a critical element of Denver's local economy, allowing goods to move in and out of the city. Restaurants, shops, and other goods and service providers rely on truck deliveries to keep their businesses running. In high-density environments, such as downtown, or where businesses don't have a parking/loading zone on their property, alleys and streets should accommodate short-term loading. Space is limited and valuable, so on-street loading is typically only provided when it has been documented that alleys are insufficient or that more loading is necessary.

In addition to traditional loading zones for large freight vehicles, consideration should be made for small-scale deliveries and passenger loading in cars, vans, or bicycles. Preferred areas for freight loading and unloading varies by street type. For example, Downtown One-Way Arterials prioritize mobility over parking and loading while Downtown Collectors and Two-Way Arterials elevate the importance of the curbspace for freight vehicles, ride-hailing vehicles, and vehicle parking.

Ride-hailing services (e.g., app-based rideshare companies and taxis) are an important component of urban mobility. Without dedicated pick-up/drop-off zones, ride-hailing vehicles create unexpected conflicts by double parking or blocking bike lanes or bus lanes. A ride-hailing drop-off area should allow drop-offs without requiring reversing or other maneuvers and should consider the volume of use to determine how many cars should be able to stop at one time. Designated loading zones can be used for loading goods or passengers and function as ride-hailing zones. There are options for locating combined ride-hailing and loading zones including the beginning of a block or on either side of an alley. The designer must anticipate that these uses will compete with other potential uses for space allocation. In downtown and other high-activity commercial districts, or when significant, documented demand exists, a ride-hailing loading/unloading area should be provided every 1-2 blocks. Often, it is preferable to have designated ride-hailing loading/unloading areas on side streets.

Please refer to the Curbspace and Mode-Specific Travelway section of this chapter to see how loading fits into the overall context for curbside uses.

## Use

- » On-street freight loading zones may be located on any street type where local businesses have frequent freight loading needs and do not have a private parking lot, alley access, or loading dock on their property. Loading zones can serve multiple businesses along a street and do not belong to one specific business. Refer to DOTI policy statements regarding loading zones and truck parking.
- » General Loading Zones: Typically, 40' in length and are intended to serve all motor vehicles (trucks, passenger cars, limos, buses, etc.) for active loading. Overweight motor vehicles may be restricted in certain areas.
- » Passenger Loading Zones: Typically, 20' or more in length and are intended to serve as a location for quick passenger pickup and drop-off where the motor vehicle is always attended and does not typically occupy the space for more than a few minutes. Please refer to the Accessible Parking & Loading Zones section in this chapter for more information about accessibility.
- » Truck/Commercial Loading Zones: Typically, 40' in length and for use by trucks or other motor vehicles with a special license allowing for parking of a motor vehicle other than a truck in a truck loading zone.
- » Truck/Commercial Loading by Permit Zones: Typically, 40' in length and for use by motor vehicles with an annual permit from DOTI.

## Design

- » Clearly sign loading zones to prevent private motor vehicles from parking in loading zones. For passenger loading, signs indicating a maximum five-minute load time are recommended.
- » Establish loading zones near beginnings and ends of blocks, midblock near driveways or alleys, or where it is easy for trucks to pull in or out of the space.

## Considerations

- » When freight loading needs are infrequent, consider designating the space a general loading zone to allow for freight or goods loading, passenger pick-up/drop-off, etc. during non-peak hours, or sign for on-street parking during the off-peak loading times.
- » Consider the entire block's loading needs when placing a loading zone to allow for use by multiple businesses along a corridor or small area.

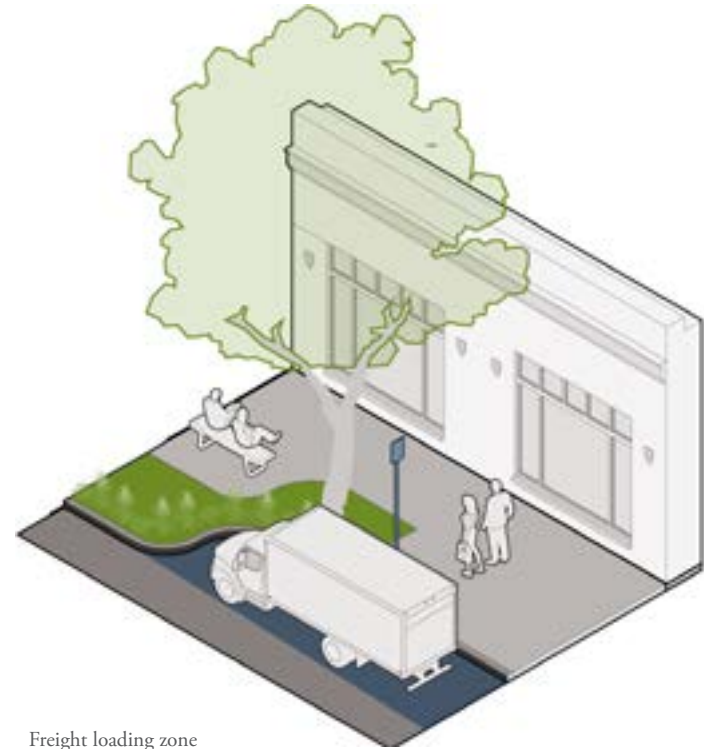

Freight loading zone

## Materials

The primary goals for public realm materials selection should be to maximize accessibility, sustainability, durability, drainage, and aesthetic appropriateness. Given that certain materials are better suited for specific zone districts, land uses, and street types, material selection should always be context-sensitive, complement the desired character of the streetscape, and—most importantly—withstand user patterns and environmental conditions associated with high-density urban locations. Proper subgrade design, preparation, and installation is critical to provide quality greenspace and prevent settling and deterioration over time.

### Use

- » Consult the latest City policy and Area Plans on material use.

### Design

- » Sidewalk zones must be concrete per DOTI standards. Aesthetic upgrades in the sidewalk zone using finishes and joints can be explored provided the design complies with Accessibility Guidelines.
- » Because the amenity zone isn't considered to be part of the sidewalk zone, treatments in the amenity zone can be more flexible including materials, finish, and color. Material selection should consider existing or expected high pedestrian traffic, as well as amenity zone vegetation and infrastructure.
- » When tree grates are required, explore various options to prioritize vegetation and street tree growth, longevity, and sustainability.

### Considerations

- » Colored concrete, different materials or treatments, and pattern changes between the zones can contribute to a more accessible and human-scale street. However this can present maintenance challenges when specific sections need to be replaced.
- » Typically, the City requires 1/4" maximum gaps in the sidewalk per PROWAG, which limits paving materials available to be utilized for walking surfaces. Sidewalk materials specified for areas outside the public right-of-way or in areas not subject to City or district maintenance is determined by the property owner and subject for review by the City.
- » Include permeable pavers and supporting drainage infrastructure in the amenity zone to support runoff reduction.

## Metered Parking

Parking meters and pay stations are devices people use to pay for on-street parking. They are installed in convenient curbside locations for user access while avoiding obstruction of the pedestrian path of travel. Parking meters and pay stations accept credit cards in addition to cash and/or coins and allow for prices to be dynamically changed based on demand, time of day, or day of the week. Parking meters typically allow payment of one to two directly adjacent parking spaces while parking pay stations typically allow payment for multiple parking spaces within a block.

### Use

- » Where on-street parking is provided proximate to commercial land uses fronting the street, parking demand is high and parking restrictions cannot manage the demand adequately. Refer to DOTI policy statement regarding parking meter installation.
- » Where on-street parking is provided proximate to occasional high-demand uses, such as sports or special event venues.

### Design

- » If used, individual meters should be located within 3' of the head or foot of the parking space to maintain potential lift operations where parallel on-street ADA parking exists.
- » Meters should be mounted with centerline of controls at no more than 42" high per ADA standards.
- » Meters should be placed 2-3 feet from the front of the curb or the back of the sidewalk to maintain ADA accessibility along sidewalks.
- » Parking pay stations should be placed within the middle of the parking spaces they serve to reduce the number of pay stations needed per block.
- » When parking pay stations are used, signs should be placed throughout the block, using existing sign posts when possible, to direct people to pay stations or to pay-by-mobile options.
- » For placement considerations related to protected bike lanes, please see the *Bikeway Design Manual*.

### Considerations

- » Pay-by-mobile payment adoption and demographics of the area should be considered when placing parking meters and pay stations.
- » Pay stations should be used to reduce visual clutter of the street.
- » Convert current parking meters or meters that have been removed into bike parking with meter post hitch attachments. Do not use this conversion at ADA accessible parking meters.
- » Care should be taken to maintain existing vegetation when placing meters in the amenity zone.

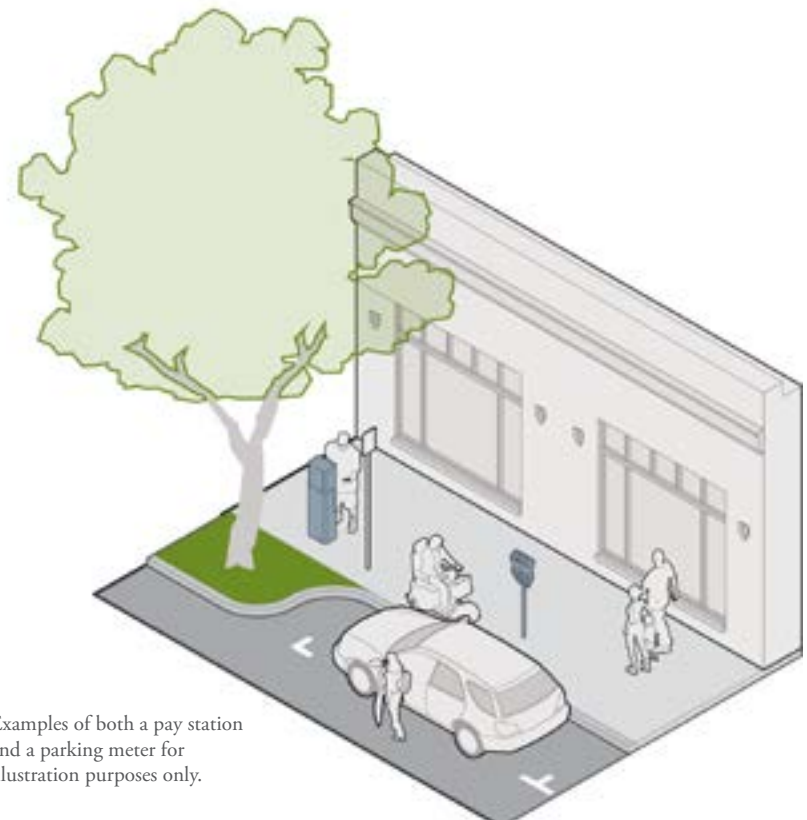

Examples of both a pay station and a parking meter for illustration purposes only.

## Mobility Hubs

A mobility hub is a combination of loading zones, car share spaces, bike parking, micromobility services, and is typically easily accessible from bike routes or bus/rail stops. Mobility hubs may provide designated parking areas or corrals for bike share and scooter share to reduce sidewalk clutter and make use of curbsides more efficient. They can also serve as transit hubs, rideshare dropoff and pickup zones, car share parking, house bicycle repair stations, and much more. As new mobility options continue to emerge, dockless mobility hubs provide the opportune places for experimentation and transfer between modes.

### Use

- » In locations with high density and variety of land uses, including Downtown, Main Streets, Mixed-Use, and Commercial Streets.
- » Near commercial or high-activity areas.
- » In amenity zones with large buffer areas.
- » Within curb extensions.
- » Within pedestrian plazas.
- » Near high-frequency transit stops.
- » Within on-street parking spaces or no parking zones where sidewalks are too narrow or pedestrian space is limited.

### Design

- » A 5' minimum clear pedestrian access route (8' clear for arterials and streetscapes 21' wide and greater) must be maintained behind any designated dock or designated bicycle or dockless mobility parking area.
- » A minimum distance of 2' should be provided from the hub to the face of the curb.
- » A depth of 6' for bikeshare docks and 5' for scooter zones should be provided.
- » In high-volume pedestrian areas, provide at least 2' clearance between hub and clear pedestrian path on sidewalks.

- » Provide 3' minimum clearance between the edge of a dock or designated parking area and any other vertical streetscape element.
- » Bikeshare docks typically feature semi-permanent structures that hold bicycles, while scooters may be parked in spaces designated by pavement markings and/or signage. Scooter stands may be installed to prevent scooters from tipping over.
- » Orient docks to facilitate easy access to dockless mobility vehicles.
- » Bikeshare pay and informational kiosks (if provided) should be accessed from the sidewalk.
- » Hubs may be located in parking lanes where there is not enough room in daylighting areas. Placing hubs in-street with high traffic volumes high should be avoided. Vertical barriers, such as flex posts, precast curbs, or planters should be used to restrict motor vehicle encroachment on on-street docks and corrals.

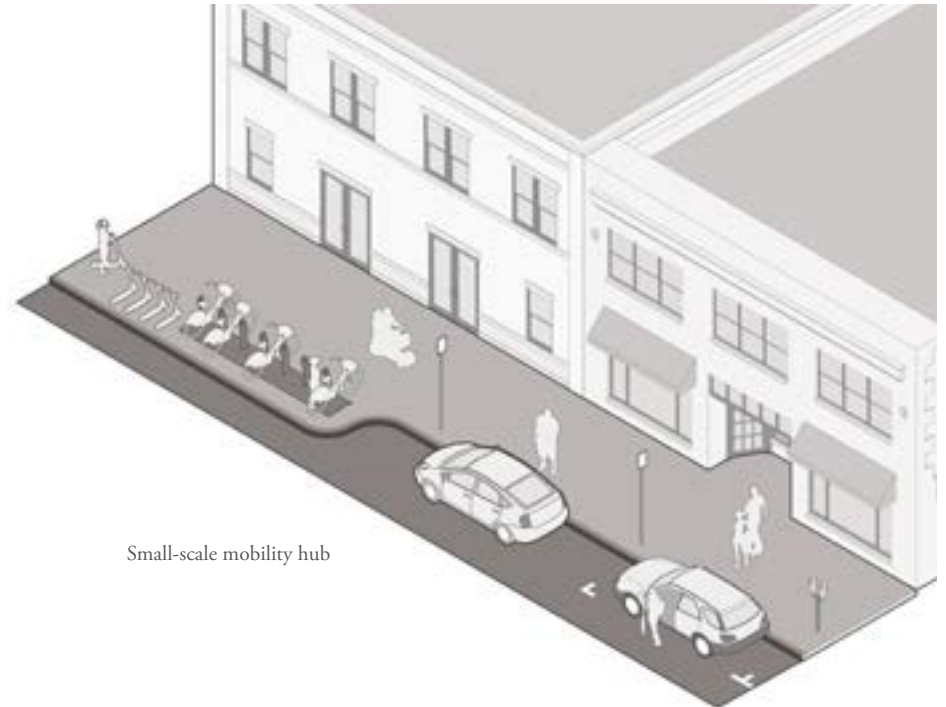

Small-scale mobility hub

- » Hubs should be clearly delineated with striping, paint, and signage.
- » Adequate sun exposure should be ensured if docks are solar powered.
- » Co-locate multiple dockless mobility options in the same location to maximize transportation choices and efficiency and minimize clutter.
- » Locate in well-lit areas with clear sight lines from sidewalks and pedestrian areas.
- » Locate hubs in curb extensions and near bus stops to preserve maximum pedestrian access aisles.
- » Include power supply, wayfinding, transit information, seating, and other design elements in hub design

### Considerations

- » Consider use of on-street hubs as protective buffers between travel lanes and bike lanes in the shadow of on-street parking.
- » Site hubs next to a curb extension to improve intersection sight distance benefits.
- » Consider working with dockless mobility vehicle operators/providers to develop a “one stop shop” for transportation services. This could take the form of an app, geo-fence, or kiosks in the right-of-way where users can see a variety of mobility options.
- » Care should be taken to maintain existing vegetation near mobility hubs.

## On-Street Parking

On-street parking provides short-term and convenient access to businesses and residences. Parking demand is especially high in Downtown and on Main Streets and Mixed Use streets, as well as in residential neighborhoods.

### Use

- » On-street parking may be provided on any street type where there is sufficient demand, street width, and where modal priorities have been met. Refer to DOTI policy statements concerning residential disability parking and short term parking.
- » Where street reconfiguration is being considered to add bike or transit facilities, on-street parking can be removed depending upon the demand and availability of on- and off-street parking options in the vicinity, or where there are convenient and reliable transportation options.

### Design

- » Typical motor vehicles are 6' - 6.5' in width. Minimum parking lane widths should be 7' in constrained areas, with 8' preferred.
- » Parking can act as a buffer for protected bike lanes. When using parking as a protected bike lane buffer, ensure a minimum of 3' of buffer space to allow for car doors to open without intruding into the bicycle riding space.
- » No Parking signs, for intersection daylighting, should be placed in accordance with DOTI policy statements.
- » Reverse-angle parking should be considered where possible. Reverse-angle parking can narrow excessively wide travel lanes and slow vehicles, can be easier to use for drivers, and can be safer in locations with high bicycle and pedestrian traffic.

### Considerations

- » In areas with high parking demand, parking time limit restrictions and/or pricing will generate more frequent turnover and should be considered.
- » Ensure that accessible parking and loading options are provided and per City policies.

## Parklets

Parklets are areas located in on-street parking lanes that extend the pedestrian realm. These amenities provide a vibrant community space for social interaction. Parklets are often designed with local businesses and residents who manage and maintain the space and are private encroachments that must be approved by the City accordingly. Parklets often become a focal point of a neighborhood and should be welcoming and accessible to all. The size and design of parklets is typically constrained by on-street parking width and necessary clearances. Parklets typically occupy one to two standard on-street parking spaces and should be easily assembled and disassembled to provide flexibility and removal during snow months.

### Use

- » Typically, on streets where motor vehicle speed limits are 25 mph or less.
- » On streets with a running slope of 5% or less.
- » On streets with moderate to high levels of current or projected people walking and rolling, land uses that encourage walking and rolling such as restaurants and cafes, and existing on-street parking.
- » Where sidewalks are too narrow for cafe seating and on-street parking exists.

### Design

- » Each end of the parklet should be buffered with parking stops, fencing, bollards, or other vertical elements. A vertical element should be placed at a minimum distance of 3' in advance of a parklet. The width of a parklet should be approximately 1' less than the striped parking lane. Parklets should have a tapered buffer to account for maintenance activities.
- » The parklet should not extend more than 7' from the curb, regardless of the width of the parking lane.
- » The deck of the parklet should be flush with the adjacent curb to maintain accessibility from the sidewalk.
- » The deck of the platform should be constructed to meet ADA surface standards.

- » A consistent vertical edge should be provided along all sides of the parklet except the side open to the sidewalk. The height of the edge parallel to the street should be a minimum of 36" tall and a maximum of 42" tall. The height of the edges perpendicular to the street should be a minimum of 14" tall.
- » Parklets should not block existing hydrants, manhole covers, drainage channels, storm sewer drains, or any utilities. Designers should coordinate with Office of the City Forester regarding design, acceptable distance from street trees, and length of time for installation. When designing parklets, verify street tree clearance above installation area is adequate.
- » To maintain sight lines to crosswalks, parklets should not be located close to corners at intersections and should adhere to sight distance requirements.
- » Components of the parklet including the deck, vertical elements, seating, tables and planters should be low-maintenance and vandal-resistant.
- » Prior to approval of installation, coordination with adjacent businesses and landowners should be completed to gauge support for parklets, develop maintenance partnerships, and ensure activation of the space.

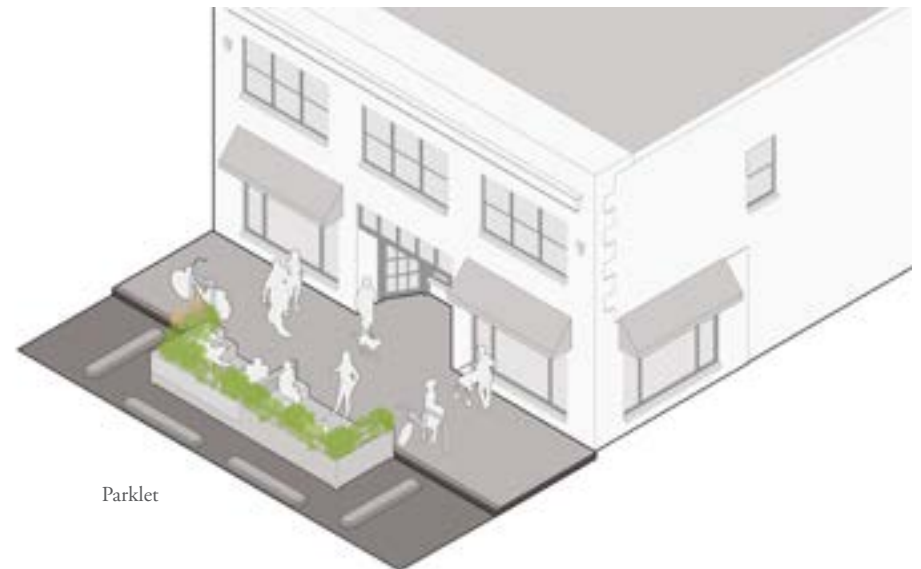

## Considerations

- » Sites with high levels of activity during the day and night time are desirable.
- » Provide bicycle parking or dockless mobility hubs at, near, or within the parklet.
- » Disassemble and remove parklet during winter months if snow removal is prohibitive or materials will deteriorate.
- » Consider temporary or pop-up installations to test the potential of the parklet and gauge community and other stakeholders.
- » Use parklets as a temporary means to evaluate permanent curb extensions or sidewalk expansions.
- » Parklets proposed and/or owned and maintained by an adjacent property owner will need to be approved through the City's encroachment permit process.

## Pedestrian and Street Lighting

### Use

- » Street lighting provides illumination and ensures safety on the street.
- » Pedestrian lighting is used to define the street and make people feel comfortable. It is used in parkways, commercial, mixed-use, and high-density residential neighborhoods.

### Design

- » The City and County of Denver's *Street Lighting Design Guidelines and Details* is the primary document for lighting design. Please consult the document for information about the design of lights, including their spacing.
- » Spacing of street lights should be based on providing required light levels on the ground.
- » Regular spacing of pedestrian light poles creates a pattern of light to delineate a district or destinations within a district. Coordinate pedestrian light locations with street lights, street trees, and utilities.
- » Pedestrian light poles often serve dual purposes and can have brackets for decorative banners, signage, and seasonal lighting displays.



## Considerations

- » Light trespass is an important consideration in the selection of lighting components, especially in mixed-use and high-density residential zone districts.
- » Consider Dark Sky approved light fixtures, which are constructed to reduce light pollution, the amount of energy being used, and the impact unnatural light has on the environment.
- » Street lighting ownership, operation, and maintenance is the responsibility of the City of Denver.
- » Pedestrian lighting ownership, operation, and maintenance is the responsibility of special districts or private property owners, not the City.
- » Space must be provided for the requisite transformer, meter, and control box.

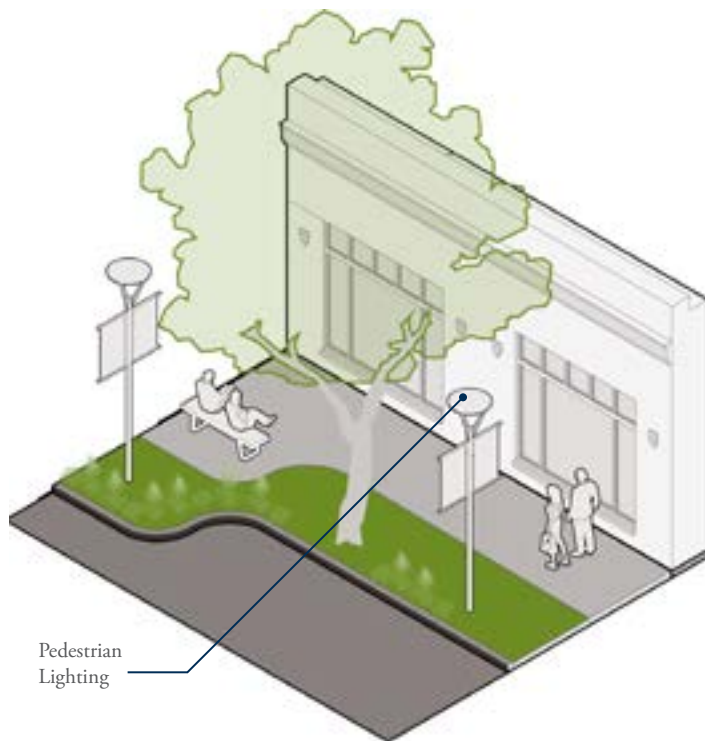

Pedestrian  
Lighting

## Street Furniture

### Use

- » **Benches:** Seating is a critical component to each street and includes temporary and permanent fixtures such as chairs, benches, seat walls, steps, and raised planters. The location and type of seating element should respond to adjacent land uses, available shade from either structures or street trees, the presence of parallel parking buffering the seating area from vehicular traffic, and the width of the amenity zone.
- » **Trash and Recycling Receptacles:** Trash and recycling receptacles are important for active, busy streetscapes and are necessary to minimize litter. Receptacles should be located in mixed-use and commercial districts, bicycle and dockless mobility stations, and all transit stops.
- » **Other:** Street furniture such as bollards, transit stops and shelters, and decorative planters are important for many types of streets. Site-specific conditions and project goals will dictate where these elements are most appropriate. Some situations are referenced elsewhere in this chapter.

### Design

- » Permanently installed furnishings must not impede pedestrian access to adjacent structures or create conflicts with the opening of car doors and access to fire hydrants. Placement should consider the location of existing infrastructure, vegetation, and planting areas.
- » Seating ideally should accommodate two or more persons.
- » ADA establishes clearance requirements for the location of benches and bus stops.
- » Durable, vandal resistant materials and designs should be selected to withstand both climate and urban environments. Internal bins should be readily accessible by maintenance crews. Materials should withstand sun damage and deter pests.
- » Recycling receptacles should be clearly marked and a different color than trash receptacles.
- » Receptacle capacity and design should conform to the standards most convenient for maintenance.
- » Street Furniture is considered an encroachment and requires permits to be installed.

## Considerations

- » Seating options include benches with and without armrests. Armrests provide stability for those who require assistance sitting and standing. Armless seating allows for access of disabled persons to street seating.
- » Seating areas longer than 4' often require central armrests or skate stops to deter uses other than seating.
- » Movable seating requires monitoring by either a district or property owner for safety, security, and replacement. Portable encroachments must be placed in accordance with encroachment rules and regulations and permit conditions.
- » There are many different styles and designs of trash and recycling receptacles, and the location and maintenance requirements must be considered when selecting a style and bin combinations. Recycling programs are desirable for many reasons, but recycling requires a commitment both by the neighborhood, district, and maintenance vendors to ensure that the recycling bins are not a catch-all for other types of trash.
- » Frequency of trash and recycling receptacles should be based on adjacent land uses, types of retail and commercial businesses, and localized pedestrian movement patterns. Some districts and streets may need more receptacles than others, and the number of receptacles may need to be increased based on future development and redevelopment trends.
- » Streetscape furniture and street lighting should be coordinated across neighborhoods and districts to maintain distinct urban design features of the area.

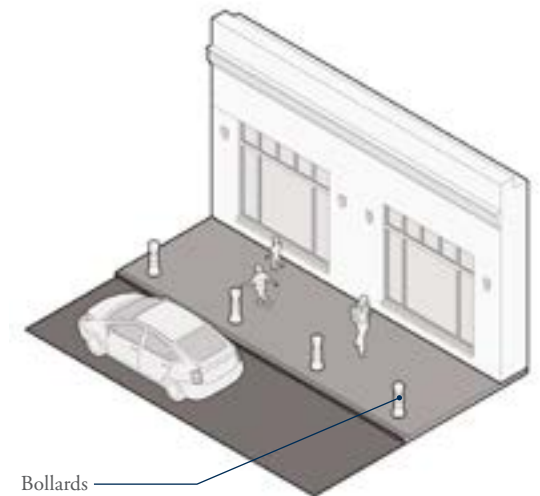
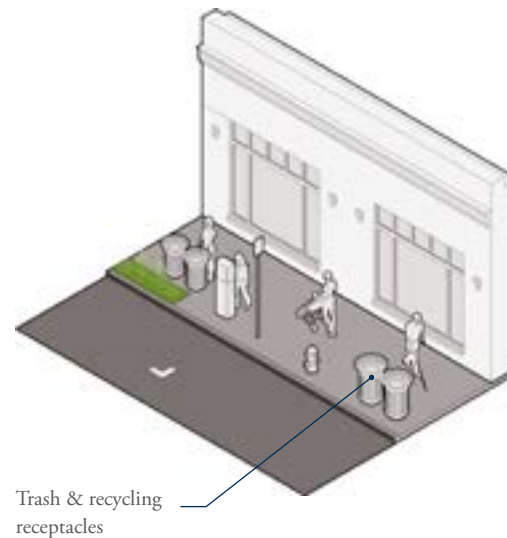
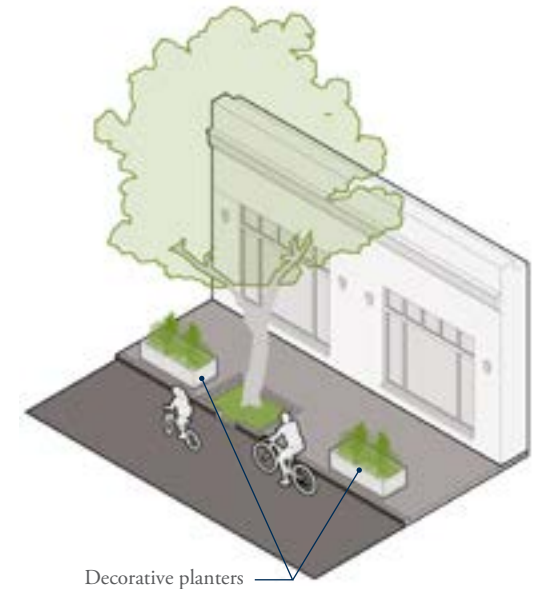
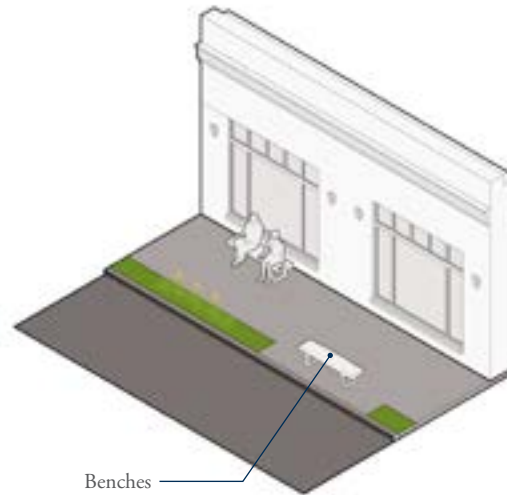

## Street Trees and Supporting Infrastructure

Trees provide a wide range of environmental, social, and economic benefits to the City's residents, visitors and the community. Street trees are a valuable resource that contribute to the character and ambiance of the public realm, and provide much-needed shade in our arid, high altitude climate. Trees remove pollution from the atmosphere and water, improving air quality and human health, and mitigate the effects of climate change.

The urban forest is a critical component of making streets function not only as transportation conduits, but as places that support the health and safety of the community, which is addressed in detail in Denver Parks & Recreation's *Game Plan for a Healthy City*. Urban Forest Expansion, Right-of-Way-Trees and Tree-Lined Streets are included in the top 25 priority strategies contained in the *Game Plan*. While these strategies focus on public health, street trees are critical to establishing scale and transforming streets into memorable corridors and parkways.

Understanding mature tree size above and below ground, maintenance regimes, and budgets is critical infrastructure for long term sustainability and resiliency of trees in the streetscape. If planted within an established District, such as a Business Improvement District or a Local Maintenance District, new plantings should be responsive to the original design intent of the streetscape while also ensuring species diversity. Installation of new plantings that yield new or unique maintenance tasks will require review and coordination with the District.

### Use

- » In contrast to smaller trees, large trees provide greater economic, ecological, and social benefits, making it especially important to provide critical infrastructure and space to support long-term and healthy tree growth.
- » Supplemental plantings can be used to physically and visually buffer pedestrians from on-street parking and drive lanes, beautify an area, and direct pedestrian traffic around established planting areas. Plantings can include deciduous and evergreen shrubs, perennials, and annuals.



Street tree box filters with planters



Supplemental plantings in amenity zone

## Design

- » Tree roots are three dimensional, and it is far more important to provide a specific volume of soil than any given dimension. Street trees will thrive when provided 1000 cubic feet of uncompacted soil volume, and require a minimum of 600 cubic feet and at least 3' of rooting depth to simply survive. This volume can be accommodated with uncompacted lawn, planters with varying lengths and widths, or other subsurface technologies to support pavement while permitting subsurface air and water movement in the soil. Additional rooting area supports long-term tree growth. Maximize soil volume and consult with the Office of the City Forester (OCF) when minimum soil volume standards cannot be achieved.
- » Tree soil volume research has shown that where soil volume is constrained in a hardscape area, structural cells provide necessary soil volume to allow greater root and canopy growth compared to minimal open surface areas or structural soils.
- » Reference the OCF Tree Planting Requirements for more detailed information. Large shade trees are ideal for delineating outdoor spaces; select appropriate species that support a diverse urban forest. The OCF Approved Street Tree List for Denver's Public Rights-of-Way is available on the Forestry web page on denvergov.org. Select trees that withstand the impacts from the urban environment and pets.
- » Coordinate tree locations with emergency vehicle, sight triangle, transit stop (see RTD Design Guidelines), and utility equipment requirements. Trees should be planted at least 30' from the perpendicular curb face at intersections. Refer to Denver's Approved Street Tree List for more information about required distances from streetscape elements.
- » The use of tree grates surrounding tree trunks is discouraged unless there is no other option. Tree grates are not considered to be part of the ADA pedestrian access route.
- » Design supplemental planting areas to withstand the impacts from the urban environment and pets. Supplemental plantings should be a maximum of 30" in height at maturity for safety and visibility.
- » Street trees in medians have been shown to have a traffic calming effect. The designer should ensure that street trees and plantings in medians meet City requirements for proper infrastructure, sight triangles, viewsheds, and other requirements.

## Considerations

- » Larger rooting volumes that satisfy Green Building Ordinance criteria increase available project credits.
- » Typical street sections accommodate street tree planting, but existing conditions along older, established neighborhood streets include less than five feet width between curb and sidewalk. Potential accommodations for tree planting in this substandard condition include:
  - » Combine sub-standard cross-section dimensions with increased planting bed lengths to achieve a minimum volume.
  - » Utilize innovative treatments like structural cells or other infrastructure technologies with standard reinforced paving details that allow for rooting below adjacent pavement.
  - » Shift the sidewalk alignment towards the property line to maximize tree planting area.
  - » As site utilities and grades allow, shift the flow line to create a 'bump-out' in the parking lane for street tree planting.
  - » As site utilities and grades allow, plant directly in the parking lane, in front of the flow line at street grade, with bollards and/or bike parking.
- » When planting trees in bioretention areas, soil should balance stormwater infiltration and long term plant growth. Water quality treatment areas with bioretention growing media may be directly adjacent to trees planted in living soil, or the two types of facilities may be separated and alternated along the streetscape.
- » Provide pet waste facilities on private property to reduce impacts of pet waste on street trees and supplemental plantings.
- » Limit salt use on adjacent walks when snow will be piled in planting areas or snowmelt drainage is directed into planting areas. Consider snow storage when deciding on appropriate plantings.
- » Water all street trees and supplemental plantings with an underground irrigation system with a central controller and rain sensor.

## Transit Stops and Shelters

Bus shelters provide weather protection and a designated waiting area for bus passengers. Shelters are typically provided at frequently used bus stops and locations used by vulnerable passengers such as at schools and senior centers, but are appropriate and encouraged at all bus stops regardless of use. Benches, trash and recycling receptacles, and bike parking are other amenities that are often co-located with bus stops and provide additional comfort and functionality to the public transit system. Consult Appendix D of *Denver Moves: Transit* and RTD Bus Infrastructure Standard Drawings for further guidance on transit stop and shelter design.

### Use

- » At any bus stop locations, but especially those with at least 40 passenger boardings per day. Refer to Accessibility Standards for transit stops.
- » Near schools, community and senior centers, and hospitals

### Design

- » Boarding and alighting areas should be at least 8' deep (perpendicular to the curb) and 6' wide.
- » Clear and level landings should be provided to both the front and rear doors of the bus. Bus doors are generally spaced 20' apart on standard 40' buses. On 60' articulated buses the doors are 40' apart. Streets with regular service from articulated buses should ensure stops are long enough.
- » A clear pedestrian access aisle of at least 5' wide must be preserved behind the bus shelter and the back of the sidewalk or nearest building facade.
- » An appropriate shelter size should be selected based on site constraints and ridership demand. Typical shelters are 5' deep and vary in length.
- » At least 15' should be provided between the edge of the shelter and crosswalks to maintain adequate visibility.
- » Conflicts with trees and other amenities should be minimized by providing at least 6' between the edge of the shelter and other vertical streetscape elements.
- » For accessible bus boarding, the vertical step between the sidewalk or platform and vehicle ramp must be less than 5/8", with a maximum horizontal gap of 3".

- » Provide bench seating while maintaining a minimum 30" wide by 40" long accessible space under shelter.
- » Include transparent wall panels in all shelters to promote feelings of personal safety and security.
- » Consult the RTD Mobility Hub Guidelines, RTD Bus Infrastructure Guidelines and Criteria and Standard Drawings, and RTD Transit Access Guidelines for more information about safe and accessible transit facilities.

### Considerations

- » Where floating bus stops are used, place shelters on the floating island.
- » Consider incorporating art, advertising, or informational wayfinding signage within bus shelters.
- » Install solar lighting where solar exposure is adequate.
- » Provide real-time information displays to keep users informed about the arrival of their bus and other information, including delays on connecting lines, weather, and news.
- » Provide heated solar-powered lamps for use in cold weather during transit operating hours.
- » Develop a process for the design, funding, and implementation mechanisms for installation and maintenance of shelters.
- » Ensure Fire Department access to Fire Department Controls is not blocked or impeded by any obstacle.

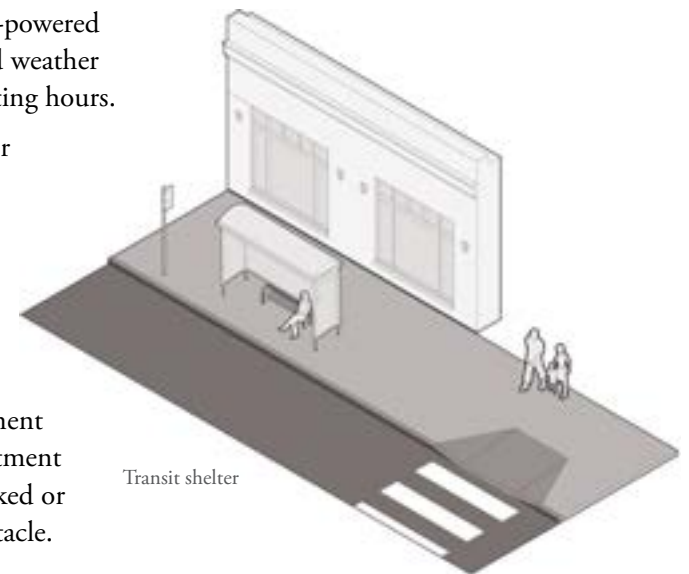

# Safe and Accessible Features

## Access Control and Diverters

On streets with traffic volumes that exceed those recommended based on classification and function, diverters may be used to shift traffic away from a roadway (particularly bikeways and shared streets) by using curb extensions or medians to limit motor vehicle access and encourage walking, rolling, and bicycling instead of driving. Half closures restrict access from one direction onto a street. Diverters force drivers to make turns, preventing them from traveling straight down a route. Access control features can be designed to allow emergency access while restricting other motor vehicles.

### Use

- » Local streets with volumes above 5,000 vehicles per day and shared streets with volumes above 400 vehicles per day.
- » On Neighborhood Bikeways where average motor vehicle daily traffic volumes exceed 2,000 or where peak hour volumes exceed 300.

### Design

- » The two main forms of diverters are median diverters and diagonal diverters. Denver's *Bikeway Design Manual* contains details on designing each of these.
- » Provide accessible routes for people walking and rolling through access control features using flush surfaces and curb ramps at crossings.
- » Where required, ensure emergency vehicle access is provided by considering the wheelbase of fire and other emergency vehicles when designing diverter islands. Consider using mountable 6" curbs and providing a width of 10' that is clear of landscaping and rigid vertical elements within the diverter to aid emergency vehicle passage.
- » Cut-throughs should be a minimum of 6' in width and length (with a length of 10' preferred) to provide access for people riding bicycles and using dockless mobility options while preventing motor vehicle through-traffic.
- » Use mountable curbs to keep motor vehicle routes narrow while allowing larger motor vehicles like delivery and garbage trucks to encroach on barriers in turns.
- » Provide bike and pedestrian crossing warning signage (W11-2 or W11-15) where bicyclists and pedestrian crossings may be unexpected.

### Considerations

- » Consider potential traffic impacts to adjacent neighborhood streets before implementing diverters and verify whether nearby neighborhood streets are adequately traffic calmed as appropriate. Diverters should not push excessive motor vehicle traffic from one neighborhood street to an adjacent neighborhood street, but rather deflect traffic to larger collectors and arterials.
- » Depending on context and circumstances, diverters may be appropriate on other high comfort bikeways (besides Neighborhood Bikeways) to achieve desired traffic volumes.



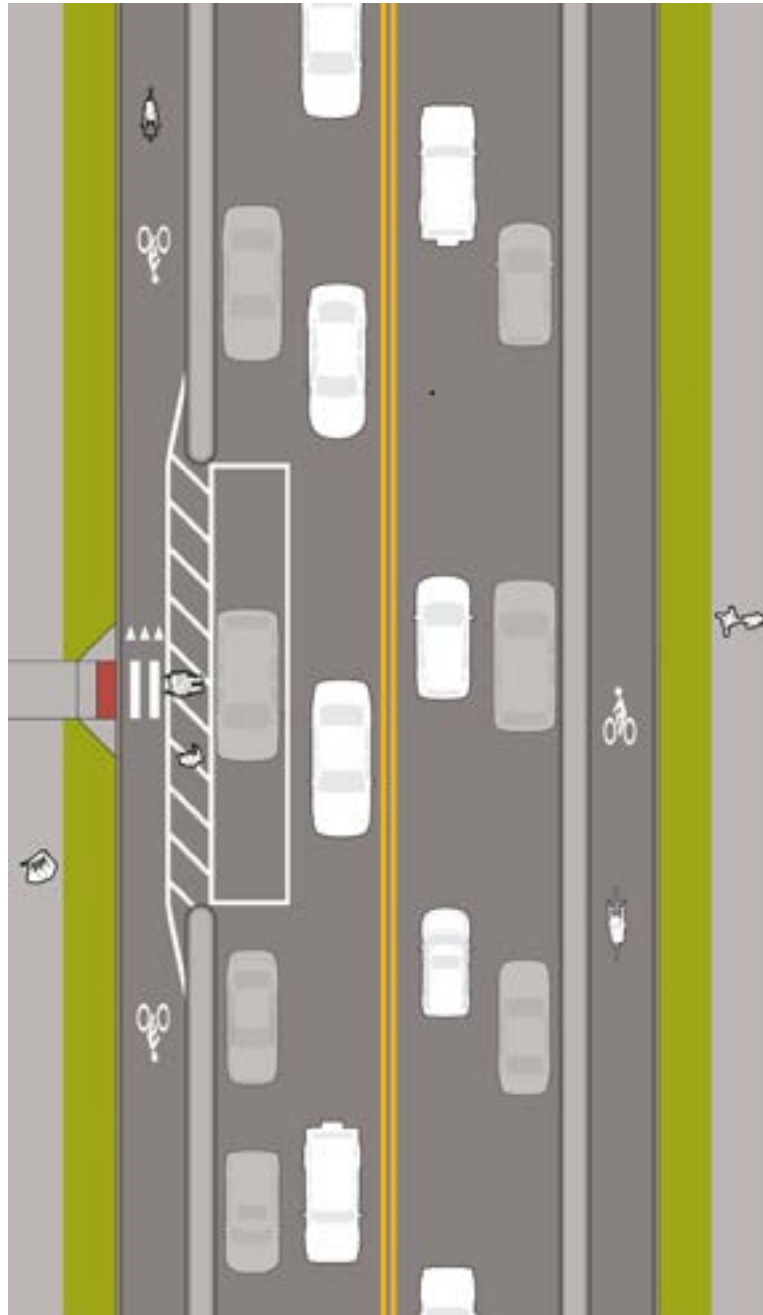

Accessible parking zone next to a protected bike lane.

## Accessible Parking & Loading Zones

Designated accessible parking and loading spaces provide additional space adjacent to signed parking for vans with ramps to allow passenger boarding and alighting and ensure an accessible route from the landing area to the sidewalk. While some unmarked on-street parking located adjacent to the sidewalk may meet the guidelines identified in PROWAG, parking that is located away from the sidewalk does not provide a clear and accessible path to the sidewalk. When designating accessible parking and loading that is not adjacent to the sidewalk, the designer is still required to provide boarding and alighting space and an accessible route to the sidewalk. The guidance that follows is from PROWAG.

### Use

- » One accessible parking space should be provided for every 25 spaces on a block perimeter, for block perimeters with 100 spaces or fewer.
- » For each additional 50 parking spaces up to 200 per block perimeter, one additional space should be accessible. Where more than 200 parking spaces are provided per block perimeter, 4% should be accessible.

- » Where dedicated passenger pick-up/drop-off zones are provided, at least one parking space for every 100' of the block face dedicated to passenger loading should be accessible.

### Design

- » Provide a 5' access aisle adjacent to accessible spaces.
- » Consult the *Bikeway Design Manual* for detailed information on designing accessible parking and loading zones along protected bicycle facilities.

### Considerations

- » Accessible spaces at the far side or near side of intersections can use existing curb ramps to maintain an accessible route.
- » Midblock spaces should be reserved for locations where intersection locations are not feasible or to facilitate access to a specific destination. A curb ramp to access the sidewalk from the accessible parking space will be required.



## Alleys

Alleys may be either public or private. Although their primary purpose is for access and service, an alley may also function as a low volume multimodal connector through a block and be attractively designed as a Shared Street.

Denver is home to numerous alleys, ranging in size and use. In Denver, alleys can provide access for motor vehicle parking and garbage collection, serve as utility corridors, and serve as energized public spaces with shops, restaurants, and public art. Denver's first fully activated, privately-owned and maintained alleyway is part of the Dairy Block in Lower Downtown and features art installations, public seating for nearby restaurants, planters, and pedestrian-scale lighting.

### Use

- » Alley design is largely dependent on adjacent land uses and needs of adjacent properties. Alleys can serve as utility corridors for overhead electric and communications infrastructure, as well as house sanitary stormwater and sewer infrastructure.
- » Alleys typically serve as access points for residents' garages, as well as garbage, recycling and compost collection, or temporary loading activities.
- » In locations with more commercial activity, such as Downtown and near Mixed-Use and Main Streets, and in compliance with ADA and other accessibility regulations, alleys can serve a place-making function, housing seating and art.
- » When the alley serves mostly vehicular and garbage collection access, parking and trash receptacle storage must not be permitted within the right-of-way portion of the alley to allow for circulation.

### Design

- » Alley widths can vary from a standard 16' to 20' when used for commercial access.
- » Proper drainage should be included in all new and retrofit alley designs. Alleys provide a good opportunity for stormwater best practices where feasible, including pervious pavement.

- » Alleys are excellent opportunities to incorporate green infrastructure. See green alleys in the *Ultra-Urban Green Infrastructure (UUGI) Guidelines* for more information.
- » The design of alleys should consider the consolidation of trash, compost, and recycling services.

### Considerations

- » Alley maintenance and snow clearance is a lower priority for the city. Abutting property owners should be encouraged and enabled to take over maintenance responsibilities if possible.
- » Private alleys must be privately maintained.

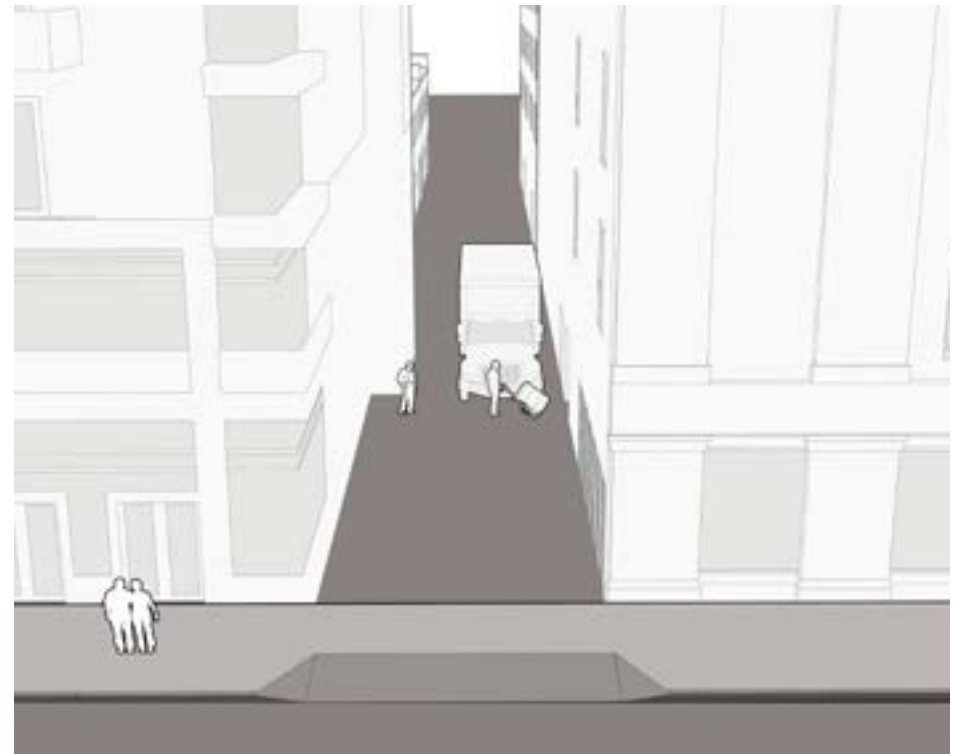

Alley

## Bicycle Highways

The City and County of Denver is planning to substantially enhance bicycle mobility along river corridors as they redevelop. As land uses change, there is a unique opportunity to both protect and enhance the natural function of these waterways for flood control and to add major regional trail networks.

Bicycle Highways will allow people in Denver to bicycle on safe routes removed from cars, trucks, and buses. These special bikeways—likely more than 20-feet wide—are an innovative concept for Denver. Much like motorists rely upon higher speed roadways to connect distant activity centers, Bicycle Highways will enable people biking to travel along a protected and separated environment from a roadway without comprising each other's safety or efficiency.

### Use

- » Bicycle Highway are envisioned to be a component of larger regional trail and mobility networks.
- » Bicycle Highways can be used to create high-comfort, grade-separated movement for bicyclists.
- » Additional landscape, ecological, and flood control enhancements along river corridors and waterways can be incorporated into Bicycle Highway systems.

### Design

- » Bicycle Highways should provide adequate width to accommodate high volumes and various user types/speeds along the facility.
- » These corridors shall incorporate necessary safety amenities like separation between directions of travel and proper lighting to ensure year round travel, much like a vehicular highway.

### Considerations

- » Though instances will be very limited, careful consideration must be given to interactions of Bicycle Highways with pedestrian and transit facilities. Elements such as rumble strips, bollards, crosswalk painting, signage, etc. should be provided to ensure safety of all bicyclists and other users.
- » Enhanced design elements should be considered at entry points, crossings, and junctions with other trails or Bicycle Highways to support safety and wayfinding.

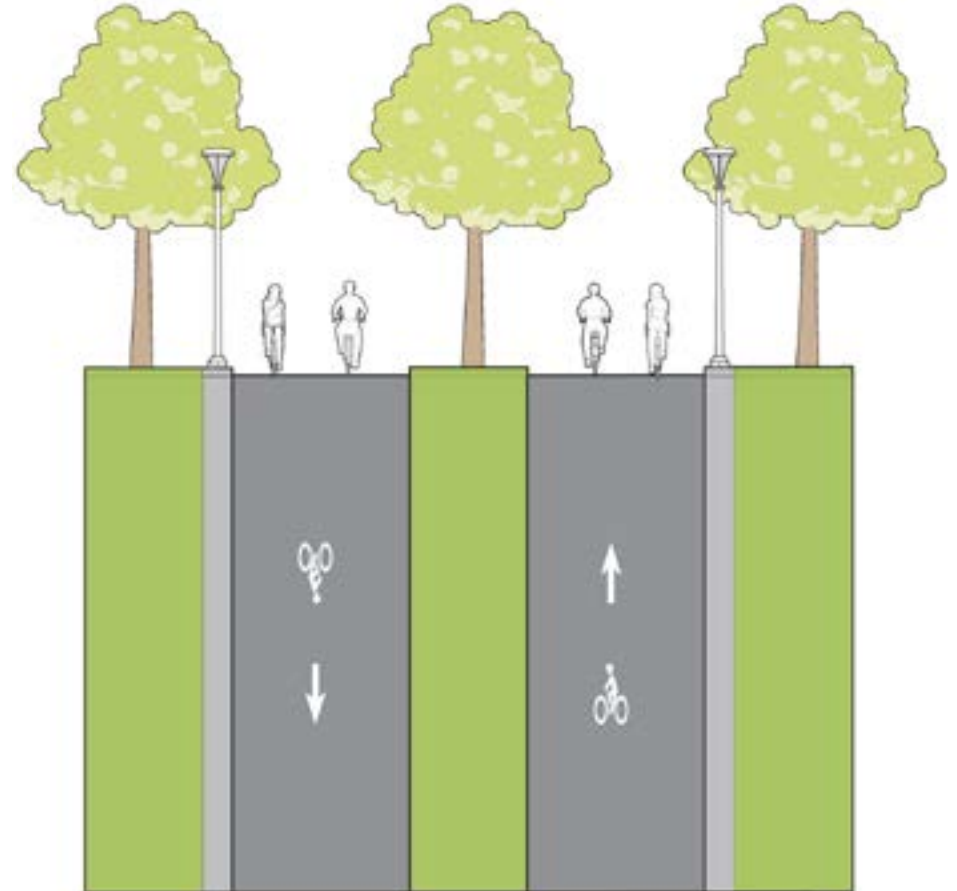

Conceptual Bicycle Highway

## Bikeways at Intersections

Intersection design is a key component to building bikeways that serve riders of all ages and abilities. The approaches to intersections should maintain continuity of bicycle facilities to the maximum extent possible. **Bikeway design, and intersection design, should follow three key principles: speed minimization, visibility of all users, and separation of vulnerable roadway users.** For more detailed design guidance on bikeway design, including bikeways at intersections and information on bicycle signals and detection, see the *Denver Bikeway Design Manual*.

### Use

- » Bikeway intersection treatments vary depending on facility type, volumes of motor vehicles and bicyclists, and frequency of turning movements.
- » Bikeways can be implemented on any street design type. When designing for a roadway that does not have a bike facility, bikeway intersection treatments can be applied where bikeways and trails cross the roadway.

### Design

- » The choice of the intersection treatment for bike lanes is a function of the intersection control, the presence of parking, bikeway configuration (one-way or two-way), and the presence of a dedicated turn lane. In all cases, the preferred intersection treatment is to continue the bike lane up to the intersection, minimizing exposure to motor vehicles. This also provides dedicated space for bicycle signal detection, which decreases bicyclist delay and improves safety.
- » Where high volumes of motor vehicles turning across the bike facility exist, bicycle signals and associated bicycle signal detection and separate phases are recommended to limit conflict.
- » Where space is available, protected intersection elements should be installed to minimize conflicts.
- » Where there are high volumes of turning movements by bicyclists, bicycle boxes or two-stage turn boxes can be installed. The designer should ensure that sight distance for all modes of travel is maintained.

### Considerations

- » Careful consideration should be taken when designing intersections where bikeways are along roads with high motor vehicle turning volumes.
- » Bicycle lane markings, including green-colored pavement markings, shared lane markings, dashed bicycle lane lines, and signage may be provided through intersections per engineering judgment.
- » Selective removal of parking spaces may be needed to provide adequate visibility and to establish sufficient bicycle lane width at approaches to intersections.
- » Install active or passive detection to facilitate bicycle movements at signalized intersections or crossings with Pedestrian Hybrid Beacons or Rectangular Rapid Flashing Beacons.
- » Traffic signals along a corridor may be timed and coordinated to facilitate continuous, uninterrupted flow for bicyclists while managing motor vehicle speeds. This signal timing method is often referred to as “green wave” timing.

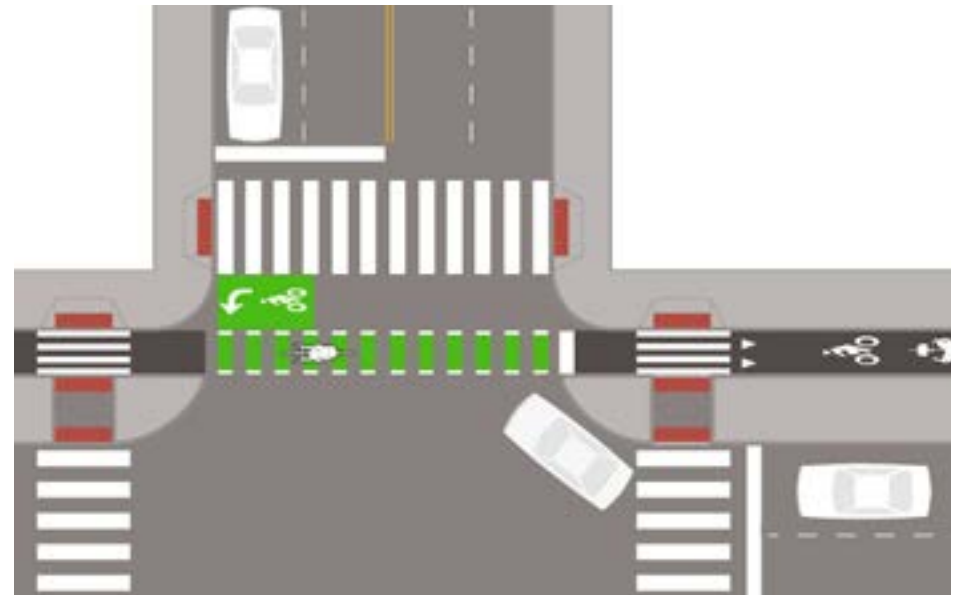

Bikeway intersection treatment with a buffer between turning vehicles and where bicyclists cross

## Bus and Bicycle Interactions

The design treatments used for bus/bike conflict mitigation will depend on context, and may include floating bus stops, raised bike lane bus stops, shared bus/bike lane stops, and curbside bus stops. Conflicts between curbside transit operations and people riding bicycles or using dockless mobility options should be mitigated through design treatments that clearly define space and alert users to any locations where bus and bike/dockless mobility uses will be mixed within the street. Consult the *Bikeway Design Manual* for detailed information on how to apply such treatments.

### Use

- » These designs should apply on any street where transit service and bikeways coexist.
- » Where bus stops intersect two-way protected bike lanes and shared use paths, floating bus stops are required to facilitate the contraflow bike/dockless mobility movement.
- » Where bus stops intersect any type of protected bike/dockless mobility facility, floating bus stops are the preferred design treatment, especially where bus frequency and bicycle volumes are high. Floating bus stops may also be used on streets with conventional striped bike lanes to better manage bus/bike conflicts and speed up transit operations.

- » Where bike lanes and bus stops operate in a shared condition, conventional bus stop conflict markings should be used to identify conflict points and heighten awareness for both bus operators and people biking or using dockless mobility modes. Conventional bus stop markings may also be appropriate where one-way protected bike lanes are provided in highly constrained rights-of-way or on corridors with infrequent bus service.
- » Where parallel on-street parking is provided and no bike lanes are provided, bus bulbs may be used to improve transit operations and provide additional amenity space for passengers waiting at bus stops.

### Design

- » Provide adequate space for curbside bus stops to ensure buses can pull in fully parallel to the curb.
- » In constrained environments where a floating bus stop is desired, reduce the width of the protected bike lane before reducing space for the sidewalk. Consult the *Bikeway Design Manual* for detailed guidance on reducing bike lane space at transit stops.
- » Provide a marked, level crossing with curb ramps or raise the bike lane to sidewalk level where pedestrians must cross to access the floating bus stop. Tactile strips should be used to communicate to blind or low-vision people where the bus stop crossing is located.

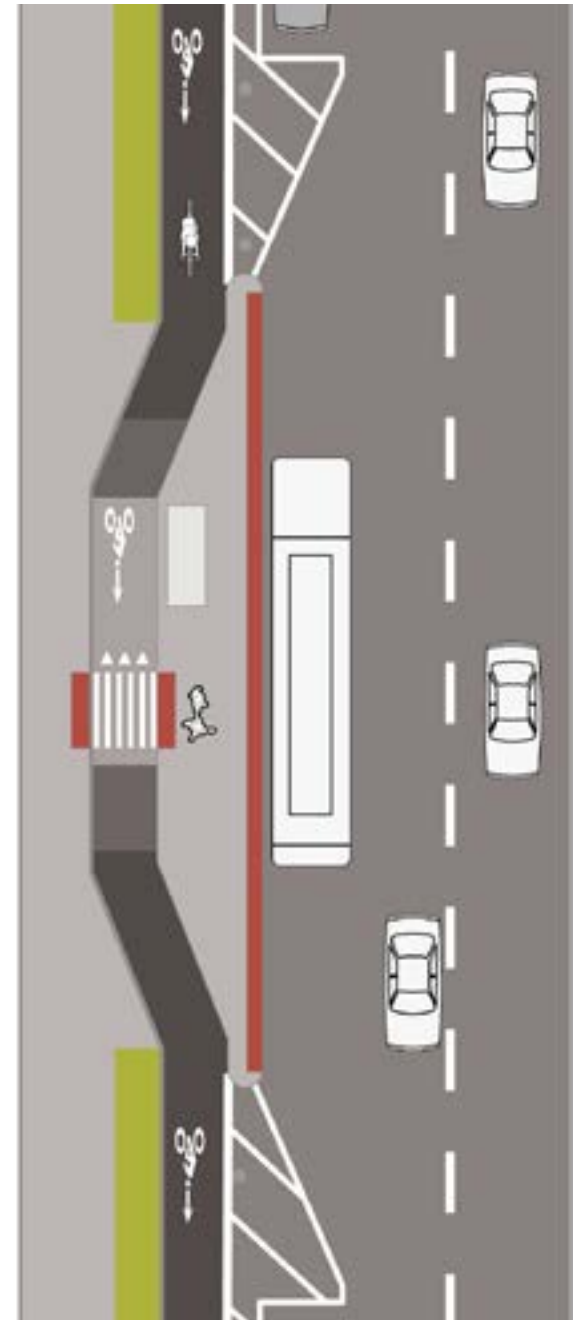

Floating bus stop (See *Bikeway Design Manual* for details)

- » Use a gradual taper to route the bike lane behind a floating bus stops, where needed. The maximum allowable taper ratio is 1:5, with a preferred ratio of 1:10.
- » Ensure shy distances of 1.5' for intermittent vertical elements (bus shelters and signs) and 2' for continuous vertical elements (railings) are maintained between vertical elements and adjacent bike lanes.
- » Provide smooth vertical transitions with a minimum slope of 1:12 and a maximum slope of 1:24 where bike/multimodal lanes rise to meet the sidewalk at grade at a bus platform.
- » Ensure bus bulbs are at least as long as one bus as measured from the front of the bus to the back of the rear door (approximately 30'). For higher volume stops, a longer bus bulb equivalent to the length of two full buses (approximately 80') is desirable.

## Considerations

- » The minimum landing area length at all bus stops should be 8' perpendicular to the bus in order to accommodate deployment of an accessible ramp and boarding by passengers using wheeled mobility aids.
- » Use bicycle lane symbols in conventional bus stops to indicate the best path of travel for people using bike lanes through the bus stop. Conventional bus stop markings should delineate a straight path of travel through the bus stop and to the entrance to the receiving bike lane after the bus stop.

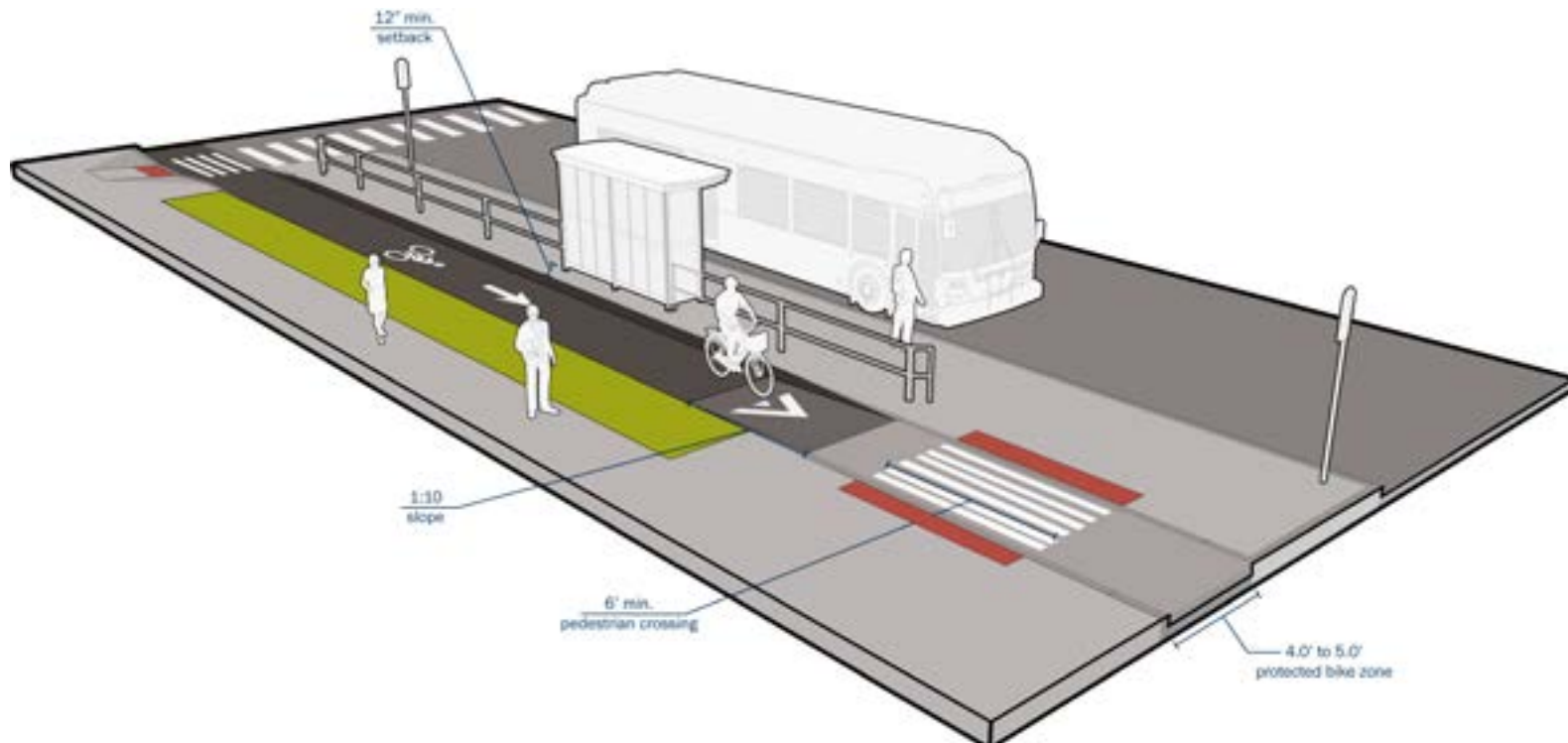

## Chicanes and Pinch Points

Chicanes slow traffic by creating a serpentine travel path by alternating street features from one side of the street to the other. Curb extensions or on-street parallel parking may be used to produce a chicane. Chicanes and pinch points slow motor vehicle traffic, allowing a more pleasant environment for people walking and biking in the roadway. They can be used for stormwater drainage catchment, street tree planting, benches, bicycle parking, and other amenities.

### Use

- » Use chicanes and pinch points on lower-volume streets including Local and Shared Streets. Engineering judgment should be used to determine when the need is met for these treatments.
- » Avoid use on streets with higher volumes of bus, freight, or emergency service activity.

### Design

- » Place chicanes to provide a maximum of 8:1 horizontal taper of the travel lane on either side. Consult the *Bikeway Design Manual* for detailed design information.
- » Use vertical elements like plantings or a W1-4 sign to warn drivers and snow plow operators of traffic pattern.
- » Use mountable curbs to accommodate larger motor vehicles while maintaining tight turn radii to slow people driving.

### Considerations

- » Use for stormwater infiltration with bioretention areas or appropriately sized tree filter boxes (see Green Infrastructure section).
- » Consult with community members to identify what amenities within chicanes are desired, such as public art, street furniture, bicycle parking, or planting area. Consider maintenance responsibilities before making amenity decisions.
- » Consult with Denver Fire Department (DFD) to ensure that designs minimize impacts to emergency services.
- » Coordinate with Street Maintenance to facilitate street sweeping.
- » If needed to maintain existing drainage patterns, consider constructing with a 2' drainage channel between the chicane island and curb.

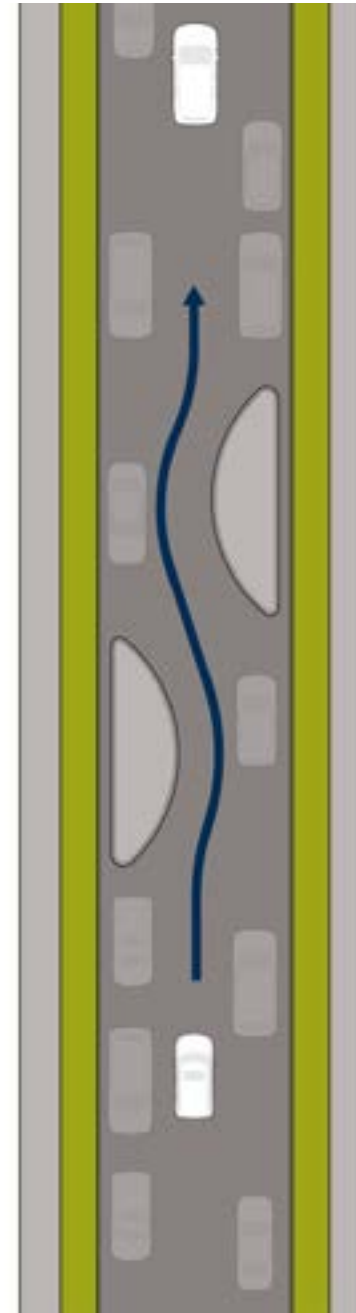

Chicane

## Corner Islands and Turn Wedges

A corner island is a raised area inside an intersection that decreases the corner radius and slows left or right turning movements for motor vehicles. Corner islands are typically used in conjunction with a protected bike lane and in protected intersections. These designs are typically constructed using concrete or curbing. Turn wedges, on the other hand, can be constructed with low-cost materials such as paint, flex posts, and rubber speed cushions and are usually at street level. Oftentimes, turn wedges are constructed to be easily mountable by large trucks, which need larger turn radii than passenger vehicles. These designs are typically used to reduce crash risk between people biking, walking, or rolling and people driving. Corner islands provide space for bicyclists waiting to turn or proceed through an intersection. They can also serve as a pedestrian refuge island, shortening crossing distances and increasing visibility of people walking and rolling across the street.

### Use

- » Typically, where major arterials or collector streets intersect, particularly those with protected bikeways, but these can be installed where no bikeway is present.
- » At intersections where high volumes of turning motor vehicles cross a protected bikeway. Refer to the *Bikeway Design Manual* for more information.
- » Where there is a demonstrated crash history between turning motorists and either people biking, walking, or rolling, or at intersections with larger than recommended curb radii.

### Design

- » To ensure passenger car turning speeds of no more than 10 mph, corner radii should be between 10' and 15'. If the control vehicle requires a larger turning radii, mountable materials may be used.
- » The motorist yield zone (width of the island) should be a minimum of 8', with 16.5' preferred.

### Considerations

- » Where high volumes of trucks and emergency vehicles exist, consider **truck aprons** or mountable curbs.
- » For interim or test installations, paint and flex posts and other materials can be used instead of concrete.

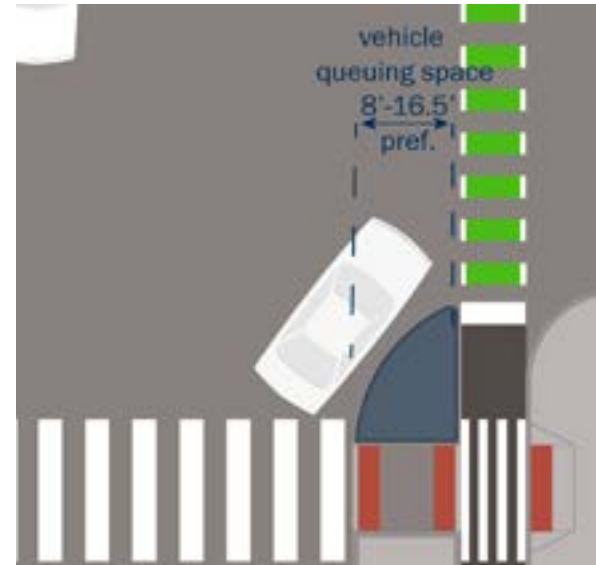

Corner island at a bikeway intersection



Truck aprons offer tighter turning radii for passenger vehicles while still allowing large trucks to mount the apron and maneuver through turns. The photo at left is a truck apron in Portland, OR.

## Corners and Curb Radii

Corner design has a significant impact on how well an intersection serves the diversity of roadway users. Two of the most important corner design elements are the effective corner radius and the actual curb radius. Actual curb radius refers to the curve that the face of curb line makes at the corner, while effective corner radius refers to the curve which motor vehicles follow when turning, which may be affected by on-street parking, bicycle lanes, medians, and other roadway features. Guidelines for curb radii design by street type can be found in the table on this page.

### Use

- » The smallest feasible curb radii should be selected for corner designs. Small curb radii benefit pedestrians by creating sharper turns that require motorists to slow down, increasing the size of waiting areas, allowing for greater flexibility in the placement of curb ramps, and reducing pedestrian crossing distances.
- » On streets where buses and larger vehicles need to make tight turns and on frequent freight routes, larger turning radii may be necessary to accommodate turning movements.
- » Small curb radii may be more difficult for large motor vehicles to negotiate. However, on-street parking or bicycle lanes may provide the larger effective radii to accommodate the appropriate design vehicle.

Street Type	Actual Curb Radii
Downtown Arterial	10' - 20'
Downtown Collector	10' - 20'
Main Street Arterial	10' - 20'
Main Street Collector	10' - 20'
Mixed-Use Arterial	10' - 25'
Mixed-Use Collector	10' - 25'
Commercial Arterial	10' - 30'
Commercial Collector	10' - 25'
Residential Arterial	10'
Residential Collector	10'
Industrial Arterial	20' - 30'
Industrial Collector	20' - 30'
Local Streets	5 - 10'
Shared Streets	5'
Alleyways	5'
Parkways	10' - 25'

### Design

- » Refer to the actual curb radii table to determine the physical radius of the curb. The effective corner radius needed to accommodate the design vehicle may differ and will depend on desired turning speed and street configuration, such as the presence of on-street bikeways, parking, etc.
- » A smaller curb radius should be used wherever possible including where:
  - » There are higher pedestrian volumes.
  - » There are low volumes of large motor vehicles.
  - » Bicycle and parking lanes create a larger effective radius.

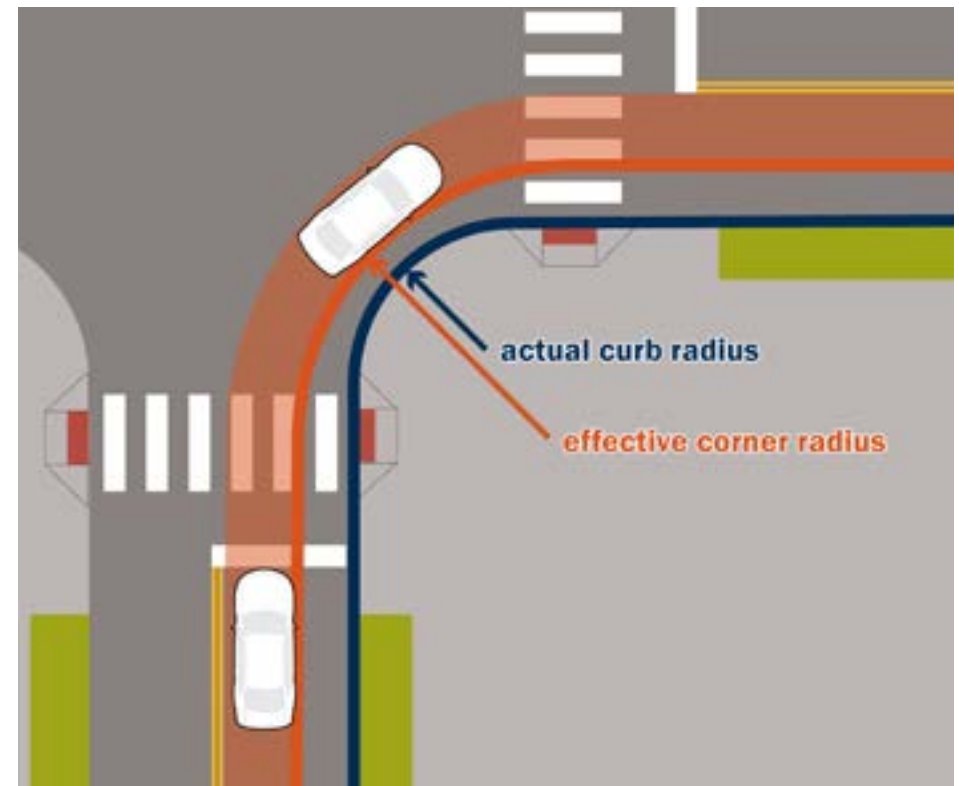

Effective vs actual curb radii



- » The maximum desired effective corner radius is 35' to accommodate large motor vehicles; however, all factors that may affect the curb radii must be taken into consideration. These include:
  - » The street type.
  - » The angle of the intersection.
  - » Presence of curb extensions.
  - » The number and width of receiving lanes.
  - » Where there are high volumes of large motor vehicles making turns, inadequate curb radii could cause large motor vehicles to regularly travel across the curb, causing damage to the curb and compromising the pedestrian waiting area. Adequate space should be made such that large vehicles can turn into adjacent travel lanes to reduce pedestrian risk.

## Considerations

A variety of strategies can be used to maximize pedestrian and bicyclist safety while accommodating large motor vehicles, including:

- » Adding parking and/or bicycle lanes to increase the effective radius of the corner.
- » Striping advance stop bars on destination streets to enable large motor vehicles to make the turn by encroaching into the adjacent roadway space.
- » Varying the actual curb radius over the length of the turn so that the radius is smaller as motor vehicles approach a crosswalk and larger when making the turn.
- » Installing a truck apron or turn wedge to discourage high-speed turns while permitting turns by larger motor vehicles.
- » Restricting access and operational changes prohibiting certain movements depending on land use and network needs.
- » While actual curb radii may be lower than federal/AASHTO standards, effective curb radii can often be larger and conform to these standards.

## Crosswalks

Marked crosswalks indicate a designated path for people walking and rolling through intersections, midblock crossings, and high-volume driveways. Denver Revised Municipal Code Section 54-1 provides the following definition for a crosswalk: Crosswalk shall mean that portion of a roadway included within the prolongation or connection of the lateral lines of sidewalks at intersections, or any portion of a roadway distinctly indicated for pedestrian crossing by lines or other marking on the surface. Marked crosswalks should be located at intersections, high-demand midblock points, and as dictated by City and County of Denver policy.

### Use

- » Crosswalk markings should be sited at all signalized and all-way controlled intersections, some uncontrolled locations per *Denver Uncontrolled Crossing Guidelines*, and at designated midblock locations.
- » For guidance on uncontrolled crossings, see Uncontrolled Pedestrian Crossings section of this chapter.

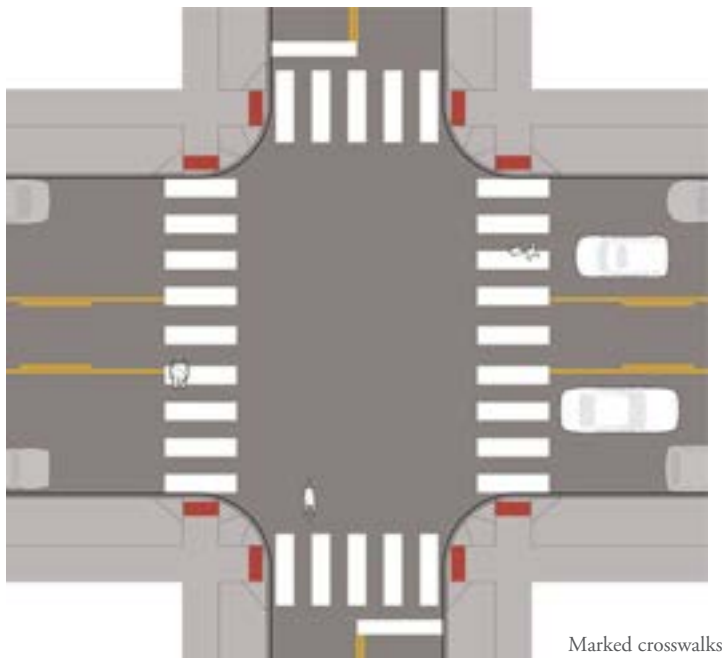

### Design

- » Consult the City and County of Denver *Uncontrolled Pedestrian Crossing Guidelines* for detail on crosswalk siting, pedestrian crossing types, and treatments.
- » Continental crosswalk striping should be used in all locations except in districts where crosswalks consist of brick paver material.
- » Install ADA-compliant curb ramps (or blended transitions for raised crosswalks) to connect to accessible routes when constructing new crosswalks.
- » At controlled intersections, provide a stop bar in advance of the crossing and consider signal timing guidance in the Pedestrian Signal Phasing section at signalized intersections. Consider location of vehicle stop bars based on design vehicle turning envelope.
- » Restrict on-street motor vehicle parking at least 20' in advance of the crossing to provide adequate sight distance. Depending on context, signage, paint, or curb extensions, or other strategies to daylight crosswalks may be appropriate.
- » Crosswalks should be as wide or wider than the connecting sidewalk. The Transportation Standards and Details for the Engineering Division includes standard details for a 10' wide crosswalk.
- » Where a protected bike lane crosses a crosswalk, yield markings on the bike lane approach can emphasize that people biking or using dockless mobility vehicles must yield to pedestrians within the crosswalk.

### Considerations

- » Streetlights should be located to front-light crosswalks, with the light source situated in advance of the crosswalk in the direction of motor vehicle travel. For wider intersections, it may be necessary to place light poles on all four corners of each intersection to adequately light a crosswalk.
- » Special paving or brick crosswalks are often existing in historic districts, downtown areas, or Main Streets. Include white striping on both sides of the special pavers or materials.
- » Consult City and County of Denver's *Street Lighting Design Guidelines* for lighting considerations when designing crosswalks.

## Curb Extensions

Extending the curb beyond the sidewalk or buffer edge shortens crosswalk length and increases visibility of people walking and rolling, particularly where there is on-street parking. Curb extensions are also effective tools for narrowing streets or tightening intersections to reduce motor vehicle turning speeds. Curb extensions may also be used to create a chicane or a bus bulb.

### Use

- » Intersection corners with on-street parking.
- » Bus stops (bus bulbs).
- » Midblock locations where traffic calming or improved sightlines are desired, including crossings for bikeways, off-street paths, bus stops, or significant points of interest.

### Design

- » Refer to the latest Transportation Standards and Details for design parameters.
- » Keep corner radii as small as possible while still accommodating the design vehicle.
- » Provide curb ramps at each crosswalk, except in the case of raised crosswalks or intersections, where tactile warnings should be used.
- » Ensure curb extensions do not impede stormwater management and drainage criteria. Consider any maintenance impacts for cleaning and maintenance.

### Considerations

- » Incorporate green infrastructure into curb extensions to collect stormwater and provide a planting area.
- » Incorporate street furniture or other public space elements such as public art, wayfinding, bike parking, trash and recycling receptacles, dockless mobility hubs, and street lighting.
- » Accommodate large design vehicles with mountable curbs or aprons while keeping corner radii tight to maintain slow turning speeds.

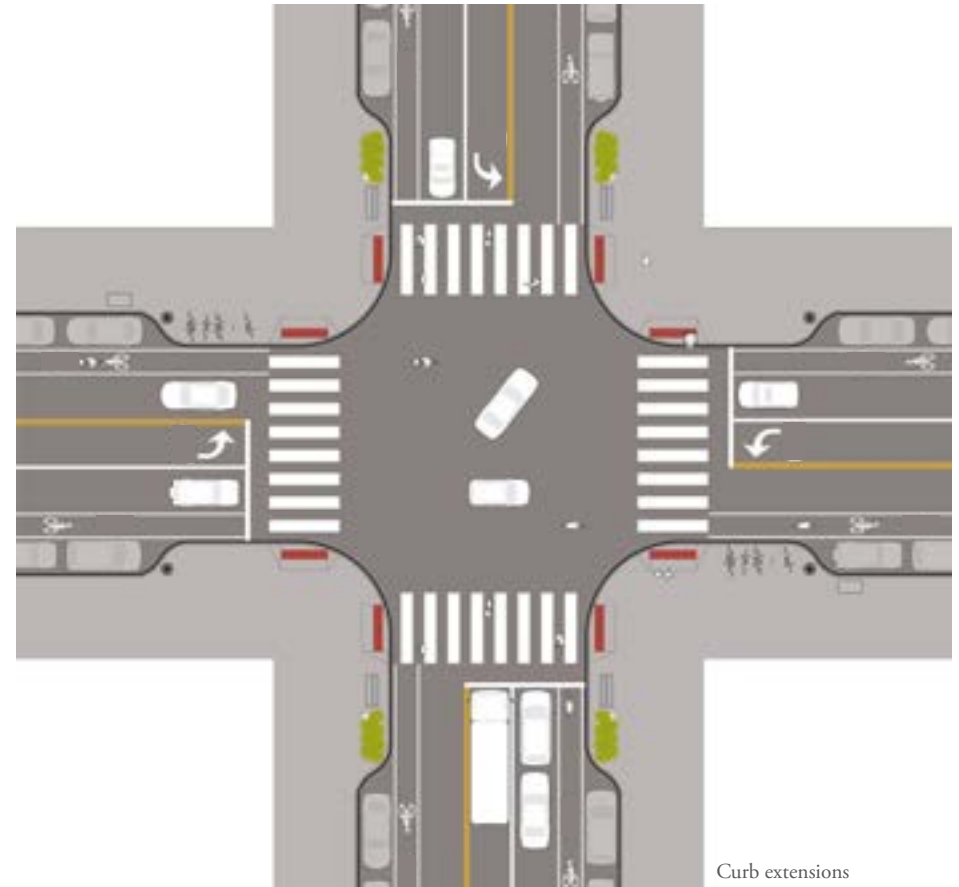

## Curb Ramps

Curb ramps are required at all intersection, midblock, and other crossings where curbs and vertical elevation changes are present along the pedestrian route. Curb ramps support independent travel for all people, including people with physical disabilities, people pushing strollers, or people towing suitcases or other wheeled objects.

### Use

» Pedestrian crossing locations where curbs and vertical grade changes occur.

### Design

- » Refer to the latest Transportation Standards and Details for design parameters for curb ramps.
- » Curb ramps need to be a minimum of 6' wide at locations maintained by Denver Parks & Recreation, such as Historic Parkways, per DOTI ROWS policy.

### Considerations

- » Use directional curb ramps instead of diagonal (blended corner) curb ramps to channelize pedestrian traffic and improve navigability for people with low vision.
- » Lengthen ramp and reduce slope below the maximum allowable standards where possible.
- » Widen ramp to match the sidewalk's clear width.
- » Widen ramp to accommodate multiple user types when connecting to a shared use path or sidewalk level bikeway.

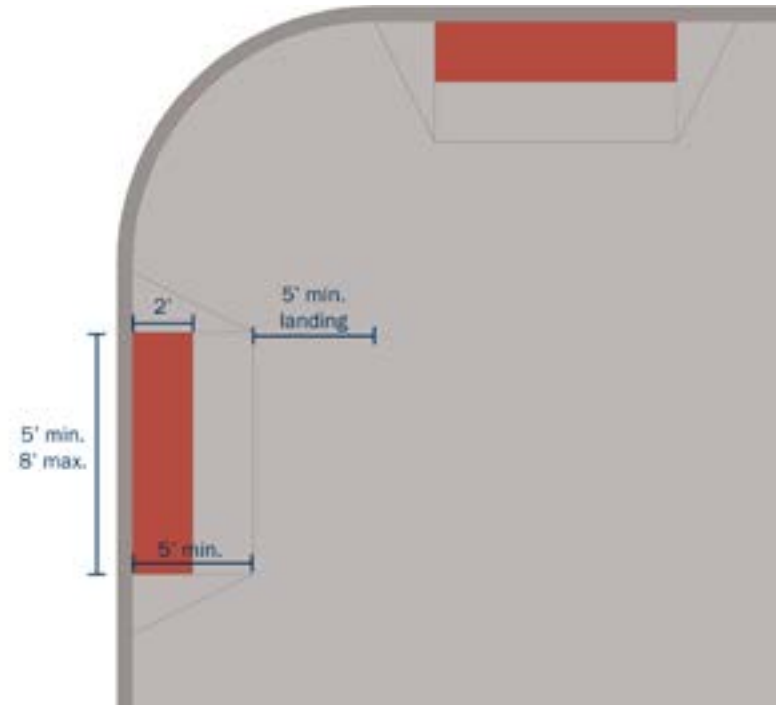

Curb ramp dimensions

## Driveway Crossings

Ideally, driveways for residential or commercial uses should be constructed to be level with the sidewalk or pedestrian path of travel and provide a minimum clear width of 5' across the driveway. A level, continuous sidewalk eliminates the need for vertical transitions while also communicating priority for people walking and rolling along the sidewalk. Raised driveway crossings can also enhance protected bike lanes by raising the bike lane to sidewalk level and ramping up the driveway in the buffer area.

### Use

- » All residential and commercial driveways.
- » All alley entrances.

### Design

- » Refer to the latest Transportation Standards and Details for design parameters for curb cuts.
- » Refer to the *Bikeway Design Manual* for detailed information about driveway crossings and raised crossings related to bike lanes.
- » Maintain a continuous sidewalk grade crossing width of at least 5' across all driveway crossings.
- » Maintain a sidewalk cross slope of 1.5% or less.
- » When driveways cross a bikeway, design for adequate sight distance for people driving using daylighting where necessary (see Sight Lines and Visibility (Daylighting)).
- » Align the edge of the transition apron with the face of the curb.

### Considerations

- » For streets with attached sidewalks or a narrow amenity zone, the sidewalk will be higher than the driveway crossing.
- » Contain driveway apron to the sidewalk buffer, where provided, to maintain sidewalk grade for entire length of the driveway crossing.
- » Maintain sidewalk and path materials (usually concrete) across driveway crossings to communicate priority for people walking, rolling, riding bicycles, and using dockless mobility vehicles.
- » Raise street-level protected bike lanes to sidewalk grade for high-volume driveway crossings. Where the density of major driveway crossings would result in a rapid succession of transition ramps, practitioners should consider raising the entire bike lane to sidewalk level.
- » Use bike crossing pavement markings at high-volume or wide driveway crossings when a bike lane is present.
- » Include audible warning for people walking and rolling across higher-volume driveways in commercial areas and where parking garage exits cross sidewalks.
- » In Downtown, Main Street, and Mixed-Use contexts, driveway crossings should be minimized, with service and motor vehicle access focused primarily on alleys.

## Hardened Centerlines

Hardened centerlines include vertical elements such as mountable curb or flex posts that force turning drivers to slow down and keep them from crossing the double yellow lines when making turning movements. They have been shown to reduce motorist-pedestrian conflicts and reduce the speed of left-turning vehicles.

### Use

- » Intersections with instances of crashes involving people walking or rolling and left-turning motor vehicles, or with high volumes of people walking, rolling, and biking crossing the street.
- » Intersections where motor vehicles are frequently turning across double yellow lines at high speeds.

### Design

- » Designs can include any combination of plastic curbing, rubber speed bumps, and flex posts, depending on turning radii, lane width, and needs to accommodate large motor vehicle turning movements.
- » Where space allows, install rubber speed bump “nose” extending into the intersection.

### Considerations

- » On roadways where trucks and emergency vehicles frequently make turning movements, consider using mountable curbs to allow larger motor vehicles to make turns while slowing smaller motor vehicles.
- » Intersection design including hardened centerlines must consider vehicular turning paths to prevent head-on collisions between opposing left-turning motorists.
- » Can be used in conjunction with turn wedges and at protected intersections.



Hardened centerlines

## In-Street Yield to Pedestrian Signs

In-street Yield to Pedestrian signs are signs placed in the roadway at crosswalk locations to remind roadway users of the laws regarding the right of way at unsignalized midblock locations and intersections. They also increase awareness and visibility of pedestrians crossing the roadway. They are often used in busy business districts; at school crossings and other locations with vulnerable populations; or where high pedestrian volumes occur in unexpected locations. In-street signs can be used in conjunction with advanced warning signs and pedestrian crossing signs at crosswalks.

### Use

- » In-street Yield to Pedestrian signs must only be used at unsignalized intersections or midblock locations with volumes below 12,000 vehicles per day. They are prohibited from use at signalized or all-way stop-controlled intersections.
- » In-street Yield to Pedestrian signs work best on low-speed, two-lane roads. They are not recommended for roads with three or more lanes, or roads with high speeds or volumes where drivers are less likely to see them.

### Design

- » In-street Yield to Pedestrian signs should be placed in the roadway close to the crosswalk location on the center line or on a median island, but they should not obstruct the crosswalk. In-street signs should also be placed to avoid turning motor vehicles from knocking over the sign and should be designed to bend over and bounce back when struck.
- » Use MUTCD as additional guidance for sign design.

### Considerations

- » May be permanent or temporary. It may be preferable to remove them during winter for snow removal. If there are maintenance issues, alternative treatments should be considered.
- » Require regular monitoring and should be replaced when damaged. Damaged signs send the message to pedestrians that a crossing is not safe.
- » Are typically not used at yield-controlled intersections and should only be installed using engineering judgment.
- » May be used in combination with pedestrian warning signs. Warning signs should be placed on the right side of the road on the sidewalk or mounted on a mast arm above the crosswalk.

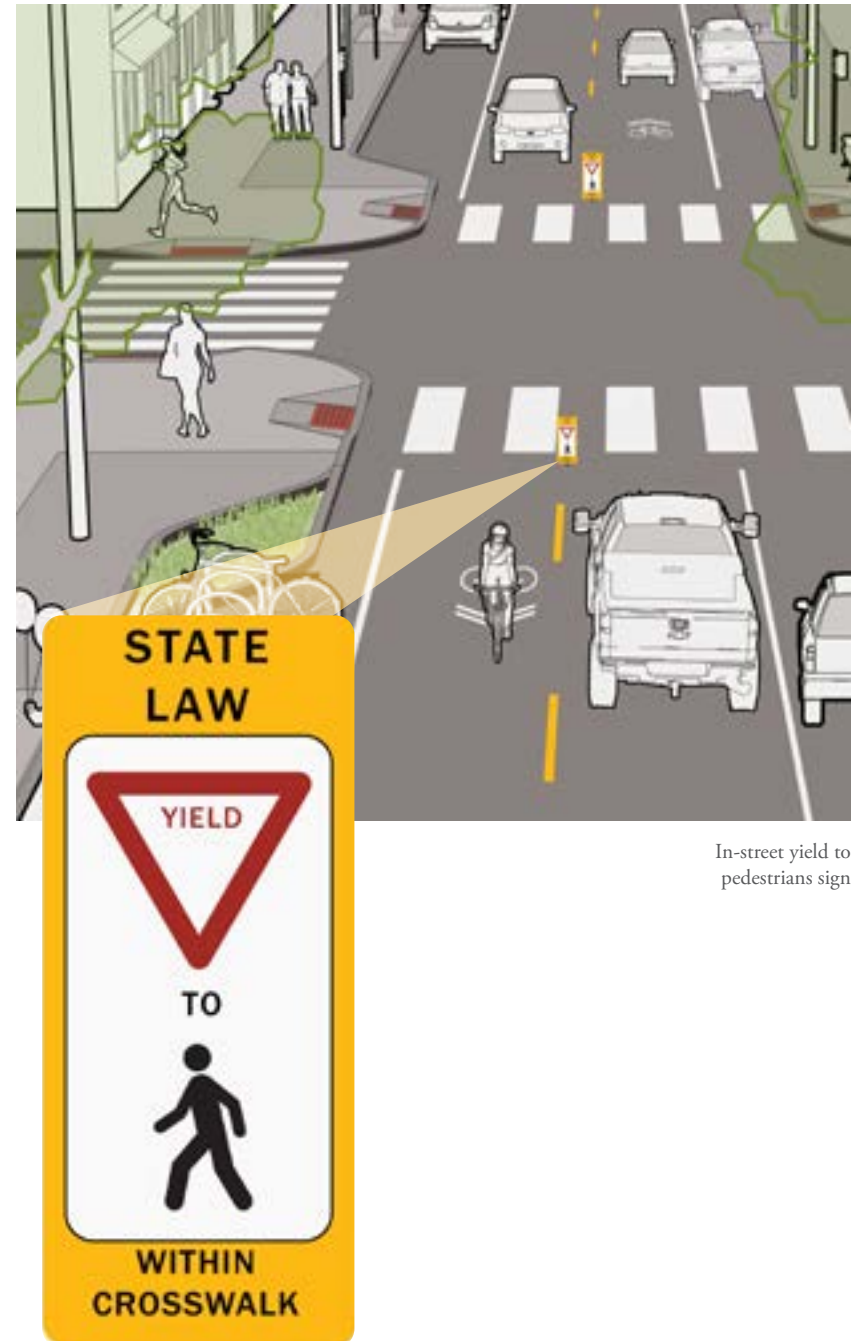

In-street yield to pedestrians sign

## Median Refuge Islands

Median refuge islands provide a protected refuge space in the center of two-way streets to allow pedestrians to cross the street in two phases. Median refuge islands are particularly beneficial where crossings are long or where a person must walk across more than one lane of traffic per direction to reach the other side of the street. Islands also provide traffic calming by narrowing the roadway and creating edge friction.

### Use

- » Crossings that require a person to walk across more than one lane of traffic per direction on two-way streets.
- » Crossings where the roadway width or observed motor vehicle speeds make people crossing the street feel unsafe or where traffic speeds and volumes otherwise prohibit people from crossing, in accordance with the FHWA STEP Guide.
- » May be used on streets with or without on-street parking.

### Design

- » Provide a minimum pedestrian island width that matches the width of the crosswalk or that is a minimum of 6' wide and 6' in depth.
- » Provide detectable warning strip at the entrance and exit to the refuge island, or any time a person walking or rolling will enter the general travelway.
- » Ensure landings meet accessible slope requirements and truncated domes are constructed at either end of the waiting area.
- » At signalized intersections, pedestrian signal heads must be oriented and timed to serve people in the refuge island. Where pedestrian signalization is not on automatic recall, a push button should be provided in the refuge island.
- » Follow MUTCD guidance for warning signage, signalization, and pavement markings on the island approach.

### Considerations

- » Maximize the width of the crossing island to narrow motor vehicle travel lanes and increase pedestrian comfort. An 8-10' wide island is preferred.
- » Design should consider ability to withstand load of fire apparatus and/or turning movements in the design of the median noses.

- » Flush accessible paths through the pedestrian island are preferred to minimize the need for ramps. When a flush route through the island is used, detectable warning panels must be installed to indicate the transition from the pedestrian refuge island to the general travelway.
- » Consider bioretention planters, street trees, or other stormwater management techniques where there is sufficient space in the median island. Ensure plantings do not interfere with sight distance triangles and pedestrian visibility.
- » At locations where people biking may also be crossing, such as shared use path crossings, a width of 10' is preferred over the 6' minimum.

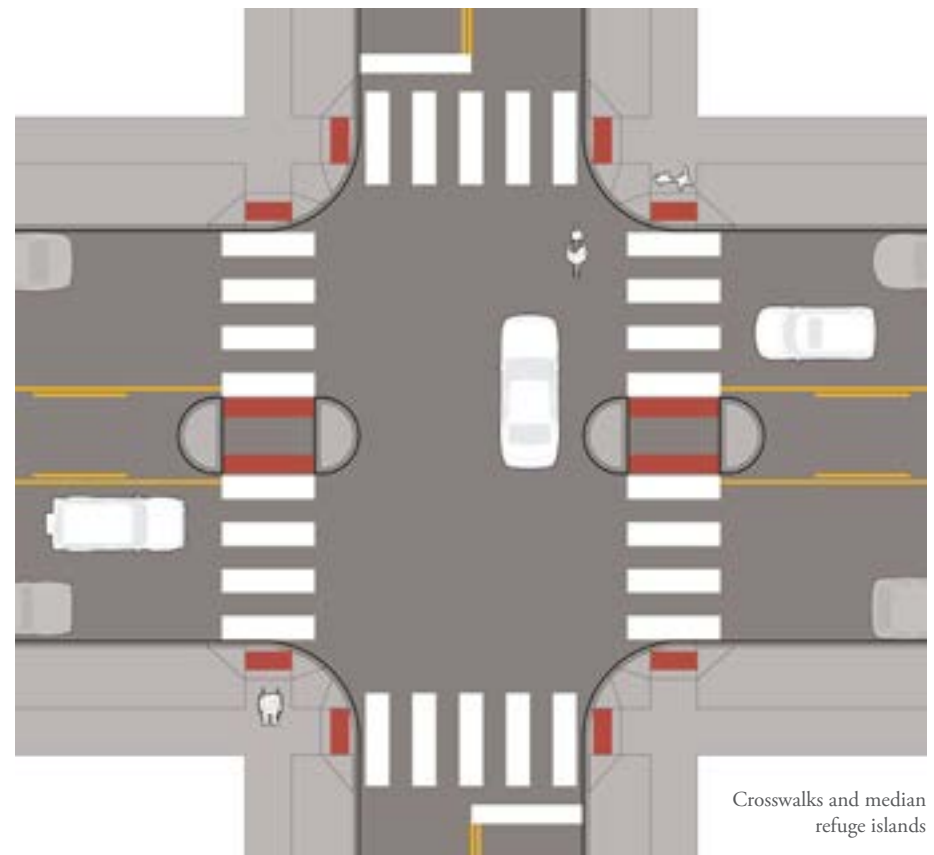



## Neighborhood Traffic Circles

Neighborhood traffic circles or mini roundabouts are effective traffic calming design alternatives for low-volume neighborhood streets, particularly when used in conjunction with other strategically-placed traffic calming devices throughout a corridor. Neighborhood traffic circles may be installed with standard height or mountable curbing depending on turning radius requirements. Traffic circles also provide opportunities for plantings, special identifying signage for neighborhoods, or public art.

### Use

- » Intersections in primarily residential areas where daily motor vehicle volumes for all approaching legs of the intersection is less than 15,000 ADT.
- » Intersections along traffic-calmed neighborhood bikeways.

### Design

- » Neighborhood traffic circles are most effective when paired with other traffic calming treatments. Consult the Neighborhood Bikeways chapter of the *Bikeway Design Manual* for how to apply circles to an overall corridor.
- » Provide 15' of clearance from intersection corners to edge of traffic circle. This may include a mountable truck apron.
- » Use the largest traffic circle radius possible to encourage slow speeds. See the *Bikeway Design Manual* for recommended radii by street width.
- » Traffic controls may be used in addition to the traffic circle. If used, mount YIELD (R1-2) or STOP (R1-1) control signs at motor vehicle approaches to the circle.
- » Mount a R6-4 directional sign in the circle when possible. Mount the R6-5P on the STOP or YIELD sign post if a sign can't be mounted within the circle. Use corner curb extensions or splitter islands to channelize motor vehicles and further reduce speeds.
- » Design the circles to be visible at night with reflective materials and/or ensure adequate street lighting exists. Assess visibility in the field and recommend changes where needed.

### Considerations

- » Include mountable truck aprons around the outside of the circle to allow large motor vehicles to use the intersection without encouraging high speeds by smaller motor vehicles.
- » If the circle geometry precludes turning movements for larger vehicles, consider turning restrictions if the adjacent street network is adequate.
- » Consider planting native and/or seasonal vegetation in the center of the circles to provide neighborhood beautification, traffic calming elements, and stormwater infiltration.
- » Depending on maintenance agreements, consider custom neighborhood identification signage or public art to the circle interior.



Planted neighborhood traffic circle

## No Turn on Red Restrictions

NO TURN ON RED signs are used to restrict motor vehicles from turning right or left at signalized intersections, during the red indication. Restricting this movement eliminates conflicts with bicycles and pedestrians crossing in front of motor vehicles making turns. These types of turning restrictions are a leading Vision Zero operational strategy.

### Use

NO TURN ON RED signs should be considered at signalized intersections with one or more of the following features or characteristics:

- » An exclusive pedestrian phase where motor vehicles are to remain stopped while pedestrian movements commence.
- » A leading pedestrian interval.
- » Motor vehicle turning movement conflicts with high volumes of pedestrians or bicyclists.
- » Poor sight distances and visibility.
- » Geometry of the intersection may result in unexpected conflicts.
- » More than three crashes reported in a 12-month period between pedestrians and motor vehicles where turn-on-red is permitted.
- » Bicycle boxes.

### Considerations

- » NO TURN ON RED signs can be provided at all times or by a dynamic sign that changes when pedestrians are present, by time of day, by a call made by an emergency vehicle, and/or at rail or light transit crossings.
- » NO TURN ON RED signs can also be used in conjunction with leading pedestrian intervals or bicycle signals that allow through movements when turning vehicular traffic is stopped.

## Pedestrian Signal Phasing

Pedestrian signals are part of a system of traffic signals that control intersection operations for people walking and rolling. Pedestrian signal phasing is intended to minimize exposure of people walking and rolling to motor vehicles, minimize delay for people waiting to cross the street, reduce non-compliant and unsafe crossing behavior, and provide accessibility benefits to people with disabilities. Pedestrian phasing falls into three categories: concurrent, exclusive, or a hybrid of the two. As much as possible, consistent approaches to pedestrian phasing should be used across the city to help make the pedestrian network predictable and consistent.

Concurrent phasing refers to phasing schemes that allow people to walk across the street at the same time and in the same direction as motor vehicle traffic. Concurrent phasing minimizes delay for all users. Exclusive phasing provides a separate phase for people walking and rolling that prohibits all motor vehicle movements while people walk across the street. An example of this is Denver's all-pedestrian signal phasing at some signals downtown. Exclusive phasing can provide safety benefits by eliminating conflicts with motor vehicles; however, it often creates longer delays for all modes and leads to less safe, non-compliant crossing behavior where right-of-way is unclear. A hybrid phasing scheme may be beneficial at complex intersections including those with skewed intersections, multiple lanes of traffic, and leading protected left-turn phases. Hybrid pedestrian phasing uses concurrent phasing to minimize delay for people walking and rolling on those legs of the intersection where conflicts are minimal, while providing an exclusive phase for more challenging legs of the intersection.

### Use

- » All signalized intersections where people walking and rolling are likely to be present.

### Design

- » A walking and rolling speed of 3.5' per second should be used to time all pedestrian phases and provide adequate time for people to cross the street.
- » Concurrent Phasing:
  - » Use concurrent phasing at all signalized intersections, except where a strong safety concern is noted due to high turning movement volumes (250 or more turning movements per hour).
  - » Leading pedestrian intervals (LPIs) should be used where concurrent phasing is applied to give people walking and rolling across the street a head start before other street users are allowed to proceed. LPIs encourage people driving to yield to pedestrians while they are turning and improve visibility between all users. No Turn on Red restrictions should be implemented at all locations where LPIs are used.
  - » Where concurrent phasing is used, consider placing signals on automatic pedestrian recall, particularly in high pedestrian traffic areas, such as within commercial areas and within a 10-minute walk shed of bus routes or transit stations.
  - » Protected left-turn phases provide an exclusive phase for people driving to turn left and may be warranted if there is a pocket lane or center turn lane and high volumes of turning or opposing traffic on the street. In these cases, lagging left turns (left turn signal at the end of the 'green' phase) should be considered instead of leading left turns (left turn signal at the beginning of the 'green' phase) to preserve the ability to use LPIs with concurrent phasing. The lagging left turn phase should be provided for both directions of traffic to avoid conflicts between through movements and permissive left turns.

» Exclusive Phasing:

- » Consider use of exclusive phasing where high concentrations of people walking and rolling are present or where at least 250 motor vehicles turn right (or left on one-way streets) per hour along any approach.
  - » No Turn on Red restrictions should be considered at all locations where exclusive phasing is used.
  - » Ensure all pedestrian signal heads are correctly oriented to be visible to all users who are directed to follow the signal indications.
- » Countdowns are required for all newly installed/ replaced pedestrian signals, and provide a pedestrian countdown in pedestrian signal heads to assist people with street crossings.

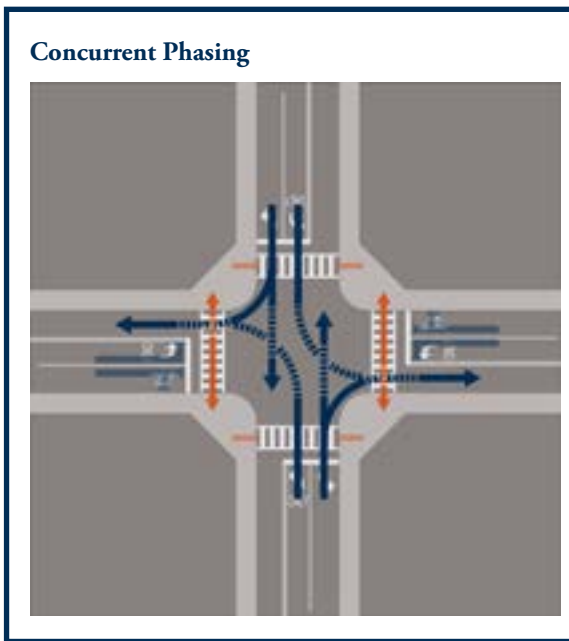

**Considerations**

- » Time signal phasing so that people walking and rolling have adequate time to cross both sides of a median-divided street during a single walk phase.
- » Provide accessible pedestrian signals (APS) to assist people with disabilities.

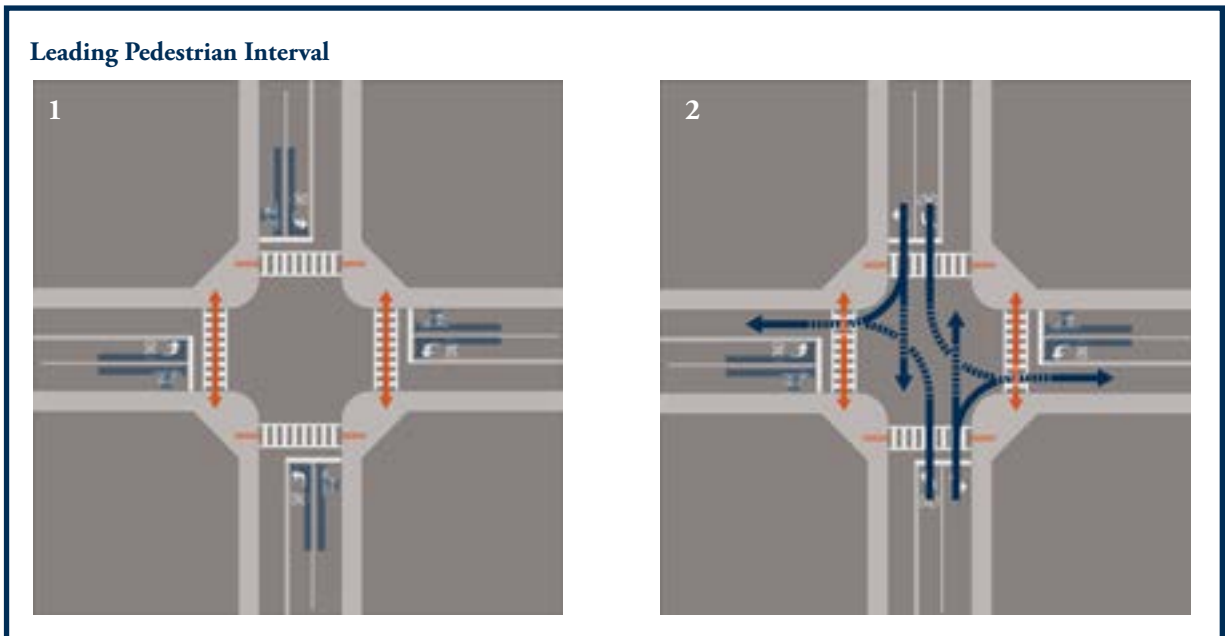

## Raised Crossings and Intersections

Raised crossings and intersections are used to slow traffic and reduce conflicts between motorists and people walking, rolling, and biking on or across the street. These crossings are elevated to reduce or eliminate the vertical transition between the sidewalk and the street. Transition aprons on each approach to the raised crossing may include pavement markings, signage, or color changes to alert drivers of the grade change.

### Use

- » Trail and sidewalk-level bikeway crossings.
- » Intersections or midblock locations where increased visibility, priority or accessibility for people walking, riding bicycles, or using dockless mobility vehicles is desired or needed, including school zones.
- » Across channelized right-turn lanes.
- » Appropriate along Downtown, Main, Mixed-Use, and Residential Collector Streets and Local Streets where they intersect with arterial and collector streets.
- » Appropriate at locations where corner radii exceed 20'.
- » Not appropriate on streets with steep roadway grades higher than 8%.
- » Not appropriate for installation directly adjacent to driveway aprons.

### Design

- » Ensure raised crosswalk/intersection is at least as wide as the connecting sidewalk or path of travel.
- » Provide detectable warning strip at edge of sidewalk to indicate to pedestrians that they are exiting the sidewalk and entering the street. Also ensure that raised crossing/intersection meets accessible slope requirements.
- » Restrict on-street parking and loading at least 20' before the marked crosswalk to provide adequate sight distance and visibility between people crossing and people driving.
- » Include warning pavement markings for drivers on transition aprons and RAISED CROSSWALK or RAISED INTERSECTION signs at the crossing.
- » Provide transition apron slopes between 5% and 8%.
- » Supplement parking restrictions with signage, pavement markings, and vertical elements such as flexible delineators, bollards, or planters.
- » Where motor vehicles with low height wheelbases are likely (e.g., lowboy trailers), the raised crosswalk/intersection height should be limited to 3 inches.

### Considerations

- » Consider use of raised crosswalks with curb extensions to maximize visibility and further slow traffic.
- » Ensure that raised crossing/intersection design does not negatively impact stormwater runoff, and snow plowing and maintenance are considered.

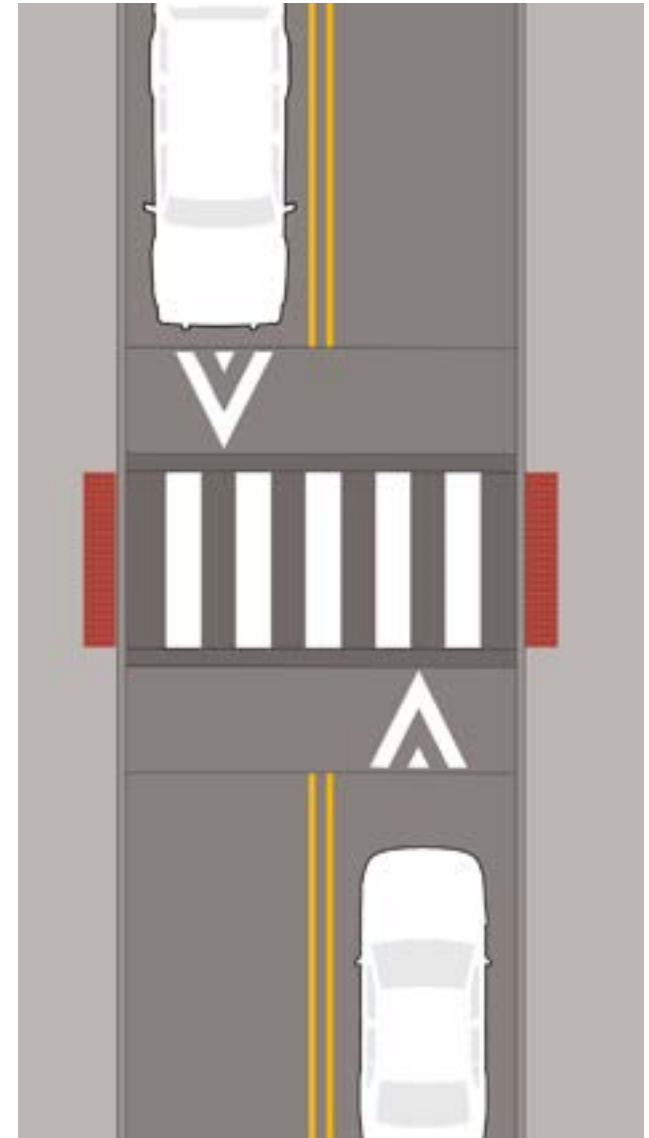

Raised crossing

## Sight Lines and Visibility (Daylighting)

Setting back parking, trees, and other visual obstructions from intersections and driveways, often referred to as daylighting, provides appropriate sightlines and visibility. Daylighting can be provided by using signs, pavement markings, flex posts, and/or curb extensions. Daylighting has been shown to be an effective Vision Zero strategy.

### Use

- » Locations where there is on-street parking, vegetation, or other objects obstructing sight-lines approaching crosswalks, intersections, or driveways.

### Design

- » Refer to current DOTI Daylighting Procedure Statement for guidance on how and where to place parking setbacks for visibility at intersections and crossings.
- » Sign or mark at least 5' of space from a lower-volume driveway as 'No Parking.'

### Considerations

- » Use engineering judgement to determine if longer daylighting areas should be used based on prevailing motor vehicle speeds or other intersection features.
- » Use physical delineators like flex posts or curb extensions to prevent motor vehicles from stopping in daylighted areas.
- » Consider ground murals, decorative planters, bike and dockless mobility parking, or mobility hubs in daylighting areas.

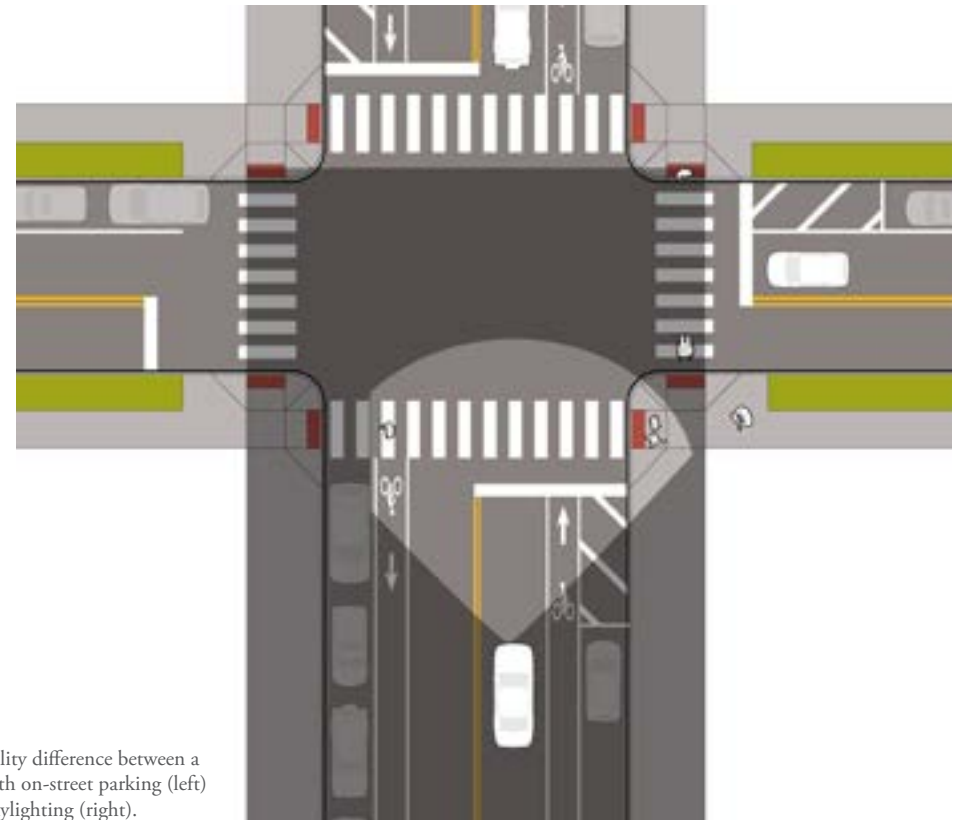
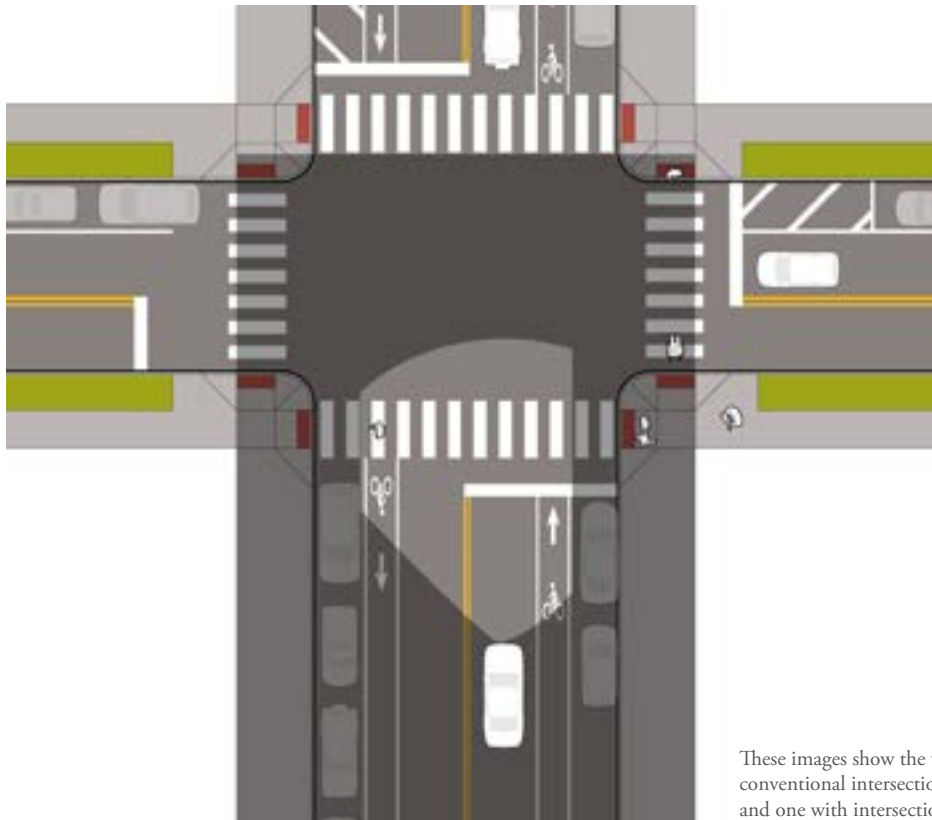

These images show the visibility difference between a conventional intersection with on-street parking (left) and one with intersection daylighting (right).

## Speed Cushions, Humps, and Tables

Vertical deflection, including speed cushions, humps, and tables, are some of the most effective treatments for slowing motor vehicle speeds. These treatments are also a form of “soft diversion,” which can make streets less desirable to motorists and potentially reduce motor vehicle volumes.

### Use

- » Local and shared streets
- » Midblock locations where lower motor vehicle speeds and volumes are desired, such as neighborhood bikeways

### Design

- » Speed humps should be designed to be between 3” and 4” higher than the existing pavement.
- » The approach and departure ramps should have a grade of 1:12, resulting in a ramp length of 3’ for ramps with 3” height.
- » Speed humps and cushions should not be located in front of driveways or close to intersections.
- » Extend speed humps the entire width of the street pavement, excluding gutter pan to provide adequate drainage.
- » Locate speed humps and cushions periodically along the corridor every 200 to 400 feet to accomplish speed control.
- » When the roadway grade is steeper than 5%, speed cushions should be used that allow bicyclists to ride downhill without risk of pedal strike. When grades exceed 8%, speed humps should not be used.
- » For speed cushions, side slopes on tapers should be no greater than 1:6 and each cushion should be 7’ in width with 3’ between cushions to accommodate for emergency response vehicle wheelbase and tire width.
- » Speed tables should have similar tapers and widths as speed humps, but should include a flat area on top that is at least 22’ long.

### Considerations

- » On roads with frequent emergency vehicle access, use speed cushions, which include gaps to allow motor vehicles with wide wheelbases to pass through unimpeded.
- » Use speed tables on roads with higher vehicle speeds and volumes. When used at an intersection or midblock crossing, follow guidance for raised crossings.
- » Speed humps are typically constructed out of asphalt, although rubber vertical deflections can be installed as a pilot or interim project.
- » Design should consider the ability to withstand the weight of fire apparatus and outriggers.
- » Consider drainage impacts and existing drainage patterns when installing speed cushions, humps, and tables.

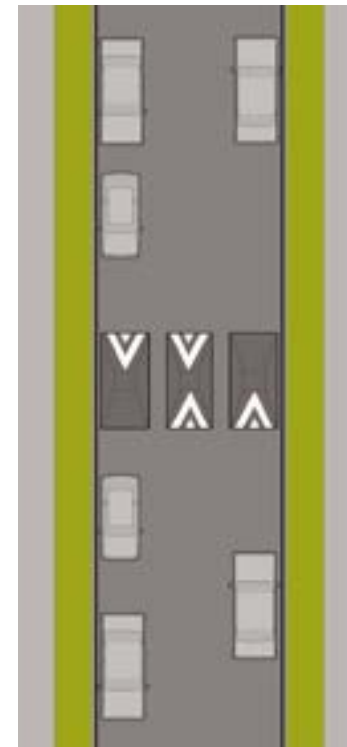

Speed cushions

## Transit Priority at Intersections

By prioritizing transit at intersections, service can become more reliable, efficient, and environmentally friendly due to less queuing and stopping and starting, thus making transit a more attractive mode of transportation. Transit prioritization strategies include signal coordination, signal priority, transit-only lanes, and queue jump or bypass lanes. **These strategies can dramatically improve transit operations at a relatively low cost compared to corridor-wide modifications.**

Signal coordination times a series of traffic lights along a corridor to permit smooth progression of traffic. This progression reduces overall traffic congestion thus aiding transit travel times together with other vehicular travelers. Signal coordination uses a pre-timed signal timing program.

Transit signal priority (TSP) enables an approaching transit vehicle to communicate with a traffic signal and alter the signal timing in a way to advantage transit progression. Transit signal priority may extend the signal green time, truncate the red phase, swap signal phases, insert a transit-only phase, or skip signal phases. The margin of signal time prioritized for transit is typically made up in modifications to the remaining signal phases with the overall signal cycle length remaining generally unchanged and fully recovered in the following cycle.

During highly congested periods or on routinely congested corridors, TSP alone may be ineffective at improving transit service. In these cases, short transit-only “queue-jump” lanes at intersections provide an opportunity for transit vehicles to bypass stopped traffic and move forward through a congested intersection. Queue-jump lanes may be transit-only or combined with general purpose right turn lanes. They may continue on the far-side of an intersection to permit transit vehicles to re-merge with through traffic. Queue jump lanes are often paired with a separate signal to permit the queue jump lane to advance and clear while other motor vehicles traveling in the same direction are given a red light.

### Use

- » Transit Signal Priority can be used along bus routes, particularly those experiencing frequent delay.
- » TSP, queue jumps, and other measures should be prioritized on high-frequency bus routes.
- » Queue jump lanes can be used at intersections without a transit stop as well as with one at either the near- or far-side so long as there is enough space on the roadway.
- » Signal coordination can reduce delay for transit as well as motor vehicles. Signal coordination uses a pre-timed signal program for traffic and pedestrian crossings.

### Design

- » Transit signal priority requires special communication technology to permit communication between the signal and approaching transit vehicles. TSP may be used on either pre-timed or activated signals.
- » Signal coordination and signal priority can be used with or without the presence of dedicated transit-only lanes or queue jump and bypass lanes at intersections.
- » Advanced stop bars may be used in combination with queue jump lanes to help transit vehicles re-enter the traffic stream or jump to the front of the queue. Advanced stop bars stop all traffic some distance back from the traffic signal.
- » Transit-only queue jump lanes may be enhanced with colored pavement or striping to further define it as a transit-only space.
- » Queue jump lanes gain the greatest advantage when provided separate signal phasing to permit lanes to clear in advance of general traffic.
- » Traffic signal priority typically cannot be activated for more than two signal cycles in a row and then cannot be activated until two to three additional signal cycles have passed to enable overall intersection recovery.



## Considerations

- » Providing a queue jump lane with a leading signal phase should take into consideration the overall signal cycle lengths and impacts to delay for other users.
- » If space is not available for a queue jump lane or bypass lane, consider using a right-hand turn lane to double as a transit advantage lane by allowing transit vehicles to move up in the queue at a signal where right turn on red is permitted. If right-turn lanes are used, appropriate signage such as RIGHT LANE MUST TURN RIGHT must be accompanied by EXCEPT BUSES placards.
- » Transit signal priority should be considered on all priority transit routes. Studies should be conducted to understand the impact to traffic on cross streets and other corridor users. TSP should be installed only when there are documented schedule adherence issues.
- » Signal coordination should take all modes into consideration including travel speeds of bicyclists and pedestrians along the corridor. Signal coordination should seek to optimize progression of all modes and minimize delay for pedestrians and bicyclists.
- » Public and transit operator education is needed for the use of queue jump lanes in multimodal environments and managing transit vehicle, motor vehicle, pedestrian, and bicycle interactions.
- » Compliance may be an issue if advance stop bars are used.

## Uncontrolled Pedestrian Crossings

Uncontrolled pedestrian crossings can be found in every neighborhood and are an important part of the pedestrian network in Denver. The City and County of Denver *Uncontrolled Pedestrian Crossing Guidelines* provide detailed information for planners and engineers about whether to mark an uncontrolled crosswalk as well as how to determine the appropriate treatment to ensure safety and efficient movement of all users of the transportation system. This section serves as a supplement to these guidelines.

### Use

Uncontrolled crossings can be found on every roadway type but are typically found at intersections of lower-volume roads that do not require signalization. Several factors are used to determine whether to mark a crossing:

- » Crosswalks should be marked at all signalized intersections and at all-way stop controlled intersections with centerline striping on one or both approaches and should follow guidance in the City and County of Denver *Uncontrolled Pedestrian Crossing Guidelines*.
- » At uncontrolled locations, crosswalks may be installed when they meet one or more of the following criteria;
  - » Where demand requirements of 20 pedestrians/hour, applying conversion factor of 1.33 for vulnerable populations, and where the location meets sight distance requirements (AASHTO's *A Policy on Geometric Design for Highways and Streets*) or sight distance obstructions can be removed.
  - » Where a location meets MUTCD's pedestrian signal warrant or application guidance for a pedestrian hybrid beacon, a marked crosswalk and pedestrian hybrid beacon may be installed.
  - » Where pedestrian delay of LOS D or worse exist.
  - » At locations directly serving a school, hospital, senior center, recreation center, library, commercial district, or park.
  - » At locations serving an existing shared-use path or trail as defined by *Denver Moves*.

### Design

- » Consult the City and County of Denver *Uncontrolled Pedestrian Crossing Guidelines* for detail on crosswalk siting, pedestrian crossing types, and treatments.
- » Crosswalks at uncontrolled intersections should have continental crosswalk markings.
- » Install ADA-compliant curb ramps (or blended transitions for raised crosswalks) to connect to accessible routes when constructing new crosswalks.
- » Provide yield lines and regulatory sign R1-5 in advance of uncontrolled multi-lane midblock crossings. Use W11-2 signs for single-lane approaches.
- » Restrict on-street motor vehicle parking at least 20' in advance of the crossing to provide adequate sight distance. Depending on context, signage, paint, or curb extensions, or other strategies to daylight crosswalks may be appropriate.
- » Crosswalks should be as wide or wider than the connecting sidewalk. Crosswalk markings should be a minimum of 10' in width.
- » Where a protected bike lane crosses a crosswalk, yield markings on the bike lane approach can emphasize that people biking or using dockless mobility vehicles must yield to pedestrians within the crosswalk. This most commonly occurs at midblock crossings, protected intersections, and transit island stops.

### Considerations

- » Streetlights should be located to front-light crosswalks, with the light source situated in advance of the crosswalk in the direction of motor vehicle travel. For wider intersections, it may be necessary to place light poles on all four corners of each intersection to adequately light a crosswalk. See Denver's *Street Lighting Design Guidelines* for details.
- » Use special paving or brick to match local context in historic districts. Include white striping on both sides of the special pavers or materials.

# Green Infrastructure

## General Guidance

Green infrastructure is a fundamental part of the City's long-term stormwater management strategy and an important tool to combat the urban heat island effect and cool city streets. Site scale green infrastructure practices, designed specifically for use in the right-of-way, treat stormwater directly at the source by directing road runoff into vegetated facilities. This practice is fundamentally different from traditional drainage design, which moves stormwater away from the roadway as quickly and efficiently as possible. It is important to weave natural processes back into urban streets using green infrastructure to improve water quality, enhance climate resiliency, and create safer connections for all modes.

To support this commitment and comply with federal requirements, Denver developed the *Ultra-Urban Green Infrastructure (UUGI) Guidelines*, which provides guidance for selecting, sizing, and constructing green infrastructure that fits in a typical street configuration. The UUGI structures include streetside stormwater planters and bump-outs, tree trenches, pervious pavement, and green gutters. The UUGI guidelines do not detail every type of green infrastructure opportunity available for use in the right-of-way, nor do they include recommendations for space allocation or a design process to accommodate the new features. While traditional roadway design includes transportation engineering and drainage engineering as two parallel tracks with each practice separate from the other, Complete Streets update this narrow approach. **Complete Streets aim to integrate green infrastructure and multiple modes of travel into the same space to achieve a balance between mobility needs with environmental performance.**

Green continuum interventions are the first step in stormwater management, focusing on runoff reduction practices. These Low Impact Development (LID) strategies reduce unnecessary impervious areas and route runoff from impervious surfaces over permeable areas to slow runoff (increase time of concentration), reduce overall volume of runoff, and promote on-site storage and infiltration. These decentralized, micro-scale interventions infiltrate, store, evaporate, and/or detain runoff close to the source, reducing the volume of water that will require treatment in structural best management practices (BMPs).

While stormwater management and LID are not aimed directly at streetscapes, green continuum strategies can be included as follows:

- » Preserving and protecting existing vegetation
- » Reducing impervious area
- » Including permeable pavements where appropriate as determined by DOTI
- » Planting trees with adequate resources
- » Depressing planted areas
- » Directing runoff from adjacent sidewalks to planted areas

This section of the Guidelines is related to City-led projects only, as private development projects have separate on-site water quality requirements.

## Bioretention Practices

Bioretention treatment areas are landscaped areas that temporarily store, infiltrate, and filter stormwater runoff from impervious paved surfaces (surfaces such as sidewalks and roadways that do not allow water to drain through the surface). Depending on their location, bioretention facilities may also provide traffic calming benefits. Treatments incorporated into the streetscape reduce the load on the municipal stormwater system; reduce runoff into local waterways; filter pollutants from runoff; and increase vegetation that helps clean our air and beautify our neighborhoods.

### Use

- » Within buffer areas, curb extensions, parking islands, medians, traffic circles, off-road trailside areas, and pedestrian refuge islands where at least 3' of width is provided.

### Design

- » Bioretention facilities must not interfere with the pedestrian accessible route.
- » Native pollinator plants should be used when vegetation is included to support beneficial insects that are important to ecosystem health.
- » Vegetation should be suited for the conditions of the site and maintenance requirements. Bioretention facilities must be designed in a way that prioritizes safety, aesthetics, and long-term maintenance in addition to functionality.
- » Low-growing plants (under 30" height) should be used in locations where sight distance (e.g., for crosswalk locations) must be preserved or where personal safety is a concern.
- » Green stormwater infiltration treatments located adjacent to building foundations should consider building drainage infrastructure, roof drainage and runoff, waterproofing of the foundation, and existing underground utilities.
- » Treatments should be calculated and designed for the expected volume of stormwater. Overflow piping mechanisms should be provided where necessary. Bioretention facilities should drain surface water within 72 hours after storm events to prevent insect habitat and bacteria accumulation.

- » Inlet curb cut openings should be designed to effectively channel stormwater into the adjacent stormwater feature by achieving at least a 2" drop in grade between the curb cut and the feature's finished surface. An inlet width of at least 18" should be provided to reduce the likelihood of clogging. The curb cut surface area should be sloped downward into the feature.
- » Check dams or serpentine swale alignments should be used to control stormwater flow within the swale on longitudinal slopes of 2-5% with bioswales.
- » Areas should be designed according to calculated runoff volume requirements for both the street and the streetscape.

### Considerations

- » Subsurface soil, geology, and groundwater table should be sampled and tested to ensure adequate drainage capacity.
- » Consider rain gardens in neighborhood areas between sidewalks and curbs or along trails in off-street segments. These features do not typically require special engineered sub soil.

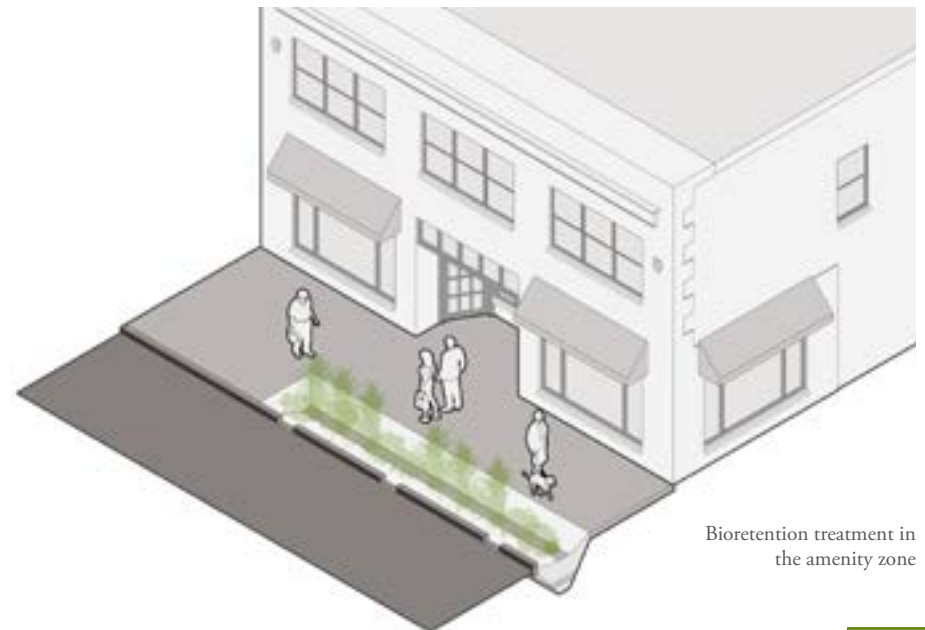

Bioretention treatment in the amenity zone

## Pervious Surfaces

Pervious paving (paving that allows water to pass into the ground) is an important component of green infrastructure, especially in urban areas where hardscape features are needed to provide access. In areas that require hardscape or paved surfaces, pervious paving can provide stormwater infiltration and prevent surface runoff. Since pervious paving allows snow and ice melt to infiltrate directly into the paving surface, pervious pavement can help eliminate puddling and freezing and may reduce winter salt and sand use. There are several types of paving materials and associated cost ranges. Initial installation costs may be offset by eliminating the need for installation of drainage structures and piping.

### Use

- » Where slopes do not exceed 5% and within:
  - » Gutter strips or parking lanes along the curb that are not used as traffic lanes or bus stops
  - » Tree trenches and amenity zone paving
  - » Bike lanes
  - » Public plazas and other public gathering spaces

### Design

- » Porous and pervious pavement surfaces should be stable, firm, and slip resistant.
- » Joints between pavers should not exceed a width of 0.5”.
- » Appropriate subsurface materials and depths to handle the runoff load of the design area should be used.

### Considerations

- » Consider surrounding materials and context when selecting paving materials and colors.
- » Soil testing and percolation rates should be used to inform subsurface material selection.
- » Underdrains should be used when necessary.

- » Porous surfaces should be vacuumed at a frequency based on the needs of the specific system when standing water is observed, or at least once a year. Vacuuming activities will be most effective during the springtime, after a winter thaw.
- » Maintenance commitments may be required—further coordination with Wastewater group needed.
- » Maintenance requirements and plans for maintenance should be considered as part of material selection.
- » Salt and sand should be limited on porous surfaces during winter months.



## Stormwater Tree Trenches

Stormwater tree trenches provide space to temporarily store and infiltrate stormwater runoff. Vegetation or tree box filters are small, individual structures while tree trenches are linear, continuous underground bioretention structures that provide a single structure to support multiple trees. These infrastructure features work by infiltrating stormwater below the surface into the boxes or trenches that contain special soil mixtures and subsurface aggregate materials that support tree growth while also allowing for water storage. The soil also irrigates trees and filters stormwater runoff, cleaning pollutants before allowing water to enter surrounding soil or conveying water to a drainage system. The surface material above the box or trench may be paved with accessible porous pavement or covered with tree grates that can be walked over. Soil cells should be used to support paving while allowing for expanded root growth.

### Use

- » Where paving or accessible surfaces are required for pedestrian access or street furniture between or surrounding street trees.
- » Areas where trees are planted among hardscaping elements such as sidewalks, plazas, and parking lots.
- » Vegetation or Tree Box Filters:
  - » Areas where utility or other underground structures constrain space and limit vegetation structure and growth.
  - » Areas where trees punctuate the streetscape or are intermittent.

### Design

- » Underdrains should be tied into traditional drainage systems or filtration areas for control of extreme stormwater inundation.
- » Stormwater should be directed to tree boxes through drain inlets in curbs or through sheet flow.
- » The number and dimensions of filters should be adjusted according to stormwater management goals for streetscape. Trench areas should be designed according to calculated runoff volume requirements for the streetscape.

- » ADA regulations concerning surface treatments and materials such as tree grates or pervious pavers within the pedestrian travel way should be followed.
- » Tree species should be specified in accordance with the recommended street tree list and site conditions.
- » Provide a continuous trench where possible to increase root growth zone.

### Considerations

- » Soil media should be installed once other site work is completed to prevent premature compaction and clogging.
- » Soil for trees should balance stormwater infiltration and long term plant growth.
- » A robust maintenance plan is necessary, and tree box filters and trenches should be maintained through routine trash removal, periodic soil inspections, and cleaning to prevent clogging once trees are established.
- » Consult the OCF for additional information.



Stormwater tree box filters

# Utilities



This illustration shows the typical placement of utilities within a new or reconstructed Denver street.

Notes:

1. Typical utility locations are shown; actual locations will vary depending on existing conditions.
2. Local electrical service to pedestrian lights and irrigation for streetscape improvements can be located behind the curb in the amenity zone.
3. Sanitary sewer to be a minimum of 10' from water mains and storm sewer. Recommend placing sanitary sewer in alleys whenever possible.
4. Gas main to be a minimum of 5' from water main.

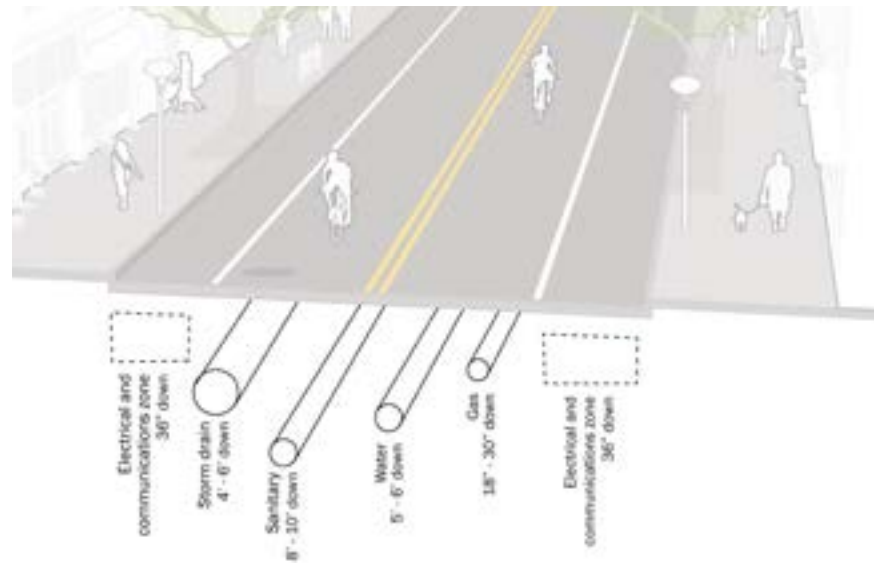

## General Guidance

Utilities are critical to the City, providing necessary services for residents and businesses and maintaining important communication links. Street corridors are the most efficient location to contain utilities. Consistent, well-planned locations of utilities can help designers avoid the challenges to street design and construction that can occur when utilities conflict with street improvements.

Thoughtful consideration of utilities during design will:

- » Minimize streetscape clutter providing a more cohesive appearance of street furnishings, lighting and trees.
- » Minimize impacts to existing trees and plantings.
- » Maximize space for new trees and plantings.
- » Minimize future cutting and trenching.
- » Maximize space for other utilities and service lines.
- » Possibly reduce long-term maintenance conflicts and costs.
- » Improve pedestrian safety.

Utilities should be placed to minimize disruption to pedestrians as well as providing access for maintenance and emergency vehicles. Guidelines for utilities within the public right-of-way include:

- » Utilities should be consolidated where feasible to maximize efficiency, minimize disruption to streetscape elements, and minimize access point. Locate utilities underground whenever possible.
- » Large utility vaults should be in the roadway or parking lane where access requirements allow it. Stormwater detention and water quality vaults should not be placed within the public right-of-way.
- » Above-ground features such as pedestals, transformers, switchboxes, meters, hydrants, and small vaults should be located behind the curb and outside of the right-of-way when possible and outside of tree protection zones and driplines. Ideally surface features should be clustered to avoid pedestrian disruption.

- » Proposed water lines, sanitary sewers and storm sewers should be installed at locations identified in the City and County of Denver’s Transportation Standards and Details. See Denver Water’s Engineering Standards and Capital Projects Construction Standards for more information.
- » In constrained conditions, consider placing electrical and communication utilities on the same side of the street or beneath the sidewalk within the right-of-way, outside of the amenity zone.
- » Utility vaults and boxes should be located outside of amenity zones whenever possible to maximize the planting area for trees and other vegetation.
- » If feasible, surface-mounted manholes, boxes, and vaults should be located outside the limits of curb ramp areas. Manhole covers are typically not slip-resistant and should not be considered part of the walkway.
- » Locate utilities within the street, under the curb, or under the back of walk—not under trees or stormwater elements.
- » If shallow utilities are unavoidable, planting areas may be limited to ground covers and low growing shrubs while avoiding trees.
- » Sewer laterals and water services should be installed as perpendicular to the face of curb as possible. When possible, water services should be installed 5-foot clear of trees or stormwater elements. In cases where overlap is unavoidable, service lines should be lowered (if necessary) and sleeved under any infiltrating stormwater facilities.
- » Installation of new raised medians or bulb outs with stormwater features or trees must account for existing utility impacts.
- » Consideration should also be made for impacts to surface drainage that could require providing a new storm inlet and or the relocation of an existing inlet resulting in potential utility impacts.

- » Private utilities, encroachments, etc. are not allowed in the Signal Equipment Clear Zone. Care should be taken with intersection Clear Zones to maintain access and operational efficiency for utilities.
- » When utility vaults or other non-linear installations occur the utility provider should consider site-specific conditions, impacts to existing structures and utilities, and soil conditions.
- » Final horizontal layout of any vaults will need to be adjusted based on actual site conditions during final design. When maintenance occurs, provide a method of handling traffic to keep workers safe.
- » Site-specific location of utilities will depend on the extent of construction occurring and should follow DOTI, Denver Wastewater and Denver Water Engineering Standards and Details, and Xcel Energy Utility Design Layout Guidelines.

Utilities should be located early in the design process. ASCE 38 subsurface utility engineering is required when excavating more than 2’ in depth. Depending on the level of design this could include contacting utility companies to obtain key maps, providing utility locates, and survey to subsurface utility engineering. Once utility information has been compiled a site walk is recommended to verify findings.

If a roadway is being reconstructed an area should be provided to consolidate utilities within a defined corridor, shared trench, or precast structure to minimize conflicts with street and water quality improvements. This may require language in franchise agreements with private utilities.

Other considerations for design, operations, and maintenance could include:

- » Utility related work should replace existing materials such as patterned concrete, brick pavers in kind.
- » Consider using “trenchless” technologies whenever possible to avoid excavation and disruption of streetscape facilities.

## Small Cell Towers

The City allows telecommunication companies to install numerous types of small cellular infrastructure installations (or small cell towers) within its right-of-way. These devices allow for faster cellular service as well as smart city technologies, which can control traffic signals to ease congestion, aid first responders, and increase efficiencies in electrical and utility services.

### Use

- » Small cell towers are typically installed in the amenity zone of the sidewalk corridor.
- » Revocable permits have been expressly granted and are subject to Terms and Conditions. City agencies have been involved in the both Utility Plan Review and Encroachment Permit Review for proposed cellular antenna poles and associated wiring/equipment within the public right-of-way.

### Design and Considerations

- » For more information on where small cell towers are allowed and where to locate them within the street space, consult the latest version of the City's *Small Cell Infrastructure Design Guidelines* and permit requirements.

### Additional Resources

- » [Small Cell Infrastructure Design Guidelines](#)
- » [Freestanding Small Cell Infrastructure Permit](#)
- » [City and County of Denver Small Cell Infrastructure Web Page](#)



## 4. Implementation and Maintenance

## Organizational Responsibilities

Roadway and sidewalk design projects in Denver are informed by the constraints and opportunities of working in a city with a mix of historic and modern construction, multiple jurisdictions and agencies, and a commitment to meaningful community and stakeholder engagement. This section outlines departmental responsibilities related to planning, design, construction, and management of the public right-of-way.

### Shared Responsibility by all Departments

Many departments within the City and County of Denver play a role related to design, function, and use of streets, whether it be within the public right-of-way or directly adjacent to it. These departments, including but not limited to Community Planning and Development, Denver Fire, Parks & Recreation, and DOTI, are committed to the success of the Complete Streets Design Guidelines and will take the following implementation steps:

- » Evaluate current standards, rules, and regulations to determine where conflicts and/or gaps with the Complete Streets Design Guidelines exist
- » Revise and/or create new standards, rules, and regulations where necessary to align with the Guidelines
- » Coordinate updates between departments to promote consistency and minimize conflicting direction
- » Work together with partners such as RTD, CDOT, Denver Water, and others to encourage consistency and alignment with the Complete Streets Design Guidelines

### Department of Transportation & Infrastructure

Denver DOTI is responsible for most aspects of street design. The Department has numerous divisions with staff that work on various aspects of implementing Complete Streets. These divisions include staff that specialize in planning and design, signal operations, project delivery, right-of-way services and enforcement, wastewater management, and street maintenance.

### Community Planning and Development

Community Planning and Development serves many functions related to streets within the city, including:

- » Comprehensive planning including citywide, neighborhood, district, corridor, and transit-oriented development planning
- » Zoning amendments and regulatory tools
- » Urban design and special projects
- » Permitting and development review

### Parks & Recreation

The Denver Parks & Recreation is the City agency responsible for trees in public parks, parkways, and other public property. Denver's street trees are under regulation of the City Forester, but their maintenance is a responsibility shared by adjacent property owners.

While the previous chapters of the Guidelines include elements of street design in Denver, this chapter covers the process of getting street projects implemented. Part of this work will be to update departmental standards, rules, and regulations that will be necessary to ultimately realize new Complete Streets projects. Partner agencies, private developers, and consultants are involved in the design and construction of streets, but the City and County of Denver has the primary responsibility for guiding and permitting street design and maintaining the streets. Thus, the City and County of Denver will require coordinated rules and regulations across multiple departments that are aligned with the vision and strategies described in the Complete Streets Design Guidelines. References in this document are relevant at the time of publication, and many associated rules and regulations will be updated over time to comply with this document.

## City Partners

The City and County of Denver has multiple partnering agencies including:

- » Regional Transportation District (RTD) is responsible for operating and maintaining bus and light rail and siting some furnishings at stops and stations.
- » Colorado Department of Transportation (CDOT) is responsible for operating and maintaining many state and US highways.
- » Denver Water is responsible for operating and maintaining water distribution lines and appurtenances.
- » Other utility companies, such as Xcel Energy, Comcast, and CenturyLink, are responsible for installing, operating, and maintaining electrical, gas, and communications utility infrastructure within the street.

## Project Types

Projects can vary in size and scope from large major corridor improvements to small maintenance projects. Often, projects can be phased to deliver quick, low-cost improvements in the short term while waiting for funding and leverage opportunities for major capital projects to make improvements more permanent. **All types of projects must comply with the Denver Complete Streets Design Guidelines.**

**Major corridor improvements** are the largest, most complicated, and most costly type of street project. These are often planned many years in advance and may rely on multiple funding sources which could include state or federal funds.

**CIP/bond projects** have been identified as part of the City and County of Denver's planning process and budgeted for in the Capital Improvement Program (CIP). These projects may include ADA updates, new sidewalks, bicycle lanes, or a combination of these elements. The City and County of Denver also typically funds projects through bond measures.

**Private developments** do not always change the public right-of-way. However, projects that have an increased impact on the public right-of-way, may require developers to perform a traffic study and/or make improvements to mitigate project impacts and bring the street frontage up to current standards. Additionally, for larger-scale developments, developers may be designing new streets. Because

development project right-of-way improvements are generally limited to the section of right-of-way directly adjacent to the project itself, the piecemeal implementation of changes to the full street cross-section may not always be possible or feasible with smaller developments.

**Retrofit projects** are generally smaller in scale and address a specific issue at an intersection or along a short section of roadway. These projects must be designed around significant constraints to keep costs manageable while bringing streets up to current right-of-way standards.

**Maintenance projects** are limited in their ability to significantly change the geometry of a street (e.g., modifications to the curb line), but can reallocate space through restriping. The City and County of Denver repaves roughly 10% of the City's streets each year, which often presents major opportunities to implement Complete Streets principles. Often, the City and County of Denver proactively upgrades curb ramps and crosswalks and designs bicycle facilities in conjunction with scheduled repaving and restriping projects. Repaving projects also provide opportunities to stripe curb extensions that narrow turning radii, narrow travel lanes to recommended widths to control vehicle speeds, and stripe reverse angled parking to narrow a roadway.

The City can also use a OneBuild approach to combine multiple projects into one bigger project to maximize economies of scale and minimize construction impacts. Striping and paving projects should coordinate with appropriate staff to ensure that these opportunities are not missed.

### Private Development's Role

A Site Development Plan (SDP) is required for major development projects, while certain large-scale, multi-block projects may also be required to go through Large Development Review (LDR) and/or submit an infrastructure master plan. Both of these processes require developers to submit concept plans, which are reviewed by City staff. These plans must be reviewed at the concept stage for compliance with the Complete Streets Design Guidelines to ensure that new streets and pedestrian realms are designed for the future.

## Addressing Typical Denver Situations

The following guidance will help the practitioner address these common street design situations in Denver:

- 1. One-way to two-way street conversions.** The City has numerous one-way multi-lane streets, particularly in or near downtown. While these streets have existed in Denver for decades, this design is often associated with higher vehicle speeds and increased crossing exposure for pedestrians. Some of these streets have already been converted to two-way, while others are planned for such conversions. Designers should use the information in Chapter 2 to guide the design of these streets. Practical considerations for two-way conversions include network-level traffic patterns, cost, traffic control impacts, traffic calming, and traffic safety.
- 2. Retrofitting streets with missing, narrow, and/or attached sidewalks.** Some parts of Denver have no sidewalks or narrow sidewalks that are directly attached to the curb, and in some cases even act as the drainage way. Narrow sidewalks do not meet current City standards. While designers should look for opportunities to upgrade sidewalks to current standard widths and detached conditions, the requirement for such action should be coordinated with the City; the feasibility of this upgrade will depend on the street project itself, as well as existing street trees. Interim or low-cost measures should be considered, such as on-street walkways, asphalt walkways that may extend into the travelway, or even shared street designs to provide more space for people walking and rolling.
- 3. Implementing street changes with limited budgets or on a demonstration basis.** While it is ideal to implement retrofits with premium materials, it is not always possible due to cost constraints. For this reason and to allow for maximum flexibility, the City and County of Denver has installed a number of lower-cost, quick-build Vision Zero and multimodal street treatments in recent years. Retrofitting streets with temporary or non-traditional materials is an important strategy in the City's implementation toolbox. Depending on the project definition and budget, the practitioner should look for creative ways to build streets and treatments with proven benefits. To ensure maintainability, operability for a range of users, and alignment with City standards, the practitioner should closely coordinate temporary or quick-build materials with DOTI staff. Implementation of temporary shared streets, such as those associated with COVID-19, is also a good example of a low-cost demonstration. The Supplemental to these Guidelines provides more details about temporary repurposed streets.



Asphalt walkway in Bellevue, WA



Quick-build walkway in Sunnyvale, CA

## Project Review Process

The City and County of Denver requires developer-led projects and City-led projects go through different review processes. The descriptions below include when the Complete Streets Design Guidelines shall be incorporated.

### Developer-Led Projects

For major developer-led projects the City and County of Denver requires a Site Development Plan (SDP) for new commercial construction and major additions for projects led by private developers. The SDP process includes three parts and the Complete Streets Design Guidelines should be consulted at each step to ensure compliance:

1. The initial submittal of a development concept;
2. Submittal and review of a formal SDP once the concept is approved; and
3. Approving and recording the final SDP.

Certain large projects may also be required to go through LDR and/or submit an infrastructure master plan. This process is designed to ensure these sites—which tend to be developed in phases over time—are given clear direction at the earliest stage of project planning on how they are expected to meet priorities important to Denver’s neighborhoods, including providing coordinated infrastructure improvements, publicly accessible open space, parkland, and quality design. During large development reviews, City staff will outline the regulatory or planning steps expected of new developments in order to stay consistent with the recommendations of *Blueprint Denver*, other adopted plans, and with the Complete Streets Design Guidelines.

### City-Led Projects

For City-led projects, the Right-of-Way Services Engineering Regulatory (ER) group and the Program Resource Office (PRO) provide programmatic oversight on all capital and bond-related projects in the City and County of Denver. ER is responsible for performing regulatory plan review and approvals for all proposed design and construction activities that are planned to occur in the City’s right-of-way. PRO is responsible for the administration of all RFQ/P and Construction Bid clearance processes. City-led projects will be reviewed to ensure adherence to the Complete Streets Design Guidelines.

## The Art of Retrofits

While the Guidelines and related City and County of Denver standards assume typical dimensions for each street type, we know that there are often exceptions. The issues caused by these exceptions have been exposed and exacerbated by recent land use changes in the city, but they are not solely related to that.

In the past, the pedestrian realm has often suffered in these situations. For example, sidewalks that may have been adequate for single family residential use no longer function as intended when alongside mixed-use development.

Complete Streets require a paradigm shift: approaching street design from the outside in. When existing street right-of-way width is substandard, practitioners should make every effort to meet Complete Streets goals and prioritize the most vulnerable street users. Practitioners should approach this as follows:

- » Use the Right-of-Way Allocation Priorities in Chapter 2 for guidance on what to prioritize within a given street space.
- » Meet all accessibility standards and maximize space for pedestrians. More square footage is desirable.
- » Explore opportunities to include street trees at regular intervals. The Office of the City Forester has published a series of planting details along with planting and tree protection specifications. Street trees and planting must be in conformance with these details except in a substandard street cross-section where exceptions to these requirements should be coordinated with the Office of the City Forester. Curb extensions located at intersections as well as at midblock crossings are opportunities to integrate street trees into constrained right-of-way.





## Design Exception Process

The Complete Streets Design Guidelines should be followed on all street design projects. If an exception needs to be made to follow the Guidelines, the request and its justification should be documented by the City project manager and coordinated with and approved by the appropriate City department or division.

## Maintenance Responsibilities

A strong systemic commitment to maintenance will ensure the longevity, dependability, and quality of Complete Streets. This section outlines maintenance considerations for seasonal maintenance, vegetation maintenance, maintenance of street amenities and art, and provision of temporary access during construction.

For new construction projects or retrofits, the following general maintenance best practices should be followed to ensure City operational staff are adequately prepared to maintain new components of the public right-of-way:

- » Begin developing maintenance plans during the planning and design stages of projects and coordinate with City departments and other stakeholders responsible for enforcing and carrying out maintenance practices.
- » Where necessary, prepare and execute maintenance agreements for elements of the public realm—such as parklets, planters, bus shelters, traffic signals, and public art—to ensure longevity and consistent quality. Encroachment permits are required for improvements in the right-of-way not owned by the City.
- » Consider materials, maintenance vehicle availability, resources for upkeep, and equipment needs for snow removal, sweeping, vegetation care, and general clean-up as design decisions are made to ensure feasibility of proper maintenance.
- » Carefully plan for seasonal maintenance requirements to ensure year-round accessibility and safety within the public realm.

## Who maintains the Public Right-of-Way?

Group	Maintenance Responsibilities
Denver DOTI	Responsible for the routine and seasonal upkeep of City-owned roadways and other elements including sewers and drainage structures, traffic control devices, parking meters, etc., and responsibilities per the City's Transit Amenity Program
Denver Parks & Recreation Department	Responsible for the maintenance of City-owned trees and some vegetation zones adjacent to parks and in parkways
CDOT	Responsible for routine and seasonal upkeep of some state-owned highways and rights-of-way. CDOT and the City and County of Denver have an agreement whereby the City maintains elements such as striping, signage, and signals on some state highways
RTD	Responsible for routine and seasonal upkeep of its right-of-way and RTD-owned bus shelters and stops, including snow removal on select transit lines, such as the bus islands on 18th Street downtown
Railroad Companies	Local and national rail companies maintain the railroad network in and around the Denver area
Property Owners	Responsible for maintenance and provision of sidewalks, curb cuts, and amenity zones (including trees) fronting their property, including snow removal of sidewalks in front of their properties
Improvement Districts	Responsible for maintenance of the public right-of-way through contracts with the City and County of Denver

## Seasonal Maintenance

Successful seasonal maintenance programs require knowledgeable staff and crews, proper equipment, and consistent procedures and preventative strategies.

### Seasonal Maintenance Planning

- » Develop proactive strategies including regular facility inspection, repair, replacement, and clear record-keeping to ensure seasonal maintenance practices are manageable and efficient.
- » Develop strategic assessment, prioritization, and maintenance plans to care for all elements of the public realm, including sidewalks, roadways, catch basins, vegetation, signage, traffic signals, lighting, trash and recycling bins, street furniture, and pavement markings.
- » Encourage the public to report issues and conditions via the City's 311 system.

### Snow Clearance

Adequate snow clearance is critical to maintaining accessible trails and roadways throughout the year.

- » Except in snow emergencies or unusually heavy snowfall, keep bike lanes and trails free of snow and ice.
- » Develop a communication plan to regularly remind property owners that they are responsible for clearing snow and ice from adjacent sidewalks within 24 hours of snow event.

### Prioritization

A balanced snow clearance prioritization strategy ensures that essential services—such as emergency access—are provided while also tending to the needs of the most vulnerable users of our streets. People walking and rolling—especially those with physical disabilities—require clear sidewalks, crossings, curb ramps, and transit stops in order to travel. This also pertains to keeping transit stops clear of snow and ice so that people can easily access transit vehicles. People riding bicycles or using other mobility options are more sensitive to snowfall than people driving due to smaller, thinner wheels and the need to maintain balance on their vehicles.

- » Establish a map of priority routes where emergency and multimodal access are most critical.

## Clearances

- » Maintain a minimum clear width of 4' per direction on protected bike lanes. On paved trails, provide a minimum clear path of 8'.
- » Maintain a minimum clear width of 3' per direction on sidewalks and pedestrian paths.

## Snow Storage

- » Use buffers and landscape areas for snow storage. Ensure adjacent pedestrian paths remain clear and that snow does not impede sight lines or block curb ramps at intersections and roadway crossings.
- » Consider the impacts of melting snow and resulting drainage as part of snow storage planning.

## Equipment

- » Use existing DOTI plowing equipment (8' and 9' blades attached to pickups and landscapers) on travelways that are at least 8' wide.
- » Procure special snow plowing equipment for bike lanes narrower than 8'.
- » Procure snow throwers to push snow farther off paths than possible with snowplows, if needed.
- » Consider procuring specialized equipment that can be outfitted with other attachments such as brooms, plow blades, snow throwers, and loaders.

## Ice Control Treatments

- » Treat bike lanes and shared use paths with salt, salt brine, or other ice control treatments to reduce icy and slippery conditions.
- » Consider porosity of pavement materials, adjacent landscape areas, wetlands, or other environmentally sensitive sites when selecting ice control treatments. Salt and brine may damage tree and vegetation roots. Environmentally friendly treatment options should be considered. Porous paving generally requires substantially reduced applications of ice control materials. Heavy use of sand may compromise the drainage capacity of these pavements.

- » When the temperature remains above 15 degrees F, use potassium chloride to prevent harm to humans or vegetation. Magnesium chloride releases 40% less chloride into the environment than rock salt or calcium chloride and continues to melt snow and ice until the temperature reaches -13 degrees F.
- » Continue ice control treatment after snowfall events, as snow can melt and refreeze.
- » If necessary, remove snow from buffer areas or improve capacity for drainage in areas where freezing is common.

## Street Sweeping and Debris Removal

Removal of sand and debris from trails and roadways is critical to maintaining high-quality travelways and reducing water pollution and sediment/debris from entering drainage system.

- » Include on-street bike lane facilities in regular sweeping schedules including:
  - » In the spring to remove accumulated winter sand, salt, and other debris and
  - » In the fall to prevent leaf buildup on in roadway gutters
- » Monitor off-street infrastructure on a regular basis to ensure prompt removal of debris and build-up.
- » Clean and remove debris from buffers between streets and protected bike lanes on a quarterly basis. In buffers where green infrastructure structures such as bioswales and infiltration systems are in place, debris clearance is especially important to ensure the system can perform stormwater management functions.

## Vegetation

Maintaining healthy street trees and other vegetation is critical to the beauty, sustainability, and resiliency of green infrastructure throughout the City. Care and maintenance of trees has been the foundation of Denver's street tree programs and a point of civic pride. Per City ordinance, adjacent landowners are responsible for maintaining street trees. This shared responsibility should be celebrated as a valuable relationship. Refer to the Office of the City Forester Tree Maintenance Requirements for more detailed information on tree and vegetation maintenance practices.

### Plant Material Selection And Siting

- » Select trees and plants for diversity and microclimate suitability based on their urban environment tolerance and maintenance properties. Group plants by hydrozone so each one gets no more or less water than required for optimal plant health.
- » Locate trees so that they don't block visibility of crosswalks or traffic control devices such as signs and traffic signals, but also coordinate spacing with the Office of the City Forester's guidelines.
- » Based on available space, work with the Office of the City Forester to select appropriate tree species to maximize environmental benefits.
- » Mulch planting areas to improve tree and soil health, but take care that it does not spill over into the sidewalk or gutters.
- » Soil health is the key to strong healthy plant material. Soil amendments should be based on soil test recommendations or four cubic yards per 1,000 square feet.
- » Based on available space, maximize soil volume for tree roots including use of new soil infrastructure technologies.
- » On routes with transit service, including RTD rail corridors, consult the latest RTD Design Guidelines for detailed information on tree clearance distances.

### Plant Material Maintenance

- » Planting and removal of street trees requires a permit from the Office of the City Forester prior to work.
- » When hiring a tree care professional, ensure they are licensed by the Office of the City Forester.
- » Include replacement of damaged or dead plant material in plans and budgets for routine maintenance.
- » Maintain trees and vegetation according to seasonal plant species requirements. Plants should be trimmed or pruned at the appropriate time of year for each specimen. Permits are required prior to any removal or trunk injection of City-owned trees. Contact the Office of the City Forester.
- » Maintain vegetation to ensure clear visibility for the safety of all users. Except for turfgrass or other low-growing groundcover, do not allow vegetation to encroach within 12" of the edge of pathways, 80" of vertical clearance over the sidewalk, or 13.5' over streets to allow for adequate user headroom and maintenance vehicles.

### Protection For Vegetation

- » Tree protection plans should be developed prior to construction activity near trees. Protection should include tree trunks, branches, the area under the canopy or 1.5 feet radially for every inch diameter, whichever is greater, as well as tree watering. Contact the Office of the City Forester to discuss tree protection plans.
- » Monitor sensitive and fragile ecosystems such as wetlands and riparian areas for invasive species. Successful removal of invasive species depends on prompt identification and appropriate removal procedures. Use current best practices and professional consultation in these cases.

## Maintaining Access During Construction

Private and City-led construction can create access and safety issues for all street users. Due to the time and effort required to make detours, people walking, riding bicycles, or using mobility devices are particularly sensitive to detours.

### Access

Maintain ADA-compliant accessibility throughout all construction zones. Use temporary ramps constructed of metal plates, wood, or asphalt as needed.

- » Temporary ramps should not be located near drainage structures.
  - » All slopes and ramps within pedestrian pathways should adhere to ADA accessibility guidelines.
  - » Contractors should ensure stormwater is able to enter the drainage system. If a ramp can only be placed such that it blocks drainage flow completely, a PVC pipe should be placed at the gutter to allow for flow. The pipe should be maintained by the contractor responsible for the project.
- » Ensure all project construction management plans are MUTCD-compliant.
- » Establish a plan for clear protocols and lines of communication between City staff, inspectors, project managers, consultants (if used by the project), and contractors to quickly address work zone access issues that emerge during construction for people walking, rolling, and riding bicycles.
- » Minimize vertical and horizontal deflection in construction management plans for all that will affect the public right-of-way. Provide a detour that is as close as possible to the normal path of travel. To the extent possible, the layout of the street should remain consistent throughout construction. Detours that require people walking, rolling, or riding bicycles to cross the street should be minimized, especially in locations where there are high volumes of people walking, rolling, and riding bicycles, and should comply with the latest City detour policies.
- » Where detours require channelization into a temporary path of travel within the street, detectable barriers should be used to ensure those with vision impairments can dependably use a cane to detect their path of travel.
- » Regular maintenance, including snow removal and sweeping, must be conducted by the contractor in construction zones. Construction-related debris must be cleared by the contractor.

### Signage

- » Provide clear signage ahead of construction sites indicating detours or other special conditions. If detours or route changes are necessary, these should be clearly signed throughout the detour route. Signage should use words that are understandable by low-literacy readers.
- » Signs and equipment must not be placed within paths, trails, and bike lanes or in any way that impedes ADA access on sidewalks.
- » Signage height should be appropriate for intended users. Signs and other devices mounted lower than 7' above the ground should not project more than 4" into the temporary path of travel, and cannot project into the path at all where the route's width is already at the minimum required by the Accessibility Guidelines.

### Art

Consider using art to offset feelings of disruption and annoyance for detoured travelers and adjacent residents and businesses. Project plans for temporary creative interventions on construction fencing or street paintings should be designed and approved by the City.



# Complete Streets Design Guidelines

