



Patterns

# AWS Prescriptive Guidance



# AWS Prescriptive Guidance: Patterns

Copyright © 2024 Amazon Web Services, Inc. and/or its affiliates. All rights reserved.

Amazon's trademarks and trade dress may not be used in connection with any product or service that is not Amazon's, in any manner that is likely to cause confusion among customers, or in any manner that disparages or discredits Amazon. All other trademarks not owned by Amazon are the property of their respective owners, who may or may not be affiliated with, connected to, or sponsored by Amazon.

# Table of Contents

<b>AWS Prescriptive Guidance patterns .....</b>	<b>1</b>
<b>Analytics .....</b>	<b>3</b>
Analyze Amazon Redshift data in Microsoft SQL Server Analysis Services .....	5
Summary .....	5
Prerequisites and limitations .....	5
Architecture .....	6
Tools .....	6
Epics .....	7
Related resources .....	8
.....	10
Summary .....	10
Prerequisites and limitations .....	10
Architecture .....	11
Tools .....	11
Epics .....	13
Related resources .....	17
Automate encryption enforcement in AWS Glue .....	18
Summary .....	18
Prerequisites and limitations .....	18
Architecture .....	18
Tools .....	20
Best practices .....	21
Epics .....	21
Related resources .....	23
Build a video processing pipeline .....	25
Summary .....	25
Prerequisites and limitations .....	25
Architecture .....	26
Tools .....	27
Epics .....	28
Related resources .....	35
Additional information .....	35
Attachments .....	36
Build an ETL pipeline from Amazon S3 to Amazon Redshift using AWS Glue .....	37

Summary .....	37
Prerequisites and limitations .....	37
Architecture .....	38
Tools .....	40
Epics .....	41
Related resources .....	47
Additional information .....	48
Calculate value at risk (VaR) by using AWS services .....	49
Summary .....	49
Prerequisites and limitations .....	50
Architecture .....	50
Tools .....	52
Best practices .....	53
Epics .....	53
Related resources .....	56
Convert NORMALIZE to Amazon Redshift SQL .....	57
Summary .....	57
Prerequisites and limitations .....	57
Architecture .....	58
Tools .....	58
Epics .....	63
Related resources .....	63
Convert RESET WHEN to Amazon Redshift SQL .....	65
Summary .....	65
Prerequisites and limitations .....	65
Architecture .....	66
Tools .....	66
Epics .....	70
Related resources .....	70
.....	72
Summary .....	72
Prerequisites and limitations .....	73
Architecture .....	73
Tools .....	74
Epics .....	75
Related resources .....	78

---

Attachments .....	78
Ensure Amazon EMR logging to Amazon S3 .....	79
Summary .....	79
Prerequisites and limitations .....	80
Architecture .....	80
Tools .....	81
Epics .....	82
Related resources .....	84
Attachments .....	84
Generate test data using AWS Glue .....	85
Summary .....	85
Prerequisites and limitations .....	85
Architecture .....	86
Tools .....	86
Best practices .....	87
Epics .....	88
Related resources .....	97
Additional information .....	98
Ingest IoT data directly into Amazon S3 .....	102
Summary .....	102
Prerequisites and limitations .....	102
Architecture .....	103
Tools .....	104
Best practices .....	104
Epics .....	105
Troubleshooting .....	111
Related resources .....	112
Additional information .....	113
Launch a Spark job in Amazon EMR using a Lambda function .....	117
Summary .....	117
Prerequisites and limitations .....	117
Architecture .....	118
Tools .....	119
Epics .....	119
Related resources .....	123
Additional information .....	123

Attachments .....	125
Migrate Apache Cassandra workloads to Amazon Keyspaces .....	126
Summary .....	126
Prerequisites and limitations .....	126
Architecture .....	127
Tools .....	128
Best practices .....	129
Epics .....	129
Troubleshooting .....	142
Related resources .....	142
Additional information .....	142
Migrate Oracle Business Intelligence 12C to the AWS Cloud .....	144
Summary .....	144
Prerequisites and limitations .....	144
Architecture .....	145
Tools .....	147
Epics .....	148
Related resources .....	160
Additional information .....	160
Migrate a Kafka cluster to Amazon MSK using MirrorMaker .....	165
Summary .....	165
Prerequisites and limitations .....	165
Architecture .....	166
Tools .....	167
Best practices .....	168
Epics .....	168
Related resources .....	171
Additional information .....	172
Migrate an ELK Stack to the AWS Cloud .....	173
Summary .....	173
Prerequisites and limitations .....	174
Architecture .....	175
Tools .....	178
Epics .....	179
Related resources .....	186
Additional information .....	188

Migrate data to AWS using Starburst .....	189
Summary .....	189
Prerequisites and limitations .....	189
Architecture .....	189
Tools .....	193
Epics .....	194
Related resources .....	197
Optimize the ETL ingestion of input file size .....	199
Summary .....	199
Prerequisites and limitations .....	199
Architecture .....	200
Tools .....	201
Epics .....	201
Related resources .....	204
Additional information .....	204
Orchestrate an ETL pipeline with AWS Step Functions .....	205
Summary .....	205
Prerequisites and limitations .....	205
Architecture .....	206
Tools .....	207
Epics .....	209
Troubleshooting .....	215
Related resources .....	215
Additional information .....	216
Perform ML analytics using Amazon Redshift ML .....	219
Summary .....	219
Prerequisites and limitations .....	219
Architecture .....	220
Tools .....	221
Epics .....	222
Related resources .....	225
Query DynamoDB tables using Athena .....	227
Summary .....	227
Prerequisites and limitations .....	227
Architecture .....	228
Tools .....	229

Epics .....	229
Related resources .....	238
Additional information .....	238
Set up a minimum viable data space .....	240
Summary .....	240
Prerequisites and limitations .....	241
Architecture .....	243
Tools .....	244
Best practices .....	245
Epics .....	246
Troubleshooting .....	300
Related resources .....	300
Additional information .....	300
Set up language-specific sorting for Amazon Redshift query results .....	305
Summary .....	305
Prerequisites and limitations .....	305
Architecture .....	306
Tools .....	306
Epics .....	306
Related resources .....	310
Additional information .....	311
Subscribe a Lambda function to event notifications from cross-Region S3 buckets .....	315
Summary .....	315
Prerequisites and limitations .....	315
Architecture .....	316
Tools .....	317
Epics .....	317
Related resources .....	321
Three AWS Glue job types for converting data .....	322
Summary .....	322
Prerequisites and limitations .....	322
Architecture .....	323
Tools .....	323
Epics .....	324
Related resources .....	326
Additional information .....	327



Attachments .....	333
Visualize Amazon Redshift audit logs using Athena and QuickSight .....	334
Summary .....	334
Prerequisites and limitations .....	334
Architecture .....	335
Tools .....	335
Epics .....	336
Related resources .....	339
Attachments .....	339
Visualize IAM credential reports using Amazon QuickSight .....	340
Summary .....	340
Prerequisites and limitations .....	341
Architecture .....	341
Tools .....	342
Epics .....	343
Additional information .....	348
More patterns .....	350
<b>Business productivity .....</b>	<b>352</b>
Set up a highly available PeopleSoft architecture on AWS .....	353
Summary .....	353
Prerequisites and limitations .....	353
Architecture .....	354
Tools .....	358
Best practices .....	359
Epics .....	362
Related resources .....	381
More patterns .....	382
<b>CloudNative .....</b>	<b>383</b>
Monitor SAP RHEL Pacemaker clusters .....	384
Summary .....	384
Prerequisites and limitations .....	384
Architecture .....	385
Tools .....	386
Best practices .....	387
Epics .....	387
Related resources .....	402

---

Attachments .....	403
Successfully import an S3 bucket as a CloudFormation stack .....	404
Summary .....	404
Prerequisites and limitations .....	404
Architecture .....	404
Epics .....	406
Related resources .....	414
Attachments .....	414
More patterns .....	415
<b>Containers &amp; microservices .....</b>	<b>417</b>
Access Amazon Neptune from Amazon EKS .....	419
Summary .....	419
Prerequisites and limitations .....	419
Architecture .....	420
Tools .....	421
Best practices .....	421
Epics .....	422
Troubleshooting .....	431
Related resources .....	431
Access container applications on Amazon ECS .....	432
Summary .....	432
Prerequisites and limitations .....	433
Architecture .....	433
Tools .....	435
Epics .....	436
Related resources .....	447
Access container applications on Amazon ECS with an AWS Fargate launch type .....	450
Summary .....	450
Prerequisites and limitations .....	451
Architecture .....	451
Tools .....	453
Epics .....	454
Related resources .....	464
Access container applications privately on Amazon EKS .....	467
Summary .....	467
Prerequisites and limitations .....	467

Architecture .....	468
Tools .....	469
Epics .....	469
Related resources .....	474
Activate mTLS in App Mesh on Amazon EKS .....	475
Summary .....	475
Prerequisites and limitations .....	475
Architecture .....	476
Tools .....	477
Epics .....	477
Related resources .....	481
Additional information .....	482
Automate backups for Amazon RDS for PostgreSQL DB instances .....	483
Summary .....	483
Prerequisites and limitations .....	484
Architecture .....	484
Tools .....	485
Epics .....	486
Related resources .....	492
Additional information .....	493
Automate deployment of Node Termination Handler .....	496
Summary .....	496
Prerequisites and limitations .....	497
Architecture .....	498
Tools .....	499
Best practices .....	500
Epics .....	500
Troubleshooting .....	508
Related resources .....	509
Additional information .....	509
Automatically build and deploy a Java application to Amazon EKS .....	511
Summary .....	511
Prerequisites and limitations .....	511
Architecture .....	512
Tools .....	514
Best practices .....	516

Epics .....	516
Related resources .....	533
Additional information .....	533
Create an Amazon ECS task definition on EC2 instances using Amazon EFS .....	535
Summary .....	535
Prerequisites and limitations .....	536
Architecture .....	536
Tools .....	538
Epics .....	538
Related resources .....	540
Attachments .....	541
Deploy Java microservices on Amazon ECS using AWS Fargate .....	542
Summary .....	542
Prerequisites and limitations .....	542
Architecture .....	542
Tools .....	544
Epics .....	545
Related resources .....	548
Deploy Java microservices on Amazon ECS using Amazon ECR and AWS Fargate .....	550
Summary .....	550
Prerequisites and limitations .....	550
Architecture .....	550
Tools .....	552
Epics .....	553
Related resources .....	558
Deploy Java microservices on Amazon ECS using Amazon ECR and load balancing .....	560
Summary .....	560
Prerequisites and limitations .....	561
Architecture .....	561
Tools .....	563
Epics .....	563
Related resources .....	564
Deploy Kubernetes packages using Amazon EKS and Helm .....	566
Summary .....	566
Prerequisites and limitations .....	566
Architecture .....	567

Tools .....	568
Epics .....	569
Related resources .....	577
Attachments .....	577
Deploy Lambda functions with container images .....	578
Summary .....	578
Prerequisites and limitations .....	578
Architecture .....	579
Tools .....	580
Best practices .....	580
Epics .....	581
Troubleshooting .....	584
Related resources .....	584
Additional information .....	585
Deploy a Java microservice on Amazon EKS and expose it with an Application Load Balancer .....	587
Summary .....	587
Prerequisites and limitations .....	587
Architecture .....	588
Tools .....	589
Epics .....	589
Related resources .....	595
Additional information .....	595
Deploy a clustered application to Amazon ECS by using AWS Copilot .....	599
Summary .....	599
Prerequisites and limitations .....	599
Architecture .....	600
Tools .....	601
Epics .....	602
Related resources .....	609
Deploy a gRPC-based application on Amazon EKS .....	610
Summary .....	610
Prerequisites and limitations .....	610
Architecture .....	611
Tools .....	613
Epics .....	614

Related resources .....	621
Additional information .....	621
Deploy and debug Amazon EKS clusters .....	624
Summary .....	624
Prerequisites and limitations .....	624
Architecture .....	625
Tools .....	626
Epics .....	627
Troubleshooting .....	649
Related resources .....	649
Additional information .....	650
Deploy containers by using Elastic Beanstalk .....	653
Summary .....	653
Prerequisites and limitations .....	654
Architecture .....	654
Tools .....	656
Epics .....	656
Related resources .....	659
Additional information .....	659
Generate a static outbound IP address using Lambda and Amazon VPC .....	660
Summary .....	660
Prerequisites and limitations .....	660
Architecture .....	661
Tools .....	662
Epics .....	662
Related resources .....	673
Identify duplicate container images automatically .....	674
Summary .....	674
Prerequisites and limitations .....	674
Architecture .....	675
Tools .....	678
Best practices .....	678
Epics .....	678
Troubleshooting .....	697
Related resources .....	698
Additional information .....	698

Install SSM Agent on Amazon EKS worker nodes .....	704
Summary .....	704
Prerequisites and limitations .....	704
Architecture .....	705
Tools .....	705
Epics .....	707
Related resources .....	709
Install the SSM Agent and CloudWatch agent on Amazon EKS worker nodes using preBootstrapCommands .....	710
Summary .....	710
Prerequisites and limitations .....	710
Architecture .....	711
Tools .....	712
Epics .....	712
Related resources .....	714
Additional information .....	714
Optimize generated Docker images .....	717
Summary .....	717
Prerequisites and limitations .....	717
Architecture .....	717
Tools .....	718
Epics .....	720
Related resources .....	727
Attachments .....	727
Place Kubernetes Pods on compatible nodes in Amazon EKS .....	728
Summary .....	728
Prerequisites and limitations .....	728
Architecture .....	729
Tools .....	731
Epics .....	732
Troubleshooting .....	742
Related resources .....	742
Additional information .....	743
Replicate filtered Amazon ECR container images across accounts or Regions .....	746
Summary .....	746
Prerequisites and limitations .....	746

---

Architecture .....	747
Tools .....	748
Epics .....	750
Related resources .....	761
Additional information .....	761
Attachments .....	762
Rotate credentials without restarting containers .....	763
Summary .....	763
Prerequisites and limitations .....	764
Architecture .....	764
Tools .....	766
Epics .....	768
Related resources .....	768
Attachments .....	769
Run Amazon ECS tasks on Amazon WorkSpaces .....	770
Summary .....	770
Prerequisites and limitations .....	770
Architecture .....	771
Tools .....	772
Epics .....	772
Related resources .....	779
Attachments .....	780
Run an ASP.NET web API Docker container on AWS .....	781
Summary .....	781
Prerequisites and limitations .....	781
Architecture .....	782
Tools .....	783
Epics .....	784
Related resources .....	792
Run message-driven workloads using AWS Fargate .....	793
Summary .....	793
Prerequisites and limitations .....	794
Architecture .....	794
Tools .....	795
Epics .....	796
Related resources .....	801



Run stateful workloads with persistent data storage .....	802
Summary .....	802
Prerequisites and limitations .....	803
Architecture .....	804
Tools .....	806
Best practices .....	807
Epics .....	808
Related resources .....	826
Additional information .....	827
More patterns .....	828
<b>Content delivery .....</b>	<b>829</b>
Send AWS WAF logs to Splunk using Firehose .....	830
Summary .....	830
Prerequisites and limitations .....	831
Architecture .....	831
Tools .....	833
Epics .....	833
Related resources .....	838
Serve static content in an S3 bucket through a VPC by using CloudFront .....	839
Summary .....	839
Prerequisites and limitations .....	839
Architecture .....	840
Tools .....	842
Epics .....	842
Related resources .....	846
Additional information .....	846
More patterns .....	849
<b>Cost management .....</b>	<b>850</b>
Create detailed cost and usage reports for AWS Glue jobs .....	851
Summary .....	851
Prerequisites and limitations .....	851
Architecture .....	851
Tools .....	852
Epics .....	853
Create detailed cost and usage reports for Amazon EMR clusters .....	857
Summary .....	857

Prerequisites and limitations .....	857
Architecture .....	857
Tools .....	858
Epics .....	859
More patterns .....	862
<b>Data lakes .....</b>	<b>863</b>
Automate data ingestion from AWS Data Exchange into Amazon S3 .....	864
Summary .....	864
Prerequisites and limitations .....	864
Architecture .....	865
Tools .....	866
Epics .....	867
Related resources .....	868
Attachments .....	868
Build a data pipeline to process Google Analytics data using the AWS DataOps Development Kit .....	869
Summary .....	869
Prerequisites and limitations .....	869
Architecture .....	870
Tools .....	871
Epics .....	872
Troubleshooting .....	874
Related resources .....	874
Additional information .....	874
Configure cross-account access to a shared AWS Glue Data Catalog using Athena .....	878
Summary .....	878
Prerequisites and limitations .....	878
Architecture .....	879
Tools .....	880
Epics .....	881
Related resources .....	893
Additional information .....	893
Deploy and manage a serverless data lake on AWS .....	894
Summary .....	894
Prerequisites and limitations .....	895
Architecture .....	895

---

Tools .....	898
Epics .....	899
Related resources .....	901
Migrate Hadoop data to Amazon S3 by using WANdisco LiveData Migrator .....	902
Summary .....	902
Prerequisites and limitations .....	902
Architecture .....	903
Epics .....	904
Related resources .....	910
Additional information .....	910
More patterns .....	911
<b>Databases .....</b>	<b>912</b>
Access on-premises SQL Server data using linked servers .....	914
Summary .....	914
Prerequisites and limitations .....	914
Architecture .....	914
Tools .....	915
Epics .....	916
Related resources .....	919
Additional information .....	919
Add HA to Oracle PeopleSoft on AWS .....	921
Summary .....	921
Prerequisites and limitations .....	922
Architecture .....	922
Tools .....	923
Best practices .....	924
Epics .....	924
Related resources .....	942
Additional information .....	942
Assess query performance for migrating SQL Server databases to MongoDB Atlas on AWS ...	945
Summary .....	945
Prerequisites and limitations .....	945
Architecture .....	946
Tools .....	948
Best practices .....	948
Epics .....	949

Related resources .....	954
Automate failover and failback with DR Orchestrator Framework .....	956
Summary .....	956
Prerequisites and limitations .....	956
Architecture .....	958
Tools .....	963
Epics .....	964
Related resources .....	985
Automate the replication of Amazon RDS instances across AWS accounts .....	986
Summary .....	986
Prerequisites and limitations .....	986
Architecture .....	987
Tools .....	989
Epics .....	990
Related resources .....	998
Additional information .....	998
Automatically back up SAP HANA databases .....	1001
Summary .....	1001
Prerequisites and limitations .....	1001
Architecture .....	1002
Tools .....	1003
Epics .....	1004
Related resources .....	1008
Block public access to Amazon RDS .....	1009
Summary .....	1009
Prerequisites and limitations .....	1010
Architecture .....	1010
Tools .....	1011
Epics .....	1012
Related resources .....	1015
Additional information .....	1015
Configure cross-account Amazon DynamoDB access .....	1017
Summary .....	1017
Prerequisites and limitations .....	1017
Architecture .....	1018
Tools .....	1020

Best practices .....	1020
Epics .....	1020
Troubleshooting .....	1030
Related resources .....	1030
Additional information .....	1030
Configure read-only routing in an Always On availability group .....	1032
Summary .....	1032
Prerequisites and limitations .....	1032
Architecture .....	1033
Tools .....	1035
Best practices .....	1035
Epics .....	1035
Troubleshooting .....	1039
Related resources .....	1040
Additional information .....	1040
Connect by using an SSH tunnel in pgAdmin .....	1042
Summary .....	1042
Prerequisites and limitations .....	1042
Architecture .....	1043
Tools .....	1043
Epics .....	1044
Related resources .....	1047
Convert JSON Oracle queries into PostgreSQL database SQL .....	1048
Summary .....	1048
Prerequisites and limitations .....	1048
Architecture .....	1049
Tools .....	1050
Best practices .....	1051
Epics .....	1051
Related resources .....	1055
Additional information .....	1056
Copy Amazon DynamoDB tables across accounts .....	1079
Summary .....	1079
Prerequisites and limitations .....	1079
Architecture .....	1079
Tools .....	1081

Epics .....	1081
Related resources .....	1085
Copy Amazon DynamoDB tables across accounts .....	1086
Summary .....	1086
Prerequisites and limitations .....	1087
Architecture .....	1087
Tools .....	1088
Best practices .....	1091
Epics .....	1091
Related resources .....	1097
Additional information .....	1097
Attachments .....	1098
Create cost and usage reports for Amazon RDS and Amazon Aurora .....	1099
Summary .....	1099
Prerequisites and limitations .....	1099
Architecture .....	1099
Tools .....	1101
Epics .....	1102
Related resources .....	1105
Emulate Oracle RAC workloads using Aurora PostgreSQL .....	1107
Summary .....	1107
Prerequisites and limitations .....	1107
Architecture .....	1108
Tools .....	1110
Epics .....	1111
Related resources .....	1114
Enable encrypted connections for PostgreSQL DB instances .....	1115
Summary .....	1115
Prerequisites and limitations .....	1115
Architecture .....	1115
Tools .....	1116
Best practices .....	1116
Epics .....	1117
Troubleshooting .....	1123
Related resources .....	1123
Encrypt an existing Amazon RDS for PostgreSQL DB instance .....	1124

Summary .....	1124
Prerequisites and limitations .....	1124
Architecture .....	1125
Tools .....	1126
Epics .....	1127
Related resources .....	1131
Additional information .....	1131
Enforce automatic tagging of Amazon RDS databases at launch .....	1133
Summary .....	1133
Prerequisites and limitations .....	1133
Architecture .....	1134
Tools .....	1134
Epics .....	1135
Related resources .....	1137
Attachments .....	1138
Estimate DynamoDB costs .....	1139
Summary .....	1139
Prerequisites and limitations .....	1140
Tools .....	1140
Best practices .....	1140
Epics .....	1141
Related resources .....	1146
Additional information .....	1146
Attachments .....	1150
Estimate storage costs for an Amazon DynamoDB table .....	1151
Summary .....	1151
Prerequisites and limitations .....	1152
Tools .....	1152
Epics .....	1153
Related resources .....	1154
Additional information .....	1154
Attachments .....	1155
Estimate the Amazon RDS engine size for an Oracle database using AWR reports .....	1156
Summary .....	1156
Prerequisites and limitations .....	1156
Architecture .....	1157

---

Tools .....	1157
Best practices .....	1158
Epics .....	1158
Related resources .....	1184
Export Amazon RDS for SQL Server tables to an S3 bucket .....	1185
Summary .....	1185
Prerequisites and limitations .....	1186
Architecture .....	1186
Tools .....	1187
Epics .....	1188
Related resources .....	1195
Additional information .....	1195
Handle anonymous blocks in Dynamic SQL statements .....	1197
Summary .....	1197
Prerequisites and limitations .....	1197
Architecture .....	1198
Tools .....	1199
Epics .....	1200
Related resources .....	1203
Additional information .....	1203
Handle overloaded Oracle functions in Aurora PostgreSQL-Compatible .....	1206
Summary .....	1206
Prerequisites and limitations .....	1206
Tools .....	1207
Epics .....	1207
Related resources .....	1212
Help enforce DynamoDB tagging .....	1213
Summary .....	1213
Prerequisites and limitations .....	1213
Architecture .....	1214
Tools .....	1214
Epics .....	1215
Related resources .....	1218
Attachments .....	1218
Implement cross-Region DR .....	1219
Summary .....	1219



Prerequisites and limitations .....	1219
Architecture .....	1220
Tools .....	1221
Epics .....	1222
Related resources .....	1234
Additional information .....	1235
Migrate 100+ argument Oracle functions to PostgreSQL .....	1236
Summary .....	1236
Prerequisites and limitations .....	1236
Architecture .....	1237
Tools .....	1237
Best practices .....	1238
Epics .....	1238
Troubleshooting .....	1240
Related resources .....	1240
Additional information .....	1240
Migrate Amazon RDS for Oracle DB instances to AMS accounts .....	1242
Summary .....	1242
Prerequisites and limitations .....	1242
Architecture .....	1243
Tools .....	1245
Epics .....	1245
Related resources .....	1250
Additional information .....	1251
Migrate Oracle OUT bind variables to PostgreSQL .....	1252
Summary .....	1252
Prerequisites and limitations .....	1253
Architecture .....	1253
Tools .....	1254
Epics .....	1255
Related resources .....	1256
Additional information .....	1256
Migrate SAP HANA to AWS using HSR .....	1261
Summary .....	1261
Prerequisites and limitations .....	1262
Architecture .....	1263

---

Tools .....	1266
Epics .....	1267
Related resources .....	1274
Additional information .....	1274
Migrate SQL Server to AWS using distributed availability groups .....	1276
Summary .....	1276
Prerequisites and limitations .....	1276
Architecture .....	1277
Tools .....	1278
Epics .....	1279
Related resources .....	1287
Migrate from Oracle 8i or 9i to Amazon RDS for Oracle using SharePlex and AWS DMS .....	1288
Summary .....	1288
Prerequisites and limitations .....	1288
Architecture .....	1289
Tools .....	1291
Epics .....	1291
Related resources .....	1296
Monitor Amazon Aurora for encryption .....	1297
Summary .....	1297
Prerequisites and limitations .....	1297
Architecture .....	1298
Tools .....	1299
Epics .....	1299
Related resources .....	1302
Attachments .....	1302
Monitor GoldenGate logs by using Amazon CloudWatch .....	1303
Summary .....	1303
Prerequisites and limitations .....	1303
Architecture .....	1304
Tools .....	1304
Epics .....	1305
Troubleshooting .....	1315
Related resources .....	1315
Replatform Oracle Database EE to Amazon RDS for Oracle SE2 .....	1316
Summary .....	1316

Prerequisites and limitations .....	1316
Architecture .....	1317
Tools .....	1319
Epics .....	1320
Related resources .....	1326
Replicate mainframe databases to AWS by using Precisely Connect .....	1327
Summary .....	1327
Prerequisites and limitations .....	1327
Architecture .....	1328
Tools .....	1334
Best practices .....	1335
Epics .....	1335
Related resources .....	1348
Schedule jobs for Amazon RDS and Aurora PostgreSQL .....	1350
Summary .....	1350
Prerequisites and limitations .....	1350
Architecture .....	1351
Tools .....	1352
Epics .....	1353
Related resources .....	1356
Secure user access in a Db2 federation database .....	1357
Summary .....	1357
Prerequisites and limitations .....	1357
Architecture .....	1358
Tools .....	1358
Epics .....	1359
Related resources .....	1364
Additional information .....	1364
Send notifications for RDS for SQL Server using an on-premises SMTP server .....	1366
Summary .....	1366
Prerequisites and limitations .....	1366
Architecture .....	1367
Tools .....	1368
Epics .....	1369
Related resources .....	1378
Set up DR for SAP on IBM Db2 on AWS .....	1379

---

Summary .....	1379
Prerequisites and limitations .....	1379
Architecture .....	1380
Tools .....	1381
Best practices .....	1382
Epics .....	1382
Troubleshooting .....	1399
Related resources .....	1400
Additional information .....	1400
Set up a CI/CD pipeline for database migration by using Terraform .....	1401
Summary .....	1401
Prerequisites and limitations .....	1402
Architecture .....	1402
Tools .....	1404
Best practices .....	1405
Epics .....	1406
Related resources .....	1410
Set up an HA/DR architecture for Oracle E-Business Suite on Amazon RDS Custom .....	1412
Summary .....	1412
Prerequisites and limitations .....	1412
Architecture .....	1413
Tools .....	1415
Epics .....	1415
Related resources .....	1419
Set up data replication between RDS for MySQL and MySQL on Amazon EC2 .....	1421
Summary .....	1421
Prerequisites and limitations .....	1421
Architecture .....	1422
Tools .....	1422
Epics .....	1423
Related resources .....	1427
Transition roles for an Oracle PeopleSoft application .....	1428
Summary .....	1428
Prerequisites and limitations .....	1428
Architecture .....	1429
Tools .....	1430

---

Best practices .....	1430
Epics .....	1430
Related resources .....	1462
Unload data from Amazon Redshift across accounts .....	1463
Summary .....	1463
Prerequisites and limitations .....	1464
Architecture .....	1464
Tools .....	1467
Best practices .....	1468
Epics .....	1469
Related resources .....	1490
Additional information .....	1491
Database migration patterns by workload .....	1492
IBM .....	1493
Microsoft .....	1494
N/A .....	1496
Open-source .....	1497
Oracle .....	1498
SAP .....	1501
More patterns .....	1502
<b>DevOps .....</b>	<b>1507</b>
Automate AWS resource assessment .....	1510
Summary .....	1510
Prerequisites and limitations .....	1511
Architecture .....	1511
Tools .....	1513
Best practices .....	1514
Epics .....	1514
Troubleshooting .....	1523
Related resources .....	1523
Additional information .....	1523
Automate SAP systems installation .....	1525
Summary .....	1525
Prerequisites and limitations .....	1525
Architecture .....	1526
Tools .....	1528

---

Epics .....	1529
Related resources .....	1536
Automate Service Catalog portfolio and product deployment using AWS CDK .....	1537
Summary .....	1537
Prerequisites and limitations .....	1538
Architecture .....	1538
Tools .....	1540
Best practices .....	1541
Epics .....	1541
Related resources .....	1553
Additional information .....	1553
Automate backups from AWS CodeCommit to Amazon S3 .....	1556
Summary .....	1556
Prerequisites and limitations .....	1556
Architecture .....	1557
Tools .....	1558
Epics .....	1558
Related resources .....	1561
Additional information .....	1561
Automate stack set deployment by using AWS CodePipeline and AWS CodeBuild .....	1564
Summary .....	1564
Prerequisites and limitations .....	1565
Architecture .....	1565
Tools .....	1567
Best practices .....	1568
Epics .....	1568
Troubleshooting .....	1585
Related resources .....	1586
Additional information .....	1586
Automatically attach a managed policy for Systems Manager to EC2 instance profiles .....	1595
Summary .....	1595
Prerequisites and limitations .....	1596
Architecture .....	1597
Tools .....	1599
Epics .....	1600
Related resources .....	1611

Attachments .....	1611
Automatically build CI/CD pipelines and Amazon ECS clusters for microservices .....	1612
Summary .....	1612
Prerequisites and limitations .....	1612
Architecture .....	1613
Tools .....	1615
Epics .....	1615
Related resources .....	1623
Additional information .....	1624
Attachments .....	1624
Build a loosely coupled architecture with microservices .....	1625
Summary .....	1625
Prerequisites and limitations .....	1625
Architecture .....	1626
Tools .....	1627
Best practices .....	1628
Epics .....	1628
Related resources .....	1636
Additional information .....	1637
Build and push Docker images to Amazon ECR .....	1638
Summary .....	1638
Prerequisites and limitations .....	1638
Architecture .....	1639
Tools .....	1640
Best practices .....	1640
Epics .....	1641
Troubleshooting .....	1644
Related resources .....	1645
Build and test iOS apps with AWS services .....	1646
Summary .....	1646
Prerequisites and limitations .....	1646
Architecture .....	1647
Tools .....	1648
Epics .....	1649
Related resources .....	1651

Check AWS CDK applications or CloudFormation templates for best practices by using rule packs .....	1653
Summary .....	1653
Prerequisites and limitations .....	1654
Tools .....	1654
Epics .....	1654
Related resources .....	1657
Configure mutual TLS for applications on Amazon EKS .....	1658
Summary .....	1658
Prerequisites and limitations .....	1658
Architecture .....	1659
Tools .....	1660
Epics .....	1660
Related resources .....	1668
Create a custom log parser for Amazon ECS using Firelens .....	1669
Summary .....	1669
Prerequisites and limitations .....	1669
Architecture .....	1670
Tools .....	1670
Epics .....	1671
Related resources .....	1678
Attachments .....	1678
Create a pipeline and AMI using CodePipeline and HashiCorp Packer .....	1679
Summary .....	1679
Prerequisites and limitations .....	1679
Architecture .....	1679
Tools .....	1681
Epics .....	1681
Related resources .....	1685
Attachments .....	1685
Create a pipeline and deploy updates to on-premises EC2 instances using CodePipeline .....	1686
Summary .....	1686
Prerequisites and limitations .....	1686
Architecture .....	1687
Tools .....	1688
Epics .....	1689



Related resources .....	1694
Attachments .....	1694
Create dynamic CI pipelines for Java and Python projects .....	1695
Summary .....	1695
Prerequisites and limitations .....	1695
Architecture .....	1696
Tools .....	1698
Best practices .....	1699
Epics .....	1700
Related resources .....	1710
Deploy CloudWatch Synthetics canaries .....	1711
Summary .....	1711
Prerequisites and limitations .....	1711
Architecture .....	1712
Tools .....	1713
Epics .....	1714
Troubleshooting .....	1717
Related resources .....	1717
Additional information .....	1718
Deploy a CI/CD pipeline for Java microservices on Amazon ECS .....	1720
Summary .....	1720
Prerequisites and limitations .....	1720
Architecture .....	1720
Tools .....	1723
Epics .....	1724
Related resources .....	1729
Deploy a CI/CD pipeline in multiple AWS accounts .....	1730
Summary .....	1730
Prerequisites and limitations .....	1731
Architecture .....	1731
Tools .....	1732
Epics .....	1732
Related resources .....	1735
Deploy a ChatOps solution to manage SAST scan results .....	1737
Summary .....	1737
Prerequisites and limitations .....	1738

Architecture .....	1739
Tools .....	1743
Best practices .....	1744
Epics .....	1745
Troubleshooting .....	1752
Related resources .....	1753
Additional information .....	1754
Deploy a firewall using AWS Network Firewall and AWS Transit Gateway .....	1756
Summary .....	1756
Prerequisites and limitations .....	1756
Architecture .....	1757
Tools .....	1758
Epics .....	1758
Related resources .....	1768
.....	1769
Summary .....	1769
Prerequisites and limitations .....	1769
Architecture .....	1770
Tools .....	1772
Epics .....	1772
Related resources .....	1773
Attachments .....	1774
Deploy an Amazon EKS cluster from AWS Cloud9 using an EC2 instance profile .....	1775
Summary .....	1775
Prerequisites and limitations .....	1775
Architecture .....	1776
Tools .....	1777
Epics .....	1777
Related resources .....	1787
Attachments .....	1787
Deploy code in multiple AWS Regions .....	1788
Summary .....	1788
Prerequisites and limitations .....	1788
Architecture .....	1789
Tools .....	1790
Epics .....	1791

Related resources .....	1799
Attachments .....	1800
Execute Amazon Redshift SQL queries .....	1801
Summary .....	1801
Prerequisites and limitations .....	1801
Architecture .....	1802
Tools .....	1803
Best practices .....	1804
Epics .....	1804
Related resources .....	1808
Additional information .....	1808
Export AWS Backup reports as a CSV file .....	1814
Summary .....	1814
Prerequisites and limitations .....	1814
Architecture .....	1815
Tools .....	1816
Best practices .....	1817
Epics .....	1817
Related resources .....	1823
Export Amazon EC2 instance tags to a CSV file .....	1824
Summary .....	1824
Prerequisites and limitations .....	1824
Tools .....	1825
Epics .....	1825
Related resources .....	1830
Generate an AWS CloudFormation template containing AWS Config managed rules .....	1831
Summary .....	1831
Prerequisites and limitations .....	1831
Epics .....	1832
Attachments .....	1837
Give SageMaker notebook instances cross-account access to a CodeCommit repository .....	1838
Summary .....	1838
Prerequisites and limitations .....	1838
Architecture .....	1839
Tools .....	1840
Best practices .....	1840

---

Epics .....	1841
Related resources .....	1847
Additional information .....	1847
Implement a GitHub Flow branching strategy .....	1849
Summary .....	1849
Prerequisites and limitations .....	1850
Architecture .....	1850
Tools .....	1852
Best practices .....	1853
Epics .....	1853
Troubleshooting .....	1858
Related resources .....	1858
Implement a Gitflow branching strategy .....	1860
Summary .....	1860
Prerequisites and limitations .....	1861
Architecture .....	1861
Tools .....	1863
Best practices .....	1864
Epics .....	1864
Troubleshooting .....	1871
Related resources .....	1872
Implement a Trunk branching strategy .....	1874
Summary .....	1874
Prerequisites and limitations .....	1875
Architecture .....	1875
Tools .....	1877
Best practices .....	1878
Epics .....	1878
Troubleshooting .....	1880
Related resources .....	1880
Implement centralized custom Checkov scanning .....	1881
Summary .....	1881
Prerequisites and limitations .....	1881
Architecture .....	1882
Tools .....	1883
Best practices .....	1883

Epics .....	1884
Related resources .....	1890
Additional information .....	1890
Initiate different CI/CD pipelines after detecting changes in a monorepo .....	1892
Summary .....	1892
Prerequisites and limitations .....	1893
Architecture .....	1893
Tools .....	1896
Best practices .....	1896
Epics .....	1897
Troubleshooting .....	1904
Related resources .....	1908
Integrate a Bitbucket repository with AWS Amplify .....	1909
Summary .....	1909
Prerequisites and limitations .....	1909
Architecture .....	1909
Tools .....	1910
Epics .....	1911
Related resources .....	1917
Attachments .....	1917
Launch a CodeBuild project across AWS accounts using Lambda .....	1918
Summary .....	1918
Prerequisites and limitations .....	1918
Architecture .....	1919
Tools .....	1921
Best practices .....	1922
Epics .....	1922
Troubleshooting .....	1931
Manage blue/green deployments of microservices to multiple accounts and Regions .....	1933
Summary .....	1933
Prerequisites and limitations .....	1934
Architecture .....	1935
Tools .....	1936
Epics .....	1937
Troubleshooting .....	1967
Related resources .....	1967

Monitor Amazon ECR repositories for wildcard permissions .....	1968
Summary .....	1968
Prerequisites and limitations .....	1968
Architecture .....	1969
Tools .....	1971
Epics .....	1972
Attachments .....	1973
Perform custom actions from AWS CodeCommit events .....	1974
Summary .....	1974
Prerequisites and limitations .....	1974
Architecture .....	1974
Tools .....	1975
Epics .....	1976
Related resources .....	1978
Publish Amazon CloudWatch metrics to a CSV file .....	1979
Summary .....	1979
Prerequisites and limitations .....	1979
Tools .....	1980
Epics .....	1980
Related resources .....	1982
Additional information .....	1983
Attachments .....	1984
Remove Amazon EC2 entries in same AWS account from AWS Managed Microsoft AD .....	1985
Summary .....	1985
Prerequisites and limitations .....	1986
Architecture .....	1986
Tools .....	1988
Best practices .....	1989
Epics .....	1990
Troubleshooting .....	1994
Related resources .....	1995
Run unit tests for Python ETL jobs in AWS Glue .....	1996
Summary .....	1996
Prerequisites and limitations .....	1996
Architecture .....	1997
Tools .....	1999

Best practices .....	2000
Epics .....	2000
Troubleshooting .....	2006
Related resources .....	2008
Additional information .....	2008
Set up Helm v3 charts in Amazon S3 .....	2009
Summary .....	2009
Prerequisites and limitations .....	2009
Architecture .....	2010
Tools .....	2011
Epics .....	2012
Related resources .....	2018
Set up a CI/CD pipeline with CodePipeline .....	2019
Home .....	2019
Prerequisites and limitations .....	2020
Architecture .....	2021
Tools .....	2022
Best practices .....	2023
Epics .....	2023
Troubleshooting .....	2033
Related resources .....	2034
Set up end-to-end encryption for applications on Amazon EKS .....	2035
Summary .....	2035
Prerequisites and limitations .....	2036
Architecture .....	2037
Tools .....	2038
Epics .....	2039
Related resources .....	2047
Simplify Amazon EKS multi-tenant application deployment .....	2048
Summary .....	2048
Prerequisites and limitations .....	2049
Architecture .....	2050
Tools .....	2052
Best practices .....	2053
Epics .....	2054
Troubleshooting .....	2068

---

Related resources .....	2069
Additional information .....	2069
Subscribe multiple email endpoints to an SNS topic .....	2070
Summary .....	2070
Prerequisites and limitations .....	2070
Architecture .....	2071
Tools .....	2071
Epics .....	2072
Related resources .....	2074
Attachments .....	2074
Use Serverspec for test-driven development .....	2075
Summary .....	2075
Prerequisites and limitations .....	2076
Architecture .....	2076
Tools .....	2077
Epics .....	2078
Related resources .....	2080
Additional information .....	2080
Attachments .....	2082
Use third-party Git repos in AWS CodePipeline .....	2083
Summary .....	2083
Prerequisites and limitations .....	2084
Architecture .....	2084
Tools .....	2085
Epics .....	2086
Related resources .....	2091
Validate Terraform configurations by using AWS CodePipeline .....	2093
Summary .....	2093
Prerequisites and limitations .....	2094
Architecture .....	2094
Tools .....	2096
Epics .....	2097
Troubleshooting .....	2106
Related resources .....	2106
Additional information .....	2106
More patterns .....	2109



<b>DevelopmentAndTesting</b> .....	<b>2112</b>
Automatically generate PynamoDB models and CRUD functions for DynamoDB .....	2113
Summary .....	2113
Prerequisites and limitations .....	2114
Architecture .....	2114
Tools .....	2116
Epics .....	2117
Related resources .....	2120
Additional information .....	2120
Structure a Python project in hexagonal architecture .....	2122
Summary .....	2122
Prerequisites and limitations .....	2122
Architecture .....	2123
Tools .....	2125
Best practices .....	2125
Epics .....	2126
Related resources .....	2146
More patterns .....	2148
<b>End-user computing</b> .....	<b>2149</b>
Create AppStream 2.0 resources using AWS CloudFormation .....	2150
Summary .....	2150
Prerequisites and limitations .....	2150
Architecture .....	2151
Tools .....	2151
Epics .....	2152
Related resources .....	2153
Additional information .....	2154
More patterns .....	2156
<b>High-performance computing</b> .....	<b>2157</b>
Deploy a Lustre file system by using Terraform and DRA .....	2158
Summary .....	2158
Prerequisites and limitations .....	2159
Architecture .....	2159
Tools .....	2161
Best practices .....	2161
Epics .....	2162

Troubleshooting .....	2166
Related resources .....	2166
Set up a Grafana monitoring dashboard for AWS ParallelCluster .....	2167
Summary .....	2167
Prerequisites and limitations .....	2168
Architecture .....	2168
Tools .....	2170
Epics .....	2171
Troubleshooting .....	2180
Related resources .....	2180
Set up an auto scaling VDI using NICE DCV .....	2182
Summary .....	2182
Prerequisites and limitations .....	2182
Architecture .....	2183
Tools .....	2184
Epics .....	2185
Troubleshooting .....	2196
Related resources .....	2196
<b>Hybrid cloud .....</b>	<b>2197</b>
Configure a data center extension to VMware Cloud on AWS .....	2198
Summary .....	2198
Prerequisites and limitations .....	2198
Architecture .....	2200
Tools .....	2201
Epics .....	2201
Related resources .....	2203
Configure vRealize Automation to provision VMs on VMware Cloud on AWS .....	2204
Summary .....	2204
Prerequisites and limitations .....	2204
Architecture .....	2206
Tools .....	2207
Epics .....	2208
Related resources .....	2214
Deploy an SDDC by using VMware Cloud on AWS .....	2215
Summary .....	2215
Prerequisites and limitations .....	2215

---

Architecture .....	2216
Tools .....	2217
Epics .....	2217
Related resources .....	2223
Integrate VMware vRealize Network Insight with VMware Cloud on AWS .....	2225
Summary .....	2225
Prerequisites and limitations .....	2226
Architecture .....	2226
Tools .....	2227
Epics .....	2227
Related resources .....	2230
Migrate VMs to VMware Cloud on AWS by using HCX OSAM .....	2231
Summary .....	2231
Prerequisites and limitations .....	2231
Architecture .....	2232
Tools .....	2233
Epics .....	2234
Related resources .....	2236
Send logs from VMware Cloud on AWS to Splunk .....	2237
Summary .....	2237
Prerequisites and limitations .....	2238
Architecture .....	2238
Tools .....	2239
Epics .....	2240
Related resources .....	2243
Set up a CI/CD pipeline for hybrid workloads on Amazon ECS Anywhere .....	2244
Summary .....	2244
Prerequisites and limitations .....	2244
Architecture .....	2245
Tools .....	2247
Best practices .....	2248
Epics .....	2249
Troubleshooting .....	2261
Related resources .....	2262
More patterns .....	2263
<b>Infrastructure .....</b>	<b>2264</b>

Access a bastion host using Session Manager and Amazon EC2 Instance Connect .....	2265
Summary .....	2265
Prerequisites and limitations .....	2266
Architecture .....	2267
Tools .....	2269
Best practices .....	2270
Epics .....	2271
Troubleshooting .....	2279
Related resources .....	2280
Additional information .....	2280
Centralize DNS resolution by using AWS Managed Microsoft AD .....	2282
Summary .....	2282
Prerequisites and limitations .....	2282
Architecture .....	2283
Tools .....	2284
Epics .....	2285
Related resources .....	2292
Centralize monitoring by using Observability Access Manager .....	2294
Summary .....	2294
Prerequisites and limitations .....	2295
Architecture .....	2296
Tools .....	2297
Best practices .....	2298
Epics .....	2298
Related resources .....	2307
Check EC2 instances for mandatory tags at launch .....	2309
Summary .....	2309
Prerequisites and limitations .....	2309
Architecture .....	2310
Tools .....	2310
Epics .....	2311
Related resources .....	2314
Attachments .....	2314
Connect to an EC2 instance using Session Manager .....	2315
Summary .....	2315
Prerequisites and limitations .....	2315

---

Architecture .....	2316
Tools .....	2318
Best practices .....	2318
Epics .....	2319
Troubleshooting .....	2322
Related resources .....	2322
Create a pipeline in AWS Regions that don't support AWS CodePipeline .....	2324
Summary .....	2324
Prerequisites and limitations .....	2324
Architecture .....	2325
Tools .....	2326
Epics .....	2326
Related resources .....	2331
Deploy a Cassandra cluster on Amazon EC2 with private static IPs .....	2332
Summary .....	2332
Prerequisites and limitations .....	2332
Architecture .....	2333
Epics .....	2335
Related resources .....	2339
Extend VRFs to AWS using Transit Gateway Connect .....	2340
Summary .....	2340
Prerequisites and limitations .....	2341
Architecture .....	2341
Tools .....	2346
Epics .....	2346
Related resources .....	2356
Attachments .....	2357
Get Amazon SNS notifications for state changes to AWS KMS keys .....	2358
Summary .....	2358
Prerequisites and limitations .....	2358
Architecture .....	2359
Tools .....	2360
Epics .....	2361
Related resources .....	2364
Additional information .....	2364
Modernize your mainframe environment with Micro Focus .....	2365

Summary .....	2365
Prerequisites and limitations .....	2367
Architecture .....	2369
Tools .....	2380
Epics .....	2381
Related resources .....	2385
Preserve routable IP space in multi-account VPC designs for non-workload subnets .....	2387
Summary .....	2387
Prerequisites and limitations .....	2387
Architecture .....	2387
Tools .....	2389
Best practices .....	2390
Epics .....	2391
Related resources .....	2392
Additional information .....	2393
Provision a Terraform product in Service Catalog from a code repository .....	2394
Summary .....	2394
Prerequisites and limitations .....	2395
Architecture .....	2395
Tools .....	2396
Best practices .....	2397
Epics .....	2397
Related resources .....	2411
Additional information .....	2411
Register multiple AWS accounts with a single email address .....	2414
Summary .....	2414
Prerequisites and limitations .....	2414
Architecture .....	2415
Tools .....	2417
Epics .....	2418
Troubleshooting .....	2427
Related resources .....	2430
Additional information .....	2430
Set up DNS resolution for hybrid networks in a multi-account AWS environment .....	2432
Summary .....	2432
Prerequisites and limitations .....	2432

---

Architecture .....	2433
Tools .....	2436
Epics .....	2437
Related resources .....	2440
Set up DNS resolution for hybrid networks in a single-account AWS environment .....	2441
Summary .....	2441
Prerequisites and limitations .....	2441
Architecture .....	2442
Tools .....	2442
Epics .....	2443
Related resources .....	2446
Set up UiPath RPA bots automatically on Amazon EC2 .....	2447
Summary .....	2447
Prerequisites and limitations .....	2448
Architecture .....	2448
Tools .....	2450
Best practices .....	2451
Epics .....	2452
Troubleshooting .....	2462
Related resources .....	2463
Set up disaster recovery for Oracle JD Edwards EnterpriseOne .....	2464
Summary .....	2464
Prerequisites and limitations .....	2465
Architecture .....	2466
Tools .....	2468
Best practices .....	2469
Epics .....	2470
Troubleshooting .....	2488
Related resources .....	2489
Synchronize Amazon EFS file systems in different Regions .....	2490
Summary .....	2490
Prerequisites and limitations .....	2490
Architecture .....	2491
Tools .....	2492
Best practices .....	2493
Epics .....	2493

---

Related resources .....	2498
Upgrade SAP Pacemaker clusters from ENSA1 to ENSA2 .....	2499
Summary .....	2499
Prerequisites and limitations .....	2500
Architecture .....	2500
Tools .....	2502
Best practices .....	2502
Epics .....	2503
Related resources .....	2520
Use consistent Availability Zones in VPCs across different accounts .....	2521
Summary .....	2521
Prerequisites and limitations .....	2522
Architecture .....	2522
Tools .....	2525
Epics .....	2526
Related resources .....	2527
Validate Account Factory for Terraform code locally .....	2529
Summary .....	2529
Prerequisites and limitations .....	2529
Architecture .....	2530
Tools .....	2531
Epics .....	2532
More patterns .....	2545
<b>IoT .....</b>	<b>2548</b>
Configure logging and monitoring for security events in your IoT environment .....	2549
Summary .....	2549
Prerequisites and limitations .....	2550
Architecture .....	2550
Tools .....	2552
Epics .....	2553
Related resources .....	2558
Extract and query AWS IoT SiteWise metadata attributes .....	2559
Summary .....	2559
Prerequisites and limitations .....	2559
Architecture .....	2560
Tools .....	2561



Epics .....	2561
Related resources .....	2564
Additional information .....	2564
.....	2567
Summary .....	2567
Prerequisites and limitations .....	2568
Architecture .....	2568
Tools .....	2570
Best practices .....	2570
Epics .....	2571
Troubleshooting .....	2586
Related resources .....	2588
Additional information .....	2588
More patterns .....	2593
<b>Machine learning &amp; AI .....</b>	<b>2594</b>
Aggregate DynamoDB data for ML forecasting in Athena .....	2595
Summary .....	2595
Prerequisites and limitations .....	2595
Architecture .....	2596
Tools .....	2597
Epics .....	2599
Related resources .....	2609
Associate an AWS CodeCommit repository with Amazon SageMaker Studio across accounts .....	2610
Summary .....	2610
Prerequisites and limitations .....	2610
Architecture .....	2611
Tools .....	2612
Epics .....	2612
Additional information .....	2617
Automate Amazon Lookout for Vision model training .....	2620
Summary .....	2620
Prerequisites and limitations .....	2623
Architecture .....	2623
Tools .....	2624
Best practices .....	2625
Epics .....	2625

---

Related resources .....	2628
Automatically extract content from PDF files .....	2629
Summary .....	2629
Prerequisites and limitations .....	2630
Architecture .....	2630
Tools .....	2632
Epics .....	2632
Related resources .....	2636
Attachments .....	2637
Build an MLOps workflow using SageMaker and Azure DevOps .....	2638
Summary .....	2638
Prerequisites and limitations .....	2638
Architecture .....	2639
Tools .....	2642
Best practices .....	2643
Epics .....	2643
Troubleshooting .....	2651
Related resources .....	2652
Create Docker containers in SageMaker for model training in Step Functions .....	2654
Summary .....	2654
Prerequisites and limitations .....	2654
Architecture .....	2655
Tools .....	2656
Epics .....	2656
Related resources .....	2669
Deploy multiple pipeline model objects in a single SageMaker endpoint .....	2670
Summary .....	2670
Prerequisites and limitations .....	2670
Architecture .....	2671
Tools .....	2672
Epics .....	2673
Related resources .....	2683
Develop AI chat-based assistants by using RAG and ReAct prompting .....	2684
Summary .....	2684
Prerequisites and limitations .....	2685
Architecture .....	2686

---

---

Tools .....	2690
Best practices .....	2692
Epics .....	2692
Troubleshooting .....	2698
Related resources .....	2698
Additional information .....	2698
Develop a chat-based assistant using Amazon Bedrock .....	2700
Summary .....	2700
Prerequisites and limitations .....	2701
Architecture .....	2702
Tools .....	2704
Best practices .....	2705
Epics .....	2706
Related resources .....	2709
Additional information .....	2710
Document institutional knowledge from voice inputs .....	2713
Summary .....	2713
Prerequisites and limitations .....	2714
Architecture .....	2715
Tools .....	2716
Best practices .....	2717
Epics .....	2718
Related resources .....	2723
Generate personalized recommendations using Amazon Personalize .....	2725
Summary .....	2725
Prerequisites and limitations .....	2725
Architecture .....	2726
Tools .....	2728
Epics .....	2729
Related resources .....	2731
Additional information .....	2731
Train and deploy a custom GPU-supported ML model .....	2735
Summary .....	2735
Prerequisites and limitations .....	2735
Architecture .....	2736
Tools .....	2737

Epics .....	2737
Related resources .....	2752
Additional information .....	2752
Use SageMaker Processing for distributed feature engineering of terabyte-scale ML datasets .....	2755
Summary .....	2755
Prerequisites and limitations .....	2755
Architecture .....	2756
Tools .....	2760
Epics .....	2760
Related resources .....	2771
Attachments .....	2772
Visualize AI/ML model results using Flask and Elastic Beanstalk .....	2773
Summary .....	2773
Prerequisites and limitations .....	2773
Architecture .....	2774
Tools .....	2777
Epics .....	2777
Related resources .....	2786
Additional information .....	2786
More patterns .....	2790
<b>Mainframe .....</b>	<b>2791</b>
Access AWS services from IBM z/OS by installing the AWS CLI .....	2792
Summary .....	2792
Prerequisites and limitations .....	2793
Architecture .....	2794
Tools .....	2795
Best practices .....	2796
Epics .....	2796
Related resources .....	2811
Additional information .....	2811
Attachments .....	2812
Back up and archive mainframe data to Amazon S3 .....	2813
Summary .....	2813
Prerequisites and limitations .....	2813
Architecture .....	2814

---

Tools .....	2816
Epics .....	2817
Related resources .....	2837
Build a mainframe file viewer in the AWS Cloud .....	2839
Summary .....	2839
Prerequisites and limitations .....	2839
Architecture .....	2840
Tools .....	2842
Epics .....	2843
Related resources .....	2853
Additional information .....	2853
Containerize modernized Blu Age applications .....	2856
Summary .....	2856
Prerequisites and limitations .....	2857
Architecture .....	2857
Tools .....	2858
Best practices .....	2859
Epics .....	2860
Related resources .....	2865
Convert EBCDIC data to ASCII on AWS .....	2867
Summary .....	2867
Prerequisites and limitations .....	2867
Architecture .....	2868
Tools .....	2870
Epics .....	2870
Related resources .....	2885
Convert mainframe EBCDIC files to ASCII files using AWS Lambda .....	2887
Summary .....	2887
Prerequisites and limitations .....	2887
Architecture .....	2888
Tools .....	2890
Best practices .....	2890
Epics .....	2891
Related resources .....	2906
Convert mainframe data files with complex record layouts .....	2907
Summary .....	2907

---

Prerequisites and limitations .....	2907
Tools .....	2908
Epics .....	2908
Related resources .....	2923
Deploy an environment for containerized apps .....	2924
Summary .....	2924
Prerequisites and limitations .....	2925
Architecture .....	2925
Tools .....	2929
Best practices .....	2930
Epics .....	2930
Related resources .....	2934
Generate insights by using AWS Mainframe Modernization and Amazon Q in QuickSight ....	2935
Summary .....	2935
Prerequisites and limitations .....	2936
Architecture .....	2936
Tools .....	2937
Best practices .....	2938
Epics .....	2938
Troubleshooting .....	2949
Related resources .....	2950
Additional information .....	2950
Attachments .....	2955
Integrate Stonebranch Universal Controller with AWS .....	2956
Summary .....	2956
Prerequisites and limitations .....	2957
Architecture .....	2958
Tools .....	2964
Epics .....	2965
Related resources .....	2989
Additional information .....	2989
Migrate and replicate VSAM files to the AWS Cloud using Precisely .....	2992
Summary .....	2992
Prerequisites and limitations .....	2992
Architecture .....	2993
Tools .....	2996

---

Epics .....	2997
Related resources .....	3006
Additional information .....	3007
Modernize mainframe output management on AWS .....	3009
Summary .....	3009
Prerequisites and limitations .....	3010
Architecture .....	3010
Tools .....	3018
Epics .....	3019
Related resources .....	3054
Additional information .....	3054
Attachments .....	3055
Modernize your mainframe batch printing workloads on AWS .....	3056
Summary .....	3056
Prerequisites and limitations .....	3056
Architecture .....	3057
Tools .....	3062
Epics .....	3063
Related resources .....	3084
Additional information .....	3085
Attachments .....	3086
Modernize your mainframe online printing workloads on AWS .....	3087
Summary .....	3087
Prerequisites and limitations .....	3087
Architecture .....	3088
Tools .....	3093
Epics .....	3094
Related resources .....	3118
Additional information .....	3118
Attachments .....	3120
Move mainframe files to Amazon S3 using Transfer Family .....	3121
Summary .....	3121
Prerequisites and limitations .....	3121
Architecture .....	3122
Tools .....	3124
Epics .....	3124

---

Related resources .....	3133
Transfer Db2 z/OS data to AWS .....	3134
Summary .....	3134
Prerequisites and limitations .....	3135
Architecture .....	3135
Tools .....	3138
Best practices .....	3139
Epics .....	3139
Related resources .....	3160
Additional information .....	3160
More patterns .....	3162
<b>Management &amp; governance .....</b>	<b>3163</b>
Alert when Data Firehose resources are not encrypted .....	3164
Summary .....	3164
Prerequisites and limitations .....	3164
Architecture .....	3165
Tools .....	3166
Epics .....	3167
Related resources .....	3168
Additional information .....	3168
Attachments .....	3168
Automate adding or updating Windows registry entries .....	3169
Summary .....	3169
Prerequisites and limitations .....	3169
Architecture .....	3169
Tools .....	3170
Epics .....	3172
Related resources .....	3173
Attachments .....	3173
Automatically stop and start an Amazon RDS DB instance .....	3174
Summary .....	3174
Prerequisites and limitations .....	3174
Architecture .....	3175
Tools .....	3177
Epics .....	3177
Related resources .....	3188



---

Centralize software package distribution in AWS Organizations by using Terraform .....	3189
Summary .....	3189
Prerequisites and limitations .....	3189
Architecture .....	3190
Tools .....	3192
Best practices .....	3192
Epics .....	3193
Troubleshooting .....	3200
Related resources .....	3201
Configure VPC Flow Logs across accounts .....	3202
Summary .....	3202
Prerequisites and limitations .....	3202
Architecture .....	3203
Tools .....	3204
Best practices .....	3205
Epics .....	3208
Related resources .....	3209
Additional information .....	3209
Configure logging for .NET applications in CloudWatch Logs .....	3212
Summary .....	3212
Prerequisites and limitations .....	3212
Architecture .....	3213
Tools .....	3214
Best practices .....	3214
Epics .....	3215
Troubleshooting .....	3219
Related resources .....	3219
Additional information .....	3220
Copy AWS Service Catalog products across AWS accounts and Regions .....	3221
Summary .....	3221
Prerequisites and limitations .....	3221
Architecture .....	3222
Tools .....	3223
Epics .....	3225
Related resources .....	3230
Attachments .....	3231

Create alarms for custom metrics using CloudWatch .....	3232
Summary .....	3232
Prerequisites and limitations .....	3232
Architecture .....	3233
Tools .....	3233
Epics .....	3234
Related resources .....	3237
Attachments .....	3238
Create an AWS Cloud9 IDE with default encrypted EBS volumes .....	3239
Summary .....	3239
Prerequisites and limitations .....	3239
Architecture .....	3240
Tools .....	3241
Epics .....	3241
Related resources .....	3243
Additional information .....	3243
Document your landing zone design .....	3245
Summary .....	3245
Prerequisites and limitations .....	3245
Epics .....	3246
Related resources .....	3247
Attachments .....	3247
Enable Amazon DevOps Guru across an organization with the AWS CDK .....	3248
Summary .....	3248
Prerequisites and limitations .....	3249
Architecture .....	3249
Tools .....	3251
Epics .....	3252
Related resources .....	3274
Implement AFT by using a bootstrap pipeline .....	3275
Summary .....	3275
Prerequisites and limitations .....	3276
Architecture .....	3276
Tools .....	3280
Best practices .....	3281
Epics .....	3281

---

Troubleshooting .....	3292
Related resources .....	3293
Manage AWS Service Catalog products in multiple AWS accounts and Regions .....	3295
Summary .....	3295
Prerequisites and limitations .....	3296
Architecture .....	3296
Tools .....	3297
Epics .....	3297
Related resources .....	3301
Additional information .....	3302
Migrate an AWS account from AWS Organizations to AWS Control Tower .....	3303
Summary .....	3303
Prerequisites and limitations .....	3303
Architecture .....	3304
Tools .....	3305
Epics .....	3305
Troubleshooting .....	3316
Related resources .....	3316
Monitor use of an AMI across AWS accounts .....	3318
Summary .....	3318
Prerequisites and limitations .....	3319
Architecture .....	3319
Tools .....	3321
Best practices .....	3322
Epics .....	3322
Troubleshooting .....	3334
Related resources .....	3335
Set up alerts for programmatic account closures in AWS Organizations .....	3336
Summary .....	3336
Prerequisites and limitations .....	3336
Architecture .....	3337
Tools .....	3339
Epics .....	3340
Related resources .....	3344
More patterns .....	3345
<b>Messaging &amp; communications .....</b>	<b>3347</b>

---

Automate RabbitMQ configuration in Amazon MQ .....	3348
Summary .....	3348
Prerequisites and limitations .....	3348
Architecture .....	3349
Tools .....	3350
Epics .....	3351
Related resources .....	3356
Attachments .....	3356
Improve call quality on agent workstations in Amazon Connect .....	3357
Summary .....	3357
Prerequisites and limitations .....	3358
Architecture .....	3358
Tools .....	3359
Epics .....	3359
Related resources .....	3371
More patterns .....	3373
<b>Migration .....</b>	<b>3374</b>
Automate migration strategy identification and planning .....	3375
Summary .....	3375
Prerequisites and limitations .....	3376
Architecture .....	3377
Tools .....	3377
Epics .....	3377
Related resources .....	3383
Create AWS CloudFormation templates for AWS DMS .....	3384
Summary .....	3384
Prerequisites and limitations .....	3384
Architecture .....	3385
Tools .....	3386
Epics .....	3386
Related resources .....	3387
Get started with automated portfolio discovery .....	3388
Summary .....	3388
Epics .....	3388
Related resources .....	3394
Additional information .....	3394

Attachments .....	3395
Migrate on-premises Cloudera workloads to AWS .....	3396
Summary .....	3396
Prerequisites and limitations .....	3400
Architecture .....	3401
Tools .....	3403
Epics .....	3404
Related resources .....	3411
Restart the AWS Replication Agent automatically without disabling SELinux .....	3413
Summary .....	3413
Prerequisites and limitations .....	3413
Tools .....	3414
Epics .....	3415
Related resources .....	3419
Re-architect .....	3421
Convert VARCHAR2(1) data type to Boolean data type .....	3423
Create users and roles in Aurora PostgreSQL-Compatible .....	3433
Emulate Oracle DR with an Aurora global database .....	3448
Incrementally migrate from Amazon RDS for Oracle to Amazon RDS for PostgreSQL .....	3455
Load BLOB files into Aurora PostgreSQL-Compatible .....	3463
Migrate Amazon RDS for Oracle to Amazon RDS for PostgreSQL in SSL mode .....	3480
Migrate Amazon RDS for Oracle to Amazon RDS for PostgreSQL using AWS SCT and AWS DMS .....	3506
Migrate Oracle SERIALLY_REUSABLE pragma packages to AWS .....	3522
Migrate Oracle external tables to Amazon Aurora .....	3529
Migrate Oracle function-based indexes .....	3555
Migrate Oracle native functions to PostgreSQL .....	3561
Migrate a Db2 database from Amazon EC2 to Aurora MySQL-Compatible .....	3569
Migrate a SQL Server database from Amazon EC2 to Amazon DocumentDB .....	3587
Migrate a ThoughtSpot Falcon database to Amazon Redshift .....	3597
Migrate an Oracle database to Amazon DynamoDB .....	3610
Migrate an Oracle partitioned table to PostgreSQL .....	3617
Migrate from Amazon RDS for Oracle to MySQL .....	3622
Migrate from IBM Db2 to Aurora PostgreSQL-Compatible .....	3631
Migrate from Oracle 8i/9i to Amazon RDS for PostgreSQL using Quest SharePlex .....	3641
Migrate from Oracle 8i/9i to Amazon RDS for PostgreSQL using materialized views .....	3652

Migrate from Oracle on Amazon EC2 to Amazon RDS for MySQL .....	3664
Migrate from Oracle to Amazon DocumentDB .....	3674
Migrate from Oracle to Amazon RDS for MariaDB .....	3681
Migrate from Oracle to Amazon RDS for MySQL .....	3692
Migrate from Oracle to Amazon RDS for PostgreSQL .....	3698
Migrate from Oracle to Amazon RDS for PostgreSQL using Oracle GoldenGate .....	3711
Migrate from Oracle to Amazon Redshift .....	3718
Migrate from Oracle to Aurora PostgreSQL-Compatible .....	3730
Migrate from Oracle with standby to Aurora PostgreSQL .....	3743
Migrate from SAP ASE to Amazon RDS for SQL Server .....	3754
Migrate from SQL Server to Amazon Redshift .....	3761
Migrate from SQL Server to Amazon Redshift using data extraction agents .....	3766
Migrate from Teradata to Amazon Redshift using data extraction agents .....	3771
Migrate from Vertica to Amazon Redshift using data extraction agents .....	3776
Migrate legacy applications from Oracle Pro*C to ECPG .....	3781
Migrate virtual generated columns from Oracle to PostgreSQL .....	3799
Set up Oracle UTL_FILE functionality on Amazon Aurora .....	3807
.....	3823
Rehost .....	3832
Accelerate Microsoft workload migration to AWS .....	3833
Automate pre-workload ingestion activities .....	3843
Create an approval process for firewall requests during a migration .....	3853
Ingest EC2 Windows instances into an AMS account .....	3859
Migrate Db2 to Amazon EC2 by using log shipping .....	3869
Migrate Db2 to Amazon EC2 with HADR .....	3887
Migrate VMware VMs with HCX Automation by using PowerCLI .....	3921
Migrate an F5 BIG-IP workload to F5 BIG-IP VE .....	3933
Migrate an on-premises Go application to AWS Elastic Beanstalk .....	3943
.....	3949
Migrate an on-premises VM to AWS .....	3959
Migrate data to Amazon S3 using AWS SFTP .....	3972
Migrate from Oracle GlassFish to AWS Elastic Beanstalk .....	3978
Migrate from Oracle to Amazon EC2 .....	3985
Migrate from Oracle to Amazon EC2 using Oracle Data Pump .....	3994
Migrate from SAP ASE to Amazon EC2 .....	4003
Migrate from SQL Server to Amazon EC2 .....	4011

Migrate from on-premises MySQL to Amazon EC2 .....	4020
Reduce homogeneous SAP migration cutover time .....	4031
Rehost on-premises workloads on AWS: migration checklist .....	4040
Set up Multi-AZ infrastructure for a SQL Server Always On FCI .....	4057
Use BMC Discovery to extract migration planning data .....	4078
Relocate .....	4089
Migrate Amazon RDS for Oracle to another AWS Region and account .....	4090
Migrate VMware SDDC to VMware Cloud on AWS .....	4099
Migrate an Amazon RDS DB instance to another VPC or account .....	4104
Migrate an Amazon RDS for Oracle DB to another VPC .....	4112
.....	4118
Migrate workloads to the VMware Cloud on AWS by using VMware HCX .....	4134
Transport PostgreSQL databases between Amazon RDS DB instances .....	4168
Replatform .....	4181
Configure links between Oracle Database and Aurora .....	4183
Export a Microsoft SQL Server database to Amazon S3 .....	4222
Migrate ML Build, Train, and Deploy workloads to Amazon SageMaker .....	4229
Migrate OpenText TeamSite workloads to AWS .....	4237
Migrate Oracle CLOB values to individual rows in PostgreSQL .....	4259
Migrate Oracle Database with Oracle Data Pump and a database link .....	4267
Migrate Oracle E-Business Suite to Amazon RDS Custom .....	4284
Migrate Oracle PeopleSoft to Amazon RDS Custom .....	4382
Migrate Oracle ROWID functionality to PostgreSQL .....	4411
Migrate Oracle error codes to an Amazon Aurora PostgreSQL-Compatible database .....	4423
Migrate Redis workloads to Redis Enterprise Cloud on AWS .....	4429
Migrate SAP ASE on Amazon EC2 to Aurora PostgreSQL-Compatible .....	4458
Migrate Windows SSL certificates to an Application Load Balancer using ACM .....	4468
Migrate a messaging queue from Microsoft Azure to Amazon SQS .....	4479
Migrate an Oracle JD Edwards EnterpriseOne database to AWS .....	4486
Migrate an Oracle PeopleSoft database to AWS .....	4514
Migrate an on-premises MySQL database to Amazon RDS for MySQL .....	4539
Migrate an on-premises SQL Server database to Amazon RDS for SQL Server .....	4548
Migrate data from Azure Blob to Amazon S3 .....	4555
Migrate from Couchbase Server to Couchbase Capella .....	4565
Migrate from IBM WebSphere to Apache Tomcat on Amazon EC2 .....	4599
Migrate from IBM WebSphere to Apache Tomcat on Amazon EC2 with Auto Scaling .....	4608

Migrate from Microsoft Azure App Service to AWS Elastic Beanstalk .....	4616
Migrate from MongoDB to MongoDB Atlas on AWS .....	4624
Migrate from Oracle WebLogic to TomEE on Amazon ECS .....	4633
Migrate from Oracle on Amazon EC2 to Amazon RDS for Oracle .....	4643
Migrate from Oracle to Amazon OpenSearch Service with Logstash .....	4650
Migrate from Oracle to Amazon RDS for Oracle .....	4660
Migrate from Oracle to Amazon RDS using Oracle Data Pump .....	4674
Migrate from PostgreSQL on Amazon EC2 to Amazon RDS for PostgreSQL .....	4685
Migrate from PostgreSQL to Aurora PostgreSQL .....	4692
Migrate from SQL Server on Windows to Linux on Amazon EC2 .....	4705
Migrate from SQL Server to Amazon RDS for SQL Server using linked servers .....	4710
Migrate from SQL Server to Amazon RDS for SQL Server using native backup and restore .....	4716
Migrate from SQL Server to Aurora MySQL .....	4721
Migrate from on-premises MariaDB to Amazon RDS for MariaDB .....	4732
Migrate from on-premises MySQL to Aurora MySQL .....	4738
Migrate from on-premises MySQL to Aurora MySQL using Percona XtraBackup .....	4746
Migrate on-premises applications using App2Container .....	4762
Migrate shared file systems in an AWS large migration .....	4774
Migrate to Amazon RDS using Oracle GoldenGate flat file adapters .....	4803
Python and Perl application changes to support database migrations .....	4811
Migration patterns by workload .....	4844
IBM .....	4845
Microsoft .....	4846
N/A .....	4847
Open-source .....	4848
Oracle .....	4849
SAP .....	4851
More patterns .....	4852
<b>Modernization .....</b>	<b>4854</b>
Analyze and visualize software architecture in CAST Imaging .....	4855
Summary .....	4855
Prerequisites and limitations .....	4855
Architecture .....	4856
Tools .....	4857
Epics .....	4858



Related resources .....	4863
Assess application readiness before migrating to AWS by using CAST Highlight .....	4865
Summary .....	4865
Prerequisites and limitations .....	4865
Architecture .....	4866
Tools .....	4868
Epics .....	4868
Related resources .....	4887
Automatically archive expired DynamoDB data to Amazon S3 .....	4888
Summary .....	4888
Prerequisites and limitations .....	4889
Architecture .....	4889
Tools .....	4890
Epics .....	4890
Related resources .....	4903
Additional information .....	4903
Build a Micro Focus Enterprise Server PAC .....	4906
Summary .....	4906
Prerequisites and limitations .....	4906
Architecture .....	4907
Tools .....	4913
Epics .....	4914
Related resources .....	4917
Additional information .....	4918
Build a multi-tenant serverless architecture in Amazon OpenSearch Service .....	4926
Summary .....	4926
Prerequisites and limitations .....	4927
Architecture .....	4927
Tools .....	4928
Epics .....	4929
Related resources .....	4971
Additional information .....	4971
Attachments .....	4978
Deploy multiple-stack applications .....	4979
Summary .....	4979
Prerequisites and limitations .....	4979

---

Architecture .....	4980
Tools .....	4982
Epics .....	4983
Related resources .....	4986
Additional information .....	4987
Attachments .....	4989
Deploy nested applications using AWS SAM .....	4990
Summary .....	4990
Prerequisites and limitations .....	4991
Architecture .....	4991
Tools .....	4993
Epics .....	4994
Related resources .....	4998
Additional information .....	4999
Implement SaaS tenant isolation for Amazon S3 by using an AWS Lambda TVM .....	5000
Summary .....	5000
Prerequisites and limitations .....	5000
Architecture .....	5001
Tools .....	5002
Epics .....	5003
Related resources .....	5024
Additional information .....	5024
Attachments .....	5025
Implement the serverless saga pattern by using AWS Step Functions .....	5026
Summary .....	5026
Prerequisites and limitations .....	5027
Architecture .....	5028
Tools .....	5029
Epics .....	5031
Related resources .....	5036
Additional information .....	5037
Manage on-premises container applications with Amazon ECS Anywhere .....	5043
Summary .....	5043
Prerequisites and limitations .....	5043
Architecture .....	5044
Tools .....	5046

---

Epics .....	5046
Related resources .....	5053
Modernize ASP.NET Web Forms applications on AWS .....	5054
Summary .....	5054
Prerequisites and limitations .....	5055
Architecture .....	5056
Tools .....	5057
Epics .....	5058
Related resources .....	5068
Additional information .....	5068
Run event-driven workloads with AWS Fargate .....	5070
Summary .....	5070
Prerequisites and limitations .....	5071
Architecture .....	5071
Tools .....	5072
Epics .....	5073
Related resources .....	5078
Additional information .....	5078
Attachments .....	5079
Tenant onboarding in SaaS architecture .....	5080
Summary .....	5080
Prerequisites and limitations .....	5080
Architecture .....	5083
Tools .....	5085
Epics .....	5087
Related resources .....	5103
Additional information .....	5103
Use CQRS and event sourcing .....	5106
Summary .....	5106
Prerequisites and limitations .....	5106
Architecture .....	5107
Tools .....	5109
Epics .....	5110
Related resources .....	5123
Additional information .....	5123
Attachments .....	5134

More patterns .....	5135
<b>Multi account strategy .....</b>	<b>5137</b>
Set up drift detection and reporting .....	5138
Summary .....	5138
Prerequisites and limitations .....	5138
Architecture .....	5139
Tools .....	5140
Epics .....	5140
Related resources .....	5143
Additional information .....	5143
Attachments .....	5143
More patterns .....	5144
<b>Networking .....</b>	<b>5145</b>
Automate peering for AWS Transit Gateway .....	5146
Summary .....	5146
Prerequisites and limitations .....	5146
Architecture .....	5147
Tools .....	5149
Epics .....	5150
Related resources .....	5153
Attachments .....	5153
Centralize network connectivity using AWS Transit Gateway .....	5154
Summary .....	5154
Prerequisites and limitations .....	5154
Architecture .....	5154
Tools .....	5155
Epics .....	5155
Related resources .....	5160
Configure HTTPS encryption for Oracle JD Edwards EnterpriseOne by using an Application Load Balancer .....	5161
Summary .....	5161
Prerequisites and limitations .....	5162
Architecture .....	5162
Tools .....	5163
Best practices .....	5163
Epics .....	5163

---

Troubleshooting .....	5171
Related resources .....	5171
Connect to Application Migration Service data and control planes over a private network ...	5172
Summary .....	5172
Prerequisites and limitations .....	5172
Architecture .....	5174
Tools .....	5176
Epics .....	5177
Related resources .....	5186
Additional information .....	5186
Create Infoblox objects using AWS CloudFormation custom resources .....	5188
Summary .....	5188
Prerequisites and limitations .....	5189
Architecture .....	5190
Tools .....	5192
Epics .....	5195
Related resources .....	5201
Attachments .....	5201
Customize CloudWatch alerts for Network Firewall .....	5202
Summary .....	5202
Prerequisites and limitations .....	5202
Architecture .....	5203
Tools .....	5204
Epics .....	5205
Related resources .....	5221
Additional information .....	5221
Deploy resources in a Wavelength Zone using Terraform .....	5223
Summary .....	5223
Prerequisites and limitations .....	5224
Architecture .....	5224
Tools .....	5225
Best practices .....	5226
Epics .....	5226
Troubleshooting .....	5230
Related resources .....	5231
Migrate DNS records in bulk to a Route 53 private hosted zone .....	5232

---

Summary .....	5232
Prerequisites and limitations .....	5232
Architecture .....	5233
Tools .....	5234
Epics .....	5234
Related resources .....	5241
Modify HTTP headers when you migrate from F5 to an Application Load Balancer on AWS ..	5242
Summary .....	5242
Prerequisites and limitations .....	5242
Architecture .....	5243
Tools .....	5243
Epics .....	5245
Related resources .....	5247
Peer VPCs in different AWS Regions by using Transit Gateway .....	5249
Summary .....	5249
Prerequisites and limitations .....	5250
Architecture .....	5250
Tools .....	5251
Epics .....	5251
Troubleshooting .....	5261
Related resources .....	5262
Privately access an AWS service endpoint from multiple VPCs .....	5263
Summary .....	5263
Prerequisites and limitations .....	5263
Architecture .....	5264
Tools .....	5266
Epics .....	5269
Related resources .....	5274
Report Network Access Analyzer findings in multiple AWS accounts .....	5275
Summary .....	5275
Prerequisites and limitations .....	5276
Architecture .....	5277
Tools .....	5281
Epics .....	5283
Troubleshooting .....	5303
Related resources .....	5304

---

Additional information .....	5304
Tag Transit Gateway attachments automatically .....	5307
Summary .....	5307
Prerequisites and limitations .....	5307
Architecture .....	5308
Tools .....	5311
Epics .....	5312
Related resources .....	5319
.....	5320
Summary .....	5320
Prerequisites and limitations .....	5320
Architecture .....	5321
Tools .....	5321
Epics .....	5322
Related resources .....	5325
Attachments .....	5325
View AWS Network Firewall logs and metrics using Splunk .....	5326
Summary .....	5326
Prerequisites and limitations .....	5326
Architecture .....	5327
Tools .....	5328
Epics .....	5328
Related resources .....	5336
More patterns .....	5337
<b>Operating systems .....</b>	<b>5338</b>
Migrate from RHEL BYOL to AWS LI instances using AWS MGN .....	5339
Summary .....	5339
Prerequisites and limitations .....	5339
Architecture .....	5340
Tools .....	5340
Epics .....	5340
Related resources .....	5353
Resolve connection errors after migrating SQL Server to AWS .....	5354
Summary .....	5354
Prerequisites and limitations .....	5354
Tools .....	5355

---

Epics .....	5355
Related resources .....	5356
More patterns .....	5357
<b>Operations .....</b>	<b>5358</b>
Automatically create an RFC using Python .....	5359
Summary .....	5359
Prerequisites and limitations .....	5359
Architecture .....	5360
Tools .....	5360
Epics .....	5361
Related resources .....	5365
Attachments .....	5365
Create a RACI matrix for cloud operations .....	5366
Summary .....	5366
Epics .....	5367
Related resources .....	5371
Attachments .....	5371
Create tag-based CloudWatch dashboards automatically .....	5372
Summary .....	5372
Prerequisites and limitations .....	5372
Architecture .....	5373
Tools .....	5374
Best practices .....	5375
Epics .....	5375
Troubleshooting .....	5381
Related resources .....	5381
Additional information .....	5381
Find AWS resources based on creation date by using AWS Config .....	5383
Summary .....	5383
Prerequisites and limitations .....	5384
Tools .....	5384
Epics .....	5385
Additional information .....	5387
View EBS snapshot details for your AWS account or organization .....	5389
Summary .....	5389
Prerequisites and limitations .....	5389



Architecture .....	5390
Tools .....	5390
Epics .....	5391
Related resources .....	5393
Additional information .....	5393
More patterns .....	5396
<b>Security, identity, compliance .....</b>	<b>5397</b>
Access AWS services from ASP.NET using Amazon Cognito .....	5400
Summary .....	5400
Prerequisites and limitations .....	5401
Architecture .....	5401
Tools .....	5402
Epics .....	5403
Troubleshooting .....	5407
Related resources .....	5407
Attachments .....	5407
Authenticate SQL Server using AWS Directory Service .....	5408
Summary .....	5408
Prerequisites and limitations .....	5408
Architecture .....	5409
Tools .....	5409
Epics .....	5410
Related resources .....	5413
Automate incident response and forensics .....	5415
Summary .....	5415
Prerequisites and limitations .....	5416
Architecture .....	5416
Tools .....	5423
Epics .....	5424
Related resources .....	5428
Additional information .....	5428
Attachments .....	5428
Automate remediation for Security Hub standard findings .....	5429
Summary .....	5429
Prerequisites and limitations .....	5430
Architecture .....	5431

---

Tools .....	5431
Best practices .....	5432
Epics .....	5432
Related resources .....	5435
Attachments .....	5435
Automate security scans for cross-account workloads using Amazon Inspector .....	5436
Summary .....	5436
Prerequisites and limitations .....	5436
Architecture .....	5437
Tools .....	5439
Epics .....	5440
Related resources .....	5444
Attachments .....	5444
Automatically re-enable AWS CloudTrail using security best practices .....	5445
Summary .....	5445
Prerequisites and limitations .....	5445
Architecture .....	5446
Tools .....	5447
Epics .....	5447
Related resources .....	5453
Attachments .....	5454
Automatically remediate unencrypted Amazon RDS DB instances and clusters .....	5455
Summary .....	5455
Prerequisites and limitations .....	5455
Architecture .....	5457
Tools .....	5457
Best practices .....	5459
Epics .....	5459
Related resources .....	5466
Additional information .....	5466
Automatically rotate IAM user access keys .....	5468
Summary .....	5468
Prerequisites and limitations .....	5469
Architecture .....	5470
Tools .....	5473
Epics .....	5475

Related resources .....	5484
Automatically validate and deploy IAM policies and roles in an AWS account .....	5486
Summary .....	5486
Prerequisites and limitations .....	5487
Architecture .....	5488
Tools .....	5489
Epics .....	5489
Related resources .....	5493
Bidirectionally integrate Security Hub and Jira .....	5494
Summary .....	5494
Prerequisites and limitations .....	5495
Architecture .....	5496
Tools .....	5498
Epics .....	5499
Related resources .....	5509
Additional information .....	5509
Build a pipeline for hardened container images .....	5511
Summary .....	5511
Prerequisites and limitations .....	5512
Architecture .....	5512
Tools .....	5516
Epics .....	5517
Troubleshooting .....	5525
Related resources .....	5526
Centralize IAM access key management in AWS Organizations by using Terraform .....	5527
Summary .....	5527
Prerequisites and limitations .....	5528
Architecture .....	5528
Tools .....	5531
Best practices .....	5532
Epics .....	5532
Troubleshooting .....	5541
Related resources .....	5542
Centralized logging and multiple-account security .....	5543
Summary .....	5543
Prerequisites and limitations .....	5544

---

Architecture .....	5545
Tools .....	5547
Epics .....	5549
Related resources .....	5556
Attachments .....	5556
Check an Amazon CloudFront distribution for access logging, HTTPS, and TLS version .....	5557
Summary .....	5557
Prerequisites and limitations .....	5558
Architecture .....	5558
Tools .....	5559
Epics .....	5560
Related resources .....	5563
Attachments .....	5563
Check for single-host network entries in security group ingress rules for IPv4 and IPv6 .....	5564
Summary .....	5564
Prerequisites and limitations .....	5564
Architecture .....	5565
Tools .....	5565
Epics .....	5566
Related resources .....	5570
Attachments .....	5570
Choose an Amazon Cognito authentication flow .....	5571
Summary .....	5571
Prerequisites and limitations .....	5571
Architecture .....	5572
Tools .....	5579
Epics .....	5579
Related resources .....	5582
Additional information .....	5582
Create AWS Config custom rules using Guard .....	5584
Summary .....	5584
Prerequisites and limitations .....	5585
Architecture .....	5585
Tools .....	5590
Epics .....	5590
Troubleshooting .....	5592

---

Related resources .....	5593
Create a report of Prowler findings from multiple AWS accounts .....	5594
Summary .....	5594
Prerequisites and limitations .....	5595
Architecture .....	5596
Tools .....	5597
Epics .....	5599
Troubleshooting .....	5622
Related resources .....	5622
Additional information .....	5622
Delete unused EBS volumes using AWS Config .....	5626
Summary .....	5626
Prerequisites and limitations .....	5626
Architecture .....	5627
Tools .....	5629
Epics .....	5629
Troubleshooting .....	5632
Related resources .....	5633
Deploy AWS Control Tower controls using AWS CDK .....	5634
Summary .....	5634
Prerequisites and limitations .....	5635
Architecture .....	5636
Tools .....	5637
Best practices .....	5638
Epics .....	5639
Related resources .....	5646
Additional information .....	5647
Deploy AWS Control Tower controls using Terraform .....	5650
Summary .....	5650
Prerequisites and limitations .....	5651
Architecture .....	5652
Tools .....	5653
Best practices .....	5654
Epics .....	5654
Troubleshooting .....	5660
Related resources .....	5662

---

Additional information .....	5662
Deploy a pipeline that detects security issues in code .....	5664
Summary .....	5664
Prerequisites and limitations .....	5664
Architecture .....	5665
Tools .....	5666
Epics .....	5667
Troubleshooting .....	5669
Related resources .....	5670
Additional information .....	5670
Deploy detective controls for public subnets .....	5672
Summary .....	5672
Prerequisites and limitations .....	5673
Architecture .....	5673
Tools .....	5677
Best practices .....	5678
Epics .....	5678
Related resources .....	5686
Additional information .....	5687
Deploy preventative controls for public subnets .....	5689
Summary .....	5689
Prerequisites and limitations .....	5690
Architecture .....	5690
Tools .....	5692
Epics .....	5692
Related resources .....	5699
Additional information .....	5699
Deploy the Security Automations for AWS WAF solution using Terraform .....	5702
Summary .....	5702
Prerequisites and limitations .....	5702
Architecture .....	5703
Tools .....	5704
Best practices .....	5704
Epics .....	5705
Troubleshooting .....	5708
Related resources .....	5708

Additional information .....	5709
Detect Amazon RDS instances with expiring CA certificates .....	5710
Summary .....	5710
Prerequisites and limitations .....	5710
Architecture .....	5711
Tools .....	5714
Best practices .....	5715
Epics .....	5715
Troubleshooting .....	5719
Related resources .....	5720
Dynamically generate an IAM policy with IAM Access Analyzer .....	5721
Summary .....	5721
Prerequisites and limitations .....	5722
Architecture .....	5723
Tools .....	5724
Epics .....	5725
Related resources .....	5731
Enable GuardDuty using CloudFormation templates .....	5733
Summary .....	5733
Prerequisites and limitations .....	5733
Architecture .....	5734
Tools .....	5735
Epics .....	5735
Related resources .....	5737
Additional information .....	5737
Enable transparent data encryption in Amazon RDS for SQL Server .....	5741
Summary .....	5741
Prerequisites and limitations .....	5741
Architecture .....	5742
Tools .....	5742
Epics .....	5743
Related resources .....	5746
Ensure AWS load balancers use secure listener protocols .....	5747
Summary .....	5747
Prerequisites and limitations .....	5748
Architecture .....	5748

---

Tools .....	5749
Best practices .....	5749
Epics .....	5749
Troubleshooting .....	5753
Related resources .....	5753
Attachments .....	5753
Ensure encryption for Amazon EMR data at rest .....	5754
Summary .....	5754
Prerequisites and limitations .....	5755
Architecture .....	5755
Tools .....	5756
Epics .....	5757
Related resources .....	5759
Attachments .....	5759
Ensure that an IAM profile is associated with an EC2 instance .....	5760
Summary .....	5760
Prerequisites and limitations .....	5760
Architecture .....	5761
Tools .....	5762
Epics .....	5763
Related resources .....	5765
Attachments .....	5765
Ensure that new Amazon Redshift clusters are encrypted .....	5766
Summary .....	5766
Prerequisites and limitations .....	5766
Architecture .....	5767
Tools .....	5767
Epics .....	5768
Related resources .....	5770
Attachments .....	5771
Export a report of IAM Identity Center identities and their assignments .....	5772
Summary .....	5772
Prerequisites and limitations .....	5773
Architecture .....	5774
Tools .....	5775
Epics .....	5776



---

Troubleshooting .....	5778
Related resources .....	5779
Additional information .....	5779
Help prevent scheduled KMS key deletion .....	5782
Summary .....	5782
Prerequisites and limitations .....	5782
Architecture .....	5783
Tools .....	5784
Epics .....	5785
Related resources .....	5788
Additional information .....	5789
Attachments .....	5789
Identify public S3 buckets in AWS Organizations .....	5790
Summary .....	5790
Prerequisites and limitations .....	5790
Architecture .....	5791
Tools .....	5793
Epics .....	5794
Troubleshooting .....	5798
Related resources .....	5799
Additional information .....	5799
Ingest AWS security logs into Microsoft Sentinel .....	5800
Summary .....	5800
Prerequisites and limitations .....	5801
Architecture .....	5802
Tools .....	5804
Best practices .....	5805
Epics .....	5805
Related resources .....	5816
Manage IAM Identity Center permission sets using CodePipeline .....	5817
Summary .....	5817
Prerequisites and limitations .....	5818
Architecture .....	5818
Tools .....	5821
Best practices .....	5822
Epics .....	5822

Troubleshooting .....	5832
Related resources .....	5833
Manage credentials with AWS Secrets Manager .....	5834
Summary .....	5834
Prerequisites and limitations .....	5834
Architecture .....	5835
Tools .....	5835
Epics .....	5836
Related resources .....	5837
Additional information .....	5837
.....	5840
Summary .....	5840
Prerequisites and limitations .....	5841
Architecture .....	5841
Tools .....	5841
Epics .....	5843
Related resources .....	5845
Attachments .....	5845
Monitor Amazon EMR clusters for in-transit encryption at launch .....	5846
Summary .....	5846
Prerequisites and limitations .....	5847
Architecture .....	5847
Tools .....	5848
Epics .....	5849
Related resources .....	5851
Attachments .....	5852
Monitor Amazon ElastiCache clusters for at-rest encryption .....	5853
Summary .....	5853
Prerequisites and limitations .....	5854
Architecture .....	5855
Tools .....	5855
Epics .....	5856
Related resources .....	5859
Attachments .....	5859
Monitor EC2 instance key pairs .....	5860
Summary .....	5860

---

Prerequisites and limitations .....	5860
Architecture .....	5861
Tools .....	5862
Epics .....	5862
Related resources .....	5866
Attachments .....	5866
Monitor IAM root user activity .....	5867
Summary .....	5867
Prerequisites and limitations .....	5868
Architecture .....	5868
Tools .....	5869
Epics .....	5871
Related resources .....	5876
Additional information .....	5876
Notify when an IAM user is created .....	5877
Summary .....	5877
Prerequisites and limitations .....	5877
Architecture .....	5878
Tools .....	5878
Epics .....	5879
Related resources .....	5882
Attachments .....	5882
Prevent internet access by using an SCP .....	5883
Summary .....	5883
Prerequisites and limitations .....	5883
Tools .....	5884
Best practices .....	5884
Epics .....	5885
Related resources .....	5887
Scan Git repositories for sensitive information .....	5888
Summary .....	5888
Prerequisites and limitations .....	5888
Architecture .....	5888
Tools .....	5889
Best practices .....	5889
Epics .....	5890

Related resources .....	5894
Send alerts from AWS Network Firewall to a Slack channel .....	5896
Summary .....	5896
Prerequisites and limitations .....	5896
Architecture .....	5897
Tools .....	5899
Epics .....	5900
Related resources .....	5906
Additional information .....	5906
Simplify private certificate management by using AWS Private CA and AWS RAM .....	5911
Summary .....	5911
Prerequisites and limitations .....	5912
Architecture .....	5912
Tools .....	5915
Epics .....	5917
Related resources .....	5923
Additional information .....	5924
Turn off security standard controls across all Security Hub member accounts in a multi-account environment .....	5925
Summary .....	5925
Prerequisites and limitations .....	5925
Architecture .....	5926
Tools .....	5928
Epics .....	5929
Related resources .....	5931
Update AWS CLI credentials from IAM Identity Center using PowerShell .....	5932
Summary .....	5932
Prerequisites and limitations .....	5932
Architecture .....	5933
Tools .....	5934
Best practices .....	5934
Epics .....	5935
Troubleshooting .....	5937
Related resources .....	5937
Additional information .....	5938
Use AWS Config to monitor Amazon Redshift .....	5940

Summary .....	5940
Prerequisites and limitations .....	5940
Architecture .....	5941
Tools .....	5942
Epics .....	5943
Related resources .....	5946
Additional information .....	5946
Use Network Firewall to capture DNS domain names from outbound network traffic .....	5947
Summary .....	5947
Prerequisites and limitations .....	5948
Architecture .....	5948
Tools .....	5949
Epics .....	5950
Use Terraform to automatically enable GuardDuty .....	5965
Summary .....	5965
Prerequisites and limitations .....	5966
Architecture .....	5968
Tools .....	5969
Epics .....	5970
Related resources .....	5979
Additional information .....	5980
.....	5981
Summary .....	5981
Prerequisites and limitations .....	5982
Architecture .....	5982
Tools .....	5982
Epics .....	5983
Related resources .....	5986
Attachments .....	5986
.....	5987
Summary .....	5987
Prerequisites and limitations .....	5987
Architecture .....	5988
Tools .....	5988
Epics .....	5989
Related resources .....	5992

---

Attachments .....	5992
More patterns .....	5993
<b>Serverless .....</b>	<b>5996</b>
Build a React Native app using AWS Amplify .....	5997
Summary .....	5997
Prerequisites and limitations .....	5997
Architecture .....	5998
Tools .....	5999
Epics .....	5999
Related resources .....	6014
Centrally manage tenants across multiple SaaS products .....	6015
Summary .....	6015
Prerequisites and limitations .....	6016
Architecture .....	6016
Tools .....	6018
Best practices .....	6019
Epics .....	6020
Related resources .....	6026
Create a cross-account Amazon EventBridge connection .....	6028
Summary .....	6028
Prerequisites and limitations .....	6029
Architecture .....	6029
Tools .....	6030
Best practices .....	6031
Epics .....	6032
Troubleshooting .....	6039
Related resources .....	6039
Additional information .....	6039
Deliver DynamoDB records to Amazon S3 using Kinesis Data Streams and Firehose .....	6043
Summary .....	6043
Prerequisites and limitations .....	6044
Architecture .....	6044
Tools .....	6045
Epics .....	6045
Related resources .....	6049
Integrate API Gateway with Amazon SQS .....	6051

---

Summary .....	6051
Prerequisites and limitations .....	6051
Architecture .....	6051
Tools .....	6052
Epics .....	6053
Related resources .....	6065
Process APIs asynchronously with AWS Lambda .....	6067
Summary .....	6067
Prerequisites and limitations .....	6068
Architecture .....	6068
Tools .....	6070
Best practices .....	6071
Epics .....	6071
Troubleshooting .....	6076
Related resources .....	6076
Process APIs asynchronously with Amazon DynamoDB Streams .....	6077
Summary .....	6077
Prerequisites and limitations .....	6078
Architecture .....	6078
Tools .....	6080
Best practices .....	6081
Epics .....	6082
Troubleshooting .....	6087
Related resources .....	6087
Process APIs asynchronously with Amazon SQS .....	6088
Summary .....	6088
Prerequisites and limitations .....	6089
Architecture .....	6089
Tools .....	6091
Best practices .....	6092
Epics .....	6093
Troubleshooting .....	6098
Related resources .....	6099
Run Systems Manager Automation tasks synchronously from Step Functions .....	6100
Summary .....	6100
Prerequisites and limitations .....	6101

---

Architecture .....	6101
Tools .....	6102
Epics .....	6103
Related resources .....	6108
Additional information .....	6109
Run parallel reads of S3 objects with AWS Lambda .....	6115
Summary .....	6115
Prerequisites and limitations .....	6116
Architecture .....	6116
Tools .....	6117
Best practices .....	6118
Epics .....	6119
Troubleshooting .....	6126
Related resources .....	6126
Additional information .....	6126
Send telemetry data from Lambda to OpenSearch .....	6130
Summary .....	6130
Prerequisites and limitations .....	6131
Architecture .....	6133
Tools .....	6135
Best practices .....	6136
Epics .....	6139
Troubleshooting .....	6144
Related resources .....	6145
Additional information .....	6145
Set up private access to an Amazon S3 bucket .....	6146
Summary .....	6146
Prerequisites and limitations .....	6146
Architecture .....	6147
Tools .....	6149
Best practices .....	6149
Epics .....	6149
Troubleshooting .....	6152
Related resources .....	6152
Use a serverless approach to chain AWS services together .....	6153
Summary .....	6153



---

Prerequisites and limitations .....	6153
Architecture .....	6154
Tools .....	6155
Epics .....	6156
More patterns .....	6159
<b>Storage &amp; backup .....</b>	<b>6161</b>
Allow EC2 instances write access to S3 buckets in AMS .....	6162
Summary .....	6162
Prerequisites and limitations .....	6162
Architecture .....	6163
Tools .....	6163
Epics .....	6163
Related resources .....	6167
Automate data stream ingestion into a Snowflake database .....	6168
Summary .....	6168
Prerequisites and limitations .....	6168
Architecture .....	6169
Tools .....	6169
Epics .....	6170
Related resources .....	6175
Additional information .....	6175
Automatically encrypt EBS volumes .....	6179
Summary .....	6179
Prerequisites and limitations .....	6179
Architecture .....	6180
Tools .....	6181
Epics .....	6183
Related resources .....	6189
Back up Sun SPARC servers in the Charon-SSP emulator on AWS .....	6191
Summary .....	6191
Prerequisites and limitations .....	6192
Tools .....	6196
Epics .....	6199
Related resources .....	6208
Additional information .....	6208
Attachments .....	6212

---

Back up and archive data to Amazon S3 with Veeam .....	6213
Summary .....	6213
Prerequisites and limitations .....	6214
Architecture .....	6215
Tools .....	6217
Best practices .....	6218
Epics .....	6219
Related resources .....	6232
Additional information .....	6233
Configure NetBackup for VMware Cloud on AWS .....	6237
Summary .....	6237
Prerequisites and limitations .....	6238
Architecture .....	6239
Tools .....	6240
Epics .....	6241
Related resources .....	6244
Copy S3 objects between accounts and Regions by using AWS CLI .....	6245
Summary .....	6245
Prerequisites and limitations .....	6246
Architecture .....	6246
Tools .....	6247
Best practices .....	6247
Epics .....	6247
Troubleshooting .....	6258
Related resources .....	6258
Copy S3 objects between accounts and Regions by using S3 Batch Replication .....	6259
Summary .....	6259
Prerequisites and limitations .....	6259
Architecture .....	6260
Tools .....	6260
Best practices .....	6261
Epics .....	6261
Related resources .....	6271
Migrate Hadoop data to Amazon S3 using DistCp and AWS PrivateLink for Amazon S3 .....	6272
Summary .....	6272
Prerequisites and limitations .....	6272

---

Architecture .....	6273
Tools .....	6274
Epics .....	6275
Use CloudEndure for disaster recovery on premises .....	6286
Summary .....	6286
Prerequisites and limitations .....	6287
Architecture .....	6287
Tools .....	6288
Epics .....	6288
Related resources .....	6302
More patterns .....	6304
<b>Web &amp; mobile apps .....</b>	<b>6306</b>
Authenticate React web application users .....	6307
Summary .....	6307
Prerequisites and limitations .....	6307
Architecture .....	6308
Tools .....	6308
Best practices .....	6309
Epics .....	6309
Troubleshooting .....	6315
Related resources .....	6316
Additional information .....	6316
Continuously deploy an Amplify web application .....	6318
Summary .....	6318
Prerequisites and limitations .....	6319
Architecture .....	6319
Tools .....	6320
Epics .....	6321
Related resources .....	6325
Create a React app by using AWS Amplify and Amazon Cognito .....	6327
Summary .....	6327
Prerequisites and limitations .....	6327
Architecture .....	6327
Tools .....	6328
Epics .....	6328
Related resources .....	6342

Deploy a React-based SPA to Amazon S3 and CloudFront .....	6343
Summary .....	6343
Prerequisites and limitations .....	6343
Architecture .....	6344
Tools .....	6345
Epics .....	6346
Additional information .....	6350
Deploy an Amazon API Gateway API using private endpoints and an Application Load Balancer .....	6351
Summary .....	6351
Prerequisites and limitations .....	6351
Architecture .....	6352
Tools .....	6354
Epics .....	6354
Related resources .....	6358
Embed an Amazon QuickSight dashboard in a local Angular application .....	6359
Summary .....	6359
Prerequisites and limitations .....	6359
Architecture .....	6360
Tools .....	6361
Epics .....	6361
Related resources .....	6376
Additional information .....	6377
Explore web app development with Green Boost .....	6378
Summary .....	6378
Prerequisites and limitations .....	6378
Architecture .....	6379
Tools .....	6381
Best practices .....	6382
Epics .....	6383
Troubleshooting .....	6403
Related resources .....	6404
Run unit tests by using AWS CodeBuild .....	6406
Summary .....	6406
Prerequisites and limitations .....	6406
Architecture .....	6407

---

Tools .....	6407
Epics .....	6408
Related resources .....	6411
Additional information .....	6412
More patterns .....	6415

# AWS Prescriptive Guidance Patterns

Amazon Web Services (AWS) Prescriptive Guidance patterns provide step-by-step instructions, architecture, tools, and code for implementing specific cloud migration, modernization, and deployment scenarios. These patterns, which are vetted by subject matter experts at AWS, are meant for builders and hands-on users who are planning to, or are in the process of, migrating to AWS. They also support users who are already on AWS and are looking for ways to optimize or modernize their cloud operations.

You can use these patterns to move your on-premises or cloud workloads of varying complexity to AWS and to accelerate your cloud adoption, optimization, and modernization efforts, regardless of whether you're in the proof of concept, planning, or implementation phase of your project. For example, for a cloud migration project:

- In the planning phase, you can evaluate the different options available to migrate to AWS. You can choose the right pattern that fits your needs, depending on whether you want to relocate, rehost, replatform, or rearchitect. You can also understand the different tools available for migration, and start planning to procure licenses or start initial conversations with vendors.
- In the proof of concept and implementation phases, you can follow the step-by-step instructions provided in the pattern to migrate your workload to AWS. Each pattern includes details such as prerequisites, target reference architectures, tools, step-by-step tasks, best practices, troubleshooting, and code.
- If you're already using the AWS Cloud, you can find patterns that will help you modernize, optimize, scale, and secure your use of cloud resources.

To view lists of patterns by technical domain, use the following links or the filtering and search options on the [AWS Prescriptive Guidance home page](#).

- [Analytics](#)
- [Business productivity](#)
- [Cloud-native](#)
- [Containers & microservices](#)
- [Content delivery](#)
- [Cost management](#)
- [Data lakes](#)

- [Databases](#)
- [DevOps](#)
- [End-user computing](#)
- [High-performance computing](#)
- [Hybrid cloud](#)
- [Infrastructure](#)
- [IoT](#)
- [Machine learning & AI](#)
- [Mainframes](#)
- [Management & governance](#)
- [Messaging & communications](#)
- [Migration](#)
- [Modernization](#)
- [Networking](#)
- [Operating systems](#)
- [Operations](#)
- [SaaS](#)
- [Security, identity, compliance](#)
- [Serverless](#)
- [Software development & testing](#)
- [Storage & backup](#)
- [Web & mobile apps](#)

To view all publications, including guides, strategies, and patterns, see the [AWS Prescriptive Guidance home page](#).

# Analytics

## Topics

- [Analyze Amazon Redshift data in Microsoft SQL Server Analysis Services](#)
- [Analyze and visualize nested JSON data with Amazon Athena and Amazon QuickSight](#)
- [Automate encryption enforcement in AWS Glue using an AWS CloudFormation template](#)
- [Build a video processing pipeline by using Amazon Kinesis Video Streams and AWS Fargate](#)
- [Build an ETL service pipeline to load data incrementally from Amazon S3 to Amazon Redshift using AWS Glue](#)
- [Calculate value at risk \(VaR\) by using AWS services](#)
- [Convert the Teradata NORMALIZE temporal feature to Amazon Redshift SQL](#)
- [Convert the Teradata RESET WHEN feature to Amazon Redshift SQL](#)
- [Enforce tagging of Amazon EMR clusters at launch](#)
- [Ensure Amazon EMR logging to Amazon S3 is enabled at launch](#)
- [Generate test data using an AWS Glue job and Python](#)
- [Cost-effectively ingest IoT data directly into Amazon S3 using AWS IoT Greengrass](#)
- [Launch a Spark job in a transient EMR cluster using a Lambda function](#)
- [Migrate Apache Cassandra workloads to Amazon Keyspaces by using AWS Glue](#)
- [Migrate Oracle Business Intelligence 12c to the AWS Cloud from on-premises servers](#)
- [Migrate an on-premises Apache Kafka cluster to Amazon MSK by using MirrorMaker](#)
- [Migrate an ELK Stack to Elastic Cloud on AWS](#)
- [Migrate data to the AWS Cloud by using Starburst](#)
- [Optimize the ETL ingestion of input file size on AWS](#)
- [Orchestrate an ETL pipeline with validation, transformation, and partitioning using AWS Step Functions](#)
- [Perform advanced analytics using Amazon Redshift ML](#)
- [Access, query, and join Amazon DynamoDB tables using Athena](#)
- [Set up a minimum viable data space to share data between organizations](#)
- [Set up language-specific sorting for Amazon Redshift query results using a scalar Python UDF](#)
- [Subscribe a Lambda function to event notifications from S3 buckets in different AWS Regions](#)



- [Three AWS Glue ETL job types for converting data to Apache Parquet](#)
- [Visualize Amazon Redshift audit logs using Amazon Athena and Amazon QuickSight](#)
- [Visualize IAM credential reports for all AWS accounts using Amazon QuickSight](#)
- [More patterns](#)

# Analyze Amazon Redshift data in Microsoft SQL Server Analysis Services

*Created by Sunil Vora (AWS)*

<b>Environment:</b> PoC or pilot	<b>Source:</b> Amazon Redshift	<b>Target:</b> Microsoft SQL Server Analysis Services
<b>R Type:</b> N/A	<b>Workload:</b> Microsoft	<b>Technologies:</b> Analytics
<b>AWS services:</b> Amazon Redshift		

## Summary

This pattern describes how to connect and analyze Amazon Redshift data in Microsoft SQL Server Analysis Services, by using the Intellisoft OLE DB Provider or CData ADO.NET Provider for database access.

Amazon Redshift is a fully managed, petabyte-scale data warehouse service in the cloud. SQL Server Analysis Services is an online analytical processing (OLAP) tool that you can use to analyze data from data marts and data warehouses such as Amazon Redshift. You can use SQL Server Analysis Services to create OLAP cubes from your data for rapid, advanced data analysis.

## Prerequisites and limitations

### Assumptions

- This pattern describes how to set up SQL Server Analysis Services and Intellisoft OLE DB Provider or CData ADO.NET Provider for Amazon Redshift on an Amazon Elastic Compute Cloud (Amazon EC2) instance. Alternatively, you can install both on a host in your corporate data center.

### Prerequisites

- An active AWS account
- An Amazon Redshift cluster with credentials

# Architecture

## Source technology stack

- An Amazon Redshift cluster

## Target technology stack

- Microsoft SQL Server Analysis Services

## Source and target architecture

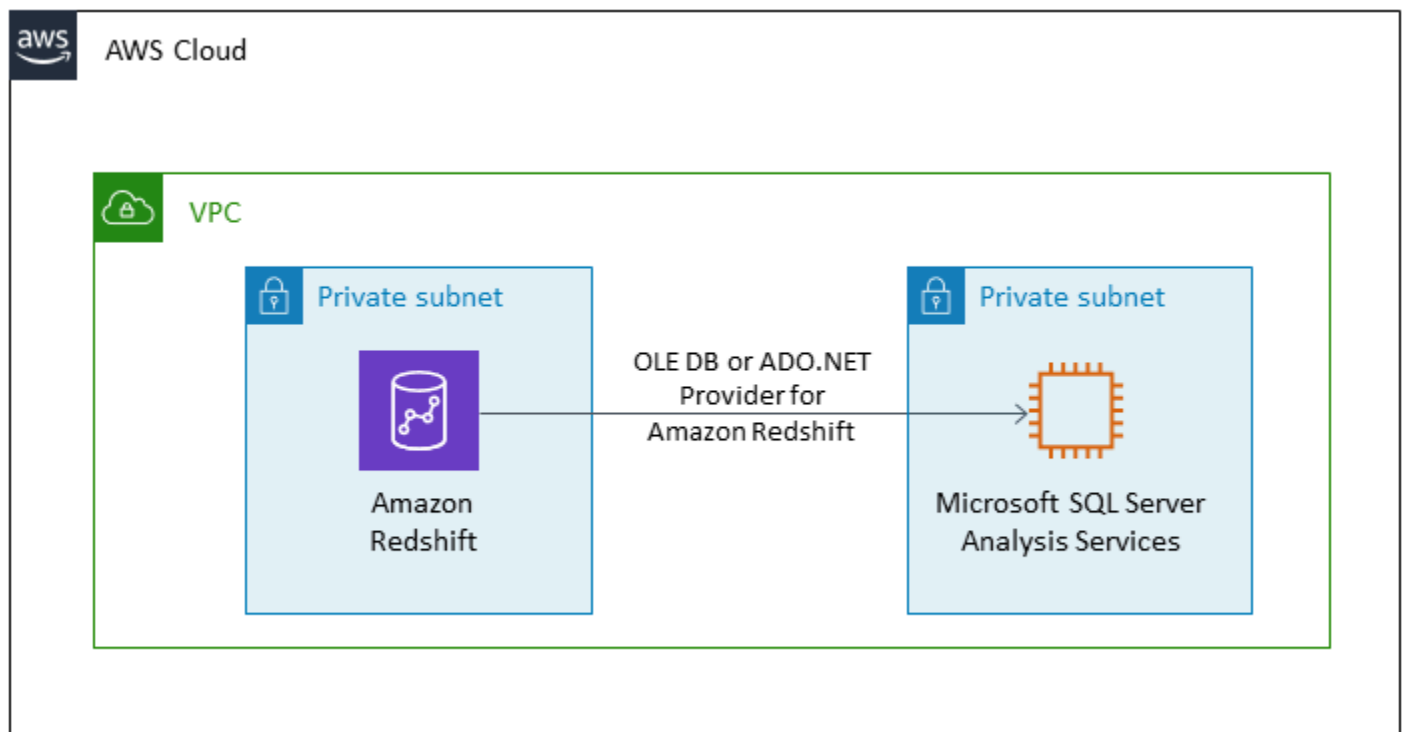

## Tools

- [Microsoft Visual Studio 2019 \(Community Edition\)](#)
- [Intellisoft OLE DB Provider for Amazon Redshift \(Trial\)](#) or [CData ADO.NET Provider for Amazon Redshift \(Trial\)](#)

## Epics

### Analyze tables

Task	Description	Skills required
Analyze the tables and data to be imported.	Identify the Amazon Redshift tables to be imported and their sizes.	DBA

### Set up EC2 instance and install tools

Task	Description	Skills required
Set up an EC2 instance.	In your AWS account, create an EC2 instance in a private or public subnet.	Systems administrator
Install tools for database access.	Download and install the <a href="#">Intellisoft OLE DB Provider for Amazon Redshift</a> (or <a href="#">CData ADO.NET Provider for Amazon Redshift</a> ).	Systems administrator
Install Visual Studio.	Download and install <a href="#">Visual Studio 2019 (Community Edition)</a> .	Systems administrator
Install extensions.	Install the <b>Microsoft Analysis Services Projects</b> extension in Visual Studio.	Systems administrator
Create a project.	Create a new tabular model project in Visual Studio to store your Amazon Redshift data. In Visual Studio, choose the <b>Analysis Services Tabular</b>	DBA

Task	Description	Skills required
	<b>Project</b> option when creating your project.	

## Create data source and import tables

Task	Description	Skills required
Create an Amazon Redshift data source.	Create an Amazon Redshift data source by using the Intellisoft OLE DB Provider for Amazon Redshift (or CData ADO.NET Provider for Amazon Redshift) and your Amazon Redshift credentials.	Amazon Redshift, DBA
Import tables.	Select and import tables and views from Amazon Redshift into your SQL Server Analysis Services project.	Amazon Redshift, DBA

## Clean up after migration

Task	Description	Skills required
Delete the EC2 instance.	Delete the EC2 instance you launched previously.	Systems administrator

## Related resources

- [Amazon Redshift](#) (AWS documentation)
- [Install SQL Server Analysis Services](#) (Microsoft documentation)
- [Tabular Model Designer](#) (Microsoft documentation)
- [Overview of OLAP cubes for advanced analytics](#) (Microsoft documentation)

- [Microsoft Visual Studio 2019 \(Community Edition\)](#)
- [Intellisoft OLE DB Provider for Amazon Redshift \(Trial\)](#)
- [CData ADO.NET Provider for Amazon Redshift \(Trial\)](#)

# Analyze and visualize nested JSON data with Amazon Athena and Amazon QuickSight

*Created by Anoop Singh (AWS)*

**Environment:** PoC or pilot

**Technologies:** Analytics;  
Databases

**AWS services:** Amazon  
Athena; Amazon QuickSight

## Summary

This pattern explains how to translate a nested, JSON-formatted data structure into a tabular view by using Amazon Athena, and then visualize the data in Amazon QuickSight.

You can use JSON-formatted data for API-powered data feeds from operational systems to create data products. This data can also help you understand your customers and their interactions with your products better, so you can tailor user experiences and predict outcomes.

## Prerequisites and limitations

### Prerequisites

- An active AWS account
- A JSON file that represents a nested data structure (this pattern provides a sample file)

### Limitations:

- JSON features integrate well with existing SQL-oriented functions in Athena. However, they aren't ANSI SQL compatible, and the JSON file is expected to carry each record on a separate line. You might need to use the `ignore.malformed.json` property in Athena to indicate if malformed JSON records should be turned into null characters or generate errors. For more information, see [Best practices for reading JSON data](#) in the Athena documentation.
- This pattern considers only simple and small amounts of JSON-formatted data. If you want to use these concepts at scale, consider applying data partitioning and consolidate your data into larger files.

## Architecture

The following diagram shows the architecture and workflow for this pattern. The nested data structures are stored in Amazon Simple Storage Service (Amazon S3) in JSON format. In Athena, the JSON data is mapped to an Athena data structure. You then create a view to analyze the data, and visualize the data structure in QuickSight.

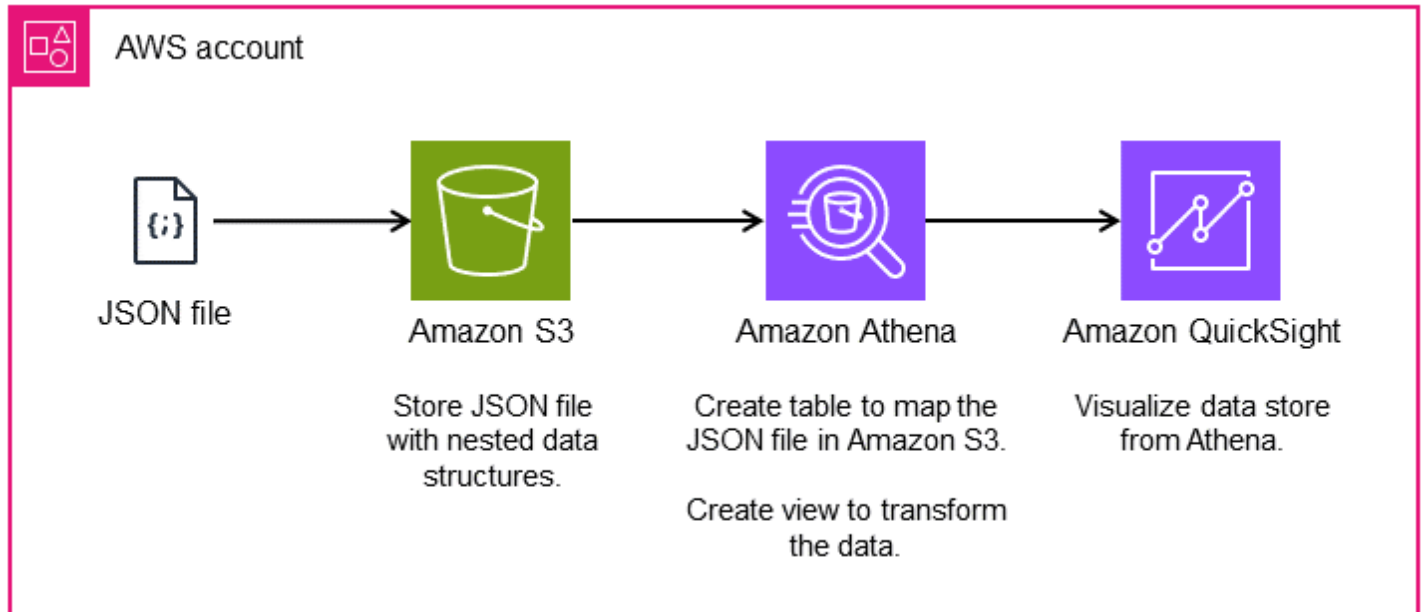

## Tools

### AWS services

- [Amazon Simple Storage Service \(Amazon S3\)](#) is a cloud-based object storage service that helps you store, protect, and retrieve any amount of data. This pattern uses Amazon S3 to store the JSON file.
- [Amazon Athena](#) is an interactive query service that helps you analyze data directly in Amazon S3 by using standard SQL. This pattern uses Athena to query and transform the JSON data. With a few actions in the AWS Management Console, you can point Athena at your data in Amazon S3 and use standard SQL to run one-time queries. Athena is serverless, so there is no infrastructure to set up or manage, and you pay only for the queries that you run. Athena scales automatically and runs queries in parallel, so results are fast, even with large datasets and complex queries.
- [Amazon QuickSight](#) is a cloud-scale business intelligence (BI) service that helps you visualize, analyze, and report your data on a single dashboard. QuickSight lets you easily create and



publish interactive dashboards that include machine learning (ML) insights. You can access these dashboards from any device, and embed them into your applications, portals, and websites.

## Example code

The following JSON file provides a nested data structure that you can use in this pattern.

```
{
  "symbol": "AAPL",
  "financials": [
    {
      "reportDate": "2017-03-31",
      "grossProfit": 20591000000,
      "costOfRevenue": 32305000000,
      "operatingRevenue": 52896000000,
      "totalRevenue": 52896000000,
      "operatingIncome": 14097000000,
      "netIncome": 11029000000,
      "researchAndDevelopment": 2776000000,
      "operatingExpense": 6494000000,
      "currentAssets": 101990000000,
      "totalAssets": 334532000000,
      "totalLiabilities": 200450000000,
      "currentCash": 15157000000,
      "currentDebt": 13991000000,
      "totalCash": 67101000000,
      "totalDebt": 98522000000,
      "shareholderEquity": 134082000000,
      "cashChange": -1214000000,
      "cashFlow": 12523000000,
      "operatingGainsLosses": null
    }
  ]
}
```

## Epics

### Set up an S3 bucket

Task	Description	Skills required
Create an S3 bucket.	To create a bucket to store the JSON file, sign in to the AWS Management Console, open the <a href="#">Amazon S3 console</a> , and then choose <b>Create bucket</b> . For more information, see <a href="#">Creating a bucket</a> in the Amazon S3 documentation.	Systems administrator
Add the nested JSON data.	Upload your JSON file to the S3 bucket. For a sample JSON file, see the previous section. For instructions, see <a href="#">Uploading objects</a> in the Amazon S3 documentation.	Systems administrator

### Analyze data in Athena

Task	Description	Skills required
Create a table for mapping the JSON data.	<ol style="list-style-type: none"><li>1. Open the <a href="#">Athena console</a>.</li><li>2. Create a database by following the instructions in the <a href="#">Athena documentation</a>.</li><li>3. From the <b>Database</b> menu, choose the database that you created.</li></ol>	Developer

Task	Description	Skills required
	<p>4. In the query editor, enter a CREATE TABLE statement such as the following:</p> <pre data-bbox="630 380 1029 1331">CREATE EXTERNAL TABLE   financials_json (     symbol string,     financials array&lt;       struct&lt;re portdate: string,                 grossprof it: bigint,                 totalreve nue: bigint,                 totalcash : bigint,                 totaldebt : bigint,                 researcha nddevelopment:   bigint&gt;&gt;     ) ROW FORMAT SERDE   'org.openx.data.js onserde.JsonSerDe' LOCATION 's3://s3b ucket-for-athena/'</pre> <p>where LOCATION specifies the location of the S3 bucket that contains the JSON file.</p> <p>5. Choose <b>Run</b> to create the table.</p> <p>For more information about creating tables, see the <a href="#">Athena documentation</a>.</p>	

Task	Description	Skills required
Create a view for data analysis.	<ol style="list-style-type: none"><li>1. Open the <a href="#">Athena console</a>.</li><li>2. Create a database by following the instructions in the <a href="#">Athena documentation</a>.</li><li>3. From the <b>Database</b> menu, choose the database that you created.</li><li>4. In the query editor, enter a CREATE VIEW statement such as the following:<pre data-bbox="633 808 1031 1717">CREATE OR REPLACE VIEW financial_json_view AS SELECT symbol, financials[1].report_date one_report_date, -- indexes start with 1 financials[1].total_revenue one_total_revenue, financials[1].report_date another_report_date, financials[1].total_revenue another_total_revenue FROM financials_json where symbol='AAPL' ORDER BY 1</pre></li><li>5. Choose <b>Run</b> to create the view.</li></ol>	Developer

Task	Description	Skills required
	For more information about creating views, see the <a href="#">Athena documentation</a> .	
Analyze and validate the data.	<ol style="list-style-type: none"> <li>1. Open the <a href="#">Athena console</a>.</li> <li>2. In the query editor, run queries by using the view that you created in the previous step.</li> <li>3. Validate the data against the JSON file, to confirm that column names and data types are mapped correctly.</li> </ol>	Developer

## Visualize data in QuickSight

Task	Description	Skills required
Set up Athena as a data source in QuickSight.	<ol style="list-style-type: none"> <li>1. Open the <a href="#">QuickSight console</a>.</li> <li>2. Choose <b>Datasets, New dataset</b>.</li> <li>3. Choose Athena as a data source.</li> <li>4. Choose the database that includes the view that you created.</li> <li>5. Choose the view that you want to create a dataset for.</li> </ol>	Systems administrator

Task	Description	Skills required
	<ol style="list-style-type: none"><li>6. On the <b>Finish data set creation</b> page, choose <b>Directly query your data</b>.</li><li>7. Choose <b>Visualize</b>.</li></ol>	
Visualize data in QuickSight.	<ol style="list-style-type: none"><li>1. After you visualize the dataset, choose the visuals from the left pane, and choose fields for the dataset. For more information, see the <a href="#">tutorial</a> in the QuickSight documentation.</li><li>2. Save the changes to the analysis.</li><li>3. Choose <b>Publish dashboard</b> to publish the visuals that you created.</li></ol>	Data analyst

## Related resources

- [Amazon Athena documentation](#)
- [Amazon QuickSight tutorials](#)
- [Working with nested JSON](#) (blog post)

# Automate encryption enforcement in AWS Glue using an AWS CloudFormation template

Created by Diogo Guedes (AWS)

<b>Code repository:</b> <a href="#">AWS Glue Encryption Enforcement</a>	<b>Environment:</b> Production	<b>Technologies:</b> Analytics; Security, identity, compliance
<b>Workload:</b> All other workloads	<b>AWS services:</b> Amazon EventBridge; AWS Glue; AWS KMS; AWS Lambda; AWS CloudFormation	

## Summary

This pattern shows you how to set up and automate encryption enforcement in AWS Glue by using an AWS CloudFormation template. The template creates all the required configurations and resources for enforcing encryption. These resources include an initial configuration, a preventive control created by an Amazon EventBridge rule, and an AWS Lambda function.

## Prerequisites and limitations

### Prerequisites

- An active AWS account
- Permissions to deploy the CloudFormation template and its resources

### Limitations

This security control is regional. You must deploy the security control in each AWS Region where you want to set up encryption enforcement in AWS Glue.

## Architecture

### Target technology stack

- Amazon CloudWatch Logs (from AWS Lambda)
- Amazon EventBridge rule
- AWS CloudFormation stack
- AWS CloudTrail
- AWS Identity and Access Management (IAM) managed role and policy
- AWS Key Management Service (AWS KMS)
- AWS KMS alias
- AWS Lambda function
- AWS Systems Manager Parameter Store

## Target architecture

The following diagram shows how to automate encryption enforcement in AWS Glue.

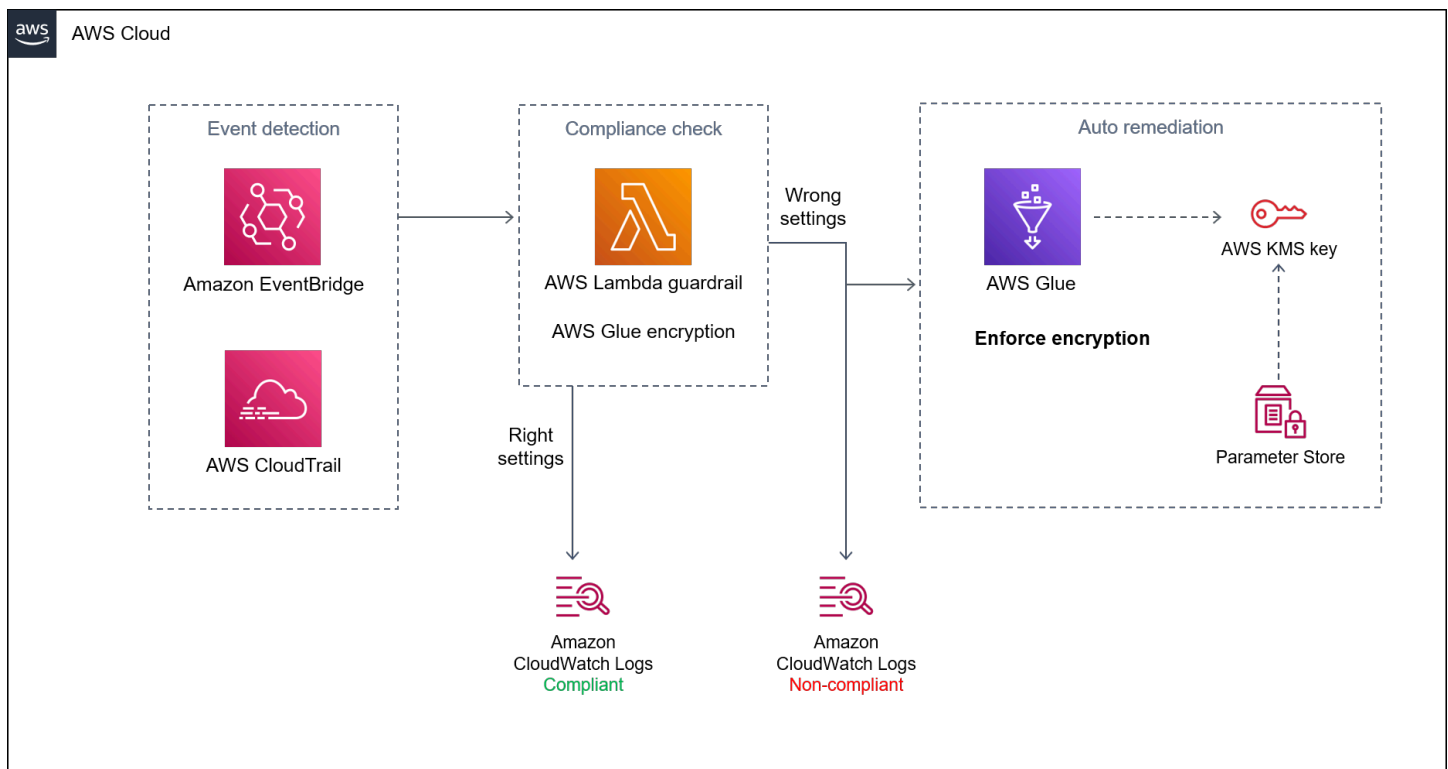

The diagram shows the following workflow:

1. A [CloudFormation template](#) creates all the resources, including the initial configuration and detective control for encryption enforcement in AWS Glue.



2. An EventBridge rule detects a state change in the encryption configuration.
3. A Lambda function is invoked for evaluation and logging through CloudWatch Logs. For non-compliant detection, the Parameter Store is recovered with an Amazon Resource Name (ARN) for an AWS KMS key. The service is remediated to compliant status with encryption enabled.

## Automation and scale

If you're using [AWS Organizations](#), you can use [AWS CloudFormation StackSets](#) to deploy this template in multiple accounts where you want to enable encryption enforcement in AWS Glue.

## Tools

- [Amazon CloudWatch](#) helps you monitor the metrics of your AWS resources and the applications you run on AWS in real time.
- [Amazon EventBridge](#) is a serverless event bus service that helps you connect your applications with real-time data from a variety of sources. For example, Lambda functions, HTTP invocation endpoints using API destinations, or event buses in other AWS accounts.
- [AWS CloudFormation](#) helps you set up AWS resources, provision them quickly and consistently, and manage them throughout their lifecycle across AWS accounts and Regions.
- [AWS CloudTrail](#) helps you enable operational and risk auditing, governance, and compliance of your AWS account.
- [AWS Glue](#) is a fully managed extract, transform, and load (ETL) service. It helps you reliably categorize, clean, enrich, and move data between data stores and data streams.
- [AWS Key Management Service \(AWS KMS\)](#) helps you create and control cryptographic keys to help protect your data.
- [AWS Lambda](#) is a compute service that helps you run code without needing to provision or manage servers. It runs your code only when needed and scales automatically, so you pay only for the compute time that you use.
- [AWS Systems Manager](#) helps you manage your applications and infrastructure running in the AWS Cloud. It simplifies application and resource management, shortens the time to detect and resolve operational problems, and helps you manage your AWS resources securely at scale.

## Code

The code for this pattern is available in the GitHub [aws-custom-guardrail-event-driven](#) repository.

## Best practices

AWS Glue supports data encryption at rest for [authoring jobs in AWS Glue](#) and [developing scripts using development endpoints](#).

Consider the following best practices:

- Configure ETL jobs and development endpoints to use AWS KMS keys to write encrypted data at rest.
- Encrypt the metadata stored in the [AWS Glue Data Catalog](#) by using keys that you manage through AWS KMS.
- Use AWS KMS keys to encrypt job bookmarks and the logs generated by [crawlers](#) and ETL jobs.

## Epics

### Launch the CloudFormation template

Task	Description	Skills required
Deploy the CloudFormation template.	<p>Download the <code>aws-custom-guardrail-event-driven.yaml</code> template from the GitHub <a href="#">repository</a>, and then <a href="#">deploy</a> the template. The <code>CREATE_COMPLETE</code> status indicates that your template was successfully deployed.</p> <p><b>Note:</b> The template requires no input parameters.</p>	Cloud architect

## Verify the encryption settings in AWS Glue

Task	Description	Skills required
Check the AWS KMS key configurations.	<ol style="list-style-type: none"><li>1. Sign in to the AWS Management Console and then open the <a href="#">AWS Glue console</a>.</li><li>2. In the navigation pane, under <b>Data Catalog</b>, choose <b>Catalog settings</b>.</li><li>3. Verify that the <b>Metadata encryption</b> and <b>Encrypt connection passwords</b> settings are flagged and configured to use <code>KMSKeyGlue</code>.</li></ol>	Cloud architect

## Test the encryption enforcement

Task	Description	Skills required
Identify the encryption setting in CloudFormation.	<ol style="list-style-type: none"><li>1. Sign in to the AWS Management Console and then open the <a href="#">CloudFormation console</a>.</li><li>2. In the navigation pane, choose <b>Stacks</b>, and then choose your stack.</li><li>3. Choose the <b>Resources</b> tab.</li><li>4. In the <b>Resources</b> table, find the encryption setting by <b>Logical ID</b>.</li></ol>	Cloud architect

Task	Description	Skills required
Switch the provisioned infrastructure to an uncompliant state.	<ol style="list-style-type: none"><li>1. Sign in to the AWS Management Console and then open the <a href="#">AWS Glue console</a>.</li><li>2. In the navigation pane, under <b>Data Catalog</b>, choose <b>Catalog settings</b>.</li><li>3. Clear the <b>Metadata encryption</b> check box.</li><li>4. Clear the <b>Encrypt connection passwords</b> check box.</li><li>5. Choose <b>Save</b>.</li><li>6. Refresh the AWS Glue console.</li></ol> <p>The guardrail detects the uncompliant state in AWS Glue after you clear the check boxes, and then enforces compliance by automatically remediating the encryption misconfiguration. As a result, the encryption check boxes should again be selected after you refresh the page.</p>	Cloud architect

## Related resources

- [Creating a stack on the AWS CloudFormation console](#) (AWS CloudFormation documentation)
- [Creating a CloudWatch Events rule that triggers on an AWS API call using AWS CloudTrail](#) (Amazon CloudWatch documentation)

- [Setting up encryption in AWS Glue](#) (AWS Glue documentation)

# Build a video processing pipeline by using Amazon Kinesis Video Streams and AWS Fargate

Created by Piotr Chotkowski (AWS) and Pushparaju Thangavel (AWS)

**Environment:** PoC or pilot

**Technologies:** Analytics;  
Media services

**AWS services:** AWS Fargate;  
Amazon Kinesis; Amazon S3

## Summary

This pattern demonstrates how to use [Amazon Kinesis Video Streams](#) and [AWS Fargate](#) to extract frames from a video stream and store them as image files for further processing in [Amazon Simple Storage Service \(Amazon S3\)](#).

The pattern provides a sample application in the form of a Java Maven project. This application defines the AWS infrastructure by using the [AWS Cloud Development Kit \(AWS CDK\)](#). Both the frame processing logic and the infrastructure definitions are written in the Java programming language. You can use this sample application as a basis for developing your own real-time video processing pipeline or to build the video preprocessing step of a machine learning pipeline.

## Prerequisites and limitations

### Prerequisites

- An active AWS account
- Java SE Development Kit (JDK) 11, installed
- [Apache Maven](#), installed
- [AWS Cloud Development Kit \(AWS CDK\)](#), installed
- [AWS Command Line Interface \(AWS CLI\)](#) version 2, installed
- [Docker](#) (required for building Docker images to use in AWS Fargate task definitions), installed

### Limitations

This pattern is intended as a proof of concept, or as a basis for further development. It should not be used in its current form in production deployments.

## Product versions

- This pattern was tested with the AWS CDK version 1.77.0 (see [AWS CDK versions](#))
- JDK 11
- AWS CLI version 2

## Architecture

### Target technology stack

- Amazon Kinesis Video Streams
- AWS Fargate task
- Amazon Simple Queue Service (Amazon SQS) queue
- Amazon S3 bucket

### Target architecture

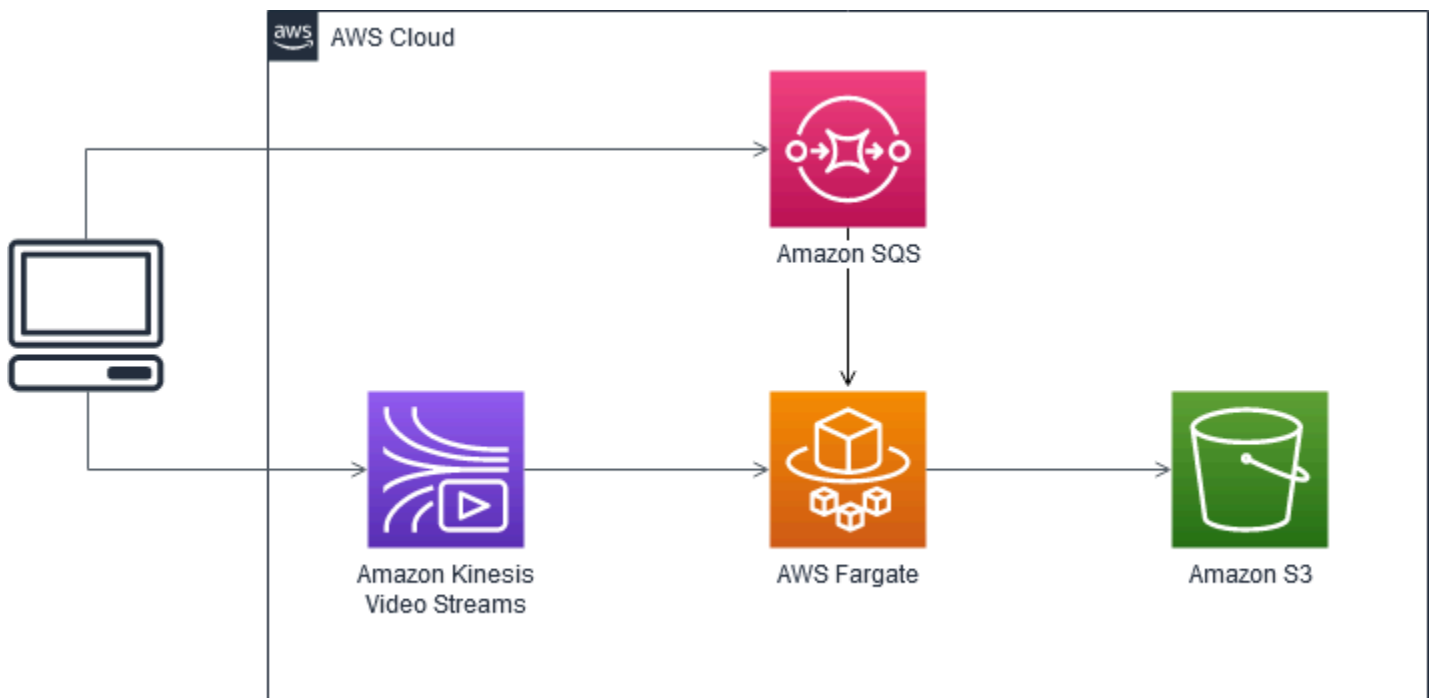

The user creates a Kinesis video stream, uploads a video, and sends a JSON message that contains details about the input Kinesis video stream and the output S3 bucket to an SQS queue. AWS Fargate, which is running the main application in a container, pulls the message from the SQS

queue and starts extracting frames. Each frame is saved in an image file and stored in the target S3 bucket.

## Automation and scale

The sample application can scale both horizontally and vertically within a single AWS Region. Horizontal scaling can be achieved by increasing the number of deployed AWS Fargate tasks that read from the SQS queue. Vertical scaling can be achieved by increasing the number of frame-splitting and image-publishing threads in the application. These settings are passed as environment variables to the application in the definition of the [QueueProcessingFargateService](#) resource in the AWS CDK. Due to the nature of AWS CDK stack deployment, you can deploy this application in multiple AWS Regions and accounts with no additional effort.

## Tools

### Tools

- [AWS CDK](#) is a software development framework for defining your cloud infrastructure and resources by using programming languages such as TypeScript, JavaScript, Python, Java, and C#/.Net.
- [Amazon Kinesis Video Streams](#) is a fully managed AWS service that you can use to stream live video from devices to the AWS Cloud, or build applications for real-time video processing or batch-oriented video analytics.
- [AWS Fargate](#) is a serverless compute engine for containers. Fargate removes the need to provision and manage servers, and lets you focus on developing your applications.
- [Amazon S3](#) is an object storage service that offers scalability, data availability, security, and performance.
- [Amazon SQS](#) is a fully managed message queuing service that enables you to decouple and scale microservices, distributed systems, and serverless applications.

### Code

- A .zip file of the sample application project (`frame-splitter-code.zip`) is attached.



# Epics

## Deploy the infrastructure

Task	Description	Skills required
Start the Docker daemon.	Start the Docker daemon on your local system. The AWS CDK uses Docker to build the image that is used in the AWS Fargate task. You must run Docker before you proceed to the next step.	Developer, DevOps engineer
Build the project.	Download the <code>frame-splitter-code</code> sample application (attached) and extract its contents into a folder on your local machine. Before you can deploy the infrastructure, you have to build the <a href="#">Java Maven</a> project. At a command prompt, navigate to the root directory of the project, and build the project by running the command: <pre>mvn clean install</pre>	Developer, DevOps engineer
Bootstrap the AWS CDK.	(First-time AWS CDK users only) If this is the first time you're using the AWS CDK, you might have to bootstrap the environment by running the AWS CLI command:	Developer, DevOps engineer

Task	Description	Skills required
	<pre data-bbox="597 218 1026 327">cdk bootstrap --profile "\$AWS_PROFILE_NAME"</pre> <p data-bbox="591 365 1032 735">where <code>\$AWS_PROFILE_NAME</code> holds the name of the AWS profile from your AWS credentials. Or, you can remove this parameter to use the default profile. For more information, see the <a href="#">AWS CDK documentation</a>.</p>	

Task	Description	Skills required
Deploy the AWS CDK stack.	<p>In this step, you create the required infrastructure resources (SQS queue, S3 bucket, AWS Fargate task definition) in your AWS account, build the Docker image that is required for the AWS Fargate task, and deploy the application. At a command prompt, navigate to the root directory of the project, and run the command:</p> <pre data-bbox="594 871 1027 1031">cdk deploy --profile "\$AWS_PROFILE_NAME" --all</pre> <p>where <code>\$AWS_PROFILE_NAME</code> holds the name of the AWS profile from your AWS credentials. Or, you can remove this parameter to use the default profile. Confirm the deployment. Note the <b>QueueUrl</b> and <b>Bucket</b> values from the CDK deployment output; you will need these in later steps. The AWS CDK creates the assets, uploads them to your AWS account, and creates all infrastructure resources. You can observe the resource creation process in the <a href="#">AWS CloudFormation</a></p>	Developer, DevOps engineer

Task	Description	Skills required
	<p><a href="#">console</a>. For more information, see the <a href="#">AWS CloudFormation documentation</a> and the <a href="#">AWS CDK documentation</a>.</p>	

Task	Description	Skills required
Create a video stream.	<p>In this step, you create a Kinesis video stream that will serve as an input stream for video processing. Make sure that you have the AWS CLI installed and configured. In the AWS CLI, run:</p> <pre data-bbox="594 583 1029 903">aws kinesismedia   --profile "\$AWS_PRO FILE_NAME" create-st ream --stream-name   "\$STREAM_NAME" --data- retention-in-hours   "24"</pre> <p>where <code>\$AWS_PROFILE</code> holds the name of the AWS profile from your AWS credentials (or remove this parameter to use the default profile) and <code>\$STREAM_NAME</code> is any valid stream name.</p> <p>Alternatively, you can create a video stream by using the Kinesis console by following the steps in the <a href="#">Kinesis Video Streams documentation</a>.</p> <p>Note the AWS Resource Name (ARN) of the created stream; you will need it later.</p>	Developer, DevOps engineer

## Run an example

Task	Description	Skills required
Upload the video to the stream.	<p>In the project folder for the <code>sample frame-splitter-code</code> application, open the <code>ProcessingTaskTest.java</code> file in the <code>src/test/java/amazon/awscdk/examples/splitter</code> folder. Replace the <code>profileName</code> and <code>streamName</code> variables with the values you used in the previous steps. To upload the example video to the Kinesis video stream you created in the previous step, run:</p> <pre>amazon.awscdk.examples.splitter.ProcessingTaskTest#testExample test</pre> <p>Alternatively, you can upload your video by using one of the methods described in the <a href="#">Kinesis Video Streams documentation</a>.</p>	Developer, DevOps engineer
Initiate video processing.	<p>Now that you have uploaded a video to the Kinesis video stream, you can start processing it. To initiate the processing logic, you have to send a message with</p>	Developer, DevOps engineer

Task	Description	Skills required
	<p>details to the SQS queue that the AWS CDK created during deployment. To send a message by using the AWS CLI, run:</p> <pre>aws sqs --profile "\$AWS_PROFILE_NAME" send-message --queue-url QUEUE_URL --message-body MESSAGE</pre> <p>where <code>\$AWS_PROFILE_NAME</code> holds the name of the AWS profile from your AWS credentials (remove this parameter to use the default profile), <code>QUEUE_URL</code> is the <b>QueueUrl</b> value from the AWS CDK output, and <code>MESSAGE</code> is a JSON string in the following format:</p> <pre>{ "streamARN": "STREAM_ARN", "bucket": "BUCKET_NAME", "s3Directory": "test-output" }</pre> <p>where <code>STREAM_ARN</code> is the ARN of the video stream you created in an earlier step and <code>BUCKET_NAME</code> is the <b>Bucket</b> value from the AWS CDK output.</p>	

Task	Description	Skills required
	Sending this message initiates video processing. Alternatively, you can send a message by using the Amazon SQS console, as described in the <a href="#">Amazon SQS documentation</a> .	
View images of the video frames.	You can see the resulting images in the S3 output bucket <code>s3://BUCKET_NAME/test-output</code> where <code>BUCKET_NAME</code> is the <b>Bucket</b> value from the AWS CDK output.	Developer, DevOps engineer

## Related resources

- [AWS CDK documentation](#)
- [AWS CDK API reference](#)
- [AWS CDK introductory workshop](#)
- [Amazon Kinesis Video Streams documentation](#)
- [Example: Identifying Objects in Video Streams Using SageMaker](#)
- [Example: Parsing and Rendering Kinesis Video Streams Fragments](#)
- [Analyze live video at scale in real time using Amazon Kinesis Video Streams and Amazon SageMaker](#) (AWS Machine Learning blog post)
- [AWS Fargate Getting Started](#)

## Additional information

### Choosing an IDE

We recommend that you use your favorite Java IDE to build and explore this project.

### Cleaning up



After you finish running this example, remove all deployed resources to avoid incurring additional AWS infrastructure costs.

To remove the infrastructure and the video stream, use these two commands in the AWS CLI:

```
cdk destroy --profile "$AWS_PROFILE_NAME" --all
```

```
aws kinesisanalyticsv2 --profile "$AWS_PROFILE_NAME" delete-stream --stream-arn "$STREAM_ARN"
```

Alternatively, you can remove the resources manually by using the AWS CloudFormation console to remove the AWS CloudFormation stack, and the Kinesis console to remove the Kinesis video stream. Note that `cdk destroy` doesn't remove the output S3 bucket or the images in Amazon Elastic Container Registry (Amazon ECR) repositories (`aws-cdk/assets`). You have to remove them manually.

## Attachments

To access additional content that is associated with this document, unzip the following file:

[attachment.zip](#)

# Build an ETL service pipeline to load data incrementally from Amazon S3 to Amazon Redshift using AWS Glue

Created by Rohan Jamadagni (AWS) and Arunabha Datta (AWS)

**Environment:** Production

**Technologies:** Analytics;  
Data lakes; Storage & backup

**AWS services:** Amazon  
Redshift; Amazon S3; AWS  
Glue; AWS Lambda

## Summary

This pattern provides guidance on how to configure Amazon Simple Storage Service (Amazon S3) for optimal data lake performance, and then load incremental data changes from Amazon S3 into Amazon Redshift by using AWS Glue, performing extract, transform, and load (ETL) operations.

The source files in Amazon S3 can have different formats, including comma-separated values (CSV), XML, and JSON files. This pattern describes how you can use AWS Glue to convert the source files into a cost-optimized and performance-optimized format like Apache Parquet. You can query Parquet files directly from Amazon Athena and Amazon Redshift Spectrum. You can also load Parquet files into Amazon Redshift, aggregate them, and share the aggregated data with consumers, or visualize the data by using Amazon QuickSight.

## Prerequisites and limitations

### Prerequisites

- An active AWS account.
- An S3 source bucket that has the right privileges and contains CSV, XML, or JSON files.

### Assumptions

- The CSV, XML, or JSON source files are already loaded into Amazon S3 and are accessible from the account where AWS Glue and Amazon Redshift are configured.
- Best practices for loading the files, splitting the files, compression, and using a manifest are followed, as discussed in the [Amazon Redshift documentation](#).

- The source file structure is unaltered.
- The source system is able to ingest data into Amazon S3 by following the folder structure defined in Amazon S3.
- The Amazon Redshift cluster spans a single Availability Zone. (This architecture is appropriate because AWS Lambda, AWS Glue, and Amazon Athena are serverless.) For high availability, cluster snapshots are taken at a regular frequency.

## Limitations

- The file formats are limited to those that are [currently supported by AWS Glue](#).
- Real-time downstream reporting isn't supported.

## Architecture

### Source technology stack

- S3 bucket with CSV, XML, or JSON files

### Target technology stack

- S3 data lake (with partitioned Parquet file storage)
- Amazon Redshift

### Target architecture

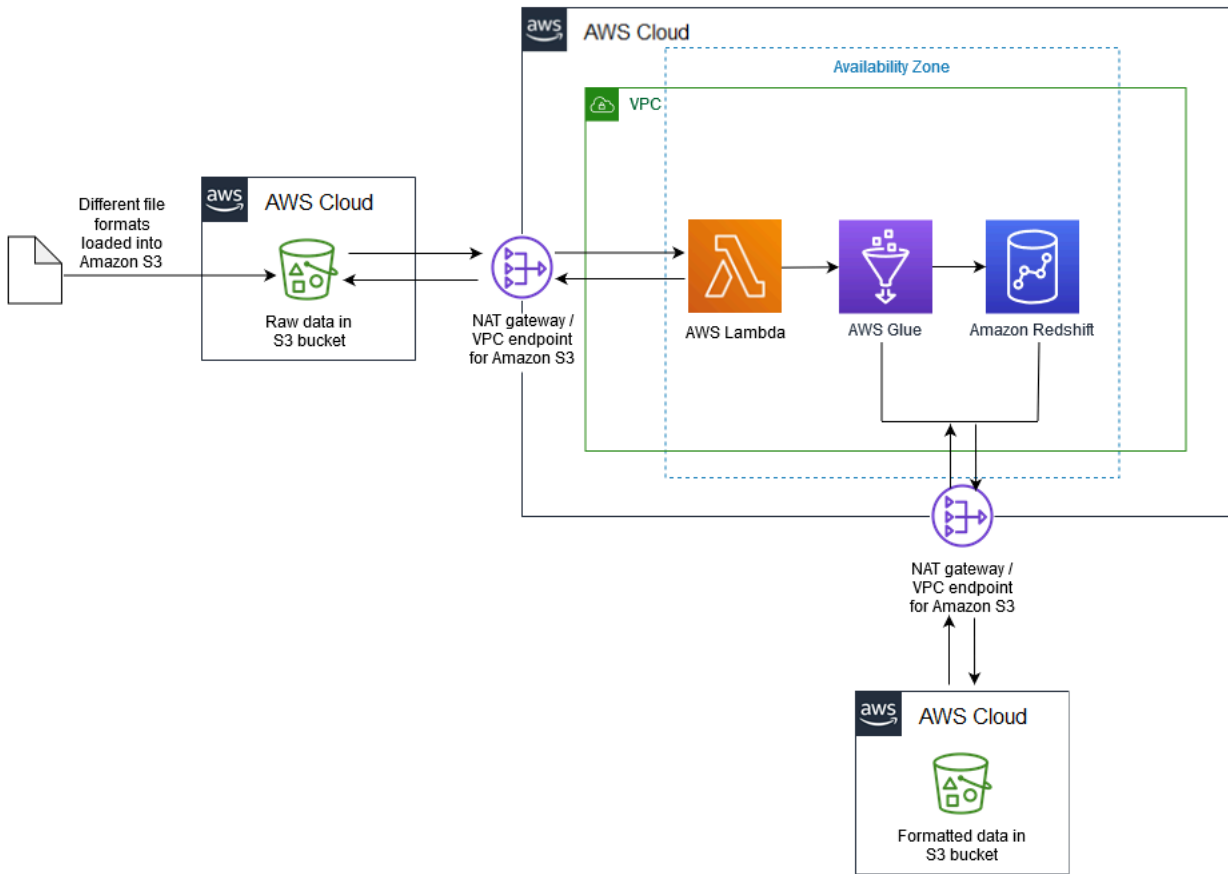

### Data flow

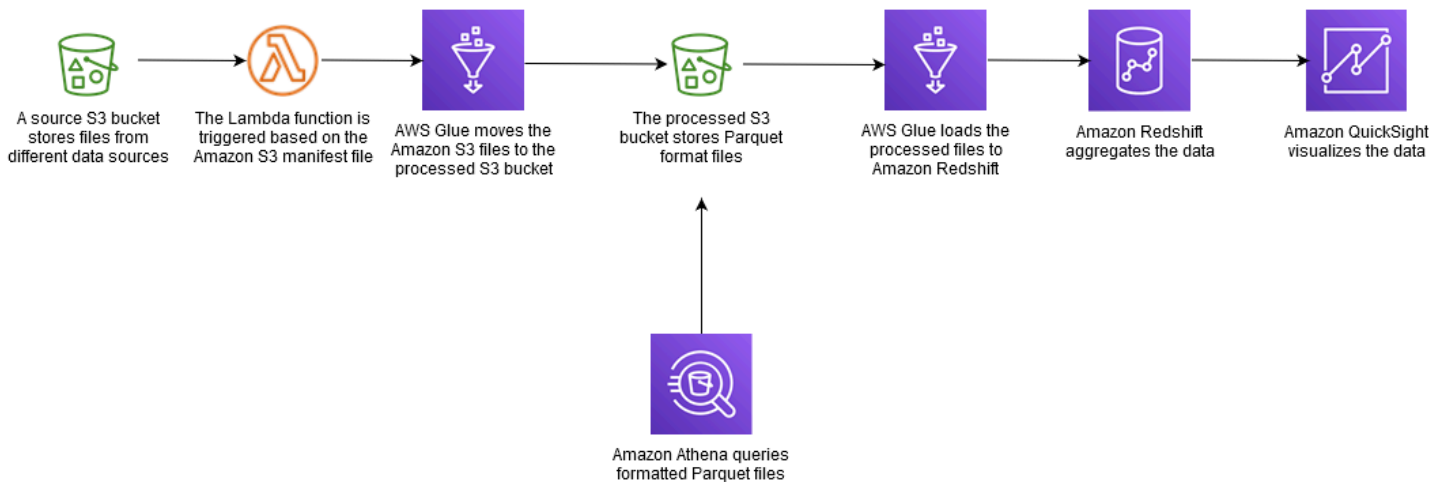

## Tools

- [Amazon S3](#) – Amazon Simple Storage Service (Amazon S3) is a highly scalable object storage service. Amazon S3 can be used for a wide range of storage solutions, including websites, mobile applications, backups, and data lakes.
- [AWS Lambda](#) – AWS Lambda lets you run code without provisioning or managing servers. AWS Lambda is an event-driven service; you can set up your code to automatically initiate from other AWS services.
- [Amazon Redshift](#) – Amazon Redshift is a fully managed, petabyte-scale data warehouse service. With Amazon Redshift, you can query petabytes of structured and semi-structured data across your data warehouse and your data lake using standard SQL.
- [AWS Glue](#) – AWS Glue is a fully managed ETL service that makes it easier to prepare and load data for analytics. AWS Glue discovers your data and stores the associated metadata (for example, table definitions and schema) in the AWS Glue Data Catalog. Your cataloged data is immediately searchable, can be queried, and is available for ETL.
- [AWS Secrets Manager](#) – AWS Secrets Manager facilitates protection and central management of secrets needed for application or service access. The service stores database credentials, API keys, and other secrets, and eliminates the need to hardcode sensitive information in plaintext format. Secrets Manager also offers key rotation to meet security and compliance needs. It has built-in integration for Amazon Redshift, Amazon Relational Database Service (Amazon RDS), and Amazon DocumentDB. You can store and centrally manage secrets by using the Secrets Manager console, the command-line interface (CLI), or Secrets Manager API and SDKs.
- [Amazon Athena](#) – Amazon Athena is an interactive query service that makes it easy to analyze data that's stored in Amazon S3. Athena is serverless and integrated with AWS Glue, so it can directly query the data that's cataloged using AWS Glue. Athena is elastically scaled to deliver interactive query performance.

## Epics

### Create the S3 buckets and folder structure

Task	Description	Skills required
Analyze source systems for data structure and attributes.	Perform this task for each data source that contributes to the Amazon S3 data lake.	Data engineer
Define the partition and access strategy.	This strategy should be based on the frequency of data captures, delta processing, and consumption needs. Make sure that S3 buckets are not open to the public and that access is controlled by specific service role-based policies only. For more information, see the <a href="#">Amazon S3 documentation</a> .	Data engineer
Create separate S3 buckets for each data source type and a separate S3 bucket per source for the processed (Parquet) data.	Create a separate bucket for each source, and then create a folder structure that's based on the source system's data ingestion frequency ; for example, <code>s3://source-system-name/date/hour</code> . For the processed (converted to Parquet format) files, create a similar structure ; for example, <code>s3://source-processed-bucket/date/hour</code> . For more information about creating S3	Data engineer

Task	Description	Skills required
	buckets, see the <a href="#">Amazon S3 documentation</a> .	

## Create a data warehouse in Amazon Redshift

Task	Description	Skills required
Launch the Amazon Redshift cluster with the appropriate parameter groups and maintenance and backup strategy.	Use the Secrets Manager database secret for admin user credentials while creating the Amazon Redshift cluster. For information about creating and sizing an Amazon Redshift cluster, see the <a href="#">Amazon Redshift documentation</a> and the <a href="#">Sizing Cloud Data Warehouses</a> whitepaper.	Data engineer
Create and attach the IAM service role to the Amazon Redshift cluster.	The AWS Identity and Access Management (IAM) service role ensures access to Secrets Manager and the source S3 buckets. For more information, see the AWS documentation on <a href="#">authorization</a> and <a href="#">adding a role</a> .	Data engineer
Create the database schema.	Follow Amazon Redshift best practices for table design. Based on the use case, choose the appropriate sort and distribution keys, and the best possible compression	Data engineer

Task	Description	Skills required
	encoding. For best practices, see the <a href="#">AWS documentation</a> .	
Configure workload management.	Configure workload management (WLM) queues, short query acceleration (SQA), or concurrency scaling, depending on your requirements. For more information, see <a href="#">Implementing workload management</a> in the Amazon Redshift documentation.	Data engineer

## Create a secret in Secrets Manager

Task	Description	Skills required
Create a new secret to store the Amazon Redshift sign-in credentials in Secrets Manager.	This secret stores the credentials for the admin user as well as individual database service users. For instructions, see the <a href="#">Secrets Manager documentation</a> . Choose <b>Amazon Redshift Cluster</b> as the secret type. Additionally, on the <b>Secret rotation</b> page, turn on the rotation. This will create the appropriate user in the Amazon Redshift cluster and will rotate the key secrets at defined intervals.	Data engineer
Create an IAM policy to restrict Secrets Manager access.	Restrict Secrets Manager access to only Amazon	Data engineer



Task	Description	Skills required
	Redshift administrators and AWS Glue.	

## Configure AWS Glue

Task	Description	Skills required
In the AWS Glue Data Catalog, add a connection for Amazon Redshift.	For instructions, see the <a href="#">AWS Glue documentation</a> .	Data engineer
Create and attach an IAM service role for AWS Glue to access Secrets Manager, Amazon Redshift, and S3 buckets.	For more information, see the <a href="#">AWS Glue documentation</a> .	Data engineer
Define the AWS Glue Data Catalog for the source.	This step involves creating a database and required tables in the AWS Glue Data Catalog. You can either use a crawler to catalog the tables in the AWS Glue database, or define them as Amazon Athena external tables. You can also access the external tables defined in Athena through the AWS Glue Data Catalog. See the AWS documentation for more information about <a href="#">defining the Data Catalog</a> and <a href="#">creating an external table</a> in Athena.	Data engineer

Task	Description	Skills required
Create an AWS Glue job to process source data.	The AWS Glue job can be a Python shell or PySpark to standardize, deduplicate, and cleanse the source data files. To optimize performance and avoid having to query the entire S3 source bucket, partition the S3 bucket by date, broken down by year, month, day, and hour as a pushdown predicate for the AWS Glue job. For more information, see the <a href="#">AWS Glue documentation</a> . Load the processed and transformed data to the processed S3 bucket partitions in Parquet format. You can query the Parquet files from Athena.	Data engineer
Create an AWS Glue job to load data into Amazon Redshift.	The AWS Glue job can be a Python shell or PySpark to load the data by upserting the data, followed by a complete refresh. For details, see the <a href="#">AWS Glue documentation</a> and the <i>Additional information</i> section.	Data engineer

Task	Description	Skills required
(Optional) Schedule AWS Glue jobs by using triggers as necessary.	The incremental data load is primarily driven by an Amazon S3 event that causes an AWS Lambda function to call the AWS Glue job. Use AWS Glue trigger-based scheduling for any data loads that demand time-based instead of event-based scheduling.	Data engineer

## Create a Lambda function

Task	Description	Skills required
Create and attach an IAM service-linked role for AWS Lambda to access S3 buckets and the AWS Glue job.	Create an IAM service-linked role for AWS Lambda with a policy to read Amazon S3 objects and buckets, and a policy to access the AWS Glue API to start an AWS Glue job. For more information, see the <a href="#">Knowledge Center</a> .	Data engineer
Create a Lambda function to run the AWS Glue job based on the defined Amazon S3 event.	The Lambda function should be initiated by the creation of the Amazon S3 manifest file. The Lambda function should pass the Amazon S3 folder location (for example, source_bucket/year/month/date/hour) to the AWS Glue job as a parameter. The AWS Glue job will use this	Data engineer

Task	Description	Skills required
	parameter as a pushdown predicate to optimize file access and job processing performance. For more information, see the <a href="#">AWS Glue documentation</a> .	
Create an Amazon S3 PUT object event to detect object creation, and call the respective Lambda function.	The Amazon S3 PUT object event should be initiated only by the creation of the manifest file. The manifest file controls the Lambda function and the AWS Glue job concurrency, and processes the load as a batch instead of processing individual files that arrive in a specific partition of the S3 source bucket. For more information, see the <a href="#">Lambda documentation</a> .	Data engineer

## Related resources

- [Amazon S3 documentation](#)
- [AWS Glue documentation](#)
- [Amazon Redshift documentation](#)
- [AWS Lambda](#)
- [Amazon Athena](#)
- [AWS Secrets Manager](#)

## Additional information

### Detailed approach for upsert and complete refresh

**Upsert:** This is for datasets that require historical aggregation, depending on the business use case. Follow one of the approaches described in [Updating and inserting new data](#) (Amazon Redshift documentation) based on your business needs.

**Complete refresh:** This is for small datasets that don't need historical aggregations. Follow one of these approaches:

1. Truncate the Amazon Redshift table.
2. Load the current partition from the staging area

or:

1. Create a temporary table with current partition data.
2. Drop the target Amazon Redshift table.
3. Rename the temporary table to the target table.

# Calculate value at risk (VaR) by using AWS services

*Created by Sumon Samanta (AWS)*

**Environment:** PoC or pilot

**Technologies:** Analytics;  
Serverless

**AWS services:** Amazon  
Kinesis Data Streams; AWS  
Lambda; Amazon SQS;  
Amazon ElastiCache

## Summary

This pattern describes how to implement a value at risk (VaR) calculation system by using AWS services. In an on-premises environment, most VaR systems use a large, dedicated infrastructure and in-house or commercial grid scheduling software to run batch processes. This pattern presents a simple, reliable, and scalable architecture to handle VaR processing in the AWS Cloud. It builds a serverless architecture that uses Amazon Kinesis Data Streams as a streaming service, Amazon Simple Queue Service (Amazon SQS) as a managed queue service, Amazon ElastiCache as a caching service, and AWS Lambda to process orders and calculate risk.

VaR is a statistical measure that traders and risk managers use to estimate potential loss in their portfolio beyond a certain confidence level. Most VaR systems involve running a large number of mathematical and statistical calculations and storing the results. These calculations require significant compute resources, so VaR batch processes have to be broken into smaller sets of compute tasks. Splitting a large batch into smaller tasks is possible because these tasks are mostly independent (that is, calculations for one task don't depend on other tasks).

Another important requirement for a VaR architecture is compute scalability. This pattern uses a serverless architecture that automatically scales in or out based on compute load. Because the batch or online compute demand is difficult to predict, dynamic scaling is required to complete the process within the timeline imposed by a service-level agreement (SLA). Also, a cost-optimized architecture should be able to scale down each compute resource as soon as the tasks on that resource are complete.

AWS services are well-suited for VaR calculations because they offer scalable compute and storage capacity, analytics services for processing in a cost-optimized way, and different types of schedulers to run your risk management workflows. Also, you pay only for the compute and storage resources that you use on AWS.

## Prerequisites and limitations

### Prerequisites

- An active AWS account.
- Input files, which depend on your business requirements. A typical use case involves the following input files:
  - Market data file (input to the VaR calculation engine)
  - Trade data file (unless trade data comes through a stream).
  - Configuration data file (model and other static configuration data)
  - Calculation engine model files (quantitative libraries)
  - Time series data file (for historical data such as the stock price for the last five years)
- If the market data or other input comes in through a stream, Amazon Kinesis Data Streams set up, and Amazon Identity and Access Management (IAM) permissions configured to write to the stream.

This pattern builds an architecture in which trade data is written from a trading system to a Kinesis data stream. Instead of using a streaming service, you can save your trade data in small batch files, store them in an Amazon Simple Storage Service (Amazon S3) bucket, and invoke an event to start processing the data.

### Limitations

- Kinesis data stream sequencing is guaranteed on each shard, so trade orders that are written to multiple shards are not guaranteed to be delivered in the same order as write operations.
- The AWS Lambda runtime limit is currently 15 minutes. (For more information, see the [Lambda FAQ](#).)

## Architecture

### Target architecture

The following architecture diagram displays the AWS services and workflows for the risk assessment system.

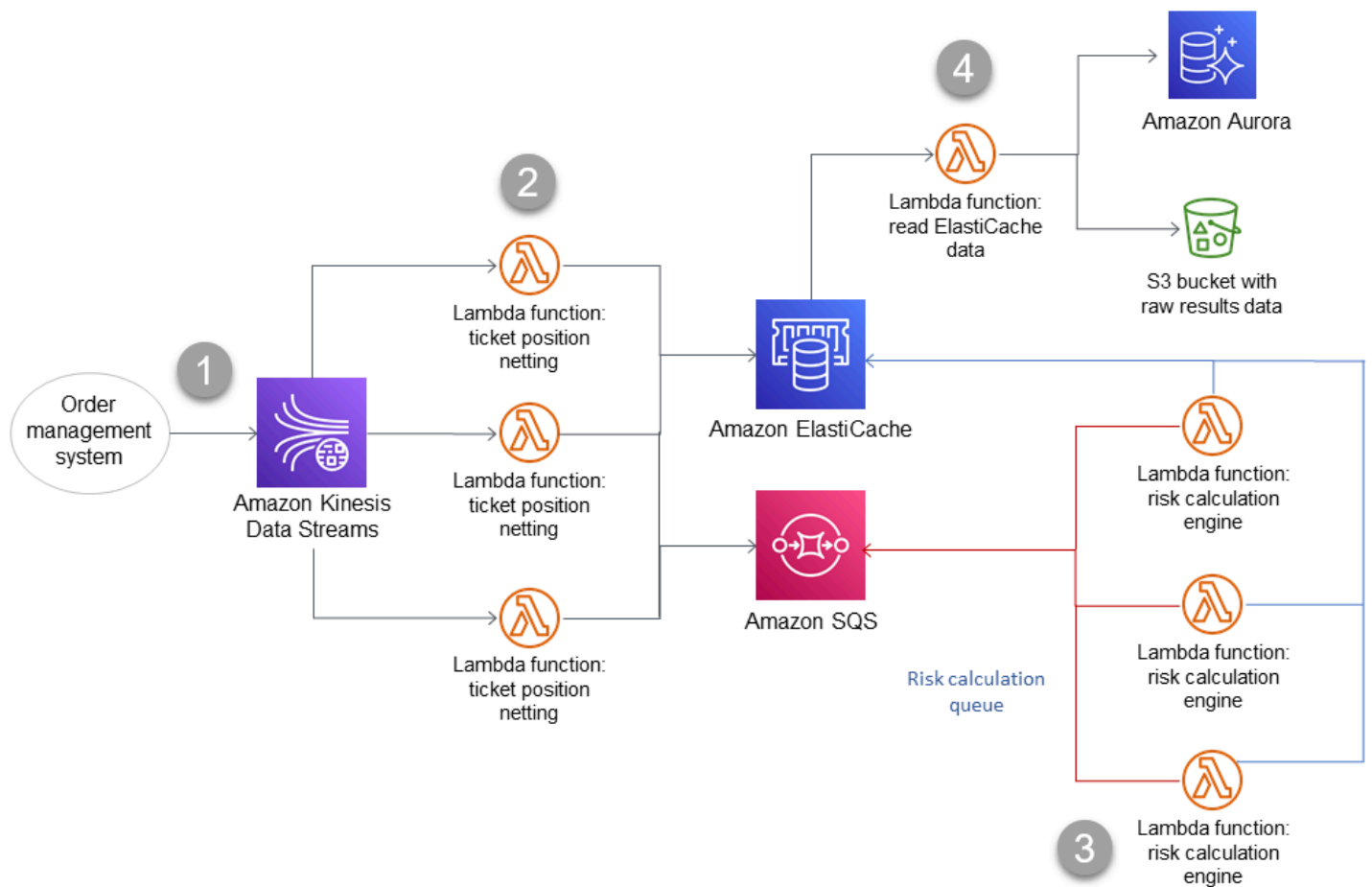

The diagram illustrates the following:

1. Trades stream in from the order management system.
2. The *ticket position netting* Lambda function processes the orders and writes consolidated messages for each ticker to a risk queue in Amazon SQS.
3. The *risk calculation engine* Lambda function processes the messages from Amazon SQS, performs risk calculations, and updates the VaR profit and loss (PnL) information in the risk cache in Amazon ElastiCache.
4. The *read ElastiCache data* Lambda function retrieves the risk results from ElastiCache and stores them in a database and S3 bucket.

For more information about these services and steps, see the *Epics* section.

## Automation and scale



You can deploy the entire architecture by using the AWS Cloud Development Kit (AWS CDK) or AWS CloudFormation templates. The architecture can support both batch processing and intraday (real-time) processing.

Scaling is built into the architecture. As more trades are written into the Kinesis data stream and are waiting to be processed, additional Lambda functions can be invoked to process those trades and can then scale down after processing is complete. Processing through multiple Amazon SQS risk calculation queues is also an option. If strict ordering or consolidation is required across queues, processing cannot be parallelized. However, for an end-of-the-day batch or a mini intraday batch, the Lambda functions can process in parallel and store the final results in ElastiCache.

## Tools

### AWS services

- [Amazon Aurora MySQL-Compatible Edition](#) is a fully managed, MySQL-compatible relational database engine that helps you set up, operate, and scale MySQL deployments. This pattern uses MySQL as an example, but you can use any RDBMS system to store data.
- [Amazon ElastiCache](#) helps you set up, manage, and scale distributed in-memory cache environments in the AWS Cloud.
- [Amazon Kinesis Data Streams](#) helps you collect and process large streams of data records in real time.
- [AWS Lambda](#) is a compute service that helps you run code without needing to provision or manage servers. It runs your code only when needed and scales automatically, so you pay only for the compute time that you use.
- [Amazon Simple Queue Service \(Amazon SQS\)](#) provides a secure, durable, and available hosted queue that helps you integrate and decouple distributed software systems and components.
- [Amazon Simple Storage Service \(Amazon S3\)](#) is a cloud-based object storage service that helps you store, protect, and retrieve any amount of data.

### Code

This pattern provides an example architecture for a VaR system in the AWS Cloud and describes how you can use Lambda functions for VaR calculations. To create your Lambda functions, see the code examples in the [Lambda documentation](#). For assistance, contact [AWS Professional Services](#).

## Best practices

- Keep each VaR compute task as small and lightweight as possible. Experiment with different numbers of trades in each compute task to see which one is most optimized for compute time and cost.
- Store reusable objects in Amazon ElastiCache. Use a framework such as Apache Arrow to reduce serialization and deserialization.
- Consider Lambda's time limitation. If you think your compute tasks might exceed 15 minutes, try to break them down into smaller tasks to avoid the Lambda timeout. If this is not possible, you might consider a container orchestration solution with AWS Fargate, Amazon Elastic Container Service (Amazon ECS), and Amazon Elastic Kubernetes Service (Amazon EKS).

## Epics

### Trade flow to risk system

Task	Description	Skills required
Start writing trades.	New, settled, or partially settled trades are written from the order management system to a risk stream. This pattern uses Amazon Kinesis as the managed streaming service. The trade order ticker's hash is used to put trade orders across multiple shards.	Amazon Kinesis

### Run Lambda functions for order processing

Task	Description	Skills required
Start risk processing with Lambda.	Run an AWS Lambda function for the new orders. Based	Amazon Kinesis, AWS Lambda, Amazon ElastiCache

Task	Description	Skills required
	<p>on the number of pending trade orders, Lambda will automatically scale. Each Lambda instance has one or more orders and retrieves the latest position for each ticker from Amazon ElastiCache. (You can use a CUSIP ID, a Curve name, or an index name for other financial derivative products as a key to store and retrieve data from ElastiCache.) In ElastiCache, the total position (quantity) and the key-value pair <i>&lt;ticker, net position&gt;</i>, where <i>net position</i> is the scaling factor, are updated once for each ticker.</p>	

### Write messages for each ticker into queue

Task	Description	Skills required
<p>Write consolidated messages to the risk queue.</p>	<p>Write the message to a queue. This pattern uses Amazon SQS as a managed queue service. A single Lambda instance might get a mini batch of trade orders at any given time, but will write only a single message for each ticker to Amazon SQS. A scaling factor is calculate</p>	<p>Amazon SQS, AWS Lambda</p>

Task	Description	Skills required
	$d: (old\ net\ position + current\ position) / old\ net\ position.$	

## Invoke risk engine

Task	Description	Skills required
Start risk calculations.	The Lambda function for the risk engine lambda is invoked. Each position is processed by a single Lambda function. However, for optimization purposes, each Lambda function can process multiple messages from Amazon SQS.	Amazon SQS, AWS Lambda

## Retrieve risk results from cache

Task	Description	Skills required
Retrieve and update risk cache.	<p>Lambda retrieves the current net position for each ticker from ElastiCache. It also retrieves a VaR profit and loss (PnL) array for each ticker from ElastiCache.</p> <p>If the PnL array already exists, the Lambda function updates the array and VaR with a scale, which comes from the Amazon SQS message written by the netting Lambda function. If the PnL array isn't</p>	Amazon SQS, AWS Lambda, Amazon ElastiCache

Task	Description	Skills required
	in ElasticCache, a new PnL and VaR are calculated by using simulated ticker price series data.	

## Update data in Elastic Cache and store in database

Task	Description	Skills required
Store risk results.	After the VaR and PnL numbers are updated in ElasticCache, a new Lambda function is invoked every five minutes. This function reads all stored data from ElasticCache and stores it in an Aurora MySQL-Compatible database and in an S3 bucket.	AWS Lambda, Amazon ElastiCache

## Related resources

- [Basel VaR Framework](#)

# Convert the Teradata NORMALIZE temporal feature to Amazon Redshift SQL

Created by Po Hong (AWS)

<b>Source:</b> Teradata data warehouse	<b>Target:</b> Amazon Redshift	<b>R Type:</b> Re-architect
<b>Environment:</b> Production	<b>Technologies:</b> Analytics; Databases; Migration	<b>Workload:</b> All other workloads
<b>AWS services:</b> Amazon Redshift		

## Summary

**NORMALIZE** is a Teradata extension to the ANSI SQL standard. When a SQL table includes a column that has a **PERIOD** data type, **NORMALIZE** combines values that meet or overlap in that column, to form a single period that consolidates multiple, individual period values. To use **NORMALIZE**, at least one column in the SQL **SELECT** list must be of Teradata's temporal **PERIOD** data type. For more information about **NORMALIZE**, see the [Teradata documentation](#).

Amazon Redshift doesn't support **NORMALIZE**, but you can implement this functionality by using native SQL syntax and the **LAG** window function in Amazon Redshift. This pattern focuses on using the Teradata **NORMALIZE** extension with the **ON MEETS OR OVERLAPS** condition, which is the most popular format. It explains how this feature works in Teradata and how it can be converted into Amazon Redshift native SQL syntax.

## Prerequisites and limitations

### Prerequisites

- Basic Teradata SQL knowledge and experience
- Amazon Redshift knowledge and experience

# Architecture

## Source technology stack

- Teradata data warehouse

## Target technology stack

- Amazon Redshift

## Target architecture

For a high-level architecture for migrating a Teradata database to Amazon Redshift, see the pattern [Migrate a Teradata database to Amazon Redshift using AWS SCT data extraction agents](#). The migration doesn't automatically convert the Teradata **NORMALIZE** phrase to Amazon Redshift SQL. You can convert this Teradata extension by following the guidelines in this pattern.

## Tools

### Code

To illustrate the concept and functionality of **NORMALIZE**, consider the following table definition in Teradata:

```
CREATE TABLE systest.project
(
  emp_id      INTEGER,
  project_name VARCHAR(20),
  dept_id     INTEGER,
  duration    PERIOD(DATE)
);
```

Run the following SQL code to insert sample data into the table:

```
BEGIN TRANSACTION;

INSERT INTO systest.project VALUES (10, 'First Phase', 1000, PERIOD(DATE '2010-01-10',
DATE '2010-03-20') );
INSERT INTO systest.project VALUES (10, 'First Phase', 2000, PERIOD(DATE '2010-03-20',
DATE '2010-07-15') );
```

```

INSERT INTO systest.project VALUES (10, 'Second Phase', 2000, PERIOD(DATE
  '2010-06-15', DATE '2010-08-18') );
INSERT INTO systest.project VALUES (20, 'First Phase', 2000, PERIOD(DATE '2010-03-10',
  DATE '2010-07-20') );

INSERT INTO systest.project VALUES (20, 'Second Phase', 1000, PERIOD(DATE
  '2020-05-10', DATE '2020-09-20') );

END TRANSACTION;

```

## Results:

```
select * from systest.project order by 1,2,3;
```

```
*** Query completed. 4 rows found. 4 columns returned.
```

```
*** Total elapsed time was 1 second.
```

emp_id	project_name	dept_id	duration
10	First Phase	1000	('10/01/10', '10/03/20')
10	First Phase	2000	('10/03/20', '10/07/15')
10	Second Phase	2000	('10/06/15', '10/08/18')
20	First Phase	2000	('10/03/10', '10/07/20')
20	Second Phase	1000	('20/05/10', '20/09/20')

## Teradata NORMALIZE use case

Now add the Teradata **NORMALIZE** SQL clause to the **SELECT** statement:

```

SELECT NORMALIZE ON MEETS OR OVERLAPS emp_id, duration
FROM systest.project
ORDER BY 1,2;

```

This **NORMALIZE** operation is performed on a single column (`emp_id`). For `emp_id=10`, the three overlapping period values in `duration` coalesce into a single period value, as follows:

emp_id	duration
10	('10/01/10', '10/08/18')
20	('10/03/10', '10/07/20')
20	('20/05/10', '20/09/20')



The following **SELECT** statement performs a **NORMALIZE** operation on `project_name` and `dept_id`. Note that the **SELECT** list contains only one **PERIOD** column, `duration`.

```
SELECT NORMALIZE project_name, dept_id, duration
FROM systest.project;
```

Output:

project_name	dept_id	duration
First Phase	1000	('10/01/10', '10/03/20')
Second Phase	1000	('20/05/10', '20/09/20')
First Phase	2000	('10/03/10', '10/07/20')
Second Phase	2000	('10/06/15', '10/08/18')

### Amazon Redshift equivalent SQL

Amazon Redshift currently doesn't support the **PERIOD** data type in a table. Instead, you need to divide a Teradata **PERIOD** data field into two parts: `start_date`, `end_date`, as follows:

```
CREATE TABLE systest.project
(
  emp_id      INTEGER,
  project_name VARCHAR(20),
  dept_id     INTEGER,
  start_date  DATE,
  end_date    DATE
);
```

Insert sample data into the table:

```
BEGIN TRANSACTION;

INSERT INTO systest.project VALUES (10, 'First Phase', 1000, DATE '2010-01-10', DATE
'2010-03-20' );
INSERT INTO systest.project VALUES (10, 'First Phase', 2000, DATE '2010-03-20', DATE
'2010-07-15');

INSERT INTO systest.project VALUES (10, 'Second Phase', 2000, DATE '2010-06-15', DATE
'2010-08-18' );
INSERT INTO systest.project VALUES (20, 'First Phase', 2000, DATE '2010-03-10', DATE
'2010-07-20' );
```

```
INSERT INTO systest.project VALUES (20, 'Second Phase', 1000, DATE '2020-05-10', DATE
'2020-09-20' );

END TRANSACTION;
```

### Output:

emp_id	project_name	dept_id	start_date	end_date
10	First Phase	1000	2010-01-10	2010-03-20
10	First Phase	2000	2010-03-20	2010-07-15
10	Second Phase	2000	2010-06-15	2010-08-18
20	First Phase	2000	2010-03-10	2010-07-20
20	Second Phase	1000	2020-05-10	2020-09-20

(5 rows)

To rewrite Teradata's **NORMALIZE** clause, you can use the [LAG window function](#) in Amazon Redshift. This function returns the values for a row at a given offset above (before) the current row in the partition.

You can use the **LAG** function to identify each row that begins a new period by determining if a period meets or overlaps with the previous period (0 if yes and 1 if no). When this flag is cumulatively summed up, it provides a group identifier that can be used in the outer **Group By** clause to arrive at the desired result in Amazon Redshift.

Here's a sample Amazon Redshift SQL statement that uses **LAG()**:

```
SELECT emp_id, start_date, end_date,
       (CASE WHEN start_date <= LAG(end_date) OVER (PARTITION BY emp_id ORDER BY
start_date, end_date) THEN 0 ELSE 1 END) AS GroupStartFlag
FROM systest.project
ORDER BY 1,2;
```

### Output:

emp_id	start_date	end_date	groupstartflag
10	2010-01-10	2010-03-20	1
10	2010-03-20	2010-07-15	0
10	2010-06-15	2010-08-18	0

```

    20 | 2010-03-10 | 2010-07-20 |      1
    20 | 2020-05-10 | 2020-09-20 |      1
(5 rows)

```

The following Amazon Redshift SQL statement normalizes only on the emp\_id column:

```

SELECT T2.emp_id, MIN(T2.start_date) as new_start_date, MAX(T2.end_date) as
new_end_date
FROM
( SELECT T1.*, SUM(GroupStartFlag) OVER (PARTITION BY emp_id ORDER BY start_date ROWS
UNBOUNDED PRECEDING) As GroupID
FROM ( SELECT emp_id, start_date, end_date,
          (CASE WHEN start_date <= LAG(end_date) OVER (PARTITION BY emp_id ORDER BY
start_date, end_date) THEN 0 ELSE 1 END) AS GroupStartFlag
FROM systest.project ) T1
) T2
GROUP BY T2.emp_id, T2.GroupID
ORDER BY 1,2;

```

Output:

```

emp_id | new_start_date | new_end_date
-----+-----+-----
    10 | 2010-01-10    | 2010-08-18
    20 | 2010-03-10    | 2010-07-20
    20 | 2020-05-10    | 2020-09-20
(3 rows)

```

The following Amazon Redshift SQL statement normalizes on both the project\_name and dept\_id columns:

```

SELECT T2.project_name, T2.dept_id, MIN(T2.start_date) as new_start_date,
MAX(T2.end_date) as new_end_date
FROM
( SELECT T1.*, SUM(GroupStartFlag) OVER (PARTITION BY project_name, dept_id ORDER BY
start_date ROWS UNBOUNDED PRECEDING) As GroupID
FROM ( SELECT project_name, dept_id, start_date, end_date,
          (CASE WHEN start_date <= LAG(end_date) OVER (PARTITION BY project_name,
dept_id ORDER BY start_date, end_date) THEN 0 ELSE 1 END) AS GroupStartFlag
FROM systest.project ) T1

```

```
) T2
GROUP BY T2.project_name, T2.dept_id, T2.GroupID
ORDER BY 1,2,3;
```

### Output:

```
project_name | dept_id | new_start_date | new_end_date
-----+-----+-----+-----
First Phase | 1000 | 2010-01-10 | 2010-03-20
First Phase | 2000 | 2010-03-10 | 2010-07-20
Second Phase | 1000 | 2020-05-10 | 2020-09-20
Second Phase | 2000 | 2010-06-15 | 2010-08-18
(4 rows)
```

## Epics

### Convert NORMALIZE to Amazon Redshift SQL

Task	Description	Skills required
Create your Teradata SQL code.	Use the NORMALIZE phrase according to your needs.	SQL developer
Convert the code to Amazon Redshift SQL.	To convert your code, follow the guidelines in the "Tools" section of this pattern.	SQL developer
Run the code in Amazon Redshift.	Create your table, load data into the table, and run your code in Amazon Redshift.	SQL developer

## Related resources

### References

- [Teradata NORMALIZE temporal feature](#) (Teradata documentation)
- [LAG window function](#) (Amazon Redshift documentation)
- [Migrate to Amazon Redshift](#) (AWS website)

- [Migrate a Teradata database to Amazon Redshift using AWS SCT data extraction agents](#) (AWS Prescriptive Guidance)
- [Convert the Teradata RESET WHEN feature to Amazon Redshift SQL](#) (AWS Prescriptive Guidance)

## Tools

- [AWS Schema Conversion Tool \(AWS SCT\)](#)

## Partners

- [AWS Migration Competency Partners](#)

# Convert the Teradata RESET WHEN feature to Amazon Redshift SQL

Created by Po Hong (AWS)

<b>Source:</b> Teradata data warehouse	<b>Target:</b> Amazon Redshift	<b>R Type:</b> Re-architect
<b>Environment:</b> Production	<b>Technologies:</b> Analytics; Databases; Migration	<b>Workload:</b> All other workloads
<b>AWS services:</b> Amazon Redshift		

## Summary

**RESET WHEN** is a Teradata feature used in SQL analytical window functions. It is an extension to the ANSI SQL standard. **RESET WHEN** determines the partition over which an SQL window function operates based on some specified condition. If the condition evaluates to **TRUE**, a new, dynamic sub-partition is created inside the existing window partition. For more information about **RESET WHEN**, see the [Teradata documentation](#).

Amazon Redshift doesn't support **RESET WHEN** in SQL window functions. To implement this functionality, you have to convert **RESET WHEN** to the native SQL syntax in Amazon Redshift, and use multiple, nested functions. This pattern demonstrates how you can use the Teradata **RESET WHEN** feature and how you can convert it to Amazon Redshift SQL syntax.

## Prerequisites and limitations

### Prerequisites

- Basic knowledge of the Teradata data warehouse and its SQL syntax
- Good understanding of Amazon Redshift and its SQL syntax

# Architecture

## Source technology stack

- Teradata data warehouse

## Target technology stack

- Amazon Redshift

## Architecture

For a high-level architecture for migrating a Teradata database to Amazon Redshift, see the pattern [Migrate a Teradata database to Amazon Redshift using AWS SCT data extraction agents](#). The migration doesn't automatically convert the Teradata **RESET WHEN** phrase to Amazon Redshift SQL. You can convert this Teradata extension by following the guidelines in the next section.

## Tools

### Code

To illustrate the concept of **RESET WHEN**, consider the following table definition in Teradata:

```
create table systest.f_account_balance
( account_id integer NOT NULL,
  month_id integer,
  balance integer )
unique primary index (account_id, month_id);
```

Run the following SQL code to insert sample data into the table:

```
BEGIN TRANSACTION;
Insert Into systest.f_account_balance values (1,1,60);
Insert Into systest.f_account_balance values (1,2,99);
Insert Into systest.f_account_balance values (1,3,94);
Insert Into systest.f_account_balance values (1,4,90);
Insert Into systest.f_account_balance values (1,5,80);
Insert Into systest.f_account_balance values (1,6,88);
```

```
Insert Into systest.f_account_balance values (1,7,90);
Insert Into systest.f_account_balance values (1,8,92);
Insert Into systest.f_account_balance values (1,9,10);
Insert Into systest.f_account_balance values (1,10,60);
Insert Into systest.f_account_balance values (1,11,80);
Insert Into systest.f_account_balance values (1,12,10);
END TRANSACTION;
```

The sample table has the following data:

<b>account_id</b>	<b>month_id</b>	<b>balance</b>
1	1	60
1	2	99
1	3	94
1	4	90
1	5	80
1	6	88
1	7	90
1	8	92
1	9	10
1	10	60
1	11	80
1	12	10

For each account, let's say that you want to analyze the sequence of consecutive monthly balance increases. When one month's balance is less than, or equal to, the previous month's balance, the requirement is to reset the counter to zero and restart.

*Teradata RESET WHEN use case*



To analyze this data, Teradata SQL uses a window function with a nested aggregate and a **RESET WHEN** phrase, as follows:

```
SELECT account_id, month_id, balance,  
       ( ROW_NUMBER() OVER (PARTITION BY account_id ORDER BY month_id  
RESET WHEN balance <= SUM(balance) over (PARTITION BY account_id ORDER BY month_id ROWS  
       BETWEEN 1 PRECEDING AND 1 PRECEDING) ) -1 ) as balance_increase  
FROM systest.f_account_balance  
ORDER BY 1,2;
```

Output:

<b>account_id</b>	<b>month_id</b>	<b>balance</b>	<b>balance_increase</b>
1	1	60	0
1	2	99	1
1	3	94	0
1	4	90	0
1	5	80	0
1	6	88	1
1	7	90	2
1	8	92	3
1	9	10	0
1	10	60	1
1	11	80	2
1	12	10	0

The query is processed as follows in Teradata:

1. The **SUM(balance)** aggregate function calculates the sum of all balances for a given account in a given month.
2. We check to see if a balance in a given month (for a given account) is greater than the balance of the previous month.
3. If the balance increased, we track a cumulative count value. If the **RESET WHEN** condition evaluates to **false**, which means that the balance has increased over successive months, we continue to increase the count.
4. The **ROW\_NUMBER()** ordered analytical function calculates the count value. When we reach a month whose balance is less than, or equal to, the balance of the previous month, the **RESET WHEN** condition evaluates to **true**. If so, we start a new partition and **ROW\_NUMBER()** restarts the count from 1. We use **ROWS BETWEEN 1 PRECEDING AND 1 PRECEDING** to access the value of the previous row.
5. We subtract 1 to ensure that the count value starts with 0.

### *Amazon Redshift equivalent SQL*

Amazon Redshift doesn't support the **RESET WHEN** phrase in an SQL analytical window function. To produce the same result, you must rewrite the Teradata SQL using Amazon Redshift native SQL syntax and nested sub-queries, as follows:

```
SELECT account_id, month_id, balance,
       (ROW_NUMBER() OVER(PARTITION BY account_id, new_dynamic_part ORDER BY month_id) -1)
       as balance_increase
FROM
( SELECT account_id, month_id, balance, prev_balance,
  SUM(dynamic_part) OVER (PARTITION BY account_id ORDER BY month_id ROWS BETWEEN
    UNBOUNDED PRECEDING AND CURRENT ROW) As new_dynamic_part
FROM ( SELECT account_id, month_id, balance,
  SUM(balance) over (PARTITION BY account_id ORDER BY month_id ROWS BETWEEN 1 PRECEDING
    AND 1 PRECEDING) as prev_balance,
  (CASE When balance <= prev_balance Then 1 Else 0 END) as dynamic_part
FROM systest.f_account_balance ) A
) B
ORDER BY 1,2;
```

Because Amazon Redshift doesn't support nested window functions in the **SELECT** clause of a single SQL statement, you must use two nested sub-queries.

- In the inner sub-query (alias A), a dynamic partition indicator (**dynamic\_part**) is created and populated. **dynamic\_part** is set to 1 if one month's balance is less than or equal to the preceding month's balance; otherwise, it's set to 0.
- In the next layer (alias B), a **new\_dynamic\_part** attribute is generated as the result of a **SUM** window function.
- Finally, you add **new\_dynamic\_part** as a new partition attribute (**dynamic partition**) to the existing partition attribute (**account\_id**) and apply the same **ROW\_NUMBER()** window function as in Teradata (and minus one).

After these changes, Amazon Redshift SQL generates the same output as Teradata.

## Epics

### Convert RESET WHEN to Amazon Redshift SQL

Task	Description	Skills required
Create your Teradata window function.	Use nested aggregates and the RESET WHEN phrase according to your needs.	SQL developer
Convert the code to Amazon Redshift SQL.	To convert your code, follow the guidelines in the "Tools" section of this pattern.	SQL developer
Run the code in Amazon Redshift.	Create your table, load data into the table, and run your code in Amazon Redshift.	SQL developer

## Related resources

### References

- [RESET WHEN Phrase](#) (Teradata documentation)
- [RESET WHEN explanation](#) (Stack Overflow)
- [Migrate to Amazon Redshift](#) (AWS website)

- [Migrate a Teradata database to Amazon Redshift using AWS SCT data extraction agents](#) (AWS Prescriptive Guidance)
- [Convert the Teradata NORMALIZE temporal feature to Amazon Redshift SQL](#) (AWS Prescriptive Guidance)

## Tools

- [AWS Schema Conversion Tool \(AWS SCT\)](#)

## Partners

- [AWS Migration Competency Partners](#)

# Enforce tagging of Amazon EMR clusters at launch

Created by Priyanka Chaudhary (AWS)

**Environment:** Production

**Technologies:** Analytics;  
Security, identity, compliance

**AWS services:** Amazon  
EMR; AWS Lambda; Amazon  
CloudWatch Events

## Summary

This pattern provides a security control that ensures that Amazon EMR clusters are tagged when they are created.

Amazon EMR is an Amazon Web Services (AWS) service for processing and analyzing vast amounts of data. Amazon EMR offers an expandable, low-configuration service as an easier alternative to running in-house cluster computing. You can use tagging to categorize AWS resources in different ways, such as by purpose, owner, or environment. For example, you can tag your Amazon EMR clusters by assigning custom metadata to each cluster. A tag consists of a key and value that you define. We recommend that you create a consistent set of tags to meet your organization's requirements. When you add a tag to an Amazon EMR cluster, the tag is also propagated to each active Amazon Elastic Compute Cloud (Amazon EC2) instance that is associated with the cluster. Similarly, when you remove a tag from an Amazon EMR cluster, that tag is removed from each associated, active EC2 instance as well.

The detective control monitors API calls and initiates an Amazon CloudWatch Events event for the [RunJobFlow](#), [AddTags](#), [RemoveTags](#), and [CreateTags](#) APIs. The event calls AWS Lambda, which runs a Python script. The Python function gets the Amazon EMR cluster ID from the JSON input from the event and performs the following checks:

- Check if the Amazon EMR cluster is configured with tag names that you specify.
- If not, send an Amazon Simple Notification Service (Amazon SNS) notification to the user with the relevant information: the Amazon EMR cluster name, violation details, AWS Region, AWS account, and Amazon Resource Name (ARN) for Lambda that this notification is sourced from.

## Prerequisites and limitations

### Prerequisites

- An active AWS account
- An Amazon Simple Storage Service (Amazon S3) bucket to upload the provided Lambda code. Or, you can create an S3 bucket for this purpose, as described in the *Epics* section.
- An active email address where you would like to receive violation notifications.
- A list of mandatory tags you want to check for.

### Limitations

- This security control is regional. You must deploy it in each AWS Region that you want to monitor.

### Product versions

- Amazon EMR release 4.8.0 and later.

## Architecture

### Workflow architecture

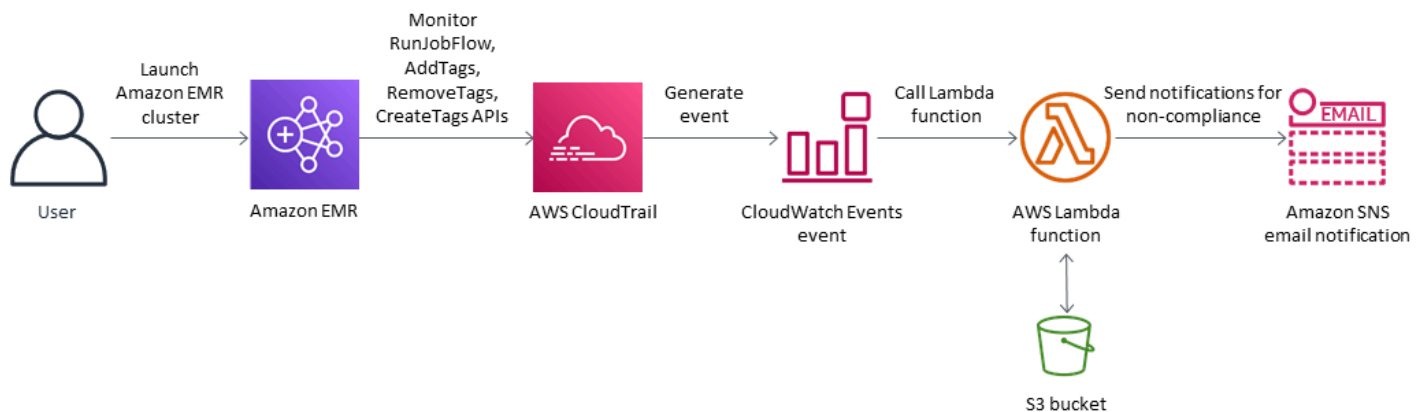

### Automation and scale

- If you are using [AWS Organizations](#), you can use [AWS Cloudformation StackSets](#) to deploy this template in multiple accounts that you want to monitor.

## Tools

### AWS services

- [AWS CloudFormation](#) – AWS CloudFormation helps you model and set up your AWS resources, provision them quickly and consistently, and manage them throughout their lifecycle. You can use a template to describe your resources and their dependencies, and launch and configure them together as a stack, instead of managing resources individually. You can manage and provision stacks across multiple AWS accounts and AWS Regions.
- [Amazon CloudWatch Events](#) - Amazon CloudWatch Events delivers a near real-time stream of system events that describe changes in AWS resources.
- [Amazon EMR](#) - Amazon EMR is web service that simplifies running big data frameworks and processing vast amounts of data efficiently.
- [AWS Lambda](#) – AWS Lambda is a compute service that supports running code without provisioning or managing servers. Lambda runs your code only when needed and scales automatically, from a few requests per day to thousands per second.
- [Amazon S3](#) – Amazon Simple Storage Service (Amazon S3) is an object storage service. You can use Amazon S3 to store and retrieve any amount of data at any time, from anywhere on the web.
- [Amazon SNS](#) – Amazon Simple Notification Service (Amazon SNS) coordinates and manages the delivery or sending of messages between publishers and clients, including web servers and email addresses. Subscribers receive all messages published to the topics to which they subscribe, and all subscribers to a topic receive the same messages.

### Code

This pattern includes the following attachments:

- `EMRTagValidation.zip` – The Lambda code for the security control.
- `EMRTagValidation.yml` – The CloudFormation template that sets up the event and Lambda function.

## Epics

### Set up the S3 bucket

Task	Description	Skills required
Define the S3 bucket.	On the <a href="#">Amazon S3 console</a> , choose or create an S3 bucket to host the Lambda code .zip file. This S3 bucket must be in the same AWS Region as the Amazon EMR cluster you want to monitor. An Amazon S3 bucket name is globally unique, and the namespace is shared by all AWS accounts. The S3 bucket name cannot include leading slashes.	Cloud architect
Upload the Lambda code.	Upload the Lambda code .zip file provided in the <i>Attachments</i> section to the S3 bucket.	Cloud architect

### Deploy the AWS CloudFormation template

Task	Description	Skills required
Launch the AWS CloudFormation template.	Open the <a href="#">AWS CloudFormation console</a> in the same AWS Region as your S3 bucket and deploy the template. For more information about deploying AWS CloudFormation templates, see <a href="#">Creating a stack on</a>	Cloud architect



Task	Description	Skills required
	<a href="#">the AWS CloudFormation console</a> in the CloudFormation documentation.	

Task	Description	Skills required
Complete the parameters in the template.	<p>When you launch the template, you'll be prompted for the following information:</p> <ul style="list-style-type: none"><li>• <b>S3 bucket:</b> Specify the bucket that you created or selected in the first epic. This is where you uploaded the attached Lambda code (.zip file).</li><li>• <b>S3 key:</b> Specify the location of the Lambda .zip file in your S3 bucket (for example, <i>filename.zip</i> or <i>controls/filename.zip</i>). Do not include leading slashes.</li><li>• <b>Notification email:</b> Provide an active email address where you want to receive Amazon SNS notifications.</li><li>• <b>Tagging key names:</b> Provide the tags you want to check for, in a comma-separated list (for example, <i>ApplicationID , Environment , Owner</i>). The CloudWatch Events event monitors the cluster for these tags and sends a notification if they aren't found.</li><li>• <b>Lambda logging level:</b> Specify the logging level and frequency for the</li></ul>	Cloud architect

Task	Description	Skills required
	Lambda function. Use <b>Info</b> to log detailed informational messages on progress, <b>Error</b> for error events that would still allow the deployment to continue, and <b>Warning</b> for potentially harmful situations.	

## Confirm the subscription

Task	Description	Skills required
Confirm the subscription.	When the CloudFormation template deploys successfully, it sends a subscription email to the email address you provided. You must confirm this email subscription to start receiving violation notifications.	Cloud architect

## Related resources

- [AWS Lambda developer guide](#)
- [Tagging clusters in Amazon EMR](#)

## Attachments

To access additional content that is associated with this document, unzip the following file: [attachment.zip](#)

# Ensure Amazon EMR logging to Amazon S3 is enabled at launch

Created by Priyanka Chaudhary (AWS)

**Environment:** Production

**Technologies:** Analytics;  
Security, identity, compliance;  
Serverless

**Workload:** Open-source

**AWS services:** Amazon EMR;  
Amazon S3; Amazon SNS;  
Amazon CloudWatch

## Summary

This pattern provides a security control that monitors logging configuration for Amazon EMR clusters running on Amazon Web Services (AWS).

Amazon EMR is an AWS tool for big data processing and analysis. Amazon EMR offers the expandable low-configuration service as an alternative to running in-house cluster computing. Amazon EMR provides two types of EMR clusters.

- **Transient Amazon EMR clusters:** Transient Amazon EMR clusters automatically shut down and stop incurring costs when processing is finished.
- **Persistent Amazon EMR clusters:** Persistent Amazon EMR clusters continue to run after the data processing job is complete.

Amazon EMR and Hadoop both produce log files that report status on the cluster. By default, these are written to the master node in the `/mnt/var/log/` directory. Depending on how you configure the cluster when you launch it, you can also save these logs to Amazon Simple Storage Service (Amazon S3) and view them through the graphical debugging tool. Note that Amazon S3 logging can be specified only when the cluster is launched. With this configuration, logs are sent from the primary node to the Amazon S3 location every 5 minutes. For transient clusters, Amazon S3 logging is important because the clusters disappear when processing is complete, and these log files can be used to debug any failed jobs.

The pattern uses an AWS CloudFormation template to deploy a security control that monitors for API calls and starts Amazon CloudWatch Events on "RunJobFlow." The trigger invokes AWS Lambda, which runs a Python script. The Lambda function retrieves the EMR cluster ID from the event JSON input and also checks for an Amazon S3 log URI. If an Amazon S3 URI is not found, the Lambda function sends an Amazon Simple Notification Service (Amazon SNS) notification detailing the EMR cluster name, violation details, AWS Region, AWS account, and the Lambda Amazon Resource Name (ARN) that the notification is sourced from.

## Prerequisites and limitations

### Prerequisites

- An active AWS account
- An S3 bucket for the Lambda code .zip file
- An email address where you want to receive the violation notification

### Limitations

- This detective control is regional and must be deployed in the AWS Regions you intend to monitor.

### Product versions

- Amazon EMR release 4.8.0 and later

## Architecture

### Target technology stack

- Amazon CloudWatch Events event
- Amazon EMR
- Lambda function
- S3 bucket
- Amazon SNS

### Target architecture



## Automation and scale

- If you are using AWS Organizations, you can use [AWS CloudFormation StackSets](#) to deploy this template in multiple accounts that you want to monitor.

## Tools

### Tools

- [AWS CloudFormation](#) – AWS CloudFormation helps you model and set up AWS resources using infrastructure as code.
- [AWS Cloudwatch Events](#) – AWS CloudWatch Events delivers a near real-time stream of system events that describe changes in AWS resources.
- [Amazon EMR](#) – Amazon EMR is a managed cluster platform that simplifies running big data frameworks.
- [AWS Lambda](#) – AWS Lambda supports running code without provisioning or managing servers. Lambda runs your code only when needed and scales automatically, from a few requests per day to thousands per second.
- [Amazon S3](#) – Amazon S3 is a web services interface that you can use to store and retrieve any amount of data from anywhere on the web.
- [Amazon SNS](#) – Amazon SNS is a web service that coordinates and manages the delivery or sending of messages between publishers and clients, including web servers and email addresses.

### Code

- A .zip file of the project is available as an attachment.

# Epics

## Define the S3 bucket

Task	Description	Skills required
Define the S3 bucket.	To host the Lambda code .zip file, choose or create an S3 bucket with a unique name that does not contain leading slashes. An S3 bucket name is globally unique, and the namespace is shared by all AWS accounts. Your S3 bucket needs to be in the same AWS Region as the Amazon EMR cluster that is being evaluated .	Cloud Architect

## Upload the Lambda code to the S3 bucket

Task	Description	Skills required
Upload the Lambda code to the S3 bucket.	Upload the Lambda code .zip file that's provided in the "Attachments" section to the S3 bucket. The S3 bucket must be in the same Region as the Amazon EMR cluster that is being evaluated.	Cloud Architect

## Deploy the AWS CloudFormation template

Task	Description	Skills required
Deploy the AWS CloudFormation template.	On the AWS CloudFormation console, in the same Region as your S3 bucket, deploy the AWS CloudFormation template that's provided as an attachment to this pattern. In the next epic, provide the values for the parameters. For more information about deploying AWS CloudFormation templates, see the "Related resources" section.	Cloud Architect

## Complete the parameters in the AWS CloudFormation template

Task	Description	Skills required
Name the S3 bucket.	Enter the name of the S3 bucket that you created in the first epic.	Cloud Architect
Provide the Amazon S3 key.	Provide the location of the Lambda code .zip file in your S3 bucket, without leading slashes (for example, <directory>/<file-name>.zip).	Cloud Architect
Provide an email address.	Provide an active email address to receive Amazon SNS notifications.	Cloud Architect
Define the logging level.	Define the logging level and frequency for your Lambda	Cloud Architect



Task	Description	Skills required
	function. "Info" designates detailed informational messages on the application's progress. "Error" designates error events that could still allow the application to continue running. "Warning" designates potentially harmful situations.	

## Confirm the subscription

Task	Description	Skills required
Confirm the subscription.	When the template successfully deploys, it sends a subscription email message to the email address provided. You must confirm this email subscription to receive violation notifications.	Cloud Architect

## Related resources

- [AWS Lambda](#)
- [Amazon EMR logging](#)
- [Deploying AWS CloudFormation templates](#)

## Attachments

To access additional content that is associated with this document, unzip the following file: [attachment.zip](#)

# Generate test data using an AWS Glue job and Python

Created by Moinul Al-Mamun (AWS)

**Environment:** Production

**Technologies:** Analytics  
; CloudNative; Data lakes;  
DevelopmentAndTesting;  
Serverless; Big data

**AWS services:** AWS Glue;  
Amazon S3

## Summary

This pattern shows you how to quickly and easily generate millions of sample files concurrently by creating an AWS Glue job written in Python. The sample files are stored in an Amazon Simple Storage Service (Amazon S3) bucket. The ability to quickly generate a large number of sample files is important for testing or evaluating services in the AWS Cloud. For example, you can test the performance of AWS Glue Studio or AWS Glue DataBrew jobs by performing data analysis on millions of small files in an Amazon S3 prefix.

Although you can use other AWS services to generate sample datasets, we recommend that you use AWS Glue. You don't need to manage any infrastructure because AWS Glue is a serverless data processing service. You can just bring your code and run it in an AWS Glue cluster. Additionally, AWS Glue provisions, configures, and scales the resources required to run your jobs. You pay only for the resources that your jobs use while running.

## Prerequisites and limitations

### Prerequisites

- An active AWS account
- AWS Command Line Interface (AWS CLI), [installed](#) and [configured](#) to work with the AWS account

### Product versions

- Python 3.9
- AWS CLI version 2

## Limitations

The maximum number of AWS Glue jobs per trigger is 50. For more information, see [AWS Glue endpoints and quotas](#).

## Architecture

The following diagram depicts an example architecture centered around an AWS Glue job that writes its output (that is, sample files) to an S3 bucket.

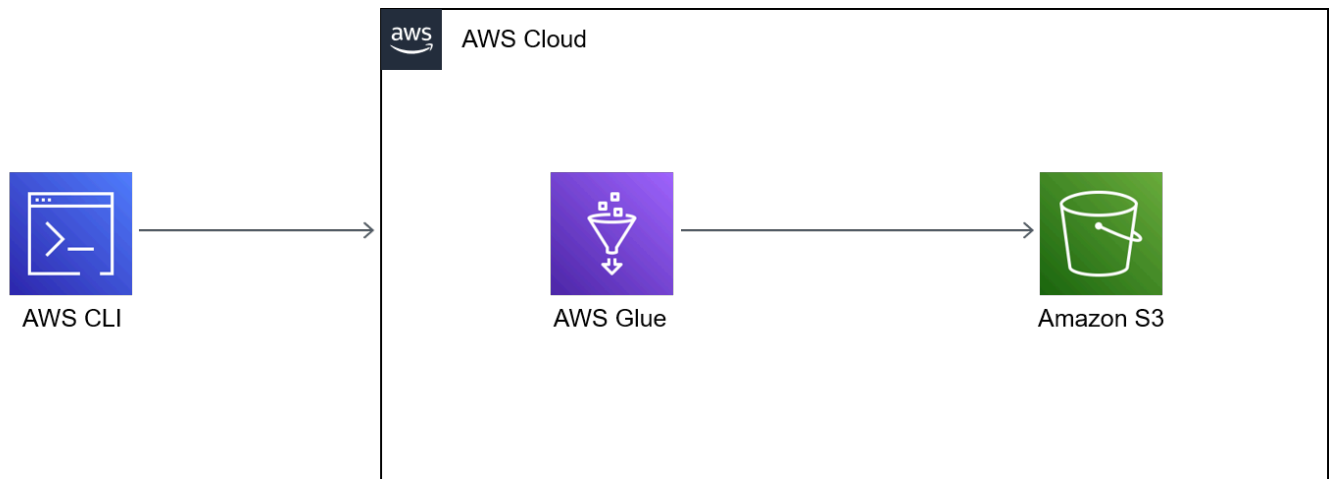

The diagram includes the following workflow:

1. You use the AWS CLI, AWS Management Console, or an API to initiate the AWS Glue job. The AWS CLI or API enables you to automate the parallelization of the invoked job and reduce the runtime for generating sample files.
2. The AWS Glue job generates file content randomly, converts the content into CSV format, and then stores the content as an Amazon S3 object under a common prefix. Each file is less than a kilobyte. The AWS Glue job accepts two user-defined job parameters: `START_RANGE` and `END_RANGE`. You can use these parameters to set file names and the number of files generated in Amazon S3 by each job run. You can run multiple instances of this job in parallel (for example, 100 instances).

## Tools

- [Amazon Simple Storage Service \(Amazon S3\)](#) is a cloud-based object storage service that helps you store, protect, and retrieve any amount of data.

- [AWS Command Line Interface \(AWS CLI\)](#) is an open-source tool that helps you interact with AWS services through commands in your command-line shell.
- [AWS Glue](#) is a fully managed extract, transform, and load (ETL) service. It helps you reliably categorize, clean, enrich, and move data between data stores and data streams.
- [AWS Identity and Access Management \(IAM\)](#) helps you securely manage access to your AWS resources by controlling who is authenticated and authorized to use them.

## Best practices

Consider the following AWS Glue best practices as you implement this pattern:

- **Use the right AWS Glue worker type to reduce cost.** We recommend that you understand the different properties of worker types, and then choose the right worker type for your workload based on CPU and memory requirements. For this pattern, we recommend that you use a Python shell job as your job type to minimize DPU and reduce cost. For more information, see [Adding jobs in AWS Glue](#) in the AWS Glue Developer Guide.
- **Use the right concurrency limit to scale your job.** We recommend that you base the maximum concurrency of your AWS Glue job on your time requirement and required number of files.
- **Start generating a small number of files at first.** To reduce cost and save time when you build your AWS Glue jobs, start with a small number of files (such as 1,000). This can make troubleshooting easier. If generating a small number of files is successful, then you can scale to a larger number of files.
- **Run locally first.** To reduce cost and save time when you build your AWS Glue jobs, start the development locally and test your code. For instructions on setting up a Docker container that can help you write AWS Glue extract, transform, and load (ETL) jobs both in a shell and in an integrated development environment (IDE), see the [Developing AWS Glue ETL jobs locally using a container](#) post on the AWS Big Data Blog.

For more AWS Glue best practices, see [Best practices](#) in the AWS Glue documentation.

## Epics

### Create a destination S3 bucket and IAM role

Task	Description	Skills required
<p>Create an S3 bucket for storing the files.</p>	<p>Create an <a href="#">S3 bucket</a> and a <a href="#">prefix</a> within it.</p> <p><b>Note:</b> This pattern uses the <code>s3://{your-s3-bucket-name}/small-files/</code> location for demonstration purposes.</p>	<p>App developer</p>
<p>Create and configure an IAM role.</p>	<p>You must create an IAM role that your AWS Glue job can use to write to your S3 bucket.</p> <ol style="list-style-type: none"> <li>1. Create an <a href="#">IAM role</a> (for example, called "AWSGlueServiceRole-smallfiles" ).</li> <li>2. Choose AWS Glue as the policy's trusted entity.</li> <li>3. Attach an <a href="#">AWS managed policy</a> called "AWSGlueServiceRole" to the role.</li> <li>4. Create an inline policy or <a href="#">customer managed policy</a> called "s3-small-file-access" based on the following configuration. Replace "{bucket}" with your bucket name.</li> </ol>	<p>App developer</p>

Task	Description	Skills required
	<pre data-bbox="634 212 1029 1199"> {   "Version":   "2012-10-17",   "Statement": [     {       "Effect":       "Allow",       "Action":       [         "s3:GetObject",         "s3:PutObject"       ],       "Resource ": [         "arn:aws:s3:::{buc ket}/small-files/i nput/*"       ]     }   ] } </pre> <p data-bbox="591 1220 1016 1346">5. Attach the "s3-small-file-access" policy to your role.</p>	

## Create and configure an AWS Glue job to handle concurrent runs

Task	Description	Skills required
Create an AWS Glue job.	You must create an AWS Glue job that generates your content and stores it in an S3 bucket.	App developer

Task	Description	Skills required
	<p>Create an <a href="#">AWS Glue job</a>, and then configure your job by completing the following steps:</p> <ol style="list-style-type: none"><li>1. Sign in to the AWS Management Console and open the <a href="#">AWS Glue console</a>.</li><li>2. In the navigation pane, under <b>Data Integration and ETL</b>, choose <b>Jobs</b>.</li><li>3. In the <b>Create job</b> section, choose <b>Python Shell script editor</b>.</li><li>4. In the <b>Options</b> section, select <b>Create a new script with boilerplate code</b>, and then choose <b>Create</b>.</li><li>5. Choose <b>Job details</b>.</li><li>6. For <b>Name</b>, enter <b>create_sm all_files</b>.</li><li>7. For <b>IAM Role</b>, select the IAM role that you created earlier.</li><li>8. In the <b>This job runs</b> section, choose <b>A new script to be authored by you</b>.</li><li>9. Expand <b>Advanced properties</b>.</li><li>10 For <b>Maximum concurrency</b>, enter <b>100</b> for</li></ol>	

Task	Description	Skills required
	<p>demonstration purposes.</p> <p><b>Note:</b> Maximum concurrency defines how many instances of the job that you can run in parallel.</p> <p>11Choose <b>Save</b>.</p>	



Task	Description	Skills required
Update the job code.	<ol style="list-style-type: none"><li>1. Open the <a href="#">AWS Glue console</a>.</li><li>2. In the navigation pane, choose <b>Jobs</b>.</li><li>3. In the <b>Your jobs</b> section, choose the job that you created earlier.</li><li>4. Choose the <b>Script</b> tab, and then update the script based on the following code. Update the <code>BUCKET_NAME</code> , <code>PREFIX</code>, and <code>text_str</code> variables with your values.</li></ol> <pre data-bbox="634 947 1029 1837">from awsglue.utils     import getResolvedOptions import sys import boto3 from random import     randrange  # Two arguments args = getResolvedOptions(sys.argv     , ['START_RANGE',     'END_RANGE'])  START_RANGE =     int(args['START_RA     NGE']) END_RANGE = int(args[     'END_RANGE'])  BUCKET_NAME =     '{BUCKET_NAME}'</pre>	App developer

Task	Description	Skills required
	<pre> PREFIX = 'small-fi les/input/' s3 = boto3.res ource('s3') for x in range(STA RT_RANGE, END_RANGE ):     # generate file name     file_name = f"input_{x}.txt"     # generate text text_str = str(randrange(1000 00))+","+str(randr ange(100000))+", " + str(randrange(1000 0000)) + "," + str(randrange(1000 0))     # write in s3 s3.Object(BUCKE T_NAME, PREFIX + file_name).put(Bod y=text_str) </pre> <p>5. Choose <b>Save</b>.</p>	

## Run the AWS Glue job from the command line or console

Task	Description	Skills required
Run the AWS Glue job from the command line.	<p>To run your AWS Glue job from the AWS CLI , run the following command using your values:</p> <pre> cmd:~\$ aws glue start- job-run --job-name </pre>	App developer

Task	Description	Skills required
	<pre>create_small_files --arguments '{"--STAR T_RANGE":"0", "--EN D_RANGE":"1000000"}' cmd:~\$ aws glue start- job-run --job-name create_small_files --arguments '{"--STAR T_RANGE":"1000000" , "--END_RANGE":"20 00000"}'</pre> <p><b>Note:</b> For instructions on running the AWS Glue job from the AWS Management Console, see the <i>Run the AWS Glue job in the AWS Management Console</i> story in this pattern.</p> <p><b>Tip:</b> We recommend using the AWS CLI to run AWS Glue jobs if you want to run multiple executions at a time with different parameters, as shown in the example above.</p> <p>To generate all AWS CLI commands that are required to generate a defined number of files using a certain parallelization factor, run the following bash code (using your values):</p> <pre># define parameters NUMBER_OF_FILES= 10000000;</pre>	

Task	Description	Skills required
	<pre>PARALLELIZATION=50;  # initialize _SB=0;  # generate commands for i in \$(seq 1   \$PARALLELIZATION); do     echo aws glue     start-job-run --     job-name create_sm     all_files --argumen     ts ""'{"--START_RANG     E":"'\${(((NUMBER_OF     _FILES/PARALLELI     ZATION) * (i-1) +     _SB))}'", "--END_RAN     GE":"'\${(((NUMBER_O     F_FILES/PARALLELI     ZATION) * (i)))}'"}'"";     _SB=1; done</pre> <p>If you use the script above, consider the following:</p> <ul style="list-style-type: none"><li>• The script simplifies the invocation and generation of small files at scale.</li><li>• Update <code>NUMBER_OF_FILES</code> and <code>PARALLELI ZATION</code> with your values.</li><li>• The script above prints a list of commands that you must run. Copy those output commands, and</li></ul>	

Task	Description	Skills required
	<p>then run them in your terminal.</p> <ul style="list-style-type: none"> <li>If you want to run the commands directly from within the script, remove the echo statement in line 11.</li> </ul> <p><b>Note:</b> To see an example of output from the above script, see <i>Shell script output</i> in the <i>Additional information</i> section of this pattern.</p>	
Run the AWS Glue job in the AWS Management Console.	<ol style="list-style-type: none"> <li>Sign in to the AWS Management Console and open the <a href="#">AWS Glue console</a>.</li> <li>In the navigation pane, under <b>Data Integration and ETL</b>, choose <b>Jobs</b>.</li> <li>In the <b>Your jobs</b> section, choose your job.</li> <li>In the <b>Parameters (optional)</b> section, update your parameters.</li> <li>Choose <b>Action</b>, and then choose <b>Run job</b>.</li> <li>Repeat steps 3-5 as many times as you require. For example, to create 10 million files, repeat this process 10 times.</li> </ol>	App developer

Task	Description	Skills required
Check the status of your AWS Glue job.	<ol style="list-style-type: none"><li>1. Open the <a href="#">AWS Glue console</a>.</li><li>2. In the navigation pane, choose <b>Jobs</b>.</li><li>3. In the <b>Your jobs</b> section, choose the job that you created earlier (that is, <code>create_small_files</code>).</li><li>4. For insight into the progress and generation of your files, review the <b>Run ID</b>, <b>Run Status</b>, and other columns.</li></ol>	App developer

## Related resources

### References

- [Registry of Open Data on AWS](#)
- [Data sets for analytics](#)
- [Open Data on AWS](#)
- [Adding jobs in AWS Glue](#)
- [Getting started with AWS Glue](#)

### Guides and patterns

- [AWS Glue best practices](#)
- [Load testing applications](#)

## Additional information

### Benchmarking test

This pattern was used to generate 10 million files using different parallelization parameters as part of a benchmarking test. The following table shows the output of the test:

Parallelization	Number of files generated by a job run	Job duration	Speed
10	1,000,000	6 hours, 40 minutes	Very slow
50	200,000	80 minutes	Moderate
100	100,000	40 minutes	Fast

If you want to make the process faster, you can configure more concurrent runs in your job configuration. You can easily adjust the job configuration based on your requirements, but keep in mind that there is an AWS Glue service quota limit. For more information, see [AWS Glue endpoints and quotas](#).

### Shell script output

The following example shows the output of the shell script from the *Run the AWS Glue job from the command line* story in this pattern.

```
user@MUC-1234567890 MINGW64 ~
$ # define parameters
NUMBER_OF_FILES=10000000;
PARALLELIZATION=50;
# initialize
_SB=0;

# generate commands
for i in $(seq 1 $PARALLELIZATION);
do
    echo aws glue start-job-run --job-name create_small_files --arguments
    ""'{"--START_RANGE":"'${((NUMBER_OF_FILES/PARALLELIZATION) (i-1) + SB)}'","--
ENDRANGE":"'${((NUMBER_OF_FILES/PARALLELIZATION) (i))}'"}'"";
    _SB=1;
```

done

```
aws glue start-job-run --job-name create_small_files --arguments '{"--START_RANGE":"0","--END_RANGE":"200000"}'
```

```
aws glue start-job-run --job-name create_small_files --arguments '{"--START_RANGE":"200001","--END_RANGE":"400000"}'
```

```
aws glue start-job-run --job-name create_small_files --arguments '{"--START_RANGE":"400001","--END_RANGE":"600000"}'
```

```
aws glue start-job-run --job-name create_small_files --arguments '{"--START_RANGE":"600001","--END_RANGE":"800000"}'
```

```
aws glue start-job-run --job-name create_small_files --arguments '{"--START_RANGE":"800001","--END_RANGE":"1000000"}'
```

```
aws glue start-job-run --job-name create_small_files --arguments '{"--START_RANGE":"1000001","--END_RANGE":"1200000"}'
```

```
aws glue start-job-run --job-name create_small_files --arguments '{"--START_RANGE":"1200001","--END_RANGE":"1400000"}'
```

```
aws glue start-job-run --job-name create_small_files --arguments '{"--START_RANGE":"1400001","--END_RANGE":"1600000"}'
```

```
aws glue start-job-run --job-name create_small_files --arguments '{"--START_RANGE":"1600001","--END_RANGE":"1800000"}'
```

```
aws glue start-job-run --job-name create_small_files --arguments '{"--START_RANGE":"1800001","--END_RANGE":"2000000"}'
```

```
aws glue start-job-run --job-name create_small_files --arguments '{"--START_RANGE":"2000001","--END_RANGE":"2200000"}'
```

```
aws glue start-job-run --job-name create_small_files --arguments '{"--START_RANGE":"2200001","--END_RANGE":"2400000"}'
```

```
aws glue start-job-run --job-name create_small_files --arguments '{"--START_RANGE":"2400001","--END_RANGE":"2600000"}'
```

```
aws glue start-job-run --job-name create_small_files --arguments '{"--START_RANGE":"2600001","--END_RANGE":"2800000"}'
```

```
aws glue start-job-run --job-name create_small_files --arguments '{"--START_RANGE":"2800001","--END_RANGE":"3000000"}'
```

```
aws glue start-job-run --job-name create_small_files --arguments '{"--START_RANGE":"3000001","--END_RANGE":"3200000"}'
```

```
aws glue start-job-run --job-name create_small_files --arguments '{"--START_RANGE":"3200001","--END_RANGE":"3400000"}'
```

```
aws glue start-job-run --job-name create_small_files --arguments '{"--START_RANGE":"3400001","--END_RANGE":"3600000"}'
```

```
aws glue start-job-run --job-name create_small_files --arguments '{"--START_RANGE":"3600001","--END_RANGE":"3800000"}'
```

```
aws glue start-job-run --job-name create_small_files --arguments '{"--START_RANGE":"3800001","--END_RANGE":"4000000"}'
```

```
aws glue start-job-run --job-name create_small_files --arguments '{"--START_RANGE":"4000001","--END_RANGE":"4200000"}'
```



```
aws glue start-job-run --job-name create_small_files --arguments '{"--START_RANGE":"4200001","--END_RANGE":"4400000"}'
```

```
aws glue start-job-run --job-name create_small_files --arguments '{"--START_RANGE":"4400001","--END_RANGE":"4600000"}'
```

```
aws glue start-job-run --job-name create_small_files --arguments '{"--START_RANGE":"4600001","--END_RANGE":"4800000"}'
```

```
aws glue start-job-run --job-name create_small_files --arguments '{"--START_RANGE":"4800001","--END_RANGE":"5000000"}'
```

```
aws glue start-job-run --job-name create_small_files --arguments '{"--START_RANGE":"5000001","--END_RANGE":"5200000"}'
```

```
aws glue start-job-run --job-name create_small_files --arguments '{"--START_RANGE":"5200001","--END_RANGE":"5400000"}'
```

```
aws glue start-job-run --job-name create_small_files --arguments '{"--START_RANGE":"5400001","--END_RANGE":"5600000"}'
```

```
aws glue start-job-run --job-name create_small_files --arguments '{"--START_RANGE":"5600001","--END_RANGE":"5800000"}'
```

```
aws glue start-job-run --job-name create_small_files --arguments '{"--START_RANGE":"5800001","--END_RANGE":"6000000"}'
```

```
aws glue start-job-run --job-name create_small_files --arguments '{"--START_RANGE":"6000001","--END_RANGE":"6200000"}'
```

```
aws glue start-job-run --job-name create_small_files --arguments '{"--START_RANGE":"6200001","--END_RANGE":"6400000"}'
```

```
aws glue start-job-run --job-name create_small_files --arguments '{"--START_RANGE":"6400001","--END_RANGE":"6600000"}'
```

```
aws glue start-job-run --job-name create_small_files --arguments '{"--START_RANGE":"6600001","--END_RANGE":"6800000"}'
```

```
aws glue start-job-run --job-name create_small_files --arguments '{"--START_RANGE":"6800001","--END_RANGE":"7000000"}'
```

```
aws glue start-job-run --job-name create_small_files --arguments '{"--START_RANGE":"7000001","--END_RANGE":"7200000"}'
```

```
aws glue start-job-run --job-name create_small_files --arguments '{"--START_RANGE":"7200001","--END_RANGE":"7400000"}'
```

```
aws glue start-job-run --job-name create_small_files --arguments '{"--START_RANGE":"7400001","--END_RANGE":"7600000"}'
```

```
aws glue start-job-run --job-name create_small_files --arguments '{"--START_RANGE":"7600001","--END_RANGE":"7800000"}'
```

```
aws glue start-job-run --job-name create_small_files --arguments '{"--START_RANGE":"7800001","--END_RANGE":"8000000"}'
```

```
aws glue start-job-run --job-name create_small_files --arguments '{"--START_RANGE":"8000001","--END_RANGE":"8200000"}'
```

```
aws glue start-job-run --job-name create_small_files --arguments '{"--START_RANGE":"8200001","--END_RANGE":"8400000"}'
```

```
aws glue start-job-run --job-name create_small_files --arguments '{"--START_RANGE":"8400001","--END_RANGE":"8600000"}'
```

```
aws glue start-job-run --job-name create_small_files --arguments '{"--START_RANGE":"8600001","--END_RANGE":"8800000"}'
aws glue start-job-run --job-name create_small_files --arguments '{"--START_RANGE":"8800001","--END_RANGE":"9000000"}'
aws glue start-job-run --job-name create_small_files --arguments '{"--START_RANGE":"9000001","--END_RANGE":"9200000"}'
aws glue start-job-run --job-name create_small_files --arguments '{"--START_RANGE":"9200001","--END_RANGE":"9400000"}'
aws glue start-job-run --job-name create_small_files --arguments '{"--START_RANGE":"9400001","--END_RANGE":"9600000"}'
aws glue start-job-run --job-name create_small_files --arguments '{"--START_RANGE":"9600001","--END_RANGE":"9800000"}'
aws glue start-job-run --job-name create_small_files --arguments '{"--START_RANGE":"9800001","--END_RANGE":"10000000"}'
```

```
user@MUC-1234567890 MINGW64 ~
```

## FAQ

### *How many concurrent runs or parallel jobs should I use?*

The number of concurrent runs and parallel jobs depend on your time requirement and desired number of test files. We recommend that you check the size of the files that you're creating. First, check how much time an AWS Glue job takes to generate your desired number of files. Then, use the right number of concurrent runs to meet your goals. For example, if you assume that 100,000 files takes 40 minutes to complete the run but your target time is 30 minutes, then you must increase the concurrency setting for your AWS Glue job.

### *What type of content can I create using this pattern?*

You can create any type of content, such as text files with different delimiters (for example, PIPE, JSON, or CSV). This pattern uses Boto3 to write to a file and then saves the file in an S3 bucket.

### *What level of IAM permission do I need in the S3 bucket?*

You must have an identity-based policy that allows Write access to objects in your S3 bucket. For more information, see [Amazon S3: Allows read and write access to objects in an S3 bucket](#) in the Amazon S3 documentation.

# Cost-effectively ingest IoT data directly into Amazon S3 using AWS IoT Greengrass

Created by Sebastian Viviani (AWS) and Rizwan Syed (AWS)

**Environment:** PoC or pilot

**Technologies:** Analytics; IoT

**Workload:** Open-source

**AWS services:** AWS IoT Greengrass; Amazon S3; Amazon Athena

## Summary

This pattern shows you how to cost-effectively ingest Internet of Things (IoT) data directly into an Amazon Simple Storage Service (Amazon S3) bucket by using an AWS IoT Greengrass Version 2 device. The device runs a custom component that reads the IoT data and saves the data in persistent storage (that is, a local disk or volume). Then, the device compresses the IoT data into an Apache Parquet file and uploads the data periodically to an S3 bucket.

The amount and speed of IoT data that you ingest is limited only by your edge hardware capabilities and network bandwidth. You can use Amazon Athena to cost-effectively analyze your ingested data. Athena supports compressed Apache Parquet files and data visualization by using [Amazon Managed Grafana](#).

## Prerequisites and limitations

### Prerequisites

- An active AWS account
- An [edge gateway](#) that runs on [AWS IoT Greengrass Version 2](#) and collects data from sensors (The data sources and the data collection process are beyond the scope of this pattern, but you can use nearly any type of sensor data. This pattern uses a local [MQTT](#) broker with sensors or gateways that publish data locally.)
- AWS IoT Greengrass [component](#), [roles](#), and [SDK dependencies](#)
- A [stream manager component](#) to upload the data to the S3 bucket

- [AWS SDK for Java](#), [AWS SDK for JavaScript](#), or [AWS SDK for Python \(Boto3\)](#) to run the APIs

## Limitations

- The data in this pattern isn't uploaded in real time to the S3 bucket. There is a delay period, and you can configure the delay period. Data is buffered temporarily in the edge device and then uploaded once the period expires.
- The SDK is available only in Java, Node.js, and Python.

## Architecture

### Target technology stack

- Amazon S3
- AWS IoT Greengrass
- MQTT broker
- Stream manager component

### Target architecture

The following diagram shows an architecture designed to ingest IoT sensor data and store that data in an S3 bucket.

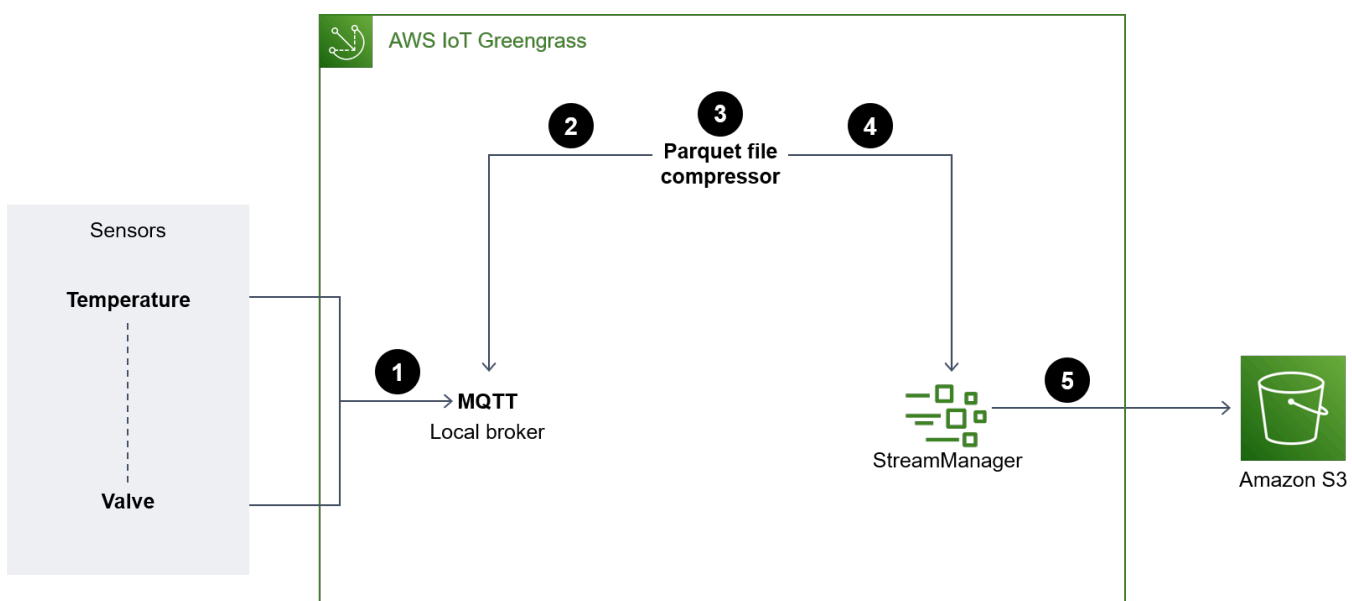

The diagram shows the following workflow:

1. Multiple sensors (for example, temperature and valve) updates are published to a local MQTT broker.
2. The Parquet file compressor that's subscribed to these sensors updates topics and receives these updates.
3. The Parquet file compressor stores the updates locally.
4. After the period lapses, the stored files are compressed into Parquet files and passed on to the stream manager to get uploaded to the specified S3 bucket.
5. The stream manager uploads the Parquet files to the S3 bucket.

**Note:** The stream manager (`StreamManager`) is a managed component. For examples of how to export data to Amazon S3, see [Stream manager](#) in the AWS IoT Greengrass documentation. You can use a local MQTT broker as a component or another broker like [Eclipse Mosquitto](#).

## Tools

### AWS tools

- [Amazon Athena](#) is an interactive query service that helps you analyze data directly in Amazon S3 by using standard SQL.
- [Amazon Simple Storage Service \(Amazon S3\)](#) is a cloud-based object storage service that helps you store, protect, and retrieve any amount of data.
- [AWS IoT Greengrass](#) is an open source IoT edge runtime and cloud service that helps you build, deploy, and manage IoT applications on your devices.

### Other tools

- [Apache Parquet](#) is an open-source column-oriented data file format designed for storage and retrieval.
- [MQTT](#) (Message Queuing Telemetry Transport) is a lightweight messaging protocol that's designed for constrained devices.

## Best practices

### Use the right partition format for uploaded data

There are no specific requirements for the root prefix names in the S3 bucket (for example, "myAwesomeDataSet/" or "dataFromSource"), but we recommend that you use a meaningful partition and prefix so that it's easy to understand the purpose of the dataset.

We also recommend that you use the right partitioning in Amazon S3 so that the queries run optimally on the dataset. In the following example, the data is partitioned in HIVE format so that the amount of data scanned by each Athena query is optimized. This improves performance and reduces cost.

```
s3://<ingestionBucket>/<rootPrefix>/year=YY/month=MM/day=DD/
HHMM_<suffix>.parquet
```

## Epics

### Set up your environment

Task	Description	Skills required
Create an S3 bucket.	<ol style="list-style-type: none"> <li>1. <a href="#">Create an S3 bucket</a> or use an existing bucket.</li> <li>2. Create a meaningful <a href="#">prefix</a> for the S3 bucket where you want to ingest the IoT data (for example, <code>s3://&lt;bucket&gt;/&lt;prefix&gt;</code> ).</li> <li>3. Record your prefix for later use.</li> </ol>	App developer
Add IAM permissions to the S3 bucket.	<p>To grant users write access to the S3 bucket and prefix that you created earlier, add the following IAM policy to your AWS IoT Greengrass role:</p> <pre>{   "Version":     "2012-10-17",</pre>	App developer

Task	Description	Skills required
	<pre data-bbox="592 205 1031 1218">    "Statement": [       {         "Sid":         "S3DataUpload",         "Effect":         "Allow",         "Action": [          "s3:List*",          "s3:Put*"         ],         "Resource":         [          "arn:aws:s3:::&lt;ing         estionBucket&gt;",          "arn:aws:s3:::&lt;ing         estionBucket&gt;/&lt;pre         fix&gt;/*"         ]       }     ]   }</pre> <p data-bbox="592 1255 1031 1438">For more information, see <a href="#">Creating an IAM policy to access Amazon S3 resources</a> in the Aurora documentation.</p> <p data-bbox="592 1480 1031 1711">Next, update the resource policy (if needed) for the S3 bucket to allow write access with the correct AWS <a href="#">principals</a>.</p>	

## Build and deploy the AWS IoT Greengrass component

Task	Description	Skills required
Update the recipe of the component.	<p><a href="#">Update the component configuration</a> when you <a href="#">create a deployment</a> based on the following example:</p> <pre data-bbox="594 548 1027 947">{   "region": "&lt;region&gt;",   "parquet_period":   &lt;period&gt;,   "s3_bucket":   "&lt;s3Bucket&gt;",   "s3_key_prefix":   "&lt;s3prefix&gt;" }</pre> <p>Replace &lt;region&gt; with your AWS Region, &lt;period&gt; with your periodic interval, &lt;s3Bucket&gt; with your S3 bucket, and &lt;s3prefix&gt; with your prefix.</p>	App developer
Create the component.	<p>Do one of the following:</p> <ul style="list-style-type: none"><li>• <a href="#">Create the component</a>.</li><li>• Add the component to the CI/CD pipeline (if one exists). Be sure to copy the artifact from the artifact repository to the AWS IoT Greengrass artifact bucket. Then, create or update your AWS IoT Greengrass component.</li></ul>	App developer



Task	Description	Skills required
	<ul style="list-style-type: none"> <li>• Add the MQTT broker as a component or add it manually later. <b>Note:</b> This decision affects the authentication scheme that you can use with the broker. Manually adding a broker decouples the broker from AWS IoT Greengrass and enables any supported authentication scheme of the broker. The AWS provided broker components have predefined authentication schemes. For more information, see <a href="#">MQTT 3.1.1 broker (Moquette)</a> and <a href="#">MQTT 5 broker (EMQX)</a>.</li> </ul>	
Update the MQTT client.	<p>The sample code doesn't use authentication because the component connects locally to the broker. If your scenario differs, update the MQTT client section as needed. Additionally, do the following:</p> <ol style="list-style-type: none"> <li>1. Update the MQTT topics in the subscription.</li> <li>2. Update the MQTT message parser as needed as messages from each source may differ.</li> </ol>	App developer

## Add the component to the AWS IoT Greengrass Version 2 core device

Task	Description	Skills required
Update the deployment of the core device.	<p>If the deployment of the AWS IoT Greengrass Version 2 core device already exists, <a href="#">revise the deployment</a>. If the deployment doesn't exist, <a href="#">create a new deployment</a>.</p> <p>To give the component the correct name, <a href="#">update the log manager configuration</a> for the new component (if needed) based on the following:</p> <pre data-bbox="594 953 1029 1885">{   "logsUploaderConfiguration": {     "systemLogsConfiguration": {       ...     },     "componentLogsConfigurationMap": {       "&lt;com.iot.ingest.parquet&gt;": {         "minimumLogLevel": "INFO",         "diskSpaceLimit": "20",         "diskSpaceLimitUnit": "MB",         "deleteLogFileAfterCloudUpload": "false"       }       ...     }   } }</pre>	App developer

Task	Description	Skills required
	<pre data-bbox="597 205 1023 384"> }, "periodicUploadIntervalSec": "300" } </pre> <p data-bbox="597 426 1023 604">Finally, complete the revision of the deployment for your AWS IoT Greengrass core device.</p>	

### Verify data ingestion into the S3 bucket

Task	Description	Skills required
Check the logs for the AWS IoT Greengrass volume.	<p data-bbox="597 896 941 930">Check for the following:</p> <ul data-bbox="597 978 1023 1560" style="list-style-type: none"> <li data-bbox="597 978 1023 1104">• The MQTT client is successfully connected to the local MQTT broker.</li> <li data-bbox="597 1131 1023 1257">• The MQTT client is subscribed to the correct topics.</li> <li data-bbox="597 1285 1023 1411">• Sensor update messages are coming to the broker on the MQTT topics.</li> <li data-bbox="597 1438 1023 1560">• Parquet compression happens at every periodic interval.</li> </ul>	App developer
Check the S3 bucket.	Verify if the data is being uploaded to the S3 bucket. You can see the files being uploaded at every period.	App developer

Task	Description	Skills required
	You can also verify if the data is uploaded to the S3 bucket by querying the data in the next section.	

## Set up querying from Athena

Task	Description	Skills required
Create a database and table.	<ol style="list-style-type: none"> <li><a href="#">Create an AWS Glue database</a> (if needed).</li> <li>Create a table in AWS Glue <a href="#">manually</a> or by running a <a href="#">crawler</a> in AWS Glue.</li> </ol>	App developer
Grant Athena access to the data.	<ol style="list-style-type: none"> <li>Update permissions to allow Athena to access the S3 bucket. For more information, see <a href="#">Fine-grained access to databases and tables in the AWS Glue Data Catalog</a> in the Athena documentation.</li> <li>Query the table in your database.</li> </ol>	App developer

## Troubleshooting

Issue	Solution
MQTT client fails to connect	<ul style="list-style-type: none"> <li>Validate the permissions on the MQTT broker. If you have an MQTT broker from</li> </ul>

Issue	Solution
	<p>AWS, see <a href="#">MQTT 3.1.1 broker (Moquette)</a> and <a href="#">MQTT 5 broker (EMQX)</a>.</p> <ul style="list-style-type: none"> <li>• Validate the credentials on the MQTT client. If you have an MQTT broker from AWS, see <a href="#">MQTT 3.1.1 broker (Moquette)</a> and <a href="#">MQTT 5 broker (EMQX)</a>.</li> </ul>
MQTT client fails to subscribe	<p>Validate the permissions on the MQTT broker. If you have an MQTT broker from AWS, see <a href="#">MQTT 3.1.1 broker (Moquette)</a> and <a href="#">MQTT 5 broker (EMQX)</a>.</p>
Parquet files don't get created	<ul style="list-style-type: none"> <li>• Verify that the MQTT topics are correct.</li> <li>• Verify that the MQTT messages from the sensors are in the correct format.</li> </ul>
Objects are not uploaded to the S3 bucket	<ul style="list-style-type: none"> <li>• Verify that you have internet connectivity and endpoint connectivity.</li> <li>• Verify that the resource policy for your S3 bucket is correct.</li> <li>• Verify the permissions for the AWS IoT Greengrass Version 2 core device role.</li> </ul>

## Related resources

- [DataFrame](#) (Pandas documentation)
- [Apache Parquet Documentation](#) (Parquet documentation)
- [Develop AWS IoT Greengrass components](#) (AWS IoT Greengrass Developer Guide, Version 2)
- [Deploy AWS IoT Greengrass components to devices](#) (AWS IoT Greengrass Developer Guide, Version 2)
- [Interact with local IoT devices](#) (AWS IoT Greengrass Developer Guide, Version 2)
- [MQTT 3.1.1 broker \(Moquette\)](#) (AWS IoT Greengrass Developer Guide, Version 2)
- [MQTT 5 broker \(EMQX\)](#) (AWS IoT Greengrass Developer Guide, Version 2)

## Additional information

### Cost analysis

The following cost analysis scenario demonstrates how the data ingestion approach covered in this pattern can impact data ingestion costs in the AWS Cloud. The pricing examples in this scenario are based on prices at the time of publication. Prices are subject to change. Additionally, your costs may vary depending on your AWS Region, AWS service quotas, and other factors related to your cloud environment.

#### *Input signal set*

This analysis uses the following set of input signals as the basis for comparing IoT ingestion costs with other available alternatives.

<b>Number of signals</b>	<b>Frequency</b>	<b>Data per signal</b>
125	25 Hz	8 bytes

In this scenario, the system receives 125 signals. Each signal is 8 bytes and occurs every 40 milliseconds (25 Hz). These signals could come individually or grouped in a common payload. You have the option to split and pack these signals based on your needs. You can also determine the latency. Latency consists of the time period for receiving, accumulating, and ingesting the data.

For comparison purposes, the ingestion operation for this scenario is based in the us-east-1 AWS Region. The cost comparison applies to AWS services only. Other costs, like hardware or connectivity, are not factored into the analysis.

#### *Cost comparisons*

The following table shows the monthly cost in US dollars (USD) for each ingestion method.

<b>Method</b>	<b>Monthly cost</b>
AWS IoT SiteWise*	331.77 USD
AWS IoT SiteWise Edge with data processing pack (keeping all data at the edge)	200 USD

AWS IoT Core and Amazon S3 rules for accessing raw data	84.54 USD
Parquet file compression at the edge and uploading to Amazon S3	0.5 USD

\*Data must be downsampled to comply with service quotas. This means there is some data loss with this method.

### *Alternative methods*

This section shows the equivalent costs for the following alternative methods:

- **AWS IoT SiteWise** – Each signal must be uploaded in an individual message. Therefore, the total number of messages per month is  $125 \times 25 \times 3600 \times 24 \times 30$ , or 8.1 billion messages per month. However, AWS IoT SiteWise can handle only 10 data points per second per property. Assuming the data is downsampled to 10 Hz, the number of messages per month is reduced to  $125 \times 10 \times 3600 \times 24 \times 30$ , or 3.24 billion. If you use the publisher component that packs measurements in groups of 10 (at 1 USD per million messages), then you get a monthly cost of 324 USD per month. Assuming that each message is 8 bytes (1 Kb/125), that's 25.92 Gb of data storage. This adds a monthly cost of 7.77 USD per month. The total cost for the first month is 331.77 USD and increases by 7.77 USD every month.
- **AWS IoT SiteWise Edge with data processing pack, including all models and signals fully processed at the edge (that is, no cloud ingestion)** – You can use the data processing pack as an alternative to reduce costs and to configure all the models that get calculated at the edge. This can work just for storage and visualization, even if no real calculation is performed. In this case, it's necessary to use powerful hardware for the edge gateway. There is a fixed cost of 200 USD per month.
- **Direct ingestion to AWS IoT Core by MQTT and an IoT rule to store the raw data in Amazon S3** – Assuming all the signals are published in a common payload, the total number of messages published to AWS IoT Core is  $25 \times 3600 \times 24 \times 30$ , or 64.8 million per month. At 1 USD per million messages, that's a monthly cost of 64.8 USD per month. At 0.15 USD per million rule activations and with one rule per message, that adds a monthly cost of 19.44 USD per month. At a cost of 0.023 USD per Gb of storage in Amazon S3, that adds another 1.5 USD per month (increasing every month to reflect the new data). The total cost for the first month is 84.54 USD and increases by 1.5 USD every month.

- **Compressing data at the edge in a Parquet file and uploading to Amazon S3 (proposed method)** – The compression ratio depends on the type of data. With the same industrial data tested for MQTT, the total output data for a full month is 1.2 Gb. This costs 0.03 USD per month. Compression ratios (using random data) described in other benchmarks are on the order of 66 percent (closer to a worst-case scenario). The total data is 21 Gb and costs 0.5 USD per month.

## Parquet file generator

The following code example shows the structure of a Parquet file generator that's written in Python. The code example is for illustration purposes only and won't work if pasted into your environment.

```
import queue
import paho.mqtt.client as mqtt
import pandas as pd

#queue for decoupling the MQTT thread
messageQueue = queue.Queue()
client = mqtt.Client()
streammanager = StreamManagerClient()

def feederListener(topic, message):
    payload = {
        "topic" : topic,
        "payload" : message,
    }
    messageQueue.put_nowait(payload)

def on_connect(client_instance, userdata, flags, rc):
    client.subscribe("#",qos=0)

def on_message(client, userdata, message):
    feederListener(topic=str(message.topic),
        message=str(message.payload.decode("utf-8")))

filename = "tempfile.parquet"
streamname = "mystream"
destination_bucket= "amzn-s3-demo-bucket"
keyname="mykey"
period= 60
```



```
client.on_connect = on_connect
client.on_message = on_message
streammanager.create_message_stream(
    MessageStreamDefinition(name=streamname,
        strategy_on_full=StrategyOnFull.OverwriteOldestData)
    )

while True:
    try:
        message = messageQueue.get(timeout=myArgs.mqtt_timeout)
    except (queue.Empty):
        logger.warning("MQTT message reception timed out")

    currentTimestamp = getCurrentTime()
    if currentTimestamp >= nextUploadTimestamp:
        df = pd.DataFrame.from_dict(accumulator)
        df.to_parquet(filename)
        s3_export_task_definition = S3ExportTaskDefinition(input_url=filename,
            bucket=destination_bucket, key=key_name)
        streammanager.append_message(streamname,
            Util.validate_and_serialize_to_json_bytes(s3_export_task_definition))
        accumulator = {}
        nextUploadTimestamp += period
    else:
        accumulator.append(message)
```

# Launch a Spark job in a transient EMR cluster using a Lambda function

Created by Dhrubajyoti Mukherjee (AWS)

<b>Environment:</b> Production	<b>Technologies:</b> Analytics	<b>Workload:</b> Open-source
<b>AWS services:</b> Amazon EMR; AWS Identity and Access Management; AWS Lambda; Amazon VPC		

## Summary

This pattern uses the Amazon EMR RunJobFlow API action to launch a transient cluster to run a Spark job from a Lambda function. A transient EMR cluster is designed to terminate as soon as the job is complete or if any error occurs. A transient cluster provides cost savings because it runs only during the computation time, and it provides scalability and flexibility in a cloud environment.

The transient EMR cluster is launched using the Boto3 API and the Python programming language in a Lambda function. The Lambda function, which is written in Python, provides the added flexibility of initiating the cluster when it is needed.

To demonstrate a sample batch computation and output, this pattern will launch a Spark job in an EMR cluster from a Lambda function and run a batch computation against the example sales data of a fictional company. The output of the Spark job will be a comma-separated values (CSV) file in Amazon Simple Storage Service (Amazon S3). The input data file, Spark .jar file, a code snippet, and an AWS CloudFormation template for a virtual private cloud (VPC) and AWS Identity and Access Management (IAM) roles to run the computation are provided as an attachment.

## Prerequisites and limitations

### Prerequisites

- An active AWS account

### Limitations

- Only one Spark job can be initiated from the code at a time.

## Product versions

- Tested on Amazon EMR 6.0.0

## Architecture

### Target technology stack

- Amazon EMR
- AWS Lambda
- Amazon S3
- Apache Spark

### Target architecture

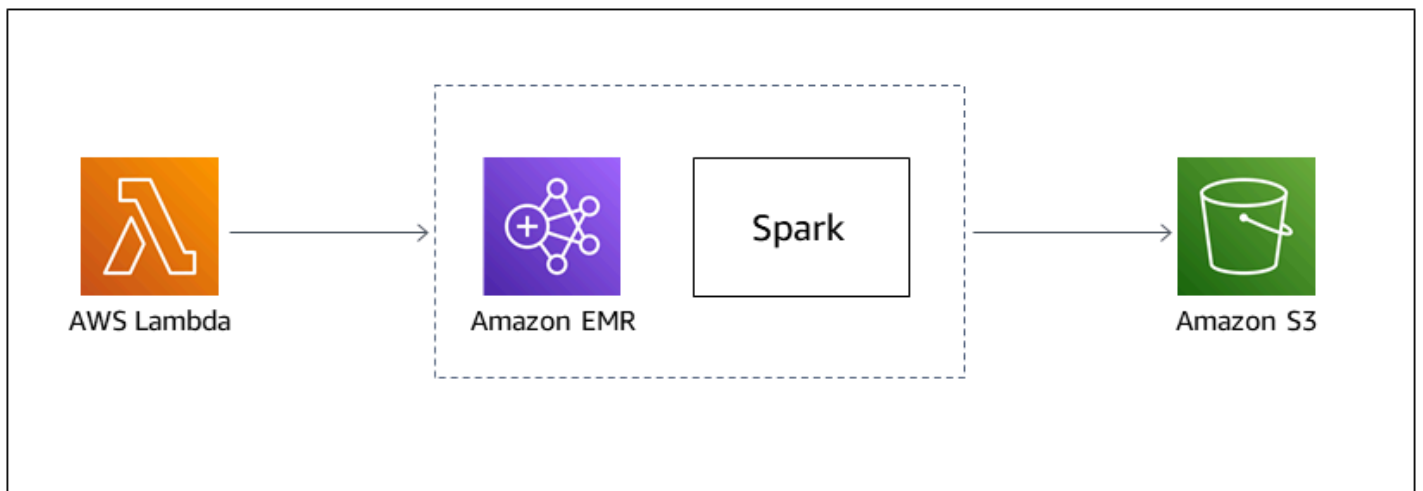

### Automation and scale

To automate the Spark-EMR batch computation, you can use either of the following options.

- Implement an Amazon EventBridge rule that can initiate the Lambda function in a cron schedule. For more information, see [Tutorial: Schedule AWS Lambda functions using EventBridge](#).
- Configure [Amazon S3 event notifications](#) to initiate the Lambda function on file arrival.

- Pass the input parameters to the AWS Lambda function through the event body and Lambda environment variables.

## Tools

### AWS services

- [Amazon EMR](#) is a managed cluster platform that simplifies running big data frameworks on AWS to process and analyze large amounts of data.
- [AWS Lambda](#) is a compute service that helps you run code without needing to provision or manage servers. It runs your code only when needed and scales automatically, so you pay only for the compute time that you use.
- [Amazon Simple Storage Service \(Amazon S3\)](#) is a cloud-based object storage service that helps you store, protect, and retrieve any amount of data.

### Other tools

- [Apache Spark](#) is a multiple-language analytics engine for large-scale data processing.

## Epics

### Create the Amazon EMR and Lambda IAM roles and the VPC

Task	Description	Skills required
Create the IAM roles and the VPC.	If you already have the AWS Lambda and Amazon EMR IAM roles and a VPC, you can skip this step. To run the code, both the EMR cluster and the Lambda function require IAM roles. The EMR cluster also requires a VPC with a public subnet or a private subnet with a NAT gateway. To automatically	Cloud architect

Task	Description	Skills required
	<p>create all the IAM roles and a VPC, deploy the attached AWS CloudFormation template as is, or you can create the roles and the VPC manually as specified in the <i>Additional information</i> section.</p>	
<p>Note the AWS CloudFormation template output keys.</p>	<p>After the CloudFormation template has successfully deployed, navigate to the <b>Outputs</b> tab in the AWS CloudFormation console. Note the five output keys:</p> <ul style="list-style-type: none"> <li>• S3Bucket</li> <li>• LambdaExecutionRole</li> <li>• ServiceRole</li> <li>• JobFlowRole</li> <li>• Ec2SubnetId</li> </ul> <p>You will use the values from these keys when you create the Lambda function.</p>	<p>Cloud architect</p>

### Upload the Spark .jar file

Task	Description	Skills required
<p>Upload the Spark .jar file.</p>	<p>Upload the Spark .jar file to the S3 bucket that the AWS CloudFormation stack created. The bucket name is</p>	<p>General AWS</p>

Task	Description	Skills required
	the same as the output key S3Bucket.	

## Create the Lambda function to launch the EMR cluster

Task	Description	Skills required
Create a Lambda function.	On the Lambda console, create a Python 3.9+ Lambda function with an execution role. The execution role policy must allow Lambda to launch an EMR cluster. (See the attached AWS CloudFormation template.)	Data engineer, Cloud engineer
Copy and paste the code.	Replace the code in the <code>lambda_function.py</code> file with the code from the <i>Additional information</i> section of this pattern.	Data engineer, Cloud engineer
Change the parameters in the code.	Follow the comments in the code to change the parameter values to match your AWS account.	Data engineer, Cloud engineer
Launch the function to initiate the cluster.	Launch the function to initiate the creation of a transient EMR cluster with the Spark .jar file provided. It will run the Spark job and terminate automatically when the job is complete.	Data engineer, Cloud engineer

Task	Description	Skills required
Check the EMR cluster status.	After the EMR cluster is initiated, it appears in the Amazon EMR console under the <b>Clusters</b> tab. Any errors while launching the cluster or running the job can be checked accordingly.	Data engineer, Cloud engineer

### Set up and run the sample demo

Task	Description	Skills required
Upload the Spark .jar file.	Download the Spark .jar file from the <i>Attachments</i> section and upload it to the S3 bucket.	Data engineer, Cloud engineer
Upload the input dataset.	Upload the attached <code>fake_sales_data.csv</code> file to the S3 bucket.	Data engineer, Cloud engineer
Paste the Lambda code and change the parameters.	Copy the code from the <b>Tools</b> section, and paste the code in a Lambda function, replacing the code <code>lambda_function.py</code> file. Change the parameter values to match your account.	Data engineer, Cloud engineer
Launch the function and verify the output.	After the Lambda function initiates the cluster with the provided Spark job, it generates a .csv file in the S3 bucket.	Data engineer, Cloud engineer

## Related resources

- [Building Spark](#)
- [Apache Spark and Amazon EMR](#)
- [Boto3 Docs run\\_job\\_flow documentation](#)
- [Apache Spark information and documentation](#)

## Additional information

### Code

```
"""
```

```
Copy paste the following code in your Lambda function. Make sure to change the following key parameters for the API as per your account
```

```
-Name (Name of Spark cluster)
-LogUri (S3 bucket to store EMR logs)
-Ec2SubnetId (The subnet to launch the cluster into)
-JobFlowRole (Service role for EC2)
-ServiceRole (Service role for Amazon EMR)
```

```
The following parameters are additional parameters for the Spark job itself. Change the bucket name and prefix for the Spark job (located at the bottom).
```

```
-s3://your-bucket-name/prefix/lambda-emr/SparkProfitCalc.jar (Spark jar file)
-s3://your-bucket-name/prefix/fake_sales_data.csv (Input data file in S3)
-s3://your-bucket-name/prefix/outputs/report_1/ (Output location in S3)
"""
```

```
import boto3
```

```
client = boto3.client('emr')
```

```
def lambda_handler(event, context):
    response = client.run_job_flow(
        Name='spark_job_cluster',
        LogUri='s3://your-bucket-name/prefix/logs',
        ReleaseLabel='emr-6.0.0',
        Instances={
            'MasterInstanceType': 'm5.xlarge',
            'SlaveInstanceType': 'm5.large',
```



```

        'InstanceCount': 1,
        'KeepJobFlowAliveWhenNoSteps': False,
        'TerminationProtected': False,
        'Ec2SubnetId': 'subnet-XXXXXXXXXXXXXXX'
    },
    Applications=[{'Name': 'Spark'}],
    Configurations=[
        {'Classification': 'spark-hive-site',
         'Properties': {
             'hive.metastore.client.factory.class':
'com.amazonaws.glue.catalog.metastore.AWSGlueDataCatalogHiveClientFactory'}
        }
    ],
    VisibleToAllUsers=True,
    JobFlowRole='EMRLambda-EMREC2InstanceProfile-XXXXXXXXXX',
    ServiceRole='EMRLambda-EMRRole-XXXXXXXXXX',
    Steps=[
        {
            'Name': 'flow-log-analysis',
            'ActionOnFailure': 'TERMINATE_CLUSTER',
            'HadoopJarStep': {
                'Jar': 'command-runner.jar',
                'Args': [
                    'spark-submit',
                    '--deploy-mode', 'cluster',
                    '--executor-memory', '6G',
                    '--num-executors', '1',
                    '--executor-cores', '2',
                    '--class', 'com.aws.emr.ProfitCalc',
                    's3://your-bucket-name/prefix/lambda-emr/SparkProfitCalc.jar',
                    's3://your-bucket-name/prefix/fake_sales_data.csv',
                    's3://your-bucket-name/prefix/outputs/report_1/'
                ]
            }
        }
    ]
)

```

## IAM roles and VPC creation

To launch the EMR cluster in a Lambda function, a VPC and IAM roles are needed. You can set up the VPC and IAM roles by using the AWS CloudFormation template in the Attachments section of this pattern, or you can manually create them by using the following links.

The following IAM roles are required to run Lambda and Amazon EMR.

### *Lambda execution role*

A Lambda function's [execution role](#) grants it permission to access AWS services and resources.

### *Service role for Amazon EMR*

The [Amazon EMR role](#) defines the allowable actions for Amazon EMR when provisioning resources and performing service-level tasks that are not performed in the context of an Amazon Elastic Compute Cloud (Amazon EC2) instance running within a cluster. For example, the service role is used to provision EC2 instances when a cluster launches.

### *Service role for EC2 instances*

The [service role for cluster EC2 instances](#) (also called the EC2 instance profile for Amazon EMR) is a special type of service role that is assigned to every EC2 instance in an Amazon EMR cluster when the instance launches. Application processes that run on top of Apache Hadoop assume this role for permissions to interact with other AWS services.

### *VPC and subnet creation*

You can [create a VPC](#) from the VPC console.

## **Attachments**

To access additional content that is associated with this document, unzip the following file: [attachment.zip](#)

# Migrate Apache Cassandra workloads to Amazon Keyspaces by using AWS Glue

Created by Nikolai Kolesnikov (AWS), Karthiga Priya Chandran (AWS), and Samir Patel (AWS)

<b>Environment:</b> Production	<b>Source:</b> Cassandra	<b>Target:</b> Amazon Keyspaces
<b>R Type:</b> N/A	<b>Workload:</b> Open-source; All other workloads	<b>Technologies:</b> Analytics; Migration; Serverless; Big data

**AWS services:** AWS Glue; Amazon Keyspaces; Amazon S3; AWS CloudShell

## Summary

This pattern shows you how to migrate your existing Apache Cassandra workloads to Amazon Keyspaces (for Apache Cassandra) by using CQLReplicator on AWS Glue. You can use CQLReplicator on AWS Glue to minimize the replication lag of migrating your workloads down to a matter of minutes. You also learn how to use an Amazon Simple Storage Service (Amazon S3) bucket to store data required for the migration, including [Apache Parquet](#) files, configuration files, and scripts. This pattern assumes that your Cassandra workloads are hosted on Amazon Elastic Compute Cloud (Amazon EC2) instances in a virtual private cloud (VPC).

## Prerequisites and limitations

### Prerequisites

- Cassandra cluster with a source table
- Target table in Amazon Keyspaces to replicate the workload
- S3 bucket to store intermediate Parquet files that contain incremental data changes
- S3 bucket to store job configuration files and scripts

### Limitations

- CQLReplicator on AWS Glue requires some time to provision Data Processing Units (DPUs) for the Cassandra workloads. The replication lag between the Cassandra cluster and the target keyspace and table in Amazon Keyspaces is likely to last for only a matter of minutes.

## Architecture

### Source technology stack

- Apache Cassandra
- DataStax Server
- ScyllaDB

### Target technology stack

- Amazon Keyspaces

### Migration architecture

The following diagram shows an example architecture where a Cassandra cluster is hosted on EC2 instances and spread across three Availability Zones. The Cassandra nodes are hosted in private subnets.

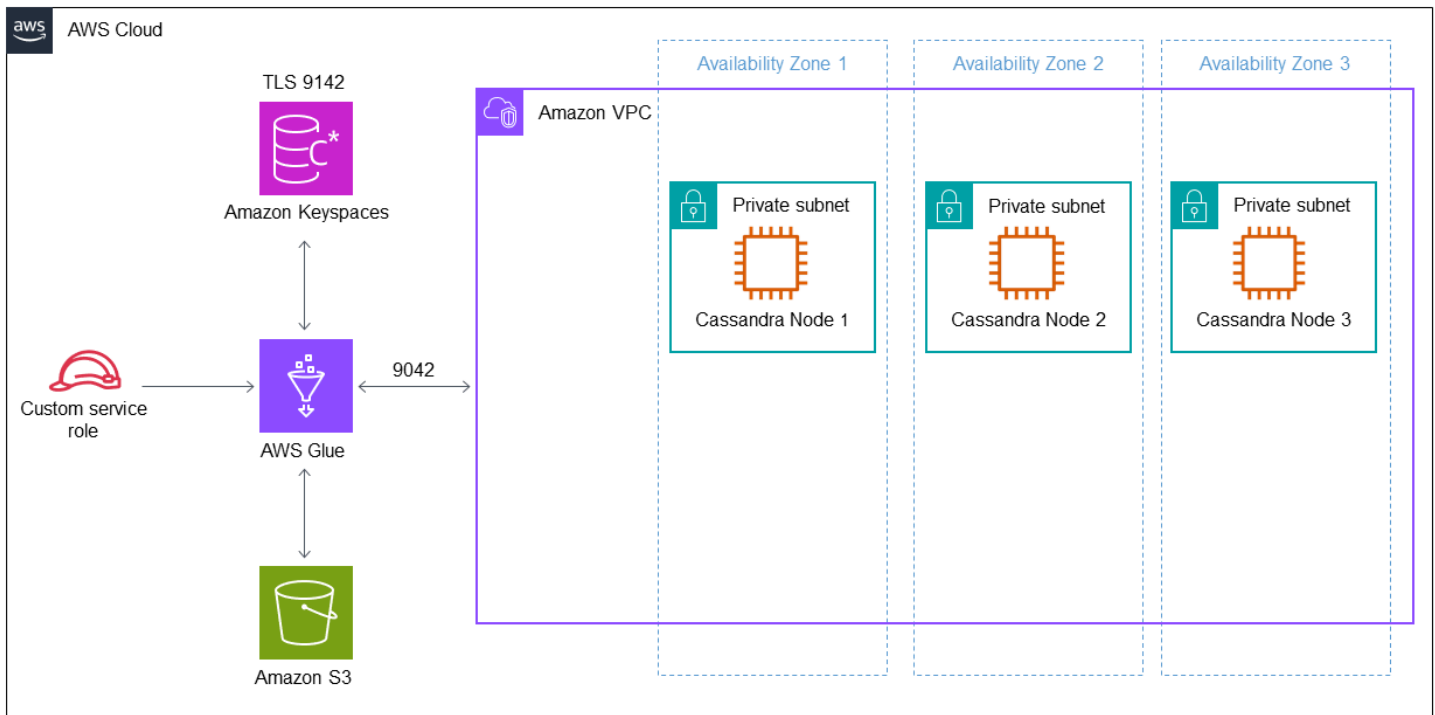

The diagram shows the following workflow:

1. A custom service role provides access to Amazon Keyspaces and the S3 bucket.
2. An AWS Glue job reads the job configuration and scripts in the S3 bucket.
3. The AWS Glue job connects through port 9042 to read data from the Cassandra cluster.
4. The AWS Glue job connects through port 9142 to write data to Amazon Keyspaces.

## Tools

### AWS services and tools

- [AWS Command Line Interface \(AWS CLI\)](#) is an open-source tool that helps you interact with AWS services through commands in your command-line shell.
- [AWS CloudShell](#) is a browser-based shell that you can use to manage AWS services by using the AWS Command Line Interface (AWS CLI) and a range of preinstalled development tools.
- [AWS Glue](#) is a fully managed ETL service that helps you reliably categorize, clean, enrich, and move data between data stores and data streams.
- [Amazon Keyspaces \(for Apache Cassandra\)](#) is a managed database service that helps you migrate, run, and scale your Cassandra workloads in the AWS Cloud.

## Code

The code for this pattern is available in the GitHub [CQLReplicator](#) repository.

## Best practices

- To determine the necessary AWS Glue resources for the migration, estimate the number of rows in the source Cassandra table. For example, 250 K rows per 0.25 DPU (2 vCPUs, 4 GB of memory) with 84 GB disk.
- Pre-warm Amazon Keyspaces tables before running CQLReplicator. For example, eight CQLReplicator tiles (AWS Glue jobs) can write up to 22 K WCUs per second, so the target should be pre-warmed up to 25-30 K WCUs per second.
- To enable communication between AWS Glue components, use a self-referencing inbound rule for all TCP ports in your security group.
- Use the incremental traffic strategy to distribute the migration workload over time.

## Epics

### Deploy CQLReplicator

Task	Description	Skills required
Create a target keyspace and table.	<p>1. Create a <a href="#">keyspace and table</a> in Amazon Keyspaces.</p> <p>For more information on write capacity, see <i>Write unit calculations</i> in the <a href="#">Additional information</a> section of this pattern.</p> <p>You can also create a keyspace by using the <a href="#">Cassandra Query Language (CQL)</a>. For more information, see <i>Create a keyspace by using CQL</i> in the</p>	App owner, AWS administrator, DBA, App developer

Task	Description	Skills required
	<p><a href="#">Additional information</a> section of this pattern.</p> <p><b>Note:</b> After you create the table, consider switching the table to <a href="#">on-demand capacity mode</a> to avoid unnecessary charges.</p> <p>2. To update to throughput mode, run the following script:</p> <pre>ALTER TABLE target_keyspace.target_table WITH CUSTOM_PROPERTIES = { 'capacity_mode': { 'throughput_mode': 'PAY_PER_REQUEST' } }</pre>	

Task	Description	Skills required
Configure the Cassandra driver to connect to Cassandra.	<p>Use the following configuration script:</p> <pre data-bbox="607 348 1029 1339">Datastax-java-driver {   basic.request.consistency = "LOCAL_QUORUM"   basic.contact-points = ["127.0.0.1:9042"]   advanced.reconnect-on-init = true   basic.load-balancing-policy {     local-dc-center = "datacenter1"   }   advanced.auth-provider = {     class = PlainTextAuthProvider     username = "user-at-sample"     password = "S@MPLE=PASSWORD="   } }</pre> <p><b>Note:</b> The preceding script uses the Spark Cassandra Connector. For more information, see the reference configuration for <a href="#">Cassandra</a>.</p>	DBA



Task	Description	Skills required
Configure the Cassandra driver to connect to Amazon Keyspaces.	<p>Use the following configuration script:</p> <pre data-bbox="592 346 1031 1831">datastax-java-driver {   basic {     load-balancing-policy {       local-datacenter =         us-west-2     }     contact-points = [       "cassandra.us-west-2.amazonaws.com:9142"     ]     request {       page-size = 2500       timeout = 360 seconds       consistency =         LOCAL_QUORUM     }   }   advanced {     control-connection {       timeout = 360 seconds     }     session-leak.threshold = 6     connection {       connect-timeout = 360         seconds       init-query-timeout =         360 seconds       warn-on-init-error =         false     }     auth-provider = {       class = software.         aws.mcs.auth.SigV4         AuthProvider     }   } }</pre>	DBA

Task	Description	Skills required
	<pre>aws-region = us- west-2 }  ssl-engine-factory {   class = DefaultSs lEngineFactory   } }</pre> <p><b>Note:</b> The preceding script uses the Spark Cassandra Connector. For more information, see the reference configuration for <a href="#">Cassandra</a>.</p>	

Task	Description	Skills required
Create an IAM role for the AWS Glue job.	<p>Create a new AWS service role named <code>glue-cassandra-migration</code> with AWS Glue as a trusted entity.</p> <p><b>Note:</b> The <code>glue-cassandra-migration</code> should provide read and write access to the S3 bucket and Amazon Keyspaces . The S3 bucket contains the .jar files, configuration files for Amazon Keyspaces and Cassandra, and the intermediate Parquet files. For example, it contains the <code>AWSGlueServiceRole</code> , <code>AmazonS3FullAccess</code> , and <code>AmazonKeyspacesFullAccess</code> managed policies.</p>	AWS DevOps

Task	Description	Skills required
Download CQLReplicator in AWS CloudShell.	<p>Download the project to your home folder by running the following command:</p> <pre data-bbox="594 394 1029 951">git clone https://github.com/aws-samples/cql-replicator.git cd cql-replicator/glue # Only for AWS CloudShell, the bc package includes bc and dc. Bc is an arbitrary precision numeric processing arithmetic language sudo yum install bc -y</pre>	
Modify the reference configuration files.	Copy CassandraConnector.conf and KeyspacesConnector.conf to the ../glue/conf directory in the project folder.	AWS DevOps

Task	Description	Skills required
Initiate the migration process.	<p>The following command initializes the CQLReplicator environment. Initialization involves copying .jar artifacts, and creating an AWS Glue connector, an S3 bucket, an AWS Glue job, the migration keyspace, and the ledger table:</p> <pre data-bbox="594 680 1029 1436">cd cql-replicator/glue/bin ./cqlreplicator --state init --sg "sg-1","sg-2" \ --subnet "subnet-XXXXXXXXXXXX" \ --az us- west-2a --region us- west-2 \ --glue- iam-role glue-cassandra- migration \ -- landing-zone s3://cql- replicator-1234567 890-us-west-2</pre> <p>The script includes the following parameters:</p> <ul style="list-style-type: none"><li>• --sg – The security groups that allow access to the Cassandra cluster from AWS Glue and include the self-referencing inbound rule for all traffic</li></ul>	AWS DevOps

Task	Description	Skills required
	<ul style="list-style-type: none"><li>• <code>--subnet</code> – The subnet to which the Cassandra cluster belongs</li><li>• <code>--az</code> – The Availability Zone of the subnet</li><li>• <code>--region</code> – The AWS Region where the Cassandra cluster is deployed</li><li>• <code>--glue-iam-role</code> – The <a href="#">IAM role permissions</a> that AWS Glue can assume when calling Amazon Keyspaces and Amazon S3 on your behalf</li><li>• <code>--landing zone</code> – An optional parameter for reusing an S3 bucket (If you don't supply a value for the <code>--landing zone</code> parameter, the <code>init</code> process will try to create a new bucket to store the configuration files, <code>.jar</code> artifacts, and intermediate files.)</li></ul>	

Task	Description	Skills required
Validate the deployment.	<p>After you run the previous command, the AWS account should contain the following:</p> <ul style="list-style-type: none"> <li>• The CQLReplicator AWS Glue job and the AWS Glue connector in AWS Glue</li> <li>• The S3 bucket that stores the artifacts</li> <li>• The target keyspace migration and the ledger table in Amazon Keyspaces</li> </ul>	AWS DevOps

## Run CQLReplicator

Task	Description	Skills required
Start the migration process.	<p>To operate CQLReplicator on AWS Glue, you need to use the <code>--state run</code> command, followed by a series of parameters. The precise configuration of these parameters is primarily determined by your unique migration requirements. For example, these settings might vary if you choose to replicate time to live (TTL) values and updates, or you offload objects exceeding 1 MB to Amazon S3.</p>	AWS DevOps

Task	Description	Skills required
	<p>To replicate the workload from the Cassandra cluster to Amazon Keyspaces, run the following command:</p> <pre data-bbox="594 426 1029 1381">./cqlreplicator --state run --tiles 8 \       -- landing-zone s3://cql- replicator-1234567 890-us-west-2 \       --region us-west-2 \       --src- keyspace source_ke yspace \       --src- table source_table \       --trg- keyspace target_key space \       -- writetime-column column_name \       --trg- table target_table -- inc-traffic</pre> <p>Your source keyspace and table are <code>source_keyspace.source_table</code> in the Cassandra cluster. Your target keyspace and table are <code>target_keyspace.target_table</code> in Amazon Keyspaces. The parameter <code>--inc-traffic</code></p>	



Task	Description	Skills required
	<p>helps prevent incremental traffic from overloading the Cassandra cluster and Amazon Keyspaces with a high number of requests.</p> <p>To replicate updates, add <code>--writetime-column regular_column_name</code> to your command line. The regular column is going to be used as the source of the write timestamp.</p>	

## Monitor the migration process

Task	Description	Skills required
<p>Validate migrated Cassandra rows during the historical migration phase.</p>	<p>To obtain the number of rows replicated during the backfilling phase, run the following command:</p> <pre data-bbox="594 1314 1029 1793"> ./cqlreplicator --state stats \                 -- landing-zone s3://cql- replicator-1234567 890-us-west-2 \                 --src- keyspace source_ke yspace --src-table source_table --region us-west-2 </pre>	<p>AWS DevOps</p>

## Stop the migration process

Task	Description	Skills required
<p>Use the <code>cqlreplicator</code> command or the AWS Glue console.</p>	<p>To stop the migration process gracefully, run the following command:</p> <pre data-bbox="594 485 1027 1121"> ./cqlreplicator --state request-stop --tiles 8 \  -- landing-zone s3://cql- replicator-1234567 890-us-west-2 \ --region us-west-2 \  --src- keyspace source_ke yspace --src-table source_table </pre> <p>To stop the migration process immediately, use the AWS Glue console.</p>	<p>AWS DevOps</p>

## Clean up

Task	Description	Skills required
<p>Delete the deployed resources .</p>	<p>The following command will delete the AWS Glue job, connector, S3 bucket, and Keyspaces table ledger:</p> <pre data-bbox="594 1787 1027 1885"> ./cqlreplicator --state cleanup --landing-zone </pre>	<p>AWS DevOps</p>

Task	Description	Skills required
	<pre>s3://cql-replicator-1234567890-us-west-2</pre>	

## Troubleshooting

Issue	Solution
AWS Glue jobs failed and returned an Out of Memory (OOM) error.	<ol style="list-style-type: none"> <li>1. Change the worker type (scale up). For example, change G0.25X to G.1X or G.1X to G.2X. Alternatively, increase the number of DPU's per AWS Glue job (scale out) in CQLReplicator.</li> <li>2. Start the migration process from the point where it was interrupted. To restart failed CQLReplicator jobs, rerun the <code>--state run</code> command with the same parameters.</li> </ol>

## Related resources

- [CQLReplicator with AWS Glue README.MD](#)
- [AWS Glue documentation](#)
- [Amazon Keyspaces documentation](#)
- [Apache Cassandra](#)

## Additional information

### Migration considerations

You can use AWS Glue to migrate your Cassandra workload to Amazon Keyspaces, while keeping your Cassandra source databases completely functional during the migration process. After the replication is complete, you can choose to cut over your applications to Amazon Keyspaces with minimal replication lag (less than minutes) between the Cassandra cluster and Amazon Keyspaces.

To maintain data consistency, you can also use a similar pipeline to replicate the data back to the Cassandra cluster from Amazon Keyspaces.

## Write unit calculations

As an example, consider that you intend to write 500,000,000 with the row size 1 KiB during one hour. The total number of Amazon Keyspaces write units (WCUs) that you require is based on this calculation:

$$\begin{aligned} &(\text{number of rows}/60 \text{ mins } 60\text{s}) \text{ 1 WCU per row} = (500,000,000/(60*60\text{s}) * 1 \text{ WCU}) \\ &= 69,444 \text{ WCUs required} \end{aligned}$$

69,444 WCUs per second is the rate for 1 hour, but you could add some cushion for overhead. For example,  $69,444 * 1.10 = 76,388$  WCUs has 10 percent overhead.

## Create a keyspace by using CQL

To create a keyspace by using CQL, run the following commands:

```
CREATE KEYSPACE target_keyspace WITH replication = {'class': 'SingleRegionStrategy'}
CREATE TABLE target_keyspace.target_table ( userid uuid, level text, gameid int,
description text, nickname text, zip text, email text, updatetime text, PRIMARY KEY
(userid, level, gameid) ) WITH default_time_to_live = 0 AND CUSTOM_PROPERTIES =
{'capacity_mode':{'throughput_mode':'PROVISIONED', 'write_capacity_units':76388,
'read_capacity_units':3612 }} AND CLUSTERING ORDER BY (level ASC, gameid ASC)
```

# Migrate Oracle Business Intelligence 12c to the AWS Cloud from on-premises servers

Created by Lanre (Lan-Ray) showunmi (AWS) and Patrick Huang (AWS)

<b>Environment:</b> Production	<b>Source:</b> On-premises	<b>Target:</b> Amazon EC2, Amazon RDS, Amazon ALB, Amazon EFS
<b>R Type:</b> Replatform	<b>Workload:</b> Oracle	<b>Technologies:</b> Analytics; Databases
<b>AWS services:</b> Amazon EBS; Amazon EC2; Amazon EFS; AWS CloudFormation; Elastic Load Balancing (ELB); AWS Certificate Manager (ACM)		

## Summary

This pattern shows how to migrate [Oracle Business Intelligence Enterprise Edition 12c](#) from on-premises servers to the AWS Cloud by using AWS CloudFormation. It also describes how you can use other AWS services to implement Oracle BI 12c components that deliver high availability, security, flexibility, and the ability to dynamically scale.

For a list of best practices related to migrating Oracle BI 12c to the AWS Cloud, see the **Additional information** section of this pattern.

**Note:** It's a best practice to run multiple test migrations before transferring your existing Oracle BI 12c data to the cloud. These tests help you fine tune your migration approach, identify and fix potential issues, and estimate downtime requirements more accurately.

## Prerequisites and limitations

### Prerequisites

- An active AWS account

- Secure network connectivity between your on-premises servers and AWS through either [AWS Virtual Private Network \(AWS VPN\)](#) services or [AWS Direct Connect](#)
- Software licenses for your Oracle operating system, Oracle BI 12c, Oracle Database, Oracle WebLogic Server, and Oracle HTTP Server

## Limitations

For information about storage size limits, see the [Amazon Relational Database Service \(Amazon RDS\) for Oracle](#) documentation.

## Product versions

- Oracle Business Intelligence Enterprise Edition 12c
- Oracle WebLogic Server 12c
- Oracle HTTP Server 12c
- Oracle Database 12c (or newer)
- Oracle Java SE 8

## Architecture

The following diagram shows an example architecture for running Oracle BI 12c components in the AWS Cloud:

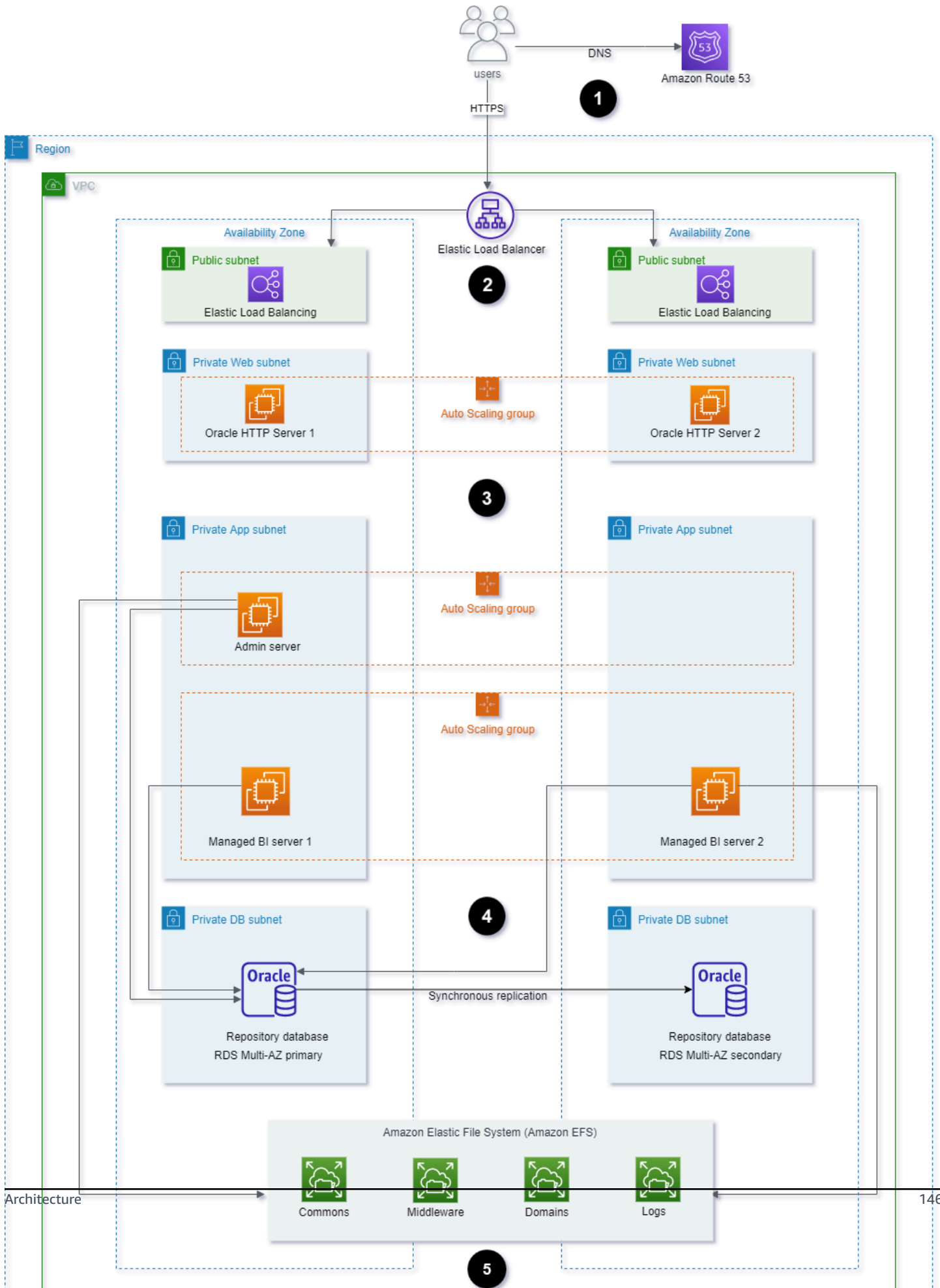

This diagram shows the following architecture:

1. Amazon Route 53 provides domain name service (DNS) configuration.
2. Elastic Load Balancing (ELB) distributes network traffic to improve the scalability and availability of the Oracle BI 12c components across multiple Availability Zones.
3. Amazon Elastic Compute Cloud (Amazon EC2) Auto Scaling groups host the Oracle HTTP Servers, Weblogic Admin server, and managed BI servers across multiple Availability Zones.
4. Amazon Relational Database Service (Amazon RDS) for Oracle database store BI Server metadata across multiple Availability Zones.
5. Amazon Elastic File System (Amazon EFS) is mounted to every Oracle BI 12c component for shared file storage.

## Technology stack

- Amazon Elastic Block Store (Amazon EBS)
- Amazon Elastic Compute Cloud (Amazon EC2)
- Amazon Elastic File System (Amazon EFS)
- Amazon RDS for Oracle
- AWS Certificate Manager (ACM)
- Elastic Load Balancing (ELB)
- Oracle BI 12c
- Oracle WebLogic Server 12c
- Oracle HTTP Server (OHS)

## Tools

- [AWS CloudFormation](#) helps you set up AWS resources, provision them quickly and consistently, and manage them throughout their lifecycle across AWS accounts and Regions.
- [AWS Certificate Manager \(ACM\)](#) helps you create, store, and renew public and private SSL/TLS X.509 certificates and keys that protect your AWS websites and applications.
- [AWS Database Migration Service \(AWS DMS\)](#) helps you migrate data stores into the AWS Cloud or between combinations of cloud and on-premises setups.



- [Amazon Elastic Compute Cloud \(Amazon EC2\)](#) provides scalable computing capacity in the AWS Cloud. You can launch as many virtual servers as you need, and quickly scale them up or down.
- [Amazon EC2 Auto Scaling](#) helps you maintain application availability and allows you to automatically add or remove Amazon EC2 instances according to conditions you define.
- [Amazon Elastic File System \(Amazon EFS\)](#) helps you create and configure shared file systems in the AWS Cloud.
- [Elastic Load Balancing](#) distributes incoming application or network traffic across multiple targets. For example, you can distribute traffic across Amazon Elastic Compute Cloud (Amazon EC2) instances, containers, and IP addresses in one or more Availability Zones.
- [Amazon Relational Database Service \(Amazon RDS\)](#) helps you set up, operate, and scale a relational database in the AWS Cloud.
- [Amazon Simple Storage Service \(Amazon S3\)](#) is a cloud-based object storage service that helps you store, protect, and retrieve any amount of data.
- [Amazon Virtual Private Cloud \(Amazon VPC\)](#) helps you launch AWS resources into a virtual network that you've defined. This virtual network resembles a traditional network that you'd operate in your own data center, with the benefits of using the scalable infrastructure of AWS.
- [Oracle Data Pump](#) helps you move data and metadata from one database to another at high speeds.
- [Oracle Fusion Middleware](#) is a suite of application development tools and integration solutions to identity management, collaboration, and business intelligence reporting.
- [Oracle GoldenGate](#) helps you design, run, orchestrate, and monitor your data replication and stream data processing solutions in the Oracle Cloud Infrastructure.
- [Oracle WebLogic Scripting Tool \(WLST\)](#) provides a command line interface that helps you horizontally scale out your WebLogic clusters.

## Epics

### Assess the source environment

Task	Description	Skills required
Gather software inventory information.	Identify versions and patch levels for each of your source technology stack's software	Migration Architect, Solutions Architect, Application Owner, Oracle BI Administrator

Task	Description	Skills required
	<p>components, including the following:</p> <ul style="list-style-type: none"><li>• Oracle operating system</li><li>• Oracle Database</li><li>• Oracle BI 12c</li><li>• Oracle WebLogic Server</li><li>• Oracle HTTP Server</li><li>• Java</li></ul>	
Gather compute and storage inventory information.	<p>In your source environment, review current and historical utilization metrics for the following:</p> <ul style="list-style-type: none"><li>• CPU usage</li><li>• Memory usage</li><li>• Storage usage</li></ul> <p><b>Important:</b> Make sure that you account for historical spikes in usage.</p>	Migration Architect, Solutions Architect, Application Owner, Oracle BI Administrator, System Administrator

Task	Description	Skills required
Gather information about the source environment's architecture and its requirements.	<p>Obtain a full understanding of your source environment's architecture and its requirements, including knowledge of the following:</p> <ul style="list-style-type: none"> <li>• Oracle WebLogic Server domain configuration</li> <li>• Clustering</li> <li>• Load balancing</li> <li>• Connectivity</li> <li>• Availability</li> <li>• Disaster recovery requirements</li> </ul>	Migration Architect, Solutions Architect, Application Owner, Oracle BI Administrator
Identify Java Database Connectivity (JDBC) data sources.	Gather information about your source environment's JDBC data sources and drivers for each database engine that it uses.	Migration Architect, Application Owner, Oracle BI Administrator, Database Engineer or Administrator
Gather information about environment-specific settings.	<p>Collect information about settings and configurations that are specific to your source environment, including the following:</p> <ul style="list-style-type: none"> <li>• Custom startup and shutdown scripts</li> <li>• Java and other environment variables</li> <li>• Certificates</li> </ul>	Migration Architect, Solutions Architect, Application Owner, Oracle BI Administrator

Task	Description	Skills required
Identify any dependencies on other applications.	<p>Collect information about integrations in your source environment that create dependencies with other applications.</p> <p><b>Important:</b> Make sure that you identify any Lightweight Directory Access Protocol (LDAP) integrations and other networking requirements.</p>	Migration Architect, Solutions Architect, Application Owner, Oracle BI Administrator

## Design your target environment

Task	Description	Skills required
Create a high-level design document.	Create a target architecture design document. Make sure that you use the information that you collected when assessing your source environment to inform the design document.	Solutions Architect, Application Architect, Database Engineer, Migration Architect
Obtain approval for the design document.	Review the design document with stakeholders and obtain the required approvals.	Application or Service Owner, Solutions Architect, Application Architect

## Deploy the infrastructure

Task	Description	Skills required
<p>Prepare the infrastructure code in CloudFormation.</p>	<p>Create CloudFormation templates to provision your Oracle BI 12c infrastructure in the AWS Cloud.</p> <p>For more information, see <a href="#">Working with AWS CloudFormation templates</a> in the <i>AWS CloudFormation User Guide</i>.</p> <p><b>Note:</b> It's a best practice to create modular CloudFormation templates for each Oracle BI 12c tier, rather than one large template for all of your resources. For more information about CloudFormation best practices, see <a href="#">8 best practices when automating your deployments with AWS CloudFormation</a> on the AWS Blog.</p>	<p>Cloud Infrastructure Architect, Solutions Architect, Application Architect</p>
<p>Download the required software.</p>	<p>Download the following software along with the required versions and patches from the <a href="#">Oracle website</a>:</p> <ul style="list-style-type: none"> <li>• Java JDK8</li> <li>• Oracle WebLogic Server 12c</li> <li>• Oracle BI 12c</li> </ul>	<p>Migration Architect, Database Engineer, Application Architect</p>

Task	Description	Skills required
Prepare the installation scripts.	<p>Create software installation scripts that run a silent install. These scripts simplify the deployment automation.</p> <p>For more information, see <a href="#">OBIEE 12c: How to Perform Silent Installation?</a> on the Oracle Support site. You need an Oracle Support account to view the documentation.</p>	Migration Architect, Database Engineer, Application Architect
Create an Amazon EBS-backed Linux AMI for your web and application tiers.	<ol style="list-style-type: none"> <li>1. <a href="#">Deploy and configure Amazon EC2 instances</a> for your web and application tiers. Make sure that the instances meet the prerequisites for running the following: <ul style="list-style-type: none"> <li>• Oracle operating system environment setup</li> <li>• Oracle operating system user account set up</li> <li>• Java software installation</li> </ul> </li> <li>2. Create Amazon Machine Images (AMIs) of the instances and save copies for future use. For instructions, see <a href="#">Create an Amazon EBS-backed Linux AMI</a> in the <i>Amazon EC2 User Guide for Linux Instances</i>.</li> </ol>	Migration Architect, Database Engineer, Application Architect

Task	Description	Skills required
Launch your AWS infrastructure by using CloudFormation.	<p>Deploy your Oracle BI 12c web and application tiers in modules by using the CloudFormation templates that you created.</p> <p>For instructions, see <a href="#">Getting started with AWS CloudFormation</a> in the <i>AWS CloudFormation User Guide</i>.</p>	Cloud Infrastructure Architect, Solutions Architect, Application Architect

### Migrate Oracle BI 12c to AWS by using a fresh installation

Task	Description	Skills required
Stage the required software.	Stage the required software in a location that is accessible to the Amazon EC2 instances. For example, you could stage the software in Amazon S3 or another Amazon EC2 instance that would be accessible to your web and application servers.	Migration Architect, Oracle BI Architect, Cloud Infrastructure Architect, Solutions Architect, Application Architect
Prepare your repository database for Oracle BI 12c installation.	Create Oracle BI 12c schemas by running the <a href="#">Oracle Repository Creation Utility (RCU)</a> against a new <a href="#">Amazon RDS for Oracle</a> database instance.	Cloud Infrastructure Architect, Solutions Architect, Application Architect, Migration Architect, Oracle BI Architect
Install Oracle Fusion Middleware 12c and Oracle BI 12c.	1. Starting with one Amazon EC2 instance, install Oracle Fusion Middleware 12c	Migration Architect, Oracle BI Architect

Task	Description	Skills required
	<p>infrastructure and OBIEE 12c. For more information, see the following sections of the <i>Oracle Fusion Middleware Enterprise Deployment Guide for Oracle Business Intelligence</i>:</p> <ul style="list-style-type: none"><li>• <a href="#">Starting the infrastructure installer on BIHOST1</a></li><li>• <a href="#">Installing Oracle Business Intelligence in preparation for an enterprise deployment</a></li></ul> <p><b>Note:</b> Use Amazon EFS to host directories that will be shared among Oracle BI 12c cluster nodes.</p> <ol style="list-style-type: none"><li>2. Apply any required patches to the installation.</li><li>3. Create AMIs of the instances and save copies for future use.</li></ol>	



Task	Description	Skills required
Configure your Oracle WebLogic Server domain for Oracle BI 12c.	<p>Configure your Oracle BI 12c domain as a non-clustered deployment.</p> <p>For more information, see <a href="#">Configuring the BI Domain</a> in the <i>Oracle Fusion Middleware Enterprise Deployment Guide for Oracle Business Intelligence</i>.</p>	Migration Architect, Oracle BI Architect
Perform horizontal scale out of the Oracle BI 12c.	<p>Horizontally scale out the single node to the desired number of nodes.</p> <p>For more information, see <a href="#">Scaling out Oracle Business Intelligence</a> in the <i>Oracle Fusion Middleware Enterprise Deployment Guide for Oracle Business Intelligence</i>.</p>	Migration Architect, Oracle BI Architect
Install Oracle HTTP Server 12c.	<ol style="list-style-type: none"> <li>1. Install Oracle HTTP Server 12c on the Oracle web tier Amazon EC2 instances. For instructions see <a href="#">Install Oracle HTTP Server 12c</a> in <i>Install and configure Oracle HTTP Server for Oracle Access Management 12c</i>.</li> <li>2. Apply any required patches to the installation.</li> <li>3. Create AMIs of the instances and save copies for future use.</li> </ol>	Migration Architect, Oracle BI Architect

Task	Description	Skills required
Configure load balancers for SSL termination.	<ol style="list-style-type: none"><li>1. Create or <a href="#">import SSL certificates in ACM</a>.</li><li>2. <a href="#">Associate the SSL certificates with ELB</a>.</li></ol>	Cloud Infrastructure Architect , Migration Architect
Migrate business intelligence metadata artifacts to AWS.	<ol style="list-style-type: none"><li>1. Export Oracle Business Intelligence Application Archive (BAR) files from the on-premises Oracle BI 12c installation. To export the BAR files, use the <a href="#">WebLogic Scripting Tool (WLST)</a> to run the <code>exportServiceInstance</code> command.</li><li>2. Import the on-premises BAR files into the AWS Oracle BI 12c installation. To import the BAR files, run the <code>importServiceInstance</code> WLST command.</li></ol>	Migration Architect, Oracle BI Architect

Task	Description	Skills required
Perform post-migration tasks.	<p>After importing the BAR files, do the following:</p> <ul style="list-style-type: none"> <li>• Configure any additional <a href="#">JDBC data sources</a>.</li> <li>• Install drivers for other data sources like PostgreSQL, or Amazon Redshift.</li> <li>• Configure Oracle <a href="#">LDAP</a>, <a href="#">SSL</a>, <a href="#">single sign-on (SSO)</a>, and <a href="#">WebLogic security store</a>.</li> <li>• Configure AWS Identity and Access Management (IAM) policies.</li> <li>• Activate usage tracking.</li> <li>• Set up integrations to other systems.</li> <li>• Migrate any custom scripts.</li> </ul>	Migration Architect, Oracle BI Architect

## Test the new environment

Task	Description	Skills required
Test the new Oracle BI 12c environment.	<p>Conduct end-to-end testing on the new Oracle BI 12c environment. Use automation as much as possible.</p> <p>Example of testing activities include the following:</p> <ul style="list-style-type: none"> <li>• Validating dashboards, reports, and URLs</li> </ul>	Migration Architect, Solutions Architect, Application Owner, Oracle BI Administrator

Task	Description	Skills required
	<ul style="list-style-type: none"> <li>User acceptance testing (UAT)</li> <li>Operational acceptance testing (OAT)</li> </ul> <p><b>Note:</b> Conduct additional testing and validation as required.</p>	

### Cut over to the new environment

Task	Description	Skills required
Disconnect traffic to the on-premises Oracle BI 12c environment.	At the appointed cutover window, stop all traffic to the on-premises Oracle BI 12c environment.	Migration Architect, Solutions Architect, Application Owner, Oracle BI Administrator
Resynchronize the new Oracle BI 12c repository database with the source database.	Resynchronize the Amazon RDS Oracle BI 12c repository database with the on-premises database.  To synchronize the databases, you can either use an <a href="#">Oracle Data Pump refresh</a> or an <a href="#">AWS DMS change data capture (CDC)</a> .	Oracle BI Administrator, Database Engineer/Administrator
Switch your Oracle BI 12c URLs to point to the new AWS environment.	Update the Oracle BI 12c URLs on your internal DNS servers so that they point to the new AWS installation.	Migration Architect, Solutions Architect, Application Owner, Oracle BI Administrator

Task	Description	Skills required
Monitor the new environment.	Monitor the new Oracle BI 12c environment by using any of the following tools: <ul style="list-style-type: none"> <li>• <a href="#">Amazon CloudWatch</a></li> <li>• <a href="#">Amazon RDS Performance Insights</a></li> <li>• <a href="#">Oracle Enterprise Manager</a></li> </ul>	Oracle BI Administrator, Database Engineer/Administrator, Application Administrator
Get sign-off on the project.	Review the testing results with stakeholders and obtain the required approvals to wrap up the migration.	Application Owner, Service Owner, Cloud Infrastructure Architect, Migration Architect, Oracle BI Architect

## Related resources

- [Using the Oracle Repository Creation Utility on RDS for Oracle](#) (*Amazon RDS User Guide*)
- [Oracle on Amazon RDS](#) (*Amazon RDS User Guide*)
- [Oracle WebLogic Server 12c on AWS](#) (AWS whitepaper)
- [Deploying Oracle Business Intelligence for high availability](#) (Oracle Help Center)
- [Oracle Business Intelligence Application Archive \(BAR\) Files](#) (Oracle Help Center)
- [How to migrate OBI 12c between environments](#) (Oracle Support)

## Additional information

The following is a list of best practices related to migrating Oracle BI 12c to the AWS Cloud.

### Repository databases

It's a best practice to host Oracle BI 12c database schemas on an Amazon RDS for Oracle instance. This instance type provides cost-efficient and resizable capacity while automating administration tasks, such as hardware provisioning, database setup, patching, and backups.

For more information, see [Using the Oracle Repository Creation Utility on RDS for Oracle](#) in the *Amazon RDS User Guide*.

## Web and application tiers

[Memory optimized Amazon EC2 instances](#) are often well suited for Oracle BI 12c servers. Whatever instance type you choose, make sure that the instances that you provision meet your system's memory usage requirements. Also, make sure that you [configure a sufficient WebLogic Java Virtual Machine \(JVM\) heap size](#) based on your Amazon EC2 instance's available memory.

## Local storage

I/O plays an important part in the overall performance of your Oracle BI 12c application. Amazon Elastic Block Store (Amazon EBS) offers different storage classes that are optimized for different workload patterns. Make sure that you choose an Amazon EBS volume type that fits your use case.

For more information about EBS volume types, see [Amazon EBS features](#) in the Amazon EBS documentation.

## Shared storage

A clustered Oracle BI 12c domain requires shared storage for the following resources:

- Configuration files
- Oracle BI 12c singleton data directory (SDD)
- Oracle global cache
- Oracle BI Scheduler scripts
- Oracle WebLogic Server binaries

You can meet this shared storage requirement by using [Amazon EFS](#), which provides a scalable, fully managed elastic Network File System (NFS) file system.

### *Fine tuning shared storage performance*

Amazon EFS has two [throughput modes](#): **Provisioned** and **Bursting**. The service also has two [performance modes](#): **General Purpose** and **Max I/O**.

To fine tune performance, start by testing your workloads in the **General Purpose** performance mode and **Provisioned** throughput mode. Doing these tests will help you determine if those baseline modes are sufficient to meet your desired service levels.

For more information, see [Amazon EFS performance](#) in the *Amazon EFS User Guide*.

## Availability and disaster recovery

It's a best practice to deploy Oracle BI 12c components across multiple Availability Zones to protect those resources in the event of an Availability Zone failure. The following is a list of availability and disaster recovery best practices for specific Oracle BI 12c resources hosted in the AWS Cloud:

- **Oracle BI 12c repository databases:** Deploy a multi-AZ Amazon RDS database instance to your Oracle BI 12c repository database. In a multi-AZ deployment, Amazon RDS automatically provisions and maintains a synchronous standby replica in a different AZ. Running an Oracle BI 12c repository database instance across Availability Zones can enhance availability during planned system maintenance and help protect your databases against instance and Availability Zone failures.
- **Oracle BI 12c Managed Servers:** To achieve fault tolerance, it's a best practice to deploy Oracle BI 12c system components on Managed Servers in an Amazon EC2 Auto Scaling Group configured to span multiple Availability Zones. Auto Scaling replaces faulty instances based on [Amazon EC2 health checks](#). In the event of an Availability Zone failure, Oracle HTTP Servers continue to direct traffic to Managed Servers in the functioning Availability Zone. Then, Auto Scaling launches instances to keep up with your host count requirements. Activating HTTP session state replication is recommended to help make sure that there's a smooth failover of the existing sessions to the functioning Managed Servers.
- **Oracle BI 12c Administration Servers:** To make sure that your Administration Server has high availability, host it in an Amazon EC2 Auto Scaling group configured to span multiple Availability Zones. Then, set the minimum and maximum size of the group set to **1**. If an Availability Zone failure occurs, Amazon EC2 Auto Scaling starts up a replacement Administration Server in an alternate Availability Zone. To recover any failed underlying hosts within the same Availability Zone, you can activate [Amazon EC2 Auto Recovery](#).
- **Oracle Web Tier servers:** It's a best practice to associate your Oracle HTTP Server with your Oracle WebLogic Server domain. For high availability, deploy your Oracle HTTP Server in an Amazon EC2 Auto Scaling group configured to span multiple Availability Zones. Then, place the server behind an ELB elastic load balancer. To provide additional protection against host failure, you can activate Amazon EC2 Auto Recovery.

## Scalability

The elasticity of the AWS Cloud helps you scale applications either horizontally or vertically in response to workload requirements.

### *Vertical scaling*

To vertically scale your application, you can change the size and type of the Amazon EC2 instances that are running your Oracle BI 12c components. You don't need to over-provision instances at the start of your deployment and incur unnecessary cost.

### *Horizontal scaling*

Amazon EC2 Auto Scaling helps you horizontally scale your application by automatically adding or removing Managed Servers based on workload requirements.

**Note:** Horizontal scaling with Amazon EC2 Auto Scaling requires scripting skills and thorough testing to implement.

## **Backup and recovery**

The following is a list of backup and recovery best practices for specific Oracle BI 12c resources hosted in the AWS Cloud:

- **Oracle Business Intelligence metadata repositories:** Amazon RDS automatically creates and saves backups of your database instances. These backups are retained for a period of time that you specify. Make sure that you configure your Amazon RDS backup duration and retention settings based on your data protection requirements. For more information, see [Amazon RDS backup and restore](#).
- **Managed Servers, Administration Servers, and Web Tier servers:** Make sure that you configure [Amazon EBS snapshots](#) based on your data protection and retention requirements.
- **Shared storage:** You can manage backup and recovery for files stored in Amazon EFS by using [AWS Backup](#). The AWS Backup service can also be deployed to centrally manage backup and recovery of other services, including Amazon EC2, Amazon EBS, and Amazon RDS. For more information, see [What is AWS Backup?](#) In the *AWS Backup Developer Guide*.

## **Security and compliance**

The following is a list of security best practices and AWS services that can help you protect your Oracle BI 12c applications in the AWS Cloud:



- **Encryption at rest:** Amazon RDS, Amazon EFS, and Amazon EBS all support industry standard encryption algorithms. You can use [AWS Key Management Service \(AWS KMS\)](#) to create and manage cryptographic keys and control their use across AWS services and in your applications. You can also configure [Oracle Transparent Data Encryption \(TDE\)](#) on the Amazon RDS for Oracle database instance that's hosting your Oracle BI 12c repository database.
- **Encryption in transit:** It's a best practice to activate either SSL or TLS protocols to protect data in transit between the various layers of your Oracle BI 12c installation. You can use [AWS Certificate Manager \(ACM\)](#) to provision, manage, and deploy public and private SSL and TLS certificates for your Oracle BI 12c resources.
- **Network security:** Make sure that you deploy your Oracle BI 12c resources in an Amazon VPC that has the appropriate access controls configured for your use case. Configure your security groups to filter inbound and outbound traffic from the Amazon EC2 instances that are running your installation. Also, make sure that you configure [Network Access Control Lists \(NACLs\)](#) that allow or deny traffic based on defined rules.
- **Monitoring and logging:** You can use [AWS CloudTrail](#) to track API calls to your AWS infrastructure, including your Oracle BI 12c resources. This functionality is useful when tracking changes to infrastructure or when conducting a security analysis. You can also use [Amazon CloudWatch](#) to view operational data that can provide you with actionable insight into the performance and health of your Oracle BI 12c application. You can configure alarms and take automated actions based on those alarms, too. Amazon RDS provides additional monitoring tools, including [Enhanced Monitoring](#) and [Performance Insights](#).

# Migrate an on-premises Apache Kafka cluster to Amazon MSK by using MirrorMaker

Created by Han Zhang (AWS) and Tanner Pratt (AWS)

<b>Environment:</b> PoC or pilot	<b>Source:</b> On-premises or self-managed Apache Kafka cluster	<b>Target:</b> Amazon Managed Streaming for Apache Kafka (Amazon MSK)
<b>R Type:</b> Replatform	<b>Workload:</b> Open-source; All other workloads	<b>Technologies:</b> Analytics; Big data; Migration
<b>AWS services:</b> Amazon MSK		

## Summary

This pattern provides guidance for migrating an on-premises, self-managed, or hosted Apache Kafka cluster to Amazon Managed Streaming for Apache Kafka (Amazon MSK). You can also use this pattern to migrate from one Amazon MSK cluster to another.

Apache Kafka includes the MirrorMaker feature, which replicates data between two Kafka clusters. MirrorMaker consists of a collection of *consumers*, which are part of a *consumer group*. The consumers read data from the topics in the source cluster and then pass this data to *producers*, which write the data to the target cluster.

The Amazon MSK documentation contains a [high-level overview](#) of the process to use MirrorMaker version 1.0 to migrate on-premises Kafka clusters to Amazon MSK. This pattern supplements this information by offering comprehensive, step-by-step instructions for using MirrorMaker version 2.0.

## Prerequisites and limitations

### Prerequisites

- An active AWS account
- A Kafka source cluster that is one of the following:

- In an on-premises data center
- Self-managed in the cloud
- Hosted through a partner

## Limitations

- To use MirrorMaker version 2.0, the source cluster must be operating Apache Kafka version 2.4.0 or later. For earlier versions, see the instructions in the [Amazon MSK documentation](#) in order to use MirrorMaker version 1.0.

## Product versions

- MirrorMaker version 2.0
- Apache Kafka version 2.4.0 or later. For more information about the versions of Apache Kafka that Amazon MSK supports, see [Supported Apache Kafka versions](#).

## Architecture

### Source technology stack

- On-premises or self-managed Kafka cluster

### Target technology stack

- Amazon MSK cluster

### Target architecture

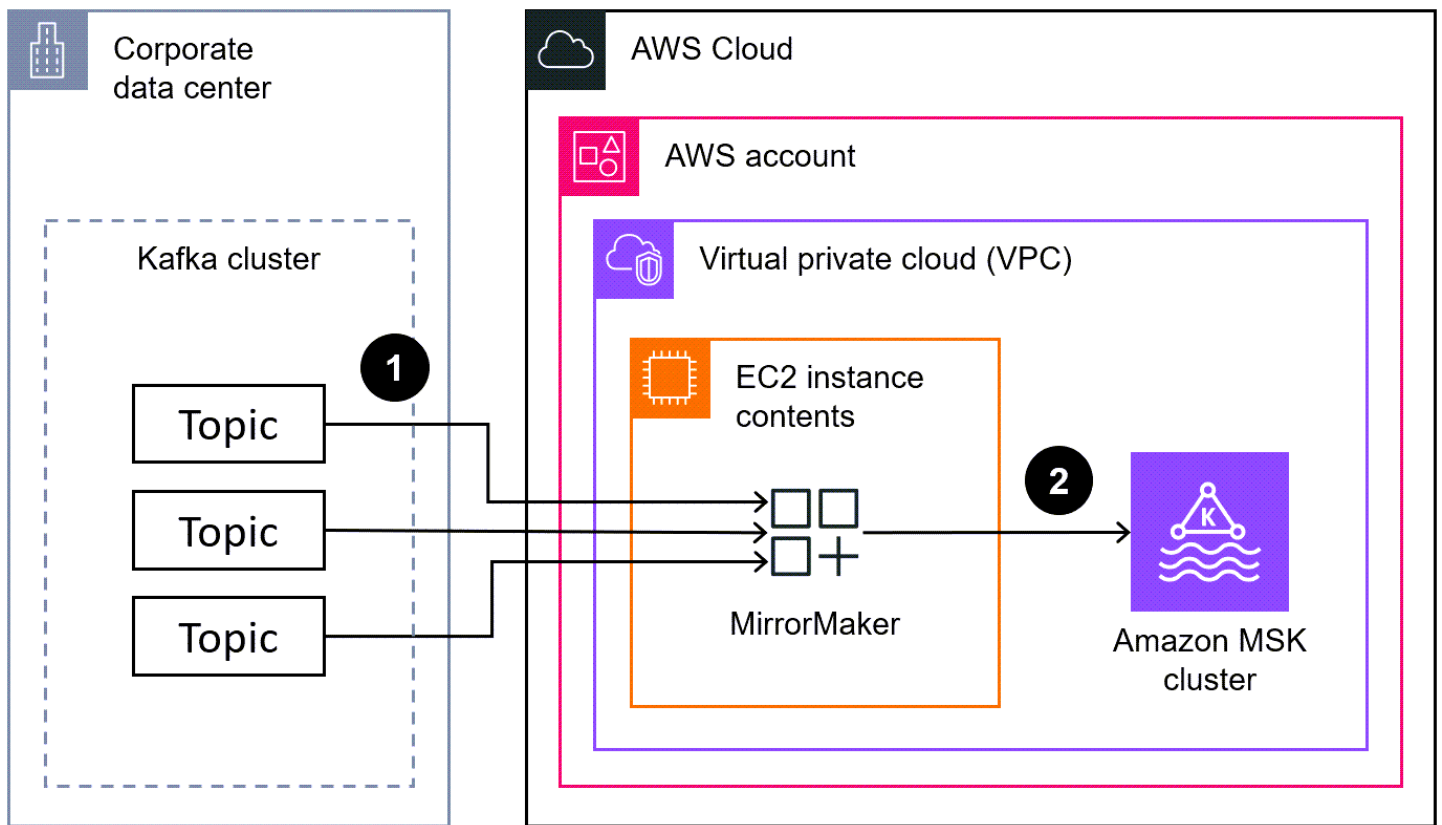

The diagram shows the following process:

1. MirrorMaker reads the data from the topics and consumer groups in the source Kafka cluster.
2. MirrorMaker replicates the data and consumer information to the target Amazon MSK cluster.

## Tools

### AWS services

- [Amazon Elastic Compute Cloud \(Amazon EC2\)](#) provides scalable computing capacity in the AWS Cloud. You can launch as many virtual servers as you need and quickly scale them up or down.
- [Amazon Managed Streaming for Apache Kafka \(Amazon MSK\)](#) is a fully managed service that helps you build and run applications that use Apache Kafka to process streaming data.
- [Amazon Virtual Private Cloud \(Amazon VPC\)](#) helps you launch AWS resources into a virtual network that you've defined. This virtual network resembles a traditional network that you'd operate in your own data center, with the benefits of using the scalable infrastructure of AWS.

### Other tools

- [Apache Kafka](#) is an open-source event streaming platform. In this pattern, you use the [MirrorMaker](#) feature of Kafka to perform the cross-cluster migration.

## Best practices

You can run MirrorMaker on in either the source or target environments, but it's recommended that you run it as close as possible to the target cluster. For more information, see [Best Practice: Consume from Remote, Produce to Local](#) in the Apache Kafka documentation.

## Epics

### Create the VPC and target Amazon MSK cluster

Task	Description	Skills required
Create a VPC.	<ol style="list-style-type: none"><li>1. Create a VPC in the target AWS account. For instructions, see <a href="#">Create a VPC</a>.</li><li>2. Create three private subnets in different Availability Zones in the new VPC. For instructions, see <a href="#">Create a subnet</a>. Using different Availability Zones provides high availability and fault tolerance.</li></ol> <p><b>Note:</b> If you are using a public internet connection to migrate the Kafka cluster, create public subnets and <a href="#">enable public access</a> to the Amazon MSK cluster.</p>	AWS systems administrator, DevOps engineer, Cloud administrator

Task	Description	Skills required
Create the Amazon MSK cluster.	Create an Amazon MSK cluster. For instructions, see <a href="#">Creating a cluster using the AWS Management Console</a> or <a href="#">Creating a cluster using the AWS CLI</a> . Configure the cluster to use the VPC and subnets that you created previously.	AWS systems administrator, DevOps engineer, Cloud administrator

## Set up MirrorMaker

Task	Description	Skills required
Install MirrorMaker.	<ol style="list-style-type: none"> <li><a href="#">Launch an EC2 instance.</a></li> <li><a href="#">Connect to your EC2 instance.</a></li> <li>On the EC2 instance, download and extract the latest Kafka release. For instructions, see <a href="#">Quick Start</a> (Kafka documentation).</li> </ol> <p><b>Note:</b> In this pattern, you install MirrorMaker 2.0 as a dedicated MirrorMaker cluster on an Amazon EC2 instance. This option is acceptable for development environments and is the approach used in this pattern. For more information about</p>	AWS systems administrator, Cloud administrator, DevOps engineer

Task	Description	Skills required
	<p>other deployment options for MirrorMaker 2.0, see the <a href="#">Additional information</a> section of this pattern.</p>	
Specify Kafka cluster information.	<p>In the Kafka client installation bin folder, create a <b>mm2.properties</b> file and configure it for your source Kafka cluster. For instructions, see <a href="#">Running a dedicated MirrorMaker cluster</a> (Kafka documentation).</p>	AWS systems administrator, Cloud administrator, DevOps engineer
Start MirrorMaker.	<p>Enter the following command to start MirrorMaker and pass the <b>mm2.properties</b> file.</p> <pre data-bbox="594 1016 1029 1178">\$ ./bin/connect-mirror-maker.sh mm2.properties</pre>	AWS systems administrator, Cloud administrator, DevOps engineer
Monitor the progress.	<p>Check the progress by inspecting the lag between the last offset for each topic and the current offset for the topic MirrorMaker is consuming. For instructions, see <a href="#">Monitoring Geo-Replication</a> in the Kafka documentation.</p>	AWS systems administrator, Cloud administrator, DevOps engineer

## Cut over

Task	Description	Skills required
Stop the consumer applications.	Stop all consumer applications that consume data from the source cluster.	App developer
Start the consumer applications.	Alter the applications bootstrap configuration to point to the destination cluster. Then begin consuming on the target cluster.	App developer
Stop the producers on the source cluster.	When the consumer applications are successfully consuming on the target cluster, stop the producers on the source cluster.	App developer
Start the producers on the target cluster.	Alter the producer's configuration bootstrap servers, and point to the target cluster. Wait for MirrorMaker to finish mirroring all data from source cluster before starting the producers.	App developer
Stop MirrorMaker.	After producers have moved to the target cluster, stop MirrorMaker.	AWS systems administrator, Cloud administrator, DevOps engineer

## Related resources

### AWS resources

- [Migrating clusters using MirrorMaker](#) (Amazon MSK documentation)



- [Amazon MSK migration labs](#) (AWS workshop studio)

### Other resources

- [MirrorMaker 2.0](#) (Apache Kafka Improvement Proposals)
- [Geo-Replication: Cross-Cluster Data Mirroring](#) (Apache Kafka documentation)

## Additional information

This pattern runs MirrorMaker 2.0 as a dedicated MirrorMaker cluster on Amazon EC2. This option is acceptable for development environments. Although it is not discussed in this pattern, you can also run MirrorMaker 2.0 in a Kafka Connect cluster. This deployment option uses a framework within the Kafka ecosystem that improves scaling and maintenance. You deploy the connector into a Kafka Connect cluster with the associated configuration to run the application. The connector can run in *standalone mode* for development or testing or in *distributed mode* for production. For more information, see [Running MirrorMaker in a Connect cluster](#) (Apache Kafka documentation). For more information about other MirrorMaker 2.0 deployment options, see [Walkthrough: Running MirrorMaker 2.0](#) (Kafka documentation).

# Migrate an ELK Stack to Elastic Cloud on AWS

Created by Battulga Purevragchaa (AWS), uday reddy, and Antony Prasad Thevaraj (AWS)

<b>Environment:</b> Production	<b>Source:</b> Elasticsearch	<b>Target:</b> Elastic Cloud
<b>R Type:</b> Replatform	<b>Workload:</b> All other workloads	<b>Technologies:</b> Analytics; Security, identity, compliance
<b>AWS services:</b> Amazon EC2; Amazon EC2 Auto Scaling; Elastic Load Balancing (ELB); Amazon S3; Amazon Route 53		

## Summary

[Elastic](#) has provided services for many years, with their users and customers typically managing Elastic themselves on premises. [Elastic Cloud](#), the managed [Elasticsearch service](#), provides a way to consume the Elastic Stack (ELK Stack) and solutions for [enterprise search](#), [observability](#), and [security](#). You can access Elastic solutions with apps such as Logs, Metrics, APM (application performance monitoring), and SIEM (security information and event management). You can use integrated features such as machine learning, index lifecycle management, Kibana Lens (for drag-and drop visualizations).

When you move from self-managed Elasticsearch to Elastic Cloud, the Elasticsearch service takes care of the following:

- Provisioning and managing the underlying infrastructure
- Creating and managing Elasticsearch clusters
- Scaling clusters up and down
- Upgrades, patching, and taking snapshots

This gives you more time to focus on solving other challenges.

This pattern defines how to migrate on-premises Elasticsearch 7.13 to Elasticsearch on Elastic Cloud on Amazon Web Services (AWS). Other versions might require slight modifications to the processes described in this pattern. For more information, contact your Elastic representative.

## Prerequisites and limitations

### Prerequisites

- An active [AWS account](#) with access to [Amazon Simple Storage Service](#) (Amazon S3) for snapshots
- A secure, sufficiently high-bandwidth [private link](#) for copying snapshot data files to Amazon S3
- [Amazon S3 Transfer Acceleration](#)
- [Elastic Snapshot policies](#) to ensure that data ingestion is archived regularly, either to a sufficiently large local data store or to remote storage (Amazon S3)

You must understand how large your snapshots and the [lifecycle policies](#) for accompanying indexes are on premises before initiating your migration. For more information, [contact Elastic](#).

### Roles and skills

The migration process also requires the roles and expertise described in the following table.

Role	Expertise	Responsibilities
App support	Familiarity with Elastic Cloud and Elastic on premises	All Elastic related tasks
Systems administrator or DBA	In-depth knowledge of the on-premises Elastic environment and its configuration	The ability to provision storage, install and use the AWS Command Line Interface (AWS CLI), and identify all data sources feeding Elastic on premises
Network administrator	Knowledge of on-premises to AWS network connectivity, security, and performance	Establishment of network links from on premises to Amazon S3, with an understanding of connectivity bandwidth

## Limitations

- Elasticsearch on Elastic Cloud is available only in [supported AWS Regions \(September 2021\)](#).

## Product versions

- Elasticsearch 7.13

## Architecture

### Source technology stack

On-premises Elasticsearch 7.13 or later:

- Cluster snapshots
- Index snapshots
- [Beats](#) configuration

### Source technology architecture

The following diagram shows a typical on-premises architecture with different ingestion methods, node types, and Kibana. The different node types reflect the Elasticsearch cluster, authentication, and visualization roles.

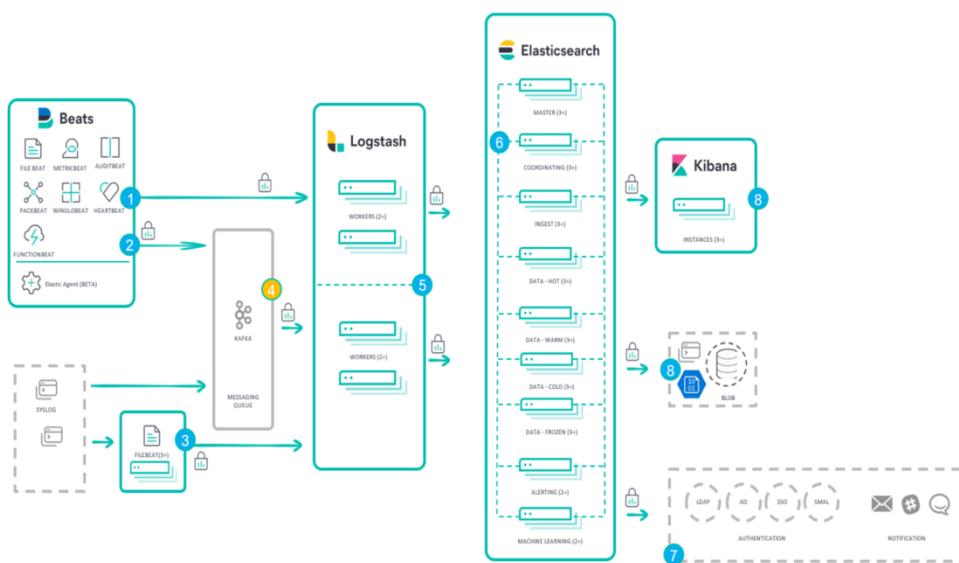

1. Ingestion from Beats to Logstash
2. Ingestion from Beats to Apache Kafka messaging queue
3. Ingestion from Filebeat to Logstash
4. Ingestion from Apache Kafka messaging queue to Logstash
5. Ingestion from Logstash to an Elasticsearch cluster
6. Elasticsearch cluster
7. Authentication and notification node
8. Kibana and blob nodes

### **Target technology stack**

Elastic Cloud is deployed to your software as a service (SaaS) account in multiple AWS Regions with cross-cluster replication.

- Cluster snapshots
- Index snapshots
- Beats configurations
- Elastic Cloud
- Network Load Balancer
- Amazon Route 53
- Amazon S3

### **Target architecture**

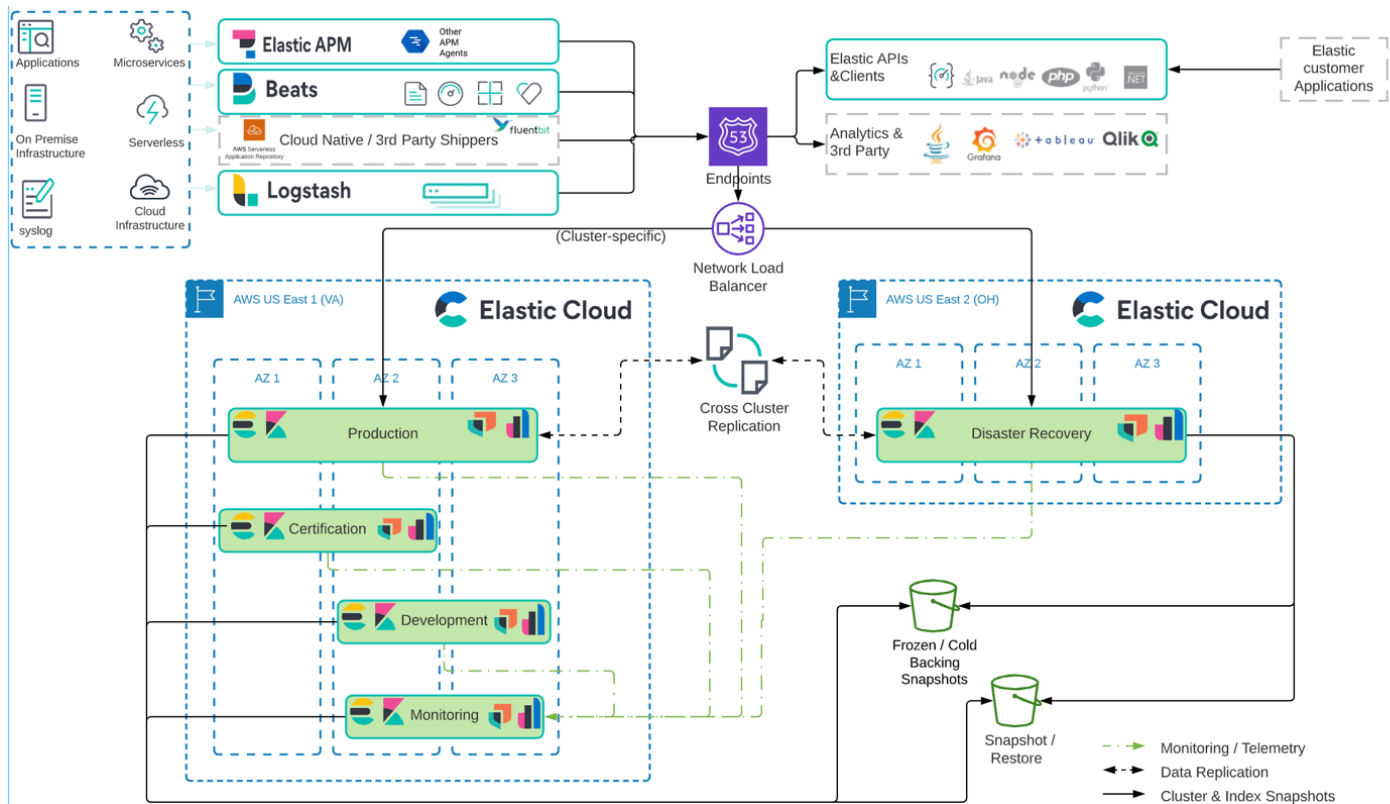

The managed Elastic Cloud infrastructure is:

- Highly available, being present in multiple [Availability Zones](#) and multiple AWS Regions.
- Region failure tolerant because data (indexes and snapshots) is replicated using Elastic Cloud [cross-cluster replication \(CCR\)](#)
- Archival, because snapshots are archived in [Amazon S3](#)
- Network partition tolerant through a combination of [Network Load Balancers](#) and [Route 53](#)
- Data ingestion originating from (but not limited to) [Elastic APM](#), [Beats](#), [Logstash](#)

## High-level migration steps

Elastic has developed its own prescriptive methodology for migrating on-premises Elastic Cluster to Elastic Cloud. The Elastic methodology is directly aligned and complementary to the AWS migration guidance and best practices, including [Well-Architected Framework](#) and [AWS Migration Acceleration Program](#) (MAP). Typically, the three AWS migration phases are the following:

- Assess
- Mobilize

- Migrate and modernize

Elastic follows similar migration phases with complementary terminology:

- Initiate
- Plan
- Implement
- Deliver
- Close

Elastic uses the Elastic Implementation Methodology to facilitate the delivery of project outcomes. This is inclusive by design to ensure that the Elastic, consulting teams, and customer teams work together with clarity to jointly deliver intended outcomes.

The Elastic methodology combines traditional waterfall phasing with Scrum within the implementation phase. Configurations of technical requirements are delivered iteratively in a collaborative manner while minimizing risk.

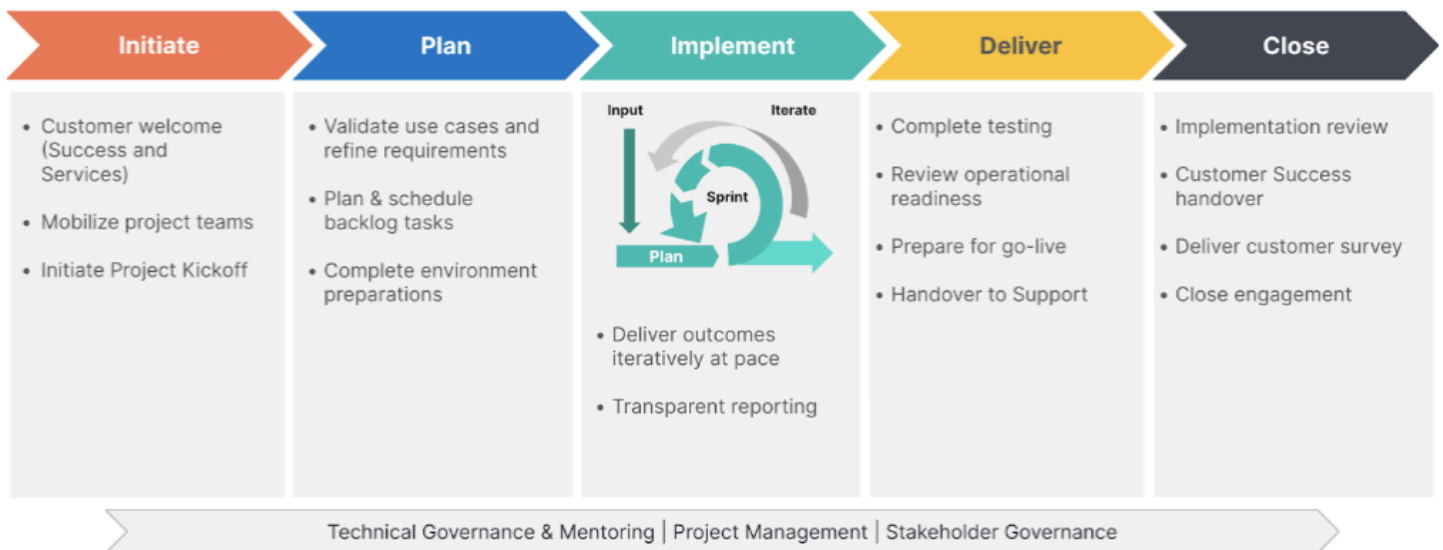

## Tools

### AWS services

- [Amazon Route 53](#) – Amazon Route 53 is a highly available and scalable Domain Name System (DNS) web service. You can use Route 53 to perform three main functions in any combination: domain registration, DNS routing, and health checking.
- [Amazon S3](#) – Amazon Simple Storage Service (Amazon S3) is an object storage service. You can use Amazon S3 to store and retrieve any amount of data at any time, from anywhere on the web. This pattern uses an S3 bucket and [Amazon S3 Transfer Acceleration](#).
- [Elastic Load Balancing](#) – Elastic Load Balancing automatically distributes your incoming traffic across multiple targets, such as EC2 instances, containers, and IP addresses, in one or more Availability Zones.

## Other tools

- [Beats](#) – Beats ship data from Logstash or Elasticsearch
- [Elastic Cloud](#) – Elastic Cloud is a managed service for hosting Elasticsearch.
- [Elasticsearch](#) – Elasticsearch is a search and analytics engine that uses the Elastic Stack to centrally store your data for search and analytics that scale. This pattern also uses snapshot creation and cross-cluster replication.
- [Logstash](#) – Logstash is a server-side data processing pipeline that ingests data from multiple sources, transforms it, and then sends it to your data storage.

## Epics

### Prepare the migration

Task	Description	Skills required
Identify servers running the on-premises Elastic solution.	Confirm that Elastic migration is supported.	App owner
Understand the on-premises server configuration.	To understand the server configuration needed to drive workloads successfully on premises, find the server hardware footprint, network configuration, and	App Support



Task	Description	Skills required
	storage characteristics that are currently in use	
Gather user and app account information.	Identify the user names and app names that are used by the on-premises Elastic environment.	Systems administrator, App support
Document Beats and data shipper configuration.	To document the configurations, look at existing data sources and sinks. For more information, see the <a href="#">Elastic documentation</a> .	App support
Determine the velocity and volume of data.	Establish a baseline for how much data the cluster is handling.	Systems administrator, App support
Document RPO and RTO scenarios.	Document recovery point objective (RPO) and recovery time objective (RTO) scenarios in terms of outages and service level agreements (SLAs).	App owner, Systems administrator, App support
Determine the optimal snapshot lifecycle settings.	Define how often data needs to be secured by using Elastic snapshots <i>during and after</i> the migration.	App owner, Systems administrator, App support
Define post-migration performance expectations.	Generate metrics on current and expected screen refresh, query runtimes, and user interface behaviors.	Systems administrator, App support

Task	Description	Skills required
Document internet access transport, bandwidth, and availability requirements.	Ascertain speed, latency, and resiliency of internet connections for copying snapshots to Amazon S3.	Network administrator
Document current costs of on-premises runtime for Elastic.	Ensure that the sizing of the AWS targeted environment is designed to be both high performing and cost effective.	DBA, Systems administrator, App support
Identify the authentication and authorization needs.	The Elastic Stack security features provide built-in realms such as Lightweight Directory Access Protocol (LDAP), Security Assertion Markup Language (SAML), and OpenID Connect (OIDC).	DBA, Systems administrator, App support
Understand the specific regulatory requirements based on the geographic location.	Ensure that data is exported and encrypted according to your requirements and to any relevant national requirements.	DBA, Systems administrator, App support

## Implement the migration

Task	Description	Skills required
Prepare the staging area on Amazon S3.	To receive snapshots on Amazon S3, <a href="#">create an S3 bucket</a> and a temporary AWS Identity and Access Management (IAM) role with full access to your newly created bucket. For more	AWS administrator

Task	Description	Skills required
	<p>information, see <a href="#">Creating a role to delegate permissions to an IAM user</a>. Use the AWS Security Token Service to <a href="#">request temporary security credentials</a>. Keep the access key ID, secret access key, and session token secured.</p> <p>Enable <a href="#">Amazon S3 Transfer Acceleration</a> on the bucket.</p>	
<p>Install AWS CLI and the Amazon S3 plugin on premises.</p>	<p>On each Elasticsearch node, run the following command.</p> <pre data-bbox="597 873 1026 1033">sudo bin/elasticsearch-plugin install repository-s3</pre> <p>Then reboot the node.</p>	<p>AWS administrator</p>
<p>Configure Amazon S3 client access.</p>	<p>Add the keys created previously by running the following commands.</p> <pre data-bbox="597 1318 1026 1478">elasticsearch-keystore add s3.client.default.access_key</pre> <pre data-bbox="597 1507 1026 1667">elasticsearch-keystore add s3.client.default.secret_key</pre> <pre data-bbox="597 1696 1026 1856">elasticsearch-keystore add s3.client.default.session_token</pre>	<p>AWS administrator</p>

Task	Description	Skills required
Register a snapshot repository for Elastic data	Use the <a href="#">Kibana Dev Tools</a> to tell the on-premises local cluster which remote S3 bucket to write to.	AWS administrator
Configure snapshot policy.	<p>To configure snapshot lifecycle management, on the Kibana <b>Policies</b> tab, choose <b>SLM policy</b>, and define which times, data streams, or indexes should be included, and what names to use.</p> <p>Configure a policy that takes frequent snapshots . Snapshots are incremental and make efficient use of storage. Match your readiness assessment decision. A policy can also specify a <a href="#">retention policy</a> and automatically delete snapshots when they are no longer needed.</p>	App support
Verify that snapshots work.	<p>In Kibana Dev Tools, run the following command.</p> <pre>GET _snapshot/&lt;your_repo_name&gt;/_all</pre>	AWS administrator, App support,
Deploy a new cluster on Elastic Cloud.	<a href="#">Log in to Elastic</a> , and choose a cluster for “observability, search or security” derived from your business findings in the readiness assessment.	AWS administrator, App support

Task	Description	Skills required
Set up cluster key store access.	The new cluster needs access to the S3 bucket that will store the snapshots. On the Elasticsearch Service Console, choose <b>Security</b> , and enter the access and secret IAM keys that you created earlier.	AWS administrator
Configure the Elastic Cloud hosted cluster to access Amazon S3.	<p>Set up new cluster access to the previously created snapshot repository in Amazon S3. Using Kibana, do the following:</p> <ol style="list-style-type: none"> <li>1. Choose <b>Stack Management, Snapshot Settings, RegisterRepo</b>.</li> <li>2. In the <b>Alias</b> field, enter the name of the repository.</li> <li>3. For <b>S3 Client name</b>, choose <b>secondary</b>.</li> <li>4. Add the S3 bucket that you created earlier to the repository.</li> <li>5. Choose <b>Compress snapshot</b>.</li> <li>6. For the <b>Encryption</b> settings, keep the default values.</li> </ol>	AWS administrator, App Support
Verify the new Amazon S3 repository.	Ensure that you can access your new repository hosted in the Elastic Cloud cluster.	AWS administrator

Task	Description	Skills required
Initilaize the Elasticsearch service cluster.	<p>On the Elasticsearch Service Console, initialize the Elasticsearch service cluster from the S3 snapshot.</p> <p>Run the following commands as POST.</p> <pre>*/_close?expand_wildcards=all</pre> <pre>/_snapshot/&lt;your-repo-name&gt;/&lt;your-snapshot-name&gt;/_restore</pre> <pre>*/_open?expand_wildcards=all</pre>	App Support

## Complete the migration

Task	Description	Skills required
Verify that the snapshot restore was successful.	<p>Using Kibana Dev Tools, run the following command.</p> <pre>GET _cat/indices</pre>	App support
Redploy ingestion services.	Connect the endpoints for Beats and Logstash to the new Elasticsearch service endpoint.	App support

## Test the cluster environment and clean up

Task	Description	Skills required
Validate the cluster environment.	After the on-premises Elastic cluster environment is migrated to AWS, you can connect to it and use your own user acceptance testing (UAT) tools to validate the new environment.	App support
Clean-up the resources.	After you validate that the cluster migrated successfully, remove the S3 bucket and the IAM role used for the migration.	AWS administrator

## Related resources

### Elastic references

- [Elastic Cloud](#)
- [Managed Elasticsearch and Kibana on AWS](#)
- [Elastic enterprise search](#)
- [Elastic integrations](#)
- [Elastic observability](#)
- [Elastic security](#)
- [Beats](#)
- [Elastic APM](#)
- [Migrate to index lifecycle management](#)
- [Elastic subscriptions](#)
- [Contact Elastic](#)

### *Elastic blog posts*

- [How to migrate from self-managed Elasticsearch to Elastic Cloud on AWS](#) (blog post)
- [Migrating to Elastic Cloud](#) (blog post)

### *Elastic documentation*

- [Tutorial: Automate backups with SLM](#)
- [ILM: Manage the index lifecycle](#)
- [Logstash](#)
- [Cross-cluster replication \(CCR\)](#)
- [Ingest pipelines](#)
- [Run Elasticsearch API requests](#)
- [Snapshot retention](#)

### *Elastic video and webinar*

- [Elastic cloud migration](#)
- [Elastic Cloud: Why are customers migrating](#) (webinar)

### **AWS references**

- [Elastic Cloud on AWS Marketplace](#)
- [AWS Command Line Interface](#)
- [AWS Direct Connect](#)
- [AWS Migration Acceleration Program](#)
- [Network Load Balancers](#)
- [Regions and Availability Zones](#)
- [Amazon Route 53](#)
- [Amazon Simple Storage Service](#)
- [Amazon S3 Transfer Acceleration](#)
- [VPN connections](#)
- [Well-Architected Framework](#)



## Additional information

If you're planning to migrate complex workloads, engage [Elastic Consulting Services](#). If you have basic questions related to configurations and services, contact the [Elastic Support](#) team.

# Migrate data to the AWS Cloud by using Starburst

Created by Antony Prasad Thevaraj (AWS), Shaun Van Staden (Starburst), and Suresh Veeragoni (AWS)

**Environment:** Production

**Technologies:** Analytics;  
Data lakes; Databases

**Workload:** All other workloads

**AWS services:** Amazon EKS

## Summary

Starburst helps accelerate your data migration journey to Amazon Web Services (AWS) by providing an enterprise query engine that brings existing data sources together in a single access point. You can run analytics across multiple data sources to get valuable insights, before finalizing any migration plans. Without disrupting business-as-usual analytics, you can migrate the data by using the Starburst engine or a dedicated extract, transform, and load (ETL) application.

## Prerequisites and limitations

### Prerequisites

- An active AWS account
- A virtual private cloud (VPC)
- An Amazon Elastic Kubernetes Service (Amazon EKS) cluster
- An Amazon Elastic Compute Cloud (Amazon EC2) Auto Scaling group
- A list of current system workloads that need to be migrated
- Network connectivity from AWS to your on-premises environment

## Architecture

### Reference architecture

The following high-level architecture diagram shows the typical deployment of Starburst Enterprise in the AWS Cloud:

1. The Starburst Enterprise cluster runs inside your AWS account.
2. A user authenticates by using Lightweight Directory Access Protocol (LDAP) or Open Authorization (OAuth) and interacts directly with the Starburst cluster.
3. Starburst can connect to several AWS data sources, such as AWS Glue, Amazon Simple Storage Service (Amazon S3), Amazon Relational Database Service (Amazon RDS), and Amazon Redshift. Starburst provides federated query capabilities across data sources in the AWS Cloud, on premises, or in other cloud environments.
4. You launch Starburst Enterprise in an Amazon EKS cluster by using Helm charts.
5. Starburst Enterprise uses Amazon EC2 Auto Scaling groups and Amazon EC2 Spot Instances to optimize infrastructure.
6. Starburst Enterprise connects directly to your existing on-premises data sources to read data real-time. In addition, if you have an existing Starburst Enterprise deployment in this environment, you can directly connect your new Starburst cluster in the AWS Cloud to this existing cluster.

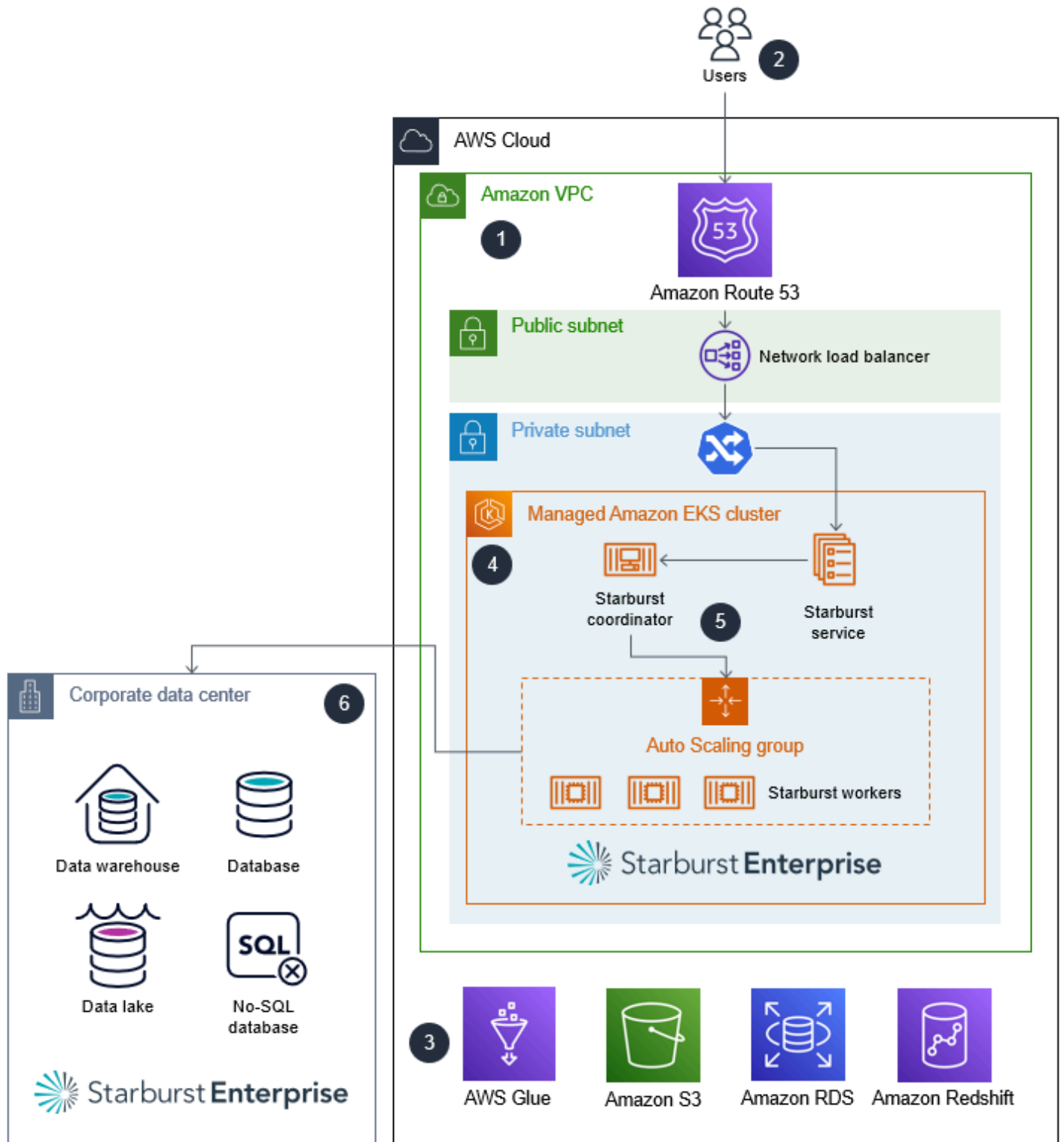

Please note the following:

- Starburst is not a data virtualization platform. It is a SQL-based massively parallel processing (MPP) query engine that forms the basis of an overall data mesh strategy for analytics.
- When Starburst is deployed as part of a migration, it has direct connectivity to the existing on-premises infrastructure.
- Starburst provides several built-in enterprise and open-source connectors that facilitate connectivity to a variety of legacy systems. For a full list of connectors and their capabilities, see [Connectors](#) in the *Starburst Enterprise user guide*.
- Starburst can query data in real-time from on-premises data sources. This prevents interruptions of regular business operations while data is being migrated.
- If you are migrating from an existing on-premises Starburst Enterprise deployment, you can use a special connector, *Starburst Stargate*, to connect your Starburst Enterprise cluster in AWS directly to your on-premises cluster. This provides additional performance benefits when business users and data analysts are federating queries from the AWS Cloud to your on-premises environment.

## High-level process overview

You can accelerate data migration projects by using Starburst because Starburst enables insights across all of your data, prior to migrating it. The following image shows the typical process for migrating data by using Starburst.

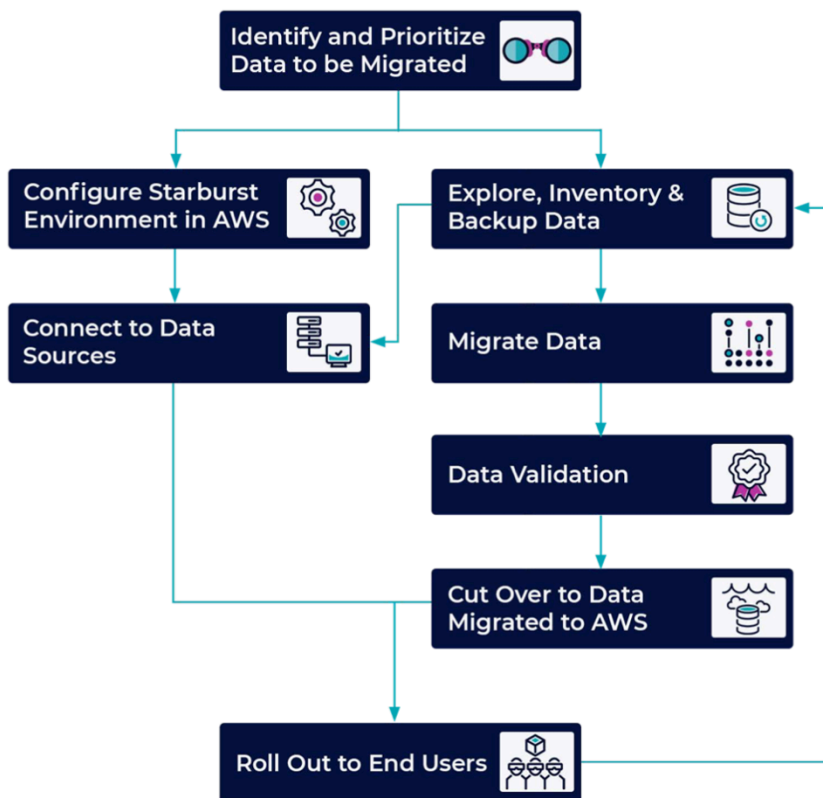

## Roles

The following roles are typically required to complete a migration using Starburst:

- **Cloud administrator** – Responsible for making cloud resources available to run the Starburst Enterprise application
- **Starburst administrator** – Responsible for installing, configuring, managing, and supporting the Starburst application
- **Data engineer**– Responsible for:
  - Migrating the legacy data to the cloud
  - Building semantic views to support analytics
- **Solution or system owner** – Responsible for the overall solution implementation

## Tools

### AWS services

- [Amazon EC2](#) – Amazon Elastic Compute Cloud (Amazon EC2) provides scalable computing capacity in the AWS Cloud.
- [Amazon EKS](#) – Amazon Elastic Kubernetes Service (Amazon EKS) is a managed service for running Kubernetes on AWS without needing to stand up or maintain your own Kubernetes control plane. Kubernetes is an open-source system for automating the deployment, scaling, and management of containerized applications.

## Other tools

- [Helm](#) – Helm is a package manager for Kubernetes that helps you install and manage applications on your Kubernetes cluster.
- [Starburst Enterprise](#) – Starburst Enterprise is a SQL-based massively parallel processing (MPP) query engine that forms the basis of an overall data mesh strategy for analytics.
- [Starburst Stargate](#) – Starburst Stargate links catalogs and data sources in one Starburst Enterprise environment, such as a cluster in an on-premises data center, to the catalogs and data sources in another Starburst Enterprise environment, such as a cluster in the AWS Cloud.

## Epics

### Assess the data

Task	Description	Skills required
Identify and prioritize your data.	Identify the data you want to move. Large, on-premises legacy systems can include core data that you want to migrate alongside data that you don't want to move or can't be moved because of compliance reasons. Starting with a data inventory helps you prioritize which data you should target first. For more information, see <a href="#">Get started</a>	Data engineer, DBA

Task	Description	Skills required
	<a href="#">with automated portfolio discovery</a> .	
Explore, inventory, and back up your data.	Validate the quality, quantity, and relevance of the data for your use case. Back up or create a snapshot of the data as needed, and finalize the target environment for the data.	Data engineer, DBA

## Set up the Starburst Enterprise environment

Task	Description	Skills required
Configure Starburst Enterprise in the AWS Cloud.	While data is being catalogued, set up Starburst Enterprise in a managed Amazon EKS cluster. For more information see, <a href="#">Deploying with Kubernetes</a> in the <i>Starburst Enterprise reference documentation</i> . This allows business-as-usual analytics while data migration is in process.	AWS administrator, App developer
Connect Starburst to the data sources.	After you have identified the data and set up Starburst Enterprise, connect Starburst to the data sources. Starburst reads data directly from the data source as a SQL query. For more information, see the	AWS administrator, App developer



Task	Description	Skills required
	<a href="#">Starburst Enterprise reference documentation.</a>	

## Migrate the data

Task	Description	Skills required
Build and run the ETL pipelines.	Begin the data migration process. This activity can occur at the same time as business-as-usual analytics . For the migration, you can use a third-party product or Starburst. Starburst has the capability to both read and write data across different sources. For more information, see the <a href="#">Starburst Enterprise reference documentation.</a>	Data engineer
Validate the data.	After the data has been migrated, validate the data to ensure all required data has been moved and is intact.	Data engineer, DevOps engineer

## Cut over and roll out

Task	Description	Skills required
Cut over the data.	After data migration and validation is complete, you can cut over the data. This involves changing the data	Data engineer, Cutover lead

Task	Description	Skills required
	<p>connection links in Starburst. Instead of pointing at the on-premises sources, you point to the new cloud sources and update the semantic views. For more information, see <a href="#">Connectors</a> in the <i>Starburst Enterprise reference documentation</i>.</p>	
Roll out to users.	Data consumers begin working off the migrated data sources. This process is invisible to the analytics end users.	Cutover lead, Data engineer

## Related resources

### AWS Marketplace

- [Starburst Galaxy](#)
- [Starburst Enterprise](#)
- [Starburst Data JumpStart](#)
- [Starburst Enterprise with Graviton](#)

### Starburst documentation

- [Starburst Enterprise user guide](#)
- [Starburst Enterprise reference documentation](#)

### Other AWS documentation

- [Get started with automated portfolio discovery](#) (AWS Prescriptive Guidance)
- [Optimizing Cloud Infrastructure Cost and Performance with Starburst on AWS](#) (blog post)



# Optimize the ETL ingestion of input file size on AWS

Created by Apoorva Patrikar (AWS)

**Environment:** PoC or pilot

**Technologies:** Analytics;  
Data lakes

**Workload:** Open-source

**AWS services:** AWS Glue;  
Amazon S3

## Summary

This pattern shows you how to optimize the ingestion step of the extract, transform, and load (ETL) process for big data and Apache Spark workloads on AWS Glue by optimizing file size before processing your data. Use this pattern to prevent or resolve the *small files problem*. That is, when a large number of small files slows down data processing due to the aggregate size of the files. For example, hundreds of files that are only a few hundred kilobytes each can significantly slow down data processing speeds for your AWS Glue jobs. This is because AWS Glue must perform internal list functions on Amazon Simple Storage Service (Amazon S3) and YARN (Yet Another Resource Negotiator) must store a large amount of metadata. To improve data processing speeds, you can use grouping to enable your ETL tasks to read a group of input files into a single in-memory partition. The partition automatically groups smaller files together. Alternatively, you can use custom code to add batch logic to your existing files.

## Prerequisites and limitations

### Prerequisites

- An active AWS account
- One or more AWS glue [jobs](#)
- One or more big data or [Apache Spark](#) workloads
- An [S3 bucket](#)

## Architecture

The following pattern shows how data in different formats is processed by an AWS Glue job and then stored in an S3 bucket to get visibility into performance.

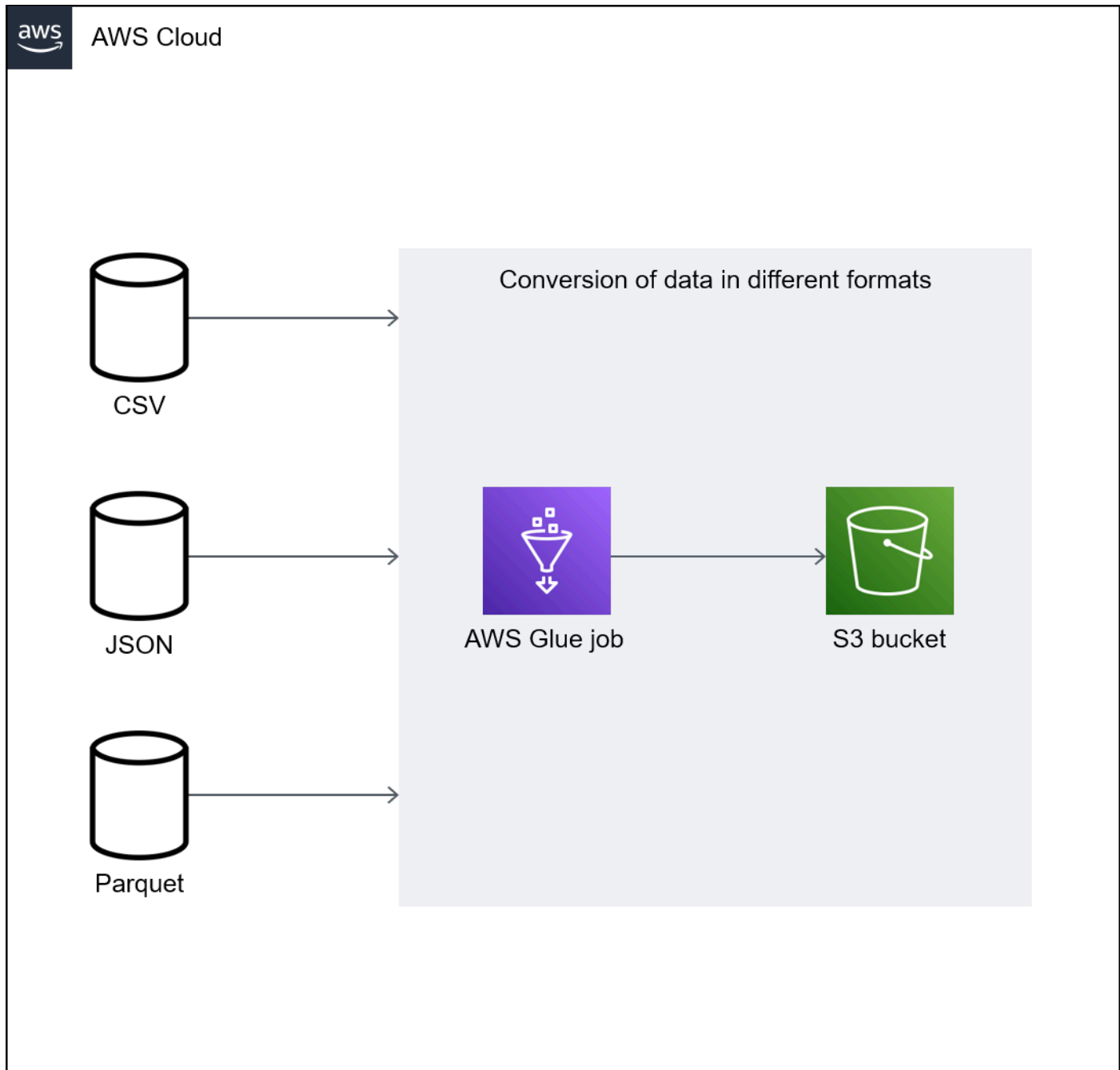

The diagram shows the following workflow:

1. An AWS Glue job converts small files in CSV, JSON, and Parquet format to dynamic frames. **Note:** The size of the input file has the most significant impact on the performance of the AWS Glue job.
2. The AWS Glue job performs internal list functions in an S3 bucket.

## Tools

- [AWS Glue](#) is a fully managed ETL service. It helps you reliably categorize, clean, enrich, and move data between data stores and data streams.
- [Amazon Simple Storage Service \(Amazon S3\)](#) is a cloud-based object storage service that helps you store, protect, and retrieve any amount of data.

## Epics

### Use grouping to optimize ETL ingestion during reading

Task	Description	Skills required
Specify the group size.	If you have more than 50,000 files, grouping is done by default. However, you can also use grouping for less than 50,000 files by specifying the group size in the <code>connectionOptions</code> parameter. The <code>connectionOptions</code> parameter is in the <code>create_dynamic_frame.from_options</code> method.	Data engineer
Write the grouping code.	Use the <code>create_dynamic_frame</code> method to create a dynamic frame. For example:	Data engineer

Task	Description	Skills required
	<pre data-bbox="609 226 998 1186"> S3bucket_node1 =   glueContext.create   _dynamic_frame.fro   m_options(     format_options={"m     ultiline": False},     connection_type="s     3",     format="json",     connection_options     ={       "paths": ["s3://       bucket/prefix/file.j       son"],       "recurse":       True,       "groupFiles":       'inPartition',       "groupSize":       1048576     },     transformation_ctx     ="S3bucket_node1",   ) </pre> <p data-bbox="592 1239 1031 1564"><b>Note:</b> Use <code>groupFiles</code> to group files in an Amazon S3 partition group. Use <code>groupSize</code> to set the target size of the group to be read in memory. Specify <code>groupSize</code> in bytes (1048576 = 1 MB).</p>	
Add the code to the workflow.	Add the grouping code to your job <a href="#">workflow</a> in AWS Glue.	Data engineer

## Use custom logic to optimize ETL ingestion

Task	Description	Skills required
Choose the language and processing platform.	Choose the scripting language and processing platform tailored to your use case.	Cloud architect
Write the code.	Write the custom logic to batch your files together.	Cloud architect
Add the code to the workflow.	Add the code to your job <a href="#">workflow</a> in AWS Glue. This enables your custom logic to be applied every time the job is run.	Data engineer

## Repartition when writing data after transformation

Task	Description	Skills required
Analyze consumption patterns.	Find out how downstream applications will use the data you write. For example, if they query data each day and you only partition data per Region or have very small output files, such as 2.5 KB per file, then this is not optimal for consumption.	DBA
Repartition data before writing.	Repartition based on joins or queries during processing (based on processing logic) and after processing (based on consumption). For	Data engineer



Task	Description	Skills required
	example, repartition based on byte size, such as <code>.repartition(100000)</code> , or repartition based on columns, such as <code>.repartition("column_name")</code> .	

## Related resources

- [Reading input files in larger groups](#)
- [Monitoring AWS Glue](#)
- [Monitoring AWS Glue using Amazon CloudWatch metrics](#)
- [Job monitoring and debugging](#)
- [Getting started with serverless ETL on AWS Glue](#)

## Additional information

### Determining file size

There is no straightforward way to determine if a file size is too big or too small. The impact of file size on processing performance depends on the configuration of your cluster. In core Hadoop, we recommend that you use files that are 128 MB or 256 MB to make the most of the block size.

For most text file workloads on AWS Glue, we recommended a file size between 100 MB and 1 GB for a 5-10 DPU cluster. To figure out the best size of input files, monitor the preprocessing section of your AWS Glue job, and then check the CPU utilization and memory utilization of the job.

### Additional considerations

If performance in the early ETL stages is a bottleneck, consider grouping or merging the data files before processing. If you have complete control on the file generation process, it can be even more efficient to aggregate data points on the source system itself before the raw data is sent to AWS.

# Orchestrate an ETL pipeline with validation, transformation, and partitioning using AWS Step Functions

Created by Sandip Gangapadhyay (AWS)

**Code repository:** [aws-step-functions-etl-pipeline-pattern](#)

**Environment:** Production

**Technologies:** Analytics; Big data; Data lakes; DevOps; Serverless

**AWS services:** Amazon Athena; AWS Glue; AWS Lambda; AWS Step Functions

## Summary

This pattern describes how to build a serverless extract, transform, and load (ETL) pipeline to validate, transform, compress, and partition a large CSV dataset for performance and cost optimization. The pipeline is orchestrated by AWS Step Functions and includes error handling, automated retry, and user notification features.

When a CSV file is uploaded to an Amazon Simple Storage Service (Amazon S3) bucket source folder, the ETL pipeline starts to run. The pipeline validates the content and the schema of the source CSV file, transforms the CSV file to a compressed Apache Parquet format, partitions the dataset by year, month, and day, and stores it in a separate folder for analytics tools to process.

The code that automates this pattern is available on GitHub, in the [ETL Pipeline with AWS Step Functions](#) repository.

## Prerequisites and limitations

### Prerequisites

- An active AWS account.
- AWS Command Line Interface (AWS CLI) installed and configured with your AWS account, so that you can create AWS resources by deploying an AWS CloudFormation stack. AWS CLI version 2 is recommended. For installation instructions, see [Installing, updating, and uninstalling the](#)

[AWS CLI version 2](#) in the AWS CLI documentation. For AWS CLI configuration instructions, see [Configuration and credential file settings](#) in the AWS CLI documentation.

- An Amazon S3 bucket.
- A CSV dataset with the correct schema. (The [code repository](#) included with this pattern provides a sample CSV file with the correct schema and data type that you can use.)
- A web browser that is supported for use with the AWS Management Console. (See the [list of supported browsers](#).)
- AWS Glue console access.
- AWS Step Functions console access.

## Limitations

- In AWS Step Functions, the maximum limit for keeping history logs is 90 days. For more information, see [Quotas](#) and [Quotas for standard workflows](#) in the AWS Step Functions documentation.

## Product versions

- Python 3.11 for AWS Lambda
- AWS Glue version 2.0

## Architecture

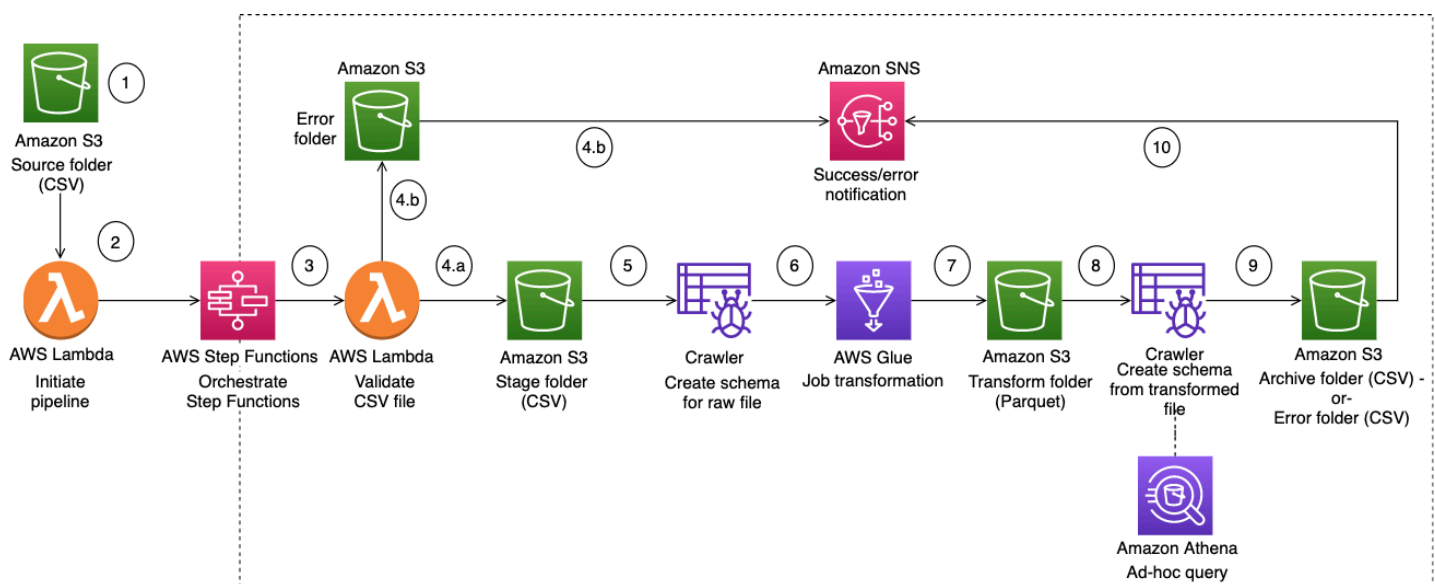

The workflow illustrated in the diagram consists of these high-level steps:

1. The user uploads a CSV file into the source folder in Amazon S3.
2. An Amazon S3 notification event initiates an AWS Lambda function that starts the Step Functions state machine.
3. The Lambda function validates the schema and data type of the raw CSV file.
4. Depending on the validation results:
  - a. If validation of the source file succeeds, the file moves to the stage folder for further processing.
  - b. If validation fails, the file moves to the error folder, and an error notification is sent through Amazon Simple Notification Service (Amazon SNS).
5. An AWS Glue crawler creates the schema of the raw file from the stage folder in Amazon S3.
6. An AWS Glue job transforms, compresses, and partitions the raw file into Parquet format.
7. The AWS Glue job also moves the file to the transform folder in Amazon S3.
8. The AWS Glue crawler creates the schema from the transformed file. The resulting schema can be used by any analytics job. You can also use Amazon Athena to run ad-hoc queries.
9. If the pipeline completes without errors, the schema file is moved to the archive folder. If any errors are encountered, the file is moved to the error folder instead.
10. Amazon SNS sends a notification that indicates success or failure based on the pipeline completion status.

All the AWS resources used in this pattern are serverless. There are no servers to manage.

## Tools

### AWS services

- [AWS Glue](#) – AWS Glue is a fully managed ETL service that makes it easy for customers to prepare and load their data for analytics.
- [AWS Step Functions](#) – AWS Step Functions is a serverless orchestration service that lets you combine AWS Lambda functions and other AWS services to build business-critical applications. Through the AWS Step Functions graphical console, you see your application's workflow as a series of event-driven steps.
- [Amazon S3](#) – Amazon Simple Storage Service (Amazon S3) is an object storage service that offers industry-leading scalability, data availability, security, and performance.

- [Amazon SNS](#) – Amazon Simple Notification Service (Amazon SNS) is a highly available, durable, secure, fully managed pub/sub messaging service that enables you to decouple microservices, distributed systems, and serverless applications.
- [AWS Lambda](#) – AWS Lambda is a compute service that lets you run code without provisioning or managing servers. AWS Lambda runs your code only when needed and scales automatically, from a few requests per day to thousands per second.

## Code

The code for this pattern is available on GitHub, in the [ETL Pipeline with AWS Step Functions](#) repository. The code repository contains the following files and folders:

- `template.yml` – AWS CloudFormation template for creating the ETL pipeline with AWS Step Functions.
- `parameter.json` – Contains all parameters and parameter values. You update this file to change parameter values, as described in the *Epics* section.
- `myLayer/python` folder – Contains Python packages needed to create the required AWS Lambda layer for this project.
- `lambda` folder – Contains the following Lambda functions:
  - `move_file.py` – Moves the source dataset to the archive, transform, or error folder.
  - `check_crawler.py` – Checks the status of the AWS Glue crawler as many times as configured by the `RETRYLIMIT` environment variable before it sends a failure message.
  - `start_crawler.py` – Starts the AWS Glue crawler.
  - `start_step_function.py` – Starts AWS Step Functions.
  - `start_codebuild.py` – Starts the AWS CodeBuild project.
  - `validation.py` – Validates the input raw dataset.
  - `s3object.py` – Creates the required directory structure inside the S3 bucket.
  - `notification.py` – Sends success or error notifications at the end of the pipeline.

To use the sample code, follow the instructions in the *Epics* section.

# Epics

## Prepare the source files

Task	Description	Skills required
Clone the sample code repository.	<ol style="list-style-type: none"><li>1. Open the <a href="#">ETL Pipeline with AWS Step Functions</a> repository.</li><li>2. Choose <b>Code</b> on the main repository page, above the file list, and copy the URL listed under <b>Clone with HTTPS</b>.</li><li>3. Change your working directory to the location where you want to store the sample files.</li><li>4. At a terminal or command prompt, type the command: <pre>git clone &lt;repoURL&gt;</pre>where &lt;repoURL&gt; refers to the URL you copied in step 2.</li></ol>	Developer
Update parameter values.	<p>In your local copy of the repository, edit the <code>parameter.json</code> file and update the default parameter values as follows:</p> <ul style="list-style-type: none"><li>• <code>pS3BucketName</code> – The name of the S3 bucket for storing the datasets. The</li></ul>	Developer

Task	Description	Skills required
	<p>template will create this bucket for you. The bucket name must be globally unique.</p> <ul style="list-style-type: none"><li>• <code>pSourceFolder</code> – The name of the folder inside the S3 bucket that will be used to upload the source CSV file.</li><li>• <code>pStageFolder</code> – The name of the folder inside the S3 bucket that will be used as the staging area during the process.</li><li>• <code>pTransformFolder</code> – The name of the folder inside the S3 bucket that will be used to store transformed and partitioned datasets.</li><li>• <code>pErrorFolder</code> – The folder inside the S3 bucket that the source CSV file will be moved to if it can't be validated.</li><li>• <code>pArchiveFolder</code> – The name of the folder inside the S3 bucket that will be used to archive the source CSV file.</li><li>• <code>pEmailforNotification</code> – A valid email</li></ul>	

Task	Description	Skills required
	<p>address for receiving success/error notifications.</p> <ul style="list-style-type: none"><li>• <code>pPrefix</code> – A prefix string that will be used in the AWS Glue crawler name.</li><li>• <code>pDatasetSchema</code> – The dataset schema that the source file will be validated against. The Cerberus Python package is used for source dataset validation. For more information, see the <a href="#">Cerberus</a> website.</li></ul>	



Task	Description	Skills required
Upload the source code to the S3 bucket.	<p>Before you deploy the CloudFormation template that automates the ETL pipeline, you must package the source files for the CloudFormation template and upload them to an S3 bucket. To do this, run the following AWS CLI command with your preconfigured profile:</p> <pre data-bbox="594 726 1029 1087">aws cloudformation   package --template-   file template.yml --s3-   bucket &lt;bucket_name&gt;   --output-template-   file packaged.template   --profile &lt;profile_   name&gt;</pre> <p>where:</p> <ul data-bbox="594 1205 1008 1776" style="list-style-type: none"><li>• <code>&lt;bucket_name&gt;</code> is the name of an existing S3 bucket in the AWS Region where you want to deploy the stack. This bucket is used to store the source code package for the CloudFormation template.</li><li>• <code>&lt;profile_name&gt;</code> is a valid AWS CLI profile that you preconfigured when you set up AWS CLI.</li></ul>	Developer

## Create the stack

Task	Description	Skills required
Deploy the CloudFormation template.	<p>To deploy the CloudFormation template, run the following AWS CLI command:</p> <pre data-bbox="594 499 1027 936">aws cloudformation   deploy --stack-name     &lt;stack_name&gt; --templat     e-file packaged.   template --parameter-     overrides file://pa     rameter.json --capabil     ities CAPABILITY_IAM     --profile &lt;profile_     name&gt;</pre> <p>where:</p> <ul data-bbox="594 1056 1016 1339" style="list-style-type: none"><li>• &lt;stack_name&gt; is a unique identifier for the CloudFormation stack.</li><li>• &lt;profile-name&gt; is your preconfigured AWS CLI profile.</li></ul>	Developer
Check progress.	<p>On the <a href="#">AWS CloudFormation console</a>, check the progress of stack development. When the status is CREATE_COMPLETE , the stack has been deployed successfully.</p>	Developer
Note the AWS Glue database name.	<p>The <b>Outputs</b> tab for the stack displays the name of the AWS</p>	Developer

Task	Description	Skills required
	Glue database. The key name is <code>GlueDBOutput</code> .	

## Test the pipeline

Task	Description	Skills required
Start the ETL pipeline.	<ol style="list-style-type: none"> <li>1. Navigate to the source folder (source, or the folder name you set in the <code>parameter.json</code> file) inside the S3 bucket.</li> <li>2. Upload a sample CSV file to this folder. (The code repository provides a sample file called <code>Sample_Bank_Transaction_Raw_Dataset.csv</code> that you can use.) Uploading the file will start the ETL pipeline through Step Functions.</li> <li>3. On the <a href="#">Step Functions console</a>, check the ETL pipeline status.</li> </ol>	Developer
Check for the partitioned dataset.	When the ETL pipeline completes, verify that the partitioned dataset is available in the Amazon S3 transform folder ( <code>transform</code> , or the folder name you set in the <code>parameter.json</code> file).	Developer

Task	Description	Skills required
Check for the partitioned AWS Glue database.	<ol style="list-style-type: none"> <li>1. On the <a href="#">AWS Glue console</a>, select the AWS Glue database created by the stack (this is the database that you noted in the previous epic).</li> <li>2. Verify that the partitioned table is available in the AWS Glue Data Catalog.</li> </ol>	Developer
Run queries.	(Optional) Use Amazon Athena to run ad-hoc queries on the partitioned and transformed database. For instructions, see <a href="#">Running SQL Queries Using Amazon Athena</a> in the AWS documentation.	Database analyst

## Troubleshooting

Issue	Solution
AWS Identity and Access Management (IAM) permissions for the AWS Glue job and crawler	If you further customize the AWS Glue job or the crawler, be sure to grant the appropriate IAM permissions in the IAM role used by the AWS Glue job, or provide data permissions to AWS Lake Formation. For more information, see the <a href="#">AWS documentation</a> .

## Related resources

### AWS service documentation

- [AWS Step Functions](#)
- [AWS Glue](#)
- [AWS Lambda](#)
- [Amazon S3](#)
- [Amazon SNS](#)

## Additional information

The following diagram shows the AWS Step Functions workflow for a successful ETL pipeline, from the Step Functions **Inspector** panel.

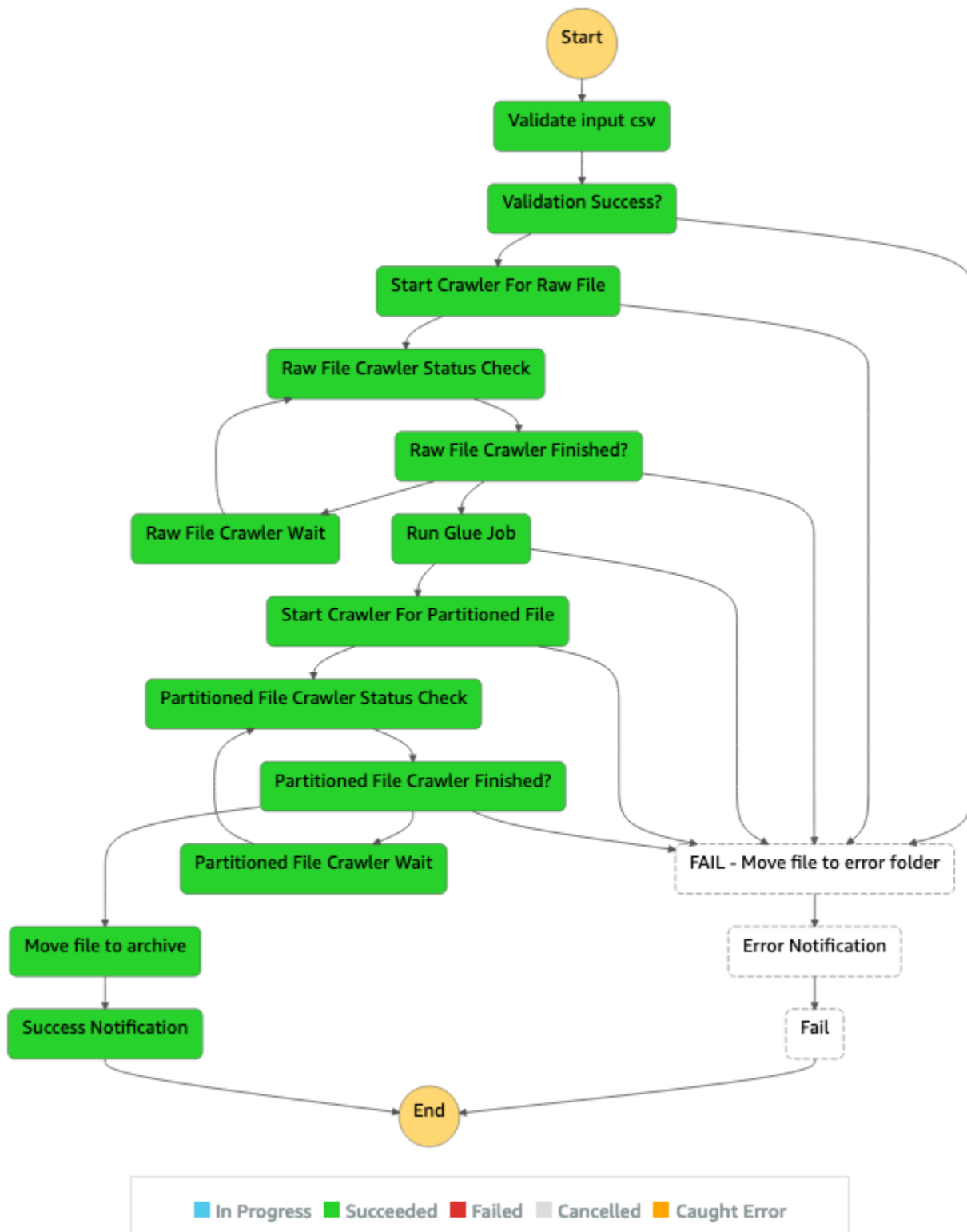

The following diagram shows the AWS Step Functions workflow for an ETL pipeline that fails because of an input validation error, from the Step Functions **Inspector** panel.

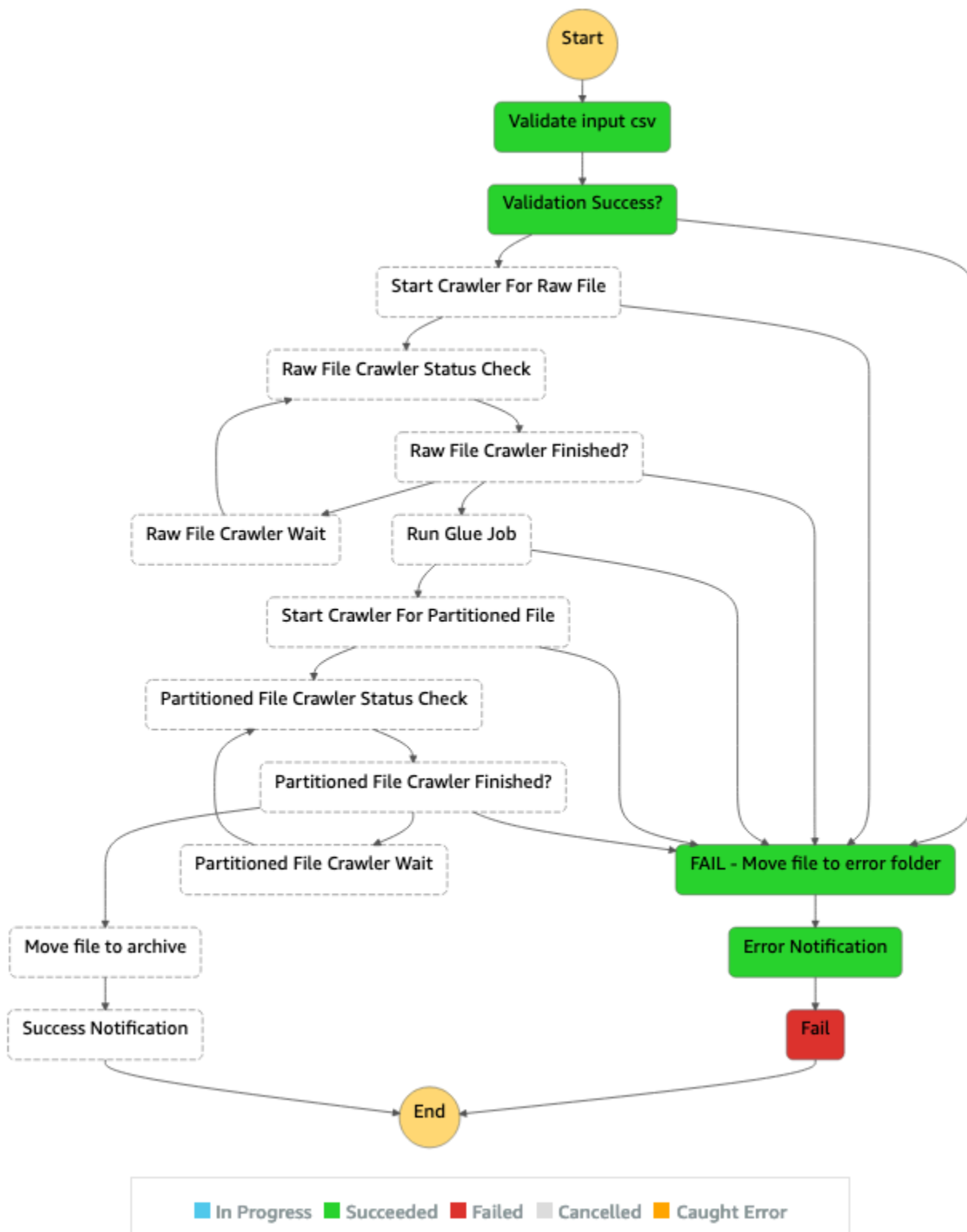

# Perform advanced analytics using Amazon Redshift ML

Created by Po Hong (AWS) and Chyanna Antonio (AWS)

**Environment:** PoC or pilot

**Technologies:** Analytics;  
Machine learning & AI

**Workload:** All other  
workloads

**AWS services:** Amazon  
Redshift; Amazon SageMaker

## Summary

On the Amazon Web Services (AWS) Cloud, you can use Amazon Redshift machine learning (Amazon Redshift ML) to perform ML analytics on data stored in either an Amazon Redshift cluster or on Amazon Simple Storage Service (Amazon S3). Amazon Redshift ML supports supervised learning, which is typically used for advanced analytics. Use cases for Amazon Redshift ML include revenue forecasting, credit card fraud detection, and customer lifetime value (CLV) or customer churn predictions.

Amazon Redshift ML makes it easy for database users to create, train, and deploy ML models by using standard SQL commands. Amazon Redshift ML uses Amazon SageMaker Autopilot to automatically train and tune the best ML models for classification or regression based on your data, while you retain control and visibility.

All interactions between Amazon Redshift, Amazon S3, and Amazon SageMaker are abstracted away and automated. After the ML model is trained and deployed, it becomes available as a [user-defined function](#) (UDF) in Amazon Redshift and can be used in SQL queries.

This pattern complements the [Create, train, and deploy ML models in Amazon Redshift using SQL with Amazon Redshift ML](#) from the AWS Blog, and the [Build, train, and deploy an ML model with Amazon SageMaker](#) tutorial from the [Getting Started Resource Center](#).

## Prerequisites and limitations

### Prerequisites

- An active AWS account
- Existing data in an Amazon Redshift table



## Skills

- Familiarity with terms and concepts used by Amazon Redshift ML, including *machine learning*, *training*, and *prediction*. For more information about this, see [Training ML models](#) in the Amazon Machine Learning (Amazon ML) documentation.
- Experience with Amazon Redshift user setup, access management, and standard SQL syntax. For more information about this, see [Getting started with Amazon Redshift](#) in the Amazon Redshift documentation.
- Knowledge and experience with Amazon S3 and AWS Identity and Access Management (IAM).
- Experience running commands in AWS Command Line Interface (AWS CLI) is also beneficial but not required.

## Limitations

- The Amazon Redshift cluster and S3 bucket must be located in the same AWS Region.
- This pattern's approach only supports supervised learning models such as regression, binary classification, and multiclass classification.

## Architecture

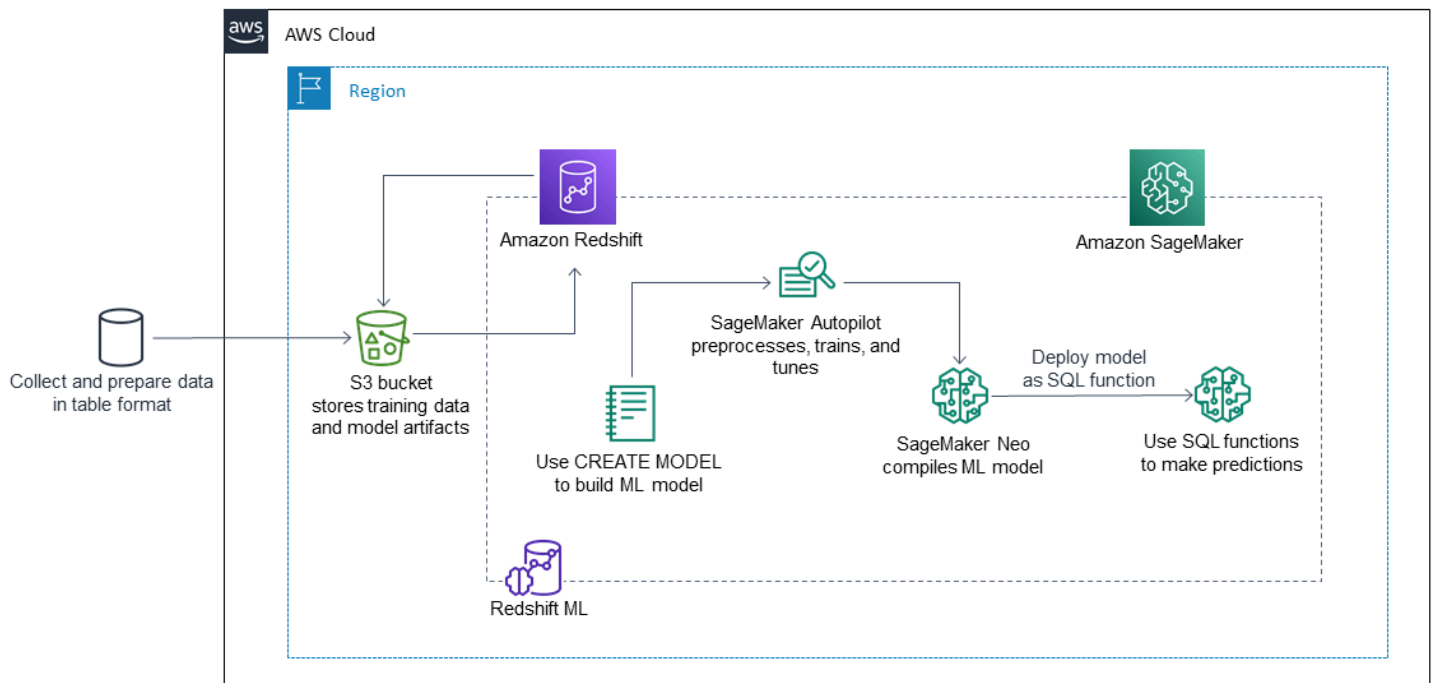

The following steps explain how Amazon Redshift ML works with SageMaker to build, train, and deploy an ML model:

1. Amazon Redshift exports training data to an S3 bucket.
2. SageMaker Autopilot automatically preprocesses the training data.
3. After the `CREATE MODEL` statement is invoked, Amazon Redshift ML uses SageMaker for training.
4. SageMaker Autopilot searches for and recommends the ML algorithm and optimal hyper-parameters that optimize the evaluation metrics.
5. Amazon Redshift ML registers the output ML model as a SQL function in the Amazon Redshift cluster.
6. The ML model's function can be used in a SQL statement.

## Technology stack

- Amazon Redshift
- SageMaker
- Amazon S3

## Tools

- [Amazon Redshift](#) – Amazon Redshift is an enterprise-level, petabyte scale, fully managed data warehousing service.
- [Amazon Redshift ML](#) – Amazon Redshift machine learning (Amazon Redshift ML) is a robust, cloud-based service that makes it easy for analysts and data scientists of all skill levels to use ML technology.
- [Amazon S3](#) – Amazon Simple Storage Service (Amazon S3) is storage for the internet.
- [Amazon SageMaker](#) – SageMaker is a fully managed ML service.
- [Amazon SageMaker Autopilot](#) – SageMaker Autopilot is a feature-set that automates key tasks of an automatic machine learning (AutoML) process.

## Code

You can create a supervised ML model in Amazon Redshift by using the following code:

```

“CREATE MODEL customer_churn_auto_model
FROM (SELECT state,
             account_length,
             area_code,
             total_charge/account_length AS average_daily_spend,
             cust_serv_calls/account_length AS average_daily_cases,
             churn
      FROM customer_activity
      WHERE record_date < '2020-01-01'
     )
TARGET churn
FUNCTION ml_fn_customer_churn_auto
IAM_ROLE 'arn:aws:iam::XXXXXXXXXXXX:role/Redshift-ML'
SETTINGS (
  S3_BUCKET 'your-bucket'
);”

```

**Note:** The SELECT state can refer to Amazon Redshift regular tables, Amazon Redshift Spectrum external tables, or both.

## Epics

### Prepare a training and test dataset

Task	Description	Skills required
Prepare a training and test dataset.	<p>Sign in to the AWS Management Console and open the Amazon SageMaker console. Follow the instructions from the <a href="#">Build, train, and deploy a machine learning model</a> tutorial to create a .csv or Apache Parquet file that has a label column (<i>supervised training</i>) and no header.</p> <p><b>Note:</b> We recommend that you shuffle and split the raw dataset into a training set</p>	Data scientist

Task	Description	Skills required
	for the model's training (70 percent) and a test set for the model's performance evaluation (30 percent).	

## Prepare and configure the technology stack

Task	Description	Skills required
Create and configure an Amazon Redshift cluster.	<p>On the Amazon Redshift console, create a cluster according to your requirements. For more information about this, see <a href="#">Create a cluster</a> in the Amazon Redshift documentation.</p> <p><b>Important:</b> Amazon Redshift clusters must be created with the SQL_PREVIEW maintenance track. For more information about preview tracks, see <a href="#">Choosing cluster maintenance tracks</a> in the Amazon Redshift documentation.</p>	DBA, Cloud architect
Create an S3 bucket to store training data and model artifacts.	On the Amazon S3 console, create an S3 bucket for the training and test data. For more information about creating an S3 bucket, see <a href="#">Create an S3 bucket</a> from AWS Quick Starts.	DBA, Cloud architect

Task	Description	Skills required
	<b>Important:</b> Make sure that your Amazon Redshift cluster and S3 bucket are in the same Region.	
Create and attach an IAM policy to the Amazon Redshift cluster.	Create an IAM policy to allow the Amazon Redshift cluster to access SageMaker and Amazon S3. For instructions and steps, see <a href="#">Cluster setup for using Amazon Redshift ML</a> in the Amazon Redshift documentation.	DBA, Cloud architect
Allow Amazon Redshift users and groups to access schemas and tables.	Grant permissions to allow users and groups in Amazon Redshift to access internal and external schemas and tables. For steps and instructions, see <a href="#">Managing permissions and ownership</a> in the Amazon Redshift documentation.	DBA

## Create and train the ML model in Amazon Redshift

Task	Description	Skills required
Create and train the ML model in Amazon Redshift.	Create and train your ML model in Amazon Redshift ML. For more information, see the CREATE MODEL statement in the Amazon Redshift documentation.	Developer, Data scientist

## Perform batch inference and prediction in Amazon Redshift

Task	Description	Skills required
Perform inference using the generated ML model function.	For more information about performing inference by using the generated ML model function, see <a href="#">Prediction</a> in the Amazon Redshift documentation.	Data scientist, Business intelligence user

## Related resources

### Prepare a training and test dataset

- [Building, training, and deploying a machine learning model with Amazon SageMaker](#)

### Prepare and configure the technology stack

- [Creating an Amazon Redshift cluster](#)
- [Choosing Amazon Redshift cluster maintenance tracks](#)
- [Creating an S3 bucket](#)
- [Setting up an Amazon Redshift cluster for using Amazon Redshift ML](#)
- [Managing permissions and ownership in Amazon Redshift](#)

### Create and train the ML model in Amazon Redshift

- [CREATE MODEL statement in Amazon Redshift](#)

### Perform batch inference and prediction in Amazon Redshift

- [Prediction in Amazon Redshift](#)

## Other resources

- [Getting started with Amazon Redshift ML](#)
- [Creating, training, and deploying ML models in Amazon Redshift using SQL with Amazon Redshift ML](#)
- [Amazon Redshift partners](#)
- [AWS machine learning competency partners](#)

# Access, query, and join Amazon DynamoDB tables using Athena

Created by Moinul Al-Mamun (AWS)

**Environment:** Production

**Technologies:** Analytics;  
Databases; Serverless

**AWS services:** Amazon  
Athena; Amazon DynamoDB;  
AWS Lambda; Amazon S3

## Summary

This pattern shows you how to set up a connection between Amazon Athena and Amazon DynamoDB by using the Amazon Athena DynamoDB connector. The connector uses an AWS Lambda function to query the data in DynamoDB. You don't need to write any code to set up the connection. After the connection is established, you can quickly access and analyze DynamoDB tables by using [Athena Federated Query](#) to run SQL commands from Athena. You can also join one or more DynamoDB tables to each other or to other data sources, such as Amazon Redshift or Amazon Aurora.

## Prerequisites and limitations

### Prerequisites

- An active AWS account with permissions to manage DynamoDB tables, Athena Data sources, Lambda, and AWS Identity and Access Management (IAM) roles
- An Amazon Simple Storage Service (Amazon S3) bucket where Athena can store query results
- An S3 bucket where the Athena DynamoDB Connector can save the data in the short term
- An AWS Region that supports [Athena engine version 2](#)
- IAM permissions to access Athena and the required S3 buckets
- [Amazon Athena DynamoDB Connector](#), installed

### Limitations

There is a cost for querying DynamoDB tables. Table sizes exceeding a few gigabytes (GBs) can incur a high cost. We recommend that you consider cost before performing any full table SCAN



operation. For more information, see [Amazon DynamoDB pricing](#). To reduce costs and achieve high performance, we recommend that you always use LIMIT in your query (for example, `SELECT * FROM table1 LIMIT 10`). Also, before you perform a JOIN or GROUP BY query in a production environment, consider the size of your tables. If your tables are too large, consider alternative options such as [migrating the table to Amazon S3](#).

## Architecture

The following diagram shows how a user can run a SQL query on a DynamoDB table from Athena.

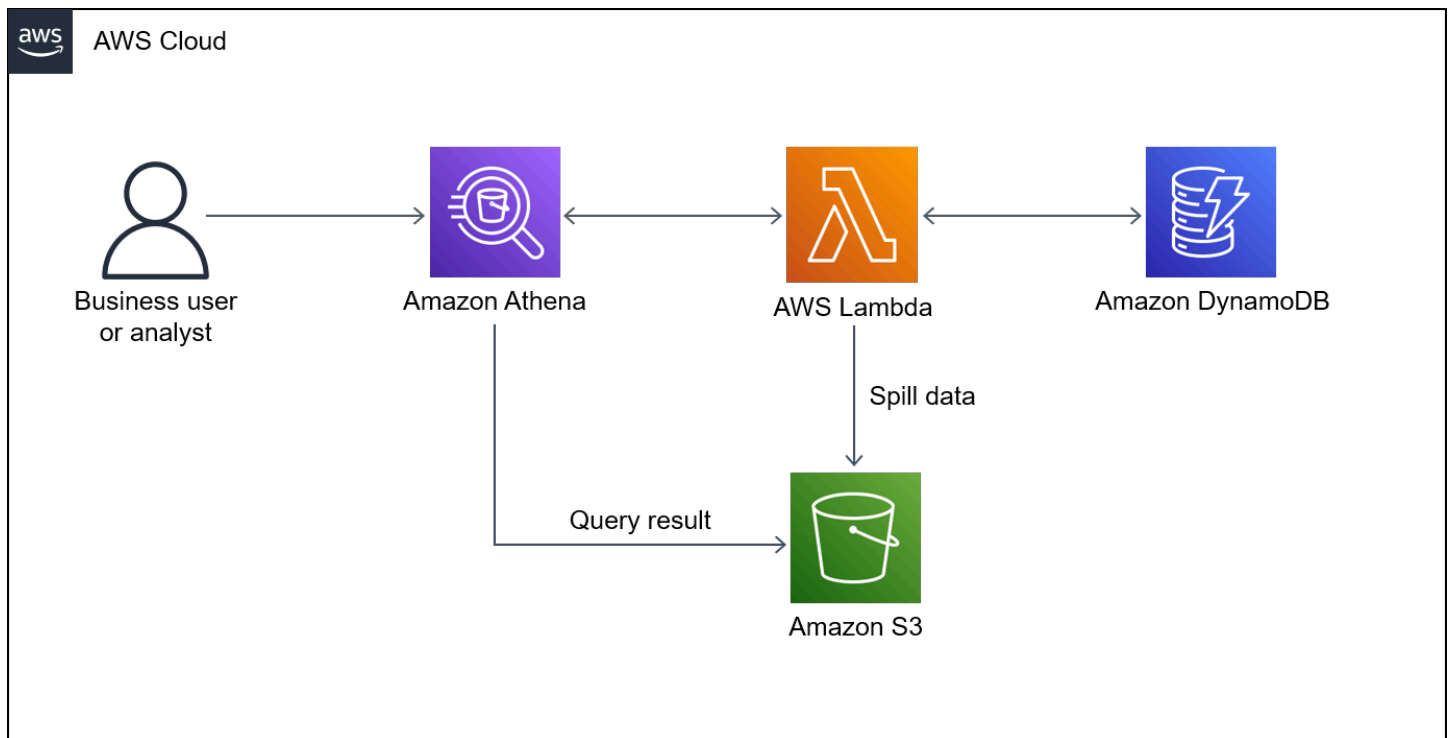

The diagram shows the following workflow:

1. To query a DynamoDB table, a user runs a SQL query from Athena.
2. Athena initiates a Lambda function.
3. The Lambda function queries the requested data in the DynamoDB table.
4. DynamoDB returns the requested data to the Lambda function. Then, the function transfers the query results to the user through Athena.
5. The Lambda function stores data in the S3 bucket.

## Technology stack

- Amazon Athena
- Amazon DynamoDB
- Amazon S3
- AWS Lambda

## Tools

- [Amazon Athena](#) is an interactive query service that helps you analyze data directly in Amazon S3 by using standard SQL.
- [Amazon Athena DynamoDB Connector](#) is an AWS tool that enables Athena to connect with DynamoDB and access your tables by using SQL queries.
- [Amazon DynamoDB](#) is a fully managed NoSQL database service that provides fast, predictable, and scalable performance.
- [AWS Lambda](#) is a compute service that helps you run code without needing to provision or manage servers. It runs your code only when needed and scales automatically, so you pay only for the compute time that you use.

## Epics

### Create sample DynamoDB tables

Task	Description	Skills required
Create the first sample table.	<ol style="list-style-type: none"><li>1. Sign in to the AWS Management Console and open the <a href="#">DynamoDB console</a>.</li><li>2. Choose <b>Create table</b>.</li><li>3. For <b>Table name</b>, enter <b>dydbtable1</b>.</li><li>4. For <b>Partition key</b>, enter <b>PK1</b>.</li><li>5. For <b>Sort key</b>, enter <b>SK1</b>.</li></ol>	Developer

Task	Description	Skills required
	<ol style="list-style-type: none"><li>6. In the <b>Table settings</b> section, choose <b>Customize settings</b>.</li><li>7. In the <b>Table class</b> section, choose <b>DynamoDB Standard</b>.</li><li>8. In the <b>Read/write capacity settings</b> section, for <b>Capacity mode</b>, choose <b>On-demand</b>.</li><li>9. In the <b>Encryption at rest</b> section, choose <b>Owned by Amazon DynamoDB</b>.</li><li>10. Choose <b>Create table</b>.</li></ol>	

Task	Description	Skills required
Insert sample data into the first table.	<ol style="list-style-type: none"><li>1. Open the <a href="#">DynamoDB console</a>.</li><li>2. In the navigation pane, choose <b>Table</b>, and then choose your table in the <b>Name</b> column.</li><li>3. Choose <b>Actions</b>, and then choose <b>Create item</b>.</li><li>4. Choose <b>JSON view</b>.</li><li>5. In the title bar of the <b>Attributes</b> editor, turn off <b>View DynamoDB JSON</b>.</li><li>6. In the <b>Attributes</b> editor, enter the following sample data one by one: <pre data-bbox="594 1052 1027 1289">{   "PK1": "1234",   "SK1": "info",   "Salary": "5000" }</pre><pre data-bbox="594 1320 1027 1558">{   "PK1": "1235",   "SK1": "info",   "Salary": "5200" }</pre></li></ol>	Developer

Task	Description	Skills required
Create the second sample table.	<ol style="list-style-type: none"><li>1. Open the <a href="#">DynamoDB console</a>.</li><li>2. Choose <b>Create table</b>.</li><li>3. For <b>Table name</b>, enter <b>dydbtable2</b>.</li><li>4. For <b>Partition key</b>, enter <b>PK2</b>.</li><li>5. For <b>Sort key</b>, enter <b>SK2</b>.</li><li>6. In the <b>Table settings</b> section, choose <b>Customize settings</b>.</li><li>7. In the <b>Table class</b> section, choose <b>DynamoDB Standard</b>.</li><li>8. In the <b>Read/write capacity settings</b> section, for <b>Capacity mode</b>, choose <b>On-demand</b>.</li><li>9. In the <b>Encryption at rest</b> section, choose <b>Owned by Amazon DynamoDB</b>.</li><li>10. Choose <b>Create table</b>.</li></ol>	Developer

Task	Description	Skills required
Insert sample data into the second table.	<ol style="list-style-type: none"> <li>1. Open the <a href="#">DynamoDB console</a>.</li> <li>2. In the navigation pane, choose <b>Table</b>, and then choose your table in the <b>Name</b> column.</li> <li>3. Choose <b>Actions</b>, and then choose <b>Create item</b>.</li> <li>4. In the title bar of the <b>Attributes</b> editor, turn off <b>View DynamoDB JSON</b>.</li> <li>5. In the <b>Attributes</b> editor, enter the following sample data one by one: <div data-bbox="594 995 1027 1234" style="border: 1px solid #ccc; border-radius: 10px; padding: 10px; margin: 10px 0;"> <pre>{   "PK2": "1234",   "SK2": "bonus",   "Bonus": "500" }</pre> </div> <div data-bbox="594 1264 1027 1503" style="border: 1px solid #ccc; border-radius: 10px; padding: 10px; margin: 10px 0;"> <pre>{   "PK2": "1235",   "SK2": "bonus",   "Bonus": "1000" }</pre> </div> </li> </ol>	Developer

### Create a data source in Athena for DynamoDB

Task	Description	Skills required
Set up the data source connector.	Create a data source for DynamoDB, and then create a	Developer

Task	Description	Skills required
	<p>Lambda function to connect to that data source.</p> <ol style="list-style-type: none"><li>1. Sign in to the AWS Management Console and open the <a href="#">Athena console</a>.</li><li>2. In the navigation pane, choose <b>Data sources</b>, and then choose <b>Create data source</b>.</li><li>3. Choose the <b>Amazon DynamoDB</b> data source, and then choose <b>Next</b>.</li><li>4. In the <b>Data source details</b> section, for <b>Data source name</b>, enter <b>testDynamoDB</b>.</li><li>5. In the <b>Connection details</b> section, select a Lambda function that's already deployed or choose <b>Create Lambda function</b> if you don't have a Lambda function to use for this pattern. <b>Note:</b> For more information on creating a Lambda function, see <a href="#">Getting started with Lambda</a> in the Lambda Developer Guide.</li><li>6. (Optional) If you choose <b>Create Lambda function</b>, then you must configure the AWS CloudFormation</li></ol>	

Task	Description	Skills required
	<p>template that's included by the Java application before deploying that stack. The template includes ApplicationName, SpillBucket, AthenaCatalogName, and other application settings.</p> <p><b>Note:</b> After you deploy this Java-based application, the stack creates a Lambda function that enables Athena to communicate with DynamoDB. This makes your tables accessible through SQL commands.</p> <ol style="list-style-type: none"><li>7. Deploy your Lambda function.</li><li>8. Choose <b>Next</b>.</li></ol>	



Task	Description	Skills required
Verify that the Lambda function can access the S3 spill bucket.	<ol style="list-style-type: none"><li>1. Open the <a href="#">Lambda console</a>.</li><li>2. In the navigation pane, choose <b>Functions</b>, and then choose the function that you created earlier.</li><li>3. Choose the <b>Configuration</b> tab.</li><li>4. In the left pane, choose <b>Environment variables</b> , and then confirm that the value for the key is <code>spill_bucket</code> .</li><li>5. In the left pane, choose <b>Permissions</b>, and then in the <b>Execution role</b> section, choose the attached IAM role. <b>Note:</b> You are directed to the IAM role that's attached to your Lambda function in the IAM console.</li><li>6. Confirm that you have write permission on <code>spill_bucket</code> bucket.</li></ol> <p>If you experience errors, see the <i>Additional information</i> section in this pattern for guidance.</p>	Developer

## Access DynamoDB tables from Athena

Task	Description	Skills required
Query the DynamoDB tables.	<ol style="list-style-type: none"><li>1. Sign in to the AWS Management Console and open the <a href="#">Athena console</a>.</li><li>2. In the navigation pane, choose <b>Data sources</b>, and then choose <b>Create data source</b>.</li><li>3. In the navigation pane, choose <b>Query editor</b>.</li><li>4. On the <b>Editor</b> tab, in the <b>Data</b> section, for <b>Data source</b>, choose your data source for <b>Data source</b>.</li><li>5. For <b>Database</b>, choose your database.</li><li>6. For Query 1, enter the following query: <code>SELECT * FROM dydbtable1 t1;</code></li><li>7. Choose <b>Run</b>, and then verify the output in the table.</li><li>8. For Query 2, enter the following query: <code>SELECT * FROM dydbtable2 t2;</code></li><li>9. Choose <b>Run</b>, and then verify the output in the table.</li></ol>	Developer
Join the two DynamoDB tables.	DynamoDB is a NoSQL data store and doesn't support the SQL join operation.	Developer

Task	Description	Skills required
	<p>Consequently, you must perform a join operation on two DynamoDB tables:</p> <ol style="list-style-type: none"><li>1. Choose the plus icon to create another query.</li><li>2. For Query 3, enter the following query:</li></ol> <pre data-bbox="597 646 1026 886">SELECT pk1, salary, bonus FROM dydbtable1 t1 JOIN dydbtable2 t2 ON t1.pk1 = t2.pk2;</pre>	

## Related resources

- [Amazon Athena DynamoDB Connector](#) (AWS Labs)
- [Query any data source with Amazon Athena's new federated query](#) (AWS Big Data Blog)
- [Athena engine version reference](#) (Athena User Guide)
- [Simplify Amazon DynamoDB data extraction and analysis by using AWS Glue and Amazon Athena](#) (AWS Database Blog)

## Additional information

If you run a query in Athena with `spill_bucket` in the `{bucket_name}/folder_name/ format`, then you can receive the following error message:

```
"GENERIC_USER_ERROR: Encountered an exception[java.lang.RuntimeException] from your LambdaFunction[arn:aws:lambda:us-east-1:xxxxxx:function:testdynamodb] executed in context[retrieving meta-data] with message[You do NOT own the spill bucket with the name: s3://amzn-s3-demo-bucket/athena_dynamodb_spill_data/]
```

This query ran against the "default" database, unless qualified by the query. Please post the error message on our forum or contact customer support with Query Id: [query-id]"

To resolve this error, update the Lambda function's environment variable `spill_bucket` to `{bucket_name_only}`, and then update the following Lambda IAM policy for bucket write access:

```
{
  "Action": [
    "s3:GetObject",
    "s3:ListBucket",
    "s3:GetBucketLocation",
    "s3:GetObjectVersion",
    "s3:PutObject",
    "s3:PutObjectAcl",
    "s3:GetLifecycleConfiguration",
    "s3:PutLifecycleConfiguration",
    "s3:DeleteObject"
  ],
  "Resource": [
    "arn:aws:s3:::spill_bucket",
    "arn:aws:s3:::spill_bucket/*"
  ],
  "Effect": "Allow"
}
```

Alternatively, you can remove the Athena data source connector that you created earlier, and recreate it by using only `{bucket_name}` for `spill_bucket`.

# Set up a minimum viable data space to share data between organizations

Created by Ramy Hcini (Think-it), Ismail Abdellaoui (Think-it), Malte Gasseling (Think-it), Jorge Hernandez Suarez (AWS), and Michael Miller (AWS)

**Environment:** PoC or pilot

**Technologies:** Analytics  
; Containers & microservices; Data lakes; Databases; Infrastructure

**Workload:** Open-source

**AWS services:** Amazon Aurora; AWS Certificate Manager (ACM); AWS CloudFormation; Amazon EC2; Amazon EFS; Amazon EKS; Elastic Load Balancing (ELB); Amazon RDS; Amazon S3; AWS Systems Manager

## Summary

Data spaces are federated networks for data exchange with trust and control over one's data as core principles. They enable organizations to share, exchange, and collaborate on data at scale by offering a cost-effective and technology-agnostic solution.

Data spaces have the potential to significantly drive efforts for a sustainable future by using data-driven problem solving with an end-to-end approach that involves all relevant stakeholders.

This pattern guides you through the example of how two companies can use data space technology on Amazon Web Services (AWS) to drive their carbon emissions–reduction strategy forward. In this scenario, company X provides carbon-emissions data, which company Y consumes. See the [Additional information](#) section for the following data space specification details:

- Participants
- Business case

- Data space authority
- Data space components
- Data space services
- Data to be exchanged
- Data model
- Tractus-X EDC connector

The pattern includes steps for the following:

- Deploying the infrastructure needed for a basic data space with two participants running on AWS.
- Exchanging carbon emissions–intensity data by using the connectors in a secure way.

This pattern deploys a Kubernetes cluster that will host data space connectors and their services through Amazon Elastic Kubernetes Service (Amazon EKS).

The [Eclipse Dataspace Components \(EDC\)](#) control plane and data plane are both deployed on Amazon EKS. The official Tractus-X Helm chart deploys PostgreSQL and HashiCorp Vault services as dependencies.

In addition, the identity service is deployed on Amazon Elastic Compute Cloud (Amazon EC2) to replicate a real-life scenario of a minimum viable data space (MVDS).

## Prerequisites and limitations

### Prerequisites

- An active AWS account to deploy the infrastructure in your chosen AWS Region
- An AWS Identity and Access Management (IAM) user with access to Amazon S3 that will be used temporarily as a technical user (The EDC connector currently doesn't support the use of roles. We recommend that you create one IAM user specifically for this demo and that this user will have limited permissions associated with it.)
- [AWS Command Line Interface \(AWS CLI\)](#) installed and configured in your chosen AWS Region
- [AWS security credentials](#)
- [eksctl](#) on your workstation
- [Git](#) on your workstation

- [kubect1](#)
- [Helm](#)
- [Postman](#)
- An [AWS Certificate Manager \(ACM\)](#) SSL/TLS certificate
- A DNS name that will point to an Application Load Balancer (the DNS name must be covered by the ACM certificate)
- [HashiCorp Vault](#) (For information about using AWS Secrets Manager to manage secrets, see the [Additional information](#) section.)

## Product versions

- [AWS CLI version 2+](#)
- [Postman Collection v2.1](#)

## Limitations

- **Connector selection** – This deployment uses an EDC-based connector. However, be sure to consider the strengths and functionalities of both the [EDC](#) and [FIWARE True](#) connectors to make an informed decision that aligns with the specific needs of the deployment.
- **EDC connector build** – The chosen deployment solution relies on the [Tractus-X EDC Connector](#) Helm chart, a well-established and extensively tested deployment option. The decision to use this chart is driven by its common usage and the inclusion of essential extensions in the provided build. While PostgreSQL and HashiCorp Vault are default components, you have the flexibility to customize your own connector build if needed.
- **Private cluster access** – Access to the deployed EKS cluster is restricted to private channels. Interaction with the cluster is performed exclusively through the use of `kubect1` and IAM. Public access to the cluster resources can be enabled by using load balancers and domain names, which must be implemented selectively to expose specific services to a broader network. However, we do not recommend providing public access.
- **Security focus** – Emphasis is placed on abstracting security configurations to default specifications so that you can concentrate on the steps involved in EDC connector data exchange. Although default security settings are maintained, it's imperative to enable secure communications before you expose the cluster to the public network. This precaution ensures a robust foundation for secure data handling.

- **Infrastructure cost** – An estimation of the infrastructure’s cost can be found by using the [AWS Pricing Calculator](#). A simple calculation shows that costs can be up to 162.92 USD per month for the deployed infrastructure.

## Architecture

The MVDS architecture comprises two virtual private clouds (VPCs), one for the Dynamic Attribute Provisioning System (DAPS) identity service and one for Amazon EKS.

### DAPS architecture

The following diagram shows DAPS running on EC2 instances controlled by an Auto Scaling group. An Application Load Balancer and route table expose the DAPS servers. Amazon Elastic File System (Amazon EFS) synchronizes the data among the DAPS instances.

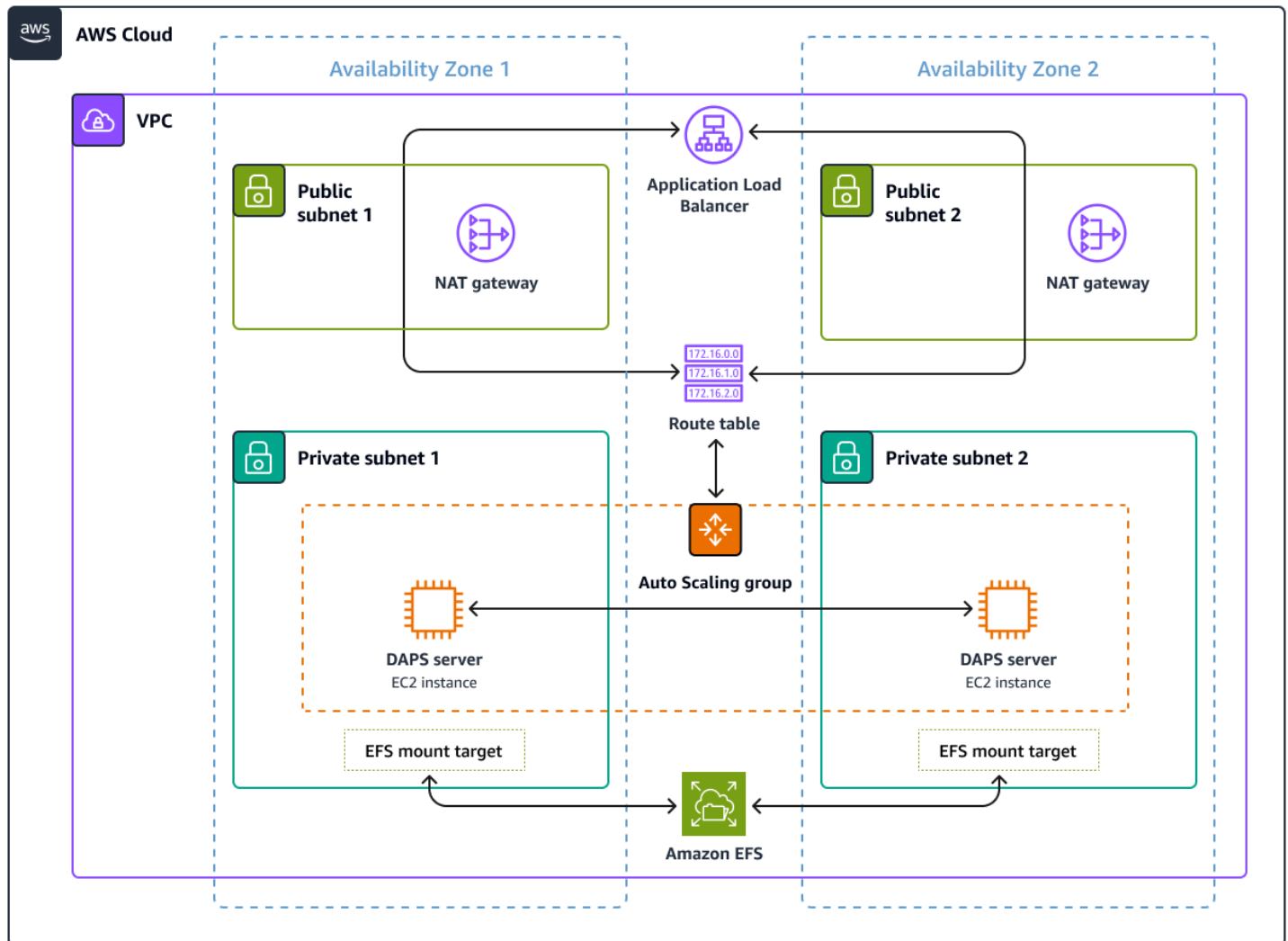



## Amazon EKS architecture

Data spaces are designed to be technology-agnostic solutions, and multiple implementations exist. This pattern uses an Amazon EKS cluster to deploy the data space technical components. The following diagram shows the deployment of the EKS cluster. Worker nodes are installed in private subnets. The Kubernetes pods access the Amazon Relational Database Service (Amazon RDS) for PostgreSQL instance that is also in the private subnets. The Kubernetes pods store shared data in Amazon S3.

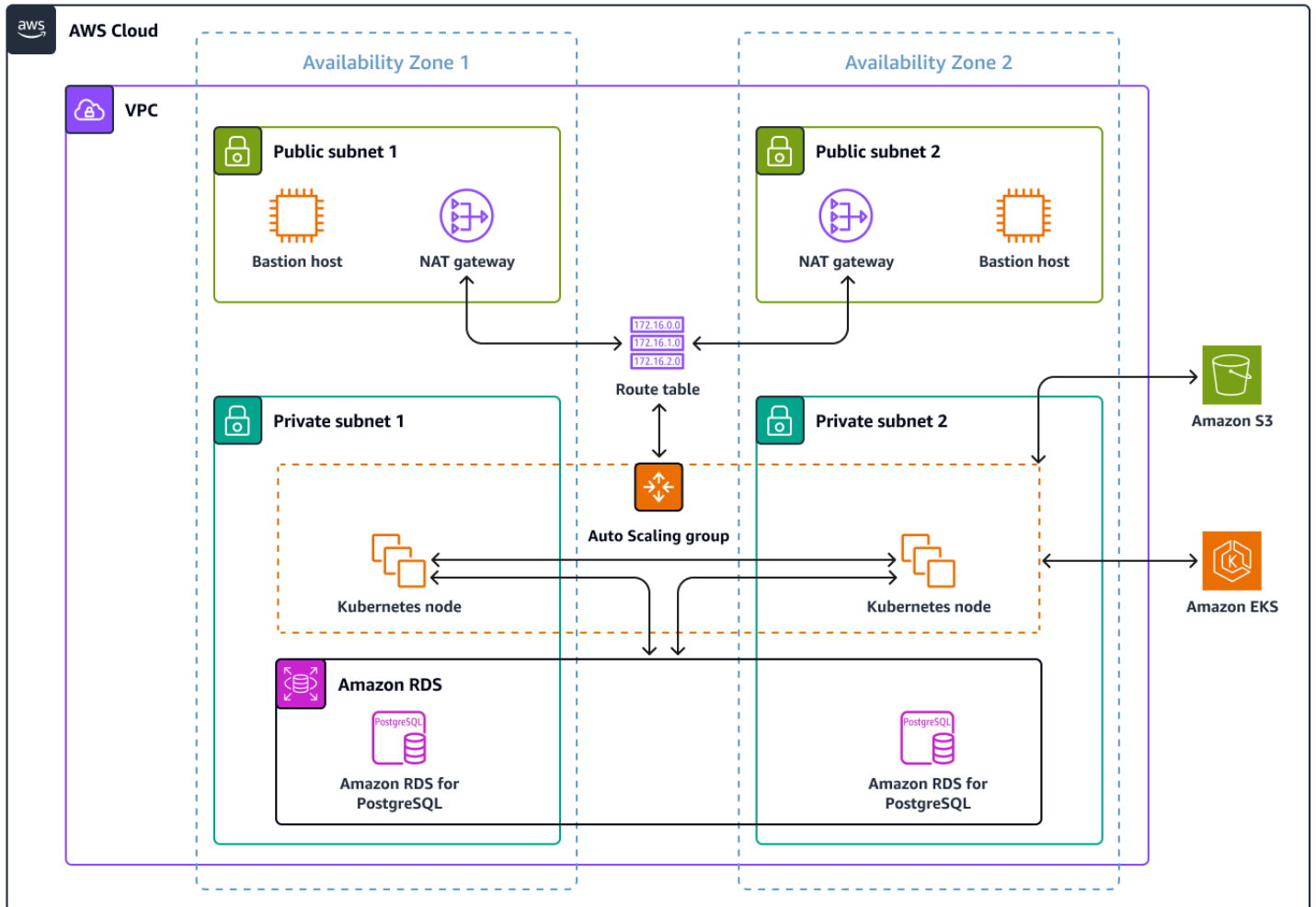

## Tools

### AWS services

- [AWS CloudFormation](#) helps you set up AWS resources, provision them quickly and consistently, and manage them throughout their lifecycle across AWS accounts and Regions.

- [Amazon Elastic Compute Cloud \(Amazon EC2\)](#) provides scalable computing capacity in the AWS Cloud. You can launch as many virtual servers as you need and quickly scale them up or down.
- [Amazon Elastic File System \(Amazon EFS\)](#) helps you create and configure shared file systems in the AWS Cloud.
- [Amazon Elastic Kubernetes Service \(Amazon EKS\)](#) helps you run Kubernetes on AWS without needing to install or maintain your own Kubernetes control plane or nodes.
- [Amazon Simple Storage Service \(Amazon S3\)](#) is a cloud-based object storage service that helps you store, protect, and retrieve any amount of data.
- [Elastic Load Balancing \(ELB\)](#) distributes incoming application or network traffic across multiple targets. For example, you can distribute traffic across EC2 instances, containers, and IP addresses in one or more Availability Zones.

## Other tools

- [eksctl](#) is a command-line utility for creating and managing Kubernetes clusters on Amazon EKS.
- [Git](#) is an open source, distributed version control system.
- [HashiCorp Vault](#) provides secure storage with controlled access for credentials and other sensitive information.
- [Helm](#) is an open source package manager for Kubernetes that helps you install and manage applications on your Kubernetes cluster.
- [kubectx](#) is a command-line interface that helps you run commands against Kubernetes clusters.
- [Postman](#) is an API platform.

## Code repository

The Kubernetes configuration YAML files and Python scripts for this pattern are available in the GitHub [aws-patterns-edc](#) repository. The pattern also uses the [Tractus-X EDC](#) repository.

## Best practices

### Amazon EKS and isolation of participants' infrastructures

Namespaces in Kubernetes will separate the company X provider's infrastructure from the company Y consumer's infrastructure in this pattern. For more information, see [EKS Best Practices Guides](#).

In a more realistic situation, each participant would have a separate Kubernetes cluster running within their own AWS account. The shared infrastructure (DAPS in this pattern) would be accessible by data space participants while being completely separated from participants' infrastructures.

## Epics

### Set up the environment, and provision an EKS cluster and EC2 instances

Task	Description	Skills required
Clone the repository.	<p>To clone the repository to your workstation, run the following command:</p> <pre>git clone https://github.com/Think-iT-Labs/aws-patterns-edc</pre> <p>The workstation must have access to your AWS account.</p>	DevOps engineer
Provision the Kubernetes cluster and set up namespaces.	<p>To deploy a simplified default EKS cluster in your account, run the following <code>eksctl</code> command on the workstation where you cloned the repo:</p> <pre>eksctl create cluster</pre> <p>The command creates the VPC and private and public subnets that span three different Availability Zones. After the network layer is created, the command creates two <code>m5.large</code> EC2 instances within an Auto Scaling group.</p>	DevOps engineer

Task	Description	Skills required
	<p>For more information and example output, see the <a href="#">eksctl guide</a>.</p> <p>After you provision the private cluster, add the new EKS cluster to your local Kubernetes configuration by running the following command:</p> <pre>aws eks update-kubeconfig --name &lt;EKS CLUSTER NAME&gt; --region &lt;AWS REGION&gt;</pre> <p>This pattern uses the eu-west-1 AWS Region to run all commands. However, you can run the same commands in your preferred AWS Region.</p> <p>To confirm that your EKS nodes are running and are in the ready state, run the following command:</p> <pre>kubectl get nodes</pre>	

Task	Description	Skills required
Set up the namespaces.	<p>To create namespaces for the provider and the consumer, run the following commands:</p> <pre>kubectl create ns provider kubectl create ns consumer</pre> <p>In this pattern, it's important to use <code>provider</code> and <code>consumer</code> as the namespaces to fit the configurations in the next steps.</p>	DevOps engineer

## Deploy the identity service

Task	Description	Skills required
Deploy DAPS by using AWS CloudFormation.	<p>For ease of managing DAPS operations, the DAPS server is installed on EC2 instances.</p> <p>To install DAPS, use the <a href="#">AWS CloudFormation template</a>. You will need the ACM certificate and DNS name from the <i>Prerequisites</i> section. The template deploys and configures the following:</p> <ul style="list-style-type: none"> <li>• Application Load Balancer</li> <li>• Auto Scaling group</li> </ul>	DevOps engineer

Task	Description	Skills required
	<ul style="list-style-type: none"><li>• EC2 instances configured with user data to install all necessary packages</li><li>• IAM roles</li><li>• DAPS</li></ul> <p>You can deploy the AWS CloudFormation template by signing in to the AWS Management Console and using the <a href="#">AWS CloudFormation console</a>. You can also deploy the template by using an AWS CLI command such as the following:</p> <pre>aws cloudformation   create-stack --stack-n ame daps \   --template-body   file://aws-patterns- edc/cloudformation.yml   --parameters \ ParameterKey=Cer tificateARN,Parame terValue=&lt;ACM Certificate ARN&gt; \ ParameterKey=DNS Name,ParameterValu e=&lt;DNS name&gt; \ ParameterKey=Ins tanceType,Paramete rValue=&lt;EC2 instance type&gt; \ ParameterKey=Env ironmentName,Param eterValue=&lt;Environ ment Name&gt; --capabil</pre>	

Task	Description	Skills required
	<p data-bbox="609 212 852 281">ities CAPABILIT Y_NAMED_IAM</p> <p data-bbox="591 344 1015 663">The environment name is your own choice. We recommend using a meaningful term, such as <code>DapsInfrastructure</code> , because it will be reflected in the AWS resource tags.</p> <p data-bbox="591 709 1024 884">For this pattern, <code>t3.small</code> is large enough to run the DAPS workflow, which has three Docker containers.</p> <p data-bbox="591 930 1024 1539">The template deploys the EC2 instances in private subnets. This means that the instances are not directly accessible through SSH (Secure Shell) from the internet. The instances are provisioned with the necessary IAM role and AWS Systems Manager Agent to enable access to the running instances through <a href="#">Session Manager</a>, a capability of AWS Systems Manager.</p> <p data-bbox="591 1585 1024 1854">We recommend using Session Manager for access. Alternatively, you could provision a bastion host to allow SSH access from the internet. When using the bastion host</p>	

Task	Description	Skills required
	<p>approach, the EC2 instance might take a few more minutes to start running.</p> <p>After the AWS CloudFormation template is successfully deployed, point the DNS name to your Application Load Balancer DNS name. To confirm, run the following command:</p> <pre>dig &lt;DNS NAME&gt;</pre> <p>The output should be similar to the following:</p> <pre>; &lt;&lt;&gt;&gt; DiG 9.16.1-Ub untu &lt;&lt;&gt;&gt; edc-patte rn.think-it.io ;; global options: +cmd ;; Got answer: ;; -&gt;HEADER&lt;&lt;- opcode: QUERY, status: NOERROR, id: 42344 ;; flags: qr rd ra; QUERY: 1, ANSWER: 3, AUTHORITY: 0, ADDITIONAL: 1  ;; OPT PSEUDOSECTION: ; EDNS: version: 0, flags:; udp: 65494 ;; QUESTION SECTION: ;edc-pattern.think- it.io. IN A  ;; ANSWER SECTION:</pre>	



Task	Description	Skills required
	<pre> edc-pattern.think- it.io. 276      IN               CNAME    daps- alb-iap9zmwy3kn8-13287 73120.eu-west-1.el b.amazonaws.com. daps-alb-iap9zmwy3k n8-1328773120.eu-w est-1.elb.amazonaw s.com. 36 IN A  52.208.240.129 daps-alb-iap9zmwy3kn8 -1328773120.eu-wes t-1.elb.amazonaws. com. 36 IN A 52.210.15 5.124                     </pre>	

Task	Description	Skills required
Register the participants' connectors to the DAPS service.	<p>From within any of the EC2 instances provisioned for DAPS, register participants:</p> <ol style="list-style-type: none"><li>1. Run the available script on the EC2 instance by using the root user: <pre>cd /srv/mvds/omejdn-daps</pre></li><li>2. Register the provider: <pre>bash scripts/register_connector.sh &lt;provider_name&gt;</pre></li><li>3. Register the consumer: <pre>bash scripts/register_connector.sh &lt;consumer_name&gt;</pre></li></ol> <p>The choice of the names doesn't impact the next steps. We recommend using either <code>provider</code> and <code>consumer</code> or <code>companyx</code> and <code>companyy</code>.</p> <p>The registration commands will also automatically configure the DAPS service with the needed information fetched from the created certificates and keys.</p>	DevOps engineer

Task	Description	Skills required
	<p>While you are logged in to a DAPS server, gather information needed for later steps in the installation:</p> <ol style="list-style-type: none"> <li>1. From <code>omejdn-daps/config/clients.yml</code> get the <code>client_id</code> for the provider and the consumer. The <code>client_id</code> values are long strings of hexadecimal digits.</li> <li>2. From the <code>omejdn-daps/keys</code> directory, copy the contents of the <code>consumer.cert</code>, <code>consumer.key</code>, <code>provider.cert</code>, and <code>provider.key</code> files.</li> </ol> <p>We recommend copying and pasting the text into similarly named files prefixed with <code>daps-</code> on your workstation.</p> <p>You should have the client IDs for the provider and consumer and should have four files in your working directory on your workstation:</p> <ul style="list-style-type: none"> <li>• Source file name <code>consumer.cert</code> becomes workstation file name <code>daps-consumer.cert</code>.</li> </ul>	

Task	Description	Skills required
	<ul style="list-style-type: none"> <li>Source file name <code>consumer.key</code> becomes workstation file name <code>daps-consumer.key</code> .</li> <li>Source file name <code>provider.cert</code> becomes workstation file name <code>daps-provider.cert</code> .</li> <li>Source file name <code>provider.key</code> becomes workstation file name <code>daps-provider.key</code> .</li> </ul>	

### Deploy the participants' connectors

Task	Description	Skills required
Clone the Tractus-X EDC repository and use the 0.4.1 version.	<p>The Tractus-X EDC connector's build requires PostgreSQL (assets database) and HashiCorp Vault (secrets management) services to be deployed and available.</p> <p>There are many different versions of Tractus-X EDC Helm charts. This pattern specifies version 0.4.1 because it uses the DAPS server.</p> <p>The latest versions use Managed Identity Wallet (MIW) with a distributed</p>	DevOps engineer

Task	Description	Skills required
	<p>implementation of the identity service.</p> <p>On the workstation where you created the two Kubernetes namespaces, clone the <a href="#">tractusx-edc repository</a>, and check out the <code>release/0.4.1</code> branch.</p> <pre data-bbox="597 646 1026 1003">git clone https://github.com/eclipse-tractusx/tractusx-edc  cd tractusx-edc  git checkout release/0.4.1</pre>	

Task	Description	Skills required
<p>Configure the Tractus-X EDC Helm chart.</p>	<p>Modify the Tractus-X Helm chart template configuration to enable both connectors to interact together.</p> <p>To do this, you would add the namespace to the DNS name of the service so that it could be resolved by other services in the cluster. These modifications should be made to the <code>charts/tractusx-connector/templates/_helpers.tpl</code> file. This pattern provides a <a href="#">final modified version of this file</a> for you to use. Copy it and put it in the <code>daps</code> section of the file <code>charts/tractusx-connector/templates/_helpers.tpl</code>.</p> <p>Make sure to comment all DAPS dependencies in <code>charts/tractusx-connector/Chart.yaml</code>:</p> <pre>dependencies:   # IDS Dynamic Attribute Provisioning Service (IAM)   # - name: daps   # version: 0.0.1   # repository:   "file://./subcharts/omejdn"   # alias: daps</pre>	<p>DevOps engineer</p>

Task	Description	Skills required
	<pre># condition: install.daps</pre>	

Task	Description	Skills required
Configure the connectors to use PostgreSQL on Amazon RDS.	<p>(Optional) Amazon Relational Database Service (Amazon RDS) instance is not required in this pattern. However, we highly recommend using Amazon RDS or Amazon Aurora because they provide features such as high availability and backup and recovery.</p> <p>To replace PostgreSQL on Kubernetes with Amazon RDS, do the following:</p> <ol style="list-style-type: none"><li>1. Provision the <a href="#">Amazon RDS for PostgreSQL instance</a>.</li><li>2. In <code>Chart.yaml</code>, comment the PostgreSQL section.</li><li>3. In <code>provider_values.yaml</code> and <code>consumer_values.yaml</code>, configure the <code>postgresql</code> section as follows:</li></ol> <pre>postgresql:   auth:     database: edc     password: &lt;RDS PASSWORD&gt;     username: &lt;RDS Username&gt;</pre>	DevOps engineer



Task	Description	Skills required
	<pre>jdbcUrl: jdbc:post gresql://&lt;RDS DNS NAME&gt;:5432/edc username: &lt;RDS Username&gt; password: &lt;RDS PASSWORD&gt; primary:   persistence:     enabled: false readReplicas:   persistence:     enabled: false</pre>	

Task	Description	Skills required
Configure and deploy the provider connector and its services.	<p>To configure the provider connector and its services, do the following:</p> <ol style="list-style-type: none"><li>1. To download the <code>provider_edc.yaml</code> file from the <code>edc_helm_configs</code> directory to the current Helm chart folder, run the following command:  <pre>wget -q https://raw.githubusercontent.com/Think-iT-Labs/aws-patterns-edc/main/edc_helm_configs/provider_edc.yaml -P charts/tractusx-connector/</pre></li><li>2. Replace the following variables (also marked in the file) with their values:<ul style="list-style-type: none"><li>• <code>CLIENT_ID</code> – The ID generated by the DAPS. The <code>CLIENT_ID</code> should be in <code>/srv/mvds/omejdn-daps/config/clients.yml/config/clients.yml</code> on the DAPS server. It should a string of hexadecimal characters.</li></ul></li></ol>	DevOps engineer

Task	Description	Skills required
	<ul style="list-style-type: none"><li>• DAPS_URL – The URL of the DAPS server. It should be <code>https://{DNS name}</code> using the DNS name that you set up when you ran the AWS CloudFormation template.</li><li>• VAULT_TOKEN – The token to be used for Vault authorization. Choose any value.</li><li>• <code>vault.fullnameOverride</code> – <code>vault-provider</code> .</li><li>• <code>vault.hashicorp.url</code> – <code>http://vault-provider:8200/</code> .</li></ul> <p>The previous values assume that the deployment name and the namespace name are <code>provider</code>.</p> <p>3. To run the Helm chart from your workstation, use the following commands:</p> <pre>cd charts/tractusx-connector  helm dependency build</pre>	

Task	Description	Skills required
	<pre>helm upgrade -- install provider ./ -f provider_edc.yaml -n provider</pre>	

Task	Description	Skills required
Add the certificate and keys to the provider vault.	<p>To avoid confusion, produce the following certificates outside of the <code>tractusx-edc/charts</code> directory.</p> <p>For example, run the following command to change to your home directory:</p> <pre>cd ~</pre> <p>You now need to add the secrets that are needed by the provider into the vault.</p> <p>The names of the secrets within the vault are the values of the keys in the <code>secretNames:</code> section of the <code>provider_edc.yml</code> file. By default, they are configured as follows:</p> <pre>secretNames:   transferProxyTokenSignerPrivateKey: transfer-proxy-token-signer-private-key   transferProxyTokenSignerPublicKey: transfer-proxy-token-signer-public-key   transferProxyTokenEncryptionKey: transferProxyTokenEncryptionKey</pre>	DevOps engineer

Task	Description	Skills required
	<pre> nAesKey: transfer- proxy-token-encryp tion-aes-key            dapsPriva teKey: daps-private- key            dapsPubli cKey: daps-public-key </pre> <p>An Advanced Encryption Standard (AES) key, private key, public key, and self-signed certificate are generated initially. These are subsequently added as secrets to the vault.</p> <p>Furthermore, this directory should contain the <code>daps-provider.cert</code> and <code>daps-provider.key</code> files that you copied from the DAPS server.</p> <ol style="list-style-type: none"> <li>1. Run the following commands:</li> </ol> <pre> # generate a private key openssl ecparam -name prime256v1 -genkey -noout -out provider- private-key.pem # generate correspon ding public key openssl ec -in provider-private-k ey.pem -pubout -out </pre>	

Task	Description	Skills required
	<pre> provider-public-key.pem # create a self-signed certificate openssl req -new -x509 -key provider-private-key.pem -out provider-cert.pem -days 360 # generate aes key openssl rand -base64 32 &gt; provider-aes.key </pre> <p>2. Before adding the secrets to the vault, convert them from multiple lines to single lines by replacing line breaks with <code>\n</code>:</p> <pre> cat provider-private-key.pem   sed 's/\$/\n/'   tr -d '\n' &gt; provider-private-key.pem.line cat provider-public-key.pem   sed 's/\$/\n/'   tr -d '\n' &gt; provider-public-key.pem.line cat provider-cert.pem   sed 's/\$/\n/'   tr -d '\n' &gt; provider-cert.pem.line cat provider-aes.key   sed 's/\$/\n/'   tr -d '\n' &gt; provider-aes.key.line </pre>	

Task	Description	Skills required
	<pre>## The following block is for daps certifica te and key openssl x509 -in daps-provider.cert - outform PEM   sed 's/ \$/\n/'   tr -d '\n' &gt; daps-provider.cert .line cat daps-provider.key   sed 's\$/\n/'   tr -d '\n' &gt; daps- provider.key.line</pre> <p>3. To format the secrets that will be added to Vault, run the following commands:</p> <pre>JSONFORMAT='{ "cont ent": "%s"}' #create a single line in JSON format printf "\${JSONFO RMAT}\n" "`cat provider-private- key.pem.line`" &gt; provider-private-k ey.json printf "\${JSONFO RMAT}\n" "`cat provider-public- key.pem.line`" &gt; provider-public-ke y.json printf "\${JSONFO RMAT}\n" "`cat provider-cert.pem. line`" &gt; provider- cert.json printf "\${JSONFO RMAT}\n" "`cat</pre>	



Task	Description	Skills required
	<pre data-bbox="646 210 993 766"> provider-aes.key.line`" &gt; provider- aes.json  printf "\${JSONFO RMA} \\n" "`cat daps- provider.key.line`" &gt; daps-provider.key. json printf "\${JSONFO RMA} \\n" "`cat daps- provider.cert.line`" &gt; daps-provider.cert .json </pre> <p data-bbox="630 823 1026 949">The secrets are now in JSON format and are ready to be added to the vault.</p> <p data-bbox="592 976 1026 1102">4. To get the pod name for the vault, run the following command:</p> <pre data-bbox="633 1144 982 1291"> kubectl get pods - n provider   egrep "vault NAME" </pre> <p data-bbox="630 1339 1026 1852">The pod name will be similar to "vault-provider-0" . This name is used when creating a port forward to the vault. The port forward gives you to access the vault to add the secret. You should run this from a workstation that has AWS credentials configured.</p>	

Task	Description	Skills required
	<p>5. To access the vault, use <code>kubectl</code> to configure a port forward:</p> <pre data-bbox="630 380 1029 537">kubectl port-forward &lt;VAULT_POD_NAME&gt; 8200:8200 -n provider</pre> <p>You should now be able to access the vault through your browser or the CLI.</p> <p><b>Browser</b></p> <ol style="list-style-type: none"><li>1. Using the browser, navigate to <a href="http://127.0.0.1:8200">http://127.0.0.1:8200</a>, which will use the port forward that you configured.</li><li>2. Log in using the token you that configured previously in <code>provider_edc.yml</code> . In the secrets engine, create three secrets. Each secret will have a Path for this secret value, which is the secret name shown in the following list. Within the secret data section, the name of the key will be content and the value will be the single line of text from the respective file named <code>.line</code>.</li></ol>	

Task	Description	Skills required
	<p>3. The secret names are sourced from the <code>secretNames</code> section in the <code>provider_edc.yml</code> file.</p> <p>4. Create the following secrets:</p> <ul style="list-style-type: none"><li>• Secret <code>transfer-proxy-token-signer-private-key</code> with file name <code>provider-private-key.pem</code>.line</li><li>• Secret <code>transfer-proxy-token-signer-public-key</code> with file name <code>provider-cert.pem</code>.line</li><li>• Secret <code>transfer-proxy-token-encryption-aes-key</code> with file name <code>provider-aes.key</code>.line</li><li>• Secret <code>daps-private-key</code> with file name <code>daps-provider.key</code>.line</li><li>• Secret <code>daps-public-key</code> with file name <code>daps-provider.cert</code>.line</li></ul>	

Task	Description	Skills required
	<p><b>Vault CLI</b></p> <p>The CLI will also use the port forward that you configured.</p> <ol style="list-style-type: none"><li>1. On your workstation, install Vault CLI by following the instructions in the <a href="#">HashiCorp Vault documentation</a>.</li><li>2. To log in to the vault by using the token that you set up in <code>provider_edc.yml</code>, run the following command:</li></ol> <pre data-bbox="634 930 1029 1087">vault login -address= http://127.0.0.1:8 200</pre> <p>With the correct token, you should see the message "Success! You are now authenticated."</p> <ol style="list-style-type: none"><li>3. To create the secrets by using the JSON formatted files that you created previously, run the following code:</li></ol> <pre data-bbox="634 1591 1029 1843">vault kv put -address= http://127.0.0.1:8 200 secret/transfer- proxy-token-signer-p rivate-key @provider -private-key.json</pre>	

Task	Description	Skills required
	<pre>vault kv put - address=http://12 7.0.0.1:8200 secret/ transfer-proxy-token -signer-public-key @provider-cert.json vault kv put -address= http://127.0.0.1:8 200 secret/transfer- proxy-token-encrypti on-aes-key @provider -aes.json  vault kv put -address= http://127.0.0.1:8 200 secret/daps- private-key @daps-pro vider.key.json vault kv put - address=http://12 7.0.0.1:8200 secret/ daps-public-key @daps-provider.cer t.json</pre>	

Task	Description	Skills required
Configure and deploy the consumer connector and its services.	<p>The steps for configuring and deploying the consumer are similar to those you completed for the provider:</p> <ol style="list-style-type: none"><li>1. To copy the <code>consumer_edc.yaml</code> from the <a href="#">aws-patterns-edc</a> repo into the <code>tractusx-edc/charts/tractusx-connector</code> folder, run the following commands:</li></ol> <pre data-bbox="630 810 1027 1247">cd tractusx-edc  wget -q https://raw.githubusercontent.com/Think-iT-Labs/aws-patterns-edc/main/edc_helm_configs/consumer_edc.yaml -P charts/tractusx-connector/</pre> <ol style="list-style-type: none"><li>2. Update the following variables with their actual values:</li></ol> <ul style="list-style-type: none"><li>• <code>CONSUMER_CLIENT_ID</code><ul style="list-style-type: none"><li>– The ID generated by DAPS. The <code>CONSUMER_CLIENT_ID</code> should be in <code>config/clients.yaml</code> on the DAPS server.</li></ul></li></ul>	

Task	Description	Skills required
	<ul style="list-style-type: none"><li>• DAPS_URL – The same DAPS URL that you used for the provider.</li><li>• VAULT_TOKEN – The token to be used for Vault authorization. Choose any value.</li><li>• vault.fullnameOverride – vault-consumer</li><li>• vault.hashicorp.url – http://vault-provider:8200/</li></ul> <p>The previous values assume that the deployment name and the namespace name are consumer.</p> <p>3. To run the Helm chart, use the following commands:</p> <pre>cd charts/tractusx-consumer  helm upgrade --install consumer ./ -f consumer_edc.yaml -n consumer</pre>	

Task	Description	Skills required
Add the certificate and keys to the consumer vault.	<p>From a security standpoint, we recommend regenerating the certificates and keys for each data space participant. This pattern regenerates certificates and keys for the consumer.</p> <p>The steps are very similar to those for the provider. You can verify the secret names in the <code>consumer_edc.yml</code> file.</p> <p>The names of the secrets within the vault are the values of the keys in the <code>secretNames:</code> section of the <code>consumer_edc.yml</code> file. By default, they are configured as follows:</p> <pre>secretNames:   transferProxyTokenSignerPrivateKey: transfer-proxy-token-signer-private-key   transferProxyTokenSignerPublicKey: transfer-proxy-token-signer-public-key   transferProxyTokenEncryptionAesKey: transfer-proxy-token-encryption-aes-key</pre>	DevOps engineer



Task	Description	Skills required
	<pre>dapsPrivateKey: daps-private-key dapsPublicKey: daps-public-key</pre> <p>The <code>daps-consumer.cert</code> and <code>daps-consumer.key</code> files that you copied from the DAPS server should already exist in this directory.</p> <ol style="list-style-type: none"><li>1. Run the following commands:</li></ol> <pre># generate a private key openssl ecparam -name prime256v1 -genkey -noout -out consumer-private-key.pem # generate corresponding public key openssl ec -in consumer-private-key.pem -pubout -out consumer-public-key.pem # create a self-signed certificate openssl req -new -x509 -key consumer-private-key.pem -out consumer-cert.pem -days 360 # generate aes key openssl rand -base64 32 &gt; consumer-aes.key</pre>	

Task	Description	Skills required
	<p>2. Manually edit the files to replace line breaks with <code>\n</code>, or use three commands similar to the following:</p> <pre data-bbox="633 430 1031 1617">cat consumer-private-key.pem   sed 's/\$/\n/'   tr -d '\n' &gt; consumer-private-key.pem.line cat consumer-public-key.pem   sed 's/\$/\n/'   tr -d '\n' &gt; consumer-public-key.pem.line cat consumer-cert.pem   sed 's/\$/\n/'   tr -d '\n' &gt; consumer-cert.pem.line cat consumer-aes.key   sed 's/\$/\n/'   tr -d '\n' &gt; consumer-aes.key.line cat daps-consumer.cert   sed 's/\$/\n/'   tr -d '\n' &gt; daps-consumer.cert.line cat daps-consumer.key   sed 's/\$/\n/'   tr -d '\n' &gt; daps-consumer.key.line</pre>	
	<p>3. To format the secrets that will be added to Vault, run the following commands:</p>	

Task	Description	Skills required
	<pre>JSONFORMAT='{ "content": "%s"}'  #create a single line in JSON format  printf "\${JSONFO RMAT}\\n" "`cat consumer-private- key.pem.line`" &gt; consumer-private-k ey.json printf "\${JSONFO RMAT}\\n" "`cat consumer-public- key.pem.line`" &gt; consumer-public-ke y.json printf "\${JSONFO RMAT}\\n" "`cat consumer-cert.pem. line`" &gt; consumer- cert.json printf "\${JSONFO RMAT}\\n" "`cat consumer-aes.key.l ine`" &gt; consumer- aes.json  printf "\${JSONFO RMAT}\\n" "`cat daps- consumer.key.line`" &gt; daps-consumer.key. json printf "\${JSONFO RMAT}\\n" "`cat daps- consumer.cert.line`" &gt; daps-consumer.cert .json</pre>	

Task	Description	Skills required
	<p>The secrets are now in JSON format and are ready to be added to the vault.</p> <p>4. To get the pod name for the consumer vault, run the following command:</p> <pre data-bbox="634 531 1029 688">kubect1 get pods -n consumer   egrep "vault NAME"</pre> <p>The pod name will be similar to "vault-consumer-0". This name is used when creating a port forward to the vault. The port forward gives you to access the vault to add the secret. You should run this from a workstation that has AWS credentials configured.</p> <p>5. To access the vault, use <code>kubect1</code> to configure a port forward:</p> <pre data-bbox="634 1430 1029 1587">kubect1 port-forward &lt;VAULT_POD_NAME&gt; 8201:8200 -n consumer</pre> <p>The local port is 8201 this time so that you can have port forwards in place for</p>	

Task	Description	Skills required
	<p>both the producer and consumer.</p> <p><b>Browser</b></p> <p>You can use your browser to connect to <a href="http://localhost:8201/">http://localhost:8201/</a> to access the consumer vault and create the secrets with names and content as outlined.</p> <p>The secrets and files that contain the content are the following:</p> <ul style="list-style-type: none"><li>• Secret transfer-proxy-token-signer-private-key with file name consumer-private-key.pem.line</li><li>• Secret transfer-proxy-token-signer-public-key with file name consumer-cert.pem.line</li><li>• Secret transfer-proxy-token-encryption-aes-key with file name consumer-aes.key.line</li></ul> <p><b>Vault CLI</b></p>	

Task	Description	Skills required
	<p>Using Vault CLI, you can run the following commands to log in to the vault and create the secrets:</p> <ol style="list-style-type: none"><li>1. Log in to the vault by using the token that you configured within <code>consumer_edc.yml</code> :</li></ol> <pre data-bbox="634 646 1029 808">vault login -address= http://127.0.0.1:8 201</pre> <p>With the correct token, you should see the message "Success! You are now authenticated."</p> <ol style="list-style-type: none"><li>2. To create the secrets using the JSON formatted files that you created previously, run the following code:</li></ol> <pre data-bbox="634 1262 1029 1871">vault kv put -address= http://127.0.0.1:8 201 secret/transfer- proxy-token-signer-p rivate-key @consumer -private-key.json vault kv put - address=http://12 7.0.0.1:8201 secret/ transfer-proxy-token -signer-public-key @consumer-cert.json vault kv put -address= http://127.0.0.1:8 201 secret/transfer-</pre>	

Task	Description	Skills required
	<pre> proxy-token-encryption-aes-key @consumer-aes.json vault kv put -address=http://127.0.0.1:8201 secret/daps-private-key @daps-consumer.key.json vault kv put -address=http://127.0.0.1:8201 secret/daps-public-key @daps-consumer.cert.json </pre>	

### Set up an HTTP client to interact with the management API of the connectors

Task	Description	Skills required
Set up port forwarding.	<ol style="list-style-type: none"> <li data-bbox="592 1071 1031 1197">1. To check the status of the pods, run the following commands: <div data-bbox="630 1234 1031 1438" style="border: 1px solid #ccc; border-radius: 10px; padding: 10px; margin: 10px 0;"> <pre> kubect1 get pods -n provider kubect1 get pods -n consumer </pre> </div> </li> <li data-bbox="592 1449 1031 1764">2. To make sure that the Kubernetes deployments were successful, look at the logs of the provider and consumer Kubernetes pods by running the following commands:</li> </ol>	DevOps engineer

Task	Description	Skills required
	<pre>kubectl logs -n provider &lt;producer control plane pod name&gt; kubectl logs -n consumer &lt;consumer control plane pod name&gt;</pre> <p>The cluster is private and is not accessible publicly. To interact with the connectors, use the Kubernetes port-forwarding feature to forward traffic generated by your machine to the connector control plane.</p> <ol style="list-style-type: none"><li>1. On the first terminal, forward the consumer's requests to the management API through port 8300:</li></ol> <pre>kubectl port-forward deployment/consumer-tractusx-connector-controlplane 8300:8081 -n consumer</pre> <ol style="list-style-type: none"><li>2. On the second terminal, forward the provider's requests to the management API through port 8400:</li></ol>	



Task	Description	Skills required
	<pre>kubectl port-forward deployment/provide r-tractusx-connect or-controlplane 8400:8081 -n provider</pre>	

Task	Description	Skills required
Create S3 buckets for the provider and the consumer.	<p>The EDC connector currently doesn't use temporary AWS credentials, such as those provided by assuming a role. The EDC supports only the use of an <a href="#">IAM access key ID and secret access key combination</a>.</p> <p>Two S3 buckets are required for later steps. One S3 bucket is used for storing data made available by the provider. The other S3 bucket is for data received by the consumer.</p> <p>The IAM user should have permission to read and write objects only in the two named buckets.</p> <p>An access key ID and secret access key pair needs to be created and kept safe. After this MVDS has been decommissioned, the IAM user should be deleted.</p> <p>The following code is an example IAM policy for the user:</p> <pre data-bbox="594 1667 1029 1881">{   "Version": "2012-10-17",   "Statement": [     {</pre>	DevOps engineer

Task	Description	Skills required
	<pre>         "Sid": "Stmt1708 699805237",         "Action": [             "s3:GetObject",             "s3:GetOb jectVersion",             "s3:ListA llMyBuckets",             "s3:ListB ucket",             "s3:ListB ucketMultipartUplo ads",             "s3:ListB ucketVersions",             "s3:PutObject"         ],         "Effect": "Allow",         "Resource": [             "arn:aws: s3:::&lt;S3 Provider Bucket&gt;",             "arn:aws: s3:::&lt;S3 Consumer Bucket&gt;",             "arn:aws: s3:::&lt;S3 Provider Bucket&gt;/*",             "arn:aws: s3:::&lt;S3 Consumer Bucket&gt;/*"         ]     ] } </pre>	

Task	Description	Skills required
Set up Postman to interact with the connector.	<p>You can now interact with the connectors through your EC2 instance. Use Postman as an HTTP client, and provide Postman Collections for both the provider and the consumer connectors.</p> <p>Import the <a href="#">collections</a> from the <code>aws-pattern-edc</code> repository into your Postman instance.</p> <p>This pattern uses Postman collection variables to provide input to your requests.</p>	App developer, Data engineer

### Provide company X carbon-emissions footprint data through the connector

Task	Description	Skills required
Prepare the carbon-emissions intensity data to be shared.	<p>First you need to decide on the data asset to be shared. The data of company X represents the carbon-emissions footprint of its vehicle fleet. Weight is Gross Vehicle Weight (GVW) in tonnes, and emissions are in grams of CO<sub>2</sub> per tonne-kilometer (g CO<sub>2</sub> e/t-km) according to the Wheel-to-Well (WTW) measurement:</p>	Data engineer, App developer

Task	Description	Skills required
	<ul style="list-style-type: none"><li>• Vehicle type: Van; weight: &lt; 3.5; emissions: 800</li><li>• Vehicle type: Urban truck; weight: 3.5–7.5; emissions: 315</li><li>• Vehicle type: Medium goods vehicle (MGV); weight: 7.5–20; emissions: 195</li><li>• Vehicle type: Heavy goods vehicle (HGV); weight: &gt; 20; emissions: 115</li></ul> <p>The example data is in the <code>carbon_emissions_data.json</code> file in the <code>aws-patterns-edc</code> repository.</p> <p>Company X uses Amazon S3 to store objects.</p> <p>Create the S3 bucket and store the example data object there. The following commands create an S3 bucket with default security settings. We highly recommend consulting <a href="#">Security best practices for Amazon S3</a>.</p> <pre>aws s3api create-bucket   &lt;BUCKET_NAME&gt; --region   &lt;AWS_REGION&gt;</pre>	

Task	Description	Skills required
	<pre># You need to add '--create-bucket-c onfiguration # LocationConstraint =&lt;AWS_REGION&gt;' if you want to create # the bucket outside of us- east-1 region  aws s3api put-object --bucket &lt;BUCKET_NAME&gt; \ --key &lt;S3 OBJECT NAME&gt; \ --body &lt;PATH OF THE FILE TO UPLOAD&gt;</pre> <p>The S3 bucket name should be globally unique. For more information about naming rules, see the <a href="#">AWS documentation</a>.</p>	

Task	Description	Skills required
<p>Register the data asset to the provider's connector by using Postman.</p>	<p>An EDC connector data asset holds the name of the data and its location. In this case, the EDC connector data asset will point to the created object in the S3 bucket:</p> <ul style="list-style-type: none"> <li>• <b>Connector:</b> Provider</li> <li>• <b>Request:</b> Create Asset</li> <li>• <b>Collection Variables:</b> Update ASSET_NAME . Choose a meaningful name that represents the asset.</li> <li>• <b>Request Body:</b> Update the request body with the S3 bucket that you created for the provider.</li> </ul> <pre data-bbox="630 1075 1029 1843"> "dataSource": {   "edc:type":   "AmazonS3",   "name": "Vehicle Carbon Footprint",   "bucketName":   "&lt;REPLACE WITH THE SOURCE BUCKET NAME&gt;",   "keyName":   "&lt;REPLACE WITH YOUR OBJECT NAME&gt;",   "region":   "&lt;REPLACE WITH THE BUCKET REGION&gt;",   "accessKeyId":   "&lt;REPLACE WITH YOUR ACCESS KEY ID&gt;",   "secretAccessKey": "&lt;REPLACE </pre>	<p>App developer, Data engineer</p>

Task	Description	Skills required
	<pre>WITH SECRET ACCESS KEY&gt;" }</pre> <ul style="list-style-type: none"><li>• <b>Response:</b> A successful request returns the created time and the asset ID of the newly created asset.</li></ul> <pre>{   "@id": "c89aa31c- ec4c-44ed-9e8c-16 47f19d7583" }</pre> <ul style="list-style-type: none"><li>• <b>Collection variable</b> <b>ASSET_ID:</b> Update the Postman collection variable ASSET_ID with the ID that was generated automatically by the EDC connector after creation.</li></ul>	



Task	Description	Skills required
Define the usage policy of the asset.	<p>An EDC data asset must be associated with clear usage policies. First, create the Policy Definition in the provider connector.</p> <p>The policy of company X is to allow participants of the data space to use the carbon-emissions footprint data.</p> <ul style="list-style-type: none"><li>• <b>Request Body:</b><ul style="list-style-type: none"><li>• <b>Connector:</b> Provider</li><li>• <b>Request:</b> Create Policy</li><li>• <b>Collection Variables</b> : Update the Policy Name variable with the name of the policy.</li></ul></li><li>• <b>Response:</b> A successful request returns the created time and the policy ID of the newly created policy. Update the collection variable POLICY_ID with the ID of the policy generated by the EDC connector after creation.</li></ul>	App developer, Data engineer

Task	Description	Skills required
Define an EDC Contract Offer for the asset and its usage policy.	<p>To allow other participants to request access to your data, offer it in a contract that specifies the usage conditions and permissions:</p> <ul style="list-style-type: none"> <li>• <b>Connector:</b> Provider</li> <li>• <b>Request:</b> Create Contract Definition</li> <li>• <b>Collection Variables:</b> Update the Contract Name variable with a name for the contract offer or definition.</li> </ul>	App developer, Data engineer

### Discover the assets and reach agreement on the defined contracts

Task	Description	Skills required
Request the data catalog shared by company X.	<p>As a data consumer in the data space, company Y first needs to discover the data that is being shared by other participants.</p> <p>In this basic setup, you can do this by asking the consumer connector to request the catalog of available assets from the provider connector directly.</p> <ul style="list-style-type: none"> <li>• <b>Connector:</b> Consumer</li> <li>• <b>Request:</b> Request Catalog</li> </ul>	App developer, Data engineer

Task	Description	Skills required
	<ul style="list-style-type: none"><li>• <b>Response:</b> All available data assets from the provider together with their attached usage policies. As a data consumer, look for the contract of your interest and update the following collection variables accordingly.<ul style="list-style-type: none"><li>• CONTRACT_OFFER_ID – The ID of the contract offer the consumer wants to negotiate</li><li>• ASSET_ID – The ID of the asset the consumer wants to negotiate</li><li>• PROVIDER_CLIENT_ID – The ID of the provider connector to negotiate with</li></ul></li></ul>	

Task	Description	Skills required
<p>Initiate a contract negotiation for the carbon-emissions intensity data from company X.</p>	<p>Now that you have identified the asset that you want to consume, initiate a contract negotiation process between the consumer and provider connectors.</p> <ul style="list-style-type: none"> <li>• <b>Connector:</b> Consumer</li> <li>• <b>Request:</b> Contract Negotiation</li> <li>• <b>Collection Variables:</b> Update the CONSUMER_CLIENT_ID variable with the ID of the consumer connector to negotiate with.</li> </ul> <p>The process might take some time before reaching the VERIFIED state.</p> <p>You can check the state of the Contract Negotiation and the corresponding Agreement ID by using the Get Negotiation request.</p>	<p>App developer, Data engineer</p>

### Consume the data by using the contract agreement

Task	Description	Skills required
<p>Consume data from HTTP endpoints.</p>	<p>(Option 1) To use HTTP data plane to consume data in the data space, you can use</p>	<p>App developer, Data engineer</p>

Task	Description	Skills required
	<p><a href="https://webhook.site">webhook.site</a> to emulate an HTTP server, and initiate the transfer process in the consumer connector:</p> <ul style="list-style-type: none"><li>• <b>Connector:</b> Consumer</li><li>• <b>Request:</b> Contract Negotiation</li><li>• <b>Collection Variables:</b> Update the Contract Agreement ID variable with the ID of the contract agreement generated by the EDC connector.</li><li>• <b>Request Body:</b> Update the request body to specify HTTP as a dataDestination alongside the webhook URL:</li></ul> <pre data-bbox="625 1155 1031 1711">{   "dataDestination": {     "type":     "HttpProxy"   },   "privateProperties": {     "receiver     HttpEndpoint":     "&lt;WEBHOOK URL&gt;"   } }</pre> <p>The connector will send the information necessary to</p>	

Task	Description	Skills required
	<p>download the file directly to the webhook URL.</p> <p>The received payload is similar to the following:</p> <pre data-bbox="625 457 1027 1528">{   "id": "dcc90391-3819-4b54-b401-1a005a029b78",   "endpoint": "http://consumer-tractusx-connector-dataplane.consumer:8081/api/public",   "authKey": "Authorization",   "authCode": "&lt;AUTH CODE YOU RECEIVE IN THE ENDPOINT&gt;",   "properties": {     "https://w3id.org/edc/v0.0.1/ns/cid": "vehicle-carbon-footprint-contract:4563abf7-5dc7-4c28-bc3d-97f45e32edac:b073669b-db20-4c83-82df-46b583c4c062"   } }</pre> <p>Use the received credentials to get the S3 asset that was shared by the provider.</p> <p>In this last step, you must send the request to the</p>	

Task	Description	Skills required
	consumer data plane (forward ports properly), as stated in the payload (endpoint).	

Task	Description	Skills required
Consume data from S3 buckets directly.	<p>(Option 2) Use Amazon S3 integration with the EDC connector, and directly point to the S3 bucket in the consumer infrastructure as a destination:</p> <ul style="list-style-type: none"><li>• <b>Request Body:</b> Update the request body to specify the S3 bucket as a dataDestination.</li></ul> <p>This should be the S3 bucket that you previously created for storing data received by the consumer.</p> <pre data-bbox="630 982 1029 1871">{   "dataDestination":   {     "type": "AmazonS3",     "bucketName":     "{{ REPLACE WITH THE DESTINATION BUCKET NAME }}",     "keyName":     "{{ REPLACE WITH YOUR OBJECT NAME }}",     "region":     "{{ REPLACE WITH THE BUCKET REGION }}",     "accessKeyId":     "{{ REPLACE WITH YOUR ACCESS KEY ID }}",     "secretAccessKey": "{{ REPLACE WITH SECRET ACCESS KEY }}"   } }</pre>	Data engineer, App developer



Task	Description	Skills required
	<pre> } } } </pre>	

## Troubleshooting

Issue	Solution
The connector might raise an issue about the certificate PEM format.	Concatenate the contents of each file to a single line by adding <code>\n</code> .

## Related resources

- [DSSC](#)
- [Building data spaces for sustainability use cases](#) (AWS Prescriptive Guidance strategy by [Think-it](#))
- [AWS for data spaces](#)
- [Tractus-X documentation](#)
- [DAPS](#)
- [Enabling data sharing through data spaces and AWS](#) (blog post)

## Additional information

### Data space specifications

#### Participants

Participant	Description of the company	Focus of the company
Company X	Operates a fleet of vehicles across Europe and South America to transport various goods.	Aims to make data-driven decisions to reduce its carbon-emissions footprint intensity.

Company Y	An environmental regulatory authority	Enforces environmental regulations and policies designed to monitor and mitigate the environmental impact of businesses and industries, including carbon-emissions intensity.
-----------	---------------------------------------	---

### *Business case*

Company X uses data space technology to share carbon footprint data with a compliance auditor, company Y, to evaluate and address the environmental impact of company X's logistics operations.

### *Data space authority*

The data space authority is a consortium of the organizations governing the data space. In this pattern, both company X and company Y form the governance body and represent a federated data space authority.

### *Data space components*

<b>Component</b>	<b>Chosen implementation</b>	<b>Additional information</b>
Dataset exchange protocol	Dataspace Protocol version 0.8	<ul style="list-style-type: none"> <li>• <a href="#">JSON-LD</a></li> <li>• <a href="#">Data Catalog Vocabulary (DCAT)</a></li> </ul>
Data space connector	Tractus-X EDC Connector version 0.4.1	<ul style="list-style-type: none"> <li>• <a href="#">EDC extensions</a></li> </ul>
Data exchange policies	Default USE Policy	<ul style="list-style-type: none"> <li>• <a href="#">Open Digital Rights Language (ODRL)</a></li> </ul>

### *Data space services*

<b>Service</b>	<b>Implementation</b>	<b>Additional information</b>
----------------	-----------------------	-------------------------------

## Identity service

[Dynamic Attribute Provisioning System \(DAPS\)](#)

"A Dynamic Attribute Provisioning System (DAPS) has the intent to ascertain certain attributes to organizations and connectors. Hence, third parties do not need to trust the latter **provided they trust the DAPS assertions.**"  
— DAPS

To focus on the connector's logic, the data space is deployed on an Amazon EC2 machine using Docker Compose.

## Discovery service

[Gaia-X Federated Catalogue](#)

"The Federated Catalogue constitutes an indexed repository of Gaia-X Self-Descriptions to enable the discovery and selection of Providers and their service offerings. The Self-Descriptions are the information given by Participants about themselves and about their services in the form of properties and claims." — Gaia-X Ecosystem Kickstarter

*Data to be exchanged***Data assets****Description****Format**

Carbon emissions data

Intensity values for different vehicle types in the specified

JSON file

region (Europe and South America) from the entire fleet of vehicles

### Data model

```
{
  "region": "string",
  "vehicles": [
    // Each vehicle type has its Gross Vehicle Weight (GVW) category and its emission
    // intensity in grams of CO2 per Tonne-Kilometer (g CO2 e/t-km) according to the "Well-
    // to-Wheel" (WTW) measurement.
    {
      "type": "string",
      "gross_vehicle_weight": "string",
      "emission_intensity": {
        "CO2": "number",
        "unit": "string"
      }
    }
  ]
}
```

### Tractus-X EDC connector

For documentation of each Tractus-X EDC parameter, see the [original values file](#).

The following table lists all of services, along with their corresponding exposed ports and endpoints for reference.

Service name	Port and path
Control plane	<ul style="list-style-type: none"> <li>• <b>management</b>: – Port: 8081 Path: /management</li> <li>• <b>control</b> – Port: 8083 Path: /control</li> <li>• <b>protocol</b> Port: 8084 Path: /api/v1/dsp</li> <li>• <b>metrics</b> – Port: 9090 Path: /metrics</li> </ul>

	<ul style="list-style-type: none"><li>• <b>observability</b> – Port: 8085 Path: /observability</li></ul>
Data plane	<b>default</b> – Port: 8080 Path: /api <b>public</b> – Port: 8081 Path: /api/data plane/control <b>proxy</b> – Port: 8186 Path: /proxy <b>metrics</b> – Port: 9090 Path: /metrics <b>observability</b> – Port: 8085 Path: /observability
Vault	Port: 8200
PostgreSQL	Port: 5432

## Using AWS Secrets Manager Manager

It's possible to use Secrets Manager instead of HashiCorp Vault as the secrets manager. To do so you, must use or build the AWS Secrets Manager EDC extension.

You will be responsible for creating and maintaining your own image, because Tractus-X doesn't provide support for Secrets Manager.

To accomplish that, you need to modify the build Gradle files of both the [control plane](#) and the [data plane](#) of the connector by introducing your AWS Secrets Manager EDC extension (see [this maven artifact](#) for an example), then build, maintain, and reference the Docker image.

For more insights on refactoring the Tractus-X connector Docker image, see [Refactor Tractus-X EDC Helm charts](#).

For simplicity purposes, we avoid to rebuilding the connector image in this pattern and use HashiCorp Vault.

# Set up language-specific sorting for Amazon Redshift query results using a scalar Python UDF

Created by Ethan Stark (AWS)

**Environment:** Production

**Technologies:** Analytics

**AWS services:** Amazon Redshift

## Summary

This pattern provides steps and sample code for using a scalar Python UDF (user-defined function) to set up case insensitive linguistic sorting for Amazon Redshift query results. It's necessary to use a scalar Python UDF because Amazon Redshift returns results based on binary UTF-8 ordering and doesn't support language-specific sorting. A Python UDF is non-SQL processing code that's based on a Python 2.7 program and runs in a data warehouse. You can run Python UDF code with a SQL statement in a single query. For more information, see the [Introduction to Python UDFs in Amazon Redshift](#) AWS Big Data Blog post.

The sample data in this pattern is based on the Turkish alphabet for demonstration purposes. The scalar Python UDF in this pattern is built to make the default query results of Amazon Redshift conform to the linguistic ordering of characters in the Turkish language. For more information, see *Turkish language example* in the *Additional information* section of this pattern. You can modify the scalar Python UDF in this pattern for other languages.

## Prerequisites and limitations

### Prerequisites

- Amazon Redshift [cluster](#) with a database, schema, and tables
- Amazon Redshift [user](#) with CREATE TABLE and CREATE FUNCTION permissions
- [Python 2.7](#) or later

### Limitations

The linguistic sorting used by the queries in this pattern is case insensitive.

# Architecture

## Technology stack

- Amazon Redshift
- Python UDF

## Tools

### AWS services

- [Amazon Redshift](#) is a managed petabyte-scale data warehouse service in the AWS Cloud. Amazon Redshift is integrated with your data lake, which enables you to use your data to acquire new insights for your business and customers.

### Other tools

- [Python \(UDFs\) user-defined functions](#) are functions that you can write in Python and then call in SQL statements.

## Epics

### Develop code to sort query results in linguistic order

Task	Description	Skills required
Create a table for your sample data.	<p>To create a table in Amazon Redshift and insert your sample data into the table, use the following SQL statements:</p> <pre>CREATE TABLE my_table (first_name varchar(30));  INSERT INTO my_table (first_name)</pre>	Data engineer

Task	Description	Skills required
	<p>VALUES</p> <ul style="list-style-type: none"><li>('ali'),</li><li>('Ali'),</li><li>('ırmak'),</li><li>('IRMAK'),</li><li>('irem'),</li><li>('İREM'),</li><li>('oğuz'),</li><li>('OĞUZ'),</li><li>('ömer'),</li><li>('ÖMER'),</li><li>('sedat'),</li><li>('SEDAT'),</li><li>('şule'),</li></ul> <p><b>Note:</b> The first names in the sample data include special characters from the Turkish alphabet. For more information about Turkish language considerations for this example, see <i>Turkish language example</i> in the <i>Additional information</i> section of this pattern.</p>	



Task	Description	Skills required
Check the default sorting of the sample data.	<p>To see the default sorting of your sample data in Amazon Redshift, run the following query:</p> <pre data-bbox="597 443 1027 600">SELECT first_name FROM my_table ORDER BY first_name;</pre> <p>The query returns the list of first names from the table that you created earlier:</p> <pre data-bbox="597 806 1027 1482">first_name ----- Ali IRMAK OĞUZ SEDAT ali irem oğuz sedat ÖMER ömer İREM ırmak ŞULE şule</pre> <p>The query results aren't in the correct order because the default binary UTF-8 ordering doesn't accommodate the linguistic ordering of the Turkish special characters.</p>	Data engineer

Task	Description	Skills required
Create a scalar Python UDF.	<p>To create a scalar Python UDF, use the following SQL code:</p> <pre data-bbox="597 346 1026 1869">CREATE OR REPLACE FUNCTION collate_sort (value varchar) RETURNS varchar IMMUTABLE AS \$\$ def sort_str(val):     import string      dictionary = {         'I': 'ı',         'ı': 'h~',         'İ': 'i',         'Ş': 's~',         'ş': 's~',         'Ğ': 'g~',         'ğ': 'g~',         'Ü': 'u~',         'ü': 'u~',         'Ö': 'o~',         'ö': 'o~',         'Ç': 'c~',         'ç': 'c~'     }      for key, value in dictionary.items() :         val = val.replace(key, value)      return val.lower ()      return sort_str( value)</pre>	Data engineer

Task	Description	Skills required
	<pre>\$\$ LANGUAGE plpythonu;</pre>	
Query the sample data.	<p>To query the sample data by using the Python UDF, run the following SQL query:</p> <pre>SELECT first_name FROM my_table ORDER BY collate_order(firs t_name);</pre> <p>The query now returns the sample data in Turkish linguistic order:</p> <pre>first_name ----- ali Ali ırmak IRMAK irem İREM oğuz OĞUZ ömer Ömer sedat SEDAT şule ŞULE</pre>	Data engineer

## Related resources

- [ORDER BY clause](#) (Amazon Redshift documentation)
- [Creating a scalar Python UDF](#) (Amazon Redshift documentation)

## Additional information

### Turkish language example

Amazon Redshift returns query results based on binary UTF-8 sort ordering, not language-specific sort ordering. This means that if you query an Amazon Redshift table containing Turkish characters, then the query results aren't sorted according to the linguistic ordering of the Turkish language. The Turkish language contains six special characters (ç, ı, ğ, ö, ş, and ü) that don't appear in the Latin alphabet. These special characters are placed at the end of a sorted result set based on binary UTF-8 ordering, as the following table shows.

Binary UTF-8 ordering	Turkish linguistic ordering
a	a
b	b
c	c
d	ç (*)
e	d
f	e
g	f
h	g
i	ğ (*)
j	h
k	ı (*)
l	i
m	j
n	k
o	l

p	m
r	n
s	o
t	ö (*)
u	p
v	r
y	s
z	ş (*)
ç (*)	t
ğ (*)	u
ı (*)	ü (*)
ö (*)	v
ş (*)	y
ü (*)	z

**Note:** The asterisk (\*) indicates a special character in the Turkish language.

As the table above illustrates, special character ç is between c and d in Turkish linguistic ordering, but appears after z in binary UTF-8 ordering. The scalar Python UDF in this pattern uses the following character replacement dictionary to replace the Turkish special characters with corresponding Latin-equivalent characters.

Turkish special character	Latin-equivalent character
ç	c~
ı	h~

ğ	g~
ö	o~
ş	s~
ü	u~

**Note:** A tilde (~) character is appended to the end of the Latin characters that replace their corresponding Turkish special characters.

### Modify a scalar Python UDF function

To modify the scalar Python UDF function from this pattern so that the function accepts a locale parameter and supports a multiple transaction dictionary, use the following SQL code:

```
CREATE OR REPLACE FUNCTION collate_sort (value varchar, locale varchar)
RETURNS varchar
IMMUTABLE
AS
$$
def sort_str(val):
    import string
    # Turkish Dictionary
    if locale == 'tr-TR':
        dictionary = {
            'I': 'ı',
            'ı': 'h~',
            'İ': 'i',
            'Ş': 's~',
            'ş': 's~',
            'Ğ': 'g~',
            'ğ': 'g~',
            'Ü': 'u~',
            'ü': 'u~',
            'Ö': 'o~',
            'ö': 'o~',
            'Ç': 'c~',
            'ç': 'c~'
        }
    # German Dictionary
    if locale == 'de-DE':
```

```
        dictionary = {
            ....
            ....
        }

        for key, value in dictionary.items():
            val = val.replace(key, value)

        return val.lower()

    return sort_str(value)

$$ LANGUAGE plpythonu;
```

The following example code shows how to query the modified Python UDF:

```
SELECT first_name FROM my_table ORDER BY collate_order(first_name, 'tr-TR');
```

# Subscribe a Lambda function to event notifications from S3 buckets in different AWS Regions

Created by Suresh Konathala, Andrew Preston, and Arindom Sarkar

**Environment:** Production

**Technologies:** Analytics

**AWS services:** AWS Lambda;  
Amazon S3; Amazon SNS;  
Amazon SQS

## Summary

[Amazon Simple Storage Service \(Amazon S3\) Event Notifications](#) publishes notifications for certain events in your S3 bucket (for example, object created events, object removal events, or restore object events). You can use an AWS Lambda function to process these notifications according to your application's requirements. However, the Lambda function can't directly subscribe to notifications from S3 buckets that are hosted in different AWS Regions.

This pattern's approach deploys a [fanout scenario](#) to process Amazon S3 notifications from cross-Region S3 buckets by using an Amazon Simple Notification Service (Amazon SNS) topic for each Region. These Regional SNS topics send the Amazon S3 event notifications to an Amazon Simple Queue Service (Amazon SQS) queue in a central Region that also contains your Lambda function. The Lambda function subscribes to this SQS queue and processes the event notifications according to your organization's requirements.

## Prerequisites and limitations

### Prerequisites

- An active AWS account.
- Existing S3 buckets in multiple Regions, including a central Region to host the Amazon SQS queue and Lambda function.
- AWS Command Line Interface (AWS CLI), installed and configured. For more information about this, see [Installing, updating, and uninstalling the AWS CLI](#) in the AWS CLI documentation.
- Familiarity with the fanout scenario in Amazon SNS. For more information about this, see [Common Amazon SNS scenarios](#) in the Amazon SNS documentation.



# Architecture

The following diagram shows the architecture for this pattern's approach.

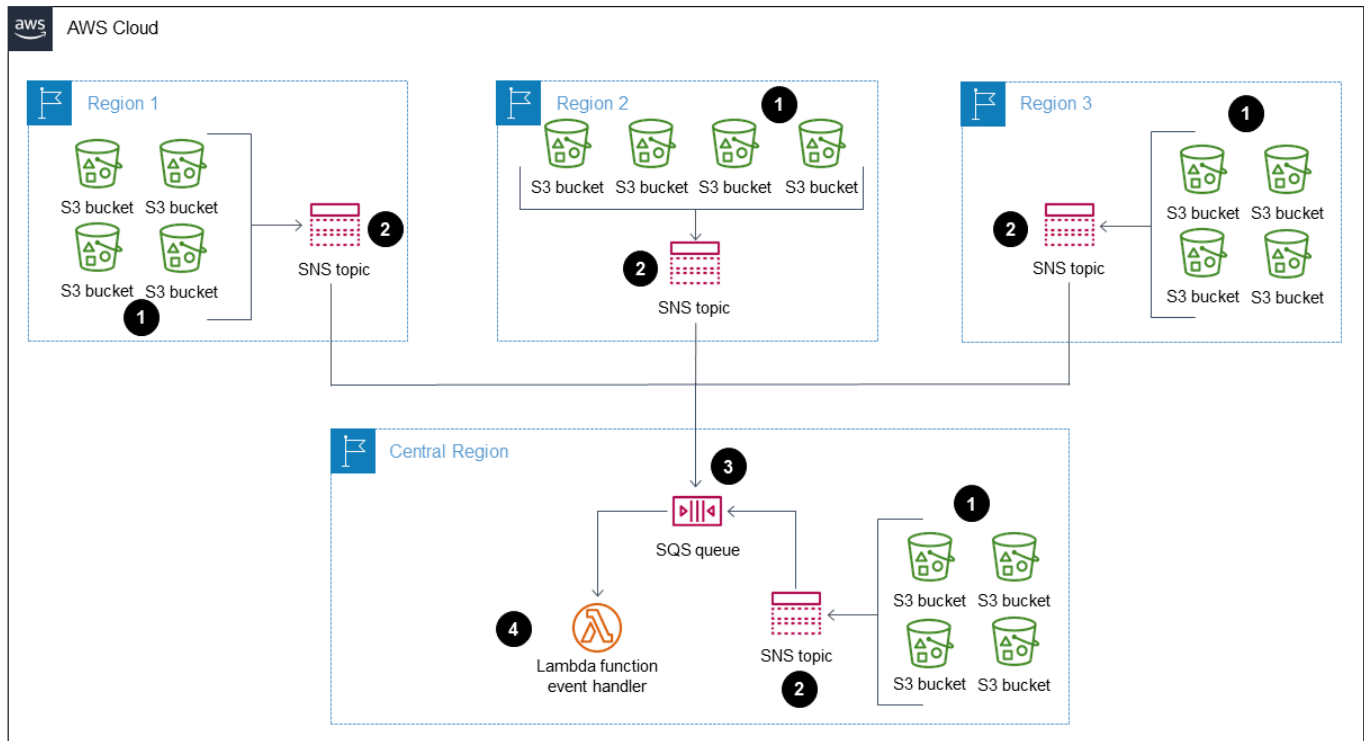

The diagram shows the following workflow:

1. Amazon S3 sends event notifications about S3 buckets (for example, object created, object removed, or object restored) to an SNS topic in the same Region.
2. The SNS topic publishes the event to an SQS queue in the central Region.
3. The SQS queue is configured as the event source for your Lambda function and buffers the event messages for the Lambda function.
4. The Lambda function polls the SQS queue for messages and processes the Amazon S3 event notifications according to your application's requirements.

## Technology stack

- Lambda
- Amazon SNS

- Amazon SQS
- Amazon S3

## Tools

- [AWS CLI](#) – The AWS Command Line Interface (AWS CLI) is an open-source tool for interacting with AWS services through commands in your command-line shell. With minimal configuration, you can run AWS CLI commands that implement functionality equivalent to that provided by the browser-based AWS Management Console from a command prompt.
- [AWS CloudFormation](#) – AWS CloudFormation helps you model and set up your AWS resources, provision them quickly and consistently, and manage them throughout their lifecycle. You can use a template to describe your resources and their dependencies, and launch and configure them together as a stack, instead of managing resources individually. You can manage and provision stacks across multiple AWS accounts and AWS Regions.
- [AWS Lambda](#) – AWS Lambda is a compute service that supports running code without provisioning or managing servers. Lambda runs your code only when needed and scales automatically, from a few requests per day to thousands per second. You pay only for the compute time that you consume—there is no charge when your code is not running.
- [Amazon SNS](#) – Amazon Simple Notification Service (Amazon SNS) coordinates and manages the delivery or sending of messages between publishers and clients, including web servers and email addresses. Subscribers receive all messages published to the topics to which they subscribe, and all subscribers to a topic receive the same messages.
- [Amazon SQS](#) – Amazon Simple Queue Service (Amazon SQS) offers a secure, durable, and available hosted queue that lets you integrate and decouple distributed software systems and components. Amazon SQS supports both standard and FIFO queues.

## Epics

### Create the SQS queue and Lambda function in your central Region

Task	Description	Skills required
Create an SQS queue with a Lambda trigger.	Sign in to the AWS Management Console and use the instructions from	AWS DevOps, Cloud architect

Task	Description	Skills required
	<p>the tutorial <a href="#">Using Lambda with Amazon SQS</a> in the AWS Lambda documentation to create the following resources in your central Region:</p> <ul style="list-style-type: none"> <li>• A Lambda execution role</li> <li>• A Lambda function to process the Amazon S3 events</li> <li>• An SQS queue</li> </ul> <p><b>Note:</b> Make sure that you configure the SQS queue as the event source for your Lambda function.</p>	

### Create an SNS topic and set up event notifications for the S3 buckets in each required Region

Task	Description	Skills required
<p>Create an SNS topic to receive Amazon S3 event notifications.</p>	<p>Create an SNS topic in a Region that you want to receive Amazon S3 event notifications from. For more information about this, see <a href="#">Creating an SNS topic</a> in the Amazon SNS documentation.</p> <p><b>Important:</b> Make sure that you record your SNS topic's Amazon Resource Name (ARN).</p>	<p>AWS DevOps, Cloud architect</p>

Task	Description	Skills required
Subscribe the SNS topic to the central SQS queue.	Subscribe your SNS topic to the SQS queue hosted by your central Region. For more information about this, see <a href="#">Subscribing to an SNS topic</a> in the Amazon SNS documentation.	AWS DevOps, Cloud architect

Task	Description	Skills required
Update the SNS topic's access policy.	<ol style="list-style-type: none"><li>1. Open the Amazon SNS console, choose <b>Topics</b>, and then choose the SNS topic that you created earlier.</li><li>2. Choose <b>Edit</b> and then expand the <b>Access policy - optional</b> section.</li><li>3. Attach the following access policy to your SNS topic to allow <code>sns:publish</code> permission for Amazon S3 and then choose <b>Save</b>:</li></ol> <pre data-bbox="592 926 1027 1764">{   "Version": "2012-10-17",   "Statement": [     {       "Sid": "0",       "Effect": "Allow",       "Principal": {         "Service": "s3.amazonaws.com"       },       "Action": "sns:Publish",       "Resource": "arn:aws:sns:us-west-2::s3Events-SNSTopic-us-west-2"     }   ] }</pre>	AWS DevOps, Cloud architect

Task	Description	Skills required
Set up notifications for each S3 bucket in the Region.	<p>Set up event notifications for each S3 bucket in the Region. For more information about this, see <a href="#">Enabling and configuring event notifications using the Amazon S3 console</a> in the Amazon S3 documentation.</p> <p><b>Note:</b> In the <b>Destination</b> section, choose <b>SNS topic</b> and specify the ARN of the SNS topic that you created earlier.</p>	AWS DevOps, Cloud architect
Repeat this epic for all required Regions.	<p><b>Important:</b> Repeat the tasks in this epic for each Region that you want to receive Amazon S3 event notifications from, including your central Region.</p>	AWS DevOps, Cloud architect

## Related resources

- [Configuring an access policy](#) (Amazon SQS documentation)
- [Configuring an SQS queue as an event source](#) (AWS Lambda documentation)
- [Configuring an SQS queue to initiate a Lambda function](#) (Amazon SQS documentation)
- [AWS::Lambda::Function resource](#) (AWS CloudFormation documentation)

# Three AWS Glue ETL job types for converting data to Apache Parquet

Created by Adnan Alvee (AWS), Karthikeyan Ramachandran, and Nith Govindasivan (AWS)

**Environment:** PoC or pilot

**Technologies:** Analytics

**Workload:** All other workloads

**AWS services:** AWS Glue

## Summary

On the Amazon Web Services (AWS) Cloud, AWS Glue is a fully managed extract, transform, and load (ETL) service. AWS Glue makes it cost-effective to categorize your data, clean it, enrich it, and move it reliably between various data stores and data streams.

This pattern provides different job types in AWS Glue and uses three different scripts to demonstrate authoring ETL jobs.

You can use AWS Glue to write ETL jobs in a Python shell environment. You can also create both batch and streaming ETL jobs by using Python (PySpark) or Scala in a managed Apache Spark environment. To get you started with authoring ETL jobs, this pattern focuses on batch ETL jobs using Python shell, PySpark, and Scala. Python shell jobs are meant for workloads requiring lesser compute power. The managed Apache Spark environment is meant for workloads requiring high compute power.

Apache Parquet is built to support efficient compression and encoding schemes. It can speed up your analytics workloads because it stores data in a columnar fashion. Converting data to Parquet can save you storage space, cost, and time in the longer run. To learn more about Parquet, see the blog post [Apache Parquet: How to be a hero with the open-source columnar data format](#).

## Prerequisites and limitations

### Prerequisites

- AWS Identity and Access Management (IAM) role (If you don't have a role, see the *Additional information* section.)

# Architecture

## Target technology stack

- AWS Glue
- Amazon Simple Storage Service (Amazon S3)
- Apache Parquet

## Automation and scale

- [AWS Glue workflows](#) support full automation of an ETL pipeline.
- You can change the number of data processing units (DPUs), or worker types, to scale horizontally and vertically.

# Tools

## AWS services

- [Amazon Simple Storage Service \(Amazon S3\)](#) is a cloud-based object storage service that helps you store, protect, and retrieve any amount of data.
- [AWS Glue](#) is a fully managed ETL service for categorizing, cleaning, enriching, and moving your data between various data stores and data streams.

## Other tools

- [Apache Parquet](#) is an open-source column-oriented data file format designed for storage and retrieval.

## Configuration

Use the following settings for configuring the compute power of AWS Glue ETL. To reduce costs, use the minimal settings when you run the workload that is provided in this pattern.

- **Python shell** – You can use 1 DPU to utilize 16 GB of memory or 0.0625 DPU to utilize 1 GB of memory. This pattern uses 0.0625 DPU, which is the default in the AWS Glue console.



- **Python or Scala for Spark** – If you choose the Spark-related job types in the console, AWS Glue by default uses 10 workers and the G.1X worker type. This pattern uses two workers, which is the minimum number allowed, with the standard worker type, which is sufficient and cost effective.

The following table displays the different AWS Glue worker types for the Apache Spark environment. Because a Python shell job does not use the Apache Spark environment to run Python, it is not included in the table.

	Standard	G.1X	G.2X
vCPU	4	4	8
Memory	16 GB	16 GB	32 GB
Disk space	50 GB	64 GB	128 GB
Executor per worker	2	1	1

## Code

For the code that is used in this pattern, including the IAM role and parameter configuration, see the *Additional information* section.

## Epics

### Upload the data

Task	Description	Skills required
Upload the data into a new or existing S3 bucket.	Create or use an existing S3 bucket in your account. Upload the <code>sample_data.csv</code> file from the <i>Attachments</i> section, and note the S3 bucket and prefix location.	General AWS

## Create and run the AWS Glue job

Task	Description	Skills required
Create the AWS Glue job.	Under the ETL section of the AWS Glue console, add an AWS Glue job. Select the appropriate job type, AWS Glue version, and the corresponding DPU/Worker type and number of workers. For details, see the <i>Configuration</i> section.	Developer, cloud or data
Change the input and output locations.	Copy the code corresponding to your AWS Glue job, and change the input and output location that you noted in the <b>Upload the data</b> epic.	Developer, cloud or data
Configure the parameters.	<p>You can use the snippets provided in the <i>Additional information</i> section to set parameters for your ETL job. AWS Glue uses four argument names internally:</p> <ul style="list-style-type: none"> <li>• --conf</li> <li>• --debug</li> <li>• --mode</li> <li>• --JOB_NAME</li> </ul> <p>The --JOB_NAME parameter must be explicitly entered on the AWS Glue console. Choose <b>Jobs, Edit Job, Security configuration, script</b></p>	Developer, cloud or data

Task	Description	Skills required
	<p><b>libraries, and job parameters (optional).</b> Enter <code>--JOB_NAME</code> as the key and provide a value. You can also use the AWS Command Line Interface (AWS CLI) or the AWS Glue API to set this parameter. The <code>--JOB_NAME</code> parameter is used by Spark and is not needed in a Python shell environment job.</p> <p>You must add <code>--</code> before every parameter name; otherwise, the code will not work. For example, for the code snippets, the location parameters must be invoked by <code>--input_loc</code> and <code>--output_loc</code>.</p>	
Run the ETL job.	Run your job and check the output. Note how much space was reduced from the original file.	Developer, cloud or data

## Related resources

### References

- [Apache Spark](#)
- [AWS Glue: How it works](#)
- [AWS Glue pricing](#)

## Tutorials and videos

- [What is AWS Glue?](#)

## Additional information

### IAM role

When you create the AWS Glue jobs, you can use either an existing IAM role that has the permissions shown in the following code snippet or a new role.

To create a new role, use the following YAML code.

```
# (c) 2022 Amazon Web Services, Inc. or its affiliates. All Rights Reserved. This AWS
Content is provided subject to the terms of the AWS Customer
# Agreement available at https://aws.amazon.com/agreement/ or other written agreement
between Customer and Amazon Web Services, Inc.

AWSTemplateFormatVersion: "2010-09-09"

Description: This template will setup IAM role for AWS Glue service.

Resources:
  rGlueRole:
    Type: AWS::IAM::Role
    Properties:
      AssumeRolePolicyDocument:
        Version: "2012-10-17"
        Statement:
          - Effect: "Allow"
            Principal:
              Service:
                - "glue.amazonaws.com"
            Action:
              - "sts:AssumeRole"
      ManagedPolicyArns:
        - arn:aws:iam::aws:policy/service-role/AWSGlueServiceRole
      Policies:
        - PolicyName: !Sub "${AWS::StackName}-s3-limited-read-write-inline-policy"
          PolicyDocument:
            Version: "2012-10-17"
            Statement:
              - Effect: Allow
```

```

        Action:
          - "s3:PutObject"
          - "s3:GetObject"
        Resource: "arn:aws:s3:::*/*"
    Tags:
      - Key   : "Name"
        Value : !Sub "${AWS::StackName}"

Outputs:
  oGlueRoleName:
    Description: AWS Glue IAM role
    Value:
      Ref: rGlueRole
    Export:
      Name: !Join [ ":", [ !Ref "AWS::StackName", rGlueRole ] ]

```

## AWS Glue Python Shell

The Python code uses the Pandas and PyArrow libraries to convert data to Parquet. The Pandas library is already available. The PyArrow library is downloaded when you run the pattern, because it is a one-time run. You can use wheel files to convert PyArrow to a library and provide the file as a library package. For more information about packaging wheel files, see [Providing your own Python library](#).

### *AWS Glue Python shell parameters*

```

from awsglue.utils import getResolvedOptions

args = getResolvedOptions(sys.argv, ["input_loc", "output_loc"])

```

### *AWS Glue Python shell code*

```

from io import BytesIO
import pandas as pd
import boto3
import os
import io
import site
from importlib import reload
from setuptools.command import easy_install
install_path = os.environ['GLUE_INSTALLATION']
easy_install.main( ["--install-dir", install_path, "pyarrow"] )

```

```
reload(site)
import pyarrow

input_loc = "bucket-name/prefix/sample_data.csv"
output_loc = "bucket-name/prefix/"

input_bucket = input_loc.split('/', 1)[0]
object_key = input_loc.split('/', 1)[1]

output_loc_bucket = output_loc.split('/', 1)[0]
output_loc_prefix = output_loc.split('/', 1)[1]

s3 = boto3.client('s3')
obj = s3.get_object(Bucket=input_bucket, Key=object_key)
df = pd.read_csv(io.BytesIO(obj['Body'].read()))

parquet_buffer = BytesIO()
s3_resource = boto3.resource('s3')
df.to_parquet(parquet_buffer, index=False)
s3_resource.Object(output_loc_bucket, output_loc_prefix + 'data' +
    '.parquet').put(Body=parquet_buffer.getvalue())
```

## AWS Glue Spark job with Python

To use an AWS Glue Spark job type with Python, choose **Spark** as the job type. Choose **Spark 3.1, Python 3 with improved job startup time (Glue Version 3.0)** as the AWS Glue version.

### *AWS Glue Python parameters*

```
from awsglue.utils import getResolvedOptions

args = getResolvedOptions(sys.argv, ["JOB_NAME", "input_loc", "output_loc"])
```

### *AWS Glue Spark job with Python code*

```
import sys
from pyspark.context import SparkContext
```

```
from awsglue.context import GlueContext
from awsglue.transforms import *
from awsglue.dynamicframe import DynamicFrame
from awsglue.utils import getResolvedOptions
from awsglue.job import Job

sc = SparkContext()
glueContext = GlueContext(sc)
spark = glueContext.spark_session
job = Job(glueContext)

input_loc = "bucket-name/prefix/sample_data.csv"
output_loc = "bucket-name/prefix/"

inputDyf = glueContext.create_dynamic_frame_from_options(\
    connection_type = "s3", \
    connection_options = {
        "paths": [input_loc]}, \
    format = "csv",
    format_options={
        "withHeader": True,
        "separator": ",",
    })

outputDF = glueContext.write_dynamic_frame.from_options(\
    frame = inputDyf, \
    connection_type = "s3", \
    connection_options = {"path": output_loc \
        }, format = "parquet")
```

For a large number of compressed big files (for example, 1,000 files that are each about 3 MB), use the `compressionType` parameter with the `recurse` parameter to read all the files that are available within the prefix, as shown in the following code.

```
input_loc = "bucket-name/prefix/"
output_loc = "bucket-name/prefix/"

inputDyf = glueContext.create_dynamic_frame_from_options(
    connection_type = "s3",
    connection_options = {"paths": [input_loc],
        "compressionType": "gzip", "recurse" : "True",
```

```
        },  
        format = "csv",  
        format_options={"withHeader": True,"separator": ","}  
    )
```

For a large number of compressed small files (for example, 1,000 files that are each about 133 KB), use the `groupFiles` parameter, along with both the `compressionType` and the `recurse` parameters. The `groupFiles` parameter groups small files into multiple big files, and the `groupSize` parameter controls the grouping to the specified size in bytes (for example, 1 MB). The following code snippet provides an example of using these parameters within the code.

```
input_loc = "bucket-name/prefix/"  
output_loc = "bucket-name/prefix/"  
  
inputDyf = glueContext.create_dynamic_frame_from_options(  
    connection_type = "s3",  
    connection_options = {"paths": [input_loc],  
                           "compressionType":"gzip","recurse" : "True",  
                           "groupFiles" : "inPartition",  
                           "groupSize" : "1048576",  
                           },  
    format = "csv",  
    format_options={"withHeader": True,"separator": ","}  
)
```

Without any change in the worker nodes, these settings enable the AWS Glue job to read multiple files (large or small, with or without compression) and write them to the target in Parquet format.

## AWS Glue Spark job with Scala

To use an AWS Glue Spark job type with Scala, choose **Spark** as the job type and **Language** as **Scala**. Choose **Spark 3.1, Scala 2 with improved job startup time (Glue Version 3.0)** as the AWS Glue version. To save on storage space, the following AWS Glue with Scala sample also uses the `applyMapping` feature to convert data types.

### *AWS Glue Scala parameters*

```
import com.amazonaws.services.glue.util.GlueArgParser val args =  
    GlueArgParser.getResolvedOptions(sysArgs, Seq("JOB_NAME", "inputLoc",  
    "outputLoc")).toArray)
```



## AWS Glue Spark job with Scala code

```
import com.amazonaws.services.glue.GlueContext
import com.amazonaws.services.glue.MappingSpec
import com.amazonaws.services.glue.DynamicFrame
import com.amazonaws.services.glue.errors.CallSite
import com.amazonaws.services.glue.util.GlueArgParser
import com.amazonaws.services.glue.util.Job
import com.amazonaws.services.glue.util.JsonOptions
import org.apache.spark.SparkContext
import scala.collection.JavaConverters._

object GlueScalaApp {
  def main(sysArgs: Array[String]) {

    @transient val spark: SparkContext = SparkContext.getOrCreate()
    val glueContext: GlueContext = new GlueContext(spark)

    val inputLoc = "s3://bucket-name/prefix/sample_data.csv"
    val outputLoc = "s3://bucket-name/prefix/"

    val readCSV = glueContext.getSource("csv", JsonOptions(Map("paths" ->
Set(inputLoc))))).getDynamicFrame()

    val applyMapping = readCSV.applyMapping(mappings = Seq(("_c0", "string", "date",
"string"), ("_c1", "string", "sales", "long"),
("_c2", "string", "profit", "double")), caseSensitive = false)

    val formatPartition = applyMapping.toDF().coalesce(1)

    val dynamicFrame = DynamicFrame(formatPartition, glueContext)

    val dataSink = glueContext.getSinkWithFormat(
      connectionType = "s3",
      options = JsonOptions(Map("path" -> outputLoc)),
      transformationContext = "dataSink", format =
"parquet").writeDynamicFrame(dynamicFrame)
  }
}
```

## Attachments

To access additional content that is associated with this document, unzip the following file:

[attachment.zip](#)

# Visualize Amazon Redshift audit logs using Amazon Athena and Amazon QuickSight

Created by Sanket Sirsikar (AWS) and Gopal Krishna Bhatia (AWS)

**Environment:** PoC or pilot

**Technologies:** Analytics; Big data; Data lakes

**AWS services:** Amazon Athena; Amazon Redshift; Amazon S3; Amazon QuickSight

## Summary

Security is an integral part of database operations on the Amazon Web Services (AWS) Cloud. Your organization should ensure that it monitors database user activities and connections to detect potential security incidents and risks. This pattern helps you monitor your databases for security and troubleshooting purposes, which is a process known as database auditing.

This pattern provides a SQL script that automates the creation of an Amazon Athena table and views for a reporting dashboard in Amazon QuickSight that helps you audit Amazon Redshift logs. This ensures that users responsible for monitoring database activities have convenient access to data security features.

## Prerequisites and limitations

### Prerequisites

- An active AWS account.
- An existing Amazon Redshift cluster. For more information about this, see [Create an Amazon Redshift cluster](#) in the Amazon Redshift documentation.
- Access to an existing Athena workgroup. For more information, see [How workgroups work](#) in the Amazon Athena documentation.
- An existing Amazon Simple Storage Service (Amazon S3) source bucket with the required AWS Identity and Access Management (IAM) permissions. For more information, see [Bucket permissions for Amazon Redshift audit logging](#) from [Database audit logging](#) in the Amazon Redshift documentation.

## Architecture

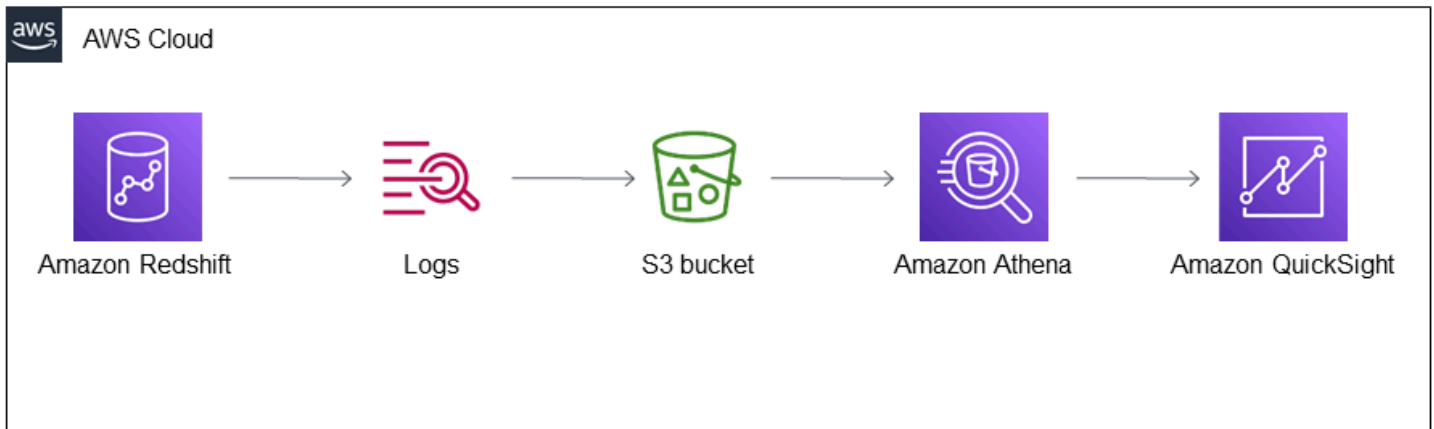

### Technology stack

- Athena
- Amazon Redshift
- Amazon S3
- QuickSight

### Tools

- [Amazon Athena](#) – Athena is an interactive query service that makes it easy to analyze data in Amazon S3 using standard SQL.
- [Amazon QuickSight](#) – QuickSight is a scalable, serverless, embeddable, machine learning-powered business intelligence (BI) service.
- [Amazon Redshift](#) – Amazon Redshift is an enterprise-level, petabyte scale, fully managed data warehousing service.
- [Amazon S3](#) – Amazon Simple Storage Service (Amazon S3) is storage for the internet.

## Epics

### Configure the Amazon Redshift cluster

Task	Description	Skills required
<p>Enable audit logging for the Amazon Redshift cluster.</p>	<ol style="list-style-type: none"> <li>1. Sign in to the AWS Management Console, open the Amazon Redshift console, choose <b>CLUSTERS</b>, and then choose the cluster that you want to enable logging for.</li> <li>2. Choose the <b>Properties</b> tab and then enable auditing by following the instructions from <a href="#">Configuring auditing using the console</a> in the Amazon Redshift documentation.</li> </ol>	<p>DBA, Data engineer</p>
<p>Enable logging in the Amazon Redshift cluster parameter group.</p>	<p>You can enable auditing of connection logs, user logs, and user activity logs at the same time by using the AWS Management Console, the Amazon Redshift API reference, or AWS Command Line Interface (AWS CLI).</p> <p>For auditing of user activity logs, you must enable the <code>enable_user_activity_logging</code> database parameter. If you only enable the audit logging feature but not the associated parameter</p>	<p>DBA, Data engineer</p>

Task	Description	Skills required
	<p>, the database audit logs the logging information for the connection and user logs but not for the user activity logs. The <code>enable_user_activity_logging</code> parameter is not enabled by default, but you can enable it by changing it from <code>false</code> to <code>true</code>.</p> <p><b>Important:</b> You need to create a new cluster parameter group with the <code>user_activity_logging</code> parameter enabled and attach it to your Amazon Redshift cluster. For more information about this, see <a href="#">Modifying a cluster</a> in the Amazon Redshift documentation.</p> <p>For more information about this task, see <a href="#">Amazon Redshift parameter groups</a> and <a href="#">Configuring auditing using the console</a> in the Amazon Redshift documentation.</p>	

Task	Description	Skills required
Configure S3 bucket permissions for Amazon Redshift cluster logging.	<p>When you enable logging, Amazon Redshift collects logging information and uploads it to log files stored in an S3 bucket. You can use an existing S3 bucket or create a new bucket.</p> <p><b>Important:</b> Make sure that Amazon Redshift has the required IAM permissions to access the S3 bucket. For more information about this, see <a href="#">Bucket permissions for Amazon Redshift audit logging</a> from <a href="#">Database audit logging</a> in the Amazon Redshift documentation.</p>	DBA, Data engineer

### Create the Athena table and views

Task	Description	Skills required
Create the Athena table and views to query Amazon Redshift audit log data from the S3 bucket.	<p>Open the Amazon Athena console and use the data definition language (DDL) query from the <code>AuditLogging.sql</code> SQL script (attached) to create the table and views for user activity logs, user logs, and connection logs.</p> <p>For more information and instructions, see the <a href="#">Create</a></p>	Data engineer

Task	Description	Skills required
	<a href="#">tables and run queries</a> tutorial from the Amazon Athena Workshop.	

## Set up log monitoring in the QuickSight dashboard

Task	Description	Skills required
Create a QuickSight dashboard using Athena as the data source.	Open the Amazon QuickSight console and create a QuickSight dashboard by following the instructions in the <a href="#">Visualize with QuickSight using Athena</a> tutorial from the Amazon Athena Workshop.	DBA, Data engineer

## Related resources

- [Create tables and run queries in Athena](#)
- [Visualize with QuickSight using Athena](#)

## Attachments

To access additional content that is associated with this document, unzip the following file: [attachment.zip](#)



# Visualize IAM credential reports for all AWS accounts using Amazon QuickSight

Created by Parag Nagwekar (AWS) and Arun Chandapillai (AWS)

<b>Code repository:</b> <a href="#">Get Organizational wide visibility of your IAM Credential Reports</a>	<b>Environment:</b> Production	<b>Technologies:</b> Analytics; Advisory; Management & governance; Security, identity, compliance
<b>Workload:</b> All other workloads	<b>AWS services:</b> Amazon Athena; AWS CloudFormation; Amazon EventBridge; AWS Identity and Access Management; Amazon QuickSight	

## Summary

**Warning:** IAM users have long-term credentials, which presents a security risk. To help mitigate this risk, we recommend that you provide these users with only the permissions they require to perform the task and that you remove these users when they are no longer needed.

You can use AWS Identity and Access Management (IAM) credential reports to help you meet the security, auditing, and compliance requirements of your organization. [Credential reports](#) provide a list of all the users in your AWS accounts and show the status of their credentials, such as passwords, access keys, and multi-factor authentication (MFA) devices. You can use credential reports for multiple AWS accounts managed by [AWS Organizations](#).

This pattern includes steps and code to help you create and share IAM credential reports for all the AWS accounts in your organization by using Amazon QuickSight dashboards. You can share the dashboards with stakeholders in your organization. The reports can help your organization achieve the following targeted business outcomes:

- Identify security incidents related to IAM users

- Track real-time migration of IAM users to single sign-on (SSO) authentication
- Track AWS Regions accessed by IAM users
- Stay compliant
- Share information with other stakeholders

## Prerequisites and limitations

### Prerequisites

- An active AWS account
- An [organization](#) with member accounts
- An [IAM role](#) with permissions to access accounts in Organizations
- AWS Command Line Interface (AWS CLI) version 2, [installed](#) and [configured](#)
- A [subscription](#) to [Amazon QuickSight Enterprise edition](#)

## Architecture

### Technology stack

- Amazon Athena
- Amazon EventBridge
- Amazon QuickSight
- Amazon Simple Storage Service (Amazon S3)
- AWS Glue
- AWS Identity and Access Management (IAM)
- AWS Lambda
- AWS Organizations

### Target architecture

The following diagram shows an architecture for setting up a workflow that captures IAM credential report data from multiple AWS accounts.

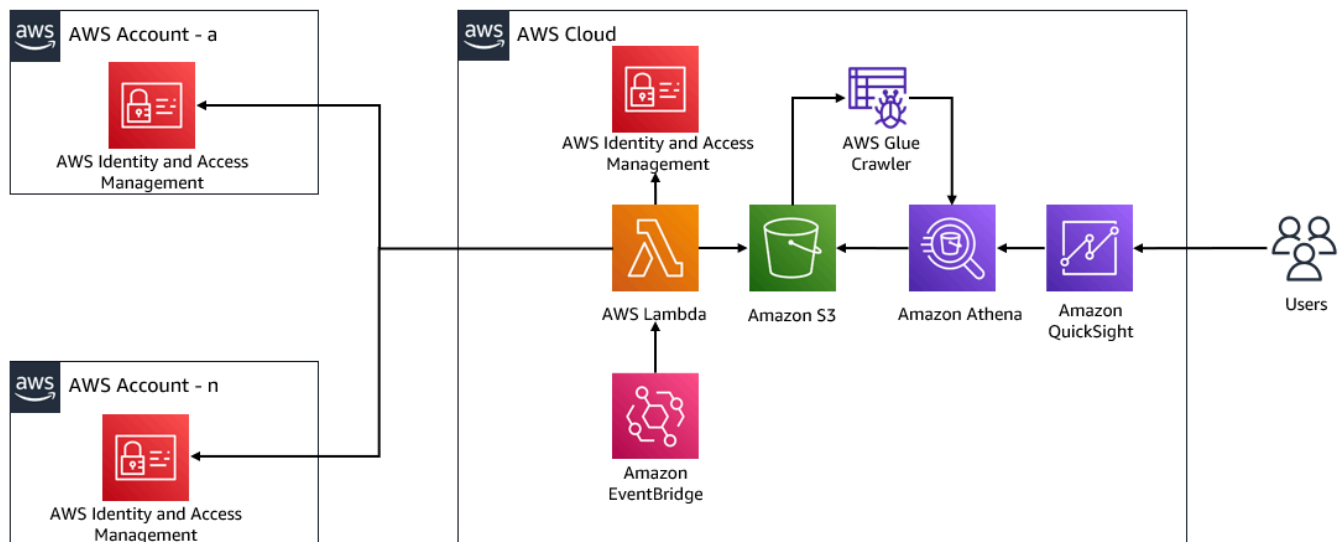

1. EventBridge invokes a Lambda function daily.
2. The Lambda function assumes an IAM role in every AWS account across the organization. Then, the function creates the IAM credentials report and stores the report data in a centralized S3 bucket. You must enable encryption and deactivate public access on the S3 bucket.
3. An AWS Glue crawler crawls the S3 bucket daily and updates the Athena table accordingly.
4. QuickSight imports and analyzes the data from the credential report and builds a dashboard that can be visualized by and shared with stakeholders.

## Tools

### AWS services

- [Amazon Athena](#) is an interactive query service that makes it easy to analyze data in Amazon S3 by using standard SQL.
- [Amazon EventBridge](#) is a serverless event bus service that helps you connect your applications with real-time data from a variety of sources. For example, Lambda functions, HTTP invocation endpoints using API destinations, or event buses in other AWS accounts.
- [Amazon QuickSight](#) is a cloud-scale business intelligence (BI) service that helps you visualize, analyze, and report your data in a single dashboard.
- [AWS Identity and Access Management \(IAM\)](#) helps you securely manage access to your AWS resources by controlling who is authenticated and authorized to use them.

- [AWS Lambda](#) is a compute service that helps you run code without needing to provision or manage servers. It runs your code only when needed and scales automatically, so you pay only for the compute time that you use.

## Code

The code for this pattern is available in the GitHub [getiamcredsreport-allaccounts-org](#) repository. You can use the code from this repository to create IAM credential reports across AWS accounts in Organizations and store them in a central location.

## Epics

### Set up the infrastructure

Task	Description	Skills required
Set up Amazon QuickSight Enterprise edition.	<ol style="list-style-type: none"> <li>1. Activate the Amazon QuickSight Enterprise edition in your AWS account. For more information, see <a href="#">Managing user access inside Amazon QuickSight</a> in the QuickSight documentation.</li> <li>2. To grant dashboard permissions, get the Amazon Resource Name (ARN) of the QuickSight users.</li> </ol>	AWS administrator, AWS DevOps, Cloud administrator, Cloud architect
Integrate Amazon QuickSight with Amazon S3 and Athena.	You must <a href="#">authorize</a> QuickSight to use Amazon S3 and Athena before you deploy the AWS CloudFormation stack.	AWS administrator, AWS DevOps, Cloud administrator, Cloud architect

## Deploy the infrastructure

Task	Description	Skills required
Clone the GitHub repository.	<ol style="list-style-type: none"><li>1. Clone the GitHub <a href="#">getiamcredsreport-allaccounts-org</a> repository to your local machine by running the following command: <code>git clone https://github.com/aws-samples/getiamcredsreport-allaccounts-org</code></li></ol>	AWS administrator
Deploy the infrastructure.	<ol style="list-style-type: none"><li>1. Sign in to the AWS Management Console and open the <a href="#">CloudFormation console</a>.</li><li>2. In the navigation pane, choose <b>Create stack</b>, and then choose <b>With new resources (standard)</b>.</li><li>3. On the <b>Identify resources</b> page, choose <b>Next</b>.</li><li>4. On the <b>Specify template</b> page, for <b>Template source</b>, select <b>Upload a template file</b>.</li><li>5. Choose <b>Choose file</b>, select the <code>Cloudformation-createcredentials-profile.yaml</code> file from your cloned GitHub repository, and then choose <b>Next</b>.</li></ol>	AWS administrator

Task	Description	Skills required
	<p>6. In <b>Parameters</b>, update <code>IAMRoleName</code> with your IAM role. This should be the IAM role that you want Lambda to assume in every account of the organization. This role creates the credential report. <b>Note:</b> The role doesn't have to be present in all accounts at this step of stack creation.</p> <p>7. In <b>Parameters</b>, update <code>S3BucketName</code> with the name of the S3 bucket where Lambda can store the credentials for all accounts.</p> <p>8. For <b>Stack name</b>, enter your stack name.</p> <p>9. Choose <b>Submit</b>.</p> <p>10 Note the Lambda function's role name.</p>	

Task	Description	Skills required
Create an IAM permission policy.	<p><a href="#">Create an IAM policy</a> for every AWS account across your organization with the following permissions:</p> <pre data-bbox="594 443 1029 1157">{   "Version": "2012-10-17",   "Statement": [     {       "Effect": "Allow",       "Action": [         "iam:GenerateCredentialReport",         "iam:GetCredentialReport"       ],       "Resource": "*"     }   ] }</pre>	AWS DevOps, Cloud administrator, Cloud architect, Data engineer

Task	Description	Skills required
Create an IAM role with a trust policy.	<ol style="list-style-type: none"><li>1. <a href="#">Create an IAM role</a> for the AWS accounts and attach the permission policy that you created in the previous step.</li><li>2. Attach the following trust policy to the IAM role:</li></ol> <pre data-bbox="597 632 1027 1465">{   "Version": "2012-10-17",   "Statement": [     {       "Effect": "Allow",       "Principal": {         "AWS": [           "arn:aws:iam::&lt;MasterAccountID&gt;:role/&lt;LambdaRole&gt;"         ]       },       "Action": "sts:AssumeRole"     }   ] }</pre> <p data-bbox="589 1503 1011 1782"><b>Important:</b> Replace <code>arn:aws:iam::&lt;MasterAccountID&gt;:role/&lt;LambdaRole&gt;</code> with the ARN of the Lambda role that you noted previously.</p>	Cloud administrator, Cloud architect, AWS administrator



Task	Description	Skills required
<p>Configure Amazon QuickSight to visualize the data.</p>	<p><b>Note:</b> Organizations typically use automation to create IAM roles for their AWS accounts. We recommend that you use this automation, if available. Alternatively, you can use the <code>CreateRoleforOrg.py</code> script from the code repository. The script requires an existing administrative role or any other IAM role that has permission to create an IAM policy and role in every AWS account.</p> <ol style="list-style-type: none"> <li>1. <a href="#">Sign in to QuickSight</a> with your credentials.</li> <li>2. <a href="#">Create a dataset</a> by using Athena (using the <code>iamcredreportdb</code> database and <code>"cfn_iamcredreport"</code> table), and then automatically <a href="#">refresh the dataset</a>.</li> <li>3. <a href="#">Create an analysis in QuickSight</a>.</li> <li>4. <a href="#">Create a QuickSight dashboard</a>.</li> </ol>	<p>AWS DevOps, Cloud administrator, Cloud architect, Data engineer</p>

## Additional information

### Additional considerations

Consider the following:

- After you use CloudFormation to deploy the infrastructure, you can wait to get the reports created in Amazon S3 and analyzed by Athena until Lambda and AWS Glue run as per their schedules. Alternatively, you can run Lambda manually to get the reports in Amazon S3, and then run the AWS Glue crawler to get the Athena table that's created from the data.
- QuickSight is a powerful tool for analyzing and visualizing data based on your business requirements. You can use [parameters](#) in QuickSight to control widget data based on data fields that you choose. Also, you can use a QuickSight analysis to create parameters (for example, Account, Date, and User fields such as `partition_0`, `partition_1`, and `user` respectively) from your dataset to add controls for the parameters for Account, Date, and User.
- To build your own QuickSight dashboards, see [QuickSight Workshops](#) from the AWS Workshop Studio website.
- To see sample QuickSight dashboards, see the GitHub [getiamcredsreport-allaccounts-org](#) code repository.

## Targeted business outcomes

You can use this pattern to achieve the following targeted business outcomes:

- **Identify security incidents related to IAM users** – Investigate every user across every AWS account in your organization by using a single pane of glass. You can track the trend of an IAM user's most recently accessed individual AWS Regions and the services they used.
- **Track real-time migration of IAM users to SSO authentication** – By using SSO, users can sign in once with a single credential and access multiple AWS accounts and applications. If you're planning to migrate your IAM users to SSO, this pattern can help you transition to SSO and track all IAM user credential usage (such as access to the AWS Management Console or usage of access keys) across all AWS accounts.
- **Track AWS Regions accessed by IAM users** – You can control IAM user access to Regions for various purposes, such as data sovereignty and cost control. You can also track use of Regions by any IAM user.
- **Stay compliant** – By following the principle of least privilege, you can grant only the specific IAM permissions that are required to perform a specific task. Also, you can track access to AWS services, the AWS Management Console, and long-term credentials usage.
- **Share information with other stakeholders** – You can share curated dashboards with other stakeholders, without granting them access to IAM credential reports or AWS accounts.

## More patterns

- [Authenticate existing React application users by using Amazon Cognito and AWS Amplify UI](#)
- [Automate data ingestion from AWS Data Exchange into Amazon S3](#)
- [Automatically extract content from PDF files using Amazon Textract](#)
- [Build a data pipeline to ingest, transform, and analyze Google Analytics data using the AWS DataOps Development Kit](#)
- [Configure cross-account access to a shared AWS Glue Data Catalog using Amazon Athena](#)
- [Create detailed cost and usage reports for Amazon EMR clusters by using AWS Cost Explorer](#)
- [Create detailed cost and usage reports for Amazon RDS and Amazon Aurora](#)
- [Create detailed cost and usage reports for AWS Glue jobs by using AWS Cost Explorer](#)
- [Deploy and manage a serverless data lake on the AWS Cloud by using infrastructure as code](#)
- [Embed an Amazon QuickSight dashboard in a local Angular application](#)
- [Ensure an Amazon Redshift cluster is encrypted upon creation](#)
- [Ensure encryption for Amazon EMR data at rest is enabled at launch](#)
- [Execute Amazon Redshift SQL queries by using Terraform](#)
- [Extract and query AWS IoT SiteWise metadata attributes in a data lake](#)
- [Generate data insights by using AWS Mainframe Modernization and Amazon Q in QuickSight](#)
- [Give SageMaker notebook instances temporary access to a CodeCommit repository in another AWS account](#)
- [Identify and alert when Amazon Data Firehose resources are not encrypted with an AWS KMS key](#)
- [Ingest and analyze AWS security logs in Microsoft Sentinel](#)
- [Migrate a self-hosted MongoDB environment to MongoDB Atlas on the AWS Cloud](#)
- [Migrate Amazon RDS for Oracle to Amazon RDS for PostgreSQL in SSL mode by using AWS DMS](#)
- [Migrate an Oracle database to Amazon RDS for Oracle by using Oracle GoldenGate flat file adapters](#)
- [Migrate an Oracle Database to Amazon Redshift using AWS DMS and AWS SCT](#)
- [Migrate data from an on-premises Hadoop environment to Amazon S3 using DistCp with AWS PrivateLink for Amazon S3](#)
- [Migrate from Couchbase Server to Couchbase Capella on AWS](#)
- [Migrate on-premises Cloudera workloads to Cloudera Data Platform on AWS](#)

- [Monitor Amazon EMR clusters for in-transit encryption at launch](#)
- [Set up a Grafana monitoring dashboard for AWS ParallelCluster](#)
- [Unload data from an Amazon Redshift cluster across accounts to Amazon S3](#)
- [Verify that new Amazon Redshift clusters have required SSL endpoints](#)
- [Verify that new Amazon Redshift clusters launch in a VPC](#)
- [Visualize AI/ML model results using Flask and AWS Elastic Beanstalk](#)

# Business productivity

## Topics

- [Set up a highly available PeopleSoft architecture on AWS](#)
- [More patterns](#)

# Set up a highly available PeopleSoft architecture on AWS

Created by Ramanathan Muralidhar (AWS)

**Environment:** Production

**Technologies:** Business productivity; Infrastructure; Web & mobile apps; Databases

**Workload:** Oracle

**AWS services:** Amazon EC2 Auto Scaling; Amazon EFS; Elastic Load Balancing (ELB); Amazon RDS

## Summary

When you migrate your PeopleSoft workloads to AWS, resiliency is an important objective. It ensures that your PeopleSoft application is always highly available and able to recover from failures quickly.

This pattern provides an architecture for your PeopleSoft applications on AWS to ensure high availability (HA) at the network, application, and database tiers. It uses an [Amazon Relational Database Service \(Amazon RDS\)](#) for Oracle or Amazon RDS for SQL Server database for the database tier. This architecture also includes AWS services such as [Amazon Route 53](#), [Amazon Elastic Compute Cloud \(Amazon EC2\)](#) Linux instances, [Amazon Elastic Block Storage \(Amazon EBS\)](#), [Amazon Elastic File System \(Amazon EFS\)](#), and an [Application Load Balancer](#), and is scalable.

[Oracle PeopleSoft](#) provides a suite of tools and applications for workforce management and other business operations.

## Prerequisites and limitations

### Prerequisites

- An active AWS account
- A PeopleSoft environment with the necessary licenses for setting it up on AWS

- A virtual private cloud (VPC) set up in your AWS account with the following resources:
  - At least two Availability Zones
  - One public subnet and three private subnets in each Availability Zone
  - A NAT gateway and an internet gateway
  - Route tables for each subnet to route the traffic
  - Network access control lists (network ACLs) and security groups defined to help ensure the security of the PeopleSoft application in accordance with your organization's standards

## Limitations

- This pattern provides a high availability (HA) solution. It doesn't support disaster recovery (DR) scenarios. In the rare occurrence that the entire AWS Region for the HA implementation goes down, the application will become unavailable.

## Product versions

- PeopleSoft applications running PeopleTools 8.52 and later

## Architecture

### Target architecture

Downtime or outage of your PeopleSoft production application impacts the availability of the application and causes major disruptions to your business.

We recommend that you design your PeopleSoft production application so that it is always highly available. You can achieve this by eliminating single points of failure, adding reliable crossover or failover points, and detecting failures. The following diagram illustrates an HA architecture for PeopleSoft on AWS.

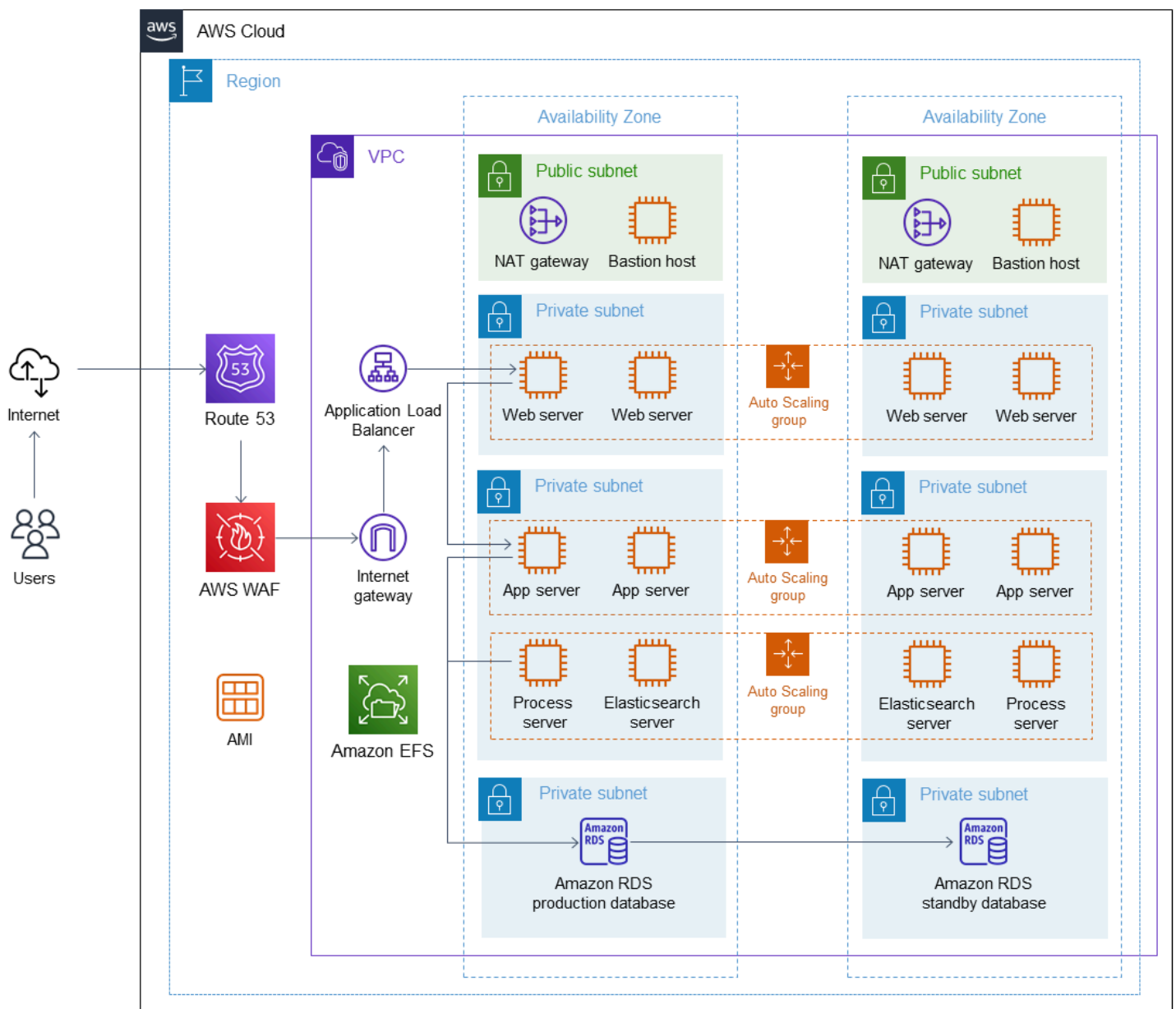

This architecture deployment uses Amazon RDS for Oracle as the PeopleSoft database, and EC2 instances that are running on Red Hat Enterprise Linux (RHEL). You can also use Amazon RDS for SQL Server as the Peoplesoft database.

This architecture contains the following components:

- [Amazon Route 53](#) is used as the Domain Name Server (DNS) for routing requests from the internet to the PeopleSoft application.



- [AWS WAF](#) helps you protect against common web exploits and bots that can affect availability, compromise security, or consume excessive resources. [AWS Shield Advanced](#) (not illustrated) provides much broader protection.
- An [Application Load Balancer](#) load-balances HTTP and HTTPS traffic with advanced request routing targeted at the web servers.
- The web servers, application servers, process scheduler servers, and Elasticsearch servers that support the PeopleSoft application run in multiple Availability Zones and use [Amazon EC2 Auto Scaling](#).
- The database used by the PeopleSoft application runs on [Amazon RDS](#) in a Multi-AZ configuration.
- The file share used by the PeopleSoft application is configured on [Amazon EFS](#) and is used to access files across instances.
- [Amazon Machine Images \(AMIs\)](#) are used by Amazon EC2 Auto Scaling to ensure that PeopleSoft components are cloned quickly when needed.
- The [NAT gateways](#) connect instances in a private subnet to services outside your VPC, and ensure that external services cannot initiate a connection with those instances.
- The [internet gateway](#) is a horizontally scaled, redundant, and highly available VPC component that allows communication between your VPC and the internet.
- The bastion hosts in the public subnet provide access to the servers in the private subnet from an external network, such as the internet or on-premises network. The bastion hosts provide controlled and secure access to the servers in the private subnets.

## Architecture details

The PeopleSoft database is housed in an Amazon RDS for Oracle (or Amazon RDS for SQL Server) database in a Multi-AZ configuration. The [Amazon RDS Multi-AZ feature](#) replicates database updates across two Availability Zones to increase durability and availability. Amazon RDS automatically fails over to the standby database for planned maintenance and unplanned disruptions.

The PeopleSoft web and middle tier are installed on EC2 instances. These instances are spread across multiple Availability Zones and tied by an [Auto Scaling group](#). This ensures that these components are always highly available. A minimum number of required instances are maintained to ensure that the application is always available and can scale when required.

We recommend that you use a current generation EC2 instance type for the OEM EC2 instances. Current generation instance types, such as [instances built on the AWS Nitro System](#), support hardware virtual machines (HVMs). The HVM AMIs are required to take advantage of [enhanced networking](#), and they also offer increased security. The EC2 instances that are part of each Auto Scaling group use their own AMI when replacing or scaling up instances. We recommend that you select EC2 instance types based on the load you want your PeopleSoft application to handle and the minimum values recommended by Oracle for your PeopleSoft application and PeopleTools release. For more information about hardware and software requirements, see the [Oracle support website](#).

The PeopleSoft web and middle tier share an Amazon EFS mount to share reports, data files, and (if needed) the PS\_HOME directory. Amazon EFS is configured with mount targets in each Availability Zone for performance and cost reasons.

An Application Load Balancer is provisioned to support the traffic that accesses the PeopleSoft application and load-balances the traffic among the web servers across different Availability Zones. An Application Load Balancer is a network device that provides HA in at least two Availability Zones. The web servers distribute the traffic to different application servers by using a load balancing configuration. Load balancing among the web server and application server ensures that load is distributed evenly across the instances, and helps avoid bottlenecks and service disruptions due to overloaded instances.

Amazon Route 53 is used as the DNS service to route traffic to the Application Load Balancer from the internet. Route 53 is a highly available and scalable DNS web service.

## HA details

- **Databases:** The Multi-AZ feature of Amazon RDS operates two databases in multiple Availability Zones with synchronous replication. This creates a highly available environment with automatic failover. Amazon RDS has failover event detection and initiates automated failover when these events occur. You can also initiate manual failover through the Amazon RDS API. For a detailed explanation, see the blog post [Amazon RDS Under The Hood: Multi-AZ](#). The failover is seamless and the application automatically reconnects to the database when it happens. However, any process scheduler jobs during the failover generate errors and have to be resubmitted.
- **PeopleSoft application servers:** The application servers are spread across multiple Availability Zones and have an Auto Scaling group defined for them. If an instance fails, the Auto Scaling group immediately replaces it with a healthy instance that's cloned from the AMI of the application server template. Specifically, *jolt pooling* is enabled, so when an application server

instance goes down, the sessions automatically fail over to another application server, and the Auto Scaling group automatically spins up another instance, brings up the application server, and registers it in the Amazon EFS mount. The newly created application server is automatically added to the web servers by using the `PSSTRSETUP.SH` script in the web servers. This ensures that the application server is always highly available and recovers from failure quickly.

- **Process schedulers:** The process schedulers servers are spread across multiple Availability Zones and have an Auto Scaling group defined for them. If an instance fails, the Auto Scaling group immediately replaces it with a healthy instance that's cloned from the AMI of the process scheduler server template. Specifically, when a process scheduler instance goes down, the Auto Scaling group automatically spins up another instance and brings up the process scheduler. Any jobs that were running when the instance failed must be resubmitted. This ensures that the process scheduler is always highly available and recovers from failure quickly.
- **Elasticsearch servers:** The Elasticsearch servers have an Auto Scaling group defined for them. If an instance fails, the Auto Scaling group immediately replaces it with a healthy instance that's cloned from the AMI of the Elasticsearch server template. Specifically, when an Elasticsearch instance goes down, the Application Load Balancer that serves requests to it detects the failure and stops sending traffic to it. The Auto Scaling group automatically spins up another instance and brings up the Elasticsearch instance. When the Elasticsearch instance is back up, the Application Load Balancer detects that it's healthy and starts sending requests to it again. This ensures that the Elasticsearch server is always highly available and recovers from failure quickly.
- **Web servers:** The web servers have an Auto Scaling group defined for them. If an instance fails, the Auto Scaling group immediately replaces it with a healthy instance that's cloned from the AMI of the web server template. Specifically, when a web server instance goes down, the Application Load Balancer that serves requests to it detects the failure and stops sending traffic to it. The Auto Scaling group automatically spins up another instance and brings up the web server instance. When the web server instance is back up, the Application Load Balancer detects that it's healthy and starts sending requests to it again. This ensures that the web server is always highly available and recovers from failure quickly.

## Tools

### AWS services

- [Application Load Balancers](#) distribute incoming application traffic across multiple targets, such as EC2 instances, in multiple Availability Zones.

- [Amazon Elastic Block Store \(Amazon EBS\)](#) provides block-level storage volumes for use with Amazon Elastic Compute Cloud (Amazon EC2) instances.
- [Amazon Elastic Compute Cloud \(Amazon EC2\)](#) provides scalable computing capacity in the AWS Cloud. You can launch as many virtual servers as you need and quickly scale them up or down.
- [Amazon Elastic File System \(Amazon EFS\)](#) helps you create and configure shared file systems in the AWS Cloud.
- [Amazon Relational Database Service \(Amazon RDS\)](#) helps you set up, operate, and scale a relational database in the AWS Cloud.
- [Amazon Route 53](#) is a highly available and scalable DNS web service.

## Best practices

### Operational best practices

- When you run PeopleSoft on AWS, use Route 53 to route the traffic from the internet and locally. Use the [failover option](#) to reroute traffic to the disaster recovery (DR) site if the primary DB instance isn't available.
- Always use an Application Load Balancer in front of the PeopleSoft environment. This ensures that traffic is load-balanced to the web servers in a secure fashion.
- In the Application Load Balancer target group settings, make sure that [stickiness is turned on](#) with a load balancer generated cookie.

**Note:** You might need to use an application-based cookie if you use external single sign-on (SSO). This ensures that connections are consistent across the web servers and application servers.

- For a PeopleSoft production application, the Application Load Balancer idle timeout must match what is set in the web profile you use. This prevents user sessions from expiring at the load balancer layer.
- For a PeopleSoft production application, set the application server [recycle count](#) to a value that minimizes memory leaks.
- If you're using an Amazon RDS database for your PeopleSoft production application, as described in this pattern, run it in [Multi-AZ format for high availability](#).
- If your database is running on an EC2 instance for your PeopleSoft production application, make sure that a [standby database is running on another Availability Zone](#) for high availability.

- For DR, make sure that your Amazon RDS database or EC2 instance has a standby configured in a separate AWS Region from the production database. This ensures that in event of a disaster in the Region, you can switch the application over to another Region.
- For DR, use [Amazon Elastic Disaster Recovery](#) to set up application-level components in a separate Region from production components. This ensures that in the event of a disaster in the Region, you can switch the application over to another Region.
- Use Amazon EFS (for moderate I/O requirements) or [Amazon FSx](#) (for high I/O requirements) to store your PeopleSoft reports, attachments, and data files. This ensures that the content is stored in one central location and can be accessed from anywhere within the infrastructure.
- Use [Amazon CloudWatch](#) (basic and detailed) to monitor the AWS Cloud resources that your PeopleSoft application is using in near real time. This ensures that you are alerted of issues instantly and can address them quickly before they affect the availability of the environment.
- If you're using an Amazon RDS database as the PeopleSoft database, use [Enhanced Monitoring](#). This feature provides access to over 50 metrics, including CPU, memory, file system I/O, and disk I/O.
- Use [AWS CloudTrail](#) to monitor API calls on the AWS resources that your PeopleSoft application is using. This helps you perform security analysis, resource change tracking, and compliance auditing.

## Security best practices

- To protect your PeopleSoft application from common exploits such as SQL injection or cross-site scripting (XSS), use [AWS WAF](#). Consider using [AWS Shield Advanced](#) for tailored detection and mitigation services.
- Add a rule to the Application Load Balancer to redirect traffic from HTTP to HTTPS automatically to help secure your PeopleSoft application.
- Set up a separate security group for the Application Load Balancer. This security group should allow only HTTPS/HTTP inbound traffic and no outbound traffic. This ensures that only intended traffic is allowed and helps secure your application.
- Use private subnets for the application servers, web servers, and database, and use [NAT gateways](#) for outbound internet traffic. This ensures that the servers that support the application aren't reachable publicly, while providing public access only to the servers that need it.
- Use different VPCs to run your PeopleSoft production and non-production environments. Use [AWS Transit Gateway](#), [VPC peering](#), [network ACLs](#), and [security groups](#) to control the traffic flow between the [VPCs](#) and, if necessary, your on-premises data center.

- Follow the principle of least privilege. Grant access to the AWS resources used by the PeopleSoft application only to users who absolutely need it. Grant only the minimum privileges required to perform a task. For more information, see the [security pillar](#) of the AWS Well-Architected Framework.
- Wherever possible, use [AWS Systems Manager](#) to access the EC2 instances that the PeopleSoft application uses.

## Reliability best practices

- When you use an Application Load Balancer, register a single target for each enabled Availability Zone. This makes the load balancer most effective.
- We recommend that you have three distinct URLs for each PeopleSoft production environment: one URL to access the application, one to serve the integration broker, and one to view reports. If possible, each URL should have its own dedicated web servers and application servers. This design helps make your PeopleSoft application more secure, because each URL has a distinct functionality and controlled access. It also minimizes the scope of impact if the underlying services fail.
- We recommend that you configure [health checks on the load balancer target groups](#) for your PeopleSoft application. The health checks should be performed on the web servers instead of the EC2 instances running those servers. This ensures that if the web server crashes or the EC2 instance that hosts the web server goes down, the Application Load Balancer reflects that information accurately.
- For a PeopleSoft production application, we recommend that you spread the web servers across at least three Availability Zones. This ensures that the PeopleSoft application is always highly available even if one of the Availability Zones goes down.
- For a PeopleSoft production application, enable jolt pooling (`joltPooling=true`). This ensures that your application fails over to another application server if a server is down for patching purposes or because of a VM failure.
- For a PeopleSoft production application, set `DynamicConfigReload` to 1. This setting is supported in PeopleTools version 8.52 and later. It adds new application servers to the web server dynamically, without restarting the servers.
- To minimize downtime when you apply PeopleTools patches, use the blue/green deployment method for your Auto Scaling group launch configurations for the web and application servers. For more information, see the [Overview of deployment options on AWS](#) whitepaper.

- Use [AWS Backup](#) to back up your PeopleSoft application on AWS. AWS Backup is a cost-effective, fully managed, policy-based service that simplifies data protection at scale.

### Performance best practices

- Terminate the SSL at the Application Load Balancer for optimal performance of the PeopleSoft environment, unless your business requires encrypted traffic throughout the environment.
- Create [interface VPC endpoints](#) for AWS services like such as [Amazon Simple Notification Service \(Amazon SNS\)](#) and [CloudWatch](#) so that traffic is always internal. This is cost-effective and helps keep your application secure.

### Cost optimization best practices

- Tag all the resources used by your PeopleSoft environment, and enable [cost allocation tags](#). These tags help you view and manage your resource costs.
- For a PeopleSoft production application, set up Auto Scaling groups for the web servers and the application servers. This maintains a minimal number of web and application servers to support your application. You can use [Auto Scaling group policies](#) to scale the the servers up and down as required.
- Use [billing alarms](#) to get alerts when costs exceed a budget threshold that you specify.

### Sustainability best practices

- Use [infrastructure as code](#) (IaC) to maintain your PeopleSoft environments. This helps you build consistent environments and maintain change control.

## Epics

### Migrate your PeopleSoft database to Amazon RDS

Task	Description	Skills required
Create a DB subnet group.	On the <a href="#">Amazon RDS console</a> , in the navigation pane, choose <b>Subnet groups</b> , and then create an Amazon	Cloud administrator

Task	Description	Skills required
	RDS DB subnet group with subnets in multiple Availability Zones. This is required for the Amazon RDS database to run in a Multi-AZ configuration.	
Create the Amazon RDS database.	Create an Amazon RDS database in an Availability Zone of the AWS Region you selected for the PeopleSoft HA environment. When you create the Amazon RDS database, make sure to select the Multi-AZ option ( <b>Create a standby instance</b> ) and the database subnet group you created in the previous step. For more information, see the <a href="#">Amazon RDS documentation</a> .	Cloud administrator, Oracle database administrator
Migrate your PeopleSoft database to Amazon RDS.	Migrate your existing PeopleSoft database into the Amazon RDS database by using AWS Database Migration Service (AWS DMS). For more information, see the <a href="#">AWS DMS documentation</a> and the AWS blog post <a href="#">Migrating Oracle databases with near-zero downtime using AWS DMS</a> .	Cloud administrator, PeopleSoft DBA



## Set up your Amazon EFS file system

Task	Description	Skills required
Create a file system.	On the <a href="#">Amazon EFS console</a> , create a file system and mount targets for each Availability Zone. For instructions, see the <a href="#">Amazon EFS documentation</a> . When the file system has been created, note its DNS name. You will use this information when you mount the file system.	Cloud administrator

## Set up your PeopleSoft application and file system

Task	Description	Skills required
Launch an EC2 instance.	<p>Launch an EC2 instance for your PeopleSoft application. For instructions, see the <a href="#">Amazon EC2 documentation</a>.</p> <ul style="list-style-type: none"> <li>For <b>Name</b>, enter APP_TEMPLATE .</li> <li>For <b>OS images</b>, choose <b>Red Hat</b>.</li> <li>For <b>Instance type</b>, choose the instance type that's appropriate for your PeopleSoft application. For more information, see <i>Architecture details</i> in the <a href="#">Architecture</a> section.</li> </ul>	Cloud administrator, PeopleSoft administrator

Task	Description	Skills required
Install PeopleSoft on the instance.	Install your PeopleSoft application and PeopleTools on the EC2 instance you created. For instructions, see the <a href="#">Oracle documentation</a> .	Cloud administrator, PeopleSoft administrator
Create the application server.	Create the application server for the AMI template and make sure that it connects successfully to the Amazon RDS database.	Cloud administrator, PeopleSoft administrator

Task	Description	Skills required
<p>Mount the Amazon EFS file system.</p>	<p>Log in to the EC2 instance as the root user and run the following commands to mount the Amazon EFS file system to a folder called PSFTMNT on the server.</p> <pre data-bbox="597 537 1027 695">sudo su - mkdir /psftmnt cat /etc/fstab</pre> <p>Append the following line to the <code>/etc/fstab</code> file. Use the DNS name you noted when you created the file system.</p> <pre data-bbox="597 999 1027 1434">fs-09e064308f11453 88.efs.us-east-1.a mazonaws.com:/ / psftmnt nfs4 nfsvers=4 .1,rsize=1048576,w size=1048576,hard, timeo=600,retrans= 2,noresvport,_netdev 0 0 mount -a</pre>	<p>Cloud administrator, PeopleSoft administrator</p>
<p>Check permissions.</p>	<p>Make sure that the PSFTMNT folder has the proper permissions so that the PeopleSoft user can access it properly.</p>	<p>Cloud administrator, PeopleSoft administrator</p>

Task	Description	Skills required
Create additional instances.	Repeat the previous steps in this epic to create template instances for the process scheduler, web server, and Elasticsearch server. Name these instances <code>PRCS_TEMPLATE</code> , <code>WEB_TEMPLATE</code> , and <code>SRCH_TEMPLATE</code> . For the web server, set <code>joltPooling=true</code> and <code>DynamicConfigReload=1</code> .	Cloud administrator, PeopleSoft administrator

### Create scripts to set up servers

Task	Description	Skills required
Create a script to install the application server.	<p>In the Amazon EC2 <code>APP_TEMPLATE</code> instance, as the PeopleSoft user, create the following script. Name it <code>appstart.sh</code> and place it in the <code>PS_HOME</code> directory. You will use this script to bring up the application server and also record the server name on the Amazon EFS mount.</p> <pre>#!/bin/ksh . /usr/homes/hcmdemo/.profile psadmin -c configure -d HCMDEMO psadmin -c parallelboot -d HCMDEMO</pre>	PeopleSoft administrator

Task	Description	Skills required
	<pre>touch /psftmnt/`echo \$HOSTNAME`</pre>	
<p>Create a script to install the process scheduler server.</p>	<p>In the Amazon EC2 PRCS_TEMPLATE instance, as the PeopleSoft user, create the following script. Name it <code>prcsstart.sh</code> and place it in the <code>PS_HOME</code> directory. You will use this script to bring up the process scheduler server.</p> <pre>#!/bin/ksh . /usr/homes/hcmdemo/.profile /* The following line ensures that the process scheduler always has a unique name during replacement or scaling activity. */ sed -i "s/*PrcsServerName.*`hostname -I   awk -F. '{print "PrcsServerName=PSUNX"\$3\$4}'`/" \$HOME/appserv/prcs/*/psprcs.cfg psadmin -p configure -d HCMDEMO psadmin -p start -d HCMDEMO</pre>	<p>PeopleSoft administrator</p>

Task	Description	Skills required
Create a script to install the Elasticsearch server.	<p>In the Amazon EC2 <code>SRCH_TEMPLATE</code> instance, as the Elasticsearch user, create the following script. Name it <code>srchstart.sh</code> and place it in the <code>HOME</code> directory.</p> <pre data-bbox="594 537 1029 1136">#!/bin/ksh /* The following line   ensures that the   correct IP is indicated   in the elasticse   arch.yaml file. */ sed -i "s/. *netw ork.host.*`hostna me -I   awk '{print "host:"\$0}'`/" \$ES_HOME_DIR/config/ elasticsearch.yaml nohup \$ES_HOME_DIR/bin/ elasticsearch &amp;</pre>	PeopleSoft administrator

Task	Description	Skills required
Create a script to install the web server.	<p>In the Amazon EC2 WEB_TEMPLATE instance, as the web server user, create the following scripts in the HOME directory.</p> <p><code>renip.sh</code>: This script ensures that the web server has the correct IP when cloned from the AMI.</p> <pre>#!/bin/ksh hn=`hostname` /* On the following line, change the IP with the hostname with the hostname of the web template. */ for text_file in `find * -type f -exec grep -l '&lt;hostname-of-the- web-template&gt;' {} \;` do sed -e 's/&lt;hostn ame-of-the-web-tem plate&gt;/'\$hn'/g' \$text_file &gt; temp mv -f temp \$text_file done</pre> <p><code>psstrsetup.sh</code> : This script ensures that the web server uses the correct application server IPs that are currently running. It tries to connect to each application server on the jolt port and adds it to the configuration file.</p>	PeopleSoft administrator

Task	Description	Skills required
	<pre data-bbox="609 226 1015 1102">#!/bin/ksh c2="" for ctr in `ls -1 / psftmnt/*.internal` do c1=`echo \$ctr   awk -F  "/" '{print \$3}'` /* In the following  lines, 9000 is the  jolt port. Change it if  necessary. */ if nc -z \$c1 9000 2&gt; / dev/null; then if [[ \$c2 = "" ]]; then c2="psserver="`echo  \$c1`:9000" else c2=`echo \$c2`,`echo  \$c1`:9000" fi fi done</pre> <p data-bbox="592 1155 1015 1291"><b>webstart.sh</b> : This script runs the two previous scripts and starts the web servers.</p> <pre data-bbox="609 1344 1015 1711">#!/bin/ksh /* Change the path  in the following if  necessary. */ cd /usr/homes/hcmdemo ./renip.sh ./psstrsetup.sh webserv/peoplesoft/ bin/startPIA.sh</pre>	



Task	Description	Skills required
Add a crontab entry.	<p>In the Amazon EC2 WEB_TEMPLATE instance, as the web server user, add the following line to <b>crontab</b>. Change the time and path to reflect the values you need. This entry ensures that your web server always has the correct application server entries in the configuration.properties file.</p> <pre data-bbox="597 779 1027 898">* * * * * /usr/homes/hcmdemo/psstrsetup.sh</pre>	PeopleSoft administrator

## Create AMIs and Auto Scaling group templates

Task	Description	Skills required
Create an AMI for the application server template.	<p>On the Amazon EC2 console, create an AMI image of the Amazon EC2 APP_TEMPLATE instance. Name the AMI PSAPPSRV-SCG-VER1 . For instructions, see the <a href="#">Amazon EC2 documentation</a>.</p>	Cloud administrator, PeopleSoft administrator
Create AMIs for the other servers.	Repeat the previous step to create AMIs for the process scheduler, Elasticsearch server, and web server.	Cloud administrator, PeopleSoft administrator

Task	Description	Skills required
Create a launch template for the application server Auto Scaling group.	<p>Create a launch template for the application server Auto Scaling group. Name the template PSAPPSRV_TEMPLATE. In the template, choose the AMI you created for the APP_TEMPLATE instance. For instructions, see the <a href="#">Amazon EC2 documentation</a>.</p> <ul style="list-style-type: none"><li>• In the launch template, select the instance type based on your requirements.</li><li>• In the <b>User data</b> field of the <b>Advanced details</b> section, add the following entries. Make sure that the path and user information are correct. You created the <code>appstart.sh</code> script in a previous step.</li></ul> <pre data-bbox="625 1346 1029 1541">#!/bin/ksh su -c "/usr/homes/hcmdemo/appstart.sh" - hcmdemo</pre>	Cloud administrator, PeopleSoft administrator

Task	Description	Skills required
Create a launch template for the process scheduler server Auto Scaling group.	<p>Repeat the previous step to create a launch template for the process scheduler server Auto Scaling group. Name the template <code>PSPRCS_TEMPLATE</code> . In the template, choose the AMI you created for the process scheduler.</p> <ul style="list-style-type: none"><li>• In the <b>User data</b> field of the <b>Advanced details</b> section, add the following entries. Make sure that the path and user information are correct. You created the <code>prcsstart.sh</code> script in a previous step.</li></ul> <pre data-bbox="630 1050 1029 1247">#!/bin/ksh su -c "/usr/homes/hcmdemo/prcsstart.sh" - hcmdemo</pre>	Cloud administrator, PeopleSoft administrator

Task	Description	Skills required
Create a launch template for the Elasticsearch server Auto Scaling group.	<p>Repeat the previous steps to create a launch template for the Elasticsearch server Auto Scaling group. Name the template <code>SRCH_TEMPLATE</code> .</p> <p>In the template, choose the AMI you created for the search server.</p> <ul style="list-style-type: none"><li>• In the <b>User data</b> field of the <b>Advanced details</b> section, add the following entries. Make sure that the path and user information are correct. You created the <code>sichstart.sh</code> script in a previous step.</li></ul> <pre data-bbox="625 1045 1029 1245">#!/bin/ksh su -c "/usr/home es/essearch/sichst art.sh" - essearch</pre>	Cloud administrator, PeopleSoft administrator

Task	Description	Skills required
<p>Create a launch template for the web server Auto Scaling group.</p>	<p>Repeat the previous steps to create a launch template for the web server Auto Scaling group. Name the template <code>WEB_TEMPLATE</code> . In the template, choose the AMI you created for the web server.</p> <ul style="list-style-type: none"> <li>In the <b>User data</b> field of the <b>Advanced details</b> section, add the following entries. Make sure that the path and user information are correct. You created the <code>webstart.sh</code> script in a previous step.</li> </ul> <pre data-bbox="626 999 1027 1199"> #! /bin/ksh su -c "/usr/homes/hcmdemo/webstart.sh" - hcmdemo </pre>	<p>Cloud administrator, PeopleSoft administrator</p>

## Create Auto Scaling groups

Task	Description	Skills required
<p>Create an Auto Scaling group for the application server.</p>	<p>On the Amazon EC2 console, create an Auto Scaling group called <code>PSAPPSRV_ASG</code> for the application server by using the <code>PSAPPSRV_TEMPLATE</code> template. For instructions, see the <a href="#">Amazon EC2 documentation</a>.</p>	<p>Cloud administrator, PeopleSoft administrator</p>

Task	Description	Skills required
	<ul style="list-style-type: none"> <li>• On the <b>Choose instance launch options</b> page, select the correct VPC and then select multiple subnets from different Availability Zones.</li> <li>• On the <b>Configure advanced options</b> page, do not select a load balancer.</li> <li>• On the <b>Configure group size and scaling policies</b> page, choose settings depending on how much load you want to architect your system for and whether you want to use a scaling policy. We recommend that you set the desired and minimum capacity to 2 at a minimum so that at least one instance is available to service the traffic at any point in time. For more information about Auto Scaling policies, see the <a href="#">Amazon EC2 documentation</a>.</li> </ul>	
Create Auto Scaling groups for the other servers.	Repeat the previous step to create Auto Scaling groups for the process scheduler, Elasticsearch server, and web server.	Cloud administrator, PeopleSoft administrator

## Create and configure target groups

Task	Description	Skills required
Create a target group for the web server.	On the Amazon EC2 console, create a target group for the web server. For instructions, see the <a href="#">Elastic Load Balancing documentation</a> . Set the port to the port that the web server is listening on.	Cloud administrator
Configure health checks.	Confirm that the health checks have the correct values to reflect your business requirements. For more information, see the <a href="#">Elastic Load Balancing documentation</a> .	Cloud administrator
Create a target group for the Elasticsearch server.	Repeat the previous steps to create a target group called PSFTSRCH for the Elasticsearch server, and set the correct Elasticsearch port.	Cloud administrator
Add target groups to Auto Scaling groups.	<p>Open the web server Auto Scaling group called PSPIA_ASG that you created earlier. On the <b>Load balancing</b> tab, choose <b>Edit</b> and then add the PSFTWEB target group to the Auto Scaling group.</p> <p>Repeat this step for the Elasticsearch Auto Scaling group PSSRCH_ASG to add</p>	Cloud administrator

Task	Description	Skills required
	the target group PSFTSRCH you created earlier.	
Set session stickiness.	<p>In the target group PSFTWEB, choose the <b>Attributes</b> tab, choose <b>Edit</b>, and set the session stickiness. For stickiness type, choose <b>Load balancer generated cookie</b>, and set the duration to 1. For more information, see the <a href="#">Elastic Load Balancing documentation</a>.</p> <p>Repeat this step for the target group PSFTSRCH.</p>	Cloud administrator

## Create and configure application load balancers

Task	Description	Skills required
Create a load balancer for the web servers.	<p>Create an Application Load Balancer named PSFTLB to load-balance traffic to the web servers. For instructions, see the <a href="#">Elastic Load Balancing documentation</a>.</p> <ul style="list-style-type: none"> <li>• Provide the load balancer name.</li> <li>• For <b>Scheme</b>, choose <b>Internet-facing</b>.</li> <li>• In the <b>Network mapping</b> section, select the correct VPC and at least two public</li> </ul>	Cloud administrator



Task	Description	Skills required
	<p>subnets from different Availability Zones.</p> <ul style="list-style-type: none"> <li>In the <b>Listeners and routing</b> section, select the target group PSFTWEB and specify the correct protocol and port number.</li> </ul>	
<p>Create a load balancer for the Elasticsearch servers.</p>	<p>Create an Application Load Balancer named PSFTSCH to load-balance traffic to the Elasticsearch servers.</p> <ul style="list-style-type: none"> <li>Provide the load balancer name.</li> <li>For <b>Scheme</b>, choose <b>Internal</b>.</li> <li>In the <b>Network mapping</b> section, select the correct VPC and private subnets.</li> <li>In the <b>Listeners and routing</b> section, select the target group PSFTSRCH and specify the correct protocol and port number.</li> </ul>	<p>Cloud administrator</p>
<p>Configure Route 53.</p>	<p>On the <a href="#">Amazon Route 53 console</a>, create a record in the hosted zone that will service the PeopleSoft application. For instructions, see the <a href="#">Amazon Route 53 documentation</a>. This ensures that all the traffic passes through the PSFTLB load balancer.</p>	<p>Cloud administrator</p>

## Related resources

- [Oracle PeopleSoft website](#)
- [AWS documentation](#)

## More patterns

- [Authenticate existing React application users by using Amazon Cognito and AWS Amplify UI](#)
- [Deploy a clustered application to Amazon ECS by using AWS Copilot](#)
- [Deploy a ChatOps solution to manage SAST scan results by using AWS Chatbot custom actions and AWS CloudFormation](#)
- [Deploy CloudWatch Synthetics canaries by using Terraform](#)
- [Document institutional knowledge from voice inputs by using Amazon Bedrock and Amazon Transcribe](#)

# CloudNative

## Topics

- [Monitor SAP RHEL Pacemaker clusters by using AWS services](#)
- [Successfully import an S3 bucket as an AWS CloudFormation stack](#)
- [More patterns](#)

# Monitor SAP RHEL Pacemaker clusters by using AWS services

Created by Harsh Thoria (AWS), Randy Germann (AWS), and RAVEENDRA Voore (AWS)

**Environment:** Production

**Technologies:** CloudNative; Infrastructure; Operating systems

**Workload:** SAP

**AWS services:** Amazon CloudWatch; Amazon SNS; Amazon CloudWatch Logs

## Summary

This pattern outlines the steps for monitoring and configuring alerts for a Red Hat Enterprise Linux (RHEL) Pacemaker cluster for SAP applications and SAP HANA database services by using Amazon CloudWatch and Amazon Simple Notification Service (Amazon SNS).

The configuration enables you to monitor SAP SCS or ASCS, Enqueue Replication Server (ERS), and SAP HANA cluster resources when they are in a "stopped" state with the help of CloudWatch log streams, metric filters, and alarms. Amazon SNS sends an email to the infrastructure or SAP Basis team about the stopped cluster status.

You can create the AWS resources for this pattern by using AWS CloudFormation scripts or the AWS service consoles. This pattern assumes that you're using the consoles; it doesn't provide CloudFormation scripts or cover infrastructure deployment for CloudWatch and Amazon SNS. Pacemaker commands are used to set the cluster alerting configuration.

## Prerequisites and limitations

### Prerequisites

- An active AWS account.
- Amazon SNS set up to send email or mobile notifications.
- An SAP ASCS/ERS for ABAP or SCS/ERS for Java, and SAP HANA Database RHEL Pacemaker cluster. For instructions, see the following:

- [SAP HANA cluster setup](#)
- [SAP Netweaver ABAP/Java cluster setup](#)

## Limitations

- This solution currently works for RHEL version 7.3 and later Pacemaker-based clusters. It hasn't been tested on SUSE operating systems.

## Product versions

- RHEL 7.3 and later

## Architecture

### Target technology stack

- RHEL Pacemaker alert event-driven agent
- Amazon Elastic Compute Cloud (Amazon EC2)
- CloudWatch alarm
- CloudWatch log group and metric filter
- Amazon SNS

### Target architecture

The following diagram illustrates the components and workflows for this solution.

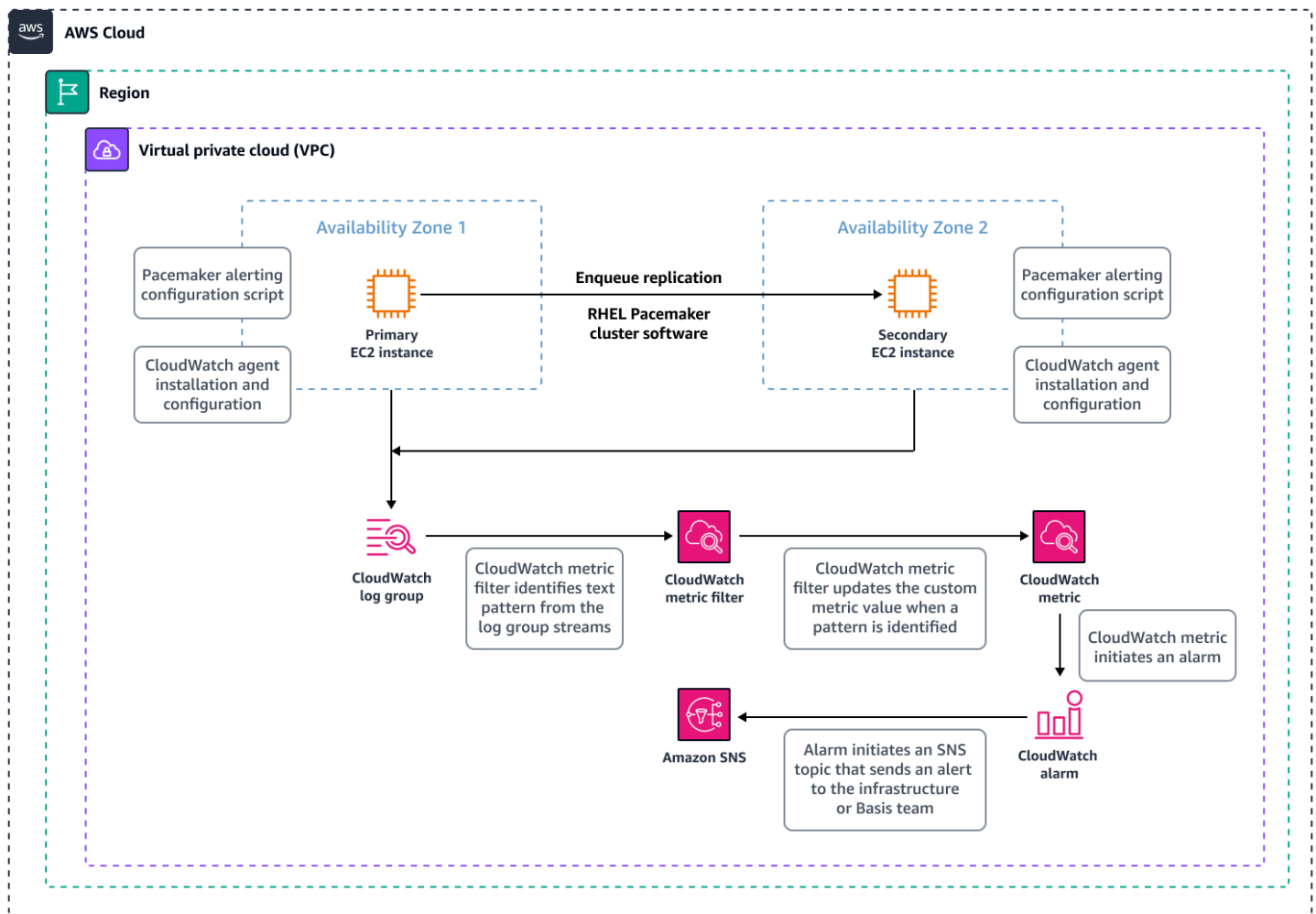

## Automation and scale

- You can automate the creation of AWS resources by using CloudFormation scripts. You can also use additional metric filters to scale and cover multiple clusters.

## Tools

### AWS services

- [Amazon CloudWatch](#) helps you monitor the metrics of your AWS resources and the applications you run on AWS in real time.
- [Amazon Simple Notification Service \(Amazon SNS\)](#) helps you coordinate and manage the exchange of messages between publishers and clients, including web servers and email addresses.

## Tools

- CloudWatch agent (unified) is a tool that collects system-level metrics, logs, and traces from EC2 instances, and retrieves custom metrics from your applications.
- Pacemaker alert agent (for RHEL 7.3 and later) is a tool that initiates an action when there's a change, such as when a resource stops or restarts, in a Pacemaker cluster.

## Best practices

- For best practices for using SAP workloads on AWS, see the [SAP Lens](#) for the AWS Well-Architected Framework.
- Consider the costs involved in setting up CloudWatch monitoring for SAP HANA clusters. For more information, see the [CloudWatch documentation](#).
- Consider using a pager or ticketing mechanism for Amazon SNS alerts.
- Always check for RHEL high availability (HA) versions of the RPM package for **pcs**, Pacemaker, and the AWS fencing agent.

## Epics

### Set up Amazon SNS

Task	Description	Skills required
Create an SNS topic.	<ol style="list-style-type: none"> <li>1. Sign in to the AWS Management Console and open the Amazon SNS console at <a href="https://console.aws.amazon.com/sns/v3/home">https://console.aws.amazon.com/sns/v3/home</a>.</li> <li>2. On the Amazon SNS dashboard, under <b>Common actions</b>, choose <b>Create Topic</b>.</li> </ol>	AWS administrator



Task	Description	Skills required
	<ol style="list-style-type: none"><li data-bbox="591 212 976 338">3. In the <b>Create new topic</b> dialog box, for <b>Type</b>, choose <b>Standard</b>.</li><li data-bbox="591 365 976 491">4. For <b>Topic name</b>, enter a name for the topic (for example, my-topic).</li><li data-bbox="591 518 932 550">5. Choose <b>Create topic</b>.</li></ol> <p data-bbox="630 596 1015 768">This creates an SNS topic with a resource policy that lets you publish notifications.</p> <ol style="list-style-type: none"><li data-bbox="591 795 992 1068">6. Copy the <b>Topic ARN</b> (for example, <code>arn:aws:sns:us-east-1:111122223333:my-topic</code> ). You will use this ARN in a later step.</li></ol>	

Task	Description	Skills required
Modify the access policy for the SNS topic.	<ol style="list-style-type: none"><li>1. On the Amazon SNS console, in the navigation pane, choose <b>Topics</b>, and then choose the topic you created.</li><li>2. Choose <b>Edit</b> and go to the <b>Access policy</b> section.</li><li>3. Make sure that the access policy includes CloudWatch as one of the service principals that are allowed to publish to this topic. For example:<pre data-bbox="630 890 1029 1724">{   "Sid": "Allow AWS CloudWatch to Publish to this SNS topic",   "Effect": "Allow",   "Principal": {     "Service": [       "cloudwat ch.amazonaws.com"     ]   },   "Action": "SNS:Publish",   "Resource": "arn:aws:sns:us-ea st-1:111122223333: my-topic" }</pre></li><li>4. Choose <b>Save changes</b>.</li></ol>	AWS systems administrator

Task	Description	Skills required
Subscribe to the SNS topic.	<ol style="list-style-type: none"><li>1. On the Amazon SNS console, in the navigation pane, choose <b>Subscriptions, Create subscription</b>.</li><li>2. For <b>Topic ARN</b>, paste the ARN that you created in the first task.</li><li>3. For <b>Protocol</b>, choose <b>Email</b>.</li><li>4. For <b>Endpoint</b>, enter an email address for the person or team that is responsible for the SAP Pacemaker cluster and should receive notifications. For example, this can be the email address for the SAP Basis or infrastructure team's distribution list.</li><li>5. Choose <b>Create subscription</b>.</li><li>6. From your email application, open the message from AWS Notifications and confirm your subscription.</li></ol> <p>Your web browser displays a confirmation response from Amazon SNS.</p>	AWS systems administrator

## Confirm the setup of the cluster

Task	Description	Skills required
Check cluster status.	Use the <b>pcs status</b> command to confirm that the resources are online.	SAP Basis administrator

## Configure Pacemaker alerts

Task	Description	Skills required
Configure the Pacemaker alert agent on the primary cluster instance.	<p>Log in to the EC2 instance in the primary cluster and run the following commands:</p> <pre>install --mode=0755 /usr/share/pacemaker/alerts/alert_file.sh.sample touch /var/lib/pacemaker/alert_file.sh touch /var/log/pcm_alert_file.log chown hacluster:haclient /var/log/pcm_alert_file.log chmod 600 /var/log/pcm_alert_file.log pcs alert create id=alert_file description="Log events to a file." path=/var/lib/pacemaker/alert_file.sh pcs alert recipient add alert_file id=my-alert_logfile value=/va</pre>	SAP Basis administrator

Task	Description	Skills required
Configure the Pacemaker alert agent on the secondary cluster instance.	<p data-bbox="610 212 1011 306">r/log/pcm_alert_file.log</p> <p data-bbox="591 348 1024 527">Log in to the secondary cluster EC2 instance in the secondary cluster and run the following commands:</p> <pre data-bbox="610 569 1011 1150">install --mode=0755 /usr/share/pacemaker/alerts/alert_file.sh.sample touch /var/lib/pacemaker/alert_file.sh touch /var/log/pcm_alert_file.log chown hacluster:haclient /var/log/pcm_alert_file.log chmod 600 /var/log/pcm_alert_file.log</pre>	SAP Basis administrator

Task	Description	Skills required
<p>Confirm that the RHEL alert resource was created.</p>	<p>Use the following command to confirm that the alert resource was created:</p> <pre data-bbox="594 394 1029 474">pcs alert</pre> <p>The output of the command will look like this:</p> <pre data-bbox="594 632 1029 1188">[root@xxxxxxx ~]# pcs alert Alerts: Alert: alert_file (path=/var/lib/pacemaker/alert_file.sh) Description: Log events to a file. Recipients: Recipient: my- alert_logfile (value=/ var/log/pcmk_alert_ file.log)</pre>	<p>SAP Basis administrator</p>

## Configure the CloudWatch agent

Task	Description	Skills required
<p>Install the CloudWatch agent.</p>	<p>There are several ways to install the CloudWatch agent on an EC2 instance. To use the command line:</p> <ol style="list-style-type: none"> <li>1. Download the CloudWatch agent package:</li> </ol>	<p>AWS systems administrator</p>

Task	Description	Skills required
	<pre>wget https://s3.&lt;region&gt;.amazonaws.com/amazoncloudwatch-agent-region/redhat/amd64/latest/amazon-cloudwatch-agent.rpm</pre> <p>where &lt;region&gt; is the AWS Region where the EC2 instance is located (for example, us-west-2 ).</p> <ol style="list-style-type: none"><li>Optional) Verify the package signature. For instructions, see <a href="#">Verifying the signature of the CloudWatch agent package</a> in the CloudWatch documentation.</li><li>Install the package on the first instance:<pre>sudo rpm -U ./amazon-cloudwatch-agent.rpm</pre></li><li>Repeat for the secondary instance.</li></ol> <p>For more information, see the <a href="#">CloudWatch documentation</a>.</p>	

Task	Description	Skills required
Attach an IAM role to the EC2 instance.	To enable the CloudWatch agent to send data from the instances, you must attach the IAM <b>CloudWatchAgentServerRole</b> role to each instance. Or, you can add a policy for the CloudWatch agent to your existing IAM role. For more information, see the <a href="#">CloudWatch documentation</a> .	AWS administrator



Task	Description	Skills required
Configure the CloudWatch agent to monitor the Pacemaker alert agent log file on the primary cluster instance.	<ol style="list-style-type: none"><li>1. Configure the primary cluster instance by running the command: <pre>sudo /opt/aws/amazon-cloudwatch-agent/bin/amazon-cloudwatch-agent-config-wizard</pre></li><li>2. Choose <b>1</b> for Linux, and then select the options for your monitoring strategy.</li><li>3. For the question "<b>Do you want to monitor any log files,</b>" choose <b>Yes</b> and provide the path of the Pacemaker log file from the <b>pcs alert</b> command. In our case, it is <code>var/log/pcm_k_alert_file.log</code>.</li><li>4. Provide the name of the log group and log stream. If you don't specify a log stream, the AWS instance ID is used as the default.</li><li>5. Repeat steps 1-4 for the secondary cluster instance.</li></ol>	AWS administrator

Task	Description	Skills required
Start the CloudWatch agent on the primary and secondary cluster instances.	<p>To start the agent, run the following command on the EC2 instances in the primary and secondary clusters:</p> <pre>sudo /opt/aws/amazon-cloudwatch-agent/bin/amazon-cloudwatch-agent-ctl -a fetch-config -m ec2 -s -c file:/opt/aws/amazon-cloudwatch-agent/bin/config.json</pre>	AWS administrator

## Set up CloudWatch resources

Task	Description	Skills required
Set up CloudWatch log groups.	<ol style="list-style-type: none"> <li>1. Open the CloudWatch console at <a href="https://console.aws.amazon.com/cloudwatch/">https://console.aws.amazon.com/cloudwatch/</a></li> <li>2. In the navigation pane, choose <b>Log groups, Create log group</b>.</li> <li>3. Enter a name for the log group, and then choose <b>Create log group</b>.</li> </ol> <p>The CloudWatch agent will transfer the Pacemaker alert file to the CloudWatch log group as a log stream.</p>	AWS administrator

Task	Description	Skills required
Set up CloudWatch metric filters.	<p>Metric filters help you search for a pattern such as <code>stop &lt;cluster-resource-name&gt;</code> in the CloudWatch log streams. When this pattern is identified, the metric filter updates a custom metric.</p> <ol style="list-style-type: none"><li>1. On the CloudWatch console, in the navigation pane, choose <b>Log groups</b>.</li><li>2. Choose the name of the log group you created in the previous task.</li><li>3. Choose <b>Actions, Create metric filter</b>.</li><li>4. For <b>Filter pattern</b>, enter the filter pattern to use, such as <code>stop ABC_scs</code>, to match the stop event for an SAP SCS cluster resource named <code>ABC_scs</code>.  For more information, see <a href="#">Filter pattern syntax</a> in the CloudWatch documentation.</li><li>5. (Optional) To test your filter pattern, under <b>Test Pattern</b>, enter one or more log events to use to test the pattern. Each log event must be specified on a</li></ol>	AWS administrator, SAP Basis administrator

Task	Description	Skills required
	<p>separate line, because line breaks are used to separate log events in the <b>Log event messages</b> box.</p> <ol style="list-style-type: none"> <li>6. Choose <b>Next</b>, and then enter a name for the filter.</li> <li>7. Under <b>Metric details</b>, for <b>Metric namespace</b>, enter a name for the CloudWatch namespace where the metric will be published (for example, <code>sapcluster_monitoring</code> ). If this namespace doesn't already exist, select <b>Create new</b>.</li> <li>8. For <b>Metric name</b>, enter a name for the new metric (for example, <code>sapcluster_&lt;sid&gt;</code> , where <code>&lt;sid&gt;</code> is the SAP system identification name).</li> <li>9. For <b>Metric value</b>, enter <b>1</b>.</li> </ol> <p>Alternatively, you can enter a token such as <code>\$size</code>. This increments the metric by the value of the number in the <code>size</code> field for every log event that contains a <code>size</code> field.</p> <ol style="list-style-type: none"> <li>10 For <b>Default value</b>, enter <b>0</b>.</li> <li>11 Choose <b>Create metric filter</b>.</li> </ol>	

Task	Description	Skills required
	<p>When the metric filter identifies the pattern in step 4, it updates the value of the CloudWatch custom metric <code>sapcluster_abc</code> to <b>1</b>.</p> <p>The CloudWatch alarm <code>SAP-Cluster-QA1-ABC</code> monitors the metric <code>sapcluster_abc</code> and sends out an SNS notification when the value of the metric changes to <b>1</b>. This indicates that the cluster resource has stopped and action needs to be taken.</p>	

Task	Description	Skills required
Set up a CloudWatch metric alarm for the SAP ASCS/SCS and ERS metric.	<p>To create an alarm based on a single metric:</p> <ol style="list-style-type: none"><li>1. On the CloudWatch console, in the navigation pane, choose <b>Alarms, All alarms</b>.</li><li>2. Choose <b>Create alarm</b>.</li><li>3. Choose <b>Select Metric</b>.</li><li>4. Search for the custom metric <code>sapcluster_monitoring</code> that was created in the previous task.</li><li>5. Choose the metric name for SAP SCS (for example, <code>sapcluster_&lt;abc&gt;</code>), which was also created in the previous task.</li><li>6. On the <b>Graphed metrics</b> tab, set the following:<ul style="list-style-type: none"><li>• For <b>Statistic</b>, choose <b>Maximum</b>.</li><li>• For <b>Period</b>, choose <b>1 minute</b>.</li><li>• For <b>Threshold type</b>, choose <b>Static</b> and set the threshold for <code>sapcluster_&lt;sid&gt;</code> to a value that's greater than or equal to 1.</li></ul></li><li>7. Choose <b>Next</b>.</li></ol>	AWS administrator

Task	Description	Skills required
	<p>8. For <b>Notification</b>, select the SNS topic you created in the first epic.</p> <p>9. For <b>Name</b> and <b>Description</b>, provide the alarm name and a brief description, and then choose <b>Next</b>.</p> <p>10 Choose <b>Create Alarm</b>.</p>	
<p>Set up a CloudWatch metric alarm for the SAP HANA metric.</p>	<p>Repeat the steps for setting up a CloudWatch metric alarm from the previous task, with these changes:</p> <ul style="list-style-type: none"> <li>• For step 5, choose the metric name for SAP HANA (for example, <code>sapcluster_db_&lt;abc&gt;</code> ).</li> <li>• For step 6, set the threshold for <code>sapcluster_&lt;sid&gt;</code> to a value that's greater than 0.</li> </ul>	<p>AWS administrator</p>

## Related resources

- [Triggering Scripts for Cluster Events](#) (RHEL documentation)
- [Create the CloudWatch agent configuration file with the wizard](#) (CloudWatch documentation)
- [Installing and running the CloudWatch agent on your servers](#) (CloudWatch documentation)
- [Create a CloudWatch alarm based on a static threshold](#) (CloudWatch documentation)
- [Manual deployment of SAP HANA on AWS with high availability clusters](#) (SAP documentation on the AWS website)
- [SAP NetWeaver guides](#) (SAP documentation on the AWS website)

## Attachments

To access additional content that is associated with this document, unzip the following file:

[attachment.zip](#)



# Successfully import an S3 bucket as an AWS CloudFormation stack

Created by Ram Kandaswamy (AWS)

**Environment:** Production

**Technologies:** CloudNative;  
Storage & backup

**AWS services:** Amazon S3;  
AWS CloudFormation

## Summary

If you use Amazon Web Services (AWS) resources, such as Amazon Simple Storage Service (Amazon S3) buckets, and want to use an infrastructure as code (IaC) approach, then you can import your resources into AWS CloudFormation and manage them as a stack.

This pattern provides steps to successfully import an S3 bucket as an AWS CloudFormation stack. By using this pattern's approach, you can avoid possible errors that might occur if you import your S3 bucket in a single action.

## Prerequisites and limitations

### Prerequisites

- An active AWS account.
- An existing S3 bucket and S3 bucket policy. For more information about this, see [What S3 bucket policy should I use to comply with the AWS Config rule s3-bucket-ssl-requests-only](#) in the AWS Knowledge Center.
- An existing AWS Key Management Service (AWS KMS) key and its alias. For more information about this, see [Working with aliases](#) in the AWS KMS documentation.
- The sample CloudFormation-template-S3-bucket AWS CloudFormation template (attached), downloaded to your local computer.

## Architecture

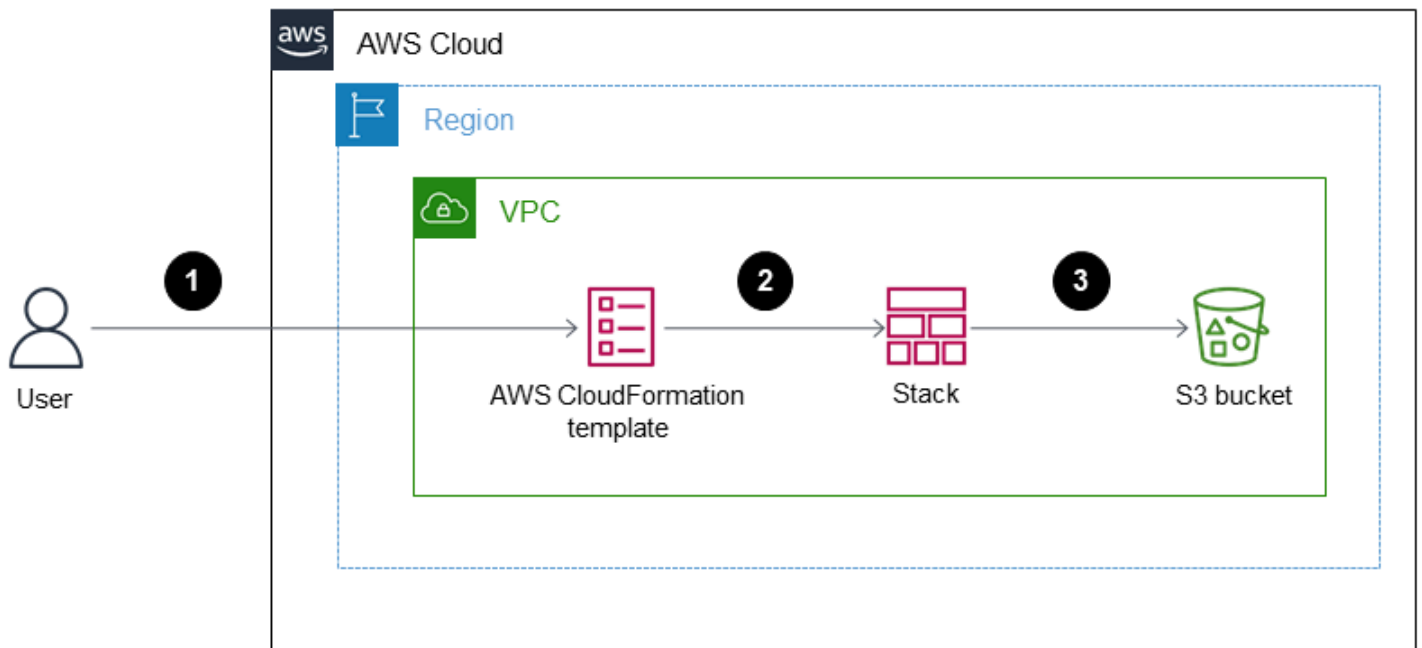

The diagram shows the following workflow:

1. The user creates a JSON or YAML-formatted AWS CloudFormation template.
2. The template creates an AWS CloudFormation stack to import the S3 bucket.
3. The AWS CloudFormation stack manages the S3 bucket that you specified in the template.

### Technology stack

- AWS CloudFormation
- AWS Identity and Access Management (IAM)
- AWS KMS
- Amazon S3

### Tools

- [AWS CloudFormation](#) – AWS CloudFormation helps you to create and provision AWS infrastructure deployments predictably and repeatedly.
- [AWS Identity and Access Management \(IAM\)](#) – IAM is a web service for securely controlling access to AWS services.

- [AWS KMS](#) – AWS Key Management Service (AWS KMS) is an encryption and key management service scaled for the cloud.
- [Amazon S3](#) – Amazon Simple Storage Service (Amazon S3) is storage for the Internet.

## Epics

### Import an S3 bucket with CMK-based encryption as an AWS CloudFormation stack

Task	Description	Skills required
<p>Create a template to import the S3 bucket and CMK.</p>	<p>On your local computer, create a template to import your S3 bucket and CMK by using the following sample template:</p> <pre data-bbox="594 915 1027 1885"> AWSTemplateFormatVersion: 2010-09-09  Parameters:    bucketName:      Type: String  Resources:    S3Bucket:      Type: 'AWS::S3::Bucket'      DeletionPolicy: Retain      Properties:        BucketName: !Ref bucketName </pre>	<p>AWS DevOps</p>

Task	Description	Skills required
	<pre> BucketEncryption:    ServerSideEncryptionConfiguration:      - ServerSideEncryptionByDefault:          SSEAlgorithm: 'aws:kms'          KMSMasterKeyID: !GetAtt            -              KMSSEKMSKeyID: !GetAtt                - Arn              KMSSEKMSKeyID:                Type: 'AWS::KMS::Key'                DeletionPolicy: Retain                Properties:                  Enabled: true                  KeyPolicy: !Sub  -                 {                    "Id": "key-consolepolicy-3",                    "Version": "2012-10-17", </pre>	

Task	Description	Skills required
	<pre> Statement": [   {     "Sid": "Enable IAM User Permissions",     "Effect": "Allow",     "Principal": {       "AWS": ["arn:aws:iam:: \${AWS::AccountId}:roo t"]     },     "Action": "kms:*",     "Resource": "*"   } ] } EnableKey Rotation: true </pre>	

Task	Description	Skills required
Create the stack.	<ol style="list-style-type: none"><li data-bbox="591 226 1027 594">1. Sign in to the AWS Management Console, open the AWS CloudFormation console, choose <b>View stack</b>, choose <b>Create stack</b>, and then choose <b>With existing resources (import resources)</b>.</li><li data-bbox="591 615 1027 793">2. Choose <b>Upload a template file</b> and then upload the template file that you created earlier.</li><li data-bbox="591 814 1027 1045">3. Enter a name for your stack and configure the remaining options according to your requirements.</li><li data-bbox="591 1066 1027 1245">4. Choose <b>Create stack</b> and wait for the stack's status to change to <code>IMPORT_COMPLETE</code>.</li></ol>	AWS DevOps

Task	Description	Skills required
Create the KMS key alias.	<ol style="list-style-type: none"><li>1. On the AWS CloudFormation console, choose <b>Stacks</b>, choose the name of the stack that you created earlier, choose the <b>Template</b> pane, and then choose <b>View in Designer</b>.</li><li>2. Add the following snippet to the Resource section of your template, and then choose <b>Create stack</b> and complete the wizard:</li></ol> <pre data-bbox="594 869 1029 1507">KMSSEncryptionAlias:    Type: 'AWS::KMS   ::Alias'    DeletionPolicy:   Retain    Properties:      AliasName: alias/     S3BucketKey      TargetKeyId: !Ref     KMSSEncryption</pre> <p>For more information about this, see <a href="#">AWS CloudFormation stack updates</a> in the AWS CloudFormation documentation.</p>	AWS DevOps

Task	Description	Skills required
Update the stack to include the S3 bucket policy.	<ol style="list-style-type: none"><li>1. On the AWS CloudFormation console, choose <b>Stacks</b>, choose the name of the stack that you created earlier, choose the <b>Template</b> pane, and then choose <b>View in Designer</b>.</li><li>2. Add the following snippet to the Resource section of the template, and then choose <b>Create stack</b> and complete the wizard:</li></ol> <pre data-bbox="594 869 1029 1877">S3BucketPolicy:    Type: 'AWS::S3: :BucketPolicy'    Properties:      Bucket: !Ref     S3Bucket      PolicyDocument: ! Sub  -        {          "Version": "2008-10- 17",          "Id": "restricthttp",          "Statement": [ </pre>	AWS DevOps



Task	Description	Skills required
	<pre> {   "Sid": "denyhttp",   "Effect": "Deny",   "Principal": {     "AWS": "*"   },   "Action": "s3:*",   "Resource": ["arn:aws:s3:::\${S3Bucket}", "arn:aws:s3:::\${S3Bucket}/*"],   "Condition": {     "Bool": {       "aws:SecureTransport": "false"     }   } } </pre>	

Task	Description	Skills required
	<pre data-bbox="594 205 1024 426"> } ] } </pre> <p data-bbox="594 464 1024 642"><b>Note:</b> This S3 bucket policy has a deny statement that restricts API calls that are not secure.</p>	
Update the key policy.	<ol data-bbox="594 684 1016 1503" style="list-style-type: none"> <li>1. On the AWS CloudFormation console, choose <b>Stacks</b>, choose the name of the stack that you created earlier, choose the <b>Template</b> pane, and then choose <b>View in Designer</b>.</li> <li>2. Modify the template's KMS resource to include the key policy that allows administrators to administer the CMK.</li> <li>3. Choose <b>Create stack</b>, choose <b>Next</b>, and then complete the wizard according to your requirements.</li> </ol> <p data-bbox="594 1581 1016 1850">For more information about this, see <a href="#">Using key policies in AWS KMS</a> and <a href="#">Allowing key administrators to administer the CMK</a> in the AWS KMS documentation.</p>	AWS administrator

Task	Description	Skills required
Add resource-level tags.	<ol style="list-style-type: none"><li>1. On the AWS CloudFormation console, choose <b>Stacks</b>, choose the name of the stack that you created earlier, choose the <b>Template</b> pane, and then choose <b>View in Designer</b>.</li><li>2. Add the following snippet to the Amazon S3 resource <code>Properties</code> section of the template, and then choose <b>Create stack</b> and complete the wizard:</li></ol> <div data-bbox="597 919 1027 1192" style="border: 1px solid #ccc; border-radius: 10px; padding: 10px; margin-top: 10px;"><p>Tags:</p><ul style="list-style-type: none"><li>- Key: <code>createdBy</code></li><li>Value: <code>Cloudformation</code></li></ul></div>	AWS DevOps

## Related resources

- [Bringing existing resources into AWS CloudFormation management](#)
- [AWS re:Invent 2017: Deep dive on AWS CloudFormation](#) (video)

## Attachments

To access additional content that is associated with this document, unzip the following file: [attachment.zip](#)

## More patterns

- [Associate an AWS CodeCommit repository in one AWS account with SageMaker Studio in another account](#)
- [Automate adding or updating Windows registry entries using AWS Systems Manager](#)
- [Automate Amazon Lookout for Vision training and deployment for anomaly detection](#)
- [Automate the creation of AppStream 2.0 resources using AWS CloudFormation](#)
- [Automatically build and deploy a Java application to Amazon EKS using a CI/CD pipeline](#)
- [Automatically create an RFC in AMS using Python](#)
- [Build a Micro Focus Enterprise Server PAC with Amazon EC2 Auto Scaling and Systems Manager](#)
- [Chain AWS services together using a serverless approach](#)
- [Check EC2 instances for mandatory tags at launch](#)
- [Configure Veritas NetBackup for VMware Cloud on AWS](#)
- [Connect to an Amazon EC2 instance by using Session Manager](#)
- [Create alarms for custom metrics using Amazon CloudWatch anomaly detection](#)
- [Create an Amazon ECS task definition and mount a file system on EC2 instances using Amazon EFS](#)
- [Create tag-based Amazon CloudWatch dashboards automatically](#)
- [Deploy a clustered application to Amazon ECS by using AWS Copilot](#)
- [Deploy a React-based single-page application to Amazon S3 and CloudFront](#)
- [Deploy and debug Amazon EKS clusters](#)
- [Deploy and manage AWS Control Tower controls by using AWS CDK and AWS CloudFormation](#)
- [Deploy and manage AWS Control Tower controls by using Terraform](#)
- [Deploy containers by using Elastic Beanstalk](#)
- [Deploy Lambda functions with container images](#)
- [Detect Amazon RDS and Aurora database instances that have expiring CA certificates](#)
- [Document institutional knowledge from voice inputs by using Amazon Bedrock and Amazon Transcribe](#)
- [Enforce automatic tagging of Amazon RDS databases at launch](#)
- [Estimate the cost of a DynamoDB table for on-demand capacity](#)
- [Export Amazon RDS for SQL Server tables to an S3 bucket by using AWS DMS](#)

- [Generate personalized and re-ranked recommendations using Amazon Personalize](#)
- [Generate test data using an AWS Glue job and Python](#)
- [Get Amazon SNS notifications when the key state of an AWS KMS key changes](#)
- [Help enforce DynamoDB tagging](#)
- [Identify and alert when Amazon Data Firehose resources are not encrypted with an AWS KMS key](#)
- [Improve operational performance by enabling Amazon DevOps Guru across multiple AWS Regions, accounts, and OUs with the AWS CDK](#)
- [Migrate a Microsoft SQL Server database from Amazon EC2 to Amazon DocumentDB by using AWS DMS](#)
- [Migrate DNS records in bulk to an Amazon Route 53 private hosted zone](#)
- [Monitor Amazon ElastiCache clusters for at-rest encryption](#)
- [Monitor Amazon EMR clusters for in-transit encryption at launch](#)
- [Monitor ElastiCache clusters for security groups](#)
- [Replicate mainframe databases to AWS by using Precisely Connect](#)
- [Send telemetry data from AWS Lambda to OpenSearch for real-time analytics and visualization](#)
- [Structure a Python project in hexagonal architecture using AWS Lambda](#)
- [Update AWS CLI credentials from AWS IAM Identity Center by using PowerShell](#)
- [View AWS Network Firewall logs and metrics by using Splunk](#)

# Containers & microservices

## Topics

- [Access an Amazon Neptune database from an Amazon EKS container](#)
- [Access container applications privately on Amazon ECS by using AWS PrivateLink and a Network Load Balancer](#)
- [Access container applications privately on Amazon ECS by using AWS Fargate, AWS PrivateLink, and a Network Load Balancer](#)
- [Access container applications privately on Amazon EKS using AWS PrivateLink and a Network Load Balancer](#)
- [Activate mTLS in AWS App Mesh using AWS Private CA on Amazon EKS](#)
- [Automate backups for Amazon RDS for PostgreSQL DB instances by using AWS Batch](#)
- [Automate deployment of Node Termination Handler in Amazon EKS by using a CI/CD pipeline](#)
- [Automatically build and deploy a Java application to Amazon EKS using a CI/CD pipeline](#)
- [Create an Amazon ECS task definition and mount a file system on EC2 instances using Amazon EFS](#)
- [Deploy Java microservices on Amazon ECS using AWS Fargate](#)
- [Deploy Java microservices on Amazon ECS using Amazon ECR and AWS Fargate](#)
- [Deploy Java microservices on Amazon ECS using Amazon ECR and load balancing](#)
- [Deploy Kubernetes resources and packages using Amazon EKS and a Helm chart repository in Amazon S3](#)
- [Deploy Lambda functions with container images](#)
- [Deploy a sample Java microservice on Amazon EKS and expose the microservice using an Application Load Balancer](#)
- [Deploy a clustered application to Amazon ECS by using AWS Copilot](#)
- [Deploy a gRPC-based application on an Amazon EKS cluster and access it with an Application Load Balancer](#)
- [Deploy and debug Amazon EKS clusters](#)
- [Deploy containers by using Elastic Beanstalk](#)
- [Generate a static outbound IP address using a Lambda function, Amazon VPC, and a serverless architecture](#)

- [Identify duplicate container images automatically when migrating to an Amazon ECR repository](#)
- [Install SSM Agent on Amazon EKS worker nodes by using Kubernetes DaemonSet](#)
- [Install the SSM Agent and CloudWatch agent on Amazon EKS worker nodes using preBootstrapCommands](#)
- [Optimize AWS App2Container generated Docker images](#)
- [Place Kubernetes Pods on Amazon EKS by using node affinity, taints, and tolerations](#)
- [Replicate filtered Amazon ECR container images across accounts or Regions](#)
- [Rotate database credentials without restarting containers](#)
- [Run Amazon ECS tasks on Amazon WorkSpaces with Amazon ECS Anywhere](#)
- [Run an ASP.NET Core web API Docker container on an Amazon EC2 Linux instance](#)
- [Run message-driven workloads at scale by using AWS Fargate](#)
- [Run stateful workloads with persistent data storage by using Amazon EFS on Amazon EKS with AWS Fargate](#)
- [More patterns](#)

# Access an Amazon Neptune database from an Amazon EKS container

Created by Ramakrishnan Palaninathan (AWS)

**Environment:** Production

**Technologies:** Containers & microservices; Databases

**Workload:** All other workloads

**AWS services:** Amazon EKS; Amazon Neptune

## Summary

This pattern establishes a connection between Amazon Neptune, which is a fully managed graph database, and Amazon Elastic Kubernetes Service (Amazon EKS), a container orchestration service, to access a Neptune database. Neptune DB clusters are confined within a virtual private cloud (VPC) on AWS. For this reason, accessing Neptune requires careful configuration of the VPC to enable connectivity.

Unlike Amazon Relational Database Service (Amazon RDS) for PostgreSQL, Neptune doesn't rely on typical database access credentials. Instead, it uses AWS Identity and Access Management (IAM) roles for authentication. Therefore, connecting to Neptune from Amazon EKS involves setting up an IAM role with the necessary permissions to access Neptune.

Furthermore, Neptune endpoints are accessible only within the VPC where the cluster resides. This means that you have to configure network settings to facilitate communication between Amazon EKS and Neptune. Depending on your specific requirements and networking preferences, there are [various approaches to configuring the VPC](#) to enable seamless connectivity between Neptune and Amazon EKS. Each method offers distinct advantages and considerations, which provide flexibility in designing your database architecture to suit your application's needs.

## Prerequisites and limitations

### Prerequisites

- Install the latest version of **kubectl** (see [instructions](#)). To check your version, run:



```
kubectl version --short
```

- Install the latest version of **eksctl** (see [instructions](#)). To check your version, run:

```
eksctl info
```

- Install the latest version of the AWS Command Line Interface (AWS CLI) version 2 (see [instructions](#)). To check your version, run:

```
aws --version
```

- Create a Neptune DB cluster (see [instructions](#)). Make sure to establish communications between the cluster's VPC and Amazon EKS through [VPC peering](#), [AWS Transit Gateway](#), or another method. Also make sure that the status of the cluster is “available” and that it has an inbound rule on port 8182 for the security group.
- Configure an IAM OpenID Connect (OIDC) provider on an existing Amazon EKS cluster (see [instructions](#)).

## Product versions

- [Amazon EKS 1.27](#)
- [Amazon Neptune engine version 1.3.0.0 \(2023-11-15\)](#)

## Architecture

The following diagram shows the connection between Kubernetes pods in an Amazon EKS cluster and Neptune to provide access to a Neptune database.

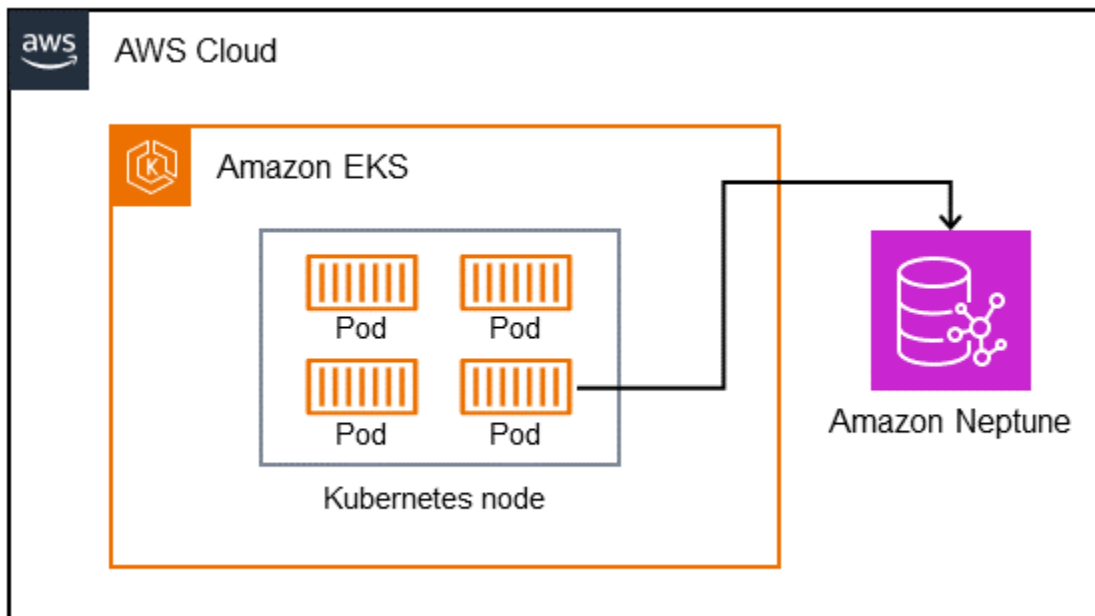

## Automation and scale

You can use the Amazon EKS [Horizontal Pod Autoscaler](#) to scale this solution.

## Tools

### Services

- [Amazon Elastic Kubernetes Service \(Amazon EKS\)](#) helps you run Kubernetes on AWS without needing to install or maintain your own Kubernetes control plane or nodes.
- [AWS Identity and Access Management \(IAM\)](#) helps you securely manage access to your AWS resources by controlling who is authenticated and authorized to use them.
- [Amazon Neptune](#) is a graph database service that helps you build and run applications that work with highly connected datasets.

## Best practices

For best practices, see [Identity and Access Management](#) in the *Amazon EKS Best Practices Guides*.

# Epics

## Set environment variables

Task	Description	Skills required
Verify the cluster context.	<p>Before you interact with your Amazon EKS cluster by using Helm or other command-line tools, you must define environment variables that encapsulate your cluster's details. These variables are used in subsequent commands to ensure that they target the correct cluster and resources.</p> <p>First, confirm that you are operating within the correct cluster context. This ensures that any subsequent commands are sent to the intended Kubernetes cluster. To verify the current context, run the following command.</p> <pre>kubectl config current-context</pre>	AWS administrator, Cloud administrator
Define the CLUSTER_NAME variable.	Define the CLUSTER_NAME environment variable for your Amazon EKS cluster. In the following command, replace the sample value <code>us-west-2</code> with the correct AWS Region for your cluster.	AWS administrator, Cloud administrator

Task	Description	Skills required
	<p>Replace the sample value <code>eks-workshop</code> with your existing cluster name.</p> <pre data-bbox="597 380 1027 659">export CLUSTER_NAME=\$(aws eks describe-cluster --region us-west-2 --name eks-workshop --query "cluster.name" --output text)</pre>	
Validate output.	<p>To validate that the variables have been set properly, run the following command.</p> <pre data-bbox="597 863 1027 940">echo \$CLUSTER_NAME</pre> <p>Verify that the output of this command matches the input you specified in the previous step.</p>	AWS administrator, Cloud administrator

## Create IAM role and associate it with Kubernetes

Task	Description	Skills required
Create a service account.	<p>You use <a href="#">IAM roles for service accounts</a> to map your Kubernetes service accounts to IAM roles, to enable fine-grained permissions management for your applications that run on Amazon EKS. You can use <a href="#">eksctl</a> to create</p>	AWS administrator, Cloud administrator

Task	Description	Skills required
	<p>and associate an IAM role with a specific Kubernetes service account within your Amazon EKS cluster. The AWS managed policy <code>NeptuneFullAccess</code> allows write and read access to your specified Neptune cluster.</p> <p><b>Important:</b> You must have an <a href="#">OIDC endpoint</a> associated with your cluster before you run these commands.</p> <p>Create a service account that you want to associate with an AWS managed policy named <code>NeptuneFullAccess</code> .</p> <pre>eksctl create iamserviceaccount --name eks-neptune-sa --namespace default --cluster \$CLUSTER_NAME --attach-policy-arn arn:aws:iam::aws:policy/NeptuneFullAccess --approve --override-existing-serviceaccounts</pre> <p>where <code>eks-neptune-sa</code> is the name of the service account that you want to create.</p>	

Task	Description	Skills required
	<p>Upon completion, this command displays the following response:</p> <pre data-bbox="597 380 1026 575">2024-02-07 01:12:39 [#] created serviceaccount "default/eks-neptune- sa"</pre>	

Task	Description	Skills required
Verify that the account is set up properly.	<p>Make sure that the eks-neptune-sa service account is set up correctly in the default namespace in your cluster.</p> <pre>kubectl get sa eks-neptune-sa -o yaml</pre> <p>The output should look like this:</p> <pre>apiVersion: v1 kind: ServiceAccount metadata:   annotations:     eks.amazonaws.com/role-arn: arn:aws:iam::123456789123:role/eksctl-eks-workshop-addon-iam-serviceaccount-d-Role1-Q35yKgdQ0lmM   creationTimestamp: "2024-02-07T01:12:39Z"   labels:     app.kubernetes.io/managed-by: eksctl     name: eks-neptune-sa     namespace: default   resourceVersion: "5174750"   uid: cd6ba2f7-a0f5-40e1-a6f4-4081e0042316</pre>	AWS administrator, Cloud administrator

Task	Description	Skills required
Check connectivity.	<p>Deploy a sample pod called pod-util and check connectivity with Neptune.</p> <pre> apiVersion: v1 kind: Pod metadata:   name: pod-util   namespace: default spec:   serviceAccountName:     eks-neptune-sa   containers:   - name: pod-util     image: public.ecr.aws/patrickc/troubleshoot-util     command:       - sleep       - "3600"     imagePullPolicy:       IfNotPresent </pre> <pre> kubectl apply -f pod-util.yaml </pre> <pre> kubectl exec --stdin --tty pod-util -- /bin/bash bash-5.1# curl -X POST -d '{"gremlin":"g.V().limit(1)}' https://db-neptune-1.cluster-xxxxxxxxxxxx.us-west-2.neptune.amazonaws.com:8182/gremlin {"requestId":"a4964fd-12b1-4ed3-8a14-e </pre>	AWS administrator, Cloud administrator



Task	Description	Skills required
	<pre>ff511431a0e", "status": {"message": "", "code": 200, "attributes": {"@type": "g:Map", "value": []}} , "result": {"data": {"@type": "g:List", "@value": []}, "meta": {"@type": "g:Map", "@value": []}}}} bash-5.1# exit exit</pre>	

## Validate connection activity

Task	Description	Skills required
Enable IAM database authentication.	<p>By default, IAM database authentication is disabled when you create a Neptune DB cluster. You can enable or disable IAM database authentication by using the AWS Management Console.</p> <p>Follow the steps in the AWS documentation to <a href="#">enable IAM database authentication in Neptune</a>.</p>	AWS administrator, Cloud administrator
Verify connections.	In this step, you interact with the <code>pod-util</code> container, which is already in running status, to install <code>awscurl</code> and verify the connection.	AWS administrator, Cloud administrator

Task	Description	Skills required
	<p>1. Run the following command to find the pod.</p> <pre>kubectl get pods</pre> <p>The output should look like this:</p> <pre>NAME READY STATUS RESTARTS AGE pod-util 1/1 Running 0 50m</pre> <p>2. Run the following command to install <b>awscurl</b>.</p> <pre>kubectl exec --stdin --tty pod-util -- / bin/bash bash-5.1# pip3 install awscurl Installing collected packages: idna, configparser, configargparse, charset-normalizer , certifi, requests, awscurl Successfully installed awscurl-0 .32 certifi-2024.2.2 charset-normalizer -3.3.2 configarg parse-1.7 configpar ser-6.0.0 idna-3.6 requests-2.31.0 bash-5.1# awscurl https://db-neptune -1.cluster-xxxxxxx xxxxx.us-west-2.ne ptune.amazonaws.co</pre>	

Task	Description	Skills required
	<pre> m:8182/status -- region us-west-2 -- service neptune-db {"status":"healthy ","startTime":"Thu Feb 08 01:22:14 UTC 2024","dbEngineVer sion":"1.3.0.0.R1" ,"role":"writer"," dfeQueryEngine":"v iaQueryHint","grem lin":{"version":"t inkerpop-3.6.4"}," sparql":{"version" :"sparql-1.1"},"op encypher":{"versio n":"Neptune-9.0.20 190305-1.0"},"labM ode":{"ObjectIndex ":"disabled","Read WriteConflictDetec tion":"enabled"}," features":{"SlowQu eryLogs":"disabled ","ResultCache":{" status":"disabled" },"IAMAuthenticati on":"enabled","Str eams":"disabled"," AuditLog":"disable d"},"settings":{"c lusterQueryTimeout InMs":"120000","Sl owQueryLogsThresho ld":"5000"}} </pre>	

## Troubleshooting

Issue	Solution
Can't access the Neptune database.	Review the IAM policy that's attached to the service account. Make sure that it allows the necessary actions (for example, <code>neptune:Connect</code> , <code>neptune:DescribeDBInstances</code> ) for the operations you want to run.

## Related resources

- [Grant Kubernetes workloads access to AWS using Kubernetes Service Accounts](#) (Amazon EKS documentation)
- [IAM roles for service accounts](#) (Amazon EKS documentation)
- [Creating a new Neptune DB cluster](#) (Amazon Neptune documentation)

# Access container applications privately on Amazon ECS by using AWS PrivateLink and a Network Load Balancer

Created by Kirankumar Chandrashekar (AWS)

**Environment:** Production

**Technologies:** Containers & microservices; Networking; Security, identity, compliance; Web & mobile apps

**Workload:** All other workloads

**AWS services:** Amazon EC2; Amazon EC2 Auto Scaling; Amazon EC2 Container Registry; Amazon EFS; Amazon RDS; Amazon VPC; Amazon ECS; Elastic Load Balancing (ELB); AWS Lambda

## Summary

This pattern describes how to privately host a Docker container application on Amazon Elastic Container Service (Amazon ECS) behind a Network Load Balancer, and access the application by using AWS PrivateLink. You can then use a private network to securely access services on the Amazon Web Services (AWS) Cloud. Amazon Relational Database Service (Amazon RDS) hosts the relational database for the application running on Amazon ECS with high availability (HA). Amazon Elastic File System (Amazon EFS) is used if the application requires persistent storage.

The Amazon ECS service running the Docker applications, with a Network Load Balancer at the front end, can be associated with a virtual private cloud (VPC) endpoint for access through AWS PrivateLink. This VPC endpoint service can then be shared with other VPCs by using their VPC endpoints.

You can also use [AWS Fargate](#) instead of an Amazon EC2 Auto Scaling group. For more information, see [Access container applications privately on Amazon ECS by using AWS Fargate, AWS PrivateLink, and a Network Load Balancer](#).

## Prerequisites and limitations

### Prerequisites

- An active AWS account
- [AWS Command Line Interface \(AWS CLI\) version 2](#), installed and configured on Linux, macOS, or Windows
- [Docker](#), installed and configured on Linux, macOS, or Windows
- An application running on Docker

### Architecture

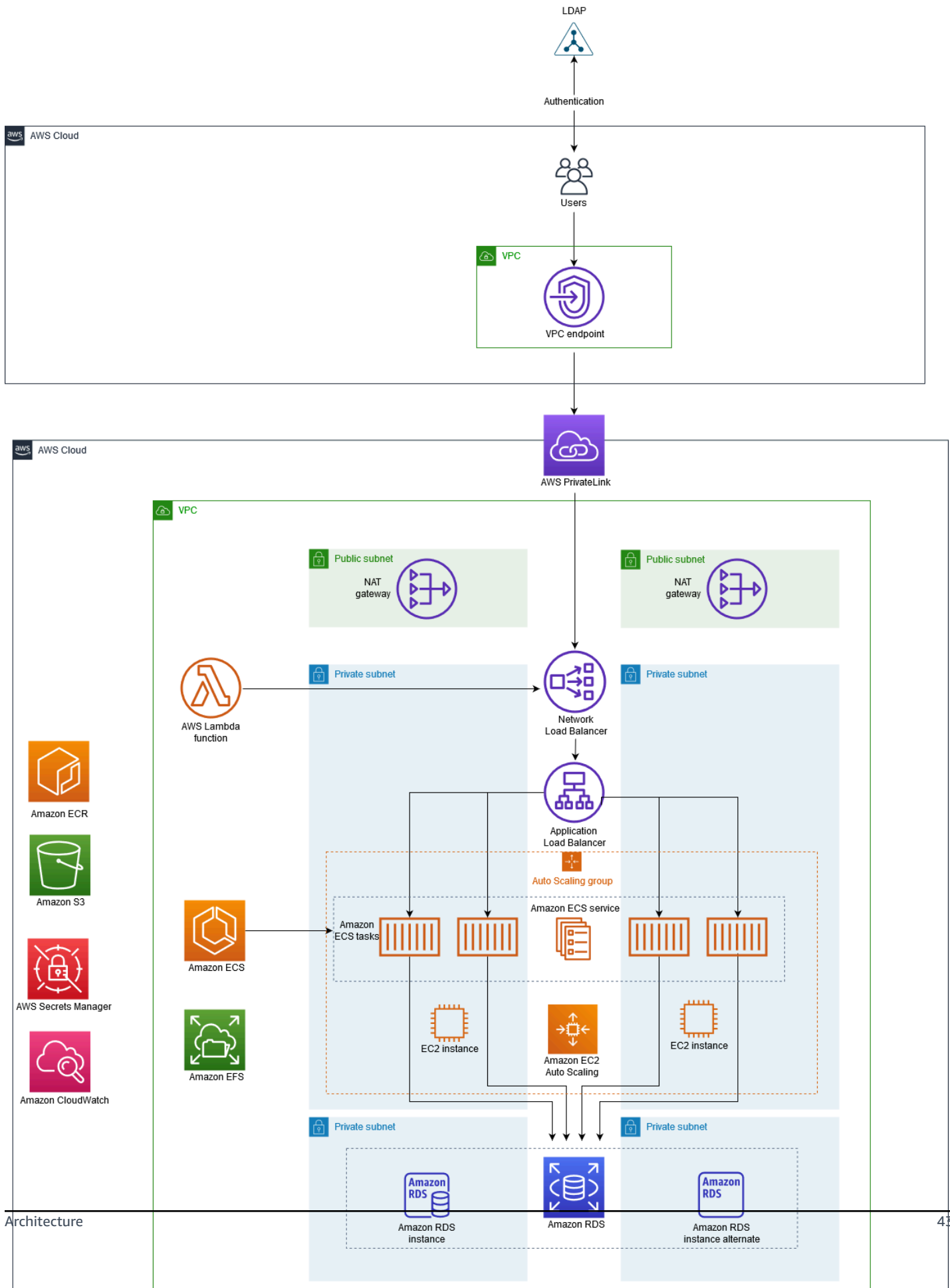

## Technology stack

- Amazon CloudWatch
- Amazon Elastic Compute Cloud (Amazon EC2)
- Amazon EC2 Auto Scaling
- Amazon Elastic Container Registry (Amazon ECR)
- Amazon ECS
- Amazon RDS
- Amazon Simple Storage Service (Amazon S3)
- AWS Lambda
- AWS PrivateLink
- AWS Secrets Manager
- Application Load Balancer
- Network Load Balancer
- VPC

### *Automation and scale*

- You can use [AWS CloudFormation](#) to create this pattern by using [Infrastructure as Code](#).

## Tools

- [Amazon EC2](#) – Amazon Elastic Compute Cloud (Amazon EC2) provides scalable computing capacity in the AWS Cloud.
- [Amazon EC2 Auto Scaling](#) – Amazon EC2 Auto Scaling helps you ensure that you have the correct number of Amazon EC2 instances available to handle the load for your application.
- [Amazon ECS](#) – Amazon Elastic Container Service (Amazon ECS) is a highly scalable, fast, container management service that makes it easy to run, stop, and manage containers on a cluster.
- [Amazon ECR](#) – Amazon Elastic Container Registry (Amazon ECR) is a managed AWS container image registry service that is secure, scalable, and reliable.
- [Amazon EFS](#) – Amazon Elastic File System (Amazon EFS) provides a simple, scalable, fully managed elastic NFS file system for use with AWS Cloud services and on-premises resources.



- [AWS Lambda](#) – Lambda is a compute service for running code without provisioning or managing servers.
- [Amazon RDS](#) – Amazon Relational Database Service (Amazon RDS) is a web service that makes it easier to set up, operate, and scale a relational database in the AWS Cloud.
- [Amazon S3](#) – Amazon Simple Storage Service (Amazon S3) is storage for the internet. It is designed to make web-scale computing easier for developers.
- [AWS Secrets Manager](#) – Secrets Manager helps you replace hardcoded credentials in your code, including passwords, by providing an API call to Secrets Manager to retrieve the secret programmatically.
- [Amazon VPC](#) – Amazon Virtual Private Cloud (Amazon VPC) helps you launch AWS resources into a virtual network that you've defined.
- [Elastic Load Balancing](#) – Elastic Load Balancing distributes incoming application or network traffic across multiple targets, such as Amazon EC2 instances, containers, and IP addresses, in multiple Availability Zones.
- [Docker](#) – Docker helps developers to pack, ship, and run any application as a lightweight, portable, and self-sufficient container.

## Epics

### Create networking components

Task	Description	Skills required
Create a VPC.	<ol style="list-style-type: none"> <li>1. Sign in to the AWS Management Console and open the Amazon VPC console. Choose <b>Create VPC</b>, and choose <b>VPC and more</b>.</li> <li>2. Enter a name for your VPC, and choose an appropriate CIDR block range.</li> <li>3. Specify two Availability Zones, two public subnets, four private subnets. Two</li> </ol>	Cloud administrator

Task	Description	Skills required
	<p>private subnets are for Amazon ECS tasks, and two private subnets are for Amazon RDS databases.</p> <p>4. Specify one NAT gateway for each Availability Zone.</p> <p>5. Choose <b>Create VPC</b>.</p>	

## Create the load balancers

Task	Description	Skills required
Create a Network Load Balancer.	<ol style="list-style-type: none"> <li>1. Open the Amazon EC2 console and choose the AWS Region that contains your VPC.</li> <li>2. Under <b>Load balancing</b>, choose <b>Load balancers</b>, and choose <b>Create load balancer</b>.</li> <li>3. Choose <b>Network Load Balancer</b>, and choose <b>Create</b>.</li> <li>4. On the <b>Configure load balancer</b> page, configure your Network Load Balancer and listener. <b>Important:</b> Make sure you choose your Network Load Balancer's scheme as <b>Internal</b>.</li> <li>5. Choose the applicable security settings,</li> </ol>	Cloud administrator

Task	Description	Skills required
	<p>configure a security group and a target group. Choose <b>Instance</b> or <b>IP</b> as the <b>Target type</b> in the <b>Configure routing</b> section. Make sure you do not register a target.</p> <p>6. When you have configured all the settings, choose <b>Next: Review</b>, and then choose <b>Create</b>.</p>	

Task	Description	Skills required
Create an Application Load Balancer.	<ol style="list-style-type: none"><li data-bbox="591 226 1026 405">1. On the Amazon EC2 console, choose the same Region that contains your VPC.</li><li data-bbox="591 426 1026 604">2. Under <b>Load balancing</b>, choose <b>Load balancers</b>, and choose <b>Create load balancer</b>.</li><li data-bbox="591 625 1026 762">3. Choose <b>Application Load Balancer</b>, and choose <b>Create</b>.</li><li data-bbox="591 783 1026 1056">4. Configure your Application Load Balancer and its listener. <b>Important:</b> Make sure you choose your Application Load Balancer's scheme as <b>Internal</b>.</li><li data-bbox="591 1077 1026 1497">5. Choose the applicable security settings, configure a security group and a target group. Choose <b>Instance</b> or <b>IP</b> as the <b>Target type</b> in the <b>Configure routing</b> section. Make sure you do not register a target.</li><li data-bbox="591 1518 1026 1696">6. When you have configured all the settings, choose <b>Next: Review</b>, and then choose <b>Create</b>.</li></ol>	Cloud administrator

## Create an Amazon EFS file system

Task	Description	Skills required
Create an Amazon EFS file system.	<ol style="list-style-type: none"><li>1. Open the Amazon EFS console, and choose <b>Create file system</b>.</li><li>2. In the <b>Create file system</b> dialog box, enter a name for your file system, and choose your VPC.</li><li>3. Choose <b>Create</b> to create the file system.</li><li>4. Set up and configure your Amazon EFS file system.</li></ol>	Cloud administrator
Mount targets for the subnets.	<ol style="list-style-type: none"><li>1. Return to the Amazon EFS console, and choose <b>File systems</b>. The <b>File systems</b> page shows the Amazon EFS file systems in your account.</li><li>2. Choose the file system that you created, and choose <b>Manage</b> to display the <b>Availability Zones</b>. To add a mount target, choose <b>Add mount target</b>, and add the four private subnets that you created.</li></ol>	Cloud administrator
Verify that the subnets are mounted as targets.	<ol style="list-style-type: none"><li>1. On the Amazon EFS console, choose <b>File systems</b>.</li><li>2. Choose <b>Network</b> to display the list of existing mount</li></ol>	Cloud administrator

Task	Description	Skills required
	targets. Make sure that these include the four subnets that you created.	

### Create an S3 bucket

Task	Description	Skills required
Create an S3 bucket.	Open the Amazon S3 console and create an S3 bucket to store your application's static assets, if required.	Cloud administrator

### Create a Secrets Manager secret

Task	Description	Skills required
Create an AWS KMS key to encrypt the Secrets Manager secret.	Open the AWS Key Management Service (AWS KMS) console and create a KMS key.	Cloud administrator
Create a Secrets Manager secret to store the Amazon RDS password.	<ol style="list-style-type: none"> <li>1. Open the AWS Secrets Manager console, and create a new secret by choosing <b>Store a new secret</b>.</li> <li>2. Choose the KMS key that you created, and store your new secret.</li> </ol>	Cloud Administrator

## Create an Amazon RDS instance

Task	Description	Skills required
Create a DB subnet group.	<ol style="list-style-type: none"><li>1. Open the Amazon RDS console and choose <b>Subnet groups</b>.</li><li>2. Choose <b>Create DB subnet group</b>, and enter a name and description for your DB subnet group.</li><li>3. Choose the VPC that you created earlier, and choose the Availability Zones and subnets. Then choose <b>Create</b>.</li></ol>	Cloud administrator
Create an Amazon RDS instance.	Create and configure an Amazon RDS instance within the private subnets. Make sure that <b>Multi-AZ</b> is turned on for HA.	Cloud administrator
Load data to the Amazon RDS instance.	Load the relational data required by your application into your Amazon RDS instance. This process will vary depending on your application's needs, as well as how your database schema is defined and designed.	Cloud administrator, DBA

## Create the Amazon ECS components

Task	Description	Skills required
Create an ECS cluster.	<ol style="list-style-type: none"> <li>1. Open the Amazon ECS console, and choose <b>Clusters</b>.</li> <li>2. Choose <b>Create clusters</b>, and set up an ECS cluster according to your required specifications.</li> </ol>	Cloud administrator
Create the Docker images.	Create the Docker images by following the instructions in the <i>Related resources</i> section.	Cloud administrator
Create Amazon ECR repositories.	<ol style="list-style-type: none"> <li>1. On the Amazon ECR console, choose <b>Repositories</b>.</li> <li>2. Choose <b>Create repository</b>, and enter a unique name for your repository.</li> <li>3. Configure the repository according to your specifications, including AWS KMS encryption if required.</li> </ol>	Cloud administrator, DevOps engineer
Authenticate your Docker client for the Amazon ECR repository.	To authenticate your Docker client for the Amazon ECR repository, run the <code>aws ecr get-login-password</code> command in the AWS CLI.	Cloud administrator
Push the Docker images to the Amazon ECR repository.	<ol style="list-style-type: none"> <li>1. Identify the Docker image you want to push, and run the <code>docker images</code> command in the AWS CLI.</li> </ol>	Cloud administrator



Task	Description	Skills required
	<ol style="list-style-type: none"> <li>2. Tag your image with the Amazon ECR registry, repository, and optional image tag name combination.</li> <li>3. Push the Docker image by running the <code>docker push</code> command.</li> <li>4. Repeat these steps for all required images.</li> </ol>	
<p>Create an Amazon ECS task definition.</p>	<p>A task definition is required to run Docker containers in Amazon ECS.</p> <ol style="list-style-type: none"> <li>1. Return to the Amazon ECS console, choose <b>Task definitions</b>, and then choose <b>Create new task definition</b>.</li> <li>2. On the <b>Select compatibilities</b> page, select the launch type that your task should use, and choose <b>Next step</b>.</li> </ol> <p>For help with setting up your task definition, see “Creating a task definition” in the <i>Related resources</i> section. <b>Important:</b> Make sure you provide the Docker images that you pushed to Amazon ECR.</p>	<p>Cloud administrator</p>

Task	Description	Skills required
Create an Amazon ECS service.	Create an Amazon ECS service by using the ECS cluster you created earlier. Make sure you choose Amazon EC2 as the launch type, and choose the task definition created in the previous step, as well as the target group of the Application Load Balancer.	Cloud administrator

### Create an Amazon EC2 Auto Scaling group

Task	Description	Skills required
Create a launch configuration.	Open the Amazon EC2 console, and create a launch configuration. Make sure that the user data has the code to allow the EC2 instances to join the desired ECS cluster. For an example of the code required, see the <i>Related resources</i> section.	Cloud administrator
Create an Amazon EC2 Auto Scaling group.	Return to the Amazon EC2 console and under <b>Auto Scaling</b> , choose <b>Auto Scaling groups</b> . Set up an Amazon EC2 Auto Scaling group. Make sure you choose the private subnets and launch configuration that you created earlier.	Cloud administrator

## Set up AWS PrivateLink

Task	Description	Skills required
Set up the AWS PrivateLink endpoint.	<ol style="list-style-type: none"><li>1. On the Amazon VPC console, create an AWS PrivateLink endpoint.</li><li>2. Associate this endpoint with the Network Load Balancer, which makes the application hosted on Amazon ECS available privately to customers.</li></ol> <p>For more information, see the <i>Related resources</i> section.</p>	Cloud administrator

## Create a VPC endpoint

Task	Description	Skills required
Create a VPC endpoint.	Create a VPC endpoint for the AWS PrivateLink endpoint that you created earlier. The VPC endpoint Fully Qualified Domain Name (FQDN) will point to the AWS PrivateLink endpoint FQDN. This creates an elastic network interface to the VPC endpoint service that the DNS endpoints can access.	Cloud administrator

## Create the Lambda function

Task	Description	Skills required
Create the Lambda function.	On the AWS Lambda console, create a Lambda function to update the Application Load Balancer IP addresses as targets for the Network Load Balancer. For more information on this, see the "Using static IP addresses for Application Load Balancers" blog post in the <i>Related resources</i> section.	App developer

## Related resources

### Create the load balancers:

- [Create a Network Load Balancer](#)
- [Create an Application Load Balancer](#)

### Create an Amazon EFS file system:

- [Create an Amazon EFS file system](#)
- [Create mount targets in Amazon EFS](#)

### Create an S3 bucket:

- [Create an S3 bucket](#)

### Create a Secrets Manager secret:

- [Create keys in AWS KMS](#)
- [Create a secret in AWS Secrets Manager](#)

**Create an Amazon RDS instance:**

- [Create an Amazon RDS DB instance](#)

**Create the Amazon ECS components:**

- [Create an Amazon ECS cluster](#)
- [Create a Docker image](#)
- [Create an Amazon ECR repository](#)
- [Authenticate Docker with Amazon ECR repository](#)
- [Push an image to an Amazon ECR repository](#)
- [Create Amazon ECS task definition](#)
- [Create an Amazon ECS service](#)

**Create an Amazon EC2 Auto Scaling group:**

- [Create a launch configuration](#)
- [Create an Auto Scaling group using a launch configuration](#)
- [Bootstrap container instances with Amazon EC2 user data](#)

**Set up AWS PrivateLink:**

- [VPC endpoint services \(AWS PrivateLink\)](#)

**Create a VPC endpoint:**

- [Interface VPC endpoints \(AWS PrivateLink\)](#)

**Create the Lambda function:**

- [Create a Lambda function](#)

**Other resources:**

- [Using static IP addresses for Application Load Balancers](#)

- [Securely accessing services over AWS PrivateLink](#)

# Access container applications privately on Amazon ECS by using AWS Fargate, AWS PrivateLink, and a Network Load Balancer

Created by Kirankumar Chandrashekar (AWS)

**Environment:** Production

**Technologies:** Containers & microservices; Networking; Security, identity, compliance; Web & mobile apps

**Workload:** All other workloads

**AWS services:** Amazon EC2 Container Registry; Amazon ECS; Amazon EFS; Amazon RDS; Amazon VPC; Elastic Load Balancing (ELB); AWS Lambda

## Summary

This pattern describes how to privately host a Docker container application on the Amazon Web Services (AWS) Cloud by using Amazon Elastic Container Service (Amazon ECS) with an AWS Fargate launch type, behind a Network Load Balancer, and access the application by using AWS PrivateLink. Amazon Relational Database Service (Amazon RDS) hosts the relational database for the application running on Amazon ECS with high availability (HA). You can use Amazon Elastic File System (Amazon EFS) if the application requires persistent storage.

This pattern uses a [Fargate launch type](#) for the Amazon ECS service running the Docker applications, with a Network Load Balancer at the front end. It can then be associated with a virtual private cloud (VPC) endpoint for access through AWS PrivateLink. This VPC endpoint service can then be shared with other VPCs by using their VPC endpoints.

You can use Fargate with Amazon ECS to run containers without having to manage servers or clusters of Amazon Elastic Compute Cloud (Amazon EC2) instances. You can also use an Amazon EC2 Auto Scaling group instead of Fargate. For more information, see [Access container applications privately on Amazon ECS by using AWS PrivateLink and a Network Load Balancer](#).

## Prerequisites and limitations

### Prerequisites

- An active AWS account
- [AWS Command Line Interface \(AWS CLI\) version 2](#), installed and configured on Linux, macOS, or Windows
- [Docker](#), installed and configured on Linux, macOS, or Windows
- An application running on Docker

### Architecture



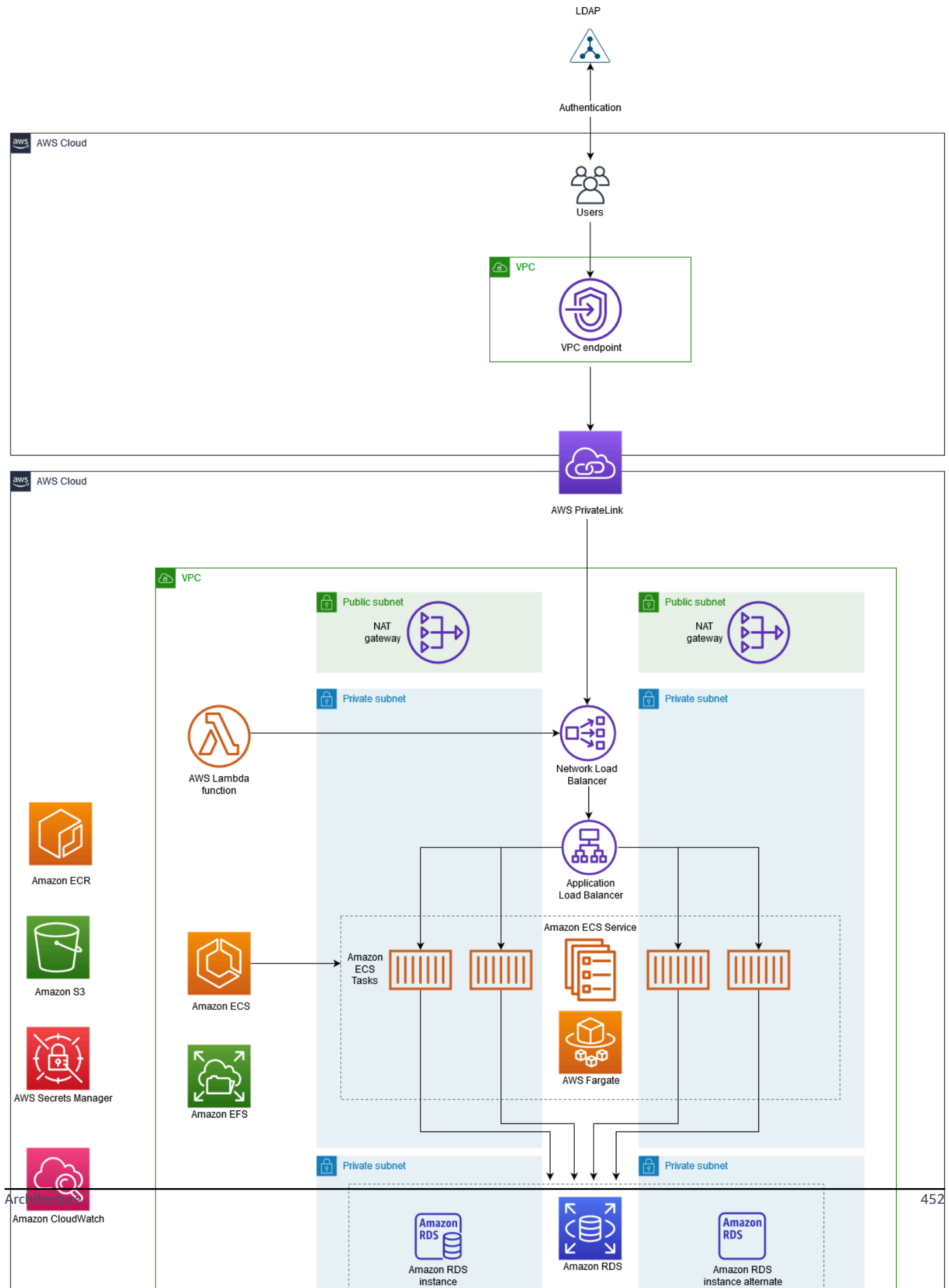

## Technology stack

- Amazon CloudWatch
- Amazon Elastic Container Registry (Amazon ECR)
- Amazon ECS
- Amazon EFS
- Amazon RDS
- Amazon Simple Storage Service (Amazon S3)
- AWS Fargate
- AWS Lambda
- AWS PrivateLink
- AWS Secrets Manager
- Application Load Balancer
- Network Load Balancer
- VPC

## Automation and scale

- You can use [AWS CloudFormation](#) to create this pattern by using [Infrastructure as Code](#).

## Tools

- [Amazon ECS](#) – Amazon Elastic Container Service (Amazon ECS) is a highly scalable, fast, container management service that makes it easy to run, stop, and manage containers on a cluster.
- [Amazon ECR](#) – Amazon Elastic Container Registry (Amazon ECR) is a managed AWS container image registry service that is secure, scalable, and reliable.
- [Amazon EFS](#) – Amazon Elastic File System (Amazon EFS) provides a simple, scalable, fully managed elastic NFS file system for use with AWS Cloud services and on-premises resources.
- [AWS Fargate](#) – AWS Fargate is a technology that you can use with Amazon ECS to run containers without having to manage servers or clusters of Amazon EC2 instances.
- [AWS Lambda](#) – Lambda is a compute service that lets you run code without provisioning or managing servers.

- [Amazon RDS](#) – Amazon Relational Database Service (Amazon RDS) is a web service that makes it easier to set up, operate, and scale a relational database in the AWS Cloud.
- [Amazon S3](#) – Amazon Simple Storage Service (Amazon S3) is storage for the internet. It is designed to make web-scale computing easier for developers.
- [AWS Secrets Manager](#) – Secrets Manager helps you replace hardcoded credentials in your code, including passwords, with an API call to Secrets Manager to retrieve the secret programmatically.
- [Amazon VPC](#) – Amazon Virtual Private Cloud (Amazon VPC) helps you launch AWS resources into a virtual network that you've defined.
- [Elastic Load Balancing](#) – Elastic Load Balancing (ELB) distributes incoming application or network traffic across multiple targets, such as EC2 instances, containers, and IP addresses, in multiple Availability Zones.
- [Docker](#)– Docker helps developers to easily pack, ship, and run any application as a lightweight, portable, and self-sufficient container.

## Epics

### Create networking components

Task	Description	Skills required
Create a VPC.	<ol style="list-style-type: none"> <li>1. Sign in to the AWS Management Console, and open the Amazon VPC console. Choose <b>Create VPC</b>, and choose <b>VPC and more</b>.</li> <li>2. Enter a name for your VPC, and choose an appropriate CIDR block range.</li> <li>3. Specify two Availability Zones, two public subnets, four private subnets. Two private subnets are for Amazon ECS tasks, and</li> </ol>	Cloud administrator

Task	Description	Skills required
	<p>two private subnets are for Amazon RDS databases.</p> <p>4. Specify one NAT gateway for each Availability Zone.</p> <p>5. Choose Create <b>VPC</b>.</p>	

## Create the load balancers

Task	Description	Skills required
<p>Create a Network Load Balancer.</p>	<ol style="list-style-type: none"> <li>1. Open the Amazon EC2 console, and choose the AWS Region that contains your VPC.</li> <li>2. Under <b>Load balancing</b>, choose <b>Load balancers</b>, and choose <b>Create load balancer</b>.</li> <li>3. Choose <b>Network Load Balancer</b>, and choose <b>Create</b>.</li> <li>4. On the <b>Configure load balancer</b> page, configure your Network Load Balancer and listener. <b>Important:</b> Make sure you choose your Network Load Balancer's scheme as <b>Internal</b>.</li> <li>5. Choose the applicable security settings, configure a security group and a target group. Choose <b>IP</b></li> </ol>	<p>Cloud administrator</p>

Task	Description	Skills required
	<p>as the <b>Target type</b> in the <b>Configure routing</b> section. Make sure you do not register a target.</p> <p>6. When you have configured all the settings, choose <b>Next: Review</b>, and then choose <b>Create</b>.</p> <p>For help with this and other stories, see the <i>Related resources</i> section.</p>	

Task	Description	Skills required
Create an Application Load Balancer.	<ol style="list-style-type: none"><li>1. On the Amazon EC2 console, choose the same Region that contains your VPC.</li><li>2. Under <b>Load balancing</b>, choose <b>Load balancers</b>, and choose <b>Create load balancer</b>.</li><li>3. Choose <b>Application Load Balancer</b>, and choose <b>Create</b>.</li><li>4. Configure your Application Load Balancer and its listener. <b>Important:</b> Make sure you choose your Application Load Balancer's scheme as <b>Internal</b>.</li><li>5. Choose the applicable security settings, configure a security group and a target group. Choose <b>IP</b> as the <b>Target type</b> in the <b>Configure routing</b> section. Make sure you do not register a target.</li><li>6. When you have configured all the settings, choose <b>Next: Review</b>, and then choose <b>Create</b>.</li></ol>	Cloud administrator

## Create an Amazon EFS file system

Task	Description	Skills required
Create an Amazon EFS file system.	<ol style="list-style-type: none"><li>1. Open the Amazon EFS console, and choose <b>Create file system</b>.</li><li>2. In the <b>Create file system</b> dialog box, enter a name for your file system, and choose your VPC.</li><li>3. Choose <b>Create</b> to create the file system.</li><li>4. Set up and configure your Amazon EFS file system.</li></ol>	Cloud administrator
Mount targets for the subnets.	<ol style="list-style-type: none"><li>1. Return to the Amazon EFS console, and choose <b>File systems</b>. The <b>File systems</b> page shows the Amazon EFS file systems in your account.</li><li>2. Choose the file system that you created, and choose <b>Manage</b> to display the <b>Availability Zone</b>.</li><li>3. To add a mount target, choose <b>Add mount target</b>, and add the four private subnets that you created.</li></ol>	Cloud administrator
Verify that the subnets are mounted as targets.	<ol style="list-style-type: none"><li>1. On the Amazon EFS console, choose <b>File systems</b>.</li><li>2. Choose <b>Network</b> to display the list of existing mount</li></ol>	Cloud administrator

Task	Description	Skills required
	targets. Make sure that these include the four subnets that you created.	

### Create an S3 bucket

Task	Description	Skills required
Create an S3 bucket.	Open the Amazon S3 console and create an S3 bucket to store your application's static assets, if required.	Cloud administrator

### Create a Secrets Manager secret

Task	Description	Skills required
Create an AWS KMS key to encrypt the Secrets Manager secret.	Open the AWS Key Management Service (AWS KMS) console and create a KMS key.	Cloud administrator
Create a Secrets Manager secret to store the Amazon RDS password.	<ol style="list-style-type: none"> <li>1. Open the AWS Secrets Manager console, and create a new secret by choosing <b>Store a new secret</b>.</li> <li>2. Choose the KMS key that you created, and store your new secret.</li> </ol>	Cloud administrator



## Create an Amazon RDS instance

Task	Description	Skills required
Create a DB subnet group.	<ol style="list-style-type: none"><li>1. Open the Amazon RDS console, and choose <b>Subnet groups</b>.</li><li>2. Choose <b>Create DB subnet group</b>, and enter a name and description for your DB subnet group.</li><li>3. Choose the VPC that you created earlier, and choose the Availability Zones and subnets. Then choose <b>Create</b>.</li></ol>	Cloud administrator
Create an Amazon RDS instance.	Create and configure an Amazon RDS instance within the private subnets. Make sure that <b>Multi-AZ</b> is turned on for high availability (HA).	Cloud administrator
Load data to the Amazon RDS instance.	Load the relational data required by your application into your Amazon RDS instance. This process will vary depending on your application's needs, as well as how your database schema is defined and designed.	DBA

## Create the Amazon ECS components

Task	Description	Skills required
Create an ECS cluster.	<ol style="list-style-type: none"> <li>1. Open the Amazon ECS console, and choose <b>Clusters</b>.</li> <li>2. Choose <b>Create clusters</b>, and set up an ECS cluster according to your required specifications.</li> </ol>	Cloud administrator
Create the Docker images.	Create the Docker images by following the instructions in the <i>Related resources</i> section.	Cloud administrator
Create an Amazon ECR repository.	<ol style="list-style-type: none"> <li>1. Open the Amazon ECR console, and choose <b>Repositories</b>.</li> <li>2. Choose <b>Create repository</b>, and enter a unique name for your repository.</li> <li>3. Configure the repository according to your specifications, including AWS KMS encryption if required.</li> </ol>	Cloud administrator, DevOps engineer
Push the Docker images to the Amazon ECR repository.	<ol style="list-style-type: none"> <li>1. Identify the Docker image you want to push, and run the <code>docker images</code> command in AWS CLI.</li> <li>2. Tag your image with the Amazon ECR registry, repository, and optional image tag name combination.</li> </ol>	Cloud administrator

Task	Description	Skills required
	<ol style="list-style-type: none"> <li>3. Push the Docker image by running the <code>docker push</code> command.</li> <li>4. Repeat these steps for all required images.</li> </ol>	
<p>Create an Amazon ECS task definition.</p>	<p>A task definition is required to run Docker containers in Amazon ECS.</p> <ol style="list-style-type: none"> <li>1. Return to the Amazon ECS console, choose <b>Task definitions</b>, and then choose <b>Create new task definition</b>.</li> <li>2. On the <b>Select compatibilities</b> page, select the launch type that your task should use, and choose <b>Next step</b>.</li> </ol> <p>For help with setting up your task definition, see “Creating a task definition” in the <i>Related resources</i> section.</p> <p><b>Important:</b> Make sure you provide the Docker images that you pushed to Amazon ECR.</p>	<p>Cloud administrator</p>

Task	Description	Skills required
Create an ECS service and choose Fargate as the launch type.	<ol style="list-style-type: none"> <li>1. Create an Amazon ECS service by using the ECS cluster you created earlier. Make sure you choose <b>Fargate</b> as the launch type.</li> <li>2. Choose the task definition created in the previous step, and choose the target group of the Application Load Balancer.</li> </ol>	Cloud administrator

## Set up AWS PrivateLink

Task	Description	Skills required
Set up the AWS PrivateLink endpoint.	<ol style="list-style-type: none"> <li>1. Open the Amazon VPC console, and create an AWS PrivateLink endpoint.</li> <li>2. Associate this endpoint with the Network Load Balancer, which makes the application hosted on Amazon ECS available privately to customers.</li> </ol> <p>For more information, see the <i>Related resources</i> section.</p>	Cloud administrator

## Create a VPC endpoint

Task	Description	Skills required
Create a VPC endpoint.	Create a VPC endpoint for the AWS PrivateLink endpoint that you created earlier. The VPC endpoint Fully Qualified Domain Name (FQDN) will point to the AWS PrivateLink endpoint FQDN. This creates an elastic network interface to the VPC endpoint service that the Domain Name Service endpoints can access.	Cloud administrator

## Create the Lambda function

Task	Description	Skills required
Create the Lambda function.	Open the Lambda console and create a Lambda function to update the Application Load Balancer IP addresses as targets for the Network Load Balancer. For more information on this, see the "Using static IP addresses for Application Load Balancers" blog post in the <i>Related resources</i> section.	App developer

## Related resources

### Create the load balancers:

- [Create a Network Load Balancer](#)
- [Create an Application Load Balancer](#)

**Create an Amazon EFS file system:**

- [Create an Amazon EFS file system](#)
- [Create mount targets in Amazon EFS](#)

**Create an S3 bucket:**

- [Create an S3 bucket](#)

**Create a Secrets Manager secret:**

- [Create keys in AWS KMS](#)
- [Create a secret in AWS Secrets Manager](#)

**Create an Amazon RDS instance:**

- [Create an Amazon RDS DB instance](#)

**Create the Amazon ECS components:**

- [Create an Amazon ECS cluster](#)
- [Create a Docker image](#)
- [Create an Amazon ECR repository](#)
- [Authenticate Docker with Amazon ECR repository](#)
- [Push an image to an Amazon ECR repository](#)
- [Create Amazon ECS task definition](#)
- [Create an Amazon ECS service](#)

**Set up AWS PrivateLink:**

- [VPC endpoint services \(AWS PrivateLink\)](#)

**Create a VPC endpoint:**

- [Interface VPC endpoints \(AWS PrivateLink\)](#)

**Create the Lambda function:**

- [Create a Lambda function](#)

**Other resources:**

- [Using static IP addresses for Application Load Balancers](#)
- [Securely accessing services over AWS PrivateLink](#)

# Access container applications privately on Amazon EKS using AWS PrivateLink and a Network Load Balancer

Created by Kirankumar Chandrashekar (AWS)

**Environment:** Production

**Technologies:** Containers & microservices; DevOps; Modernization; Security, identity, compliance

**Workload:** All other workloads

**AWS services:** Amazon EKS; Amazon VPC

## Summary

This pattern describes how to privately host a Docker container application on Amazon Elastic Kubernetes Service (Amazon EKS) behind a Network Load Balancer, and access the application by using AWS PrivateLink. You can then use a private network to securely access services on the Amazon Web Services (AWS) Cloud.

The Amazon EKS cluster running the Docker applications, with a Network Load Balancer at the front end, can be associated with a virtual private cloud (VPC) endpoint for access through AWS PrivateLink. This VPC endpoint service can then be shared with other VPCs by using their VPC endpoints.

The setup described by this pattern is a secure way to share application access among VPCs and AWS accounts. It requires no special connectivity or routing configurations, because the connection between the consumer and provider accounts is on the global AWS backbone and doesn't traverse the public internet.

## Prerequisites and limitations

### Prerequisites

- [Docker](#), installed and configured on Linux, macOS, or Windows.
- An application running on Docker.



- An active AWS account.
- [AWS Command Line Interface \(AWS CLI\) version 2](#), installed and configured on Linux, macOS, or Windows.
- An existing Amazon EKS cluster with tagged private subnets and configured to host applications. For more information, see [Subnet tagging](#) in the Amazon EKS documentation.
- Kubectl, installed and configured to access resources on your Amazon EKS cluster. For more information, see [Installing kubectl](#) in the Amazon EKS documentation.

## Architecture

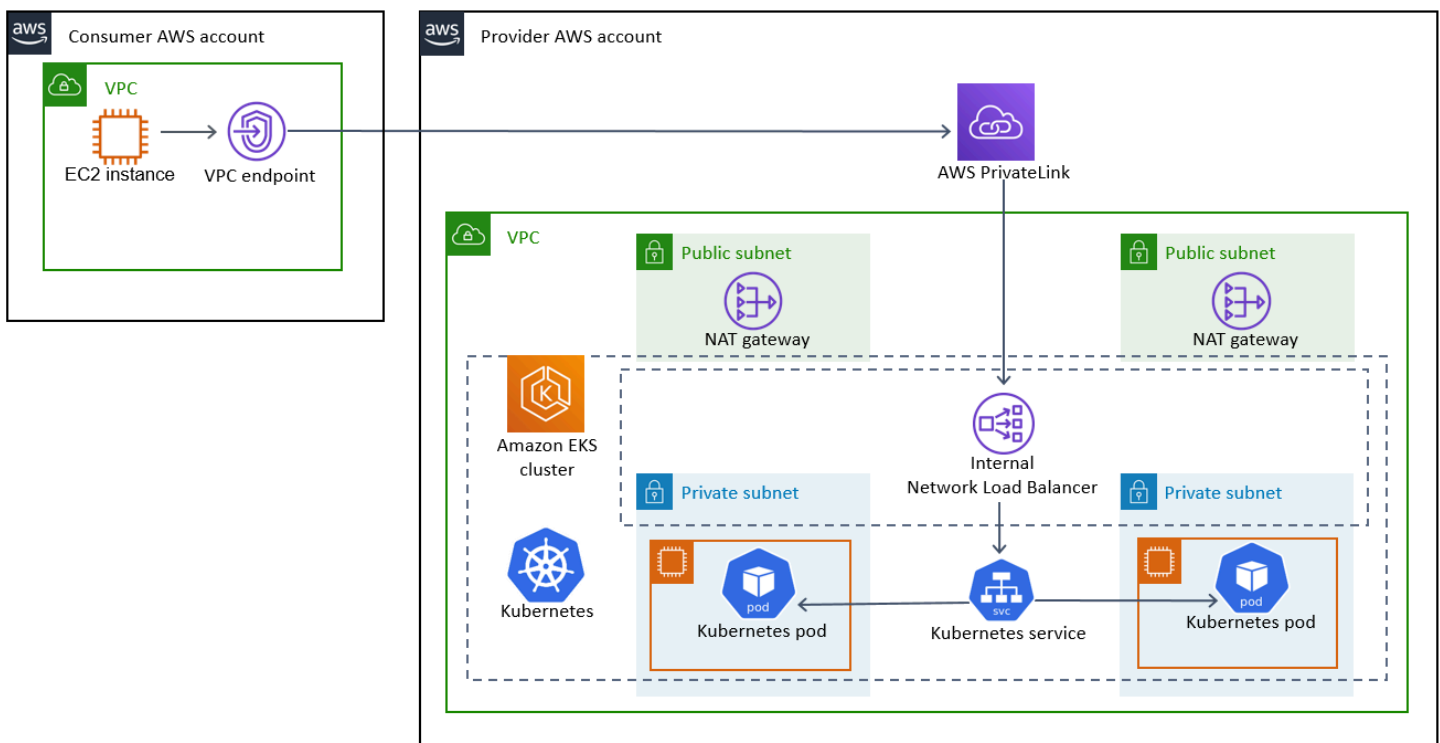

### Technology stack

- Amazon EKS
- AWS PrivateLink
- Network Load Balancer

### Automation and scale

- Kubernetes manifests can be tracked and managed on a Git-based repository (for example, on AWS CodeCommit), and deployed by using continuous integration and continuous delivery (CI/CD) in AWS CodePipeline.
- You can use AWS CloudFormation to create this pattern by using infrastructure as code (IaC).

## Tools

- [AWS CLI](#) – AWS Command Line Interface (AWS CLI) is an open-source tool that enables you to interact with AWS services using commands in your command-line shell.
- [Elastic Load Balancing](#) – Elastic Load Balancing distributes incoming application or network traffic across multiple targets, such as Amazon Elastic Compute Cloud (Amazon EC2) instances, containers, and IP addresses, in one or more Availability Zones.
- [Amazon EKS](#) – Amazon Elastic Kubernetes Service (Amazon EKS) is a managed service that you can use to run Kubernetes on AWS without needing to install, operate, and maintain your own Kubernetes control plane or nodes.
- [Amazon VPC](#) – Amazon Virtual Private Cloud (Amazon VPC) helps you launch AWS resources into a virtual network that you've defined.
- [Kubectl](#) – Kubectl is a command line utility for running commands against Kubernetes clusters.

## Epics

### Deploy the Kubernetes deployment and service manifest files

Task	Description	Skills required
Create the Kubernetes deployment manifest file.	<p>Create a deployment manifest file by modifying the following sample file according to your requirements.</p> <pre>apiVersion: apps/v1 kind: Deployment metadata:   name: sample-app</pre>	DevOps engineer

Task	Description	Skills required
	<pre>spec:   replicas: 3   selector:     matchLabels:       app: nginx   template:     metadata:       labels:         app: nginx     spec:       containers:         - name: nginx           image:             public.ecr.aws/z9d             2n7e1/nginx:1.19.5           ports:             - name: http               container Port: 80</pre> <p><b>Note:</b> This is a NGINX sample configuration file that is deployed by using the NGINX Docker image. For more information, see <a href="#">How to use the official NGINX Docker image</a> in the Docker documentation.</p>	
Deploy the Kubernetes deployment manifest file.	<p>Run the following command to apply the deployment manifest file to your Amazon EKS cluster:</p> <pre>kubectl apply -f &lt;your_deployment_f file_name&gt;</pre>	DevOps engineer

Task	Description	Skills required
Create the Kubernetes service manifest file.	<p>Create a service manifest file by modifying the following sample file according to your requirements.</p> <pre data-bbox="594 443 1027 1276">apiVersion: v1 kind: Service metadata:   name: sample-service   annotations:     service.beta.kubernetes.io/aws-load-balancer-type: nlb     service.beta.kubernetes.io/aws-load-balancer-internal: "true" spec:   ports:     - port: 80       targetPort: 80       protocol: TCP   type: LoadBalancer   selector:     app: nginx</pre> <p><b>Important:</b> Make sure that you included the following annotations to define an internal Network Load Balancer:</p> <pre data-bbox="594 1577 1027 1789">service.beta.kubernetes.io/aws-load-balancer-type: nlb service.beta.kubernetes.io/aws-l</pre>	DevOps engineer

Task	Description	Skills required
	<pre>load-balancer-internal: "true"</pre>	
Deploy the Kubernetes service manifest file.	<p>Run the following command to apply the service manifest file to your Amazon EKS cluster:</p> <pre>kubectl apply -f &lt;your_service_file_name&gt;</pre>	DevOps engineer

## Create the endpoints

Task	Description	Skills required
Record the Network Load Balancer's name.	<p>Run the following command to retrieve the name of the Network Load Balancer:</p> <pre>kubectl get svc sample-service -o wide</pre> <p>Record the Network Load Balancer's name, which is required to create an AWS PrivateLink endpoint.</p>	DevOps engineer
Create an AWS PrivateLink endpoint.	Sign in to the AWS Management Console, open the Amazon VPC console, and then create an AWS PrivateLink endpoint. Associate this endpoint with the Network Load Balancer, this makes	Cloud administrator

Task	Description	Skills required
	<p>the application privately available to customers. For more information, see <a href="#">VPC endpoint services (AWS PrivateLink)</a> in the Amazon VPC documentation.</p> <p><b>Important:</b> If the consumer account requires access to the application, the consumer account's <a href="#">AWS account ID</a> must be added to the allowed principals list for the AWS PrivateLink endpoint configuration. For more information, see <a href="#">Adding and removing permissions for your endpoint service</a> in the Amazon VPC documentation.</p>	

Task	Description	Skills required
Create a VPC endpoint.	<p>On the Amazon VPC console, choose <b>Endpoint Services</b>, and then choose <b>Create Endpoint Service</b>. Create a VPC endpoint for the AWS PrivateLink endpoint.</p> <p>The VPC endpoint's fully qualified domain name (FQDN) points to the FQDN for the AWS PrivateLink endpoint. This creates an elastic network interface to the VPC endpoint service that the DNS endpoints can access.</p>	Cloud administrator

## Related resources

- [Using the official NGINX Docker image](#)
- [Network load balancing on Amazon EKS](#)
- [Creating VPC endpoint services \(AWS PrivateLink\)](#)
- [Adding and removing permissions for your endpoint service](#)

# Activate mTLS in AWS App Mesh using AWS Private CA on Amazon EKS

Created by Omar Kahil (AWS), Emmanuel Saliu (AWS), Muhammad Shahzad (AWS), and Andy Wong (AWS)

**Environment:** PoC or pilot

**Technologies:** Containers & microservices

**AWS services:** AWS App Mesh; Amazon EKS; AWS Certificate Manager (ACM)

## Summary

This pattern shows how to implement Mutual Transport Layer Security (mTLS) on Amazon Web Services (AWS) using certificates from AWS Private Certificate Authority (AWS Private CA) in AWS App Mesh. It uses the Envoy secret discovery service (SDS) API through the Secure Production Identity Framework for Everyone (SPIFFE). SPIFFE is a Cloud Native Computing Foundation (CNCF) open-source project with wide community support that provides fine-grained and dynamic workload identity management. To implement SPIFFE standards, use the SPIRE SPIFFE runtime environment.

Using mTLS in App Mesh offers two-way peer authentication, because it adds a layer of security over TLS and allows services in the mesh to verify the client that's making the connection. The client in the client-server relationship also provides an X.509 certificate during the session negotiation process. The server uses this certificate to identify and authenticate the client. This helps to verify if the certificate is issued by a trusted certificate authority (CA) and if the certificate is a valid one.

## Prerequisites and limitations

### Prerequisites

- An Amazon Elastic Kubernetes Service (Amazon EKS) cluster with self-managed or managed node groups
- App Mesh controller deployed on the cluster with SDS activated
- A private certificate from AWS Certificate Manager (ACM) that is issued by AWS Private CA



## Limitations

- SPIRE cannot be installed on AWS Fargate because the SPIRE Agent must be run as a Kubernetes DaemonSet.

## Product versions

- AWS App Mesh Controller chart 1.3.0 or later

## Architecture

The following diagram shows the EKS cluster with App Mesh in the VPC. The SPIRE server in one worker node communicates with the SPIRE Agents in other worker nodes, and with AWS Private CA. Envoy is used for mTLS communication between the SPIRE Agent worker nodes.

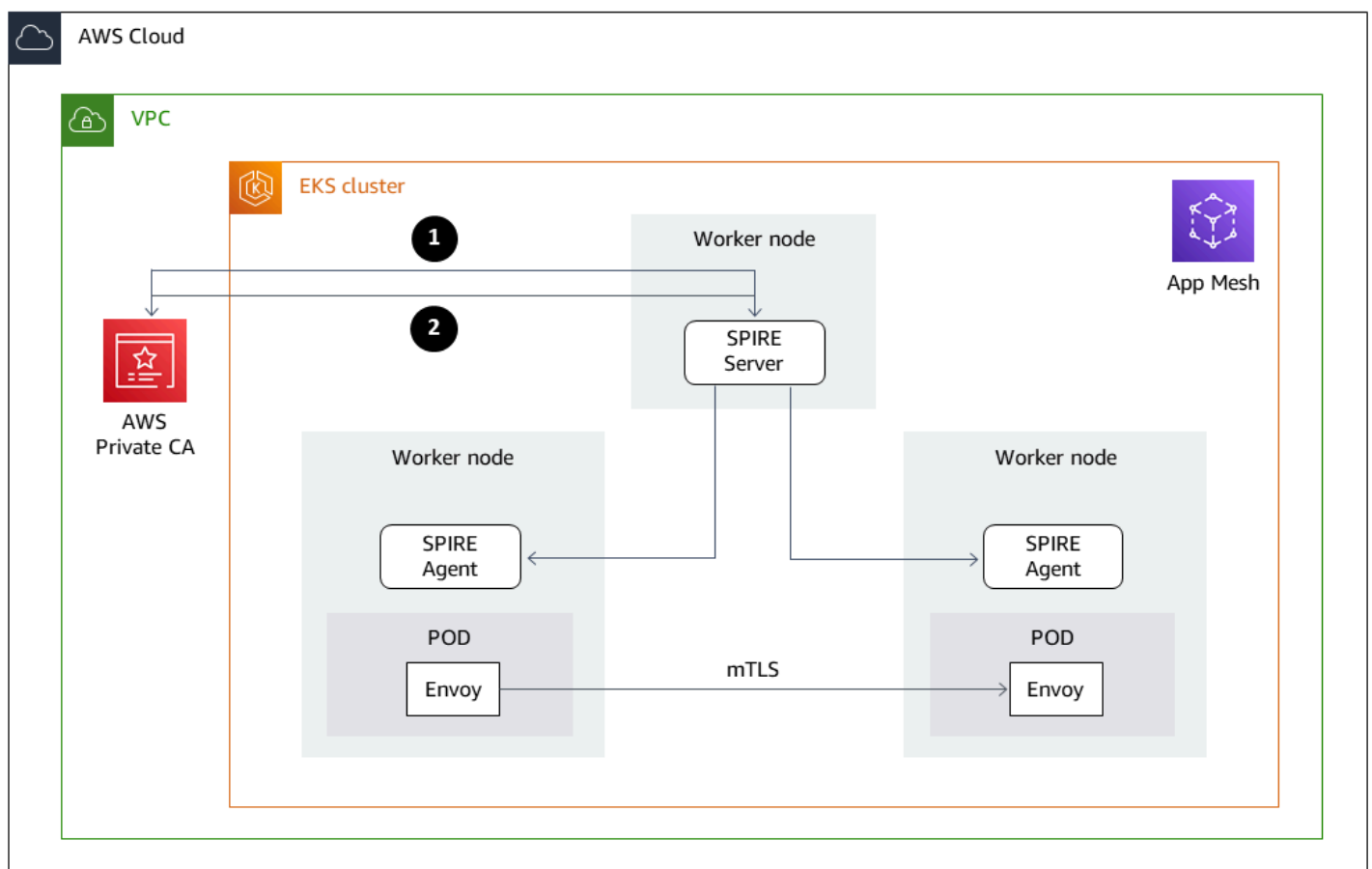

The diagram illustrates the following steps:

1. Certificate is issued.
2. Request cert signing and certificate.

## Tools

### AWS services

- [AWS Private CA](#) – AWS Private Certificate Authority (AWS Private CA) enables creation of private certificate authority (CA) hierarchies, including root and subordinate CAs, without the investment and maintenance costs of operating an on-premises CA.
- [AWS App Mesh](#) – AWS App Mesh is a service mesh that makes it easier to monitor and control services. App Mesh standardizes how your services communicate, giving you consistent visibility and network traffic controls for every service in an application.
- [Amazon EKS](#) – Amazon Elastic Kubernetes Service (Amazon EKS) is a managed service that you can use to run Kubernetes on AWS without needing to install, operate, and maintain your own Kubernetes control plane or nodes.

### Other tools

- [Helm](#) – Helm is a package manager for Kubernetes that helps you install and manage applications on your Kubernetes cluster. This pattern uses Helm to deploy AWS App Mesh Controller.
- [AWS App Mesh Controller chart](#) – AWS App Mesh Controller chart is used by this pattern to enable AWS App Mesh on Amazon EKS.

## Epics

### Set up the environment

Task	Description	Skills required
Set up App Mesh with Amazon EKS.	Follow base deployment steps that are provided in the <a href="#">repository</a> .	DevOps engineer

Task	Description	Skills required
Install SPIRE.	Install SPIRE on the EKS cluster by using <a href="#">spire_set_up.yaml</a> .	DevOps engineer
Install the AWS Private CA certificate.	Create and install a certificate for your private root CA by following the instructions in the <a href="#">AWS documentation</a> .	DevOps engineer
Grant permissions to the cluster node instance role.	To attach policies to the cluster node instance role, use the code that's in the <a href="#">Additional information</a> section.	DevOps engineer
Add the SPIRE plugin for AWS Private CA.	<p>To add the plugin to the SPIRE server configuration, use the code that's in the <a href="#">Additional information</a> section. Replace the <code>certificate_authority_arn</code> Amazon Resource Name (ARN) to your private CA ARN. The signing algorithm used must be the same as the signing algorithm on the private CA. Replace <code>your_region</code> with your AWS Region.</p> <p>For more information about the plugin, see <a href="#">Server plugin: UpstreamAuthority "aws_pca"</a>.</p>	DevOps engineer

Task	Description	Skills required
Update bundle.cert.	After you create the SPIRE server, a <code>spire-bundle.yaml</code> file will be created. Change the <code>bundle.crt</code> value in the <code>spire-bundle.yaml</code> file from the private CA to the public certificate.	DevOps engineer

## Deploy and register the workloads

Task	Description	Skills required
Register node and workload entries with SPIRE.	To register node and workload (services) with SPIRE Server, use the code in the <a href="#">repository</a> .	DevOps engineer
Create a mesh in App Mesh with mTLS activated.	Create a new mesh in App Mesh with all the components for your microservices application (for example, virtual service, virtual router, and virtual nodes).	DevOps engineer
Inspect the registered entries.	You can inspect the registered entries for your nodes and workloads by running the following command. <div data-bbox="597 1654 1026 1845" style="border: 1px solid #ccc; border-radius: 10px; padding: 10px; margin-top: 10px;"> <pre>kubectl exec -n spire   spire-server-0 -- /   opt/spire/bin/spire-   server entry show</pre> </div>	DevOps engineer

Task	Description	Skills required
	This will show the entries for the SPIRE Agents.	

## Verify mTLS traffic

Task	Description	Skills required
Verify mTLS traffic.	<ol style="list-style-type: none"> <li>1. From the frontend service, send an HTTP header to the backend service, and verify a successful response with the services that are registered in SPIRE.</li> <li>2. For mutual TLS authentication, you can inspect the <code>ssl.handshake</code> statistic by running the following command. <div data-bbox="630 1150 1029 1388" data-label="Code-Block" style="border: 1px solid #ccc; border-radius: 10px; padding: 10px; margin: 10px 0;"> <pre>kubectl exec -it \$POD -n \$NAMESPACE -c envoy -- curl http:// localhost:9901/stats   grep ssl.handshake</pre> </div> <p>After running the previous command, you should see the listener <code>ssl.handshake</code> count, which will look similar to the following example:</p> </li> </ol>	DevOps engineer

Task	Description	Skills required
	<pre>listener.0.0.0.0_1 5000.ssl.handshake: 2</pre>	
<p>Verify that certificates are being issued from AWS Private CA.</p>	<p>You can check that the plugins have been configured correctly and certificates are being issued from your upstream private CA by viewing the logs in your SPIRE server. Run the following command.</p> <pre>kubectl logs spire-server-0 -n spire</pre> <p>Then view the logs that are produced. This code assumes that your server is named <code>spire-server-0</code> and is hosted in your <code>spire</code> namespace. You should see successful loading of the plugins and a connection being made to your upstream private CA.</p>	<p>DevOps engineer</p>

## Related resources

- [Using mTLS with SPIFFE/SPIRE in AWS App Mesh on Amazon EKS](#)
- [Enabling mTLS in AWS App Mesh using SPIFFE/SPIRE in a multi-account Amazon EKS environment](#)
- [Walkthrough used in this pattern](#)

- [Server plugin: UpstreamAuthority "aws\\_pca"](#)
- [Quickstart for Kubernetes](#)

## Additional information

### Attach permissions to the cluster node instance role

```
{
  "Version": "2012-10-17",
  "Statement": [
    {
      "Sid": "ACMPCASigning",
      "Effect": "Allow",
      "Action": [
        "acm-pca:DescribeCertificateAuthority",
        "acm-pca:IssueCertificate",
        "acm-pca:GetCertificate",
        "acm:ExportCertificate"
      ],
      "Resource": "*"
    }
  ]
}
AWS Managed Policy: "AWSAppMeshEnvoyAccess"
```

### Add the SPIRE plugin for ACM

Add the SPIRE plugin for ACM

Change `certificate_authority_arn` to your PCA ARN. The signing algorithm used must be the same as the signing algorithm on the PCA. Change `your_region` to the appropriate AWS Region.

```
UpstreamAuthority "aws_pca" {
  plugin_data {
    region = "your_region"
    certificate_authority_arn = "arn:aws:acm-pca:...."
    signing_algorithm = "your_signing_algorithm"
  }
}
```

# Automate backups for Amazon RDS for PostgreSQL DB instances by using AWS Batch

Created by Kirankumar Chandrashekar (AWS)

**Environment:** PoC or pilot

**Technologies:** Containers & microservices; Databases; DevOps

**Workload:** All other workloads

**AWS services:** Amazon RDS; AWS Batch; Amazon CloudWatch; AWS Lambda; Amazon S3

## Summary

Backing up your PostgreSQL databases is an important task and can typically be completed with the [pg\\_dump utility](#), which uses the COPY command by default to create a schema and data dump of a PostgreSQL database. However, this process can become repetitive if you require regular backups for multiple PostgreSQL databases. If your PostgreSQL databases are hosted in the cloud, you can also take advantage of the [automated backup](#) feature provided by Amazon Relational Database Service (Amazon RDS) for PostgreSQL as well. This pattern describes how to automate regular backups for Amazon RDS for PostgreSQL DB instances using the pg\_dump utility.

Note: The instructions assume that you're using Amazon RDS. However, you can also use this approach for PostgreSQL databases that are hosted outside Amazon RDS. To take backups, the AWS Lambda function must be able to access your databases.

A time-based Amazon CloudWatch Events event initiates a Lambda function that searches for specific backup [tags applied to the metadata](#) of the PostgreSQL DB instances on Amazon RDS. If the PostgreSQL DB instances have the **bkp:AutomatedDBDump = Active** tag and other required backup tags, the Lambda function submits individual jobs for each database backup to AWS Batch.

AWS Batch processes these jobs and uploads the backup data to an Amazon Simple Storage Service (Amazon S3) bucket. This pattern uses a Dockerfile and an entrypoint.sh file to build a Docker container image that is used to make backups in the AWS Batch job. After the backup



process is complete, AWS Batch records the backup details to an inventory table on Amazon DynamoDB. As an additional safeguard, a CloudWatch Events event initiates an Amazon Simple Notification Service (Amazon SNS) notification if a job fails in AWS Batch.

## Prerequisites and limitations

### Prerequisites

- An active AWS account.
- An existing managed or unmanaged compute environment. For more information, see [Managed and unmanaged compute environments](#) in the AWS Batch documentation.
- [AWS Command Line Interface \(CLI\) version 2 Docker image](#), installed and configured.
- Existing Amazon RDS for PostgreSQL DB instances.
- An existing S3 bucket.
- [Docker](#), installed and configured on Linux, macOS, or Windows.
- Familiarity with coding in Lambda.

## Architecture

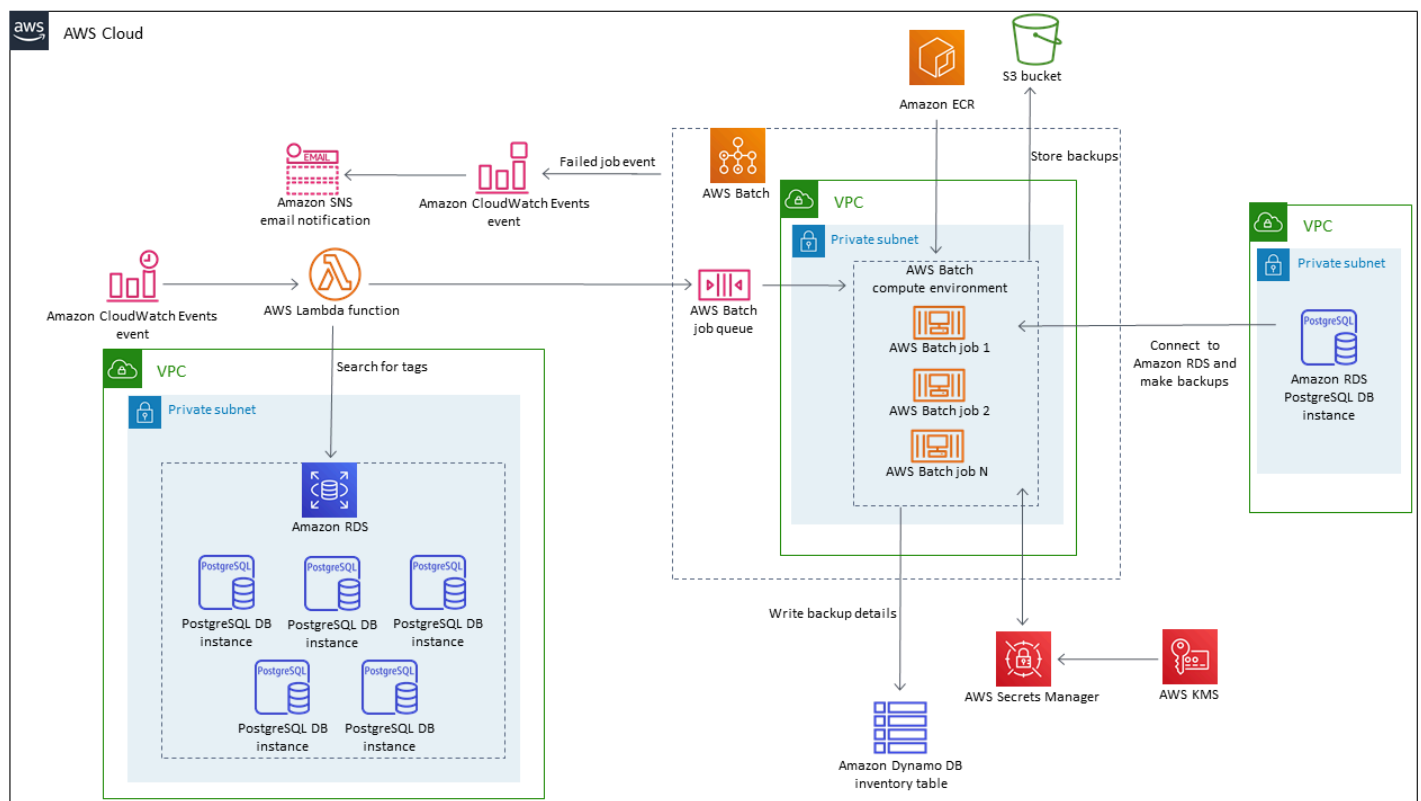

## Technology stack

- Amazon CloudWatch Events
- Amazon DynamoDB
- Amazon Elastic Container Registry (Amazon ECR)
- Amazon RDS
- Amazon SNS
- Amazon S3
- AWS Batch
- AWS Key Management Service (AWS KMS)
- AWS Lambda
- AWS Secrets Manager
- Docker

## Tools

- [Amazon CloudWatch Events](#) – CloudWatch Events delivers a near real-time stream of system events that describe changes in AWS resources.
- [Amazon DynamoDB](#) – DynamoDB is a fully managed NoSQL database service that provides fast and predictable performance with seamless scalability.
- [Amazon ECR](#) – Amazon Elastic Container Registry (Amazon ECR) is a managed AWS container image registry service that is secure, scalable, and reliable.
- [Amazon RDS](#) – Amazon Relational Database Service (Amazon RDS) is a web service that makes it easier to set up, operate, and scale a relational database in the AWS Cloud.
- [Amazon SNS](#) – Amazon Simple Notification Service (Amazon SNS) is a managed service that provides message delivery from publishers to subscribers.
- [Amazon S3](#) – Amazon Simple Storage Service (Amazon S3) is storage for the internet.
- [AWS Batch](#) – AWS Batch helps you run batch computing workloads on the AWS Cloud.
- [AWS KMS](#) – AWS Key Management Service (AWS KMS) is a managed service that makes it easy for you to create and control the encryption keys used to encrypt your data.
- [AWS Lambda](#) – Lambda is a compute service that helps you run code without provisioning or managing servers.

- [AWS Secrets Manager](#) – Secrets Manager helps you replace hardcoded credentials in your code, including passwords, with an API call to Secrets Manager to retrieve the secret programmatically.
- [Docker](#) – Docker helps developers easily pack, ship, and run any application as a lightweight, portable, and self-sufficient container.

Your PostgreSQL DB instances on Amazon RDS must have [tags applied to their metadata](#). The Lambda function searches for tags to identify DB instances that should be backed up, and the following tags are typically used.

Tag	Description
<code>bkp:AutomatedDBDump = Active</code>	Identifies an Amazon RDS DB instance as a candidate for backups.
<code>bkp:AutomatedBackupSecret = &lt;secret_name &gt;</code>	Identifies the Secrets Manager secret that contains the Amazon RDS login credentials.
<code>bkp:AutomatedDBDumpS3Bucket = &lt;s3_bucket_name&gt;</code>	Identifies the S3 bucket to send backups to.
<code>bkp:AutomatedDBDumpFrequency</code> <code>bkp:AutomatedDBDumpTime</code>	Identify the frequency and times when databases should be backed up.
<code>bkp:pgdumpcommand = &lt;pgdump_command&gt;</code>	Identifies the databases for which the backups need to be taken.

## Epics

### Create an inventory table in DynamoDB

Task	Description	Skills required
Create a table in DynamoDB.	Sign in to the AWS Management Console, open the Amazon DynamoDB console, and create a table.	Cloud administrator, Database administrator

Task	Description	Skills required
	For help with this and other stories, see the <i>Related resources</i> section.	
Confirm that the table was created.	Run the <code>aws dynamodb describe-table --table-name &lt;table-name&gt;   grep TableStatus</code> command. If the table exists, the command will return the "TableStatus": "ACTIVE", result.	Cloud administrator, Database administrator

## Create an SNS topic for failed job events in AWS Batch

Task	Description	Skills required
Create an SNS topic.	Open the Amazon SNS console, choose <b>Topics</b> , and create an SNS topic with the name <code>JobFailedAlert</code> . Subscribe an active email address to the topic, and check your email inbox to confirm the SNS subscription email from AWS Notifications.	Cloud administrator
Create a failed job event rule for AWS Batch.	Open the Amazon CloudWatch console, choose <b>Events</b> , and then choose <b>Create rule</b> . Choose <b>Show advanced options</b> , and choose <b>Edit</b> . For <b>Build a pattern that selects events for processing by your targets</b> , replace	Cloud administrator

Task	Description	Skills required
	the existing text with the “Failed job event” code from the <i>Additional information</i> section. This code defines a CloudWatch Events rule that initiates when AWS Batch has a Failed event.	
Add event rule target.	In <b>Targets</b> , choose <b>Add targets</b> , and choose the JobFailedAlert SNS topic. Configure the remaining details and create the Cloudwatch Events rule.	Cloud administrator

### Build a Docker image and push it to an Amazon ECR repository

Task	Description	Skills required
Create an Amazon ECR repository.	Open the Amazon ECR console and choose the AWS Region in which you want to create your repository. Choose <b>Repositories</b> , and then choose <b>Create repository</b> . Configure the repository according to your requirements.	Cloud administrator
Write a Dockerfile.	Sign in to Docker and use the “Sample Dockerfile” and “Sample entrypoint.sh file” from the <i>Additional informati</i>	DevOps engineer

Task	Description	Skills required
	on section to build a Dockerfile.	
Create a Docker image and push it to the Amazon ECR repository.	Build the Dockerfile into a Docker image and push it to the Amazon ECR repository. For help with this story, see the <i>Related resources</i> section.	DevOps engineer

## Create the AWS Batch components

Task	Description	Skills required
Create an AWS Batch job definition.	Open the AWS Batch console and create a job definition that includes the Amazon ECR repository's Uniform Resource Identifier (URI) as the property Image.	Cloud administrator
Configure the AWS Batch job queue.	On the AWS Batch console, choose <b>Job queues</b> , and then choose <b>Create queue</b> . Create a job queue that will store jobs until AWS Batch runs them on the resources within your compute environment. Important: Make sure you write logic for AWS Batch to record the backup details to the DynamoDB inventory table.	Cloud administrator

## Create and schedule a Lambda function

Task	Description	Skills required
Create a Lambda function to search for tags.	Create a Lambda function that searches for tags on your PostgreSQL DB instances and identifies backup candidates. Make sure your Lambda function can identify the <code>bkp:AutomatedDBDump = Active</code> tag and all other required tags. Important: The Lambda function must also be able to add jobs to the AWS Batch job queue.	DevOps engineer
Create a time-based CloudWatch Events event.	Open the Amazon CloudWatch console and create a CloudWatch Events event that uses a cron expression to run your Lambda function on a regular schedule. Important: All scheduled events use the UTC time zone.	Cloud administrator

## Test the backup automation

Task	Description	Skills required
Create an Amazon KMS key.	Open the Amazon KMS console and create a KMS key that can be used to encrypt the Amazon RDS credentials stored in AWS Secrets Manager.	Cloud administrator

Task	Description	Skills required
Create an AWS Secrets Manager secret.	Open the AWS Secrets Manager console and store your Amazon RDS for PostgreSQL database credentials as a secret.	Cloud administrator
Add the required tags to the PostgreSQL DB instances.	Open the Amazon RDS console and add tags to the PostgreSQL DB instances that you want to automatically back up. You can use the tags from the table in the <i>Tools</i> section. If you require backups from multiple PostgreSQL databases within the same Amazon RDS instance, then use <code>-d test:-d test1</code> as the value for the <code>bkp:pgdumpcommand</code> tag. <b>Important:</b> <code>test</code> and <code>test1</code> are database names. Make sure that there is no space after the colon (:).	Cloud administrator



Task	Description	Skills required
Verify the backup automation.	To verify the backup automation, you can either invoke the Lambda function or wait for the backup schedule to begin. After the backup process is complete, check that the DynamoDB inventory table has a valid backup entry for your PostgreSQL DB instances. If they match, then the backup automation process is successful.	Cloud administrator

## Related resources

### Create an inventory table in DynamoDB

- [Create an Amazon DynamoDB table](#)

### Create an SNS topic for failed job events in AWS Batch

- [Create an Amazon SNS topic](#)
- [Send SNS alerts for failed job events in AWS Batch](#)

### Build a Docker image and push it to an Amazon ECR repository

- [Create an Amazon ECR repository](#)
- [Write a Dockerfile, create a Docker image, and push it to Amazon ECR](#)

## Create the AWS Batch components

- [Create an AWS Batch job definition](#)
- [Configure your compute environment and AWS Batch job queue](#)
- [Create a job queue in AWS Batch](#)

## Create a Lambda function

- [Create a Lambda function and write code](#)
- [Use Lambda with DynamoDB](#)

## Create a CloudWatch Events event

- [Create a time-based CloudWatch Events event](#)
- [Use cron expressions in Cloudwatch Events](#)

## Test the backup automation

- [Create an Amazon KMS key](#)
- [Create a Secrets Manager secret](#)
- [Add tags to an Amazon RDS instance](#)

## Additional information

### Failed job event:

```
{
  "detail-type": [
    "Batch Job State Change"
  ],
```

```

"source": [
  "aws.batch"
],
"detail": {
  "status": [
    "FAILED"
  ]
}
}

```

### Sample Dockerfile:

```

FROM alpine:latest
RUN apk --update add py-pip postgresql-client jq bash && \
pip install awscli && \
rm -rf /var/cache/apk/*
ADD entrypoint.sh /usr/bin/
RUN chmod +x /usr/bin/entrypoint.sh
ENTRYPOINT ["entrypoint.sh"]

```

### Sample entrypoint.sh file:

```

#!/bin/bash
set -e
DATETIME=`date +"%Y-%m-%d_%H_%M"`
FILENAME=RDS_PostGres_dump_${RDS_INSTANCE_NAME}
FILE=${FILENAME}_${DATETIME}

aws configure --profile new-profile set role_arn arn:aws:iam:${TargetAccountId}:role/
${TargetAccountRoleName}
aws configure --profile new-profile set credential_source EcsContainer

echo "Central Account access provider IAM role is: "
aws sts get-caller-identity

echo "Target Customer Account access provider IAM role is: "
aws sts get-caller-identity --profile new-profile

securestring=$(aws secretsmanager get-secret-value --secret-id $SECRETID --output json
--query 'SecretString' --region=$REGION --profile new-profile)

if [[ ${securestring} ]]; then
  echo "successfully accessed secrets manager and got the credentials"

```

```

export PGPASSWORD=$(echo $securestring | jq --raw-output | jq -r '.DB_PASSWORD')
PGSQL_USER=$(echo $securestring | jq --raw-output | jq -r '.DB_USERNAME')
echo "Executing pg_dump for the PostGRES endpoint ${PGSQL_HOST}"
# pg_dump -h $PGSQL_HOST -U $PGSQL_USER -n dms_sample | gzip -9 -c | aws s3 cp -
--region=$REGION --profile new-profile s3://$BUCKET/$FILE
# in="-n public:-n private"
IFS=':' list=($EXECUTE_COMMAND);
for command in "${list[@]}";
do
    echo $command;
    pg_dump -h $PGSQL_HOST -U $PGSQL_USER ${command} | gzip -9 -c | aws s3 cp - --
region=$REGION --profile new-profile s3://$BUCKET/$FILE-${command}.sql.gz"
    echo $?;
    if [[ $? -ne 0 ]]; then
        echo "Error occurred in database backup process. Exiting now....."
        exit 1
    else
        echo "Postgresql dump was successfully taken for the RDS endpoint
${PGSQL_HOST} and is uploaded to the following S3 location s3://$BUCKET/$FILE-
${command}.sql.gz"
        #write the details into the inventory table in central account
        echo "Writing to DynamoDB inventory table"
        aws dynamodb put-item --table-name ${RDS_POSTGRES_DUMP_INVENTORY_TABLE} --
region=$REGION --item '{ "accountId": { "S": ""${TargetAccountId}"" }, "dumpFileUrl":
{"S": ""s3://$BUCKET/$FILE-${command}.sql.gz"" }, "DumpAvailableTime": {"S":
""`date +%Y-%m-%d::%H::%M::%S` UTC""}}'
        echo $?
        if [[ $? -ne 0 ]]; then
            echo "Error occurred while putting item to DynamoDb Inventory Table.
Exiting now....."
            exit 1
        else
            echo "Successfully written to DynamoDb Inventory Table
${RDS_POSTGRES_DUMP_INVENTORY_TABLE}"
        fi
    fi
done;
else
    echo "Something went wrong ${?}"
    exit 1
fi
exec "$@"

```

# Automate deployment of Node Termination Handler in Amazon EKS by using a CI/CD pipeline

Created by Sandip Gangapadhyay (AWS), John Vargas (AWS), Pragtideep Singh (AWS), Sandeep Gawande (AWS), and Viyoma Sachdeva (AWS)

**Code repository:** [Deploy NTH to EKS](#)

**Environment:** Production

**Technologies:** Containers & microservices; DevOps

**AWS services:** AWS CodePipeline; Amazon EKS; AWS CodeBuild

## Summary

On the Amazon Web Services (AWS) Cloud, you can use [AWS Node Termination Handler](#), an open-source project, to handle Amazon Elastic Compute Cloud (Amazon EC2) instance shutdown within Kubernetes gracefully. AWS Node Termination Handler helps to ensure that the Kubernetes control plane responds appropriately to events that can cause your EC2 instance to become unavailable. Such events include the following:

- [EC2 instance scheduled maintenance](#)
- [Amazon EC2 Spot Instance interruptions](#)
- [Auto Scaling group scale in](#)
- [Auto Scaling group rebalancing](#) across Availability Zones
- EC2 instance termination through the API or the AWS Management Console

If an event isn't handled, your application code might not stop gracefully. It also might take longer to recover full availability, or it might accidentally schedule work to nodes that are going down. The `aws-node-termination-handler` (NTH) can operate in two different modes: Instance Metadata Service (IMDS) or Queue Processor. For more information about the two modes, see the [Readme file](#).

This pattern automates the deployment of NTH by using Queue Processor through a continuous integration and continuous delivery (CI/CD) pipeline.

**Note:** If you're using [EKS managed node groups](#), you don't need the `aws-node-termination-handler`.

## Prerequisites and limitations

### Prerequisites

- An active AWS account.
- A web browser that is supported for use with the AWS Management Console. See the [list of supported browsers](#).
- AWS Cloud Development Kit (AWS CDK) [installed](#).
- `kubectl`, the Kubernetes command line tool, [installed](#).
- `eksctl`, the AWS Command Line Interface (AWS CLI) for Amazon Elastic Kubernetes Service (Amazon EKS), [installed](#).
- A running EKS cluster with version 1.20 or later.
- A self-managed node group attached to the EKS cluster. To create an Amazon EKS cluster with a self-managed node group, run the following command.

```
eksctl create cluster --managed=false --region <region> --name <cluster_name>
```

For more information on `eksctl`, see the [eksctl documentation](#).

- AWS Identity and Access Management (IAM) OpenID Connect (OIDC) provider for your cluster. For more information, see [Creating an IAM OIDC provider for your cluster](#).

### Limitations

- You must use an AWS Region that supports the Amazon EKS service.

### Product versions

- Kubernetes version 1.20 or later
- `eksctl` version 0.107.0 or later
- AWS CDK version 2.27.0 or later

# Architecture

## Target technology stack

- A virtual private cloud (VPC)
- An EKS cluster
- Amazon Simple Queue Service (Amazon SQS)
- IAM
- Kubernetes

## Target architecture

The following diagram shows the high-level view of the end-to-end steps when the node termination is started.

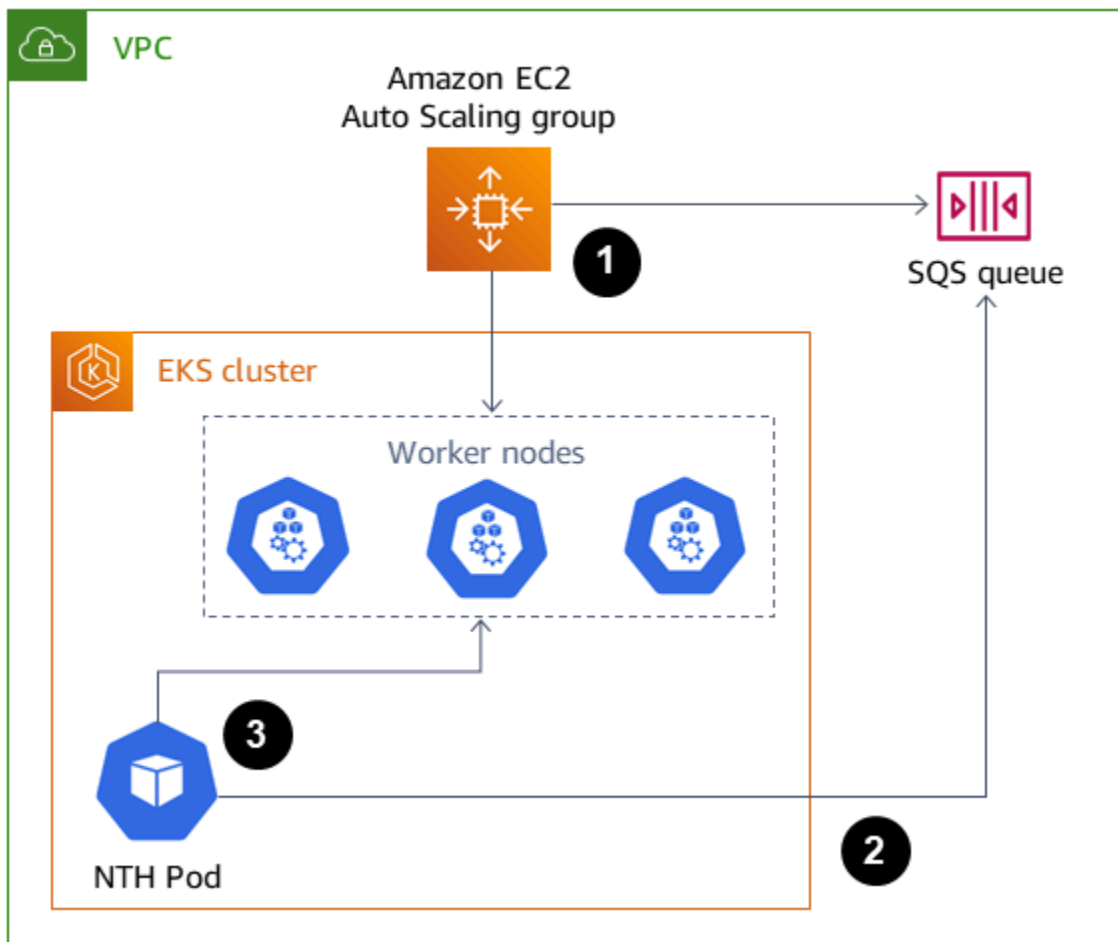

The workflow shown in the diagram consists of the following high-level steps:

1. The automatic scaling EC2 instance terminate event is sent to the SQS queue.
2. The NTH Pod monitors for new messages in the SQS queue.
3. The NTH Pod receives the new message and does the following:
  - Cordons the node so that new pod does not run on the node.
  - Drains the node, so that the existing pod is evacuated
  - Sends a lifecycle hook signal to the Auto Scaling group so that the node can be terminated.

### Automation and scale

- Code is managed and deployed by AWS CDK, backed by AWS CloudFormation nested stacks.
- The [Amazon EKS control plane](#) runs across multiple Availability Zones to ensure high availability.
- For [automatic scaling](#), Amazon EKS supports the Kubernetes [Cluster Autoscaler](#) and [Karpenter](#).

## Tools

### AWS services

- [AWS Cloud Development Kit \(AWS CDK\)](#) is a software development framework that helps you define and provision AWS Cloud infrastructure in code.
- [AWS CodeBuild](#) is a fully managed build service that helps you compile source code, run unit tests, and produce artifacts that are ready to deploy.
- [AWS CodeCommit](#) is a version control service that helps you privately store and manage Git repositories, without needing to manage your own source control system.
- [AWS CodePipeline](#) helps you quickly model and configure the different stages of a software release and automate the steps required to release software changes continuously.
- [Amazon Elastic Kubernetes Service \(Amazon EKS\)](#) helps you run Kubernetes on AWS without needing to install or maintain your own Kubernetes control plane or nodes.
- [Amazon EC2 Auto Scaling](#) helps you maintain application availability and allows you to automatically add or remove Amazon EC2 instances according to conditions you define.
- [Amazon Simple Queue Service \(Amazon SQS\)](#) provides a secure, durable, and available hosted queue that helps you integrate and decouple distributed software systems and components.



## Other tools

- [kubectl](#) is a Kubernetes command line tool for running commands against Kubernetes clusters. You can use kubectl to deploy applications, inspect and manage cluster resources, and view logs.

## Code

The code for this pattern is available in the [deploy-nth-to-eks](#) repo on GitHub.com. The code repo contains the following files and folders.

- `nth` folder – The Helm chart, values files, and the scripts to scan and deploy the AWS CloudFormation template for Node Termination Handler.
- `config/config.json` – The configuration parameter file for the application. This file contains all the parameters needed for CDK to be deployed.
- `cdk` – AWS CDK source code.
- `setup.sh` – The script used to deploy the AWS CDK application to create the required CI/CD pipeline and other required resources.
- `uninstall.sh` – The script used to clean up the resources.

To use the example code, follow the instructions in the *Epics* section.

## Best practices

For best practices when automating AWS Node Termination Handler, see the following:

- [EKS Best Practices Guides](#)
- [Node Termination Handler - Configuration](#)

## Epics

### Set up your environment

Task	Description	Skills required
Clone the repo.	To clone the repo by using SSH (Secure Shell), run the following the command.	App developer, AWS DevOps, DevOps engineer

Task	Description	Skills required
	<pre>git clone git@github.com:aws-samples/ deploy-nth-to-eks.git</pre> <p>To clone the repo by using HTTPS, run the following the command.</p> <pre>git clone https://github.com/aws-samples/ deploy-nth-to-eks.git</pre> <p>Cloning the repo creates a folder named <code>deploy-nth-to-eks</code>.</p> <p>Change to that directory.</p> <pre>cd deploy-nth-to-eks</pre>	
Set the kubeconfig file.	<p>Set your AWS credentials in your terminal and confirm that you have rights to assume the cluster role. You can use the following example code.</p> <pre>aws eks update-kubeconfig --name &lt;Cluster_Name&gt; -- region &lt;region&gt;--role-arn &lt;Role_ARN&gt;</pre>	AWS DevOps, DevOps engineer, App developer

## Deploy the CI/CD pipeline

Task	Description	Skills required
Set up the parameters.	<p>In the <code>config/confirm.json</code> file, set up the following required parameters.</p> <ul style="list-style-type: none"><li>• <code>pipelineName</code> : The name of the CI/CD pipeline to be created by AWS CDK (for example, <code>deploy-nth-to-eks-pipeline</code> ). AWS CodePipeline will create a pipeline that has this name.</li><li>• <code>repositoryName</code> : The AWS CodeCommit repo to be created (for example, <code>deploy-nth-to-eks-repo</code> ). AWS CDK will create this repo and set it as the source for the CI/CD pipeline.</li></ul> <p><b>Note:</b> This solution will create this CodeCommit repo and the branch (provided in the following branch parameter).</p> <ul style="list-style-type: none"><li>• <code>branch</code>: The branch name in the repo (for example, <code>main</code>). A commit to this branch will initiate the CI/CD pipeline.</li></ul>	App developer, AWS DevOps, DevOps engineer

Task	Description	Skills required
	<ul style="list-style-type: none"> <li>• <code>cfn_scan_script</code> :The path of the script that will be used to scan the AWS CloudFormation template for NTH (<code>scan.sh</code>). This script exists in <code>nth</code> folder that will be part of the AWS CodeCommit repo.</li> <li>• <code>cfn_deploy_script</code> :The path of the script that will be used to deploy the AWS CloudFormation template for NTH (<code>installApp.sh</code>).</li> <li>• <code>stackName</code> : The name of the CloudFormation stack to be deployed.</li> <li>• <code>eksClusterName</code> : The name of the existing EKS cluster.</li> <li>• <code>eksClusterRole</code> : The IAM role that will be used to access the EKS cluster for all Kubernetes API calls (for example, <code>clusteradmin</code> ). Usually, this role is added in <code>aws-auth ConfigMap</code> .</li> <li>• <code>create_cluster_role</code> : To create the <code>eksClusterRole</code> IAM role, enter <b>yes</b>. If you want to provide an existing cluster role in</li> </ul>	

Task	Description	Skills required
	<p>the <code>eksClusterRole</code> parameter, enter <b>no</b>.</p> <ul style="list-style-type: none"> <li>• <code>create_iam_oidc_provider</code> : To create the IAM OIDC provider for your cluster, enter <b>yes</b>. If an IAM OIDC provider already exists, enter <b>no</b>. For more information, see <a href="#">Creating an IAM OIDC provider for your cluster</a>.</li> <li>• <code>AsgGroupName</code> : A comma-separated list of Auto Scaling group names that are part of the EKS cluster (for example, <code>ASG_Group_1, ASG_Group_2</code> ).</li> <li>• <code>region</code>: The name of the AWS Region where the cluster is located (for example, <code>us-east-2</code> ).</li> <li>• <code>install_cdk</code> : If AWS CDK isn't currently installed on the machine, enter <b>yes</b>. Run the <code>cdk --version</code> command to check whether the installed AWS CDK version is 2.27.0 or later. In that case, enter <b>no</b>.</li> </ul> <p>If you enter <b>yes</b>, the <code>setup.sh</code> script will run the <code>sudo npm install -g</code></p>	

Task	Description	Skills required
	<p><code>cdk@2.27.0</code> command to install AWS CDK on the machine. The script requires sudo permissions, so provide the account password when prompted.</p>	
Create the CI/CD pipeline to deploy NTH.	<p>Run the <code>setup.sh</code> script.</p> <pre>./setup.sh</pre> <p>The script will deploy the AWS CDK application that will create the CodeCommit repo with example code, the pipeline, and CodeBuild projects based on the user input parameters in <code>config/config.json</code> file.</p> <p>This script will ask for the password as it installs npm packages with the <code>sudo</code> command.</p>	App developer, AWS DevOps, DevOps engineer

Task	Description	Skills required
Review the CI/CD pipeline.	<p>Open the AWS Management Console, and review the following resources created in the stack.</p> <ul style="list-style-type: none"><li>• CodeCommit repo with the contents of the nth folder</li><li>• AWS CodeBuild project <code>cfn-scan</code>, which will scan the CloudFormation template for vulnerabilities.</li><li>• CodeBuild project <code>Nth-Deploy</code>, which will deploy the AWS CloudFormation template and the corresponding NTH Helm charts through the AWS CodePipeline pipeline.</li><li>• A CodePipeline pipeline to deploy NTH.</li></ul> <p>After the pipeline runs successfully, Helm release <code>aws-node-termination-handler</code> is installed in the EKS cluster. Also, a Pod named <code>aws-node-termination-handler</code> is running in the <code>kube-system</code> namespace in the cluster.</p>	App developer, AWS DevOps, DevOps engineer

## Test NTH deployment

Task	Description	Skills required
Simulate an Auto Scaling group scale-in event.	<p>To simulate an automatic scaling scale-in event, do the following:</p> <ol style="list-style-type: none"> <li>1. On the AWS console, open the <b>EC2 console</b>, and choose <b>Auto Scaling Groups</b>.</li> <li>2. Select the Auto Scaling group that has same name as the one provided in <code>config/config.json</code> , and choose <b>Edit</b>.</li> <li>3. Decrease <b>Desired and Minimum Capacity</b> by 1.</li> <li>4. Choose <b>Update</b>.</li> </ol>	
Review the logs.	<p>During the scale-in event, the NTH Pod will cordon and drain the corresponding worker node (the EC2 instance that will be terminated as part of the scale-in event). To check the logs, use the code in the <i>Additional information</i> section.</p>	App developer, AWS DevOps, DevOps engineer



## Clean up

Task	Description	Skills required
Clean up all AWS resources.	<p>To clean up the resources created by this pattern, run the following command.</p> <pre>./uninstall.sh</pre> <p>This will clean up all the resources created in this pattern by deleting the CloudFormation stack.</p>	DevOps engineer

## Troubleshooting

Issue	Solution
The npm registry isn't set correctly.	<p>During the installation of this solution, the script installs npm install to download all the required packages. If, during the installation, you see a message that says "Cannot find module," the npm registry might not be set correctly. To see the current registry setting, run the following command.</p> <pre>npm config get registry</pre> <p>To set the registry with <code>https://registry.npmjs.org/</code>, run the following command.</p> <pre>npm config set registry https://registry.npmjs.org</pre>

Issue	Solution
Delay SQS message delivery.	As part of your troubleshooting, if you want to delay the SQS message delivery to NTH Pod, you can adjust the SQS delivery delay parameter. For more information, see <a href="#">Amazon SQS delay queues</a> .

## Related resources

- [AWS Node Termination Handler source code](#)
- [EC2 workshop](#)
- [AWS CodePipeline](#)
- [Amazon Elastic Kubernetes Service \(Amazon EKS\)](#)
- [AWS Cloud Development Kit](#)
- [AWS CloudFormation](#)

## Additional information

1. Find the NTH Pod name.

```
kubectl get pods -n kube-system |grep aws-node-termination-handler
aws-node-termination-handler-65445555-kbqc7 1/1 Running 0 26m
kubectl get pods -n kube-system |grep aws-node-termination-handler
aws-node-termination-handler-65445555-kbqc7 1/1 Running 0 26m
```

2. Check the logs. An example log looks like the following. It shows that the node has been cordoned and drained before sending the Auto Scaling group lifecycle hook completion signal.

```
kubectl -n kube-system logs aws-node-termination-handler-65445555-kbqc7
022/07/17 20:20:43 INF Adding new event to the event store
event={"AutoScalingGroupName":"eksctl-my-cluster-target-nodegroup-
ng-10d99c89-NodeGroup-ZME36IGAP701","Description":"ASG Lifecycle Termination
event received. Instance will be interrupted at 2022-07-17 20:20:42.702
+0000 UTC \n","EndTime":"0001-01-01T00:00:00Z","EventID":"asg-lifecycle-
term-33383831316538382d353564362d343332362d613931352d383430666165636334333564","InProgress":fal
```

```
east-2.compute.internal", "NodeProcessed": false, "Pods": null, "ProviderID": "aws:///us-
east-2c/i-0409f2a9d3085b80e", "StartTime": "2022-07-17T20:20:42.702Z", "State": ""}
2022/07/17 20:20:44 INF Requesting instance drain event-id=asg-lifecycle-
term-33383831316538382d353564362d343332362d613931352d383430666165636334333564
instance-id=i-0409f2a9d3085b80e kind=SQS_TERMINATE node-name=ip-192-168-75-60.us-
east-2.compute.internal provider-id=aws:///us-east-2c/i-0409f2a9d3085b80e
2022/07/17 20:20:44 INF Pods on node node_name=ip-192-168-75-60.us-
east-2.compute.internal pod_names=["aws-node-qchsw", "aws-node-termination-
handler-65445555-kbqc7", "kube-proxy-mz5x5"]
2022/07/17 20:20:44 INF Draining the node
2022/07/17 20:20:44 ??? WARNING: ignoring DaemonSet-managed Pods: kube-system/aws-node-
qchsw, kube-system/kube-proxy-mz5x5
2022/07/17 20:20:44 INF Node successfully cordoned and drained
node_name=ip-192-168-75-60.us-east-2.compute.internal reason="ASG Lifecycle
Termination event received. Instance will be interrupted at 2022-07-17 20:20:42.702
+0000 UTC \n"
2022/07/17 20:20:44 INF Completed ASG Lifecycle Hook (NTH-K8S-TERM-HOOK) for instance
i-0409f2a9d3085b80e
```

# Automatically build and deploy a Java application to Amazon EKS using a CI/CD pipeline

Created by MAHESH RAGHUNANDANAN (AWS), James Radtke (AWS), and Jomcy Pappachen (AWS)

<b>Code repository:</b> <a href="#">aws-cicd-java-eks</a>	<b>Environment:</b> Production	<b>Technologies:</b> Containers & microservices; CloudNative; DevOps; Modernization
<b>Workload:</b> All other workloads	<b>AWS services:</b> AWS CloudFormation; AWS CodeCommit; AWS CodePipeline; Amazon EC2 Container Registry; Amazon EKS	

## Summary

This pattern describes how to create a continuous integration and continuous delivery (CI/CD) pipeline that automatically builds and deploys a Java application with recommended DevSecOps practices to an Amazon Elastic Kubernetes Service (Amazon EKS) cluster on the Amazon Web Services (AWS) Cloud. This pattern uses a greeting application developed with a Spring Boot Java framework and that uses Apache Maven.

You can use this pattern's approach to build the code for a Java application, package the application artifacts as a Docker image, security scan the image, and upload the image as a workload container on Amazon EKS. This pattern's approach is useful if you want to migrate from a tightly coupled monolithic architecture to a microservices architecture. The approach also helps you to monitor and manage the entire lifecycle of a Java application, which ensures a higher level of automation and helps avoid errors or bugs.

## Prerequisites and limitations

### Prerequisites

- An active AWS account.

- AWS Command Line Interface (AWS CLI) version 2, installed and configured. For more information about this, see [Installing, updating, and uninstalling the AWS CLI version 2](#) in the AWS CLI documentation.
- AWS CLI version 2 must be configured with the same IAM role that creates the Amazon EKS cluster because only that role is authorized to add other IAM roles to the `aws-auth` ConfigMap. For information and steps to configure AWS CLI, see [Configuration basics](#) in the AWS CLI documentation.
- AWS Identity and Access Management (IAM) roles and permissions with full access to AWS CloudFormation. For more information about this, see [Controlling access with IAM](#) in the AWS CloudFormation documentation.
- An existing Amazon EKS cluster, with details of the IAM role name and IAM role Amazon Resource Name (ARN) of worker nodes in the EKS cluster.
- Kubernetes Cluster Autoscaler, installed and configured in your Amazon EKS cluster. For more information, see [Cluster Autoscaler](#) in the Amazon EKS documentation.
- Access to code in the GitHub repository.

### *Important note*

AWS Security Hub is enabled as part of the AWS CloudFormation templates that are in the code. By default, after Security Hub is enabled, it comes with a 30-day free trial, after which there is a cost associated with this AWS service. For more information about pricing, see [AWS Security Hub pricing](#).

### **Product versions**

- Helm version 3.4.2 or later
- Apache Maven version 3.6.3 or later
- BridgeCrew Checkov version 2.2 or later
- Aqua Security Trivy version 0.37 or later

## **Architecture**

### **Technology stack**

- AWS CodeBuild
- AWS CodeCommit

- Amazon CodeGuru
- AWS CodePipeline
- Amazon Elastic Container Registry
- Amazon Elastic Kubernetes Service
- Amazon EventBridge
- AWS Security Hub
- Amazon Simple Notification Service (Amazon SNS)

## Target architecture

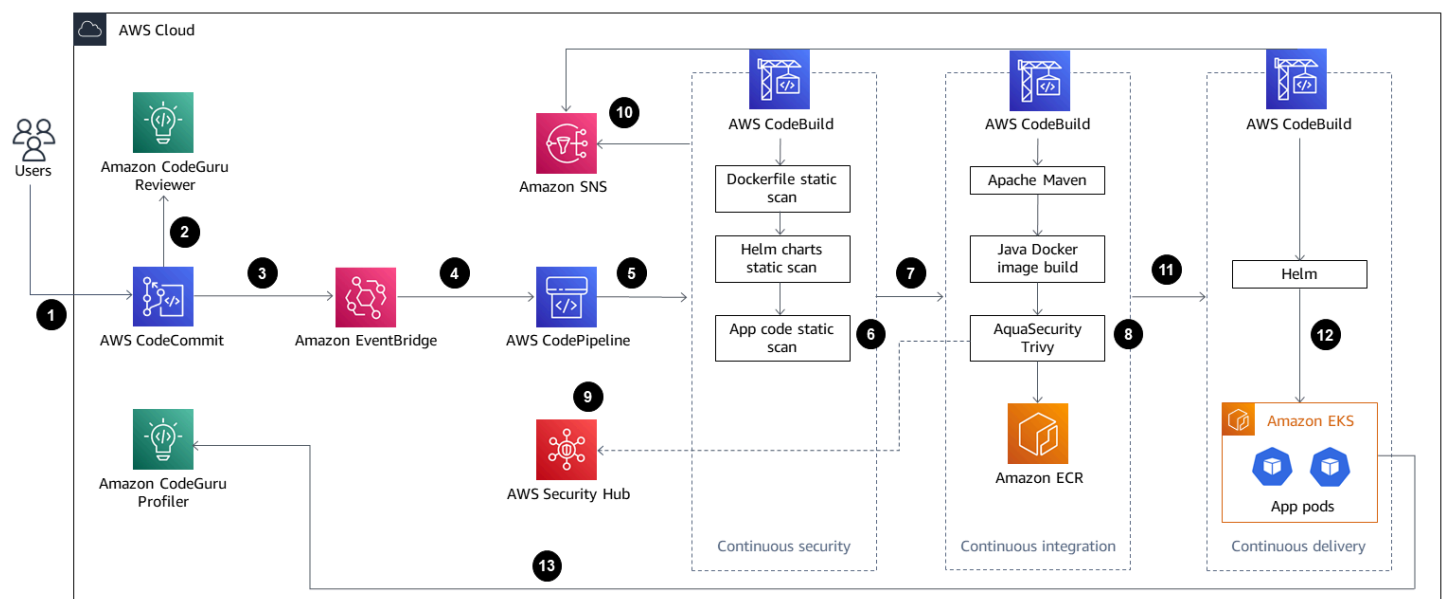

The diagram shows the following workflow:

1. The developer updates the Java application code in the base branch of the CodeCommit repository, which creates a pull request (PR).
2. As soon as the PR is submitted, Amazon CodeGuru Reviewer automatically reviews the code, analyzes it based on best practices for Java, and gives recommendations to the developer.
3. After the PR is merged to the base branch, an Amazon EventBridge event is created.
4. The EventBridge event initiates the CodePipeline pipeline, which starts .
5. CodePipeline runs the CodeSecurity Scan stage (continuous security).
6. CodeBuild starts the security scan process in which the Dockerfile and Kubernetes deployment Helm files are scanned using Checkov, and application source code is scanned based on

incremental code changes. The application source code scan is performed by the [CodeGuru Reviewer Command Line Interface \(CLI\) wrapper](#).

7. If the security scan stage is successful, the Build stage (continuous integration) is initiated.
8. In the Build stage, CodeBuild builds the artifact, packages the artifact to a Docker image, scans the image for security vulnerabilities by using Aqua Security Trivy, and stores the image in Amazon ECR.
9. The vulnerabilities detected from step 8 are uploaded to Security Hub for further analysis by developers or engineers. Security Hub provides an overview and recommendations for remediating the vulnerabilities.
10. Email notifications of various phases within the CodePipeline pipeline are sent through Amazon SNS.
11. After the continuous integration phases are complete, CodePipeline enters the Deploy stage (continuous delivery).
12. The Docker image is deployed to Amazon EKS as a container workload (pod) by using Helm charts.
13. The application pod is configured with Amazon CodeGuru Profiler Agent which will send the profiling data of the application (CPU, heap usage, and latency) to Amazon CodeGuru Profiler, which helps developers to understand the behavior of the application.

## Tools

### AWS services

- [AWS CloudFormation](#) helps you set up AWS resources, provision them quickly and consistently, and manage them throughout their lifecycle across AWS accounts and Regions.
- [AWS CodeBuild](#) is a fully managed build service that helps you compile source code, run unit tests, and produce artifacts that are ready to deploy.
- [AWS CodeCommit](#) is a version control service that helps you privately store and manage Git repositories, without needing to manage your own source control system.
- [Amazon CodeGuru Profiler](#) collects runtime performance data from your live applications, and provides recommendations that can help you fine-tune your application performance.
- [Amazon CodeGuru Reviewer](#) uses program analysis and machine learning to detect potential defects that are difficult for developers to find and offers suggestions for improving your Java and Python code.

- [AWS CodePipeline](#) helps you quickly model and configure the different stages of a software release and automate the steps required to release software changes continuously.
- [Amazon Elastic Container Registry \(Amazon ECR\)](#) is a managed container image registry service that's secure, scalable, and reliable.
- [Amazon Elastic Kubernetes Service \(Amazon EKS\)](#) helps you run Kubernetes on AWS without needing to install or maintain your own Kubernetes control plane or nodes.
- [Amazon EventBridge](#) is a serverless event bus service that helps you connect your applications with real-time data from a variety of sources. For example, AWS Lambda functions, HTTP invocation endpoints using API destinations, or event buses in other AWS accounts.
- [AWS Identity and Access Management \(IAM\)](#) helps you securely manage access to your AWS resources by controlling who is authenticated and authorized to use them.
- [AWS Security Hub](#) provides a comprehensive view of your security state in AWS. It also helps you check your AWS environment against security industry standards and best practices.
- [Amazon Simple Notification Service \(Amazon SNS\)](#) helps you coordinate and manage the exchange of messages between publishers and clients, including web servers and email addresses.
- [Amazon Simple Storage Service \(Amazon S3\)](#) is a cloud-based object storage service that helps you store, protect, and retrieve any amount of data.

## Other services

- [Helm](#) is an open-source package manager for Kubernetes.
- [Apache Maven](#) is a software project management and comprehension tool.
- [BridgeCrew Checkov](#) is a static code analysis tool for scanning infrastructure as code (IaC) files for misconfigurations that might lead to security or compliance problems.
- [Aqua Security Trivy](#) is a comprehensive scanner for vulnerabilities in container images, file systems, and Git repositories, in addition to configuration issues.

## Code

The code for this pattern is available in the GitHub [aws-codepipeline-devsecops-amazoneks](#) repository.



## Best practices

- The principle of least privilege has been followed for IAM entities across all the phases of this solution. If you want to extend the solution with additional AWS services or third-party tools, we recommend following the principle of least privilege.
- If you have multiple Java applications, we recommend creating separate CI/CD pipelines for each application.
- If you have a monolith application, we recommend breaking the application into microservices as much as possible. Microservices are more flexible, they make it easier to deploy applications as containers, and they provide better visibility into the overall build and deployment of the application.

## Epics

### Set up the environment

Task	Description	Skills required
Clone the GitHub repository.	<p>To clone the repository, run the following command.</p> <pre>git clone https://github.com/aws-samples/aws-codepipeline-devsecops-amazoneks</pre>	App developer, DevOps engineer
Create an S3 bucket and upload the code.	<ol style="list-style-type: none"> <li>1. Sign in to the AWS Management Console, open the Amazon S3 console, and then create an S3 bucket in the AWS Region where you plan to deploy this solution. For more information, see <a href="#">Creating a bucket</a> in the Amazon S3 documentation.</li> </ol>	AWS DevOps, DevOps engineer, Cloud administrator, DevOps

Task	Description	Skills required
	<p>2. In the S3 bucket, create a folder named code.</p> <p>3. Navigate to where you cloned the repository. To create a compressed version of the entire code with the .zip extension (cicdstack.zip ) and validate the .zip file, run the following commands in order.</p> <p><b>Note:</b> If the python command fails and states that Python was not found, use python3 instead.</p> <pre>cd aws-codepipeline-d evsecops-amazoneks python -m zipfile -c cicdstack.zip * python -m zipfile -t cicdstack.zip</pre> <p>4. Upload the cicdstack .zip file to the code folder that you previously created in the S3 bucket.</p>	

Task	Description	Skills required
Create an AWS CloudFormation stack.	<ol style="list-style-type: none"><li data-bbox="592 226 1027 359">1. Open the AWS CloudFormation console and choose <b>Create stack</b>.</li><li data-bbox="592 380 1027 653">2. In <b>Specify template</b>, choose <b>Upload a template file</b>, upload the <code>cf_templates/codecommit_ecr.yaml</code> file, and then choose <b>Next</b>.</li><li data-bbox="592 674 1027 1703">3. In <b>Specify stack details</b>, enter the stack name, and then provide the following input parameter values:<ul style="list-style-type: none"><li data-bbox="630 877 1027 1108">• <b>CodeCommitRepositoryBranchName</b>: The branch-name where your code will be residing(the default is <b>main</b>)</li><li data-bbox="630 1129 1027 1297">• <b>CodeCommitRepositoryName</b>: The name of the CodeCommit repo to be created.</li><li data-bbox="630 1318 1027 1549">• <b>CodeCommitRepositoryS3Bucket</b>: The name of the S3 bucket where you created the code folder</li><li data-bbox="630 1570 1027 1703">• <b>CodeCommitRepositoryS3BucketObjKey</b>: <code>code/cicdstack.zip</code></li></ul></li></ol>	AWS DevOps, DevOps

Task	Description	Skills required
	<ul style="list-style-type: none"> <li>• <b>ECRRepositoryName:</b> The name of the Amazon ECR repo to be created</li> </ul> <ol style="list-style-type: none"> <li>4. Choose <b>Next</b>, use the default settings for the <b>Configure stack options</b>, and then choose <b>Next</b>.</li> <li>5. In the <b>Review</b> section, verify the template and stack details, and then choose <b>Create stack</b>. The stack is then created, including the CodeCommit and Amazon ECR repositories.</li> <li>6. Note the names of the CodeCommit and Amazon ECR repositories, which will be required for the Java CI/CD pipeline setup.</li> </ol>	
Validate the CloudFormation stack deployment.	<ol style="list-style-type: none"> <li>1. Under <b>Stacks</b> on the CloudFormation console, verify the status of CloudFormation stack that you deployed. The status of the stack should be <b>CREATE COMPLETE</b>.</li> <li>2. Additionally, from the console, validate that CodeCommit and Amazon ECR have been provisioned and are ready.</li> </ol>	DevOps engineer

Task	Description	Skills required
Delete the S3 bucket.	Empty and delete the S3 bucket that you created earlier. For more information, see <a href="#">Deleting a bucket</a> in the Amazon S3 documentation.	AWS DevOps, DevOps

## Configure the Helm charts

Task	Description	Skills required
Configure the Helm charts of your Java application.	<ol style="list-style-type: none"><li>In the location where you cloned the GitHub repository, navigate to the folder <code>helm_charts/aws-proserve-java-greeting</code>. In this folder, the <code>values.dev.yaml</code> file contains information about Kubernetes resources configuration that you can modify for your container deployments to Amazon EKS. Update the Docker repository parameter by providing your AWS account ID, AWS Region, and Amazon ECR repository name. <pre>image:   repository:     &lt;account-id&gt;.dkr.ecr.&lt;region&gt;.amazon</pre></li></ol>	DevOps

Task	Description	Skills required
	<pre>aws.com/&lt;app-ecr-r epo-name&gt;</pre> <p>2. The Java pod's service type is set to LoadBalancer .</p> <pre>service:   type: LoadBalancer   port: 80   targetPort: 8080   path: /hello   initialDelaySecond s: 60   periodSeconds: 30</pre> <p>To use a different service (for example, NodePort), you can change the parameters. For more information, see the <a href="#">Kubernetes documentation</a>.</p> <p>3. You can activate the <a href="#">Kubernetes Horizontal Pod Autoscaler</a> by changing the autoscaling parameter to <code>enabled: true</code>.</p> <pre>autoscaling:   enabled: true   minReplicas: 1   maxReplicas: 100   targetCPUUtilizati onPercentage: 80   # targetMem oryUtilizationPerc centage: 80</pre>	

Task	Description	Skills required
	<p>You can enable different features for the Kubernetes workloads by changing the values in the <code>values.&lt;ENV&gt;.yaml</code> file, where <code>&lt;ENV&gt;</code> is your development, production, UAT, or QA environment.</p>	
Validate Helm charts for syntax errors.	<ol style="list-style-type: none"><li>1. From the terminal, verify that Helm v3 is installed in your local workstation by running the following command. <pre>helm --version</pre><p>If Helm v3 isn't installed, <a href="#">install it</a>.</p></li><li>2. In the terminal, navigate to the Helm charts directory (<code>helm_charts/aws-pr</code> <code>oserve-java-greeting</code>), and run the following command. <pre>helm lint . -f values.dev.yaml</pre><p>This will check the Helm charts for any syntax errors.</p></li></ol>	DevOps engineer

## Set up the Java CI/CD pipeline

Task	Description	Skills required
Create the CI/CD pipeline.	<ol style="list-style-type: none"><li>1. Open the AWS CloudFormation console, and choose <b>Create stack</b>.</li><li>2. In <b>Specify template</b>, choose <b>Upload a template file</b>, upload the <code>cf_templates/build_deployment.yaml</code> template, and then choose <b>Next</b>.</li><li>3. In <b>Specify stack details</b>, specify the <b>Stack name</b>, and then provide the following values for the input parameters:<ul style="list-style-type: none"><li>• <b>CodeBranchName:</b> Branch name of CodeCommit repo, where your code resides</li><li>• <b>EKSClusterName:</b> Name of your EKS cluster (not the <code>EKSClusterID</code>)</li><li>• <b>EKSCodeBuildAppName:</b> Name of the app Helm chart (<code>aws-proserve-java-greeting</code>)</li><li>• <b>EKSWorkerNodeRoleARN:</b> ARN of the Amazon EKS worker nodes IAM role</li></ul></li></ol>	AWS DevOps



Task	Description	Skills required
	<ul style="list-style-type: none"> <li>• <b>EKSWorkerNodeRoleName:</b> Name of the IAM role assigned to the Amazon EKS worker nodes</li> <li>• <b>EcrDockerRepository:</b> Name of Amazon ECR repo where the Docker images of your code will be stored</li> <li>• <b>EmailRecipient:</b> Email address where build notifications need to be sent</li> <li>• <b>EnvType:</b> Environment (for example, dev, test, or prod)</li> <li>• <b>SourceRepoName:</b> Name of the CodeCommit repo, where your code resides</li> </ul> <p>4. Choose <b>Next</b>. Use the default settings in <b>Configure stack options</b>, and then choose <b>Next</b>.</p> <p>5. In the <b>Review</b> section, verify the AWS CloudFormation template and stack details, and then choose <b>Next</b>.</p> <p>6. Choose <b>Create stack</b>.</p> <p>7. During the CloudFormation stack deployment, the owner of the email address</p>	

Task	Description	Skills required
	<p>that you provided in the parameters will receive a message to subscribe to an SNS topic. To subscribe to Amazon SNS, the owner must choose the link in the message.</p> <p>8. After the stack is created, open the <b>Outputs</b> tab of the stack, and then record the ARN value for the <code>EksCodeBuildkuberoleARN</code> output key. This IAM ARN value will be required later for providing the CodeBuild IAM role with permissions to deploy workloads in the Amazon EKS cluster.</p>	

### Activate integration between Security Hub and Aqua Security

Task	Description	Skills required
Turn on Aqua Security integration.	This step is required for uploading the Docker image vulnerability findings reported by Trivy to Security Hub. Because AWS CloudFormation doesn't support Security Hub integrations, this process must be done manually.	AWS administrator, DevOps engineer

Task	Description	Skills required
	<ol style="list-style-type: none"> <li>1. Open the <b>AWS Security Hub</b> console, and navigate to <b>Integrations</b>.</li> <li>2. Search for Aqua Security, and select <b>Aqua Security: Aqua Security</b>.</li> <li>3. Choose <b>Accept findings</b>.</li> </ol>	

### Configure CodeBuild to run Helm or kubectl commands

Task	Description	Skills required
Allow CodeBuild to run Helm or kubectl commands in the Amazon EKS cluster.	<p>For CodeBuild to be authenticated to use Helm or kubectl commands with the EKS cluster, you must add the IAM roles to the aws-auth ConfigMap. In this case, add the ARN of IAM role EksCodeBuildkubernetesRoleARN, which is the IAM role created for the CodeBuild service to access the EKS cluster and deploy workloads on it. This is a one-time activity.</p> <p><b>Important:</b> The following procedure must be completed before the deployment approval stage in CodePipeline.</p>	DevOps

Task	Description	Skills required
	<ol style="list-style-type: none"><li data-bbox="592 212 987 485">1. Open the <code>cf_templates/kube_aws_auth_configmap_patch.sh</code> shell script in your Amazon Linux or macOS environment.</li><li data-bbox="592 510 964 684">2. Authenticate to the Amazon EKS cluster by running the following command. <pre data-bbox="634 722 1029 921">aws eks --region &lt;aws-region&gt; update-kubeconfig --name &lt;eks-cluster-name&gt;</pre></li><li data-bbox="592 940 1013 1356">3. Run the shell script by using the following command, replacing <code>&lt;rolearn-eks-codebuild-kubect1&gt;</code> with the ARN value of <code>EksCodeBuildkubernetesRoleARN</code> that you recorded earlier. <pre data-bbox="634 1394 1029 1633">bash cf_templates/kube_aws_auth_configmap_patch.sh &lt;rolearn-eks-codebuild-kubect1&gt;</pre></li></ol> <p data-bbox="592 1703 1008 1833">The <code>aws_auth</code> ConfigMap is configured, and access is granted.</p>	

## Validate the CI/CD pipeline

Task	Description	Skills required
<p>Verify that the CI/CD pipeline automatically initiates.</p>	<p>1. The CodeSecurity Scan stage in the pipeline will usually fail if Checkov detects vulnerabilities in the Dockerfile or Helm charts. However, the purpose of this example is to establish a process of identifying potential security vulnerabilities rather than fixing it through the CI/CD pipeline, typically a DevSecOps process. In the file <code>buildspec/buildspec_secscan.yaml</code>, the checkov command uses the <code>--soft-fail</code> flag to avoid pipeline failure.</p> <pre data-bbox="630 1310 1029 1885"> - echo -e "\n Running Dockerfile Scan" - checkov -f code/app/Dockerfile --framework dockerfile --soft- fail --summary- position bottom - echo -e "\n Running Scan of Helm Chart files" - cp -pv helm_charts/\$EKS_C </pre>	<p>DevOps</p>

Task	Description	Skills required
	<pre data-bbox="646 212 977 800"> ODEBUILD_APP_NAME/ values.dev.yaml helm_charts/\$EKS_C ODEBUILD_APP_NAME/ values.yaml - checkov -d helm_charts/\$EKS_C ODEBUILD_APP_NAME --framework helm -- soft-fail --summary- position bottom - rm -rfv helm_charts/\$EKS_C ODEBUILD_APP_NAME/ values.yaml </pre> <p data-bbox="630 863 1029 1419">For the pipeline to fail when vulnerabilities are reported for the Dockerfile and Helm charts, the <code>--soft-fail</code> option must be removed from the checkov command. Developers or engineers can then fix the vulnerabilities and commit the changes to the CodeCommit source code repository.</p> <p data-bbox="592 1444 1003 1854">2. Similar to CodeSecurity Scan, the Build stage uses Aqua Security Trivy for identifying HIGH and CRITICAL Docker image vulnerabilities before pushing the application to Amazon ECR. In this example, we are</p>	

Task	Description	Skills required
	<p>not making pipeline fail for Docker image vulnerabilities. In the file <code>buildspec/buildspec.yml</code>, the <code>trivy</code> command includes the flag <code>--exit-code</code> with a value <code>0</code>, which is why pipeline doesn't fail when HIGH or CRITICAL Docker image vulnerabilities are reported.</p> <pre data-bbox="630 810 1029 1604"> - AWS_REGION= \$AWS_DEFAULT_REGION AWS_ACCOUNT_ID=\$AWS_ACCOUNT_ID trivy - d image --no-progress --ignore-unfixed -- exit-code 0 --severit y HIGH,CRITICAL -- format template -- template "@securit yhub/asff.tpl" -o securityhub/report .asff \$AWS_ACCO UNT_ID.dkr.ecr.\$AW S_DEFAULT_REGION.a mazonaws.com/\$IMAG E_REPO_NAME:\$CODEB UILD_RESOLVED_SOUR CE_VERSION </pre> <p>For the pipeline to fail when HIGH, CRITICAL vulnerabilities are reported, change the value of <code>--exit-code</code> to <code>1</code>.</p>	

Task	Description	Skills required
	<p>Developers or engineers can then fix the vulnerabilities and commit the changes to the CodeCommit source code repository.</p> <p>3. Docker image vulnerabilities reported by Aqua Security Trivy are uploaded to <b>Security Hub</b>. On the AWS Security Hub console, navigate to <b>Findings</b>. Filter the findings with <b>Record State = Active</b> and <b>Product = Aqua Security</b>. This will list the Docker image vulnerabilities in Security Hub. It can take 15 minutes–1 hour for vulnerabilities to appear on Security Hub.</p> <p>For more information about starting the pipeline by using CodePipeline, see <a href="#">Start a pipeline in CodePipeline</a>, <a href="#">Start a pipeline manually</a>, and <a href="#">Start a pipeline on a schedule</a> in the AWS CodePipeline documentation.</p>	



Task	Description	Skills required
Approve the deployment.	<ol style="list-style-type: none"><li data-bbox="592 226 1026 787">1. After the build phase is complete, there is a deployment approval gate. The reviewer or a release manager should inspect the build and, if all requirements are met, approve it. This is the recommended approach for teams that use continuous delivery for application deployment.</li><li data-bbox="592 808 1026 892">2. After approval, the pipeline initiates the Deploy stage.</li><li data-bbox="592 913 1026 1228">3. After the Deploy stage is successful, the CodeBuild log for this stage provides the URL of the application. Use the URL to validate the readiness of the application.</li></ol>	DevOps

Task	Description	Skills required
Validate application profiling.	<p>After the deployment is complete and the application pod is deployed in Amazon EKS, the Amazon CodeGuru Profiler agent configured in the application will try to send profiling data of the application (CPU, heap summary, latency, and bottlenecks) to Amazon CodeGuru Profiler.</p> <p>For the initial deployment of an application, Amazon CodeGuru Profiler takes about 15 minutes to visualize the profiling data.</p>	AWS DevOps

## Related resources

- [AWS CodePipeline documentation](#)
- [Scanning images with Trivy in an AWS CodePipeline](#) (blog post)
- [Improving your Java applications using Amazon CodeGuru Profiler](#) (blog post)
- [AWS Security Finding Format \(ASFF\) syntax](#)
- [Amazon EventBridge event patterns](#)
- [Helm upgrade](#)

## Additional information

CodeGuru Profiler should not be confused with the AWS X-Ray service in terms of functionality. CodeGuru Profiler is preferred for identifying the most expensive lines of codes, which might cause bottlenecks or security issues, and fix them before they become a potential risk. AWS X-Ray service is for application performance monitoring.

In this pattern, event rules are associated with the default event bus. If needed, you can extend the pattern to use a custom event bus.

This pattern uses CodeGuru Reviewer as a static application security testing (SAST) tool for application code. You can also use this pipeline for other tools, such as SonarQube or Checkmarx. The corresponding scan setup instructions of any of these tools can be added in `buildspec/buildspec_secscan.yaml`, replacing the scan instructions of CodeGuru.

# Create an Amazon ECS task definition and mount a file system on EC2 instances using Amazon EFS

*Created by Durga Prasad Cheepuri (AWS)*

**Environment:** PoC or pilot

**Technologies:** Containers & microservices; CloudNative; Management & governance; Storage & backup; Web & mobile apps

**AWS services:** Amazon ECS; Amazon EFS

## Summary

This pattern provides code samples and steps to create an Amazon Elastic Container Service (Amazon ECS) task definition that runs on Amazon Elastic Compute Cloud (Amazon EC2) instances in the Amazon Web Services (AWS) Cloud, while using Amazon Elastic File System (Amazon EFS) to mount a file system on those EC2 instances. Amazon ECS tasks that use Amazon EFS automatically mount the file systems that you specify in the task definition and make these file systems available to the task's containers across all Availability Zones in an AWS Region.

To meet your persistent storage and shared storage requirements, you can use Amazon ECS and Amazon EFS together. For example, you can use Amazon EFS to store persistent user data and application data for your applications with active and standby ECS container pairs running in different Availability Zones for high availability. You can also use Amazon EFS to store shared data that can be accessed in parallel by ECS containers and distributed job workloads.

To use Amazon EFS with Amazon ECS, you can add one or more volume definitions to a task definition. A volume definition includes an Amazon EFS file system ID, access point ID, and a configuration for AWS Identity and Access Management (IAM) authorization or Transport Layer Security (TLS) encryption in transit. You can use container definitions within task definitions to specify the task definition volumes that get mounted when the container runs. When a task that uses an Amazon EFS file system runs, Amazon ECS ensures that the file system is mounted and available to the containers that need access to it.

## Prerequisites and limitations

### Prerequisites

- An active AWS account
- A virtual private cloud (VPC) with a virtual private network (VPN) endpoint or a router
- (Recommended) [Amazon ECS container agent 1.38.0 or later](#) for compatibility with Amazon EFS access points and IAM authorization features (For more information, see the AWS blog post [New for Amazon EFS – IAM Authorization and Access Points.](#))

### Limitations

- Amazon ECS container agent versions earlier than 1.35.0 don't support Amazon EFS file systems for tasks that use the EC2 launch type.

## Architecture

The following diagram shows an example of an application that uses Amazon ECS to create a task definition and mount an Amazon EFS file system on EC2 instances in ECS containers.

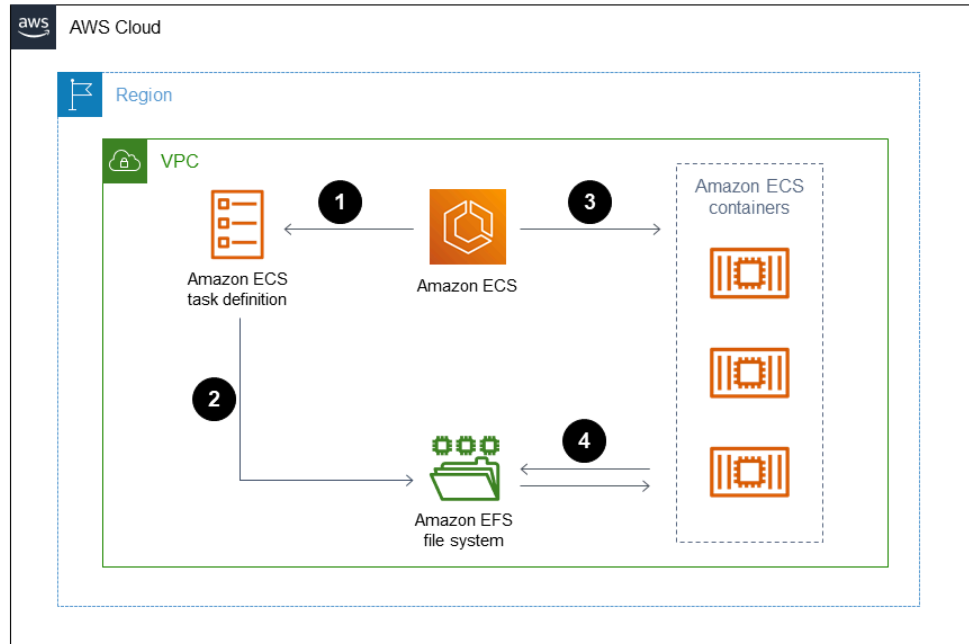

The diagram shows the following workflow:

1. Create an Amazon EFS file system.
2. Create a task definition with a container.
3. Configure the container instances to mount the Amazon EFS file system. The task definition references the volume mounts, so the container instance can use the Amazon EFS file system. ECS tasks have access to the same Amazon EFS file system, regardless of which container instance those tasks are created on.
4. Create an Amazon ECS service with three instances of the task definition.

### Technology stack

- Amazon EC2
- Amazon ECS
- Amazon EFS

## Tools

- [Amazon EC2](#) – Amazon Elastic Compute Cloud (Amazon EC2) provides scalable computing capacity in the AWS Cloud. You can use Amazon EC2 to launch as many or as few virtual servers as you need, and you can scale out or scale in.
- [Amazon ECS](#) – Amazon Elastic Container Service (Amazon ECS) is a highly scalable, fast container management service for running, stopping, and managing containers on a cluster. You can run your tasks and services on a serverless infrastructure that is managed by AWS Fargate. Alternatively, for more control over your infrastructure, you can run your tasks and services on a cluster of EC2 instances that you manage.
- [Amazon EFS](#) – Amazon Elastic File System (Amazon EFS) provides a simple, scalable, fully managed elastic NFS file system for use with AWS Cloud services and on-premises resources.
- [AWS CLI](#) – The AWS Command Line Interface (AWS CLI) is an open-source tool for interacting with AWS services through commands in your command-line shell. With minimal configuration, you can run AWS CLI commands that implement functionality equivalent to that provided by the browser-based AWS Management Console from a command prompt.

## Epics

### Create an Amazon EFS file system

Task	Description	Skills required
Create an Amazon EFS file system by using the AWS Management Console.	<ol style="list-style-type: none"><li>1. <a href="#">Create an Amazon EFS file system</a> and choose the VPC that includes your containers. <b>Note:</b> If you use a different VPC, <a href="#">set up a VPC peering connection</a>.</li><li>2. Note the file system ID.</li></ol>	AWS DevOps

**Create an Amazon ECS task definition by using either an Amazon EFS file system or the AWS CLI**

Task	Description	Skills required
Create a task definition using an Amazon EFS file system.	<p>Create a task definition by using the <a href="#">new Amazon ECS console</a> or <a href="#">classic Amazon ECS console</a> with the following configurations:</p> <ul style="list-style-type: none"><li>• If you use the new console, choose <b>Amazon EC2 instances</b> for <b>App environment</b>. If you use the classic console, choose <b>EC2</b> as the launch type.</li><li>• Add a volume. Enter a name for the volume, choose <b>EFS</b> for volume type, and then choose the file system ID that you noted earlier. For the root directory, choose the Amazon EFS file system path that you want to host on the Amazon ECS container host.</li></ul>	AWS DevOps
Create a task definition using the AWS CLI.	<p>1. To create a JSON template with input parameter placeholders for your task definition, run the following command:</p> <pre>aws ecs register-task-definition</pre>	AWS DevOps



Task	Description	Skills required
	<pre data-bbox="630 205 1027 306">--generate-cli-skeleton</pre> <p data-bbox="591 321 1027 499">2. To create the task definition with the JSON template, run the following command:</p> <pre data-bbox="630 537 1027 772">aws ecs register-task-definition --cli-input-json file://&lt;path_to_your_json_file&gt;</pre> <p data-bbox="591 789 1027 1398">3. Enter the input parameters in your JSON template based on the <code>task_definition_parameters.json</code> file (attached). <b>Note:</b> For more information on input parameters, see <a href="#">Task definition parameters</a> (Amazon ECS documentation) and <a href="#">register-task-definition</a> (AWS CLI Command Reference).</p>	

## Related resources

- [Amazon ECS task definitions](#)
- [Amazon EFS volumes](#)

## Attachments

To access additional content that is associated with this document, unzip the following file:

[attachment.zip](#)

# Deploy Java microservices on Amazon ECS using AWS Fargate

Created by Vijay Thompson (AWS) and Sandeep Bondugula (AWS)

<b>Environment:</b> PoC or pilot	<b>Source:</b> Containers	<b>Target:</b> Amazon ECS
<b>R Type:</b> N/A	<b>Technologies:</b> Containers & microservices; Web & mobile apps	<b>AWS services:</b> Amazon ECS

## Summary

This pattern provides guidance for deploying containerized Java microservices on Amazon Elastic Container Service (Amazon ECS) by using AWS Fargate. The pattern doesn't use Amazon Elastic Container Registry (Amazon ECR) for container management; instead, Docker images are pulled in from a Docker hub.

## Prerequisites and limitations

### Prerequisites

- An existing Java microservices application on a Docker hub
- A public Docker repository
- An active AWS account
- Familiarity with AWS services, including Amazon ECS and Fargate
- Docker, Java, and Spring Boot framework
- Amazon Relational Database Service (Amazon RDS) up and running (optional)
- A virtual private cloud (VPC) if the application requires Amazon RDS (optional)

## Architecture

### Source technology stack

- Java microservices (for example, implemented in Spring Boot) and deployed on Docker

## Source architecture

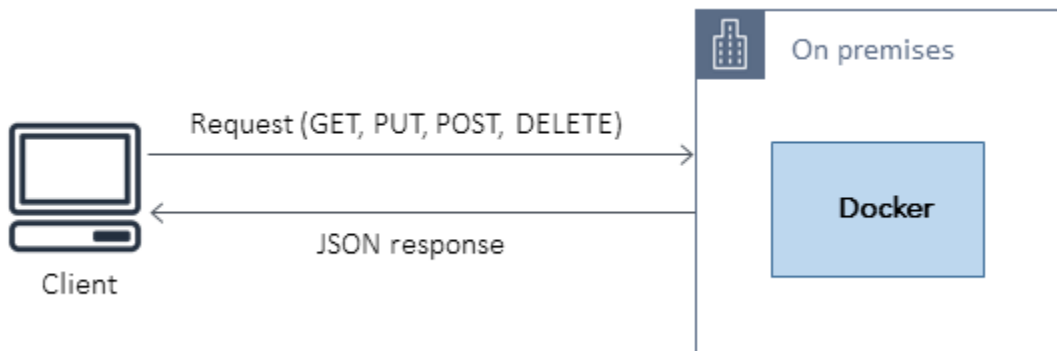

## Target technology stack

- An Amazon ECS cluster that hosts each microservice by using Fargate
- A VPC network to host the Amazon ECS cluster and associated security groups
- A cluster/task definition for each microservice that spins up containers by using Fargate

## Target architecture

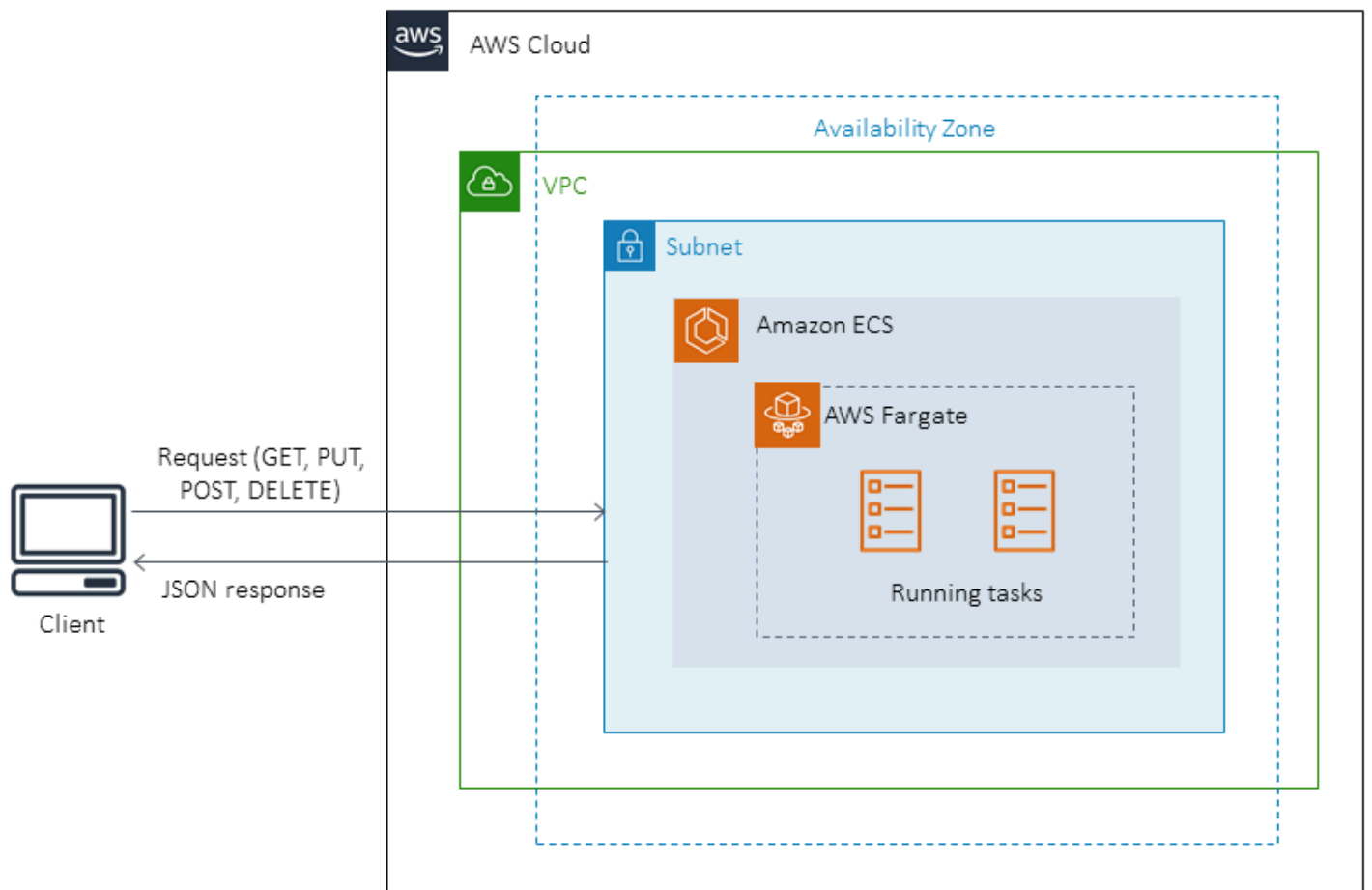

## Tools

### Tools

- [Amazon ECS](#) eliminates the need to install and operate your own container orchestration software, manage and scale a cluster of virtual machines, or schedule containers on those virtual machines.
- [AWS Fargate](#) helps you run containers without needing to manage servers or Amazon Elastic Compute Cloud (Amazon EC2) instances. It's used in conjunction with Amazon Elastic Container Service (Amazon ECS).
- [Docker](#) is a software platform that allows you to build, test, and deploy applications quickly. Docker packages software into standardized units called *containers* that have everything the software needs to run, including libraries, system tools, code, and runtime.

### Docker code

The following Dockerfile specifies the Java Development Kit (JDK) version that is used, where the Java archive (JAR) file exists, the port number that is exposed, and the entry point for the application.

```
FROM openjdk:11
ADD target/Spring-docker.jar Spring-docker.jar
EXPOSE 8080
ENTRYPOINT ["java","-jar","Spring-docker.jar"]
```

## Epics

### Create new task definitions

Task	Description	Skills required
Create a task definition.	Running a Docker container in Amazon ECS requires a task definition. Open the Amazon ECS console at <a href="https://console.aws.amazon.com/ecs/">https://console.aws.amazon.com/ecs/</a> , choose <b>Task definitions</b> , and then create a new task definition. For more information, see the <a href="#">Amazon ECS documentation</a> .	AWS systems administrator, App developer
Choose launch type.	Choose <b>Fargate</b> as the launch type.	AWS systems administrator, App developer
Configure the task.	Define a task name and configure the application with the appropriate amount of task memory and CPU.	AWS systems administrator, App developer
Define the container.	Specify the container name. For the image, enter the Docker site name, the repository name, and the tag	AWS systems administrator, App developer

Task	Description	Skills required
	name of the Docker image (docker.io/sample-repo/sample-application:sample-tag-name ). Set memory limits for the application, and set port mappings (8080, 80) for the allowed ports.	
Create the task.	When the task and container configurations are in place, create the task. For detailed instructions, see the links in the <i>Related resources</i> section.	AWS systems administrator, App developer

## Configure the cluster

Task	Description	Skills required
Create and configure a cluster.	Choose <b>Networking only</b> as the cluster type, configure the name, and then create the cluster or use an existing cluster if available. For more information, see the <a href="#">Amazon ECS documentation</a> .	AWS systems administrator, App developer

## Configure Task

Task	Description	Skills required
Create a task.	Inside the cluster, choose <b>Run new task</b> .	AWS systems administrator, App developer

Task	Description	Skills required
Choose launch type.	Choose <b>Fargate</b> as the launch type.	AWS systems administrator, App developer
Choose task definition, revision, and platform version.	Choose the task that you want to run, the revision of the task definition, and the platform version.	AWS systems administrator, App developer
Select the cluster.	Choose the cluster where you want to run the task from.	AWS systems administrator, App developer
Specify the number of tasks.	Configure the number of tasks that should run. If you're launching with two or more tasks, a load balancer is required to distribute the traffic among the tasks.	AWS systems administrator, App developer
Specify the task group.	(Optional) Specify a task group name to identify a set of related tasks as a task group.	AWS systems administrator, App developer
Configure the cluster VPC, subnets, and security groups.	Configure the cluster VPC and the subnets on which you want to deploy the application. Create or update security groups (HTTP, HTTPS, and port 8080) to provide access to inbound and outbound connections.	AWS systems administrator, App developer



Task	Description	Skills required
Configure public IP settings.	Enable or disable the public IP, depending on whether you want to use a public IP address for Fargate tasks. The default, recommended option is <b>Enabled</b> .	AWS systems administrator, App developer
Review settings and create the task	Review your settings, and then choose <b>Run Task</b> .	AWS systems administrator, App developer

## Cut over

Task	Description	Skills required
Copy the application URL.	When the task status has been updated to <i>Running</i> , select the task. In the Networking section, copy the public IP.	AWS systems administrator, App developer
Test your application.	In your browser, enter the public IP to test the application.	AWS systems administrator, App developer

## Related resources

- [Docker Basics for Amazon ECS](#) (Amazon ECS documentation)
- [Amazon ECS on AWS Fargate](#) (Amazon ECS documentation)
- [Creating a Task Definition](#) (Amazon ECS documentation)
- [Creating a Cluster](#) (Amazon ECS documentation)
- [Configuring Basic Service Parameters](#) (Amazon ECS documentation)
- [Configuring a Network](#) (Amazon ECS documentation)
- [Deploying Java Microservices on Amazon ECS](#) (blog post)



# Deploy Java microservices on Amazon ECS using Amazon ECR and AWS Fargate

Created by Vijay Thompson (AWS) and Sandeep Bondugula (AWS)

<b>Environment:</b> PoC or pilot	<b>Source:</b> Containers	<b>Target:</b> Amazon ECS
<b>R Type:</b> N/A	<b>Technologies:</b> Containers & microservices; Web & mobile apps	<b>AWS services:</b> Amazon ECS

## Summary

This pattern guides you through the steps for deploying Java microservices as containerized applications in Amazon Elastic Container Service (Amazon ECS). The pattern also uses Amazon Elastic Container Registry (Amazon ECR) to manage your container, and AWS Fargate to run your container.

## Prerequisites and limitations

### Prerequisites

- An existing Java microservices application running on premises on Docker
- An active AWS account
- Familiarity with Amazon ECR, Amazon ECS, AWS Fargate, and AWS Command Line Interface (AWS CLI)
- Familiarity with Java and Docker software

### Product versions

- AWS CLI version 1.7 or later

## Architecture

### Source technology stack

- Java microservices (for example, developed using Spring Boot) and deployed on premises
- Docker

### Source architecture

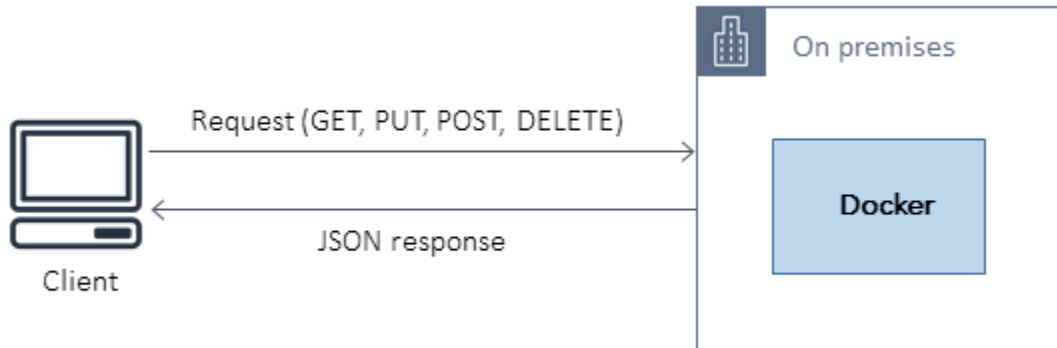

### Target technology stack

- Amazon ECR
- Amazon ECS
- AWS Fargate

### Target architecture

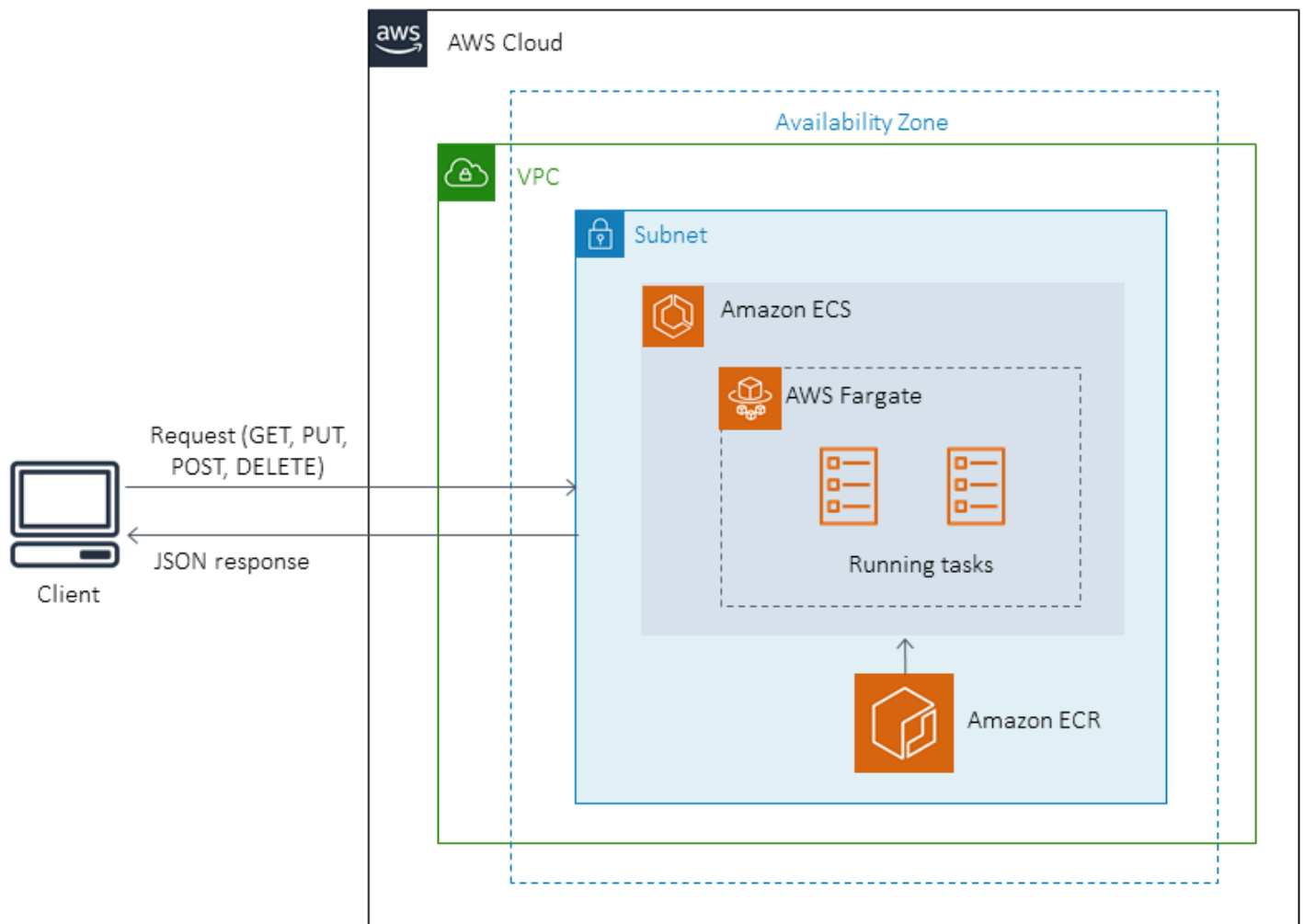

## Tools

### Tools

- [Amazon Elastic Container Registry \(Amazon ECR\)](#) is a fully managed registry that makes it easy for developers to store, manage, and deploy Docker container images. Amazon ECR is integrated with Amazon ECS to simplify your development-to-production workflow. Amazon ECR hosts your images in a highly available and scalable architecture so you can reliably deploy containers for your applications. Integration with AWS Identity and Access Management (IAM) provides resource-level control of each repository.
- [Amazon Elastic Container Service \(Amazon ECS\)](#) is a highly scalable, high-performance container orchestration service that supports Docker containers and allows you to easily run and scale containerized applications on AWS. Amazon ECS eliminates the need for you to install and

operate your own container orchestration software, manage and scale a cluster of virtual machines, or schedule containers on those virtual machines.

- [AWS Fargate](#) is a compute engine for Amazon ECS that allows you to run containers without having to manage servers or clusters. With AWS Fargate, you no longer have to provision, configure, and scale clusters of virtual machines to run containers. This removes the need to choose server types, decide when to scale your clusters, or optimize cluster packing.
- [Docker](#) is a platform that lets you build, test, and deliver applications in packages called containers.

## Code

The following DockerFile specifies the Java Development Kit (JDK) version that is used, where the Java archive (JAR) file exists, the port number that is exposed, and the entry point for the application.

```
FROM openjdk:8
ADD target/Spring-docker.jar Spring-docker.jar
EXPOSE 8080
ENTRYPOINT ["java", "-jar", "Spring-docker.jar"]
```

## Epics

### Create an Amazon ECR repository

Task	Description	Skills required
Create a repository.	Sign in to the AWS Management Console, and open the Amazon ECR console at <a href="https://console.aws.amazon.com/ecr/repositories">https://console.aws.amazon.com/ecr/repositories</a> . Create a private repository. For instructions, see <a href="#">Creating a private repository</a> in the Amazon ECR documentation.	Developer, System Admin

Task	Description	Skills required
Upload the project.	Open the repository and choose <b>View push commands</b> . Follow the steps displayed to upload the project. (These steps work only when you use AWS CLI version 1.7 or later.) When the upload is complete, copy the URL of the build in the repository. You will use this URL when you create a container in Amazon ECS.	Developer, System Admin

## Create and spin up the container

Task	Description	Skills required
Create a task definition.	Running a Docker container in Amazon ECS requires a task definition. Open the Amazon ECS console at <a href="https://console.aws.amazon.com/ecs/">https://console.aws.amazon.com/ecs/</a> , choose <b>Task definitions</b> , and create a new task definition. For more information, see <a href="#">Creating a task definition</a> in the Amazon ECS documentation.	Developer, System Admin
Choose the launch type.	Choose Fargate as the launch type.	Developer, System Admin
Configure the task.	Define a task name and configure the application with	Developer, System Admin

Task	Description	Skills required
	the appropriate amount of task memory and CPU.	
Define the container.	Add the container, providing a name, the URL of the Amazon ECR repository, memory limits, and port mapping. Ports 8080 and 80 are configured for port mappings. Configure the remaining settings based on your application requirements.	Developer, System Admin
Create the task.	When the task and container configurations are in place, create the task. For detailed instructions, see the links in the <a href="#">Related resources</a> section.	Developer, System Admin

## Create an Amazon ECS cluster and configure a service

Task	Description	Skills required
Create or choose a cluster.	An Amazon ECS cluster provides a logical grouping of tasks or services. You can opt to use an existing cluster or create a new cluster. If you decide to create a new cluster, choose the cluster type based on your requirements. In our example, we selected a networking cluster. Provide a name for the cluster and	Developer, System Admin



Task	Description	Skills required
	choose whether you want to create a new virtual private cloud (VPC) to use for Fargate tasks.	
Create a service.	Inside the cluster, choose <b>Create service</b> .	Developer, System Admin
Choose the launch type.	Choose Fargate as the launch type.	Developer, System Admin
Choose task definition, revision, and platform version.	Choose the task that you want to run, followed by the revision of the task definition and the platform version.	Developer, System Admin
Select the cluster.	Select the cluster in which to create your service from the dropdown list.	Developer, System Admin
Provide a service name.	Provide a unique name for the service that you are creating.	Developer, System Admin
Specify the number of tasks.	Configure the number of tasks that should run when the service launches. If you're launching with two or more tasks, a load balancer is required to balance the tasks. The minimum number of tasks to be configured is <b>One</b> .	Developer, System Admin

Task	Description	Skills required
Set the minimum and maximum healthy percentages.	Configure the minimum and maximum healthy percentages for the application, or accept the default option that is provided.	Developer, System Admin
Configure deployment settings.	Choose the deployment type based on your requirements. You can choose a rolling update or a blue/green deployment.	Developer, System Admin
Configure the cluster VPC, subnets, and security groups.	Configure the cluster VPC, the subnets on which you want to deploy the application, and the security groups (HTTP, HTTPS, and port 8080) for providing access to inbound/outbound connections.	Developer, System Admin
Configure public IP settings.	Enable or disable the public IP, depending on whether you want to use a public IP address for Fargate tasks.	Developer, System Admin
Configure load balancing.	Configure the load balancer, if you're launching the service with more than one task. You must create a load balancer and its target group before you launch the service.	Developer, System Admin

Task	Description	Skills required
Configure automatic scaling.	Configure your service to use Amazon ECS Service Auto Scaling to adjust the desired number of tasks up or down, depending on your requirements.	Developer, System Admin
Review settings and create the service.	Review your service settings, and then choose <b>Create service</b> .	Developer, System Admin

## Cut over

Task	Description	Skills required
Test your application.	Test the application by using the public DNS that's created when the task is deployed. If the application has a load balancer, test the application by using it and then cut over.	Developer, System Admin

## Related resources

- [Docker basics for Amazon ECS](#) (Amazon ECS documentation)
- [Amazon ECS on AWS Fargate](#) (Amazon ECS documentation)
- [Creating a private repository](#) (Amazon ECR documentation)
- [Creating a task definition](#) (Amazon ECS documentation)
- [Container definitions](#) (Amazon ECS documentation)
- [Creating a cluster](#) (Amazon ECS documentation)
- [Configuring basic service parameters](#) (Amazon ECS documentation)
- [Configuring a network](#) (Amazon ECS documentation)

- [Configuring your service to use a load balancer](#) (Amazon ECS documentation)
- [Configuring your service to use Service Auto Scaling](#) (Amazon ECS documentation)

# Deploy Java microservices on Amazon ECS using Amazon ECR and load balancing

Created by Durga Prasad Cheepuri (AWS)

<b>Environment:</b> PoC or pilot	<b>Source:</b> Java	<b>Target:</b> Amazon ECS
<b>R Type:</b> N/A	<b>Technologies:</b> Containers & microservices; Web & mobile apps	<b>AWS services:</b> Amazon ECS

## Summary

This pattern outlines steps for deploying a containerized Java microservices architecture on Amazon Elastic Container Service (Amazon ECS) to make it easier to scale and faster to develop your applications. This helps enable innovation and accelerates time-to-market for new features.

The pattern also uses Amazon Elastic Container Registry (Amazon ECR) to store and manage the Docker-based containers, and an AWS CloudFormation template with a Python script to automate the setup of your infrastructure. The pattern is based on the post [Deploying Java Microservices on Amazon Elastic Container Service](#), which is published on the AWS Compute blog.

Microservices provide an architectural and organizational approach to software development, where software is composed of small, independent services that communicate over well-defined application programming interfaces (APIs). Small, self-contained teams own these services.

Amazon ECS is a highly scalable, high-performance container orchestration service. It supports Docker containers and enables you to run and scale containerized applications on AWS quickly. With Amazon ECS, you no longer have to install and operate your container orchestration software, manage and scale a cluster of virtual machines (VMs), or schedule containers on those VMs.

With simple API calls, you can launch and stop Docker-enabled applications, query the complete state of your request, and access many natural features, such as AWS Identity and Access Management (IAM) roles, security groups, load balancers, Amazon CloudWatch Events, AWS CloudFormation templates, and AWS CloudTrail logs.

## Prerequisites and limitations

### Prerequisites

- An active AWS account
- Java microservices source code, with Java Development Kit version 1.7 or later
- An access key and secret access key for a user in the account
- AWS Command Line Interface (AWS CLI)
- Java, AWS Software Development Kit (SDK) for Python (Boto3), and Docker software
- Familiarity with the use of the preceding technologies
- Familiarity with AWS services such as Amazon ECS, AWS CloudFormation, and Elastic Load Balancing

## Architecture

### Source technology stack

- Microservices implemented in Java and deployed on Apache Tomcat in an on-premises environment

### Target technology stack

- The Application Load Balancer that inspects the client request. Based on routing rules, the load balancer directs the request to an instance and port from the target group that matches the state.
- A target group for each microservice. The target groups are used by the corresponding services to register available container instances. Each target group has a path, so when you call the way for a particular microservice, it maps to the correct target group. This enables you to use one Application Load Balancer to serve all the microservices, accessed by the path. For example, `https:///owner/*` would map and direct to the Owner microservice.
- An Amazon ECS cluster that hosts the containers for each microservice.
- An Amazon Virtual Private Cloud (Amazon VPC) network for hosting the Amazon ECS cluster and associated security groups.
- An Amazon Elastic Container Registry (Amazon ECR) repository for each microservice.

- A service or task definition for each microservice, which spins up containers on the instances of the Amazon ECS cluster.

### Target architecture

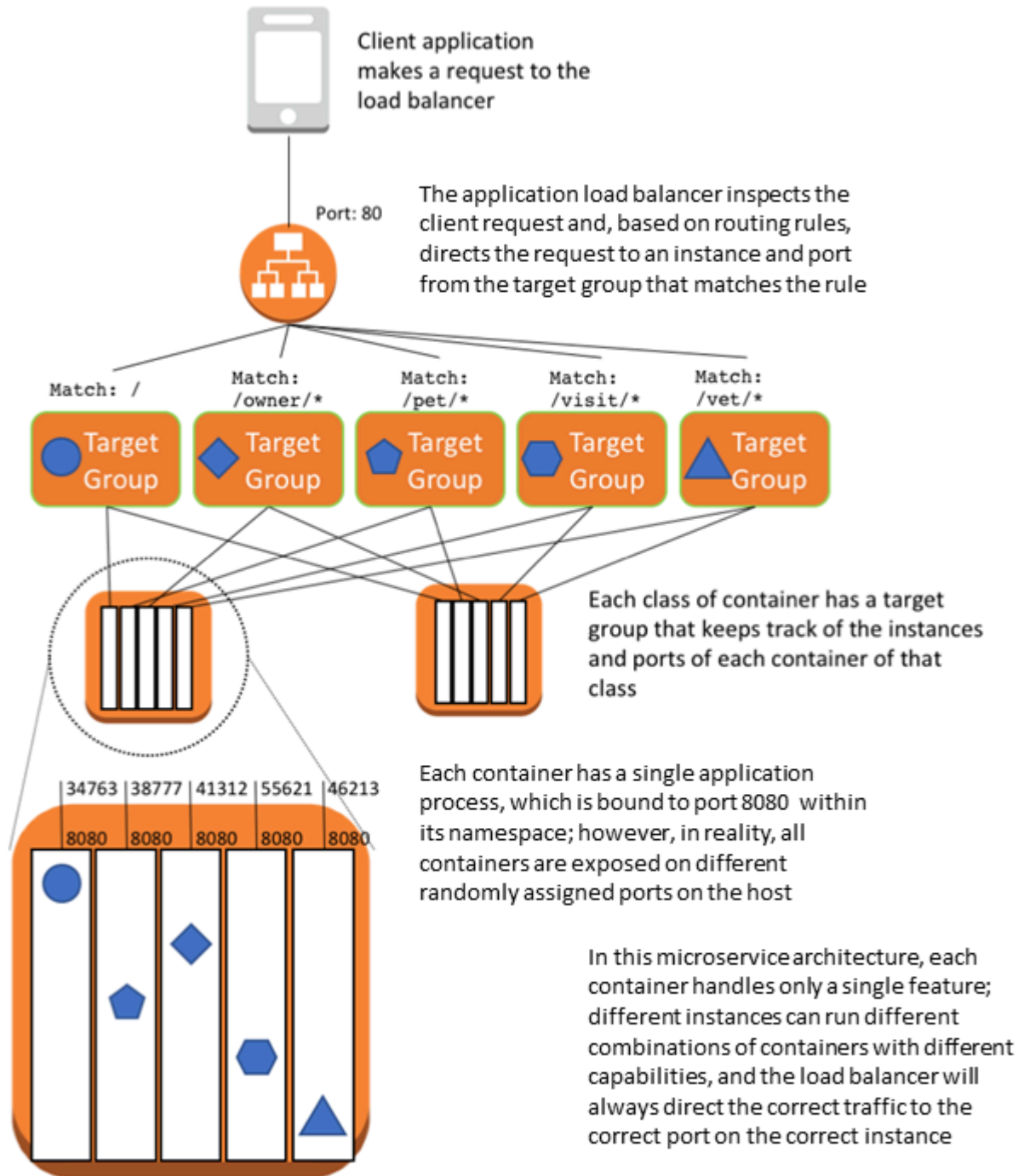

## Tools

- [Amazon ECS](#) – Amazon ECS lets you launch and stop container-based applications with simple API calls, enables you to get the state of your cluster from a centralized service, and gives you access to many familiar Amazon Elastic Compute Cloud (Amazon EC2) features.
- [Amazon ECR](#) – Amazon Elastic Container Registry (Amazon ECR) is a fully managed registry that makes it easy for developers to store, manage, and deploy Docker container images. Amazon ECR is integrated with Amazon ECS to simplify your development-to-production workflow. Amazon ECR hosts your images in a highly available and scalable architecture so you can reliably deploy containers for your applications. Integration with AWS Identity and Access Management (IAM) provides resource-level control of each repository.

## Epics

### Create an AWS CloudFormation template to set up an Amazon ECS cluster to host the Java microservices

Task	Description	Skills required
Provision an Amazon EC2 Linux instance, install Docker, and create a Docker file for each microservice.		Ops
Set up Docker images on Amazon ECR.	Use the Dockerfile for the image to push, build the image, and tag it for your new repository. Do the same for each microservice. Push the newly tagged images to the repository.	Ops
Create an AWS CloudFormation template.	Create an AWS CloudFormation template to provision the virtual private cloud (VPC), Amazon ECS cluster, and Amazon Relational	Ops



Task	Description	Skills required
	Database Service (Amazon RDS).	

## Provision AWS services

Task	Description	Skills required
Create the AWS infrastructure by using the CloudFormation template you created earlier.	Use the Python script at <a href="https://github.com/awslabs/amazon-ecs-java-microservices/blob/master/2_ECS_Java_Spring_PetClinic_Microservices/setup.py">https://github.com/awslabs/amazon-ecs-java-microservices/blob/master/2_ECS_Java_Spring_PetClinic_Microservices/setup.py</a> to invoke the AWS CloudFormation template you created earlier. This template creates the AWS infrastructure you need for the target environment.	Ops
Create Amazon ECR repositories, tasks, services, the Application Load Balancer, and target groups.	The Python script reads the outputs of the AWS CloudFormation template and uses BOTO3 API calls to create Amazon ECR repositories, tasks, services, the Application Load Balancer, and target groups.	Ops

## Related resources

- [Deploying Java Microservices on Amazon Elastic Container Service](#) (AWS Compute blog post)
- [Python script](#)

- [Amazon ECS documentation](#)
- [Docker basics for Amazon ECS](#)
- [AWS SDK for Python](#)
- [Amazon VPC documentation](#)
- [Amazon ECR documentation](#)

# Deploy Kubernetes resources and packages using Amazon EKS and a Helm chart repository in Amazon S3

*Created by Sagar Panigrahi (AWS)*

**Environment:** PoC or pilot

**Technologies:** Containers & microservices; DevOps

**AWS services:** Amazon EKS

## Summary

This pattern helps you to manage Kubernetes applications efficiently, regardless of their complexity. The pattern integrates Helm into your existing continuous integration and continuous delivery (CI/CD) pipelines to deploy applications into a Kubernetes cluster. Helm is a Kubernetes package manager that helps you manage Kubernetes applications. Helm charts help to define, install, and upgrade complex Kubernetes applications. Charts can be versioned and stored in Helm repositories, which improves mean time to restore (MTTR) during outages.

This pattern uses Amazon Elastic Kubernetes Service (Amazon EKS) for the Kubernetes cluster. It uses Amazon Simple Storage Service (Amazon S3) as a Helm chart repository, so that the charts can be centrally managed and accessed by developers across the organization.

## Prerequisites and limitations

### Prerequisites

- An active Amazon Web Services (AWS) account with a virtual private cloud (VPC)
- An Amazon EKS cluster
- Worker nodes set up within the Amazon EKS cluster and ready to take workloads
- Kubectl for configuring the Amazon EKS kubeconfig file for the target cluster in the client machine
- AWS Identity and Access Management (IAM) access to create the S3 bucket
- IAM (programmatically or role) access to Amazon S3 from the client machine
- Source code management and a CI/CD pipeline

## Limitations

- There is no support at this time for upgrading, deleting, or managing custom resource definitions (CRDs).
- If you are using a resource that refers to a CRD, the CRD must be installed separately (outside of the chart).

## Product versions

- Helm v3.6.3

## Architecture

### Target technology stack

- Amazon EKS
- Amazon VPC
- Amazon S3
- Source code management
- Helm
- Kubectl

### Target architecture

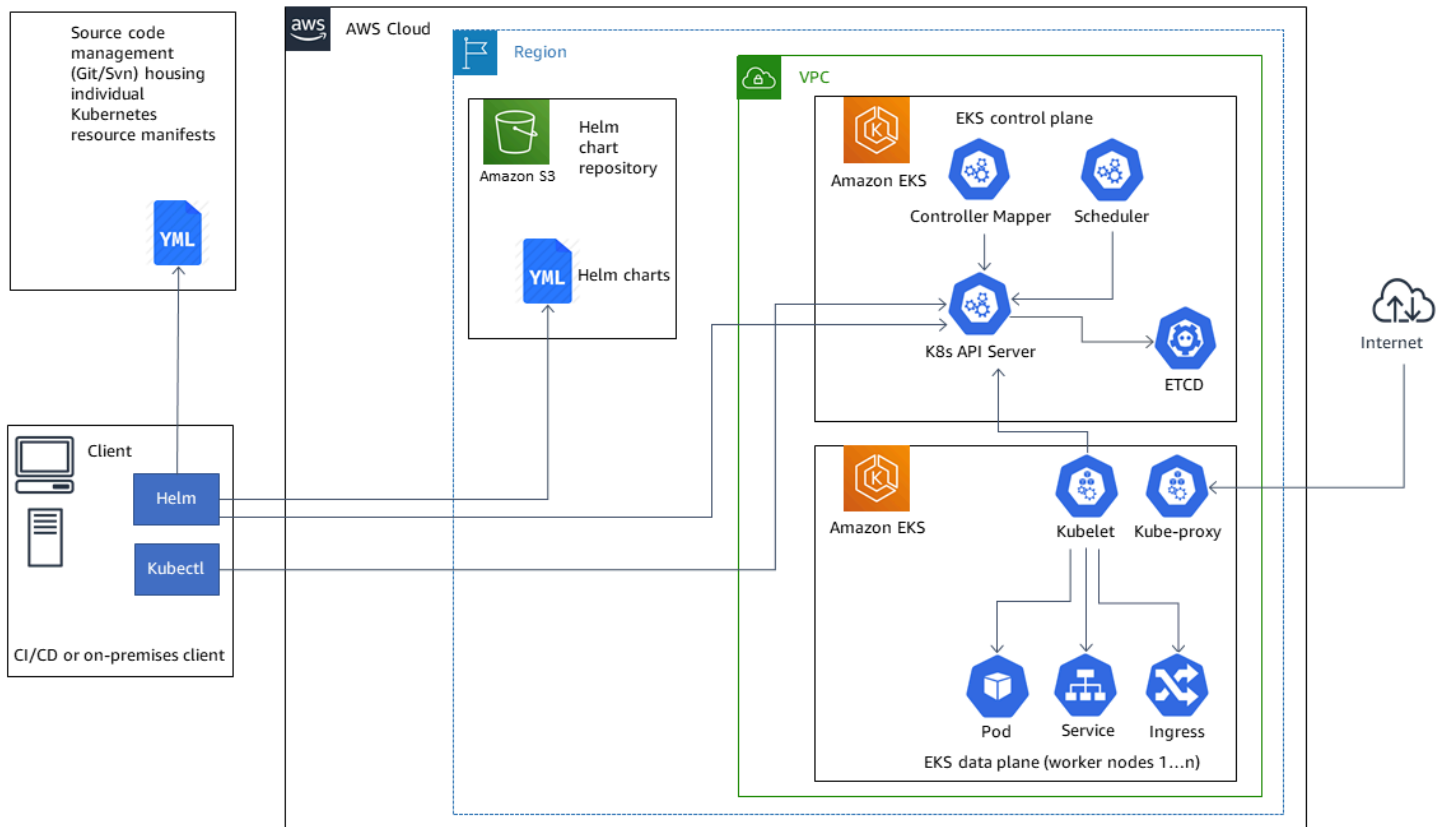

## Automation and scale

- AWS CloudFormation can be used to automate the infrastructure creation. For more information, see [Creating Amazon EKS resources with AWS CloudFormation](#) in the Amazon EKS documentation.
- Helm is to be incorporated into your existing CI/CD automation tool to automate the packaging and versioning of Helm charts (out of scope for this pattern).
- GitVersion or Jenkins build numbers can be used to automate the versioning of charts.

## Tools

### Tools

- [Amazon EKS](#) – Amazon Elastic Kubernetes Service (Amazon EKS) is a managed service for running Kubernetes on AWS without needing to stand up or maintain your own Kubernetes control plane. Kubernetes is an open-source system for automating the deployment, scaling, and management of containerized applications.

- [Helm](#) – Helm is a package manager for Kubernetes that helps you install and manage applications on your Kubernetes cluster.
- [Amazon S3](#) – Amazon Simple Storage Service (Amazon S3) is storage for the internet. You can use Amazon S3 to store and retrieve any amount of data at any time, from anywhere on the web.
- [Kubectl](#) – Kubectl is a command line utility for running commands against Kubernetes clusters.

## Code

The example code is attached.

## Epics

### Configure and initialize Helm

Task	Description	Skills required
Install the Helm client.	To download and install the Helm client on your local system, use the following command.  <pre>sudo curl https://raw.githubusercontent.com/helm/helm/master/scripts/get-helm-3   bash</pre>	DevOps engineer
Validate the Helm installation.	To validate that Helm is able to communicate with the Kubernetes API server within the Amazon EKS cluster, run <code>helm version</code> .	DevOps engineer

## Create and install a Helm chart in the Amazon EKS cluster

Task	Description	Skills required
Create a Helm chart for NGINX.	To create a helm chart named <code>my-nginx</code> on the client machine, run <code>helm create my-nginx</code> .	DevOps engineer
Review the structure of the chart.	To review the structure of the chart, run the <code>tree</code> command <code>tree my-nginx/</code> .	DevOps engineer
Deactivate service account creation in the chart.	In <code>values.yaml</code> , under the <code>serviceAccount</code> section, set the <code>create</code> key to <code>false</code> . This is turned off because there is no requirement to create a service account for this pattern.	DevOps engineer
Validate (lint) the modified chart for syntactical errors.	To validate the chart for any syntactical error before installing it in the target cluster, run <code>helm lint my-nginx/</code> .	DevOps engineer
Install the chart to deploy Kubernetes resources.	To run the Helm chart installation, use the following command. <pre>helm install --name my-nginx-release --debug my-nginx/ --namespace helm-space</pre> <p>The optional debug flag outputs all debug messages</p>	DevOps engineer

Task	Description	Skills required
	during the installation. The <code>namespace</code> flag specifies the namespace in which the resources part of this chart will be created.	
Review the resources in the Amazon EKS cluster.	To review the resources that were created as part of the Helm chart in the <code>helm-space</code> namespace, use the following command.  <pre>kubectl get all -n helm-space</pre>	DevOps engineer

## Roll back to a previous version of a Kubernetes application

Task	Description	Skills required
Modify and upgrade the release.	To modify the chart, in <code>values.yaml</code> , change the <code>replicaCount</code> value to 2. Then upgrade the already installed release by running the following command.  <pre>helm upgrade my-nginx-release my-nginx/ --namespace helm-space</pre>	DevOps engineer
Review the history of the Helm release.	To list all the revisions for a specific release that have been installed using Helm, run the following command.	DevOps engineer



Task	Description	Skills required
	<pre>helm history my-nginx-release</pre>	
Review the details for a specific revision.	<p>Before switching or rolling back to a working version, and for an additional layer of validation before installing a revision, view which values were passed to each of the revisions by using the following command.</p> <pre>helm get --revision=2 my-nginx-release</pre>	DevOps engineer
Roll back to a previous version.	<p>To roll back to a previous revision, use the following command.</p> <pre>helm rollback my-nginx-release 1</pre> <p>This example is rolling back to revision number 1.</p>	DevOps engineer

### Initialize an S3 bucket as a Helm repository

Task	Description	Skills required
Create an S3 bucket for Helm charts.	Create a unique S3 bucket. In the bucket, create a folder called <code>charts</code> . The example in this pattern uses <code>s3://my-</code>	Cloud administrator

Task	Description	Skills required
<p>Install the Helm plugin for Amazon S3.</p>	<p>helm-charts/charts as the target chart repository.</p> <p>To install the helm-s3 plugin on your client machine, use the following command.</p> <pre>helm plugin install https://github.com/hypnoglow/helm-s3.git --version 0.10.0</pre> <p>Note: Helm V3 support is available with plugin version 0.9.0 and above.</p>	DevOps engineer
<p>Initialize the Amazon S3 Helm repository.</p>	<p>To initialize the target folder as a Helm repository, use the following command.</p> <pre>helm S3 init s3://my-helm-charts/charts</pre> <p>The command creates an <code>index.yaml</code> file in the target to track all the chart information that is stored at that location.</p>	DevOps engineer

Task	Description	Skills required
Add the Amazon S3 repository to Helm.	<p>To add the repository in the client machine, use the following command.</p> <pre>helm repo add my-helm-charts s3://my-helm-charts/charts</pre> <p>This command adds an alias to the target repository in the Helm client machine.</p>	DevOps engineer
Review the repository list.	To view the list of repositories in the Helm client machine, run <code>helm repo list</code> .	DevOps engineer

### Package and store charts in the Amazon S3 Helm repository

Task	Description	Skills required
Package the chart.	To package the <code>my-nginx</code> chart that you created, run <code>helm package ./my-nginx/</code> . The command packages all the contents of the <code>my-nginx</code> chart folder into an archive file, which is named using the version number that is mentioned in the <code>Chart.yaml</code> file.	DevOps engineer
Store the package in the Amazon S3 Helm repository.	To upload the package to the Helm repository in Amazon S3, run the following	DevOps engineer

Task	Description	Skills required
	<p>command, using the correct name of the <code>.tgz</code> file.</p> <pre>helm s3 push ./my-nginx-0.1.0.tgz my-helm-charts</pre>	
Search for the Helm chart.	<p>To confirm that the chart appears both locally and in the Helm repository in Amazon S3, run the following command.</p> <pre>helm search repo my-nginx</pre>	DevOps engineer

### Modify, version, and package a chart

Task	Description	Skills required
Modify and package the chart.	<p>In <code>values.yaml</code>, set the <code>replicaCount</code> value to 1. Then package the chart by running <code>helm package ./my-nginx/</code>, this time changing the version in <code>Chart.yaml</code> to <code>0.1.1</code>.</p> <p>The versioning is ideally updated through automation using tools such as <code>GitVersion</code> or Jenkins build numbers in a CI/CD pipeline. Automating</p>	DevOps engineer

Task	Description	Skills required
	the version number is out of scope for this pattern.	
Push the new version to the Helm repository in Amazon S3.	To push the new package with version of 0.1.1 to the my-helm-charts Helm repository in Amazon S3, run the following command.  <pre>helm s3 push ./my-nginx-0.1.1.tgz my-helm-charts</pre>	DevOps engineer

### Search for and install a chart from the Amazon S3 Helm repository

Task	Description	Skills required
Search for all versions of the my-nginx chart.	To view all the available versions of a chart, run the following command with the <code>--versions</code> flag.  <pre>helm search repo my-nginx --versions</pre> <p>Without the flag, Helm by default displays the latest uploaded version of a chart.</p>	DevOps engineer
Install a chart from the Amazon S3 Helm repository.	The search results from the previous task show the multiple versions of the my-nginx chart. To install the new version (0.1.1) from the	DevOps engineer

Task	Description	Skills required
	<p>Amazon S3 Helm repository, use the following command.</p> <pre data-bbox="597 331 1026 569">helm upgrade my-nginx- release my-helm-c harts/my-nginx -- version 0.1.1 --namespa ce helm-space</pre>	

## Related resources

- [HELM documentation](#)
- [helm-s3 plugin \(MIT License\)](#)
- [HELM client binary](#)
- [Amazon EKS documentation](#)

## Attachments

To access additional content that is associated with this document, unzip the following file: [attachment.zip](#)

# Deploy Lambda functions with container images

Created by Ram Kandaswamy (AWS)

<b>Environment:</b> Production	<b>Technologies:</b> Containers & microservices; CloudNative; DevelopmentAndTesting; Serverless	<b>Workload:</b> All other workloads
<b>AWS services:</b> Amazon EC2 Container Registry; AWS Lambda		

## Summary

AWS Lambda supports container images as a deployment model. This pattern shows how to deploy Lambda functions through container images.

Lambda is a serverless, event-driven compute service that you can use to run code for virtually any type of application or backend service without provisioning or managing servers. With container image support for Lambda functions, you get the benefits of up to 10 GB of storage for your application artifact and the ability to use familiar container image development tools.

The example in this pattern uses Python as the underlying programming language, but you can use other languages, such as Java, Node.js, or Go. The pattern uses AWS CodeCommit as the source, but you could also use GitHub, Bitbucket, or Amazon Simple Storage Service (Amazon S3).

## Prerequisites and limitations

### Prerequisites

- Amazon Elastic Container Registry (Amazon ECR) activated
- Application code
- Docker images with the runtime interface client and the latest version of Python

### Limitations

- Maximum image size supported is 10 GB.
- Maximum runtime for a Lambda based container deployment is 15 minutes.

## Architecture

### Target technology stack

- Python programming language
- AWS CodeBuild
- AWS CodeCommit
- Docker image
- Amazon ECR
- AWS Identity and Access Management (IAM)
- AWS Lambda
- Amazon CloudWatch Logs

### Target architecture

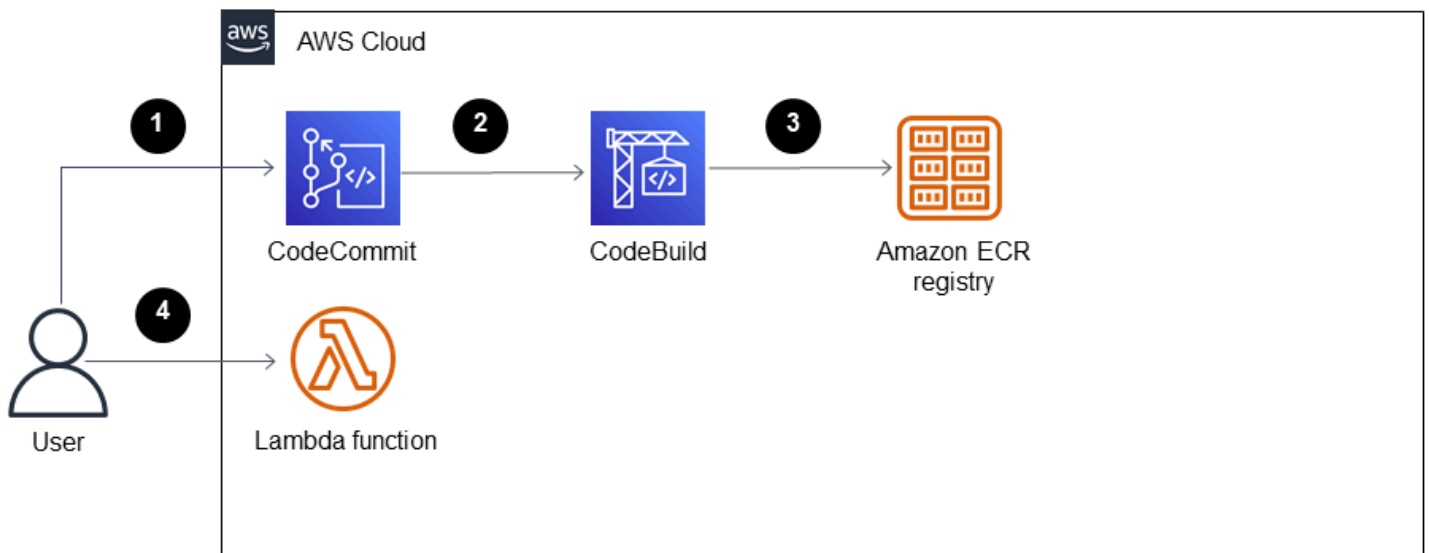

1. You create a repository and commit the application code using CodeCommit.
2. The CodeBuild project is initiated when a change is made to CodeCommit, which is used as the source provider.
3. The CodeBuild project creates the Docker image and publishes the image to Amazon ECR.



4. You create the Lambda function by using the image in Amazon ECR.

## Automation and scale

This pattern can be automated by using AWS CloudFormation, AWS Cloud Development Kit (AWS CDK), or API operations from an SDK. Lambda can automatically scale based on the number of requests, and you can tune it by using the concurrency parameters. For more information, see the [Lambda documentation](#).

## Tools

### AWS services

- [AWS CloudFormation Designer](#) provides an integrated JSON and YAML editor that helps you view and edit CloudFormation templates.
- [AWS CodeBuild](#) is a fully managed build service that helps you compile source code, run unit tests, and produce artifacts that are ready to deploy.
- [AWS CodeCommit](#) is a version control service that helps you privately store and manage Git repositories, without needing to manage your own source control system.
- [AWS CodeStar](#) is a cloud-based service for creating, managing, and working with software development projects on AWS. For this pattern, you can use AWS CodeStar or another development environment.
- [Amazon Elastic Container Registry \(Amazon ECR\)](#) is a managed container image registry service that's secure, scalable, and reliable.
- [AWS Lambda](#) is a compute service that helps you run code without needing to provision or manage servers. It runs your code only when needed and scales automatically, so you pay only for the compute time that you use.

### Other tools

- [Docker](#) is a set of platform as a service (PaaS) products that use virtualization at the operating-system level to deliver software in containers.

## Best practices

- Make your function as efficient and small as possible to avoid loading unnecessary files.

- Strive to have static layers higher up in your Docker file list, and place layers that change more often lower down. This improves caching, which improves performance.
- The image owner is responsible for updating and patching the image. Add that update cadence to your operational processes. For more information, see the [AWS Lambda documentation](#).

## Epics

### Create a project in CodeBuild

Task	Description	Skills required
Create a CodeCommit repository.	Create a CodeCommit repository that will contain the Dockerfile, the <code>buildspec.yaml</code> file, and the application source code. For more information, see the <a href="#">AWS CodeCommit documentation</a> .	Developer
Create a CodeBuild project.	On the CodeBuild console, create a new project that uses the CodeCommit repo and the <code>buildspec.yaml</code> file. You will use the CodeBuild project to create the image.  Confirm that privileged mode is enabled. To build Docker images, this is necessary. Otherwise, the image will not build successfully.  Provide values for project name and description. For the source provider, choose CodeCommit. For more	Developer

Task	Description	Skills required
	information, see the <a href="#">AWS documentation</a> .	
Edit the Dockerfile.	<p>The Dockerfile should be located in the top-level directory where you're developing the application. The Python code should be in the <code>src</code> folder.</p> <p>When you create the image, use the <a href="#">official Lambda supported images</a>. Otherwise, a bootstrap error will occur, making the packing process more difficult.</p> <p>For details, see the <a href="#">Additional information</a> section.</p>	Developer
Create a repo in Amazon ECR.	<p>Create a container repository in Amazon ECR. In the following example command, the name of the repository created is <code>cf-demo</code>. The repository will be reused in the <code>buildspec.yaml</code> file.</p> <pre>aws ecr create-repository --cf-demo</pre>	AWS administrator, Developer

Task	Description	Skills required
Push the image to Amazon ECR.	You can use CodeBuild to perform the image-build process. CodeBuild needs permission to interact with Amazon ECR and to work with S3. As part of the process, the Docker image is built and pushed to the Amazon ECR registry. For details on the template and the code, see the <a href="#">Additional information</a> section.	Developer
Verify that the image is in the repository.	To verify that the image is in the repository, on the Amazon ECR console, choose <b>Repositories</b> . The image should be listed, with tags and with the results of a vulnerability scan report if that feature was turned on in the Amazon ECR settings. For more information, see the <a href="#">AWS documentation</a> .	Developer

### Create the Lambda function to run the image

Task	Description	Skills required
Create the Lambda function.	On the Lambda console, choose <b>Create function</b> , and then choose <b>Container image</b> . Enter the function name and the URI for the	App developer

Task	Description	Skills required
	image that is in the Amazon ECR repository, and then choose <b>Create function</b> . For more information, see the <a href="#">AWS Lambda documentation</a> .	
Test the Lambda function.	To invoke and test the function, choose <b>Test</b> . For more information, see the <a href="#">AWS Lambda documentation</a> .	App developer

## Troubleshooting

Issue	Solution
Build is not succeeding.	<ol style="list-style-type: none"><li>1. Check if the privileged mode is turned on for the CodeBuild project.</li><li>2. Ensure that the Docker related commands have the necessary permissions. Trying adding sudo to the commands.</li><li>3. Verify that the IAM role associated with CodeBuild has a policy with appropriate actions to interact with Amazon ECR, Amazon S3, and CloudWatch logs.</li></ol>

## Related resources

- [Base images for Lambda](#)
- [Docker sample for CodeBuild](#)
- [Pass temporary credentials](#)

## Additional information

### Edit the Dockerfile

The following code shows the commands that you edit in the Dockerfile.

```
FROM public.ecr.aws/lambda/python:3.11

# Copy function code
COPY app.py ${LAMBDA_TASK_ROOT}
COPY requirements.txt ${LAMBDA_TASK_ROOT}

# install dependencies
RUN pip3 install --user -r requirements.txt

# Set the CMD to your handler (could also be done as a parameter override outside of
  the Dockerfile)
CMD [ "app.lambda_handler" ]
```

The FROM command value corresponds to the Python 3.11 base image that is using the Lambda function in the public Amazon ECR image repository.

The COPY app.py \${LAMBDA\_TASK\_ROOT} command copies the code to the task root directory, which the Lambda function will use. This command uses the environment variable so we don't have to worry about the actual path. The function to be run is passed as an argument to the CMD [ "app.lambda\_handler" ] command.

The COPY requirements.txt command captures the dependencies necessary for the code.

The RUN pip install --user -r requirements.txt command installs the dependencies to the local user directory.

To build your image, run the following command.

```
docker build -t <image name> .
```

### Add the image in Amazon ECR

In the following code, replace aws\_account\_id with the account number, and replace us-east-1 if you are using a different Region. The buildspec file uses the CodeBuild build number to uniquely identify image versions as a tag value. You can change this to fit your requirements.

## The buildspec custom code

```
phases:
  install:
    runtime-versions:
      python: 3.11
  pre_build:
    commands:
      - python3 --version
      - pip3 install --upgrade pip
      - pip3 install --upgrade awscli
      - sudo docker info
  build:
    commands:
      - echo Build started on `date`
      - echo Building the Docker image...
      - ls
      - cd app
      - docker build -t cf-demo:$CODEBUILD_BUILD_NUMBER .
      - docker container ls
  post_build:
    commands:
      - echo Build completed on `date`
      - echo Pushing the Docker image...
      - aws ecr get-login-password --region us-east-1 | docker login --username AWS --
password-stdin aws_account_id.dkr.ecr.us-east-1.amazonaws.com
      - docker tag cf-demo:$CODEBUILD_BUILD_NUMBER aws_account_id.dkr.ecr.us-
east-1.amazonaws.com/cf-demo:$CODEBUILD_BUILD_NUMBER
      - docker push aws_account_id.dkr.ecr.us-east-1.amazonaws.com/cf-demo:
$CODEBUILD_BUILD_NUMBER
```

# Deploy a sample Java microservice on Amazon EKS and expose the microservice using an Application Load Balancer

Created by Vijay Thompson (AWS) and Akkamahadevi Hiremath (AWS)

**Environment:** PoC or pilot

**Technologies:** Containers & microservices

**Workload:** Open-source

**AWS services:** Amazon EC2 Container Registry; Amazon EKS; Amazon ECR

## Summary

This pattern describes how to deploy a sample Java microservice as a containerized application on Amazon Elastic Kubernetes Service (Amazon EKS) by using the `eksctl` command line utility and Amazon Elastic Container Registry (Amazon ECR). You can use an Application Load Balancer to load balance the application traffic.

## Prerequisites and limitations

### Prerequisites

- An active AWS account
- The AWS Command Line Interface (AWS CLI) version 1.7 or later, installed and configured on macOS, Linux, or Windows
- A running [Docker daemon](#)
- The `eksctl` command line utility, installed and configured on macOS, Linux, or Windows (For more information, see [Getting started with Amazon EKS – eksctl](#) in the Amazon EKS documentation.)
- The `kubectl` command line utility, installed and configured on macOS, Linux, or Windows (For more information, see [Installing or updating kubectl](#) in the Amazon EKS documentation.)

### Limitations



- This pattern doesn't cover the installation of an SSL certificate for the Application Load Balancer.

## Architecture

### Target technology stack

- Amazon ECR
- Amazon EKS
- Elastic Load Balancing

### Target architecture

The following diagram shows an architecture for containerizing a Java microservice on Amazon EKS.

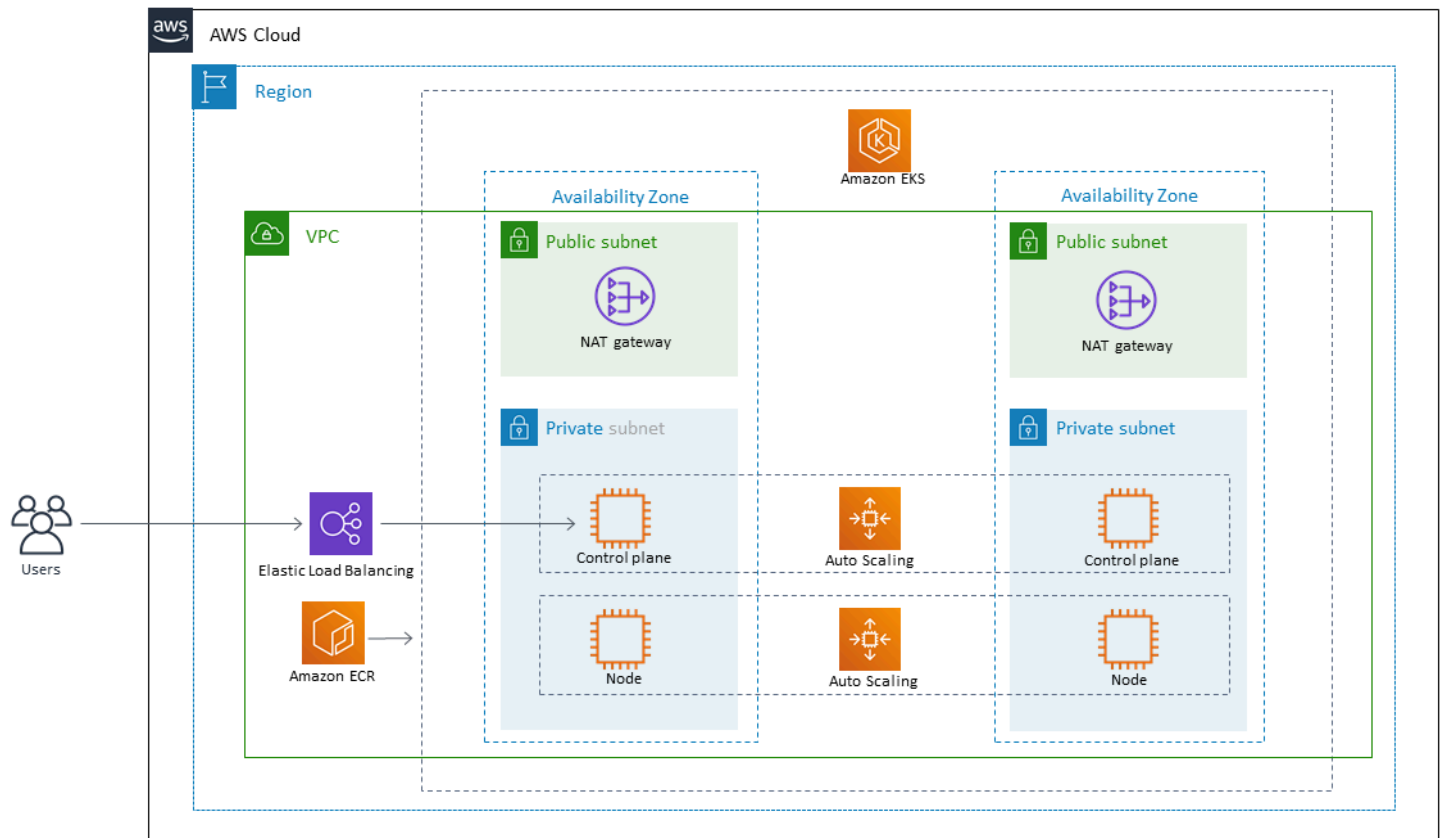

## Tools

- [Amazon Elastic Container Registry \(Amazon ECR\)](#) is a managed container image registry service that's secure, scalable, and reliable.
- [Amazon Elastic Kubernetes Service \(Amazon EKS\)](#) helps you run Kubernetes on AWS without needing to install or maintain your own Kubernetes control plane or nodes.
- [AWS Command Line Interface \(AWS CLI\)](#) is an open-source tool that helps you interact with AWS services through commands in your command-line shell.
- [Elastic Load Balancing](#) automatically distributes your incoming traffic across multiple targets, such as Amazon Elastic Compute Cloud (Amazon EC2) instances, containers, and IP addresses, in one or more Availability Zones.
- [eksctl](#) helps you create clusters on Amazon EKS.
- [kubect](#) makes it possible to run commands against Kubernetes clusters.
- [Docker](#) helps you build, test, and deliver applications in packages called containers.

## Epics

### Create an Amazon EKS cluster by using eksctl

Task	Description	Skills required
Create an Amazon EKS cluster.	<p>To create an Amazon EKS cluster that uses two t2.small Amazon EC2 instances as nodes, run the following command:</p> <pre>eksctl create cluster --name &lt;your-cluster-name&gt; --version &lt;version-number&gt; --nodes=1 --node-type=t2.small</pre> <p><b>Note:</b> The process can take between 15 to 20 minutes. After the cluster is created,</p>	Developer, System Admin

Task	Description	Skills required
	the appropriate Kubernetes configuration is added to your <a href="#">kubeconfig</a> file. You can use the kubeconfig file with <code>kubectl</code> to deploy the application in later steps.	
Verify the Amazon EKS cluster.	To verify that the cluster is created and that you can connect to it, run the <code>kubectl get nodes</code> command.	Developer, System Admin

### Create an Amazon ECR repository and push the Docker image.

Task	Description	Skills required
Create an Amazon ECR repository.	Follow the instructions from <a href="#">Creating a private repository</a> in the Amazon ECR documentation.	Developer, System Admin
Create a POM XML file.	Create a <code>pom.xml</code> file based on the <i>Example POM file</i> code in the <a href="#">Additional information</a> section of this pattern.	Developer, System Admin
Create a source file.	Create a source file called <code>HelloWorld.java</code> in the <code>src/main/java/eksExample</code> path based on the following example: <div style="border: 1px solid #ccc; border-radius: 10px; padding: 10px; margin-top: 10px;"> <pre>package eksExample; import static spark.Spark.get;</pre> </div>	

Task	Description	Skills required
	<pre data-bbox="609 247 1015 703">public class HelloWorld {     public static void     main(String[] args) {         get("/", (req,         res) -&gt; {             return             "Hello World!";         });     } }</pre> <p data-bbox="592 741 998 825">Be sure to use the following directory structure:</p> <pre data-bbox="609 867 1015 1375">### Dockerfile ### deployment.yaml ### ingress.yaml ### pom.xml ### service.yaml ### src     ### main         ### java             ### eksExample                 ### HelloWorld.java</pre>	
Create a Dockerfile.	Create a Dockerfile based on the <i>Example Dockerfile</i> code in the <a href="#">Additional information</a> section of this pattern.	Developer, System Admin

Task	Description	Skills required
Build and push the Docker image.	<p>In the directory where you want your Dockerfile to build, tag, and push the image to Amazon ECR, run the following commands:</p> <pre data-bbox="594 489 1027 1365">aws ecr get-login --password --region &lt;region&gt;  docker login --username &lt;username &gt; --password-stdin &lt;account_number&gt;.d kr.ecr.&lt;region&gt;.am azonaws.com docker buildx build -- platform linux/amd64 -t hello-world-java:v 1 . docker tag hello-wor ld-java:v1 &lt;account_ number&gt;.dkr.ecr.&lt;r egion&gt;.amazonaws.com/ &lt;repository_name&gt;:v1 docker push &lt;account_ number&gt;.dkr.ecr.&lt;r egion&gt;.amazonaws.com/ &lt;repository_name&gt;:v1</pre> <p><b>Note:</b> Modify the AWS Region, account number, and repository details in the preceding commands. Be sure to note the image URL for later use.</p> <p><b>Important:</b> A macOS system with an M1 chip has a problem building an image</p>	

Task	Description	Skills required
	that's compatible with Amazon EKS running on an AMD64 platform. To resolve this issue, use <a href="#">docker buildx</a> to build a Docker image that works on Amazon EKS.	

## Deploy the Java microservices

Task	Description	Skills required
Create a deployment file.	<p>Create a YAML file called <code>deployment.yaml</code> based on the <i>Example deployment file</i> code in the <a href="#">Additional information</a> section of this pattern.</p> <p><b>Note:</b> Use the image URL that you copied earlier as the path of the image file for the Amazon ECR repository.</p>	Developer, System Admin
Deploy the Java microservices on the Amazon EKS cluster.	To create a deployment in your Amazon EKS cluster, run the <code>kubectl apply -f deployment.yaml</code> command.	Developer, System Admin
Verify the status of the pods.	<ol style="list-style-type: none"> <li>To verify the status of the pods, run the <code>kubectl get pods</code> command.</li> <li>Wait for the status to change to <b>Ready</b>.</li> </ol>	Developer, System Admin

Task	Description	Skills required
Create a service.	<ol style="list-style-type: none"> <li>1. Create a file called <code>service.yaml</code> based on the <i>Example service file</i> code in the <a href="#">Additional information</a> section of this pattern.</li> <li>2. Run the <code>kubectl apply -f service.yaml</code> command.</li> </ol>	Developer, System Admin
Install the AWS Load Balancer Controller add-on.	<p>Follow the instructions from <a href="#">Installing the AWS Load Balancer Controller add-on</a> in the Amazon EKS documentation.</p> <p><b>Note:</b> You must have the add-on installed to create an Application Load Balancer or Network Load Balancer for a Kubernetes service.</p>	Developer, System Admin
Create an ingress resource.	Create a YAML file called <code>ingress.yaml</code> based on the <i>Example ingress resource file</i> code in the <a href="#">Additional information</a> section of this pattern.	Developer, System Admin
Create an Application Load Balancer.	To deploy the ingress resource and create an Application Load Balancer, run the <code>kubectl apply -f ingress.yaml</code> command.	Developer, System Admin

## Test the application

Task	Description	Skills required
Test and verify the application.	<ol style="list-style-type: none"> <li>To get the load balancer's DNS name from the ADDRESS field, run the <code>kubectl get ingress.networking.k8s.io/java-microservice-ingress</code> command.</li> <li>On an EC2 instance in the same VPC as your Amazon EKS nodes, run the <code>curl -v &lt;DNS address from previous command&gt;</code> command.</li> </ol>	Developer, System Admin

## Related resources

- [Creating a private repository](#) (Amazon ECR documentation)
- [Pushing a Docker image](#) (Amazon ECR documentation)
- [Ingress Controllers](#) (Amazon EKS Workshop)
- [Docker buildx](#) (Docker docs)

## Additional information

### Example POM file

```
<?xml version="1.0" encoding="UTF-8"?>
<project xmlns="http://maven.apache.org/POM/4.0.0" xmlns:xsi="http://www.w3.org/2001/
XMLSchema-instance"
  xsi:schemaLocation="http://maven.apache.org/POM/4.0.0 http://maven.apache.org/xsd/
maven-4.0.0.xsd">
  <modelVersion>4.0.0</modelVersion>
```



```
<groupId>helloWorld</groupId>
<artifactId>helloWorld</artifactId>
<version>1.0-SNAPSHOT</version>

<dependencies>
  <dependency>
    <groupId>com.sparkjava</groupId><artifactId>spark-core</
artifactId><version>2.0.0</version>
  </dependency>
</dependencies>
<build>
  <plugins>
    <plugin>
      <groupId>org.apache.maven.plugins</groupId><artifactId>maven-jar-plugin</
artifactId><version>2.4</version>
      <configuration><finalName>eksExample</finalName><archive><manifest>
        <addClasspath>true</addClasspath><mainClass>eksExample.HelloWorld</
mainClass><classpathPrefix>dependency-jars</classpathPrefix>
        </manifest></archive>
      </configuration>
    </plugin>
    <plugin>
      <groupId>org.apache.maven.plugins</groupId><artifactId>maven-compiler-plugin</
artifactId><version>3.1</version>
      <configuration><source>1.8</source><target>1.8</target></configuration>
    </plugin>
    <plugin>
      <groupId>org.apache.maven.plugins</groupId><artifactId>maven-assembly-plugin</
artifactId>
      <executions>
        <execution>
          <goals><goal>attached</goal></goals><phase>package</phase>
          <configuration>
            <finalName>eksExample</finalName>
            <descriptorRefs><descriptorRef>jar-with-dependencies</descriptorRef></
descriptorRefs>
            <archive><manifest><mainClass>eksExample.HelloWorld</mainClass></
manifest></archive>
          </configuration>
        </execution>
      </executions>
    </plugin>
  </plugins>
</build>
</artifactId>
</version>
</parent>
</project>
```

```
    </plugin>
  </plugins>
</build>
</project>
```

## Example Dockerfile

```
FROM bellsoft/liberica-openjdk-alpine-musl:17

RUN apk add maven
WORKDIR /code

# Prepare by downloading dependencies
ADD pom.xml /code/pom.xml
RUN ["mvn", "dependency:resolve"]
RUN ["mvn", "verify"]

# Adding source, compile and package into a fat jar
ADD src /code/src
RUN ["mvn", "package"]

EXPOSE 4567
CMD ["java", "-jar", "target/eksExample-jar-with-dependencies.jar"]
```

## Example deployment file

```
apiVersion: apps/v1
kind: Deployment
metadata:
  name: microservice-deployment
spec:
  replicas: 2
  selector:
    matchLabels:
      app.kubernetes.io/name: java-microservice
  template:
    metadata:
      labels:
        app.kubernetes.io/name: java-microservice
    spec:
      containers:
        - name: java-microservice-container
          image: .dkr.ecr.amazonaws.com/:
```

```
ports:
  - containerPort: 4567
```

## Example service file

```
apiVersion: v1
kind: Service
metadata:
  name: "service-java-microservice"
spec:
  ports:
    - port: 80
      targetPort: 4567
      protocol: TCP
  type: NodePort
selector:
  app.kubernetes.io/name: java-microservice
```

## Example ingress resource file

```
apiVersion: networking.k8s.io/v1
kind: Ingress
metadata:
  name: "java-microservice-ingress"
  annotations:
    kubernetes.io/ingress.class: alb
    alb.ingress.kubernetes.io/load-balancer-name: apg2
    alb.ingress.kubernetes.io/target-type: ip
  labels:
    app: java-microservice
spec:
  rules:
    - http:
        paths:
          - path: /
            pathType: Prefix
            backend:
              service:
                name: "service-java-microservice"
                port:
                  number: 80
```

# Deploy a clustered application to Amazon ECS by using AWS Copilot

Created by Jean-Baptiste Guillois (AWS), Mathew George (AWS), and Thomas Scott (AWS)

**Code repository:** [Clustered Sample Application demo](#)

**Environment:** Production

**Technologies:** Containers & microservices; Business productivity; CloudNative; DevelopmentAndTesting

**AWS services:** Amazon ECS; AWS Fargate; Amazon ECR

## Summary

This pattern shows how to deploy containers in an Amazon Elastic Container Service (Amazon ECS) cluster in two ways—by using the Amazon Web Services (AWS) Management Console, and by using AWS Copilot—to demonstrate how AWS Copilot simplifies deployment tasks.

Amazon ECS is a highly scalable, fast container management service that makes it easy to run, stop, and manage containers on a cluster. Your containers are defined in a task definition that you use to run individual tasks or tasks within a service. You can run your tasks and services on a serverless infrastructure that is managed by AWS Fargate. Alternatively, for more control over your infrastructure, you can run your tasks and services on a cluster of Amazon Elastic Compute Cloud (Amazon EC2) instances that you manage.

The AWS Copilot command line interface (CLI) commands simplify building, releasing, and operating production-ready containerized applications on Amazon ECS from a local development environment. The AWS Copilot CLI aligns with developer workflows that support modern application best practices: from using infrastructure as code to creating a continuous integration and continuous delivery (CI/CD) pipeline provisioned on behalf of a user. You can use the AWS Copilot CLI as part of your everyday development and testing cycle as an alternative to the AWS Management Console.

## Prerequisites and limitations

### Prerequisites

- An active AWS account
- AWS Command Line Interface (AWS CLI) locally installed and configured to use your AWS account (see the [installation instructions](#) and the [configuration instructions](#) in the AWS CLI documentation)
- AWS Copilot locally installed (see the [installation instructions](#) in the Amazon ECS documentation)
- Docker installed on your local machine (see the [Docker documentation](#))

## Limitations

- Docker enforces pull limits of 100 container images per 6 hours per IP address on the free plan.

## Architecture

### Target technology stack

- AWS environment set up with a virtual private cloud (VPC), public and private subnets, and security groups
- Amazon ECS cluster
- Amazon ECS service and task definition
- Amazon Elastic Container Registry (Amazon ECR)
- Amazon DynamoDB
- Application Load Balancer
- AWS Fargate
- Amazon Identity and Access Management (IAM)
- Amazon CloudWatch
- AWS CloudTrail

### Target architecture

When you deploy the sample application for this pattern, multiple tasks are created and deployed in separate Availability Zones. Each task stores data in Amazon DynamoDB. When you access the webpage for a task, you can view the data from all other tasks.

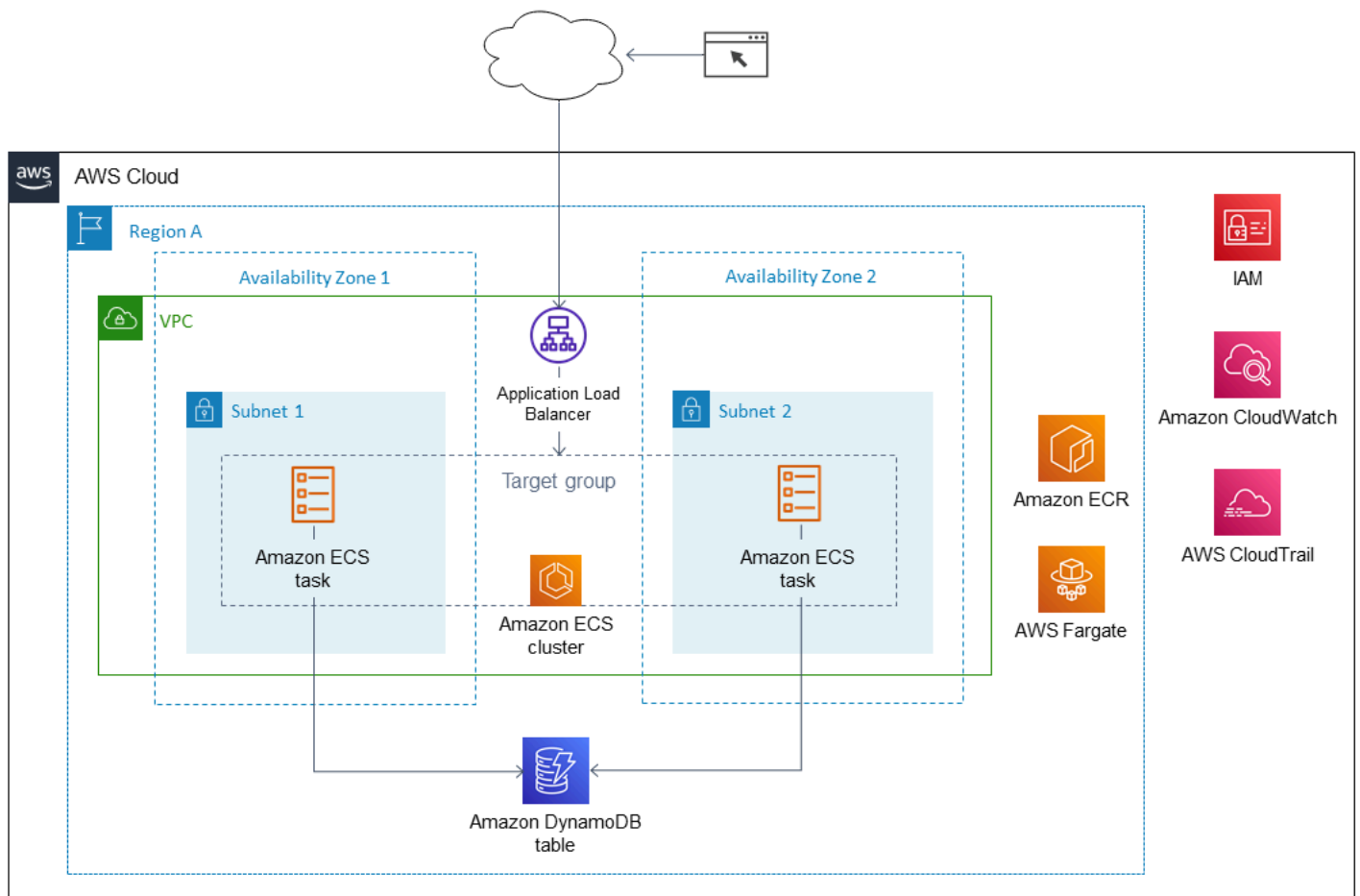

## Tools

### AWS services

- [Amazon ECR](#) – Amazon Elastic Container Registry (Amazon ECR) is an AWS managed container image registry service that is secure, scalable, and reliable. Amazon ECR supports private repositories with resource-based permissions using IAM.
- [Amazon ECS](#) – Amazon Elastic Container Service (Amazon ECS) is a highly scalable, fast container management service for running, stopping, and managing containers on a cluster. You can run your tasks and services on a serverless infrastructure that is managed by AWS Fargate. Alternatively, for more control over your infrastructure, you can run your tasks and services on a cluster of Amazon Elastic Compute Cloud (Amazon EC2) instances that you manage.
- [AWS Copilot](#) – AWS Copilot provides a command line interface that helps you launch and manage containerized applications on AWS, including pushing to a registry, creating a task definition, and creating a cluster.

- [AWS Fargate](#) – AWS Fargate is a serverless, pay-as-you-go compute engine that lets you focus on building applications without managing servers. AWS Fargate is compatible with both Amazon ECS and Amazon Elastic Kubernetes Service (Amazon EKS). When you run your Amazon ECS tasks and services with the Fargate launch type or a Fargate capacity provider, you package your application in containers, specify the CPU and memory requirements, define networking and IAM policies, and launch the application. Each Fargate task has its own isolation boundary and doesn't share the underlying kernel, CPU resources, memory resources, or elastic network interface with another task.
- [Amazon DynamoDB](#) – Amazon DynamoDB is a fully managed NoSQL database service that provides fast and predictable performance with seamless scalability.
- [Elastic Load Balancing \(ELB\)](#) – Elastic Load Balancing automatically distributes your incoming traffic across multiple targets, such as EC2 instances, containers, and IP addresses, in one or more Availability Zones. It monitors the health of its registered targets, and routes traffic only to the healthy targets. Elastic Load Balancing scales your load balancer as your incoming traffic changes over time. It can automatically scale to the vast majority of workloads.

## Tools

- [Docker Command Line Interface](#)
- [AWS Command Line Interface \(AWS CLI\)](#)
- [AWS Copilot command line interface](#)

## Code

The code for the sample application used in this pattern is available on GitHub, in the [Cluster Sample Application](#) repository. Follow the instructions in the next section to use the sample files.

## Epics

### Deploy the application stack - option 1 (AWS Management Console)

Task	Description	Skills required
Clone the GitHub repository.	Clone the sample code repository by using the command:	App developer, AWS DevOps

Task	Description	Skills required
	<pre>git clone https://github.com/aws-samples/cluster-sample-app cluster-sample-app &amp;&amp; cd cluster-sample-app</pre>	
Create your Amazon ECR repository.	<ol style="list-style-type: none"><li>1. Sign in to the AWS Management Console and open the Amazon ECR console at <a href="https://console.aws.amazon.com/ecr/repositories">https://console.aws.amazon.com/ecr/repositories</a>.</li><li>2. Choose <b>Create repository</b>.</li><li>3. For the repository name, enter <b>cluster-sample-app</b>.</li><li>4. For all other settings, keep the default values.</li><li>5. Choose <b>Create repository</b>.</li></ol> <p>For more information, see <a href="#">Creating a private repository</a> in the Amazon ECR documentation.</p>	App developer, AWS DevOps



Task	Description	Skills required
Build, tag, and push your Docker image to your Amazon ECR repository.	<ol style="list-style-type: none"><li>1. Select the repository you just created and choose <b>View push commands</b>.</li><li>2. Copy the commands that are displayed and run them locally to build, tag, and push your docker image. These commands will be similar to the following.</li></ol> <p>To authenticate your Docker client to the registry:</p> <pre>aws ecr get-login -password --region &lt;YOUR_AWS_REGION&gt;   docker login --username AWS --password-stdin &lt;YOUR_AWS_ACCOUNT&gt; .dkr.ecr.&lt;YOUR_AWS _REGION&gt;.amazonaws .com</pre> <p>To build your Docker image:</p> <pre>docker build -t cluster- sample-app .</pre> <p>To tag your Docker image:</p> <pre>docker tag cluster- sample-app:latest &lt;YOUR_AWS_ACCOUNT&gt; .dkr.ecr.&lt;YOUR_AWS _REGION&gt;.amazonaws</pre>	App developer, AWS DevOps

Task	Description	Skills required
	<pre>.com/cluster-sample- app:latest</pre> <p>To push the Docker image to your repository:</p> <pre>docker push &lt;YOUR_AWS _ACCOUNT&gt;.dkr.ecr. &lt;YOUR_AWS_REGION&gt;. amazonaws.com/clus ter-sample-app:latest</pre>	

Task	Description	Skills required
Deploy the application stack.	<ol style="list-style-type: none"><li>1. Open the AWS CloudFormation console at <a href="https://console.aws.amazon.com/cloudformation/">https://console.aws.amazon.com/cloudformation/</a>.</li><li>2. Choose <b>Create stack</b>.</li><li>3. In the <b>Prepare template</b> section, choose <b>Template is ready</b>.</li><li>4. In the <b>Specify template</b> section, choose <b>Upload a template file</b>.</li><li>5. Choose the local file <code>cluster-sample-app-stack.yml</code> that you cloned from the GitHub repository as the CloudFormation template, and then choose <b>Next</b>.</li><li>6. Enter a name for your stack, and then choose <b>Next</b>.</li><li>7. Keep all default options, and then choose <b>Next</b>.</li><li>8. Review all options, acknowledge the creation of IAM resources, and then choose <b>Create stack</b>.</li><li>9. When your application stack has been deployed, choose the <b>Output</b> tab, copy the URL, and open it in your browser to access the application.</li></ol>	AWS DevOps, App developer

Task	Description	Skills required
	For more information about deploying CloudFormation templates, see <a href="#">Creating a stack</a> in the AWS CloudFormation documentation.	

## Deploy the application stack – option 2 (AWS Copilot CLI)

Task	Description	Skills required
Clone the GitHub repository.	Clone the sample code repository by using the command: <pre data-bbox="594 898 1029 1178">git clone https://github.com/aws-samples/cluster-sample-app cluster-sample-app           &amp;&amp; cd cluster-sample-app</pre>	App developer, AWS DevOps
Deploy your container image to AWS by using the AWS Copilot CLI.	Deploy the application in one step by using the following command in the root directory of your project: <pre data-bbox="594 1434 1029 1749">copilot init --app cluster-sample-app --name demo --type "Load Balanced Web Service" --dockerfile ./Dockerfile --port 8080 --deploy</pre> <p data-bbox="594 1787 1029 1873">You should then be able to access the application by</p>	App developer, AWS DevOps

Task	Description	Skills required
	using the DNS name provided as output.	

## Delete the created resources

Task	Description	Skills required
Delete the resources created through the AWS Management Console.	<p>If you used option 1 (the AWS Management Console) to deploy the application stack, follow these steps when you're ready to delete the resources you created:</p> <ol style="list-style-type: none"> <li>1. Open the CloudFormation console at <a href="https://console.aws.amazon.com/cloudformation/">https://console.aws.amazon.com/cloudformation/</a>.</li> <li>2. Select the stack you created, and then choose <b>Delete</b>.</li> <li>3. Open the Amazon ECR console at <a href="https://console.aws.amazon.com/ecr/repositories">https://console.aws.amazon.com/ecr/repositories</a>.</li> <li>4. Select the repository you created, and then choose <b>Delete</b>.</li> </ol>	App developer, AWS DevOps
Delete the resources created by AWS Copilot.	If you used option 2 (the AWS Copilot CLI) to deploy the application stack, run the following command from the root directory of your project	App developer, AWS DevOps

Task	Description	Skills required
	when you're ready to delete the resources you created:  <code>copilot app delete</code>	

## Related resources

- [Installing or updating the latest version of the AWS CLI](#) (AWS CLI documentation)
- [Using the AWS Copilot command line interface](#) (Amazon ECS documentation)
- [Amazon ECS on AWS Fargate](#) (Amazon ECR documentation)
- [Amazon ECS documentation](#)
- [Amazon ECR documentation](#)
- [Amazon CloudFormation documentation](#)
- [Docker Desktop](#) (Docker documentation)

# Deploy a gRPC-based application on an Amazon EKS cluster and access it with an Application Load Balancer

Created by Kirankumar Chandrashekar (AWS) and Huy Nguyen (AWS)

**Code repository:** [grpc-traffic-on-alb-to-eks](#)

**Environment:** PoC or pilot

**Technologies:** Containers & microservices; Content delivery; Web & mobile apps

**Workload:** All other workloads

**AWS services:** Amazon EKS; Elastic Load Balancing (ELB)

## Summary

This pattern describes how to host a gRPC-based application on an Amazon Elastic Kubernetes Service (Amazon EKS) cluster and securely access it through an Application Load Balancer.

[gRPC](#) is an open-source remote procedure call (RPC) framework that can run in any environment. You can use it for microservice integrations and client-server communications. For more information about gRPC, see the AWS blog post [Application Load Balancer support for end-to-end HTTP/2 and gRPC](#).

This pattern shows you how to host a gRPC-based application that runs on Kubernetes pods on Amazon EKS. The gRPC client connects to an Application Load Balancer through the HTTP/2 protocol with an SSL/TLS encrypted connection. The Application Load Balancer forwards traffic to the gRPC application that runs on Amazon EKS pods. The number of gRPC pods can be automatically scaled based on traffic by using the [Kubernetes Horizontal Pod Autoscaler](#). The Application Load Balancer's target group performs health checks on the Amazon EKS nodes, evaluates if the target is healthy, and forwards traffic only to healthy nodes.

## Prerequisites and limitations

### Prerequisites

- An active AWS account.
- [Docker](#), installed and configured on Linux, macOS, or Windows.

- [AWS Command Line Interface \(AWS CLI\) version 2](#), installed and configured on Linux, macOS, or Windows.
- [eksctl](#), installed and configured on Linux, macOS, or Windows.
- `kubectl`, installed and configured to access resources on your Amazon EKS cluster. For more information, see [Installing or updating kubectl](#) in the Amazon EKS documentation.
- [gRPCurl](#), installed and configured.
- A new or existing Amazon EKS cluster. For more information, see [Getting started with Amazon EKS](#).
- Your computer terminal configured to access the Amazon EKS cluster. For more information, see [Configure your computer to communicate with your cluster](#) in the Amazon EKS documentation.
- [AWS Load Balancer Controller](#), provisioned in the Amazon EKS cluster.
- An existing DNS host name with a valid SSL or SSL/TLS certificate. You can obtain a certificate for your domain by using AWS Certificate Manager (ACM) or uploading an existing certificate to ACM. For more information about these two options, see [Requesting a public certificate](#) and [Importing certificates into AWS Certificate Manager](#) in the ACM documentation.

## Architecture

The following diagram shows the architecture implemented by this pattern.



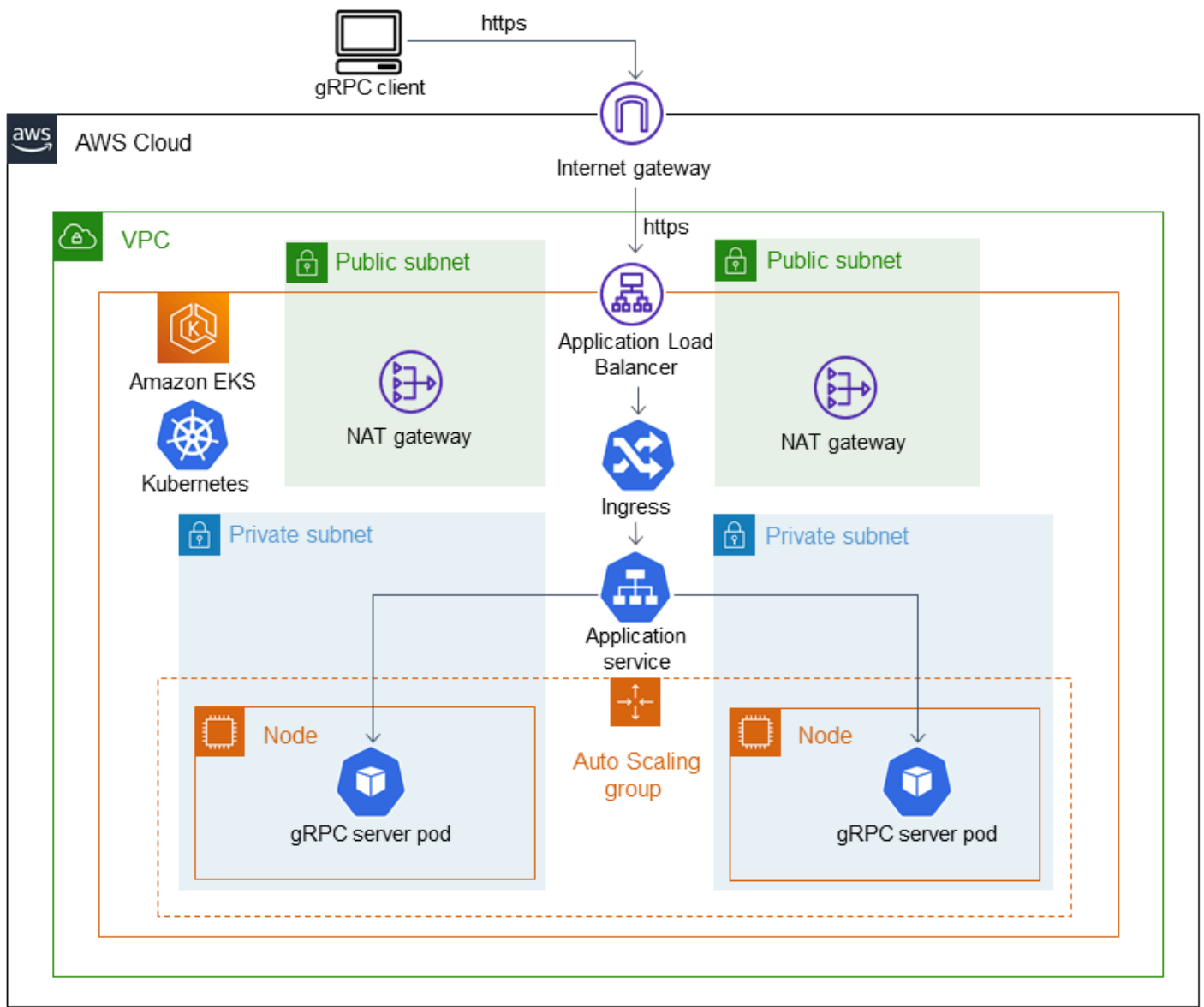

The following diagram shows a workflow where SSL/TLS traffic is received from a gRPC client that offloads to an Application Load Balancer. Traffic is forwarded in plaintext to the gRPC server because it comes from a virtual private cloud (VPC).

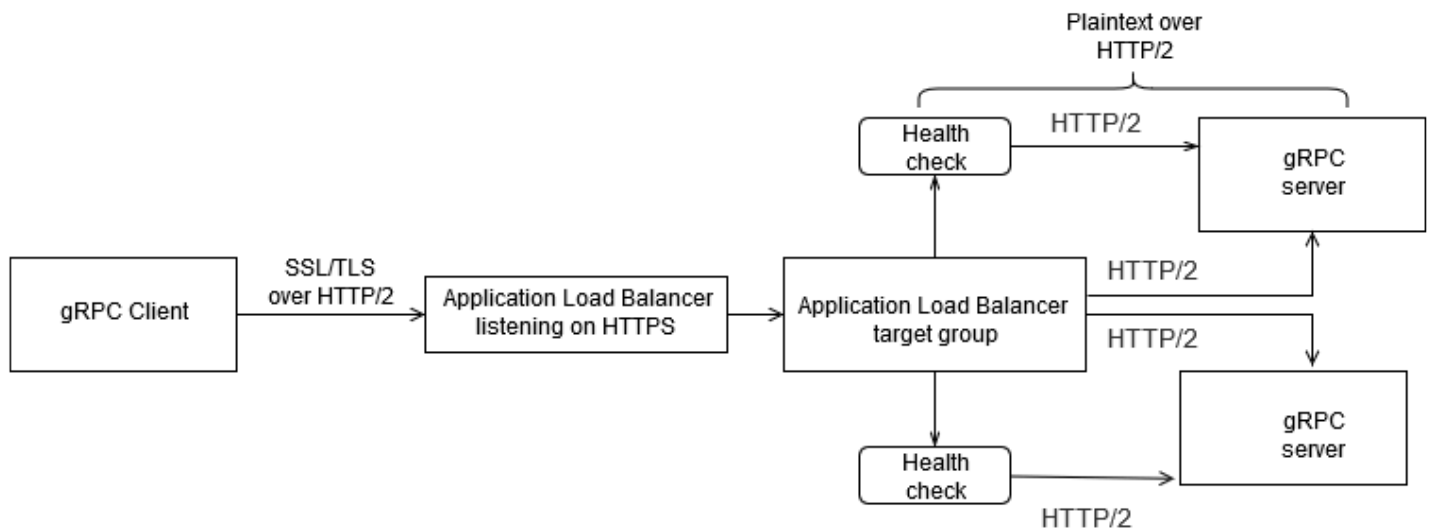

## Tools

### AWS services

- [AWS Command Line Interface \(AWS CLI\)](#) is an open-source tool that helps you interact with AWS services through commands in your command line shell.
- [Elastic Load Balancing](#) distributes incoming application or network traffic across multiple targets. For example, you can distribute traffic across Amazon Elastic Compute Cloud (Amazon EC2) instances, containers, and IP addresses in one or more Availability Zones.
- [Amazon Elastic Container Registry \(Amazon ECR\)](#) is a managed container image registry service that's secure, scalable, and reliable.
- [Amazon Elastic Kubernetes Service \(Amazon EKS\)](#) helps you run Kubernetes on AWS without needing to install or maintain your own Kubernetes control plane or nodes.

### Tools

- [eksctl](#) is a simple CLI tool for creating clusters on Amazon EKS.
- [kubectx](#) is a command line utility for running commands against Kubernetes clusters.
- [AWS Load Balancer Controller](#) helps you manage AWS Elastic Load Balancers for a Kubernetes cluster.
- [gRPCurl](#) is a command line tool that helps you interact with gRPC services.

## Code repository

The code for this pattern is available in the GitHub [grpc-traffic-on-alb-to-eks](#) repository.

## Epics

### Build and push the gRPC server's Docker image to Amazon ECR

Task	Description	Skills required
Create an Amazon ECR repository.	<p>Sign in to the AWS Management Console, open the <a href="#">Amazon ECR console</a>, and then create an Amazon ECR repository. For more information, see <a href="#">Creating a repository</a> in the Amazon ECR documentation. Make sure that you record the Amazon ECR repository's URL.</p> <p>You can also create an Amazon ECR repository with AWS CLI by running the following command:</p> <pre>aws ecr create-repository --repository-name helloworld-grpc</pre>	Cloud administrator
Build the Docker image.	<p>1. Clone the GitHub <a href="#">grpc-traffic-on-alb-to-eks</a> repository.</p> <pre>git clone https://github.com/aws-samples/grpc-traffic-on-alb-to-eks.git</pre>	DevOps engineer

Task	Description	Skills required
	<p>2. From the root directory of the repository, make sure that the Dockerfile exists and then run the following command to build the Docker image:</p> <pre data-bbox="634 520 1029 680">docker build -t &lt;amazon_ecr_reposi tory_url&gt;:&lt;Tag&gt; .</pre> <p><b>Important:</b> Make sure that you replace <code>&lt;amazon_ecr_repository_url&gt;</code> with the URL of the Amazon ECR repository that you created earlier.</p>	

Task	Description	Skills required
<p>Push the Docker image to Amazon ECR.</p>	<ol style="list-style-type: none"> <li>Run the following command to log in to the Amazon ECR repository:           <pre data-bbox="634 394 1029 793">aws ecr get-login           -password --region             us-east-1 --no-cli-             auto-prompt   docker             login --username AWS             --password-stdin             &lt;your_aws_account_             id&gt;.dkr.ecr.us-eas             t-1.amazonaws.com</pre> </li> <li>Push the Docker image to the Amazon ECR repository by running the following command:           <pre data-bbox="634 1024 1029 1262">docker push &lt;your_aws             _account_id&gt;.dkr.e             cr.us-east-1.amazo             naws.com/helloworl             d-grpc:1.0</pre> <p><b>Important:</b> Make sure that you replace <code>&lt;your_aws_account_id&gt;</code> with your AWS account ID.</p> </li> </ol>	<p>DevOps engineer</p>

## Deploy the Kubernetes manifests to the Amazon EKS cluster

Task	Description	Skills required
<p>Modify the values in the Kubernetes manifest file.</p>	<ol style="list-style-type: none"> <li>Modify the <code>grpc-sample.yaml</code> Kubernetes</li> </ol>	<p>DevOps engineer</p>

Task	Description	Skills required
	<p>s manifest file in the Kubernetes folder of the repository according to your requirements. You must modify the annotations and host name in the ingress resource. For a sample ingress resource, see the <a href="#">Additional information</a> section. For more information about ingress annotations, see <a href="#">Ingress annotations</a> in the Kubernetes documentation.</p> <p>2. In the Kubernetes deployment resource, change the deployment resource's image to the uniform resource identifier (URI) for the Amazon ECR repository that you pushed the Docker image to. For a sample deployment resource, see the <a href="#">Additional information</a> section.</p>	

Task	Description	Skills required
Deploy the Kubernetes manifest file.	<p>Deploy the <code>grpc-sample.yaml</code> file to the Amazon EKS cluster by running the following <code>kubectl</code> command:</p> <pre>kubectl apply -f ./kubernetes/grpc-sample.yaml</pre>	DevOps engineer

## Create the DNS record for the Application Load Balancer's FQDN

Task	Description	Skills required
Record the FQDN for the Application Load Balancer.	<ol style="list-style-type: none"> <li>Run the following <code>kubectl</code> command to describe the Kubernetes ingress resource that manages the Application Load Balancer: <pre>kubectl get ingress -n grpcserver</pre> <p>Sample output is provided in the <a href="#">Additional information</a> section. In the output, the <code>HOSTS</code> field displays the DNS host name that the SSL certificates were created for.</p> </li> <li>Record the Application Load Balancer's fully qualified domain name</li> </ol>	DevOps engineer

Task	Description	Skills required
	<p>(FQDN) from the Address field of the output.</p> <p>3. Create a DNS record that points to the Application Load Balancer's FQDN. If your DNS provider is Amazon Route 53, you can create an alias record that points to the Application Load Balancer's FQDN. For more information about this option, see <a href="#">Choosing between alias and non-alias records</a> in the Route 53 documentation.</p>	

## Test the solution

Task	Description	Skills required
Test the gRPC server.	<p>Use gRPCurl to test the endpoint by running the following command:</p> <pre data-bbox="594 1383 1029 1667">grpcurl grpc.example.com:443 list grpc.reflection.v1alpha.ServerReflection helloworld.helloworld</pre> <p><b>Note:</b> Replace <code>grpc.example.com</code> with your DNS name.</p>	DevOps engineer



Task	Description	Skills required
Test the gRPC server using a gRPC client.	<p>In the <code>helloworld_client_ssl.py</code> sample gRPC client, replace the host name from <code>grpc.example.com</code> with the host name used for the gRPC server.</p> <p>The following code sample shows the response from the gRPC server for the client's request:</p> <pre data-bbox="594 810 1027 1367">python ./app/helloworld_client_ssl.py message: "Hello to gRPC server from Client"  message: "Thanks for talking to gRPC server!! Welcome to hello world. Received message is \"Hello to gRPC server from Client\"" received: true</pre> <p>This shows that the client can talk to the server and that the connection is successful.</p>	DevOps engineer

## Clean up

Task	Description	Skills required
Remove the DNS record.	Remove the DNS record that points to the Application Load Balancer's FQDN that you created earlier.	Cloud administrator
Remove the load balancer.	On the <a href="#">Amazon EC2 console</a> , choose <b>Load Balancers</b> , and then remove the load balancer that the Kubernetes controller created for your ingress resource.	Cloud administrator
Delete the Amazon EKS cluster.	Delete the Amazon EKS cluster by using <code>eksctl</code> :  <pre>eksctl delete cluster -f ./eks.yaml</pre>	AWS DevOps

## Related resources

- [Network load balancing on Amazon EKS](#)
- [Target groups for your Application Load Balancers](#)

## Additional information

### Sample ingress resource:

```
---
apiVersion: networking.k8s.io/v1
kind: Ingress
metadata:
  annotations:
    alb.ingress.kubernetes.io/healthcheck-protocol: HTTP
```

```

alb.ingress.kubernetes.io/ssl-redirect: "443"
alb.ingress.kubernetes.io/backend-protocol-version: "GRPC"
alb.ingress.kubernetes.io/listen-ports: '[{"HTTP": 80}, {"HTTPS":443}]'
alb.ingress.kubernetes.io/scheme: internet-facing
alb.ingress.kubernetes.io/target-type: ip
alb.ingress.kubernetes.io/certificate-arn: arn:aws:acm:<AWS-
Region>:<AccountId>:certificate/<certificate_ID>
alb.ingress.kubernetes.io/healthcheck-protocol: HTTP
labels:
  app: grpcserver
  environment: dev
name: grpcserver
namespace: grpcserver
spec:
  ingressClassName: alb
  rules:
  - host: grpc.example.com # <----- replace this as per your host name for which the
    SSL certttficate is available in ACM
    http:
      paths:
      - backend:
          service:
            name: grpcserver
            port:
              number: 9000
          path: /
          pathType: Prefix

```

### Sample deployment resource:

```

apiVersion: apps/v1
kind: Deployment
metadata:
  name: grpcserver
  namespace: grpcserver
spec:
  selector:
    matchLabels:
      app: grpcserver
  replicas: 1
  template:
    metadata:
      labels:

```

```
    app: grpcserver
spec:
  containers:
  - name: grpc-demo
    image: <your_aws_account_id>.dkr.ecr.us-east-1.amazonaws.com/helloworld-
grpc:1.0 #<----- Change to the URI that the Docker image is pushed to
    imagePullPolicy: Always
    ports:
    - name: grpc-api
      containerPort: 9000
    env:
    - name: POD_IP
      valueFrom:
        fieldRef:
          fieldPath: status.podIP
    restartPolicy: Always
```

### Sample output:

NAME	CLASS	HOSTS	Address
PORTS	AGE		
grpcserver	<none>	<DNS-HostName>	<ELB-address>
80	27d		

# Deploy and debug Amazon EKS clusters

Created by Svenja Raether (AWS) and Mathew George (AWS)

**Environment:** PoC or pilot

**Technologies:** Containers & microservices; Infrastructure; Modernization; Serverless; CloudNative

**Workload:** All other workloads

**AWS services:** Amazon EKS; AWS Fargate

## Summary

Containers are becoming an essential part of cloud native application development. Kubernetes provides an efficient way to manage and orchestrate containers. [Amazon Elastic Kubernetes Service \(Amazon EKS\)](#) is a fully-managed, certified [Kubernetes](#) conformant service for building, securing, operating, and maintaining Kubernetes clusters on Amazon Web Services (AWS). It supports running pods on AWS Fargate to provide on-demand, right-sized compute capacity.

It's important for developers and administrators to know debugging options when running containerized workloads. This pattern walks you through deploying and debugging containers on Amazon EKS with [AWS Fargate](#). It includes creating, deploying, accessing, debugging, and cleaning up the Amazon EKS workloads.

## Prerequisites and limitations

### Prerequisites

- An active [AWS account](#)
- [AWS Identity and Access Management \(IAM\)](#) role configured with sufficient permissions to create and interact with Amazon EKS, IAM roles, and service linked roles
- [AWS Command Line Interface \(AWS CLI\)](#) installed on the local machine
- [eksctl](#)
- [kubectrl](#)
- [Helm](#)

## Limitations

- This pattern provides developers with useful debugging practices for development environments. It does not state best practices for production environments.
- If you are running Windows, use your operating system–specific commands for setting the environment variables.

## Product versions used

- [AWS CLI version 2](#)
- [kubect1 version](#) within one minor version difference of the Amazon EKS control plane that you're using
- [eksctl](#) latest version
- [Helm v3](#)

## Architecture

### Technology stack

- Application Load Balancer
- Amazon EKS
- AWS Fargate

### Target architecture

All resources shown in the diagram are provisioned by using `eksctl` and `kubect1` commands issued from a local machine. Private clusters must be run from an instance that is inside the private VPC.

The target architecture consists of an EKS cluster using the Fargate launch type. This provides on-demand, right-sized compute capacity without the need to specify server types. The EKS cluster has a control plane, which is used to manage the cluster nodes and workloads. The pods are provisioned into private VPC subnets spanning multiple Availability Zones. The Amazon ECR Public Gallery is referenced to retrieve and deploy an NGINX web server image to the cluster's pods.

The diagram shows how to access the Amazon EKS control plane using `kubect1` commands and how to access the application by using the Application Load Balancer.

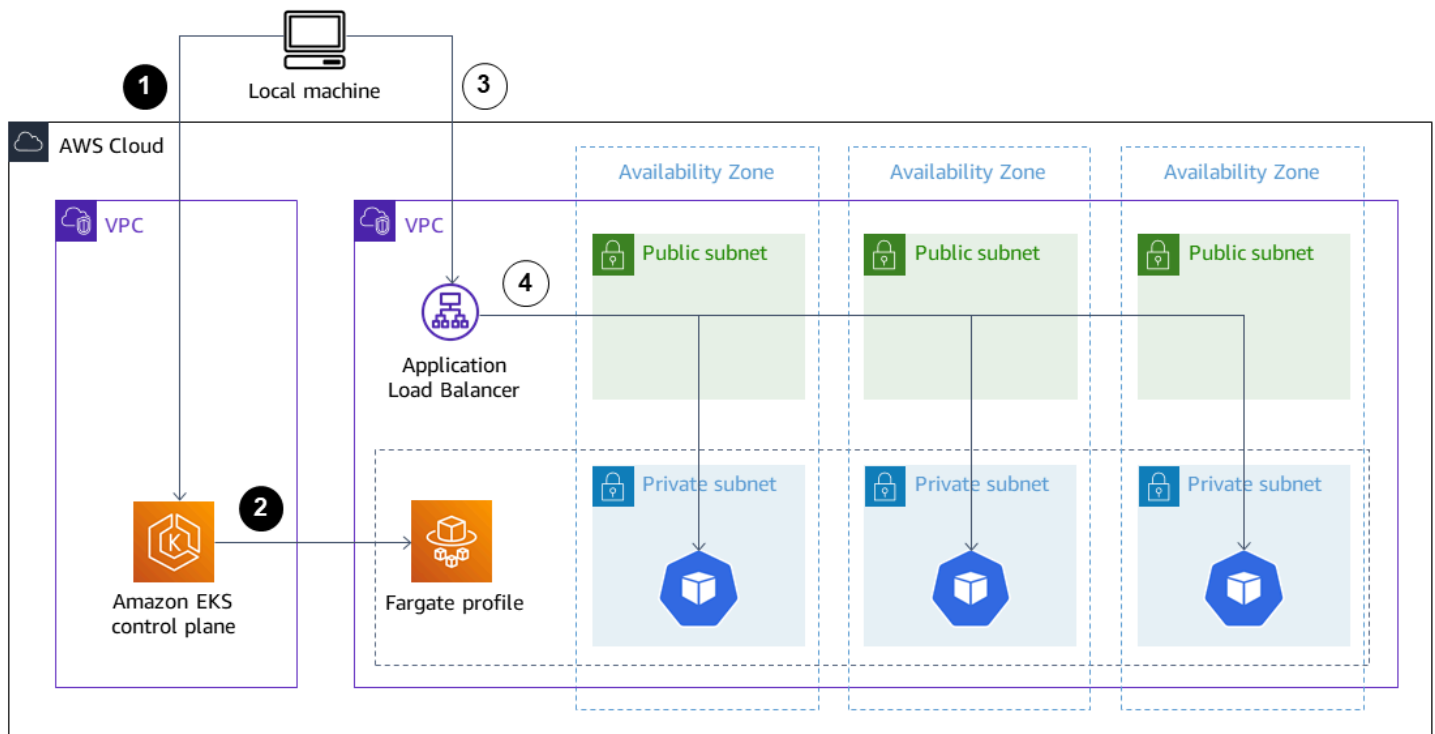

1. A local machine outside the AWS Cloud sends commands to the Kubernetes control plane inside an Amazon EKS managed VPC.
2. Amazon EKS schedules pods based on the selectors in the Fargate profile.
3. The local machine opens the Application Load Balancer URL in the browser.
4. The Application Load Balancer divides traffic between the Kubernetes pods in Fargate cluster nodes deployed in private subnets spanning multiple Availability Zones.

## Tools

### AWS services

- [Amazon Elastic Container Registry \(Amazon ECR\)](#) is a managed container image registry service that's secure, scalable, and reliable.
- [Amazon Elastic Kubernetes Service \(Amazon EKS\)](#) helps you run Kubernetes on AWS without needing to install or maintain your own Kubernetes control plane or nodes. This pattern also uses the `eksctl` command-line tool to work with Kubernetes clusters on Amazon EKS.

- [AWS Fargate](#) helps you run containers without needing to manage servers or Amazon Elastic Compute Cloud (Amazon EC2) instances. It's used in conjunction with Amazon Elastic Container Service (Amazon ECS).
- [Elastic Load Balancing \(ELB\)](#) distributes incoming application or network traffic across multiple targets. For example, you can distribute traffic across Amazon Elastic Compute Cloud (Amazon EC2) instances, containers, and IP addresses in one or more Availability Zones. This pattern uses the [AWS Load Balancer Controller](#) controlling component to create the Application Load Balancer when a [Kubernetes ingress](#) is provisioned. The Application Load Balancer distributes incoming traffic among multiple targets.

## Other tools

- [Helm](#) is an open-source package manager for Kubernetes. In this pattern, Helm is used to install the AWS Load Balancer Controller.
- [Kubernetes](#) is an open-source system for automating deployment, scaling, and management of containerized applications.
- [NGINX](#) is a high-performance web and reverse proxy server.

## Epics

### Create an EKS cluster

Task	Description	Skills required
Create the files.	Using the code in the <a href="#">Additional information</a> section, create the following files: <ul style="list-style-type: none"> <li>• clusterconfig-fargate.yaml</li> <li>• nginx-deployment.yaml</li> <li>• nginx-service.yaml</li> <li>• nginx-ingress.yaml</li> </ul>	App developer, AWS administrator, AWS DevOps



Task	Description	Skills required
	<ul style="list-style-type: none"><li>• <code>index.html</code></li></ul>	
Set environment variables.	<p><b>Note:</b> If a command fails because of previous unfinished tasks, wait a few seconds, and then run the command again.</p> <p>This pattern uses the AWS Region and cluster name that are defined in the file <code>clusterconfig-fargate.yaml</code>. Set the same values as environment variables to reference them in further commands.</p> <pre>export AWS_REGION="us-east-1" export CLUSTER_NAME="my-fargate"</pre>	App developer, AWS DevOps, AWS systems administrator

Task	Description	Skills required
Create an EKS cluster.	<p>To create an EKS cluster that uses the specifications from the <code>clusterconfig-fargate.yaml</code> file, run the following command.</p> <pre data-bbox="594 489 1029 648">eksctl create cluster -f clusterconfig-fargate.yaml</pre> <p>The file contains the <code>ClusterConfig</code>, which provisions a new EKS cluster named <code>my-fargate-cluster</code> in the <code>us-east-1</code> Region and one default Fargate profile (<code>fp-default</code>).</p> <p>The default Fargate profile is configured with two selectors (<code>default</code> and <code>kube-system</code>).</p>	App developer, AWS DevOps, AWS administrator

Task	Description	Skills required
	<p data-bbox="591 226 1024 306">To check the created cluster, run the following command.</p> <pre data-bbox="597 348 1018 464">eksctl get cluster -- output yaml</pre> <p data-bbox="591 506 1024 585">The output should be the following.</p> <pre data-bbox="597 627 1018 779">- Name: my-fargate   Owned: "True"   Region: us-east-1</pre> <p data-bbox="591 821 1024 951">Check the created Fargate profile by using the <code>CLUSTER_NAME</code> .</p> <pre data-bbox="597 993 1018 1184">eksctl get fargatepr ofile --cluster \$CLUSTER_NAME --output yaml</pre> <p data-bbox="591 1226 1024 1499">This command displays information about the resources. You can use the information to verify the created cluster. The output should be the following.</p> <pre data-bbox="597 1541 1018 1866">- name: fp-default   podExecutionRoleARN: arn:aws:iam::&lt;YOUR-ACCOUNT-ID&gt;:role/eksctl-my-fargate-cluster-FargatePodExecutionRole-xxx   selectors:</pre>	<p data-bbox="1066 226 1500 306">App developer, AWS DevOps, AWS systems administrator</p>

Task	Description	Skills required
	<ul style="list-style-type: none"> <li>- namespace: default</li> <li>- namespace: kube-system</li> <li>status: ACTIVE</li> <li>subnets:</li> <li>- subnet-aaa</li> <li>- subnet-bbb</li> <li>- subnet-ccc</li> </ul>	

## Deploy a container

Task	Description	Skills required
<p>Deploy the NGINX web server.</p>	<p>To apply the NGINX web server deployment on the cluster, run the following command.</p> <pre data-bbox="594 1050 1029 1167">kubectl apply -f ./nginx-deployment.yaml</pre> <p>The output should be the following.</p> <pre data-bbox="594 1325 1029 1442">deployment.apps/nginx-deployment created</pre> <p>The deployment includes three replicas of the NGINX image taken from the Amazon ECR Public Gallery. The image is deployed to the default namespace and exposed on port 80 on the running pods.</p>	<p>App developer, AWS DevOps, AWS systems administrator</p>

Task	Description	Skills required
<p>Check the deployment and pods.</p>	<p>(Optional) Check the deployment. You can verify the status of your deployment with the following command.</p> <pre data-bbox="597 489 1027 569">kubect1 get deployment</pre> <p>The output should be the following.</p> <pre data-bbox="597 726 1027 1003">NAME   READY   UP-TO-DATE   AVAILABLE   AGE nginx-deployment   3/3                  3           3                  7m14s</pre> <p>A pod is a deployable object in Kubernetes, containing one or more containers. To list all pods, run the following command.</p> <pre data-bbox="597 1308 1027 1388">kubect1 get pods</pre> <p>The output should be the following.</p> <pre data-bbox="597 1545 1027 1833">NAME   STATUS    READY   AGE      RESTARTS nginx-deployment-xxxx- aaa   1/1     Running 0           94s</pre>	<p>App developer, AWS DevOps, AWS administrator</p>

Task	Description	Skills required
	<pre>nginx-deployment-xxxx- bbb 1/1 Running 0 94s nginx-deployment-xxxx- ccc 1/1 Running 0 94s</pre>	
<p>Scale the deployment.</p>	<p>To scale the deployment from the three replicas that were specified in <code>deployment.yaml</code> to four replicas, use the following command.</p> <pre>kubectl scale deployment nginx-deployment --replicas 4</pre> <p>The output should be the following.</p> <pre>deployment.apps/nginx-deployment scaled</pre>	<p>App developer, AWS DevOps, AWS systems administrator</p>

## Deploy an AWS Load Balancer Controller

Task	Description	Skills required
<p>Set environment variables.</p>	<p>Describe the cluster's CloudFormation stack to retrieve information about its VPC.</p> <pre>aws cloudformation describe-stacks --stack-name eksctl-\$CLUSTER_NAME-cluster</pre>	<p>App developer, AWS DevOps, AWS systems administrator</p>

Task	Description	Skills required
	<pre>tr --query "Stacks[0].Outputs[?OutputKey==`VPC`].OutputValue"</pre> <p>The output should be the following.</p> <pre>[   "vpc-&lt;YOUR-VPC-ID&gt; "]</pre> <p>Copy the VPC ID and export it as an environment variable.</p> <pre>export VPC_ID="vpc-&lt;YOUR-VPC-ID&gt;"</pre>	
Configure IAM for the cluster service account.	<p>Use the <code>AWS_REGION</code> and <code>CLUSTER_NAME</code> from the earlier epic to create an IAM Open ID Connect provider for the cluster.</p> <pre>eksctl utils associate-iam-oidc-provider \--region \$AWS_REGION \--cluster \$CLUSTER_NAME \--approve</pre>	App developer, AWS DevOps, AWS systems administrator

Task	Description	Skills required
<p>Download and create the IAM policy.</p>	<p>Download the IAM policy for the AWS Load Balancer Controller that allows it to make calls to AWS APIs on your behalf.</p> <pre data-bbox="594 489 1027 848">curl -o iam-policy.json https://raw.githubusercontent.com/kubernetes-sigs/aws-load-balancer-controller/main/docs/install/iam_policy.json</pre> <p>Create the policy in your AWS account by using the AWS CLI.</p> <pre data-bbox="594 1003 1027 1320">aws iam create-policy \ --policy-name AWSLoadBalancerControllerIAMPolicy \ --policy-document file://iam-policy.json</pre> <p>You should see the following output.</p> <pre data-bbox="594 1478 1027 1852">{   "Policy": {     "PolicyName":       "AWSLoadBalancerControllerIAMPolicy",     "PolicyId":       "&lt;YOUR_POLICY_ID&gt;",     "Arn": "arn:aws:iam::&lt;YOUR-ACCOUNT</pre>	<p>App developer, AWS DevOps, AWS systems administrator</p>



Task	Description	Skills required
	<pre>-ID&gt;:policy/AWSLoadBalancerControllerIAMPolicy",     "Path": "/",     "DefaultVersionId": "v1",     "AttachmentCount": 0,     "PermissionsBoundaryUsageCount": 0,     "IsAttachable": true,     "CreateDate": "&lt;YOUR-DATE&gt;",     "UpdateDate": "&lt;YOUR-DATE&gt;"   } }</pre> <p>Save the Amazon Resource Name (ARN) of the policy as \$POLICY_ARN .</p> <pre>export POLICY_ARN="arn:aws:iam::&lt;YOUR-ACCOUNT-ID&gt;:policy/AWSLoadBalancerControllerIAMPolicy"</pre>	

Task	Description	Skills required
Create an IAM service account.	<p>Create an IAM service account named <code>aws-load-balancer-controller</code> in the <code>kube-system</code> namespace. Use the <code>CLUSTER_NAME</code>, <code>AWS_REGION</code>, and <code>POLICY_ARN</code> that you previously configured.</p> <pre data-bbox="597 684 1027 1278">eksctl create iamserviceaccount \   --cluster=\$CLUSTER_NAME \   --region=\$AWS_REGION \   --attach-policy-arn=\$POLICY_ARN \   --namespace=kube-system \   --name=aws-load-balancer-controller \   --override-existing-serviceaccounts \   --approve</pre> <p>Verify the creation.</p> <pre data-bbox="597 1392 1027 1785">eksctl get iamserviceaccount \   --cluster \$CLUSTER_NAME \   --name aws-load-balancer-controller \   --namespace kube-system \   --output yaml</pre>	App developer, AWS DevOps, AWS systems administrator

Task	Description	Skills required
	<p>The output should be the following.</p> <pre data-bbox="597 331 1026 1285">- metadata:   name: aws-load-balancer-controller   namespace: kube-system   status:     roleARN: arn:aws:iam::&lt;YOUR-ACCOUNT-ID&gt;:role/eksctl-my-fargate-addon-iam-serviceaccount-kubernetes-Role1-&lt;YOUR-ROLE-ID&gt;     wellKnownPolicies:       autoScaler: false       awsLoadBalancerController: false       certManager: false       ebsCSIController: false       efsCSIController: false       externalDNS: false       imageBuilder: false</pre>	

Task	Description	Skills required
Install the AWS Load Balancer Controller.	<p>Update the Helm repository.</p> <pre>helm repo update</pre> <p>Add the Amazon EKS chart repository to the Helm repo.</p> <pre>helm repo add eks https://aws.github.io/eks-charts</pre> <p>Apply the Kubernetes custom resource definitions (CRDs) that are used by the <a href="#">AWS Load Balancer Controller eks-chart</a> in the background.</p> <pre>kubectl apply -k "github.com/aws/eks-charts/stable/aws-load-balancer-controller//crds?ref=master"</pre> <p>The output should be the following.</p> <pre>customresourcedefinition.apiextensions.k8s.io/ingressclassparams.elbv2.k8s.aws created customresourcedefinition.apiextensions.k8s.io/targetgroupbindings.elbv2.k8s.aws created</pre>	App developer, AWS DevOps, AWS systems administrator

Task	Description	Skills required
	<p>Install the Helm chart, using the environment variables that you set previously.</p> <pre data-bbox="597 380 1029 1014">helm install aws-load-balancer-controller eks/aws-load-balancer-controller \   --set clusterName=\$CLUSTER_NAME \   --set serviceAccount.create=false \   --set region=\$AWS_REGION \   --set vpcId=\$VPC_ID \   --set serviceAccount.name=aws-load-balancer-controller \   -n kube-system</pre> <p>The output should be the following.</p> <pre data-bbox="597 1171 1029 1650">NAME: aws-load-balancer-controller LAST DEPLOYED: &lt;YOUR-DATE&gt; NAMESPACE: kube-system STATUS: deployed REVISION: 1 TEST SUITE: None NOTES: AWS Load Balancer controller installed!</pre>	

Task	Description	Skills required
Create an NGINX service.	<p>Create a service to expose the NGINX pods by using the <code>nginx-service.yaml</code> file.</p> <pre>kubectl apply -f nginx-service.yaml</pre> <p>The output should be the following.</p> <pre>service/nginx-service created</pre>	App developer, AWS DevOps, AWS systems administrator
Create the Kubernetes ingress resource.	<p>Create a service to expose the Kubernetes NGINX ingress by using the <code>nginx-ingress.yaml</code> file.</p> <pre>kubectl apply -f nginx-ingress.yaml</pre> <p>The output should be the following.</p> <pre>ingress.networking.k8s.io/nginx-ingress created</pre>	App developer, AWS DevOps, AWS systems administrator

Task	Description	Skills required
Get the load balancer URL.	<p>To retrieve the ingress information, use the following command.</p> <pre>kubectl get ingress nginx-ingress</pre> <p>The output should be the following.</p> <pre>NAME          CLASS HOSTS        ADDRESS            PORTS    AGE nginx-ingress &lt;none&gt; *          k8s-defau lt-nginxing-xxx.us -east-1.elb.amazon aws.com      80       80s</pre> <p>Copy the ADDRESS (for example, k8s-default-nginxing-xxx.us-east-1.elb.amazonaws.com ) from the output, and paste it into your browser to access the <code>index.html</code> file.</p>	App developer, AWS DevOps, AWS systems administrator

## Debug running containers

Task	Description	Skills required
Select a pod.	List all pods, and copy the desired pod's name.	App developer, AWS DevOps, AWS systems administrator

Task	Description	Skills required
	<pre data-bbox="597 212 1029 289">kubectl get pods</pre> <p data-bbox="597 327 959 405">The output should be the following.</p> <pre data-bbox="597 447 1029 1276">NAME       STATUS   READY       AGE      RESTARTS nginx-deployment- xxxx-aaa      1/1   Running    0   55m nginx-deployment- xxxx-bbb      1/1   Running    0   55m nginx-deployment- xxxx-ccc      1/1   Running    0   55m nginx-deployment- xxxx-ddd      1/1   Running    0   42m</pre> <p data-bbox="597 1318 1000 1444">This command lists the existing pods and additional information.</p> <p data-bbox="597 1493 1013 1862">If you are interested in a specific pod, fill in the name of the pod you are interested in for the <code>POD_NAME</code> variable or set it as an environment variable. Otherwise, omit this parameter to look up all resources.</p>	



Task	Description	Skills required
	<pre>export POD_NAME="nginx- deployment-&lt;YOUR-POD- NAME&gt;"</pre>	
Access the logs.	<p>Get the logs from the pod that you want to debug.</p> <pre>kubectl logs \$POD_NAME</pre>	App developer, AWS systems administrator, AWS DevOps
Forward the NGINX port.	<p>Use port-forwarding to map the pod's port for accessing the NGINX web server to a port on your local machine.</p> <pre>kubectl port-forward deployment/nginx-d eployment 8080:80</pre> <p>In your browser, open the following URL.</p> <pre>http://localhost:8080</pre> <p>The <code>port-forward</code> command provides access to the <code>index.html</code> file without making it publicly available over a load balancer. This is useful for accessing the running application while debugging it. You can stop the port-forwarding by pressing the keyboard command <b>Ctrl+C</b>.</p>	App developer, AWS DevOps, AWS systems administrator

Task	Description	Skills required
Run commands within the pod.	<p>To look at the current <code>index.html</code> file, use the following command.</p> <pre>kubectl exec \$POD_NAME -- cat /usr/share/ nginx/html/index.html</pre> <p>You can use the <code>exec</code> command to issue any command directly in the pod. This is useful for debugging running applications.</p>	App developer, AWS DevOps, AWS systems administrator
Copy files to a pod.	<p>Remove the default <code>index.html</code> file on this pod.</p> <pre>kubectl exec \$POD_NAME -- rm /usr/share/ nginx/html/index.html</pre> <p>Upload the customized local file <code>index.html</code> to the pod.</p> <pre>kubectl cp index.html \$POD_NAME:/usr/share/ nginx/html/</pre> <p>You can use the <code>cp</code> command to change or add files directly to any of the pods.</p>	App developer, AWS DevOps, AWS systems administrator

Task	Description	Skills required
Use port-forwarding to display the change.	<p>Use port-forwarding to verify the changes that you made to this pod.</p> <pre>kubectl port-forward pod/\$POD_NAME 8080:80</pre> <p>Open the following URL in your browser.</p> <pre>http://localhost:8080</pre> <p>The applied changes to the <code>index.html</code> file should be visible in the browser.</p>	App developer, AWS DevOps, AWS systems administrator

## Delete resources

Task	Description	Skills required
Delete the load balancer.	<p>Delete the ingress.</p> <pre>kubectl delete ingress/n ginx-ingress</pre> <p>The output should be the following.</p> <pre>ingress.networking .k8s.io "nginx-in gress" deleted</pre> <p>Delete the service.</p>	App developer, AWS DevOps, AWS systems administrator

Task	Description	Skills required
	<pre>kubectl delete service/n ginx-service</pre> <p>The output should be the following.</p> <pre>service "nginx-service" deleted</pre> <p>Delete the load balancer controller.</p> <pre>helm delete aws-load- balancer-controller - n kube-system</pre> <p>The output should be the following.</p> <pre>release "aws-load- balancer-controller" uninstalled</pre> <p>Delete the service account.</p> <pre>eksctl delete iam servic eaccount --cluster \$CLUSTER_NAME -- namespace kube-syst em --name aws-load- balancer-controller</pre>	

Task	Description	Skills required
Delete the deployment.	<p>To delete the deployment resources, use the following command.</p> <pre>kubectl delete deploy/nginx-deployment</pre> <p>The output should be the following.</p> <pre>deployment.apps "nginx-deployment" deleted</pre>	App developer, AWS DevOps, AWS systems administrator
Delete the cluster.	<p>Delete the EKS cluster by using the following command, where <code>my-fargate</code> is the cluster name.</p> <pre>eksctl delete cluster --name \$CLUSTER_NAME</pre> <p>This command deletes the entire cluster, including all associated resources.</p>	App developer, AWS DevOps, AWS systems administrator
Delete the IAM policy.	<p>Delete the previously created policy by using the AWS CLI.</p> <pre>aws iam delete-policy --policy-arn \$POLICY_ARN</pre>	App developer, AWS administrator, AWS DevOps

## Troubleshooting

Issue	Solution
<p>You receive an <a href="#">error message upon cluster creation</a> stating that your targeted Availability Zone doesn't have sufficient capacity to support the cluster. You should see a message similar to the following.</p> <div data-bbox="115 611 792 966" style="border: 1px solid #ccc; border-radius: 10px; padding: 10px;"><pre>Cannot create cluster 'my-fargate' because us-east-1e, the targeted availability zone, does not currently have sufficient capacity to support the cluster. Retry and choose from these availability zones: us-east-1a, us-east-1b, us-east-1c, us-east-1d, us-east-1f</pre></div>	<p>Create the cluster again using the recommended Availability Zones from the error message. Specify a list of Availability Zones in the last line of your <code>clusterconfig-fargate.yaml</code> file (for example, <code>availabilityZones: ["us-east-1a", "us-east-1b", "us-east-1c"]</code> ).</p>

## Related resources

- [Amazon EKS documentation](#)
- [Application load balancing on Amazon EKS](#)
- [EKS Best Practices Guides](#)
- [AWS Load Balancer Controller documentation](#)
- [eksctl documentation](#)
- [Amazon ECR Public Gallery NGINX image](#)
- [Helm documentation](#)
- [Debug Running Pods](#) (Kubernetes documentation)
- [Amazon EKS Workshop](#)
- [EKS cluster creation errors](#)

## Additional information

### clusterconfig-fargate.yaml

```
apiVersion: eksctl.io/v1alpha5
kind: ClusterConfig

metadata:
  name: my-fargate
  region: us-east-1

fargateProfiles:
  - name: fp-default
    selectors:
      - namespace: default
      - namespace: kube-system
```

### nginx-deployment.yaml

```
apiVersion: apps/v1
kind: Deployment
metadata:
  name: "nginx-deployment"
  namespace: "default"
spec:
  replicas: 3
  selector:
    matchLabels:
      app: "nginx"
  template:
    metadata:
      labels:
        app: "nginx"
    spec:
      containers:
        - name: nginx
          image: public.ecr.aws/nginx/nginx:latest
          ports:
            - containerPort: 80
```

### nginx-service.yaml

```
apiVersion: v1
kind: Service
metadata:
  annotations:
    alb.ingress.kubernetes.io/target-type: ip
  name: "nginx-service"
  namespace: "default"
spec:
  ports:
    - port: 80
      targetPort: 80
      protocol: TCP
  type: NodePort
  selector:
    app: "nginx"
```

## nginx-ingress.yaml

```
apiVersion: networking.k8s.io/v1
kind: Ingress
metadata:
  namespace: "default"
  name: "nginx-ingress"
  annotations:
    kubernetes.io/ingress.class: alb
    alb.ingress.kubernetes.io/scheme: internet-facing
spec:
  rules:
    - http:
        paths:
          - path: /
            pathType: Prefix
            backend:
              service:
                name: "nginx-service"
                port:
                  number: 80
```

## index.html

```
<!DOCTYPE html>
<html>
```



```
<body>
  <h1>Welcome to your customized nginx!</h1>
  <p>You modified the file on this running pod</p>
</body>

</html>
```

# Deploy containers by using Elastic Beanstalk

Created by Thomas Scott (AWS) and Jean-Baptiste Guillois (AWS)

**Code repository:** [Cluster](#)  
[Sample App](#)

**Environment:** Production

**Technologies:** Containers & microservices; CloudNative; Modernization

**AWS services:** AWS Elastic Beanstalk

## Summary

On the Amazon Web Services (AWS) Cloud, AWS Elastic Beanstalk supports Docker as an available platform, so that containers can run with the created environment. This pattern shows how to deploy containers using the Elastic Beanstalk service. The deployment of this pattern will use the web server environment based on the Docker platform.

To use Elastic Beanstalk for deploying and scaling web applications and services, you upload your code and the deployment is automatically handled. Capacity provisioning, load balancing, automatic scaling, and application health monitoring are also included. When you use Elastic Beanstalk, you can take full control over the AWS resources that it creates on your behalf. There is no additional charge for Elastic Beanstalk. You pay only for the AWS resources that are used to store and run your applications.

This pattern includes instructions for deployment using the [AWS Elastic Beanstalk Command Line Interface \(EB CLI\)](#) and the AWS Management Console.

## Use cases

Use cases for Elastic Beanstalk include the following:

- Deploy a prototype environment to demo a frontend application. (This pattern uses a Dockerfile as the example.)
- Deploy an API to handle API requests for a given domain.
- Deploy an orchestration solution using Docker-Compose (`docker-compose.yml` is not used as the practical example in this pattern).

## Prerequisites and limitations

### Prerequisites

- An AWS account
- AWS EB CLI locally installed
- Docker installed on a local machine

### Limitations

- There is a Docker pull limit of 100 pulls per 6 hours per IP address on the free plan.

## Architecture

### Target technology stack

- Amazon Elastic Compute Cloud (Amazon EC2) instances
- Security group
- Application Load Balancer
- Auto Scaling group

### Target architecture

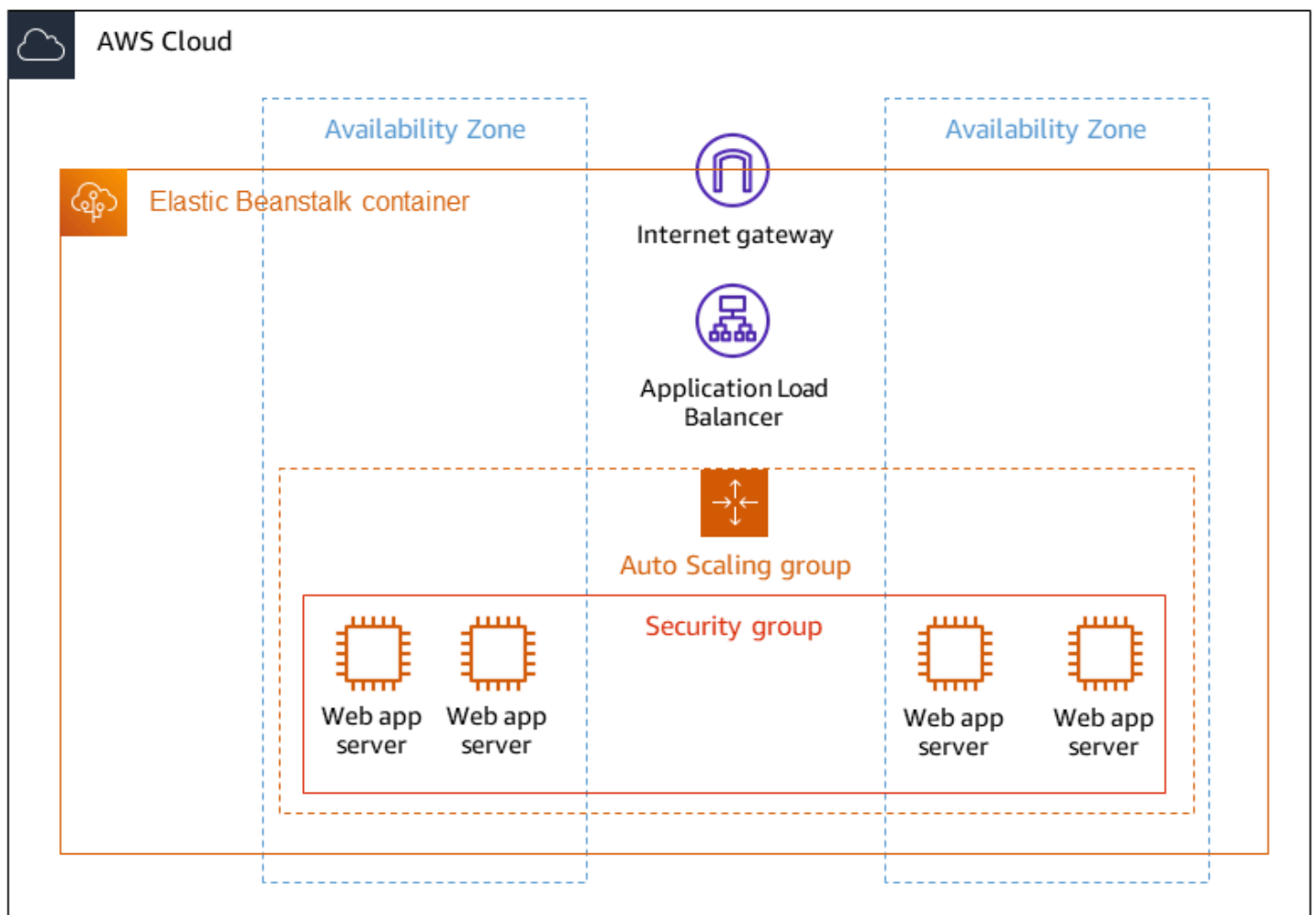

## Automation and scale

AWS Elastic Beanstalk can automatically scale based on the number of requests made. AWS resources created for an environment include one Application Load Balancer, an Auto Scaling group, and one or more Amazon EC2 instances.

The load balancer sits in front of the Amazon EC2 instances, which are part of the Auto Scaling group. Amazon EC2 Auto Scaling automatically starts additional Amazon EC2 instances to accommodate increasing load on your application. If the load on your application decreases, Amazon EC2 Auto Scaling stops instances, but it keeps at least one instance running.

## Automatic scaling triggers

The Auto Scaling group in your Elastic Beanstalk environment uses two Amazon CloudWatch alarms to initiate scaling operations. The default triggers scale when the average outbound network traffic from each instance is higher than 6 MB or lower than 2 MB over a period of five

minutes. To use Amazon EC2 Auto Scaling effectively, configure triggers that are appropriate for your application, instance type, and service requirements. You can scale based on several statistics including latency, disk I/O, CPU utilization, and request count. For more information, see [Auto Scaling triggers](#).

## Tools

### AWS services

- [AWS Command Line Interface \(AWS CLI\)](#) is an open-source tool that helps you interact with AWS services through commands in your command-line shell.
- [AWS EB Command Line Interface \(EB CLI\)](#) is a command-line client that you can use to create, configure, and manage Elastic Beanstalk environments.
- [Elastic Load Balancing](#) distributes incoming application or network traffic across multiple targets. For example, you can distribute traffic across Amazon Elastic Compute Cloud (Amazon EC2) instances, containers, and IP addresses in one or more Availability Zones.

### Other services

- [Docker](#) packages software into standardized units called containers that include libraries, system tools, code, and runtime.

### Code

The code for this pattern is available in the GitHub [Cluster Sample Application](#) repository.

## Epics

### Build with a Dockerfile

Task	Description	Skills required
Clone the remote repository.	<ul style="list-style-type: none"><li>• To clone the repository, run the command <code>git clone https://github.com/aws-samples/</code></li></ul>	App developer, AWS administrator, AWS DevOps

Task	Description	Skills required
Initialize the Elastic Beanstalk Docker project.	<p data-bbox="626 212 911 296"><code>cluster-sample-app.git.</code></p> <ol data-bbox="594 338 1003 527" style="list-style-type: none"> <li>1. Create a file called <code>aws.json</code> at the root.</li> <li>2. In the <code>aws.json</code> file, add the following code.</li> </ol> <pre data-bbox="634 569 1027 1276"> {     "AWSEBDoc kerrunVersion":"1",     "Image":{         "Name":"c luster-sample-app"     },     "Ports":[         {              "ContainerPort":80         },         {              "HostPort":8080         }     ] } </pre> <ol data-bbox="594 1297 1003 1430" style="list-style-type: none"> <li>3. Run the command <code>eb init -p docker</code> at the root of the project.</li> </ol>	App developer, AWS administrator, AWS DevOps
Test the project locally.	<ol data-bbox="594 1472 1003 1755" style="list-style-type: none"> <li>1. Run the command <code>eb local run</code> at the root of the project.</li> <li>2. Test the application by navigating to <code>http://localhost</code>.</li> </ol>	App developer, AWS administrator, AWS DevOps

## Deploy using EB CLI

Task	Description	Skills required
Run deployment command	1. Run the command <code>eb create docker-sample-cluster-app</code> at the root of the project.	App developer, AWS administrator, AWS DevOps
Access the deployed version.	After the deployment command has finished, access the project using the <code>eb open</code> command.	App developer, AWS administrator, AWS DevOps

## Deploy using the console

Task	Description	Skills required
Deploy the application by using the browser.	<ol style="list-style-type: none"><li>1. Open the console.</li><li>2. Navigate to the Elastic Beanstalk console.</li><li>3. Choose <b>Create Application</b>.</li><li>4. For the <b>Application Name</b>, enter <b>Cluster-Sample-App</b>.</li><li>5. Choose <b>Docker</b> as the platform.</li><li>6. Choose <b>Upload your code</b>.</li><li>7. Choose your local <code>.zip</code> file (in the root of the cloned project) or a public Amazon Simple Storage Service (Amazon S3) URL.</li></ol>	App developer, AWS administrator, AWS DevOps

Task	Description	Skills required
Access the deployed version.	After deployment, access the deployed application, and choose the URL provided.	App developer, AWS administrator, AWS DevOps

## Related resources

- [Web server environments](#)
- [Install the EB CLI on macOS](#)
- [Manually install the EB CLI](#)

## Additional information

### Advantages of using Elastic Beanstalk

- Automatic infrastructure provisioning
- Automatic management of the underlying platform
- Automatic patching and updates to support the application
- Automatic scaling of the application
- Ability to customize the number of nodes
- Ability to access the infrastructure components if needed
- Ease of deployment over other container deployment solutions



# Generate a static outbound IP address using a Lambda function, Amazon VPC, and a serverless architecture

Created by Thomas Scott (AWS)

**Environment:** Production

**Technologies:** Containers & microservices; DevelopmentAndTesting

**AWS services:** AWS Lambda

## Summary

This pattern describes how to generate a static outbound IP address in the Amazon Web Services (AWS) Cloud by using a serverless architecture. Your organization can benefit from this approach if it wants to send files to a separate business entity by using Secure File Transfer Protocol (SFTP). This means that the business entity must have access to an IP address that allows files through its firewall.

The pattern's approach helps you create an AWS Lambda function that uses an [Elastic IP address](#) as the outbound IP address. By following the steps in this pattern, you can create a Lambda function and a virtual private cloud (VPC) that routes outbound traffic through an internet gateway with a static IP address. To use the static IP address, you attach the Lambda function to the VPC and its subnets.

## Prerequisites and limitations

### Prerequisites

- An active AWS account.
- AWS Identity and Access Management (IAM) permissions to create and deploy a Lambda function, and to create a VPC and its subnets. For more information about this, see [Execution role and user permissions](#) in the AWS Lambda documentation.
- If you plan to use infrastructure as code (IaC) to implement this pattern's approach, you need an integrated development environment (IDE) such as AWS Cloud9. For more information about this, see [What is AWS Cloud9?](#) in the AWS Cloud9 documentation.

# Architecture

The following diagram shows the serverless architecture for this pattern.

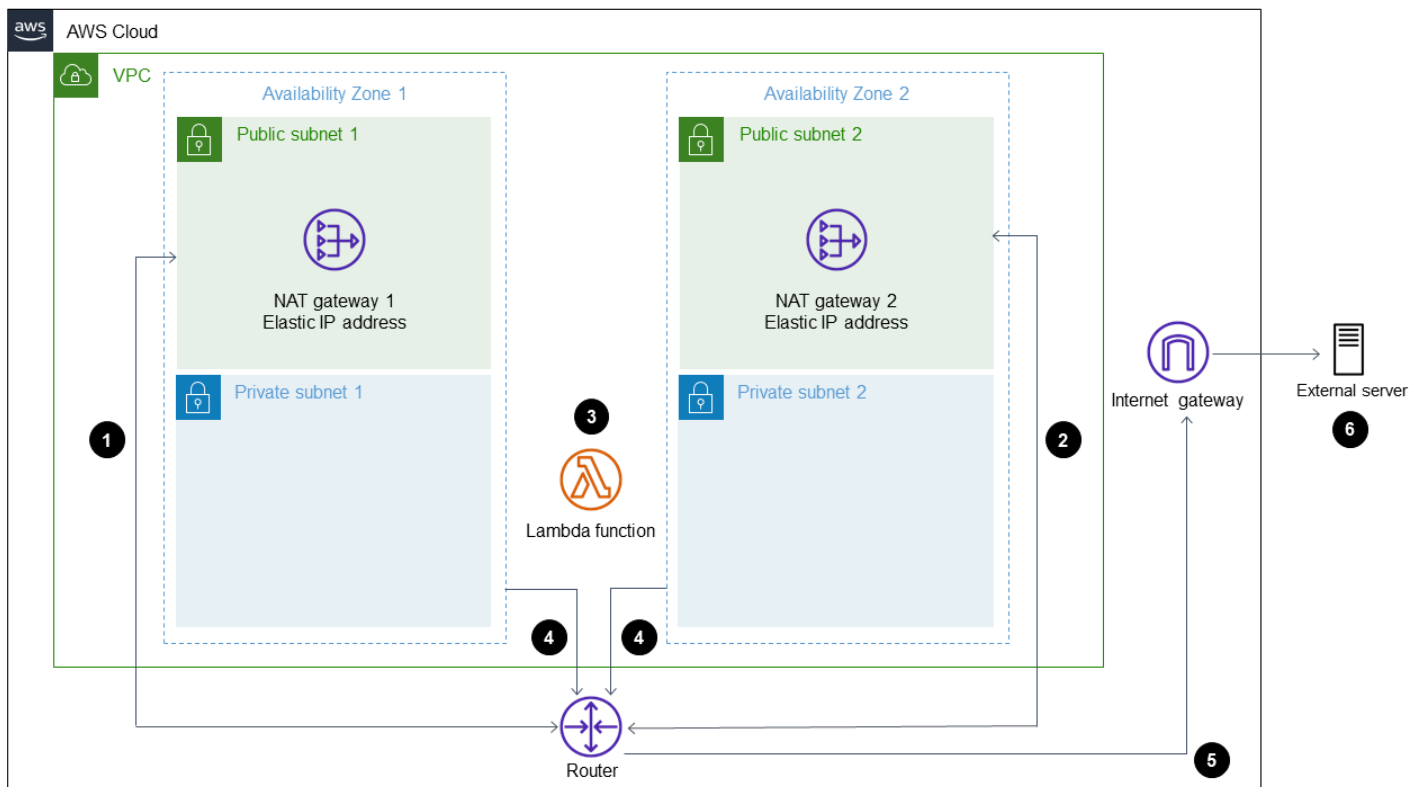

The diagram shows the following workflow:

1. Outbound traffic leaves NAT gateway 1 in Public subnet 1.
2. Outbound traffic leaves NAT gateway 2 in Public subnet 2.
3. The Lambda function can run in Private subnet 1 or Private subnet 2.
4. Private subnet 1 and Private subnet 2 route traffic to the NAT gateways in the public subnets.
5. The NAT gateways send outbound traffic to the internet gateway from the public subnets.
6. Outbound data is transferred from the internet gateway to the external server.

## Technology stack

- Lambda
- Amazon Virtual Private Cloud (Amazon VPC)

## Automation and scale

You can ensure high availability (HA) by using two public and two private subnets in different Availability Zones. Even if one Availability Zone becomes unavailable, the pattern's solution continues to work.

## Tools

- [AWS Lambda](#) – AWS Lambda is a compute service that supports running code without provisioning or managing servers. Lambda runs your code only when needed and scales automatically, from a few requests per day to thousands per second. You pay only for the compute time that you consume—there is no charge when your code is not running.
- [Amazon VPC](#) – Amazon Virtual Private Cloud (Amazon VPC) provisions a logically isolated section of the AWS Cloud where you can launch AWS resources in a virtual network that you've defined. This virtual network closely resembles a traditional network that you'd operate in your own data center, with the benefits of using the scalable infrastructure of AWS.

## Epics

### Create a new VPC

Task	Description	Skills required
Create a new VPC.	<p>Sign in to the AWS Management Console, open the Amazon VPC console, and then create a VPC named Lambda VPC that has <code>10.0.0.0/25</code> as the IPv4 CIDR range.</p> <p>For more information about creating a VPC, see <a href="#">Getting started with Amazon VPC</a> in the Amazon VPC documentation.</p>	AWS administrator

## Create two public subnets

Task	Description	Skills required
Create the first public subnet.	<ol style="list-style-type: none"><li>1. On the Amazon VPC console, choose <b>Subnets</b> and then choose <b>Create Subnet</b>.</li><li>2. For <b>Name tag</b>, enter <code>public-one</code> .</li><li>3. For <b>VPC</b>, choose Lambda VPC.</li><li>4. Choose an Availability Zone and record it.</li><li>5. For <b>IPv4 CIDR block</b>, enter <code>10.0.0.0/28</code> and then choose <b>Create subnet</b>.</li></ol>	AWS administrator
Create the second public subnet.	<ol style="list-style-type: none"><li>1. On the Amazon VPC console, choose <b>Subnets</b> and then choose <b>Create Subnet</b>.</li><li>2. For <b>Name tag</b>, enter <code>public-two</code> .</li><li>3. For <b>VPC</b>, choose Lambda VPC.</li><li>4. Choose an Availability Zone and record it. <b>Important</b> : You cannot use the Availability Zone that contains the <code>public-one</code> subnet.</li><li>5. For <b>IPv4 CIDR block</b>, enter <code>10.0.0.16/28</code> and then choose <b>Create subnet</b>.</li></ol>	AWS administrator

## Create two private subnets

Task	Description	Skills required
Create the first private subnet.	<ol style="list-style-type: none"><li>1. On the Amazon VPC console, choose <b>Subnets</b> and then choose <b>Create Subnet</b>.</li><li>2. For <b>Name tag</b>, enter <code>private-one</code>.</li><li>3. For <b>VPC</b>, choose Lambda VPC.</li><li>4. Choose the Availability Zone that contains the <code>public-one</code> subnet that you created earlier.</li><li>5. For <b>IPv4 CIDR block</b>, enter <code>10.0.0.32/28</code> and then choose <b>Create subnet</b>.</li></ol>	AWS administrator
Create the second private subnet.	<ol style="list-style-type: none"><li>1. On the Amazon VPC console, choose <b>Subnets</b> and then choose <b>Create Subnet</b>.</li><li>2. For <b>Name tag</b>, enter <code>private-two</code>.</li><li>3. For <b>VPC</b>, choose Lambda VPC.</li><li>4. Choose the same Availability Zone that contains the <code>public-two</code> subnet that you created earlier.</li><li>5. For <b>IPv4 CIDR block</b>, enter <code>10.0.0.64/28</code> and then choose <b>Create subnet</b>.</li></ol>	AWS administrator

## Create two Elastic IP addresses for your NAT gateways

Task	Description	Skills required
Create the first Elastic IP address.	<ol style="list-style-type: none"><li>1. On the Amazon VPC console, choose <b>Elastic IPs</b> and then choose <b>Allocate new address</b>.</li><li>2. Choose <b>Allocate</b> and record the <b>Allocation ID</b> for your newly created Elastic IP address.</li></ol> <p><b>Note:</b> This Elastic IP address is used for your first NAT gateway.</p>	AWS administrator
Create the second Elastic IP address.	<ol style="list-style-type: none"><li>1. On the Amazon VPC console, choose <b>Elastic IPs</b> and then choose <b>Allocate new address</b>.</li><li>2. Choose <b>Allocate</b> and record the <b>Allocation ID</b> for this second Elastic IP address.</li></ol> <p><b>Note:</b> This Elastic IP address is used for your second NAT gateway.</p>	AWS administrator

## Create an internet gateway

Task	Description	Skills required
Create an internet gateway.	<ol style="list-style-type: none"> <li>1. On the Amazon VPC console, choose <b>Internet Gateways</b> and then choose <b>Create internet gateway</b>.</li> <li>2. Enter <code>internet-gateway</code> as the name and then choose <b>Create internet gateway</b>. Make sure that you record the internet gateway ID.</li> </ol>	AWS administrator
Attach the internet gateway to the VPC.	Select the internet gateway that you just created, and then choose <b>Actions, Attach to VPC</b> .	AWS administrator

## Create two NAT gateways

Task	Description	Skills required
Create the first NAT gateway.	<ol style="list-style-type: none"> <li>1. On the Amazon VPC console, choose <b>NAT Gateways</b> and then choose <b>Create NAT Gateway</b>.</li> <li>2. Enter <code>nat-one</code> as the NAT gateway name.</li> <li>3. Choose <code>public-one</code> as the subnet to create the NAT gateway in.</li> <li>4. For <b>Connectivity type</b>, choose <b>Public</b>.</li> </ol>	AWS administrator

Task	Description	Skills required
	<ol style="list-style-type: none"><li>5. For <b>Elastic IP allocation ID</b>, choose the first Elastic IP address that you created earlier and associate it with the NAT gateway.</li><li>6. Choose <b>Create NAT gateway</b>.</li></ol>	
Create the second NAT gateway.	<ol style="list-style-type: none"><li>1. On the Amazon VPC console, choose <b>NAT Gateways</b> and then choose <b>Create NAT Gateway</b>.</li><li>2. Enter <code>nat-two</code> as the NAT gateway name.</li><li>3. Choose <code>public-two</code> as the subnet to create the NAT gateway in.</li><li>4. For <b>Connectivity type</b>, choose <b>Public</b>.</li><li>5. For <b>Elastic IP allocation ID</b>, choose the second Elastic IP address that you created earlier and associate it with the NAT gateway.</li><li>6. Choose <b>Create NAT gateway</b>.</li></ol>	AWS administrator



## Create route tables for your public and private subnets

Task	Description	Skills required
Create the route table for the public-one subnet.	<ol style="list-style-type: none"><li>1. On the Amazon VPC console, choose <b>Route Tables</b> and then choose <b>Create route table</b>.</li><li>2. Enter public-one-subnet as the route table name and then choose <b>Create route table</b>.</li><li>3. Choose the public-one-subnet route table, choose <b>Edit routes</b>, and then choose <b>Add route</b>.</li><li>4. Specify 0.0.0.0 in the <b>Destination</b> box and then choose the internet gateway ID in the <b>Target</b> list.</li><li>5. On the <b>Subnet associations</b> tab, choose <b>Edit subnet associations</b>, choose the public-one subnet with the 10.0.0.0/28 CIDR range, and then choose <b>Save associations</b>.</li><li>6. Choose <b>Save Changes</b>.</li></ol>	AWS administrator
Create the route table for the public-two subnet.	<ol style="list-style-type: none"><li>1. On the Amazon VPC console, choose <b>Route Tables</b> and then choose <b>Create route table</b>.</li></ol>	AWS administrator

Task	Description	Skills required
	<ol style="list-style-type: none"><li data-bbox="591 212 1013 390">2. Enter <code>public-two-subnet</code> as the route table name and then choose <b>Create route table</b>.</li><li data-bbox="591 415 980 594">3. Choose the <code>public-two-subnet</code> route table, choose <b>Edit routes</b>, and then choose <b>Add route</b>.</li><li data-bbox="591 619 992 840">4. Specify <code>0.0.0.0</code> in the <b>Destination</b> box and then choose the internet gateway ID in the <b>Target</b> list.</li><li data-bbox="591 865 984 1234">5. On the <b>Subnet associations</b> tab, choose <b>Edit subnet associations</b>, choose the <code>public-two</code> subnet with the <code>10.0.0.16/28</code> CIDR range, and then choose <b>Save associations</b>.</li><li data-bbox="591 1260 959 1291">6. Choose <b>Save Changes</b>.</li></ol>	

Task	Description	Skills required
Create the route table for the private-one subnet.	<ol style="list-style-type: none"><li>1. On the Amazon VPC console, choose <b>Route Tables</b> and then choose <b>Create route table</b>.</li><li>2. Enter <code>private-one-subnet</code> as the route table name and then choose <b>Create route table</b>.</li><li>3. Choose the <code>private-one-subnet</code> route table, choose <b>Edit routes</b>, and then choose <b>Add route</b>.</li><li>4. Specify <code>0.0.0.0</code> in the <b>Destination</b> box and then choose the NAT gateway in the <code>public-one</code> subnet in the <b>Target</b> list.</li><li>5. On the <b>Subnet associations</b> tab, choose <b>Edit subnet associations</b>, choose the <code>private-one</code> subnet with the <code>10.0.0.32/28</code> CIDR range, and then choose <b>Save associations</b>.</li><li>6. Choose <b>Save Changes</b>.</li></ol>	AWS administrator

Task	Description	Skills required
Create the route table for the private-two subnet.	<ol style="list-style-type: none"><li>1. On the Amazon VPC console, choose <b>Route Tables</b> and then choose <b>Create route table</b>.</li><li>2. Enter <code>private-two-subnet</code> as the route table name and then choose <b>Create route table</b>.</li><li>3. Choose the <code>private-two-subnet</code> route table, choose <b>Edit routes</b>, and then choose <b>Add route</b>.</li><li>4. Specify <code>0.0.0.0</code> in the <b>Destination</b> box and then choose the NAT gateway in the <code>public-two</code> subnet in the <b>Target</b> list.</li><li>5. On the <b>Subnet associations</b> tab, choose <b>Edit subnet associations</b>, choose the <code>private-two</code> subnet with the <code>10.0.0.64/28</code> CIDR range, and then choose <b>Save associations</b>.</li><li>6. Choose <b>Save Changes</b>.</li></ol>	AWS administrator

## Create the Lambda function, add it to the VPC, and test the solution

Task	Description	Skills required
Create a new Lambda function.	<ol style="list-style-type: none"> <li>1. Open the AWS Lambda console and choose <b>Create function</b>.</li> <li>2. Under <b>Basic information</b>, enter Lambda test under <b>Function name</b> and then choose the language of your choice under <b>Runtime</b>.</li> <li>3. Choose <b>Create function</b>.</li> </ol>	AWS administrator
Add the Lambda function to your VPC.	<ol style="list-style-type: none"> <li>1. On the AWS Lambda console, choose <b>Functions</b> and then choose the function that you created earlier.</li> <li>2. Choose <b>Configuration</b> and then choose <b>VPC</b>.</li> <li>3. Choose <b>Edit</b> and then choose Lambda VPC and both private subnets.</li> <li>4. Choose <b>Default security group</b> for testing purposes and then choose <b>Save</b>.</li> </ol>	AWS administrator
Write code to call an external service.	<ol style="list-style-type: none"> <li>1. In the programming language of your choice, write code to call an external service that returns your IP address.</li> </ol>	AWS administrator

Task	Description	Skills required
	2. Verify that the returned IP address matches one of your Elastic IP addresses.	

## Related resources

- [Configuring a Lambda function to access resources in a VPC](#)

# Identify duplicate container images automatically when migrating to an Amazon ECR repository

Created by Rishabh Yadav (AWS) and Rishi Singla (AWS)

**Code repository:** [automated -solution-to-identify-identical-images-between-various-container-repositories](#)

**Environment:** Production

**Technologies:** Containers & microservices; DevOps; Migration; Modernization

**AWS services:** AWS CodeBuild; AWS CodePipeline; Amazon ECR; AWS CodeCommit

## Summary

The pattern provides an automated solution to identify whether images that are stored in different container repositories are duplicates. This check is useful when you plan to migrate images from other container repositories to Amazon Elastic Container Registry (Amazon ECR).

For foundational information, the pattern also describes the components of a container image, such as the image digest, manifest, and tags. When you plan a migration to Amazon ECR, you might decide to synchronize your container images across container registries by comparing the digests of the images. Before you migrate your container images, you need to check whether these images already exist in the Amazon ECR repository to prevent duplication. However, it can be difficult to detect duplication by comparing image digests, and this might lead to issues in the initial migration phase. This pattern compares the digests of two similar images that are stored in different container registries and explains why the digests vary, to help you compare images accurately.

## Prerequisites and limitations

- An active AWS account
- Access to the [Amazon ECR public registry](#)

- Familiarity with the following AWS services:
  - [AWS CodeCommit](#)
  - [AWS CodePipeline](#)
  - [AWS CodeBuild](#)
  - [AWS Identity and Access Management \(IAM\)](#)
  - [Amazon Simple Storage Service \(Amazon S3\)](#)
- Configured CodeCommit credentials (see [instructions](#))

## Architecture

### Container image components

The following diagram illustrates some of the components of a container image. These components are described after the diagram.

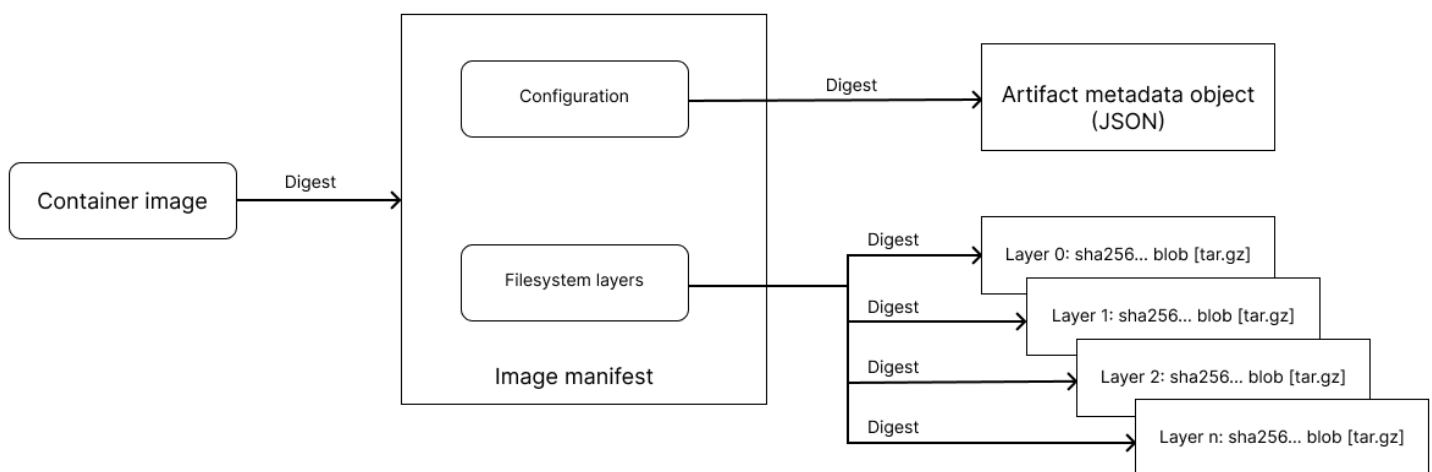

### Terms and definitions

The following terms are defined in the [Open Container Initiative \(OCI\) Image Specification](#).

- **Registry:** A service for image storage and management.
- **Client:** A tool that communicates with registries and works with local images.
- **Push:** The process for uploading images to a registry.
- **Pull:** The process for downloading images from a registry.
- **Blob:** The binary form of content that is stored by a registry and can be addressed by a digest.



- **Index:** A construct that identifies multiple image manifests for different computer platforms (such as x86-64 or ARM 64-bit) or media types. For more information, see the [OCI Image Index Specification](#).
- **Manifest:** A JSON document that defines an image or artifact that is uploaded through the manifest's endpoint. A manifest can reference other blobs in a repository by using descriptors. For more information, see the [OCI Image Manifest Specification](#).
- **Filesystem layer:** System libraries and other dependencies for an image.
- **Configuration:** A blob that contains artifact metadata and is referenced in the manifest. For more information, see the [OCI Image Configuration Specification](#).
- **Object or artifact:** A conceptual content item that's stored as a blob and associated with an accompanying manifest with a configuration.
- **Digest:** A unique identifier that's created from a cryptographic hash of the contents of a manifest. The image digest helps uniquely identify an immutable container image. When you pull an image by using its digest, you will download the same image every time on any operating system or architecture. For more information, see the [OCI Image Specification](#).
- **Tag:** A human-readable manifest identifier. Compared with image digests, which are immutable, tags are dynamic. A tag that points to an image can change and move from one image to another, although the underlying image digest remains the same.

## Target architecture

The following diagram displays the high-level architecture of the solution provided by this pattern to identify duplicate container images by comparing images that are stored in Amazon ECR and private repositories.

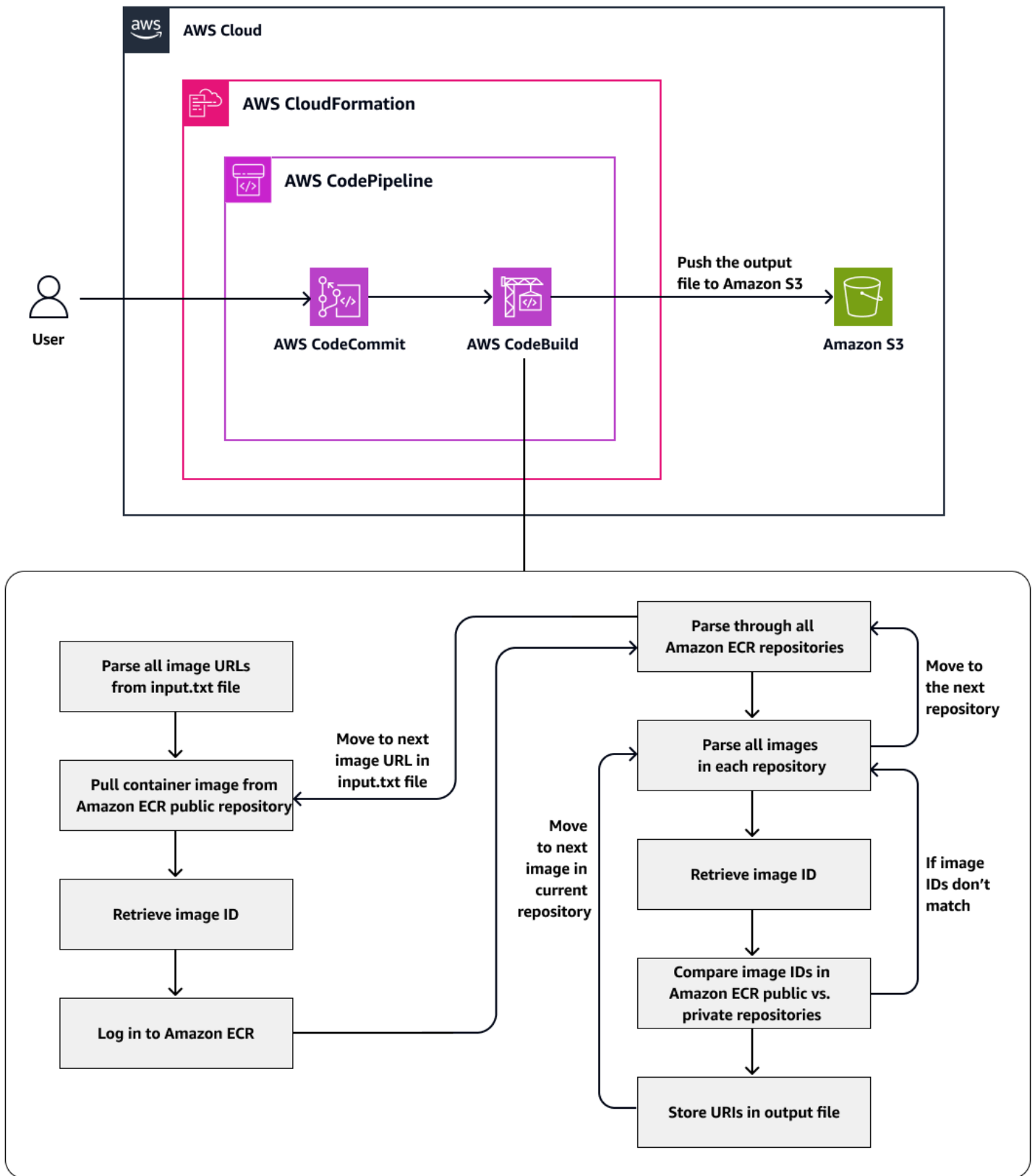

## Tools

### AWS services

- [AWS CloudFormation](#) helps you set up AWS resources, provision them quickly and consistently, and manage them throughout their lifecycle across AWS accounts and Regions.
- [AWS CodeBuild](#) is a fully managed build service that helps you compile source code, run unit tests, and produce artifacts that are ready to deploy.
- [AWS CodeCommit](#) is a version control service that helps you privately store and manage Git repositories, without needing to manage your own source control system.
- [AWS CodePipeline](#) helps you quickly model and configure the different stages of a software release and automate the steps required to release software changes continuously.
- [Amazon Elastic Container Registry \(Amazon ECR\)](#) is a managed container image registry service that's secure, scalable, and reliable.

### Code

The code for this pattern is available in the GitHub repository [Automated solution to identify duplicate container images between repositories](#).

### Best practices

- [AWS CloudFormation best practices](#)
- [AWS CodePipeline best practices](#)

## Epics

### Pull container images from Amazon ECR public and private repositories

Task	Description	Skills required
Pull an image from the Amazon ECR public repository.	From the terminal, run the following command to pull the image <code>amazonlinux</code> from the Amazon ECR public repository.	App developer, AWS DevOps, AWS administrator

Task	Description	Skills required
	<pre data-bbox="609 226 1015 409">\$~ % docker pull public.ecr.aws/ama zonlinux/amazonlin ux:2018.03</pre> <p data-bbox="592 445 1015 672">When the image has been pulled to your local machine, you'll see the following pull digest, which represents the image index.</p> <pre data-bbox="609 724 1015 1522">2018.03: Pulling from amazonlinux/amazon linux 4ddc0f8d367f: Pull complete  Digest: sha256:f9 72d24199508c52de7a d37a298bda35d8a1bd 7df158149b381c03f6 c6e363b5  Status: Downloade d newer image for public.ecr.aws/ama zonlinux/amazonlin ux:2018.03 public.ecr.aws/a mazonlinux/amazonl inux:2018.03</pre>	

Task	Description	Skills required
Push the image to an Amazon ECR private repository.	<ol style="list-style-type: none"><li data-bbox="591 226 1024 506">1. Create a private Amazon ECR repository named <code>test_ecr_repository</code> in the US East (N. Virginia) Region (<code>us-east-1</code>).</li></ol> <pre data-bbox="634 537 1029 936">\$~ % aws ecr get-login \   -password --region \   us-east-1   docker \   login --username \   AWS --password-stdin \   &lt;account-id&gt;.dkr.e \   cr.us-east-1.amazo \   naws.com \   Login Succeeded</pre> <p data-bbox="630 974 956 1104">where <code>&lt;account-id&gt;</code> refers to your AWS account.</p> <ol style="list-style-type: none"><li data-bbox="591 1129 1024 1499">2. Tag the local image that you pulled previously. Use the value <code>public.ecr.aws/amazonlinux/amazonlinux:2018.03</code> and push it to the Amazon ECR private repository.</li></ol> <pre data-bbox="634 1535 1029 1869">\$~ % docker tag \   public.ecr.aws/ama \   zonlinux/amazonlin \   ux:2018.03 &lt;account- \   id&gt;.dkr.ecr.us-eas \   t-1.amazonaws.com/ \   test_ecr_repositor \   y:latest</pre>	AWS administrator, AWS DevOps, App developer

Task	Description	Skills required
	<pre data-bbox="634 247 1027 464"> \$~ % docker push   &lt;account-id&gt;.dkr.ecr.us-east-1.amazonaws.com/test_ecr_repository:latest                     </pre> <p data-bbox="630 506 1032 730">When you push the image to the Amazon ECR repository, Docker will push the underlying image and not the image index.</p> <pre data-bbox="634 772 1027 1276"> The push refers to repository [&lt;account-id&gt;.dkr.ecr.us-east-1.amazonaws.com/test_ecr_repository] d5655967c2c4: Pushed latest: digest:   sha256:52db9000073d93b9bdee6a7246a68c35a741aaade05a8f4febba0bf795cdac02   size: 529                     </pre>	

Task	Description	Skills required
<p>Pull the same image from the Amazon ECR private repository.</p>	<p>1. From the terminal, run the following command to pull the image that you previously pushed to the Amazon ECR private repository.</p> <pre data-bbox="630 535 1029 1451">\$~ % docker pull &lt;account-id&gt;.dkr.ecr.us-east-1.amazonaws.com/test_ecr_repository:latest latest: Pulling from test_ecr_repository Digest: sha256:52db9000073d93b9bdee6a7246a68c35a741aaade05a8f4febba0bf795cdac02 Status: Image is up to date for &lt;account-id&gt;.dkr.ecr.us-east-1.amazonaws.com/test_ecr_repository:latest &lt;account-id&gt;.dkr.ecr.us-east-1.amazonaws.com/test_ecr_repository:latest</pre> <p>The digest for this image matches the digest of the image that you pushed to the Amazon ECR private repository, and represents the underlying image. This value doesn't match the image index that you</p>	<p>App developer, AWS DevOps, AWS administrator</p>

Task	Description	Skills required
	<p>pulled from the public repository.</p> <p>2. To verify, retrieve the image index by digest.</p> <pre data-bbox="634 436 1029 1839"> curl -k -H "Authorization: Bearer \$TOKEN" https://public.ecr.aws/v2/amazonlinux/amazonlinux/manifests/sha256:f972d24199508c52de7ad37a298bda35d8a1bd7df158149b381c03f6c6e363b55 {   "schemaVersion": 2,   "mediaType": "application/vnd.docker.distribution.manifest.list.v2+json",   "manifests": [     {       "mediaType": "application/vnd.docker.distribution.manifest.v2+json",       "size": 529,       "digest": "sha256:52db9000073d93b9bdee6a7246a68c35a741aaade05a8f4febba0bf795cdac02",       "platform": {         "architecture": "amd64", </pre>	



Task	Description	Skills required
	<pre> "linux"       "os":         }       }     ]   } </pre>	

## Compare the image manifests

Task	Description	Skills required
<p>Find the manifest of the image stored in the Amazon ECR public repository.</p>	<p>From the terminal, run the following command to pull the manifest of the image <code>public.ecr.aws/amazonlinux/amazonlinux:2018.03</code> from the Amazon ECR public repository.</p> <pre> \$~ % docker manifest inspect public.ecr.aws/amazonlinux/amazonlinux:2018.03 {   "schemaVersion": 2,   "mediaType": "application/vnd.docker.distribution.manifest.list.v2+json",   "manifests": [     {       "mediaType": "application/vnd.docker.distribution.manifest.v2+json",       "size": 529, </pre>	<p>AWS administrator, AWS DevOps, App developer</p>

Task	Description	Skills required
	<pre>        "digest":           "sha256:52db900007           3d93b9bdee6a7246a6           8c35a741aaade05a8f           4febba0bf795cdac02",           "platform": {             "architec             ture": "amd64",             "os":               "linux"           }         ]       }</pre>	

Task	Description	Skills required
Find the manifest of the image stored in the Amazon ECR private repository.	<p>From the terminal, run the following command to pull the manifest of the image &lt;account-id&gt;.dkr.ecr.us-east-1.amazonaws.com/test_ecr_repository:latest from the Amazon ECR private repository.</p> <pre data-bbox="597 684 1026 1808">\$~ % docker manifest inspect &lt;account-id&gt;.dkr.ecr.us-east-1.amazonaws.com/test_ecr_repository:latest</pre> <pre data-bbox="613 1024 1010 1808">{  "schemaVersion": 2,  "mediaType": "application/vnd.docker.distribution.manifest.v2+json",  "config": {    "mediaType": "application/vnd.docker.container.image.v1+json",    "size": 1477,    "digest": "sha256:f7cee5e1af28ad4e147589c474d399b12d9b551ef4c3e11e02d982fce5eebc68"  },  "layers": [    {</pre>	AWS DevOps, AWS systems administrator, App developer

Task	Description	Skills required
	<pre>"mediaType":   "application/vnd.docker.image.rootfs   .diff.tar.gzip",   "size": 62267075,   "digest": "sha256:4   ddc0f8d367f424871a   060e2067749f32bd36   a91085e714dcb15995   2f2d71453"   }   ]   }</pre>	

Task	Description	Skills required
<p>Compare the digest pulled by Docker with the manifest digest for the image in the Amazon ECR private repository.</p>	<p>Another question is why the digest provided by the <b>docker pull</b> command differs from the manifest's digest for the image <code>&lt;account-id&gt;.dkr.ecr.us-east-1.amazonaws.com/test_ecr_repository:latest</code>.</p> <p>The digest used for <b>docker pull</b> represents the digest of the image manifest, which is stored in a registry. This digest is considered the root of a hash chain, because the manifest contains the hash of the content that will be downloaded and imported into Docker.</p> <p>The image ID used within Docker can be found in this manifest as <code>config.digest</code>. This represents the image configuration that Docker uses. So you could say that the manifest is the envelope, and the image is the content of the envelope. The manifest digest is always different from the image ID. However, a specific manifest should always produce the same image ID. Because the</p>	<p>AWS DevOps, AWS systems administrator, App developer</p>

Task	Description	Skills required
	<p>manifest digest is a hash chain, we cannot guarantee that it will always be the same for a given image ID. In most cases, it produces the same digest, although Docker cannot guarantee that. The possible difference in the manifest digest stems from Docker not storing the blobs that are compressed with gzip locally. Therefore, exporting layers might produce a different digest, although the uncompressed content remains the same. The image ID verifies that uncompressed content is the same; that is, the image ID is now a content addressable identifier (chainID).</p> <p>To confirm this information, you can compare the output of the <b>docker inspect</b> command on the Amazon ECR public and private repositories:</p> <ol style="list-style-type: none"><li>1. Run the following command from your terminal for the image stored in the Amazon ECR public repository.</li></ol>	

Task	Description	Skills required
	<pre data-bbox="633 210 1023 409">\$~ % docker inspect public.ecr.aws/amazonlinux/amazonlinux:2018.03</pre> <p data-bbox="630 441 961 619">For the output from the command, see the <a href="#">Additional information</a> section.</p> <p data-bbox="592 640 1006 871">2. Run the following command from your terminal for the image stored in the Amazon ECR private repository.</p> <pre data-bbox="633 903 1023 1144">\$~ % docker inspect &lt;account-id&gt;.dkr.ecr.us-east-1.amazonaws.com/test_ecr_repository:latest</pre> <p data-bbox="630 1176 961 1354">For the output from the command, see the <a href="#">Additional information</a> section.</p> <p data-bbox="592 1438 1006 1564">The results verify that both images have the same image ID digest and layer digest.</p> <pre data-bbox="592 1606 982 1795">ID: f7cee5e1af28ad4e147589c474d399b12d9b551ef4c3e11e02d982fce5eebc68</pre>	

Task	Description	Skills required
	<p>Layers: d5655967c 2c4e8d68f8ec7cf753 218938669e6c16ac13 24303c073c736a2e2a2</p> <p>Additionally, the digests are based on the bytes of the object that's managed locally (the local file is a tar of the container image layer) or the blob that's pushed to the registry server. However, when you push the blob to a registry, the tar is compressed and the digest is computed in the compressed tar file. Therefore, the difference in the <b>docker pull</b> digest value arises from compression that is applied at the registry (Amazon ECR private or public) level.</p> <p><b>Note:</b> This explanation is specific to using a Docker client. You won't see this behavior with other clients such as <b>nerdctl</b> or <b>Finch</b>, because they don't automatically compress the image during push and pull operations.</p>	



## Automatically identify duplicate images between Amazon ECR public and private repositories

Task	Description	Skills required
Clone the repository.	<p>Clone the Github repository for this pattern into a local folder:</p> <pre data-bbox="594 499 1027 816">\$git clone https://github.com/aws-samples/automated-solution-to-identify-duplicate-container-images-between-repositories</pre>	AWS administrator, AWS DevOps
Set up a CI/CD pipeline.	<p>The GitHub repository includes a <code>.yaml</code> file that creates an AWS CloudFormation stack to set up a pipeline in AWS CodePipeline.</p> <ol style="list-style-type: none"><li>1. Sign in to the AWS Management Console and open the <a href="#">AWS CloudFormation console</a>.</li><li>2. Create a stack by using the template <code>pipeline.yaml</code> file, which is in the code folder in the cloned repository.</li><li>3. Accept or change the default values of parameters. Specify values for the following:<ul style="list-style-type: none"><li>• Stack name</li></ul></li></ol>	AWS administrator, AWS DevOps

Task	Description	Skills required
	<ul style="list-style-type: none"><li>• <code>ArtifactStoreBucketName</code> – An existing S3 bucket that will be used to store AWS CodePipeline artifacts</li><li>• <code>OutputBucket</code> – An existing S3 bucket that will be used to store the URIs for the duplicate images</li><li>• <code>SourceImageFile</code> – An existing text file named <code>input.txt</code> that contains the image URIs from the public repository that will be checked against the Amazon ECR private repository to detect duplication</li></ul> <p>4. Review and adjust stack options, and then choose <b>Submit</b> to run the template.</p> <p>The pipeline will be set up with two stages (<code>CodeCommit</code> and <code>CodeBuild</code>, as shown in the architecture diagram) to identify images in the private repository that also exist in the public repository. The pipeline is configured with the following resources:</p>	

Task	Description	Skills required
	<ul style="list-style-type: none"><li>• CodePipeline for the orchestration of the deployment pipeline.</li><li>• A CodeCommit repository to store the bash script and input file. The bash script is used to compare the container image IDs in the public and private repositories to find duplications. This check is performed across all the repositories in the specified AWS account in a single AWS Region.</li><li>• A CodeBuild project to invoke the bash script to identify images that are already present in the Amazon ECR repository.</li><li>• Necessary IAM roles to allow access.</li><li>• An S3 bucket to store the output file that contains image URIs.</li><li>• Another S3 bucket to store CodePipeline artifacts.</li></ul>	

Task	Description	Skills required
Populate the CodeCommit repository.	<p>To populate the CodeCommit repository, perform these steps:</p> <ol style="list-style-type: none"><li>1. Open the <a href="#">CodeCommit console</a> and navigate to the AWS Region where you created the CloudFormation stack.</li><li>2. Find the repository that you provisioned by using the CloudFormation script from the list, choose <b>Clone URL</b>, and then copy the <b>HTTPS URL</b> protocol to connect to the repository.</li><li>3. Open a command prompt and run the <b>git clone</b> command with the HTTPS URL that you copied in the previous step.</li><li>4. Navigate to the root directory. Create a file named <code>input.txt</code> and populate this file with the Amazon ECR public image registry URIs that you would like to search for in the private Amazon ECR repository.</li><li>5. Copy the files <code>script.sh</code>, <code>buildspec.yml</code>, and <code>input.txt</code> from your local copy of the GitHub</li></ol>	AWS administrator, AWS DevOps

Task	Description	Skills required
	<p>repository <a href="#">Automated solution to identify duplicate container images between repositories</a> to the cloned CodeCommit repository.</p> <p>6. Upload the files to CodeCommit by using these commands:</p> <pre data-bbox="630 674 1029 873">git add . git commit -m "added input files" git push</pre>	
Clean up.	<p>To avoid incurring future charges, delete the resources by following these steps:</p> <ol style="list-style-type: none"><li>1. Navigate to the S3 bucket that stores the CodePipeline artifacts, and empty the bucket.</li><li>2. Navigate to the S3 bucket that stores the duplicate image URIs, and empty the bucket.</li><li>3. Navigate to the CloudFormation console and delete the stack that you created to set up the pipeline.</li></ol>	AWS administrator

## Troubleshooting

Issue	Solution
<p>When you try to push, pull, or otherwise interact with a CodeCommit repository from the terminal or command line, you are prompted to provide a user name and password, and you must supply the Git credentials for your IAM user.</p>	<p>The most common causes for this error are the following:</p> <ul style="list-style-type: none"><li>• Your local computer is running an operating system that doesn't support credential management, or it doesn't have a credential management utility installed.</li><li>• The Git credentials for your IAM user haven't been saved to one of these credential management systems.</li></ul> <p>Depending on your operating system and local environment, you might need to install a credential manager, configure the credential manager that is included in your operating system, or customize your local environment to use credential storage. For example, if your computer is running macOS, you can use the Keychain Access utility to store your credentials. If your computer is running Windows, you can use the Git Credential Manager that is installed with Git for Windows. For more information, see <a href="#">Setup for HTTPS users using Git credentials</a> in the CodeCommit documentation and <a href="#">Credential Storage</a> in the Git documentation.</p>
<p>You encounter HTTP 403 or "no basic auth credentials" errors when you push an image to the Amazon ECR repository.</p>	<p>You might encounter these error messages from the <b>docker push</b> or <b>docker pull</b> command, even if you have successfully authenticated to Docker by using the <b>aws ecr</b></p>

Issue	Solution
	<p><b>get-login-password</b> command. Known causes are:</p> <ul style="list-style-type: none"><li>• You have authenticated to a different Region. For more information, see <a href="#">Private registry authentication</a> in the Amazon ECR documentation.</li><li>• You have authenticated to push to a repository that you don't have permissions for. For more information, see <a href="#">Private repository policies</a> in the Amazon ECR documentation.</li><li>• Your token has expired. The default expiration period for tokens obtained by using the <code>GetAuthorizationToken</code> operation is 12 hours.</li></ul>

## Related resources

- [Automated solution to identify duplicate container images between repositories](#) (GitHub repository)
- [Amazon ECR public gallery](#)
- [Private images in Amazon ECR](#) (Amazon ECR documentation)
- [AWS::CodePipeline::Pipeline resource](#) (AWS CloudFormation documentation)
- [OCI Image Format Specification](#)

## Additional information

### Output of Docker inspection for image in Amazon ECR public repository

```
[
  {
    "Id":
      "sha256:f7cee5e1af28ad4e147589c474d399b12d9b551ef4c3e11e02d982fce5eebc68",
```

```

    "RepoTags": [
      "<account-id>.dkr.ecr.us-east-1.amazonaws.com/test_ecr_repository:latest",
      "public.ecr.aws/amazonlinux/amazonlinux:2018.03"
    ],
    "RepoDigests": [
      "<account-id>.dkr.ecr.us-east-1.amazonaws.com/
test_ecr_repository@sha256:52db9000073d93b9bdee6a7246a68c35a741aaade05a8f4febba0bf795cdac02",
      "public.ecr.aws/amazonlinux/
amazonlinux@sha256:f972d24199508c52de7ad37a298bda35d8a1bd7df158149b381c03f6c6e363b5"
    ],
    "Parent": "",
    "Comment": "",
    "Created": "2023-02-23T06:20:11.575053226Z",
    "Container":
"ec7f2fc7d2b6a382384061247ef603e7d647d65f5cd4fa397a3ccbba9278367c",
    "ContainerConfig": {
      "Hostname": "ec7f2fc7d2b6",
      "Domainname": "",
      "User": "",
      "AttachStdin": false,
      "AttachStdout": false,
      "AttachStderr": false,
      "Tty": false,
      "OpenStdin": false,
      "StdinOnce": false,
      "Env": [
        "PATH=/usr/local/sbin:/usr/local/bin:/usr/sbin:/usr/bin:/sbin:/bin"
      ],
      "Cmd": [
        "/bin/sh",
        "-c",
        "#(nop) ",
        "CMD [\"/bin/bash\"]"
      ],
      "Image":
"sha256:c1bced1b5a65681e1e0e52d0a6ad17aaf76606149492ca0bf519a466ecb21e51",
      "Volumes": null,
      "WorkingDir": "",
      "Entrypoint": null,
      "OnBuild": null,
      "Labels": {}
    },
    "DockerVersion": "20.10.17",
    "Author": "",

```



```

    "Config": {
      "Hostname": "",
      "Domainname": "",
      "User": "",
      "AttachStdin": false,
      "AttachStdout": false,
      "AttachStderr": false,
      "Tty": false,
      "OpenStdin": false,
      "StdinOnce": false,
      "Env": [
        "PATH=/usr/local/sbin:/usr/local/bin:/usr/sbin:/usr/bin:/sbin:/bin"
      ],
      "Cmd": [
        "/bin/bash"
      ],
      "Image":
"sha256:c1bced1b5a65681e1e0e52d0a6ad17aaf76606149492ca0bf519a466ecb21e51",
      "Volumes": null,
      "WorkingDir": "",
      "Entrypoint": null,
      "OnBuild": null,
      "Labels": null
    },
    "Architecture": "amd64",
    "Os": "linux",
    "Size": 167436755,
    "VirtualSize": 167436755,
    "GraphDriver": {
      "Data": {
        "MergedDir": "/var/lib/docker/overlay2/
c2c2351a82b26cbdf7782507500e5adb5c2b3a2875bdbba79788a4b27cd6a913/merged",
        "UpperDir": "/var/lib/docker/overlay2/
c2c2351a82b26cbdf7782507500e5adb5c2b3a2875bdbba79788a4b27cd6a913/diff",
        "WorkDir": "/var/lib/docker/overlay2/
c2c2351a82b26cbdf7782507500e5adb5c2b3a2875bdbba79788a4b27cd6a913/work"
      },
      "Name": "overlay2"
    },
    "RootFS": {
      "Type": "layers",
      "Layers": [
"sha256:d5655967c2c4e8d68f8ec7cf753218938669e6c16ac1324303c073c736a2e2a2"

```

```

    ]
  },
  "Metadata": {
    "LastTagTime": "2023-03-02T10:28:47.142155987Z"
  }
}
]

```

## Output of Docker inspection for image in Amazon ECR private repository

```

[
  {
    "Id":
"sha256:f7cee5e1af28ad4e147589c474d399b12d9b551ef4c3e11e02d982fce5eebc68",
    "RepoTags": [
      "<account-id>.dkr.ecr.us-east-1.amazonaws.com/test_ecr_repository:latest",
      "public.ecr.aws/amazonlinux/amazonlinux:2018.03"
    ],
    "RepoDigests": [
      "<account-id>.dkr.ecr.us-east-1.amazonaws.com/
test_ecr_repository@sha256:52db9000073d93b9bdee6a7246a68c35a741aaade05a8f4febba0bf795cdac02",
      "public.ecr.aws/amazonlinux/
amazonlinux@sha256:f972d24199508c52de7ad37a298bda35d8a1bd7df158149b381c03f6c6e363b5"
    ],
    "Parent": "",
    "Comment": "",
    "Created": "2023-02-23T06:20:11.575053226Z",
    "Container":
"ec7f2fc7d2b6a382384061247ef603e7d647d65f5cd4fa397a3ccbba9278367c",
    "ContainerConfig": {
      "Hostname": "ec7f2fc7d2b6",
      "Domainname": "",
      "User": "",
      "AttachStdin": false,
      "AttachStdout": false,
      "AttachStderr": false,
      "Tty": false,
      "OpenStdin": false,
      "StdinOnce": false,
      "Env": [
        "PATH=/usr/local/sbin:/usr/local/bin:/usr/sbin:/usr/bin:/sbin:/bin"
      ],
      "Cmd": [

```

```

        "/bin/sh",
        "-c",
        "#(nop) ",
        "CMD [\"/bin/bash\"]"
    ],
    "Image":
"sha256:c1bced1b5a65681e1e0e52d0a6ad17aaf76606149492ca0bf519a466ecb21e51",
    "Volumes": null,
    "WorkingDir": "",
    "Entrypoint": null,
    "OnBuild": null,
    "Labels": {}
},
"DockerVersion": "20.10.17",
"Author": "",
"Config": {
    "Hostname": "",
    "Domainname": "",
    "User": "",
    "AttachStdin": false,
    "AttachStdout": false,
    "AttachStderr": false,
    "Tty": false,
    "OpenStdin": false,
    "StdinOnce": false,
    "Env": [
        "PATH=/usr/local/sbin:/usr/local/bin:/usr/sbin:/usr/bin:/sbin:/bin"
    ],
    "Cmd": [
        "/bin/bash"
    ],
    "Image":
"sha256:c1bced1b5a65681e1e0e52d0a6ad17aaf76606149492ca0bf519a466ecb21e51",
    "Volumes": null,
    "WorkingDir": "",
    "Entrypoint": null,
    "OnBuild": null,
    "Labels": null
},
"Architecture": "amd64",
"Os": "linux",
"Size": 167436755,
"VirtualSize": 167436755,
"GraphDriver": {

```

```
    "Data": {
      "MergedDir": "/var/lib/docker/overlay2/
c2c2351a82b26cbdf7782507500e5adb5c2b3a2875bdbba79788a4b27cd6a913/merged",
      "UpperDir": "/var/lib/docker/overlay2/
c2c2351a82b26cbdf7782507500e5adb5c2b3a2875bdbba79788a4b27cd6a913/diff",
      "WorkDir": "/var/lib/docker/overlay2/
c2c2351a82b26cbdf7782507500e5adb5c2b3a2875bdbba79788a4b27cd6a913/work"
    },
    "Name": "overlay2"
  },
  "RootFS": {
    "Type": "layers",
    "Layers": [

"sha256:d5655967c2c4e8d68f8ec7cf753218938669e6c16ac1324303c073c736a2e2a2"
    ]
  },
  "Metadata": {
    "LastTagTime": "2023-03-02T10:28:47.142155987Z"
  }
}
]
```

# Install SSM Agent on Amazon EKS worker nodes by using Kubernetes DaemonSet

*Created by Mahendra Revanasiddappa (AWS)*

**Environment:** PoC or pilot

**Technologies:** Containers & microservices; DevOps; Infrastructure

**AWS services:** Amazon EKS; AWS Systems Manager

## Summary

**Note, September 2021:** The latest Amazon EKS optimized AMIs install SSM Agent automatically. For more information, see the [release notes](#) for the June 2021 AMIs.

In Amazon Elastic Kubernetes Service (Amazon EKS), because of security guidelines, worker nodes don't have Secure Shell (SSH) key pairs attached to them. This pattern shows how you can use the Kubernetes DaemonSet resource type to install AWS Systems Manager Agent (SSM Agent) on all worker nodes, instead of installing it manually or replacing the Amazon Machine Image (AMI) for the nodes. DaemonSet uses a cron job on the worker node to schedule the installation of SSM Agent. You can also use this pattern to install other packages on worker nodes.

When you're troubleshooting issues in the cluster, installing SSM Agent on demand enables you to establish an SSH session with the worker node, to collect logs or to look into instance configuration, without SSH key pairs.

## Prerequisites and limitations

### Prerequisites

- An existing Amazon EKS cluster with Amazon Elastic Compute Cloud (Amazon EC2) worker nodes.
- Container instances should have the required permissions to communicate with the SSM service. The AWS Identity and Access Management (IAM) managed role **AmazonSSMManagedInstanceCore** provides the required permissions for SSM Agent to run on EC2 instances. For more information, see the [AWS Systems Manager documentation](#).

## Limitations

- This pattern isn't applicable to AWS Fargate, because DaemonSets aren't supported on the Fargate platform.
- This pattern applies only to Linux-based worker nodes.
- The DaemonSet pods run in privileged mode. If the Amazon EKS cluster has a webhook that blocks pods in privileged mode, the SSM Agent will not be installed.

## Architecture

The following diagram illustrates the architecture for this pattern.

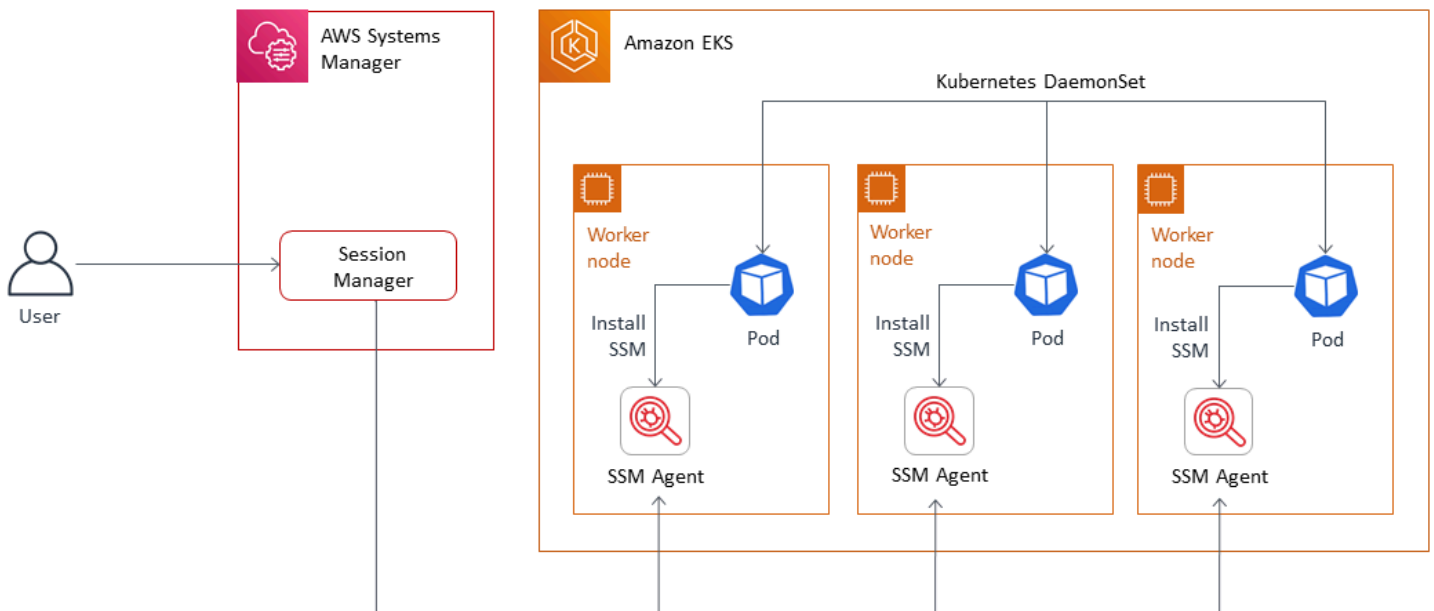

## Tools

### Tools

- [kubect1](#) is a command-line utility that is used to interact with an Amazon EKS cluster. This pattern uses `kubect1` to deploy a DaemonSet on the Amazon EKS cluster, which will install SSM Agent on all worker nodes.
- [Amazon EKS](#) makes it easy for you to run Kubernetes on AWS without having to install, operate, and maintain your own Kubernetes control plane or nodes. Kubernetes is an open-source system for automating the deployment, scaling, and management of containerized applications.

- [AWS Systems Manager Session Manager](#) lets you manage your EC2 instances, on-premises instances, and virtual machines (VMs) through an interactive, one-click, browser-based shell or through the AWS Command Line Interface (AWS CLI).

## Code

Use the following code to create a DaemonSet configuration file that will install SSM Agent on the Amazon EKS cluster. Follow the instructions in the [Epics](#) section.

```
cat << EOF > ssm_daemonset.yaml
apiVersion: apps/v1
kind: DaemonSet
metadata:
  labels:
    k8s-app: ssm-installer
  name: ssm-installer
  namespace: kube-system
spec:
  selector:
    matchLabels:
      k8s-app: ssm-installer
  template:
    metadata:
      labels:
        k8s-app: ssm-installer
    spec:
      containers:
        - name: sleeper
          image: busybox
          command: ['sh', '-c', 'echo I keep things running! && sleep 3600']
      initContainers:
        - image: amazonlinux
          imagePullPolicy: Always
          name: ssm
          command: ["/bin/bash"]
          args: ["-c", "echo '* * * * * root yum install -y https://s3.amazonaws.com/ec2-downloads-windows/SSMAgent/latest/linux_amd64/amazon-ssm-agent.rpm & rm -rf /etc/cron.d/ssmstart' > /etc/cron.d/ssmstart"]
          securityContext:
            allowPrivilegeEscalation: true
      volumeMounts:
        - mountPath: /etc/cron.d
```

```

    name: cronfile
    terminationMessagePath: /dev/termination-log
    terminationMessagePolicy: File
volumes:
- name: cronfile
  hostPath:
    path: /etc/cron.d
    type: Directory
dnsPolicy: ClusterFirst
restartPolicy: Always
schedulerName: default-scheduler
terminationGracePeriodSeconds: 30

```

EOF

## Epics

### Set up kubectl

Task	Description	Skills required
Install and configure kubectl to access the EKS cluster.	If kubectl isn't already installed and configured to access the Amazon EKS cluster, see <a href="#">Installing kubectl</a> in the Amazon EKS documentation.	DevOps

### Deploy the DaemonSet

Task	Description	Skills required
Create the DaemonSet configuration file.	Use the code in the <a href="#">Code</a> section earlier in this pattern to create a DaemonSet configuration file called <code>ssm_daemonset.yaml</code> , which will be	DevOps



Task	Description	Skills required
	<p>deployed to the Amazon EKS cluster.</p> <p>The pod launched by DaemonSet has a main container and an <code>init</code> container. The main container has a <code>sleep</code> command. The <code>init</code> container includes a <code>command</code> section that creates a cron job file to install SSM Agent at the path <code>/etc/cron.d/</code> . The cron job runs only once, and the file it creates is automatically deleted after the job is complete.</p> <p>When the <code>init</code> container has finished, the main container waits for 60 minutes before exiting. After 60 minutes, a new pod is launched. This pod installs SSM Agent, if it's missing, or updates SSM Agent to the latest version.</p> <p>If required, you can modify the <code>sleep</code> command to restart the pod once a day or to run more often.</p>	

Task	Description	Skills required
Deploy the DaemonSet on the Amazon EKS cluster.	<p>To deploy the DaemonSet configuration file you created in the previous step on the Amazon EKS cluster, use the following command:</p> <pre data-bbox="594 489 1027 606">kubect1 apply -f   ssm_daemonset.yaml</pre> <p>This command creates a DaemonSet to run the pods on worker nodes to install SSM Agent.</p>	DevOps

## Related resources

- [Installing kubect1](#) (Amazon EKS documentation)
- [Setting up Session Manager](#) (AWS Systems Manager documentation)

# Install the SSM Agent and CloudWatch agent on Amazon EKS worker nodes using preBootstrapCommands

Created by Akkamahadevi Hiremath (AWS)

**Environment:** Production

**Technologies:** Containers & microservices; Infrastructure; Operations

**AWS services:** Amazon EKS; AWS Systems Manager; Amazon CloudWatch

## Summary

This pattern provides code samples and steps to install the AWS Systems Manager Agent (SSM Agent) and Amazon CloudWatch agent on Amazon Elastic Kubernetes Service (Amazon EKS) worker nodes in the Amazon Web Services (AWS) Cloud during Amazon EKS cluster creation. You can install the SSM Agent and CloudWatch agent by using the `preBootstrapCommands` property from the `eksctl` [config file schema](#) (Weaveworks documentation). Then, you can use the SSM Agent to connect to your worker nodes without using an Amazon Elastic Compute Cloud (Amazon EC2) key pair. Additionally, you can use the CloudWatch agent to monitor memory and disk utilization on your Amazon EKS worker nodes.

## Prerequisites and limitations

### Prerequisites

- An active AWS account
- The [eksctl command line utility](#), installed and configured on macOS, Linux, or Windows
- The [kubectrl command line utility](#), installed and configured on macOS, Linux, or Windows

### Limitations

- We recommend that you avoid adding long-running scripts to the `preBootstrapCommands` property, because this delays the node from joining the Amazon EKS cluster during scaling activities. We recommend that you create a [custom Amazon Machine Image \(AMI\)](#) instead.
- This pattern applies to Amazon EC2 Linux instances only.

# Architecture

## Technology stack

- Amazon CloudWatch
- Amazon Elastic Kubernetes Service (Amazon EKS)
- AWS Systems Manager Parameter Store

## Target architecture

The following diagram shows an example of a user connecting to Amazon EKS worker nodes using SSM Agent which was installed using the `preBootstrapCommands`.

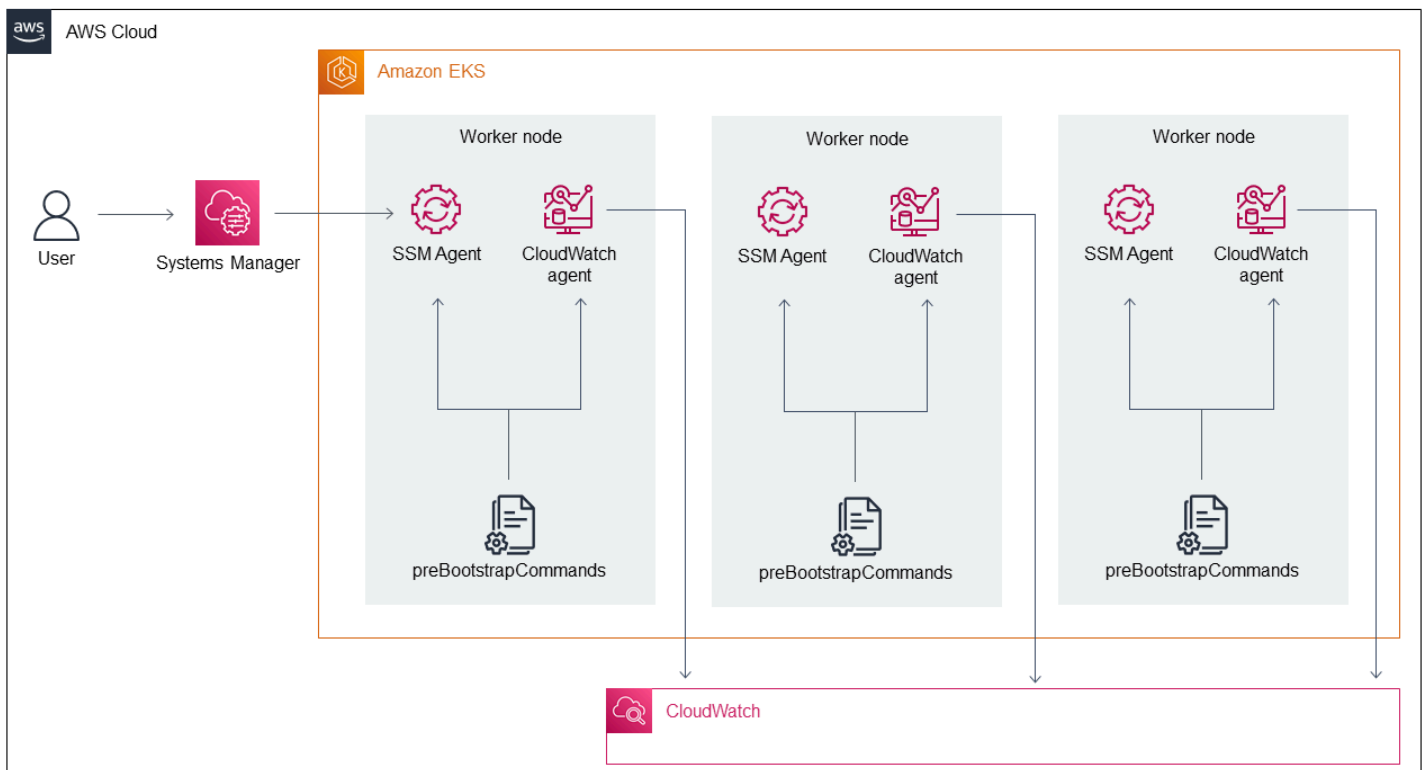

The diagram shows the following workflow:

1. The user creates an Amazon EKS cluster by using the `eksctl` configuration file with the `preBootstrapCommands` property, which installs the SSM Agent and CloudWatch agent.
2. Any new instances that join the cluster later due to scaling activities get created with the pre-installed SSM Agent and CloudWatch agent.

3. The user connects to Amazon EC2 by using the SSM Agent and then monitors memory and disk utilization by using the CloudWatch agent.

## Tools

- [Amazon CloudWatch](#) helps you monitor the metrics of your AWS resources and the applications that you run on AWS in real time.
- [Amazon Elastic Kubernetes Service \(Amazon EKS\)](#) helps you run Kubernetes on AWS without needing to install or maintain your own Kubernetes control plane or nodes.
- [AWS Systems Manager Parameter Store](#) provides secure, hierarchical storage for configuration data management and secrets management.
- [AWS Systems Manager Session Manager](#) helps you manage your EC2 instances, on-premises instances, and virtual machines through an interactive, one-click, browser-based shell or through the AWS Command Line Interface (AWS CLI).
- [eksctl](#) is a command-line utility for creating and managing Kubernetes clusters on Amazon EKS.
- [kubectx](#) is a command-line utility for communicating with the cluster API server.

## Epics

### Create an Amazon EKS cluster

Task	Description	Skills required
Store the CloudWatch agent configuration file.	Store the CloudWatch agent configuration file in the <a href="#">AWS Systems Manager Parameter Store</a> in the AWS Region where you want to create your Amazon EKS cluster. To do this, <a href="#">create a parameter</a> in AWS Systems Manager Parameter Store and note the name of the parameter (for example, AmazonCloudwatch-linux ).	DevOps engineer

Task	Description	Skills required
	<p>For more information, see the <i>Example CloudWatch agent configuration file</i> code in the <a href="#">Additional information</a> section of this pattern.</p>	
<p>Create the eksctl configuration file and cluster.</p>	<ol style="list-style-type: none"> <li>1. Create an eksctl configuration file that includes the CloudWatch agent and SSM Agent installation steps. For more information, see the <i>Example eksctl configuration file</i> code in the <a href="#">Additional information</a> section of this pattern.</li> <li>2. Create a cluster by running the <code>eksctl create cluster -f cluster.yaml</code> command.</li> </ol>	<p>AWS DevOps</p>

### Verify that the SSM Agent and CloudWatch agent work

Task	Description	Skills required
<p>Test the SSM Agent.</p>	<p>Use SSH to connect to your Amazon EKS cluster nodes by using any of the methods covered in <a href="#">Start a session</a> from the AWS Systems Manager documentation.</p>	<p>AWS DevOps</p>
<p>Test the CloudWatch agent.</p>	<p>Use the CloudWatch console to validate the CloudWatch agent:</p>	<p>AWS DevOps</p>

Task	Description	Skills required
	<ol style="list-style-type: none"><li>1. Sign in to the AWS Management Console and open the <a href="#">CloudWatch console</a>.</li><li>2. On the navigation pane, expand <b>Metrics</b> and then choose <b>All metrics</b>.</li><li>3. In the search box on the <b>Browse</b> tab, enter and then choose <b>CWAgent metrics</b> to see the memory and disk metrics.</li></ol>	

## Related resources

- [Installing and running the CloudWatch agent on your servers](#) (Amazon CloudWatch documentation)
- [Create a Systems Manager parameter \(console\)](#) (AWS Systems Manager documentation)
- [Create the CloudWatch agent configuration file](#) (Amazon CloudWatch documentation)
- [Starting a session \(AWS CLI\)](#) (AWS Systems Manager documentation)
- [Starting a session \(Amazon EC2 console\)](#) (AWS Systems Manager documentation)

## Additional information

### Example CloudWatch agent configuration file

In the following example, the CloudWatch agent is configured to monitor disk and memory utilization on Amazon Linux instances:

```
{
  "agent": {
    "metrics_collection_interval": 60,
    "run_as_user": "cwagent"
  },
}
```

```

"metrics": {
  "append_dimensions": {
    "AutoScalingGroupName": "${aws:AutoScalingGroupName}",
    "ImageId": "${aws:ImageId}",
    "InstanceId": "${aws:InstanceId}",
    "InstanceType": "${aws:InstanceType}"
  },
  "metrics_collected": {
    "disk": {
      "measurement": [
        "used_percent"
      ],
      "metrics_collection_interval": 60,
      "resources": [
        "*"
      ]
    },
    "mem": {
      "measurement": [
        "mem_used_percent"
      ],
      "metrics_collection_interval": 60
    }
  }
}
}

```

## Example eksctl configuration file

```

apiVersion: eksctl.io/v1alpha5
kind: ClusterConfig
metadata:
  name: test
  region: us-east-2
  version: "1.24"
managedNodeGroups:
  - name: test
    minSize: 2
    maxSize: 4
    desiredCapacity: 2
    volumeSize: 20
    instanceType: t3.medium
    preBootstrapCommands:

```



```
- sudo yum install amazon-ssm-agent -y
- sudo systemctl enable amazon-ssm-agent
- sudo systemctl start amazon-ssm-agent
- sudo yum install amazon-cloudwatch-agent -y
- sudo /opt/aws/amazon-cloudwatch-agent/bin/amazon-cloudwatch-agent-ctl -a fetch-
config -m ec2 -s -c ssm:AmazonCloudwatch-linux
iam:
  attachPolicyARNs:
    - arn:aws:iam::aws:policy/AmazonEKSEKSPolicy
    - arn:aws:iam::aws:policy/AmazonEKS_CNI_Policy
    - arn:aws:iam::aws:policy/AmazonEC2ContainerRegistryReadOnly
    - arn:aws:iam::aws:policy/CloudWatchAgentServerPolicy
    - arn:aws:iam::aws:policy/AmazonSSMManagedInstanceCore
```

## Additional code details

- In the last line of the `preBootstrapCommands` property, `AmazonCloudwatch-linux` is the name of the parameter created in AWS System Manager Parameter Store. You must include `AmazonCloudwatch-linux` in Parameter Store in the same AWS Region where you created the Amazon EKS cluster. You can also specify a file path, but we recommend using Systems Manager for easier automation and reusability.
- If you use `preBootstrapCommands` in the `eksctl` configuration file, you see two launch templates in the AWS Management Console. The first launch template includes the commands specified in `preBootstrapCommands`. The second template includes the commands specified in `preBootstrapCommands` and default Amazon EKS user data. This data is required to get the nodes to join the cluster. The node group's Auto Scaling group uses this user data to spin up new instances.
- If you use the `iam` attribute in the `eksctl` configuration file, you must list the default Amazon EKS policies with any additional policies required in your attached AWS Identity and Access Management (IAM) policies. In the code snippet from the *Create the `eksctl` configuration file and cluster* step, `CloudWatchAgentServerPolicy` and `AmazonSSMManagedInstanceCore` are additional policies added to make sure that the CloudWatch agent and SSM Agent work as expected. The `AmazonEKSEKSPolicy`, `AmazonEKS_CNI_Policy`, `AmazonEC2ContainerRegistryReadOnly` policies are mandatory policies required for the Amazon EKS cluster to function correctly.

# Optimize AWS App2Container generated Docker images

Created by Varun Sharma (AWS)

**Environment:** PoC or pilot

**Technologies:** Containers & microservices; Modernization; DevOps

**AWS services:** Amazon ECS

## Summary

AWS App2Container is a command line tool that helps transform existing applications running on premises or on virtual machines into containers, without needing code changes.

Based on application type, App2Container takes a conservative approach to identify dependencies. For process mode, all non-system files on the application server are included in the container image. In such cases, a fairly large image might be generated.

This pattern provides an approach for optimizing the container images generated by App2Container. It is applicable for all Java applications discovered by App2Container in process mode. The workflow defined in the pattern is designed to be run on the application server.

## Prerequisites and limitations

### Prerequisites

- An active AWS account
- A Java application running on an application server on a Linux server
- [App2Container installed and set up](#), with all prerequisites met, on the Linux server

## Architecture

### Source technology stack

- A Java application running on a Linux server

### Target technology stack

- A Docker image generated by App2Container

## Target architecture flow

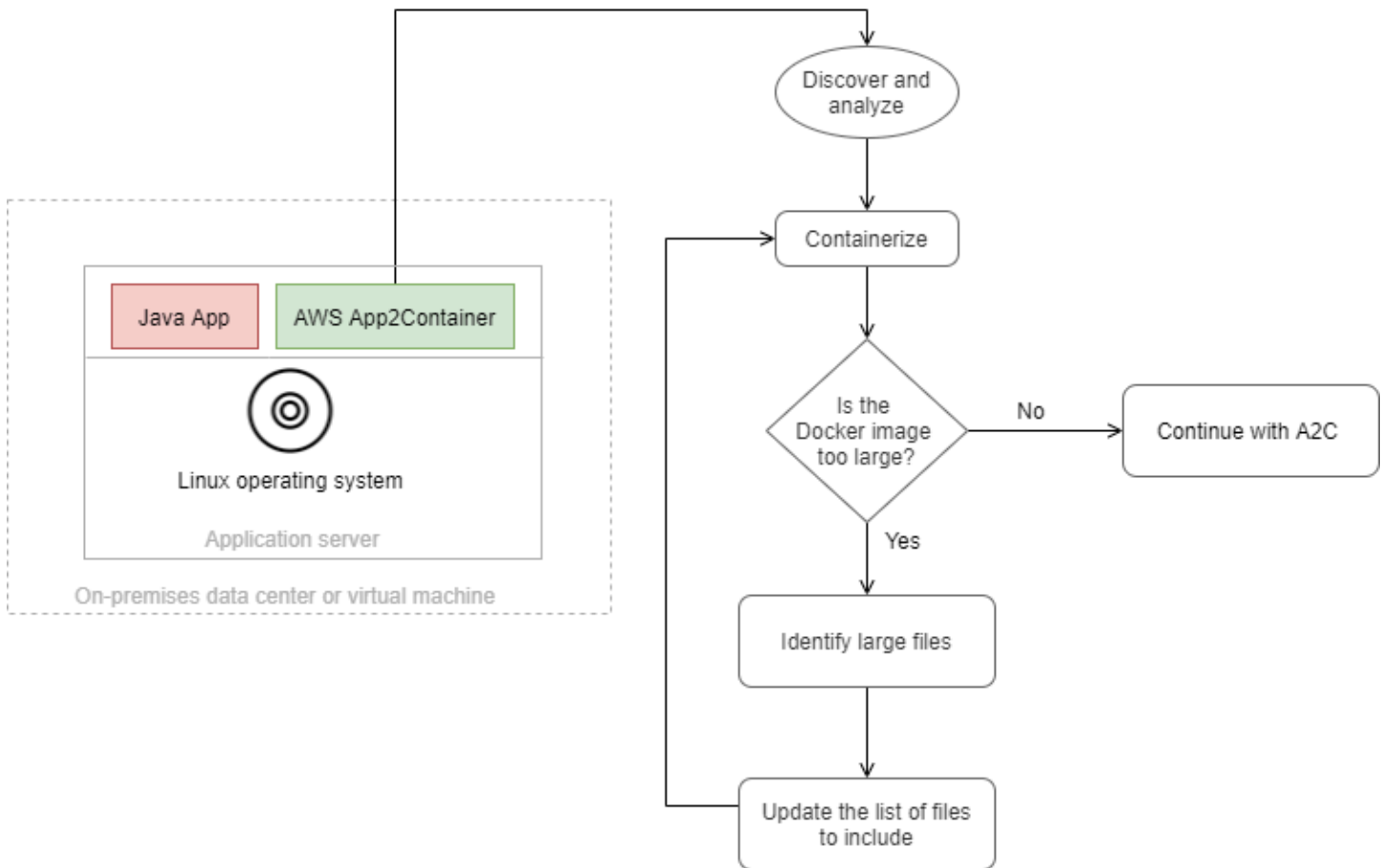

1. Discover the applications that are running on the application server, and analyze the applications.
2. Containerize the applications.
3. Evaluate the size of the Docker image. If the image is too large, continue to step 4.
4. Use the shell script (attached) to identify large files.
5. Update the `appExcludedFiles` and `appSpecificFiles` lists in the `analysis.json` file.

## Tools

### Tools

- [AWS App2Container](#) – AWS App2Container (A2C) is a command line tool to help you lift and shift applications that run in your on-premises data center or on virtual machines, so that they run in containers that are managed by Amazon Elastic Container Service (Amazon ECS) or Amazon Elastic Kubernetes Service (Amazon EKS).

## Code

The `optimizeImage.sh` shell script and an example `analysis.json` file are attached.

The `optimizeImage.sh` file is a utility script for reviewing the contents of the App2Container generated file, `ContainerFiles.tar`. The review identifies files or subdirectories that are large and can be excluded. The script is a wrapper for the following tar command.

```
tar -Ptvf <path>|tr -s ' '|cut -d ' ' -f3,6| awk '$2 ~/<filetype>$/'| awk '$2 ~/^<toplevel>/'| cut -f1-<depth> -d '/'|awk '{ if ($1>= <size>) arr[$2]+=$1 } END { for (key in arr) { if(<verbose>) printf("%-50s\t%-50s\n", key, arr[key]) else printf("%s,\n", key) } } '|sort -k2 -nr
```

In the tar command, the script uses the following values:

<code>path</code>	The path to <code>ContainerFiles.tar</code>
<code>filetype</code>	The file type to match
<code>toplevel</code>	The top-level directory to match
<code>depth</code>	The depth of the absolute path
<code>size</code>	The size for each file

The script does the following:

1. It uses `tar -Ptvf` to list the files without extracting them.
2. It filters the files by file type, starting with the top-level directory.
3. Based on the depth, it generates the absolute path as an index.
4. Based on the index and stores, it provides the total size of the subdirectory.
5. It prints the size of the subdirectory.

You can also replace the values manually in the tar command.

## Epics

### Discover, analyze, and containerize applications

Task	Description	Skills required
Discover the on-premises Java applications.	To discover all applications running on the application server, run the following command. <pre>sudo app2container inventory</pre>	AWS DevOps
Analyze the discovered applications.	To analyze each application by using the application-id that was obtained in the inventory stage, run the following command. <pre>sudo app2container analyze --application-id &lt;java-app-id&gt;</pre>	AWS DevOps
Containerize the analyzed applications.	To containerize an application, run the following command. <pre>sudo app2container containerize --application-id &lt;application-id&gt;</pre> <p>The command generates the Docker image along with a</p>	AWS DevOps

Task	Description	Skills required
	<p>tar bundle in the workspace location.</p> <p>If the Docker image is too large, proceed to the next step.</p>	

### Identify appExcludedFiles and appSpecificFiles from the App2Container extracted tar file

Task	Description	Skills required
Identify the Artifacts tar file size.	<p>Identify the Container Files.tar file in <code>{workspace}/{java-app-id}/Artifacts</code> , where <code>workspace</code> is the App2Container workspace and <code>java-app-id</code> is the application ID.</p> <pre>./optimizeImage.sh -p / {workspace}/{java-app- id}/Artifacts/Containe rFiles.tar -d 0 -t / - v</pre> <p>This is the total size of the tar file after optimization.</p>	AWS DevOps
List the subdirectories under the <code>/</code> directory and their sizes.	<p>To identify the sizes of the major subdirectories under the <code>/</code> top-level directory, run the following command.</p> <pre>./optimizeImage.sh -p / {workspace}/{java-app-</pre>	AWS DevOps

Task	Description	Skills required
	<pre>id}/Artifacts/ContainerFiles.tar -d 1 -t / -s 1000000 -v /var 554144711 /usr 2097300819 /tmp 18579660 /root 43645397 /opt 222320534 /home 65212518 /etc 11357677</pre>	

Task	Description	Skills required
Identify large subdirectories under the / directory.	<p>For each major subdirectory that is listed in the previous command, identify the sizes of its subdirectories. Use <code>-d</code> to increase the depth and <code>-t</code> to indicate the top-level directory.</p> <p>For example, use <code>/var</code> as the top-level directory. Under <code>/var</code>, identify all the large subdirectories and their sizes.</p> <pre>./optimizeImage.sh -p / {workspace}/{java-app- id}/Artifacts/Containe rFiles.tar -d 2 -t / var -s 1000000 -v</pre> <p>Repeat this process for each subdirectory listed in the previous step (for example, <code>/usr</code>, <code>/tmp</code>, <code>/opt</code>, and <code>/home</code>).</p>	AWS DevOps



Task	Description	Skills required
Analyze the large folder in each subdirectory under the / directory.	<p>For each subdirectory that is listed in the previous step, identify any folders that are required to run the application.</p> <p>For example, using the subdirectories from the previous step, list all the subdirectories in the /var directory and their sizes. Identify any subdirectories that are needed by the application.</p> <pre data-bbox="594 905 1027 1182">/var/tmp     237285851 /var/lib     24489984 /var/cache     237285851</pre> <p>To exclude subdirectories that are not needed by the application, in the <code>analysis.json</code> file, add those subdirectories to the <code>appExcludedFiles</code> section under <code>containerParameters</code> .</p> <p>An example <code>analysis.json</code> file is attached.</p>	AWS DevOps

Task	Description	Skills required
Identify files that are needed from the appExcludes list.	<p>For each subdirectory that is added to appExcludes list, identify any files in that subdirectory that are required by the application. In the analysis.json file, add the specific files or subdirectories in the appSpecificFiles section under container Parameters .</p> <p>For example, if the /usr/lib directory is added to the exclude list, but /usr/lib/jvm is needed by the application, add /usr/lib/jvm to the appSpecificFiles section.</p>	AWS DevOps

### Extract and containerize the application again

Task	Description	Skills required
Containerize the analyzed application.	<p>To containerize the application, run the following command.</p> <pre>sudo app2container   containerize --application-id &lt;application-id&gt;</pre> <p>The command generates the Docker image along with a</p>	AWS DevOps

Task	Description	Skills required
	tar bundle in the workspace location.	
Identify the Artifacts tar file size.	<p>Identify the ContainerFiles.tar file in {workspace}/{java-app-id}/Artifacts , where workspace is the App2Container workspace and java-app-id is the application ID.</p> <pre data-bbox="597 747 1027 989"> ./optimizeImage.sh -p / {workspace}/{java-app-id}/Artifacts/ContainerFiles.tar -d 0 -t / -v </pre> <p>This is the total size of the tar file after optimization.</p>	AWS DevOps
Run the Docker image.	<p>To verify that the image starts without errors, run the Docker image locally using the following commands.</p> <p>To identify the imageId of the container, use <code>docker images  grep java-app-id .</code></p> <p>To run the container, use <code>docker run -d &lt;image id&gt;.</code></p>	AWS DevOps

## Related resources

- [What is App2Container?](#)
- [AWS App2Container – A New Containerizing Tool for Java and .NET Applications](#) (blog post)

## Attachments

To access additional content that is associated with this document, unzip the following file:  
[attachment.zip](#)

# Place Kubernetes Pods on Amazon EKS by using node affinity, taints, and tolerations

Created by Hitesh Parikh (AWS) and Raghu Bhamidimarri (AWS)

**Environment:** PoC or pilot

**Technologies:** Containers & microservices

**Workload:** Open-source

**AWS services:** Amazon EKS

## Summary

This pattern demonstrates the use of Kubernetes *node affinity*, *node taints*, and Pod *tolerations* to intentionally schedule application Pods on specific worker nodes in an Amazon Elastic Kubernetes Service (Amazon EKS) cluster on the Amazon Web Services (AWS) Cloud.

A *taint* is a node property that enables nodes to reject a set of pods. A *toleration* is a Pod property that enables the Kubernetes scheduler to schedule Pods on nodes that have matching taints.

However, tolerations alone can't prevent a scheduler from placing a Pod on a worker node that doesn't have any taints. For example, a compute intensive Pod with a toleration can unintentionally get scheduled on a general-purpose untainted node. In that scenario, the *node affinity* property of a Pod instructs the scheduler to place the Pod on a node that meets the node selection criteria specified in the node affinity.

Taints, tolerations, and node affinity together instruct the scheduler to schedule Pods consistently on the nodes with matching taints and the node labels that match the node affinity node-selection criteria specified on the Pod.

This pattern provides an example Kubernetes deployment manifest file, and the steps to create an EKS cluster, deploy an application, and validate Pod placement.

## Prerequisites and limitations

### Prerequisites

- An AWS account with credentials configured to create resources on your AWS account
- AWS Command Line Interface (AWS CLI)

- `eksctl`
- `kubectl`
- [Docker](#) installed (for the operating system being used), and the engine started (for information about Docker licensing requirements, see the [Docker site](#))
- [Java](#) version 11 or later
- A Java microservice running on your favorite integrated development environment (IDE); for example, [AWS Cloud9](#), [IntelliJ IDEA Community Edition](#) or [Eclipse](#) (if you don't have a Java microservice, see the [Deploy a sample Java microservice on Amazon EKS](#) pattern and [Microservices with Spring](#) for help with creating the microservice)

## Limitations

- This pattern doesn't provide the Java code, and it assumes that you are already familiar with Java. To create a basic Java microservice, see [Deploy a sample Java microservice on Amazon EKS](#).
- The steps in this article create AWS resources that can accrue cost. Make sure that you clean up the AWS resources after you have completed the steps to implement and validate the pattern.

## Architecture

### Target technology stack

- Amazon EKS
- Java
- Docker
- Amazon Elastic Container Registry (Amazon ECR)

### Target architecture

The solution architecture diagram shows Amazon EKS with two Pods (Deployment 1 and Deployment 2) and two node groups (ng1 and ng2) with two nodes each. The Pods and nodes have the following properties.

Deployment 1 Pod	Deployment 2 Pod	Node group 1 (ng1)	Node group 2 (ng2)
---------------------	---------------------	-----------------------	-----------------------

<b>Toleration</b>	key: classified_workload, value: true, effect: NoSchedule	None	
	key: machine_learning_workload, value: true, effect: NoSchedule		
<b>Node affinity</b>	key: alpha.eksctl.io/nodegroup-name = ng1;	None	nodeGroup.s.name = ng1
<b>Taint</b>			key: classified_workload, value: true, effect: NoSchedule  key: machine_learning_workload, value: true, effect: NoSchedule

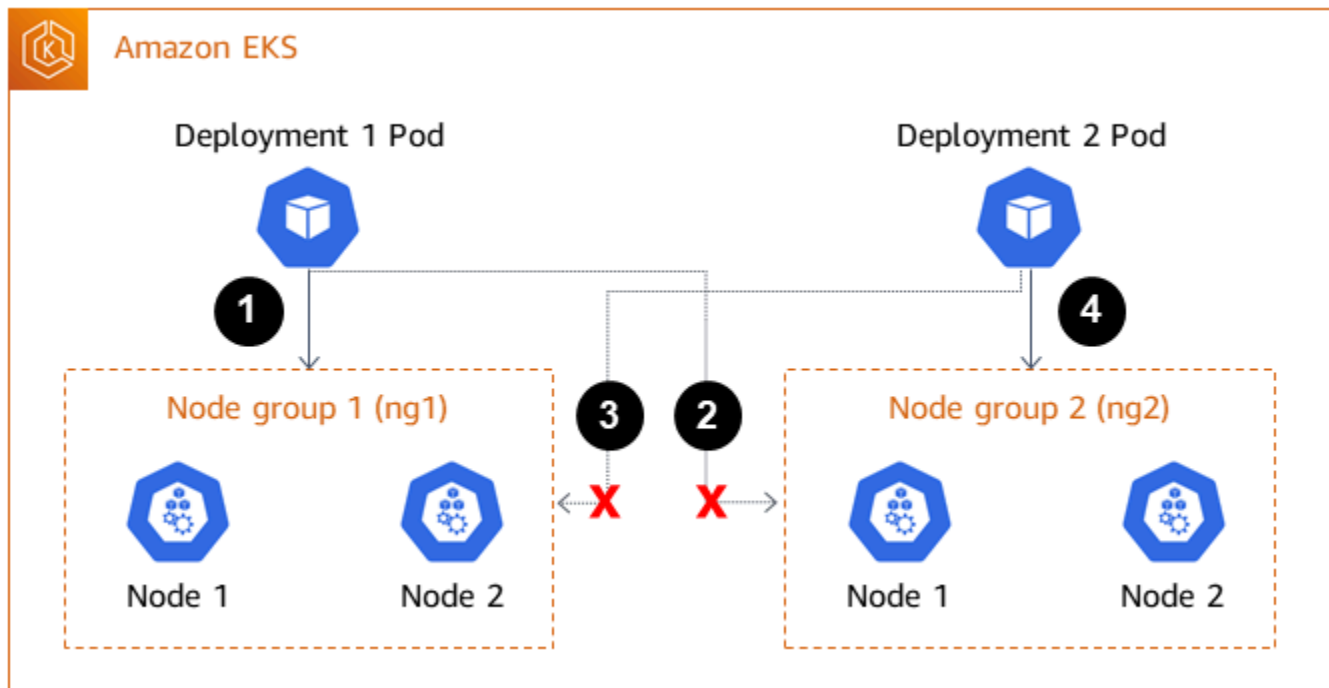

1. The Deployment 1 Pod has tolerations and node affinity defined, which instructs the Kubernetes scheduler to place the deployment Pods on the Node group 1 (ng1) nodes.
2. Node group 2 (ng2) doesn't have a node label that matches the node affinity node selector expression for Deployment 1, so the Pods will not be scheduled on ng2 nodes.
3. The Deployment 2 Pod doesn't have any tolerations or node affinity defined in the deployment manifest. The scheduler will reject scheduling Deployment 2 Pods on Node group 1 because of the taints on the nodes.
4. The Deployment 2 Pods will be placed on Node group 2 instead, because the nodes don't have any taints.

This pattern demonstrates that by using taints and tolerations, combined with node affinity, you can control placement of Pods on specific sets of worker nodes.

## Tools

### AWS services

- [AWS Command Line Interface \(AWS CLI\)](#) is an open-source tool that helps you interact with AWS services through commands in your command-line shell.
- [Amazon Elastic Container Registry \(Amazon ECR\)](#) is a managed container image registry service that's secure, scalable, and reliable.



- [Amazon Elastic Kubernetes Service \(Amazon EKS\)](#) helps you run Kubernetes on AWS without needing to install or maintain your own Kubernetes control plane or nodes.
- [eksctl](#) is AWS equivalent of kubectl and helps with creating EKS.

## Other tools

- [Docker](#) is a set of platform as a service (PaaS) products that use virtualization at the operating-system level to deliver software in containers.
- [kubect](#) is a command-line interface that helps you run commands against Kubernetes clusters.

## Epics

### Create the EKS cluster

Task	Description	Skills required
Create the cluster.yaml file.	<p>Create a file called <code>cluster.yaml</code> with the following code.</p> <pre> apiVersion: eksctl.io/ v1alpha5 kind: ClusterConfig  metadata:   name: eks-taint-demo   region: us-west-1  # Unmanaged nodegroup s with and without taints. nodeGroups:   - name: ng1     instanceType: m5.xlarge     minSize: 2     maxSize: 3     taints: </pre>	App owner, AWS DevOps, Cloud administrator, DevOps engineer

Task	Description	Skills required
	<pre> - key: classified_workload   value: "true"   effect:     NoSchedule - key: machine_learning_workload   value: "true"   effect:     NoSchedule  - name: ng2   instanceType:     m5.xlarge   minSize: 2   maxSize: 3 </pre>	
Create the cluster by using <code>eksctl</code> .	<p>Run the <code>cluster.yaml</code> file to create the EKS cluster. Creating the cluster might take a few minutes.</p> <pre> eksctl create cluster -f cluster.yaml </pre>	AWS DevOps, AWS systems administrator, App developer

## Create an image and upload it to Amazon ECR

Task	Description	Skills required
Create an Amazon ECR private repository.	To create an Amazon ECR repository, see <a href="#">Creating a private repository</a> . Note the URI of the repo.	AWS DevOps, DevOps engineer, App developer
Create the Dockerfile.	If you have an existing Docker container image that you want to use to test the	AWS DevOps, DevOps engineer

Task	Description	Skills required
	<p>pattern, you can skip this step.</p> <p>To create a Dockerfile, use the following snippet as a reference. If you encounter errors, see the <a href="#">Troubleshooting</a> section.</p> <pre>FROM adoptopenjdk/openjdk11:jdk-11.0.14.1_1-alpine  RUN apk add maven WORKDIR /code  # Prepare by downloading dependencies ADD pom.xml /code/pom.xml RUN ["mvn", "dependency:resolve"] RUN ["mvn", "verify"]  # Adding source, compile and package into a fat jar ADD src /code/src RUN ["mvn", "package"]  EXPOSE 4567 CMD ["java", "-jar", "target/eksExample-jar-with-dependencies.jar"]</pre>	

Task	Description	Skills required
Create the pom.xml and source files, and build and push the Docker image.	<p>To create the pom.xml file and the Java source file, see <a href="#">Deploy a sample Java microservice on Amazon EKS</a> pattern.</p> <p>Use the instructions in that pattern to build and push the Docker image.</p>	AWS DevOps, DevOps engineer, App developer

## Deploy to Amazon EKS

Task	Description	Skills required
Create the deployment.yaml file.	<p>To create the deployment.yaml file, use the code in the <a href="#">Additional information</a> section.</p> <p>In the code, the key for node affinity is any label that you create while creating node groups. This pattern uses the default label created by eksctl. For information about customizing labels, see <a href="#">Assigning Pods to Nodes</a> in the Kubernetes documentation.</p> <p>The value for the node affinity key is the name of the node group that was created by cluster.yaml .</p>	AWS DevOps, DevOps engineer, App developer

Task	Description	Skills required
	<p>To get the key and value for the taint, run the following command.</p> <pre data-bbox="594 380 1027 537">kubect1 get nodes -o json   jq '.items[].spec.taints'</pre> <p>The image is the URI of the Amazon ECR repository that you created in an earlier step.</p>	
Deploy the file.	<p>To deploy to Amazon EKS, run the following command.</p> <pre data-bbox="594 873 1027 989">kubect1 apply -f deployment.yaml</pre>	App developer, DevOps engineer, AWS DevOps

Task	Description	Skills required
Check the deployment.	<p>1. To check if the pods are READY, run the following command.</p> <pre data-bbox="630 394 1029 512">kubect1 get pods -o wide</pre> <p>If the POD is ready, the output should look similar to the following, with the STATUS as Running.</p> <pre data-bbox="630 768 1029 1323">NAME          READY STATUS       RESTARTS AGE          IP        NODE NOMINATED    NODE READINESS    GATES &lt;pod_name&gt;   1/1 Running      0 12d         192.168.1 8.50        ip-192-16 8-20-110.us-west-1 .compute.internal &lt;none&gt; &lt;none&gt;</pre> <p>Note the name of the Pod and the name of the node. You can skip the next step.</p> <p>2. (Optional) To get additional details about the Pod and check the tolerations on the Pod, run the following command.</p>	App developer, DevOps engineer, AWS DevOps

Task	Description	Skills required
	<pre data-bbox="630 212 1029 327">kubect1 describe pod &lt;pod_name&gt;</pre> <p data-bbox="630 365 1005 499">An example of the output is in the <a href="#">Additional information</a> section.</p> <p data-bbox="591 520 1000 695">3. To validate that the Pod placement on the node is correct, run the following command.</p> <pre data-bbox="630 737 1029 894">kubect1 describe node &lt;node name&gt;   grep -A 1 "Taints"</pre> <p data-bbox="630 932 993 1205">Confirm that the taint on the node matches toleration, and the label on the node matches the node affinity defined in <code>deployment.yaml</code> .</p> <p data-bbox="630 1251 1016 1667">The Pod with tolerations and node affinity should be placed on a node with the matching taints and the node affinity labels. The previous command gives you the taints on the node. The following is an example output.</p> <pre data-bbox="630 1703 1029 1839">kubect1 describe node ip-192-168-29-181. us-west-1.compute.</pre>	

Task	Description	Skills required
	<pre>internal   grep -A 1 "Taints" Taints:   classified_workload=true:NoSchedule    machine_learning_workload=true:NoSchedule</pre> <p>Additionally, run the following command to check that the node on which the Pod is placed has a label matching the node affinity node label.</p> <pre>kubectl get node &lt;node name&gt; --show-labels</pre> <p>4. To verify that the application is doing what it is intended to do, check the Pod logs by running the following command.</p> <pre>kubectl logs -f &lt;name-of-the-pod&gt;</pre>	



Task	Description	Skills required
Create a second deployment .yaml file without toleration and node affinity.	<p>This additional step is to validate that when no node affinity or tolerations are specified in the deployment manifest file, the resulting Pod is not scheduled on a node with taints. (It should be scheduled on a node that doesn't have any taints). Use the following code to create a new deployment file called <code>deploy_no_taint.yaml</code>.</p> <pre>apiVersion: apps/v1 kind: Deployment metadata:   name: microservice- deployment-non-tainted spec:   replicas: 1   selector:     matchLabels:       app.kuber netes.io/name: java- microservice-no-taint   template:     metadata:       labels:         app.kuber netes.io/name: java- microservice-no-taint     spec:       containers:         - name: java- microservice-container -2           image:             &lt;account_number&gt;.d kr.ecr&lt;region&gt;.ama</pre>	App developer, AWS DevOps, DevOps engineer

Task	Description	Skills required
	<pre>zonaws.com/&lt;repository_name&gt;:latest   ports:     - container Port: 4567</pre>	
<p>Deploy the second deployment .yaml file, and validate Pod placement</p>	<ol style="list-style-type: none"> <li>Run the following command.           <pre>kubectl apply -f   deploy_no_taint.yaml</pre> </li> <li>After the deployment is successful, run the same commands that you ran previously to check the Pod placement in a node group with no taint.           <pre>kubectl describe node   &lt;node_name&gt;   grep   "Taints"</pre> <p>The output should be the following.</p> <pre>Taints: &lt;none&gt;</pre> <p>This completes the testing.</p> </li> </ol>	<p>App developer, AWS DevOps, DevOps engineer</p>

## Clean up resources

Task	Description	Skills required
Clean up the resources.	To avoid incurring AWS charges for resources that are left running, use the following command. <pre>eksctl delete cluster --name &lt;Name of the cluster&gt; --region &lt;region-code&gt;</pre>	AWS DevOps, App developer

## Troubleshooting

Issue	Solution
Some of these commands might not run if your system uses <a href="#">arm64 architecture</a> (especially if you are running this on an M1 Mac). The following line might error out. <pre>FROM adoptopenjdk/openjdk11:jdk-11.0.14.1_1-alpine</pre>	If you have errors when running the Dockerfile, replace the FROM line with the following line. <pre>FROM bellsoft/liberica-openjdk-alpine-musl:17</pre>

## Related resources

- [Deploy a sample Java microservice on Amazon EKS](#)
- [Create an Amazon ECR private repository](#)
- [Assigning Pods to Nodes](#) (Kubernetes documentation)
- [Taints and Tolerations](#) (Kubernetes documentation)
- [Amazon EKS](#)
- [Amazon ECR](#)

- [AWS CLI](#)
- [Docker](#)
- [IntelliJ IDEA CE](#)
- [Eclipse](#)

## Additional information

### deployment.yaml

```
apiVersion: apps/v1
kind: Deployment
metadata:
  name: microservice-deployment
spec:
  replicas: 1
  selector:
    matchLabels:
      app.kubernetes.io/name: java-microservice
  template:
    metadata:
      labels:
        app.kubernetes.io/name: java-microservice
    spec:
      affinity:
        nodeAffinity:
          requiredDuringSchedulingIgnoredDuringExecution:
            nodeSelectorTerms:
              - matchExpressions:
                  - key: alpha.eksctl.io/nodegroup-name
                    operator: In
                    values:
                      - <node-group-name-from-cluster.yaml>
      tolerations: #only this pod has toleration and is viable to go to ng with taint
        - key: "<Taint key>" #classified_workload in our case
          operator: Equal
          value: "<Taint value>" #true
          effect: "NoSchedule"
        - key: "<Taint key>" #machine_learning_workload in our case
          operator: Equal
          value: "<Taint value>" #true
          effect: "NoSchedule"
```

```

containers:
  - name: java-microservice-container
    image: <account_number>.dkr.ecr<region>.amazonaws.com/
<repository_name>:latest
    ports:
      - containerPort: 4567

```

## describe pod example output

```

Name:          microservice-deployment-in-tainted-nodes-5684cc495b-vpcfx
Namespace:    default
Priority:      0
Node:         ip-192-168-29-181.us-west-1.compute.internal/192.168.29.181
Start Time:   Wed, 14 Sep 2022 11:06:47 -0400
Labels:       app.kubernetes.io/name=java-microservice-taint
              pod-template-hash=5684cc495b
Annotations:  kubernetes.io/psp: eks.privileged
Status:       Running
IP:           192.168.13.44
IPs:
  IP:         192.168.13.44
Controlled By: ReplicaSet/microservice-deployment-in-tainted-nodes-5684cc495b
Containers:
  java-microservice-container-1:
    Container ID:
      docker://5c158df8cc160de8f57f62f3ee16b12725a87510a809d90a1fb9e5d873c320a4
    Image:          934188034500.dkr.ecr.us-east-1.amazonaws.com/java-eks-apg
    Image ID:       docker-pullable://934188034500.dkr.ecr.us-east-1.amazonaws.com/
java-eks-apg@sha256:d223924aca8315aab20d54eddf3443929eba511b6433017474d01b63a4114835
    Port:          4567/TCP
    Host Port:     0/TCP
    State:         Running
      Started:     Wed, 14 Sep 2022 11:07:02 -0400
    Ready:         True
    Restart Count: 0
    Environment:   <none>
    Mounts:
      /var/run/secrets/kubernetes.io/serviceaccount from kube-api-access-ddvw (ro)
Conditions:
  Type           Status
  Initialized    True
  Ready          True
  ContainersReady True

```

```
PodScheduled      True
Volumes:
  kube-api-access-ddvww:
    Type:          Projected (a volume that contains injected data from
multiple sources)
    TokenExpirationSeconds: 3607
    ConfigMapName:  kube-root-ca.crt
    ConfigMapOptional: <nil>
    DownwardAPI:    true
QoS Class:        BestEffort
Node-Selectors:   <none>
Tolerations:      classified_workload=true:NoSchedule
                  machine_learning_workload=true:NoSchedule
                  node.kubernetes.io/not-ready:NoExecute op=Exists for 300s
                  node.kubernetes.io/unreachable:NoExecute op=Exists for
300s
Events:           <none>
```

# Replicate filtered Amazon ECR container images across accounts or Regions

Created by *Abdal Garuba (AWS)*

**Environment:** Production

**Technologies:** Containers & microservices; DevOps

**AWS services:** Amazon EC2 Container Registry; Amazon CloudWatch; AWS CodeBuild ; AWS Identity and Access Management; AWS CLI

## Summary

Amazon Elastic Container Registry (Amazon ECR) can replicate all container images in an image repository across Amazon Web Services (AWS) Regions and AWS accounts natively, by using the [cross-Region](#) and [cross-account replication](#) features. (For more information, see the AWS blog post [Cross region replication in Amazon ECR has landed](#).) However, there is no way to filter the images that are copied across AWS Regions or accounts based on any criteria.

This pattern describes how to replicate container images that are stored in Amazon ECR across AWS accounts and Regions, based on image tag patterns. The pattern uses Amazon CloudWatch Events to listen for push events for images that have a predefined, custom tag. A push event starts an AWS CodeBuild project and passes the image details to it. The CodeBuild project copies the images from the source Amazon ECR registry to the destination registry based on the details provided.

This pattern copies images that have specific tags across accounts. For example, you can use this pattern to copy only production-ready, secure images to the production AWS account. In the development account, after images are thoroughly tested, you can add a predefined tag to the secure images and use the steps in this pattern to copy the marked images to the production account.

## Prerequisites and limitations

### Prerequisites

- An active AWS account for source and destination Amazon ECR registries
- Administrative permissions for the tools used in this pattern
- [Docker](#) installed on your local machine for testing
- [AWS Command Line Interface \(AWS CLI\)](#), for authenticating into Amazon ECR

## Limitations

- This pattern watches the push events of the source registry in only one AWS Region. You can deploy this pattern to other Regions to watch registries in those Regions.
- In this pattern, one Amazon CloudWatch Events rule listens for a single image tag pattern. If you want to check for multiple patterns, you can add events to listen for additional image tag patterns.

## Architecture

### Target architecture

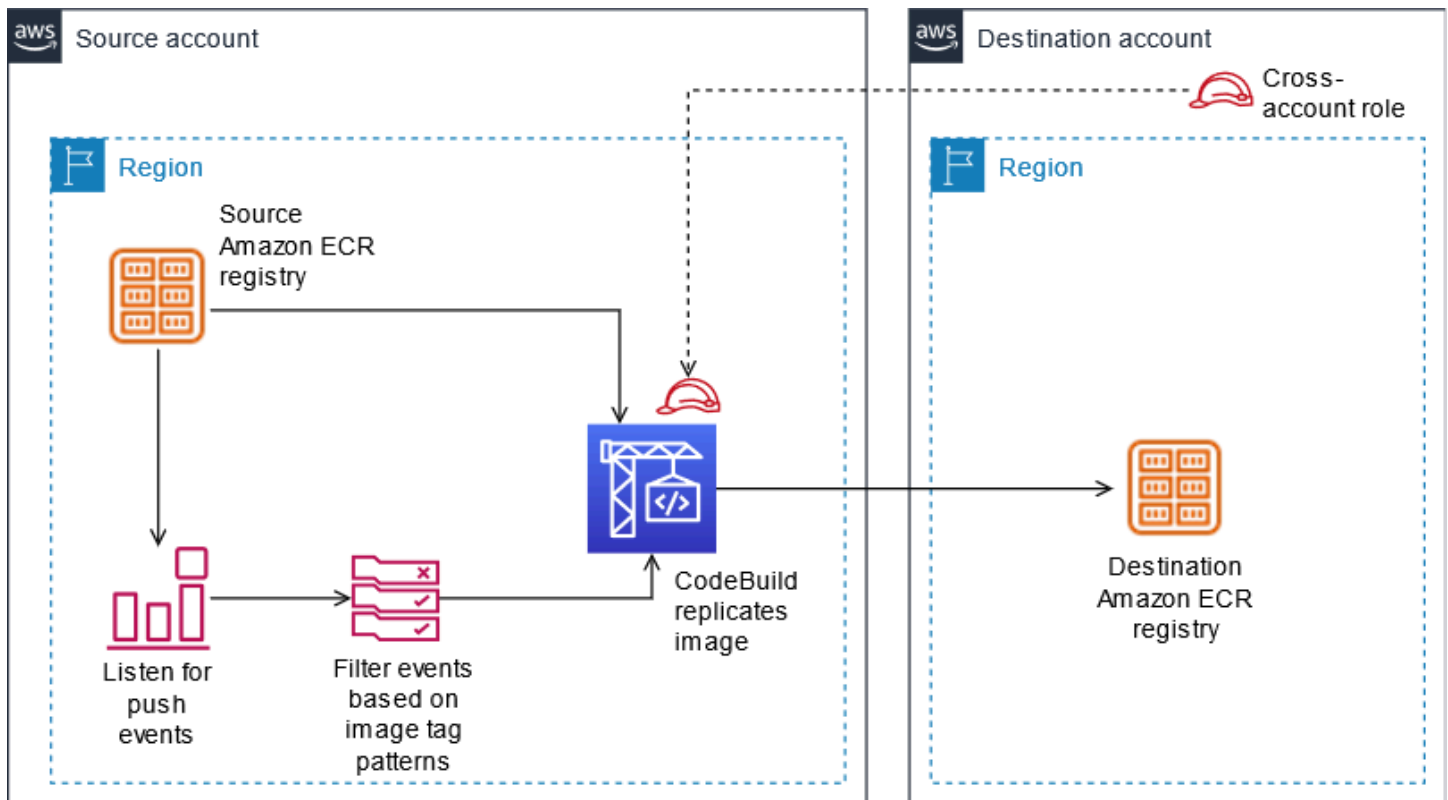

### Automation and scale



This pattern can be automated with an infrastructure as code (IaC) script and deployed at scale. To use AWS CloudFormation templates to deploy this pattern, download the attachment and follow the instructions in the [Additional information](#) section.

You can point multiple Amazon CloudWatch Events events (with different custom event patterns) to the same AWS CodeBuild project to replicate multiple image tag patterns, but you will need to update the secondary validation in the `buildspec.yaml` file (which is included in the attachment and in the [Tools](#) section) as follows to support multiple patterns.

```
...
if [[ ${IMAGE_TAG} != release-* ]]; then
...
```

## Tools

### Amazon services

- [IAM](#) – AWS Identity and Access Management (IAM) enables you to manage access to AWS services and resources securely. In this pattern, you would need to create the cross-account IAM role that AWS CodeBuild will assume when pushing container images to the destination registry.
- [Amazon ECR](#) – Amazon Elastic Container Registry (Amazon ECR) is a fully managed container registry that makes it easy to store, manage, share, and deploy your container images and artifacts anywhere. Image push actions to the source registry send system event details to the event bus that is picked up by Amazon CloudWatch Events.
- [AWS CodeBuild](#) – AWS CodeBuild is a fully managed continuous integration service that provides compute power to perform jobs such as compiling source code, running tests, and producing artifacts that are ready to be deployed. This pattern uses AWS CodeBuild to perform the copy action from the source Amazon ECR registry to the destination registry.
- [CloudWatch Events](#) – Amazon CloudWatch Events delivers a stream of system events that describe changes in AWS resources. This pattern uses rules to match Amazon ECR push actions with a specific image tag pattern.

### Tools

- [Docker CLI](#) – Docker is a tool that makes it easier to create and manage containers. Containers pack an application and all its dependencies into one unit or package that can easily be deployed on any platform that supports the container runtime.

## Code

You can implement this pattern in two ways:

- Automated setup: Deploy the two AWS CloudFormation templates provided in the attachment. For instructions, see the [Additional information](#) section.
- Manual setup: Follow the steps in the [Epics](#) section.

### *Sample buildspec.yaml*

If you're using the CloudFormation templates that are provided with this pattern, the `buildspec.yaml` file is included in the CodeBuild resources.

```
version: 0.2
env:
  shell: bash
phases:
  install:
    commands:
      - export CURRENT_ACCOUNT=$(echo ${CODEBUILD_BUILD_ARN} | cut -d':' -f5)
      - export CURRENT_ECR_REGISTRY=${CURRENT_ACCOUNT}.dkr.ecr.
        ${AWS_REGION}.amazonaws.com
      - export DESTINATION_ECR_REGISTRY=${DESTINATION_ACCOUNT}.dkr.ecr.
        ${DESTINATION_REGION}.amazonaws.com
  pre_build:
    on-failure: ABORT
    commands:
      - echo "Validating Image Tag ${IMAGE_TAG}"
      - |
        if [[ ${IMAGE_TAG} != release-* ]]; then
          aws codebuild stop-build --id ${CODEBUILD_BUILD_ID}
          sleep 60
          exit 1
        fi
      - aws ecr get-login-password --region ${AWS_REGION} | docker login -u AWS --
password-stdin ${CURRENT_ECR_REGISTRY}
      - docker pull ${CURRENT_ECR_REGISTRY}/${REPO_NAME}:${IMAGE_TAG}
  build:
    commands:
      - echo "Assume cross-account role"
      - CREDENTIALS=$(aws sts assume-role --role-arn ${CROSS_ACCOUNT_ROLE_ARN} --
role-session-name Rolesession)
```

```

- export AWS_DEFAULT_REGION=${DESTINATION_REGION}
- export AWS_ACCESS_KEY_ID=$(echo ${CREDENTIALS} | jq -r
'.Credentials.AccessKeyId')
- export AWS_SECRET_ACCESS_KEY=$(echo ${CREDENTIALS} | jq -r
'.Credentials.SecretAccessKey')
- export AWS_SESSION_TOKEN=$(echo ${CREDENTIALS} | jq -r
'.Credentials.SessionToken')
- echo "Logging into cross-account registry"
- aws ecr get-login-password --region ${DESTINATION_REGION} | docker login -u
AWS --password-stdin ${DESTINATION_ECR_REGISTRY}
- echo "Check if Destination Repository exists, else create"
- |
aws ecr describe-repositories --repository-names ${REPO_NAME} --region
${DESTINATION_REGION} \
|| aws ecr create-repository --repository-name ${REPO_NAME} --region
${DESTINATION_REGION}
- echo "retag image and push to destination"
- docker tag ${CURRENT_ECR_REGISTRY}/${REPO_NAME}:${IMAGE_TAG}
${DESTINATION_ECR_REGISTRY}/${REPO_NAME}:${IMAGE_TAG}
- docker push ${DESTINATION_ECR_REGISTRY}/${REPO_NAME}:${IMAGE_TAG}

```

## Epics

### Create IAM roles

Task	Description	Skills required
Create a CloudWatch Events role.	<p>In the source AWS account, create an IAM role for Amazon CloudWatch Events to assume. The role should have permissions to start a AWS CodeBuild project.</p> <p>To create the role by using the AWS CLI, follow the <a href="#">instructions in the IAM documentation</a>.</p> <p>Example trust policy (trustpolicy.json ):</p>	AWS administrator, AWS DevOps, AWS systems administrator, Cloud administrator, Cloud architect , DevOps engineer

Task	Description	Skills required
	<pre data-bbox="609 220 1031 724">{   "Version": "2012-10-17",   "Statement": {     "Effect": "Allow",     "Principal":     {"Service": "events.a mazonaws.com"},     "Action": "sts:Assu meRole"   } }</pre> <p data-bbox="592 766 982 892">Example permission policy (permissionpolicy.j son ):</p> <pre data-bbox="609 934 1031 1438">{   "Version": "2012-10-17",   "Statement": {     "Effect": "Allow",     "Action": "codebuil d:StartBuild",     "Resource":     "&lt;CodeBuild Project ARN&gt;"   } }</pre>	

Task	Description	Skills required
Create a CodeBuild role.	<p>Create an IAM role for AWS CodeBuild to assume, by following the <a href="#">instructions in the IAM documentation</a>. The role should have the following permissions:</p> <ul style="list-style-type: none"><li>• Permission to assume the destination cross-account role</li><li>• Permission to create log groups and log streams, and to put log events</li><li>• Read-only permissions to all Amazon ECR repositories, by adding the <a href="#">AmazonEC2ContainerRegistryReadOnly</a> managed policy to the role</li><li>• Permission to stop CodeBuild</li></ul> <p>Example trust policy (trustpolicy.json):</p> <pre>{   "Version": "2012-10-17",   "Statement": [     {       "Effect": "Allow",       "Principal": {         "Service": "codebuild.amazonaws.com"       },     }   ], }</pre>	AWS administrator, AWS DevOps, AWS systems administrator, Cloud administrator, Cloud architect , DevOps engineer

Task	Description	Skills required
	<pre data-bbox="609 210 1015 420">       "Action":       "sts:AssumeRole"     }   ] } </pre> <p data-bbox="592 462 982 598">Example permission policy (permissionpolicy.json):</p> <pre data-bbox="609 640 1015 1785"> {   "Version":   "2012-10-17",   "Statement": [     {       "Action": [         "codebuild:StartBuild",         "codebuild:StopBuild",         "codebuild:Get*",         "codebuild:List*",         "codebuild:BatchGet*",         ],       "Resource":       "*",       "Effect":       "Allow"     },     {       "Action": [         "logs:CreateLogGroup", </pre>	

Task	Description	Skills required
	<pre data-bbox="609 247 1015 1207"> "logs:CreateLogStream",  "logs:PutLogEvents"     ],     "Resource": "*",     "Effect": "Allow"     },     {         "Action": "sts:AssumeRole",         "Resource": "&lt;ARN of destination role&gt;",         "Effect": "Allow",         "Sid": "AssumeCrossAccountArn"     }     ] } </pre> <p data-bbox="592 1260 1006 1438">Attach the managed policy AmazonEC2ContainerRegistryReadOnly to the CLI command as follows:</p> <pre data-bbox="609 1491 1015 1816"> ~\$ aws iam attach-role-policy \ --policy-arn arn:aws:iam::aws:policy/AmazonEC2ContainerRegistryReadOnly \ --role-name &lt;name of CodeBuild Role&gt; </pre>	

Task	Description	Skills required
Create a cross-account role.	<p>In the destination AWS account, create an IAM role for the AWS CodeBuild role for the source account to assume. The cross-account role should allow container images to create a new repository and upload container images to Amazon ECR.</p> <p>To create the IAM role by using the AWS CLI, follow the <a href="#">instructions in the IAM documentation</a>.</p> <p>To allow the AWS CodeBuild project from the previous step, use the following trust policy:</p> <pre data-bbox="594 1171 1029 1730">{   "Version": "2012-10-17",   "Statement": {     "Effect": "Allow",     "Principal": {       "AWS": "&lt;ARN of source codebuild role&gt;"     },     "Action": "sts:AssumeRole"   } }</pre> <p>To allow the AWS CodeBuild project from the previous</p>	AWS administrator, AWS DevOps, Cloud administrator, Cloud architect, DevOps engineer, AWS systems administrator



Task	Description	Skills required
	<p>step to save images in the destination registry, use the following permission policy:</p> <pre data-bbox="597 380 1029 1822">{   "Version":   "2012-10-17",   "Statement": [     {       "Action": [  "ecr:GetDownloadUr lForLayer",  "ecr:BatchCheckLay erAvailability",  "ecr:PutImage",  "ecr:InitiateLayer Upload",  "ecr:UploadLayerPa rt",  "ecr:CompleteLayer Upload",  "ecr:GetRepository Policy",  "ecr:DescribeRepos itories",  "ecr:GetAuthorizat ionToken",  "ecr:CreateReposit ory"        ],     }   ], }</pre>	

Task	Description	Skills required
	<pre> "Resource":   "*",   "Effect":     "Allow"   } ] } </pre>	

## Create the CodeBuild project

Task	Description	Skills required
Create a CodeBuild project.	<p>Create a AWS CodeBuild project in the source account by following the <a href="#">instructions in the AWS CodeBuild documentation</a>. The project should be in the same Region as the source registry.</p> <p>Configure the project as follows:</p> <ul style="list-style-type: none"> <li>• Environment type: LINUX CONTAINER</li> <li>• Service role: CodeBuild Role</li> <li>• Privileged mode: true</li> <li>• Environment image: aws/codebuild/standard:x.x (use the latest image available)</li> <li>• Environment variables: <ul style="list-style-type: none"> <li>• CROSS_ACCOUNT_ROLE_ARN : The Amazon</li> </ul> </li> </ul>	AWS administrator, AWS DevOps, AWS systems administrator, Cloud administrator, Cloud architect , DevOps engineer

Task	Description	Skills required
	<p>Resource Name (ARN) of the cross-account role</p> <ul style="list-style-type: none"> <li>• <code>DESTINATION_REGION</code> : The name of the cross-account Region</li> <li>• <code>DESTINATION_ACCOUNT</code> : The number of the destination account</li> <li>• Build specifications: Use the <code>buildspec.yaml</code> file listed in the <a href="#">Tools</a> section.</li> </ul>	

## Create the event

Task	Description	Skills required
Create an events rule.	<p>Because the pattern uses the content filtering feature, you need to create the event by using Amazon EventBridge. Create the event and target by following the <a href="#">instructions in the EventBridge documentation</a>, with a few modifications:</p> <ul style="list-style-type: none"> <li>• For <b>Define pattern</b>, choose <b>Event Pattern</b>, and then choose <b>Custom pattern</b>.</li> <li>• Copy the following custom events pattern sample code into the text box provided:</li> </ul> <pre>{</pre>	AWS administrator, AWS DevOps, AWS systems administrator, Cloud administrator, Cloud architect , DevOps engineer

Task	Description	Skills required
	<pre data-bbox="625 205 1031 823"> "source": ["aws.ecr "], "detail-type": ["ECR Image Action"], "detail": { "action-type": ["PUSH"], "result": ["SUCCESS"], "image-ta g": [{ "prefix": "release-"}] } } </pre> <ul data-bbox="592 840 1031 1323" style="list-style-type: none"> <li>• For <b>Select targets</b>, choose the AWS CodeBuild project, and paste the ARN for the AWS CodeBuild project that you created in the previous epic.</li> <li>• For <b>Configure Input</b>, choose <b>Input Transformer</b>. <ul data-bbox="625 1239 998 1323" style="list-style-type: none"> <li>• In the <b>Input Path</b> text box, paste:</li> </ul> </li> </ul> <pre data-bbox="657 1354 1031 1596"> {"IMAGE_TAG":"\$.de tail.image-tag", "R EPO_NAME":"\$.detai l.repository-name" } </pre> <ul data-bbox="625 1617 998 1701" style="list-style-type: none"> <li>• In the <b>Input Template</b> text box, paste:</li> </ul> <pre data-bbox="657 1732 1031 1864"> {"environmentVaria blesOverride": [ {"name": </pre>	

Task	Description	Skills required
	<pre data-bbox="657 205 1027 426">"IMAGE_TAG", "value": &lt;IMAGE_TAG &gt;}, {"name": "REPO_N AME", "value": &lt;REPO _NAME&gt;}]}}</pre> <ul data-bbox="592 443 1027 663" style="list-style-type: none"> <li>• Choose <b>Use existing role</b>, and choose the name of the CloudWatch Events role you created previously in the <i>Create IAM roles epic</i>.</li> </ul>	

## Validate

Task	Description	Skills required
Authenticate with Amazon ECR.	Authenticate to both source and destination registries by following the steps in the <a href="#">Amazon ECR documentation</a> .	AWS administrator, AWS DevOps, AWS systems administrator, Cloud administrator, DevOps engineer, Cloud architect
Test image replication.	<p data-bbox="592 1234 1027 1602">In your source account, push a container image to a new or existing Amazon ECR source repository with an image tag prefixed with <code>release-</code>. To push the image, follow the steps in the <a href="#">Amazon ECR documentation</a>.</p> <p data-bbox="592 1650 1027 1774">You can monitor the progress of the CodeBuild project in the <a href="#">CodeBuild console</a>.</p>	AWS administrator, AWS DevOps, AWS systems administrator, Cloud administrator, Cloud architect, DevOps engineer

Task	Description	Skills required
	<p>After the CodeBuild project has completed successfully, sign in to the destination AWS account, open the Amazon ECR console, and confirm that the image exists in the destination Amazon ECR registry.</p>	
<p>Test image exclusion.</p>	<p>In your source account, push a container image to a new or existing Amazon ECR source repository with an image tag that doesn't have the custom prefix.</p> <p>Confirm that the CodeBuild project isn't started, and that no container images appear in the destination registry.</p>	<p>AWS administrator, AWS DevOps, AWS systems administrator, Cloud administrator, Cloud architect , DevOps engineer</p>

## Related resources

- [Getting started with CodeBuild](#)
- [Getting started with Amazon EventBridge](#)
- [Content-based filtering in Amazon EventBridge event patterns](#)
- [Delegate access across AWS accounts using IAM roles](#)
- [Private image replication](#)

## Additional information

To automatically deploy the resources for this pattern, follow these steps:

1. Download the attachment and extract the two CloudFormation templates: `part-1-copy-tagged-images.yaml` and `part-2-destination-account-role.yaml`.
2. Log in to the [AWS CloudFormation console](#), and deploy `part-1-copy-tagged-images.yaml` in the same AWS account and Region as the source Amazon ECR registries. Update the parameters as needed. The template deploys the following resources:
  - Amazon CloudWatch Events IAM role
  - AWS CodeBuild project IAM role
  - AWS CodeBuild project
  - AWS CloudWatch Events rule
3. Take note of the value of `SourceRoleName` in the **Outputs** tab. You will need this value in the next step.
4. Deploy the second CloudFormation template, `part-2-destination-account-role.yaml`, in the AWS account that you want to copy the Amazon ECR container images to. Update the parameters as needed. For the `SourceRoleName` parameter, specify the value from step 3. This template deploys the cross-account IAM role.
5. Validate image replication and exclusion, as described in the last step of the [Epics](#) section.

## Attachments

To access additional content that is associated with this document, unzip the following file: [attachment.zip](#)

# Rotate database credentials without restarting containers

Created by Josh Joy (AWS)

**Environment:** Production

**Technologies:** Containers & microservices; Databases; DevOps; Infrastructure; Security, identity, compliance; Management & governance

**AWS services:** Amazon ECS; Amazon Aurora; AWS Fargate; AWS Secrets Manager; Amazon VPC

## Summary

On the Amazon Web Services (AWS) Cloud, you can use AWS Secrets Manager to rotate, manage, and retrieve database credentials throughout their lifecycle. Users and applications retrieve secrets with a call to the Secrets Manager API, removing the need to hardcode sensitive information in plaintext.

If you're using containers for microservice workloads, you can securely store credentials in AWS Secrets Manager. To separate out configuration from code, these credentials are commonly injected into the container. However, it's important to rotate your credentials periodically and automatically. It's also important to support the ability to refresh credentials after revocation. At the same time, applications require the ability to rotate credentials while reducing any potential downstream availability impact.

This pattern describes how to rotate your secrets that are secured with AWS Secrets Manager within your containers without requiring your containers to restart. In addition, this pattern reduces the number of credential lookups to Secrets Manager by using the Secrets Manager [client-side caching component](#). When you use the client-side caching component to refresh the credentials within the application, the container doesn't need to be restarted to fetch a rotated credential.

This approach works for Amazon Elastic Kubernetes Service (Amazon EKS) and Amazon Elastic Container Service (Amazon ECS).

[Two scenarios are covered](#). In the single-user scenario, the database credential is refreshed on secret rotation by detecting the expired credential. The credential cache is instructed to refresh the secret, and then the application re-establishes the database connection. The client-side caching component caches the credential within the application and helps avoid reaching out to Secrets



Manager for each credential lookup. The credential is rotated within the application without the need to force the credential refresh by restarting the container.

The second scenario rotates the secret by alternating between two users. Having two active users reduces the potential for downtime, because one user's credentials are always active. Two-user credential rotation is helpful when you have a large deployment with clusters in which there might be a small propagation delay of credential updates.

## Prerequisites and limitations

### Prerequisites

- An active AWS account.
- An application running in a container in Amazon EKS or Amazon ECS.
- Credentials stored in Secrets Manager, with [rotation enabled](#).
- A second set of credentials stored in Secrets Manager, if deploying the two-user solution. Code examples can be found in the GitHub repo [aws-secrets-manager-rotation-lambdas](#).
- An Amazon Aurora database.

### Limitations

- This example is targeted for Python applications. For Java applications, you can use the [Java client-side caching component](#) or the [JDBC client-side caching library](#) for Secrets Manager.

## Architecture

### Target architecture

*Scenario 1 – Rotation of a credential for a single user*

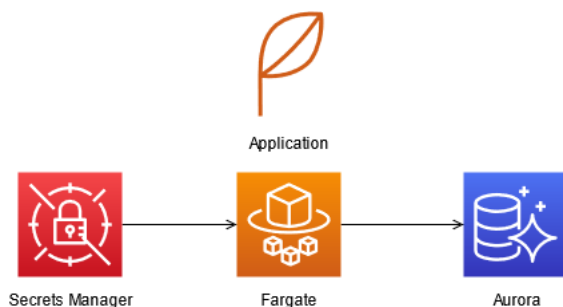

In the first scenario, a single database credential is periodically rotated by Secrets Manager. The application container runs in Fargate. When the first database connection is established, the application container fetches the database credential for Aurora. The Secrets Manager caching component then caches the credential for future connection establishment. When rotation period has elapsed, the credential expires and the database returns an authentication error. The application then fetches the rotated credential, invalidates the cache, and updates the credential cache via the Secrets Manager client-side caching component.

In this scenario, there might be a minimal disruption while the credential is being rotated and stale connections are using the outdated credential. This concern can be addressed by using the two-user scenario.

### Scenario 2 – Rotation of credentials for two users

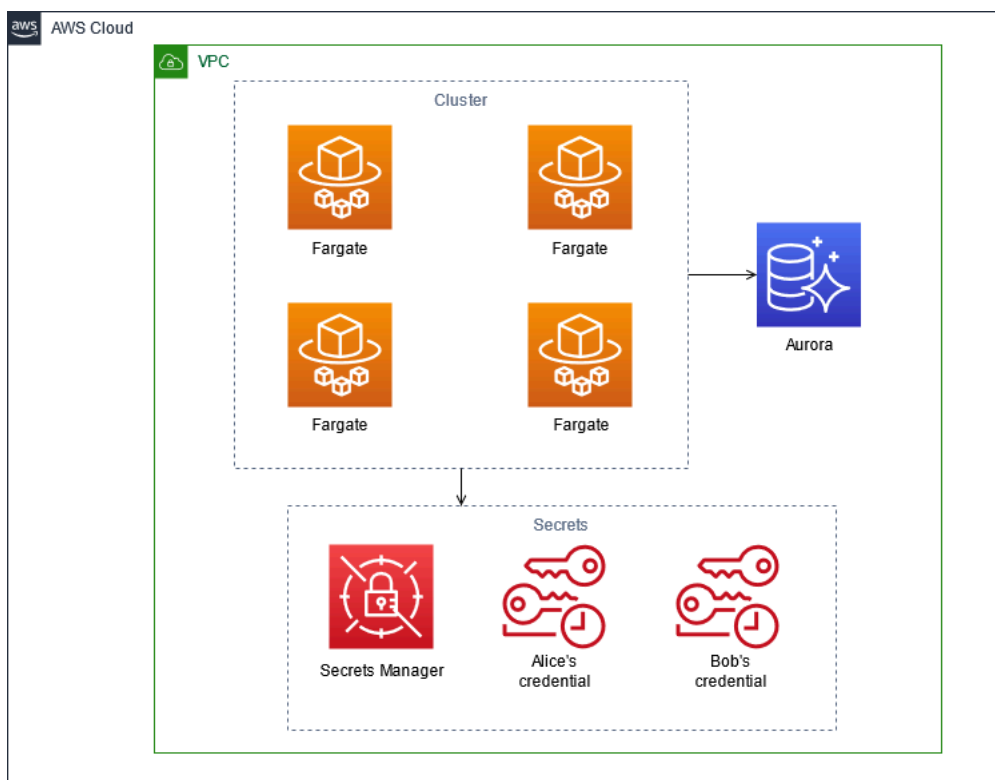

In the second scenario, two database user credentials (Alice's and Bob's) are periodically rotated by Secrets Manager. The application container runs in a Fargate cluster. When the first database connection is established, the application container fetches the Aurora database credential for the first user (Alice). The Secrets Manager caching component then caches the credential for future connection establishment.

Although there are two users and credentials, one only active credential is managed by Secrets Manager. In this case, the caching component periodically expires and fetches the latest credential. If the Secrets Manager rotation period is longer than the cache timeout, the caching component picks up the rotated credential for the second user (Bob). For example, if the cache expiration is measured in minutes and the rotation period is measured in days, the caching component fetches the new credential as part of its periodic cache refresh. In this way, the downtime is minimized because each user's credential is active for one Secrets Manager rotation.

## Automation and scale

You can use [AWS CloudFormation](#) to deploy this pattern by using [infrastructure as code](#). This builds and creates the application container, creates the Fargate task, deploys the container into Fargate, and sets up and configure Secrets Manager with Aurora. For step-by-step deployment instructions, see the [readme](#) file.

## Tools

### Tools

- [AWS Secrets Manager](#) enables the replacement of hardcoded credentials, including passwords, with an API call to Secrets Manager to retrieve the secret. Because Secrets Manager can automatically rotate the secret according to a schedule, you can replace long-term secrets with short-term ones, reducing the risk of compromise.
- [Docker](#) helps developers to pack, ship, and run any application as a lightweight, portable, and self-sufficient container.

### Code

#### *Example Python code*

This pattern uses the Python client-side caching component for Secrets Manager to retrieve the authentication credentials when establishing the database connection. The client-side caching component helps avoid reaching out to Secrets Manager each time.

Now, when the rotation period elapses, the cached credential will be expired, and connecting to the database will result in an authentication error. For MySQL, the authentication error code is 1045. This example uses Amazon Aurora for MySQL, though you could use another engine such as PostgreSQL. Upon the authentication error, the database connection exception handling code

catches the error. It then informs the Secrets Manager client-side caching component to refresh the secret, then to reauthenticate and re-establish the database connection. If you are using PostgreSQL or another engine, you must look up the corresponding authentication error code.

The container application can now update the database password with the rotated password without restarting the container.

Place the following code in your application code that handles database connections. This example uses Django, and it [subclasses](#) the database backend with a database wrapper for connections. If you are using a different programming language or database connection library, see your database connection library to review how to subclass database connection retrieval.

```
def get_new_connection(self, conn_params):
    try:
        logger.info("get connection")
        databascredentials.get_conn_params_from_secrets_manager(conn_params)
        conn =super(DatabaseWrapper,self).get_new_connection(conn_params)
        return conn
    except MySQLdb.OperationalError as e:
        error_code=e.args[0]
        if error_code!=1045:
            raise e

        logger.info("Authentication error. Going to refresh secret and try again.")
        databascredentials.refresh_now()
        databascredentials.get_conn_params_from_secrets_manager(conn_params)
        conn=super(DatabaseWrapper,self).get_new_connection(conn_params)
        logger.info("Successfully refreshed secret and established new database
connection.")
        return conn
```

### *AWS CloudFormation and Python code*

- <https://github.com/aws-samples/aws-secrets-manager-credential-rotation-without-container-restart>

## Epics

### Maintain application availability during credential rotation

Task	Description	Skills required
Install the caching component .	Download and install the Secrets Manager client-side caching component for Python. For the download link, see the <i>Related resources</i> section.	Developer
Cache the working credential.	Use the Secrets Manager client-side caching component to cache the working credential locally.	Developer
Update the application code to refresh the credential upon the unauthorized error from the database connection.	Update the application code to use Secrets Manager to fetch and refresh database credentials. Add the logic to handle unauthorized error codes, and then fetch the newly rotated credential. See the <i>Example Python code</i> section.	Developer

## Related resources

### Create a Secrets Manager secret

- [Create keys in AWS KMS](#)
- [Create and manage secrets with AWS Secrets Manager](#)

### Create an Amazon Aurora cluster

- [Creating an Amazon RDS DB instance](#)

## Create the Amazon ECS components

- [Creating a cluster using the classic console](#)
- [Create a Docker image](#)
- [Creating a private repository](#)
- [Amazon ECR private registry](#)
- [Pushing a Docker image](#)
- [Amazon ECS task definitions](#)
- [Creating an Amazon ECS service in the classic console](#)

## Download and install the Secrets Manager client-side caching component

- [Python caching client](#)

## Attachments

To access additional content that is associated with this document, unzip the following file:  
[attachment.zip](#)

# Run Amazon ECS tasks on Amazon WorkSpaces with Amazon ECS Anywhere

Created by Akash Kumar (AWS)

**Environment:** Production

**Technologies:** Containers & microservices; Modernization

**Workload:** All other workloads

**AWS services:** Amazon ECS; Amazon WorkSpaces; AWS Directory Service

## Summary

Amazon Elastic Container Service (Amazon ECS) Anywhere supports the deployment of Amazon ECS tasks in any environment, including Amazon Web Services (AWS) managed infrastructure and customer managed infrastructure. You can do this while using a fully AWS managed control plane that's running in the cloud and always up to date.

Enterprises often use Amazon WorkSpaces for developing container-based applications. This has required Amazon Elastic Compute Cloud (Amazon EC2) or AWS Fargate with an Amazon ECS cluster to test and run ECS tasks. Now, by using Amazon ECS Anywhere, you can add Amazon WorkSpaces as external instances directly to an ECS cluster, and you can run your tasks directly. This reduces your development time, because you can test your container with an ECS cluster locally on Amazon WorkSpaces. You can also save the cost of using EC2 or Fargate instances for testing your container applications.

This pattern showcases how to deploy ECS tasks on Amazon WorkSpaces with Amazon ECS Anywhere. It sets up the ECS cluster and uses AWS Directory Service Simple AD to launch the WorkSpaces. Then the example ECS task launches NGINX in the WorkSpaces.

## Prerequisites and limitations

- An active AWS account
- AWS Command Line Interface (AWS CLI)
- AWS credentials [configured on your machine](#)

# Architecture

## Target technology stack

- A virtual private cloud (VPC)
- An Amazon ECS cluster
- Amazon WorkSpaces
- AWS Directory Service with Simple AD

## Target architecture

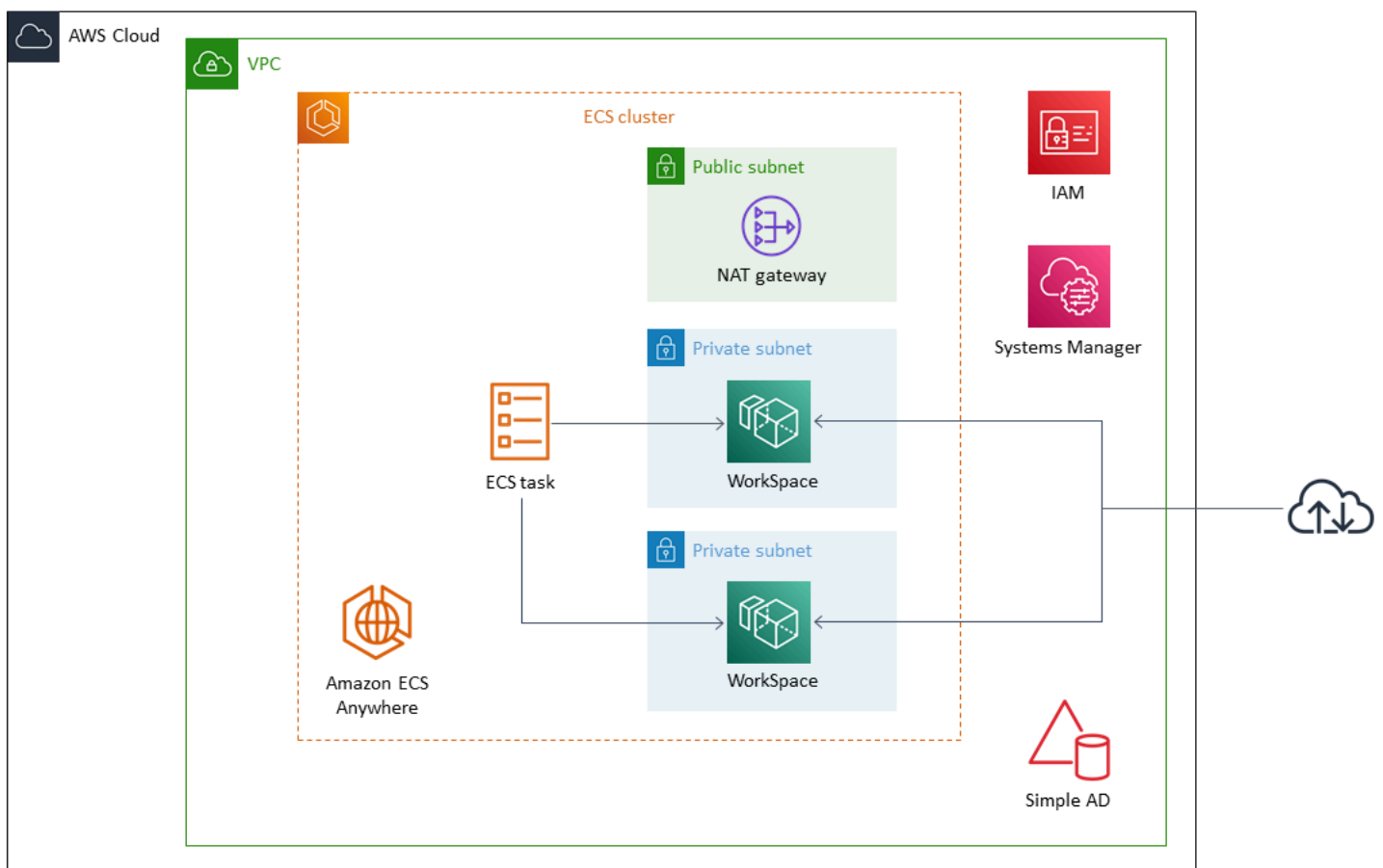

The architecture includes the following services and resources:

- An ECS cluster with public and private subnets in a custom VPC
- Simple AD in the VPC to provide user access to Amazon WorkSpaces
- Amazon WorkSpaces provisioned in the VPC using Simple AD



- AWS Systems Manager activated for adding Amazon WorkSpaces as managed instances
- Using Amazon ECS and AWS Systems Manager Agent (SSM Agent), Amazon WorkSpaces added to Systems Manager and the ECS cluster
- An example ECS task to run in the WorkSpaces in the ECS cluster

## Tools

- [AWS Directory Service Simple Active Directory \(Simple AD\)](#) is a standalone managed directory powered by a Samba 4 Active Directory Compatible Server. Simple AD provides a subset of the features offered by AWS Managed Microsoft AD, including the ability to manage users and to securely connect to Amazon EC2 instances.
- [Amazon Elastic Container Service \(Amazon ECS\)](#) is a fast and scalable container management service that helps you run, stop, and manage containers on a cluster.
- [AWS Identity and Access Management \(IAM\)](#) helps you securely manage access to your AWS resources by controlling who is authenticated and authorized to use them.
- [AWS Systems Manager](#) helps you manage your applications and infrastructure running in the AWS Cloud. It simplifies application and resource management, shortens the time to detect and resolve operational problems, and helps you manage your AWS resources securely at scale.
- [Amazon WorkSpaces](#) helps you provision virtual, cloud-based Microsoft Windows or Amazon Linux desktops for your users, known as *WorkSpaces*. WorkSpaces eliminates the need to procure and deploy hardware or install complex software.

## Epics

### Set up the ECS cluster

Task	Description	Skills required
Create and configure the ECS cluster.	To create the ECS cluster, follow the instructions in the <a href="#">AWS documentation</a> , including the following steps: <ul style="list-style-type: none"> <li>• For <b>Select cluster compatibility</b>, choose</li> </ul>	Cloud architect

Task	Description	Skills required
	<p><b>Networking only</b>, which will support an Amazon WorkSpace as an external instance to the ECS cluster.</p> <ul style="list-style-type: none"> <li>Choose to create a new VPC.</li> </ul>	

## Launch Amazon WorkSpaces

Task	Description	Skills required
Set up Simple AD and launch Amazon WorkSpaces.	To provision a Simple AD directory for your newly created VPC and launch Amazon WorkSpaces, follow the instructions in the <a href="#">AWS documentation</a> .	Cloud architect

## Set up AWS Systems Manager for a hybrid environment

Task	Description	Skills required
Download the attached scripts.	On your local machine, download the <code>ssm-trust-policy.json</code> and <code>ssm-activation.json</code> files that are in the <i>Attachments</i> section.	Cloud architect
Add the IAM role.	Add environment variables based on your business requirements.	Cloud architect

Task	Description	Skills required
	<pre>export AWS_DEFAULT_REGION=\${AWS_REGION_ID} export ROLE_NAME=\${ECS_TASK_ROLE} export CLUSTER_NAME=\${ECS_CLUSTER_NAME} export SERVICE_NAME=\${ECS_CLUSTER_SERVICE_NAME}</pre> <p>Run the following command.</p> <pre>aws iam create-role --role-name \$ROLE_NAME --assume-role-policy-document file://ssm-trust-policy.json</pre>	
<p>Add the AmazonSSMManagedInstanceCore policy to the IAM role.</p>	<p>Run the following command.</p> <pre>aws iam attach-role-policy --role-name \$ROLE_NAME --policy-arn arn:aws:iam::aws:policy/AmazonSSMManagedInstanceCore</pre>	<p>Cloud architect</p>
<p>Add the AmazonEC2ContainerServiceforEC2Role policy to IAM role.</p>	<p>Run the following command.</p> <pre>aws iam attach-role-policy --role-name \$ROLE_NAME --policy-arn arn:aws:iam::aws:policy/service-role/AmazonEC2ContainerServiceforEC2Role</pre>	<p>Cloud architect</p>

Task	Description	Skills required
Verify the IAM role.	To verify the IAM role, run the following command.  <pre>aws iam list-attached-role-policies --role-name \$ROLE_NAME</pre>	Cloud architect
Activate Systems Manager.	Run the following command.  <pre>aws ssm create-activation --iam-role \$ROLE_NAME   tee ssm-activation.json</pre>	Cloud architect

## Add WorkSpaces to the ECS cluster

Task	Description	Skills required
Connect to your WorkSpaces.	To connect to and set up your Workspaces, follow the instructions in the <a href="#">AWS documentation</a> .	App developer
Download the ecs-anywhere install script.	At the command prompt, run the following command.  <pre>curl -o "ecs-anywhere-install.sh" "https://amazon-ecs-agent-packages-preview.s3.us-east-1.amazonaws.com/ecs-anywhere-install.sh" &amp;&amp; sudo chmod +x ecs-anywhere-install.sh</pre>	App developer

Task	Description	Skills required
Check integrity of the shell script.	<p>(Optional) Run the following command.</p> <pre data-bbox="594 344 1027 863">curl -o "ecs-anywhere-install.sh.sha256" "https://amazon-ecs-agent-packages-prereview.s3.us-east-1.amazonaws.com/ecs-anywhere-install.sh.sha256" &amp;&amp; sha256sum -c ecs-anywhere-install.sh.sha256</pre>	App developer
Add an EPEL repository on Amazon Linux.	<p>To add an Extra Packages for Enterprise Linux (EPEL) repository, run the command <code>sudo amazon-linux-extras install epel -y</code>.</p>	App developer
Install Amazon ECS Anywhere.	<p>To run the install script, use the following command.</p> <pre data-bbox="594 1339 1027 1745">sudo ./ecs-anywhere-install.sh --cluster \$CLUSTER_NAME --activation-id \$ACTIVATION_ID --activation-code \$ACTIVATION_CODE --region \$AWS_REGION</pre>	

Task	Description	Skills required
Check instance information from the ECS cluster.	<p>To check the Systems Manager and ECS cluster instance information and validate that WorkSpaces were added on the cluster, run the following command from your local machine.</p> <pre>aws ssm describe-instance-informati on" &amp;&amp; "aws ecs list-container-instances --cluster \$CLUSTER_NAME</pre>	App developer

### Add an ECS task for the WorkSpaces

Task	Description	Skills required
Create a task execution IAM role.	<p>Download <code>task-execution-assume-role.json</code> and <code>external-task-definition.json</code> from the <i>Attachments</i> section.</p> <p>On your local machine, run the following command.</p> <pre>aws iam --region \$AWS_DEFAULT_REGION create-role --role-name \$ECS_TASK_EXECUTION_ROLE --assume-role-policy-document file://ta</pre>	Cloud architect

Task	Description	Skills required
	<pre>sk-execution-assume- role.json</pre>	
Add the policy to the execution role.	Run the following command. <pre>aws iam --region \$AWS_DEFAULT_REGIO N attach-role-policy --role-name \$ECS_TASK _EXECUTION_ROLE -- policy-arn arn:aws:i am::aws:policy/ser vice-role/AmazonEC STaskExecutionRole Policy</pre>	Cloud architect
Create a task role.	Run the following command. <pre>aws iam --region \$AWS_DEFAULT_REGIO N create-role -- role-name \$ECS_TASK _EXECUTION_ROLE -- assume-role-policy- document file://ta sk-execution-assume- role.json</pre>	Cloud architect
Register the task definition to the cluster.	On your local machine, run the following command. <pre>aws ecs register-task- definition --cli-inp ut-json file://ex ternal-task-defini tion.json</pre>	Cloud architect

Task	Description	Skills required
Run the task.	<p>On your local machine, run the following command.</p> <pre>aws ecs run-task -- cluster \$CLUSTER_NAME --launch-type EXTERNAL --task-definition nginx</pre>	Cloud architect
Validate the task running state.	<p>To fetch the task ID, run the following command.</p> <pre>export TEST_TASKID= \$(aws ecs list-tasks -- cluster \$CLUSTER_NAME   jq -r '.taskArns[0]')</pre> <p>With the task ID, run the following command.</p> <pre>aws ecs describe-tasks --cluster \$CLUSTER_ NAME --tasks \${TEST_TA SKID}</pre>	Cloud architect
Verify the task on the WorkSpace.	<p>To check that NGINX is running on the WorkSpace , run the command <code>curl http://localhost:8080</code> .</p>	App developer

## Related resources

- [ECS clusters](#)
- [Setting up a hybrid environment](#)



- [Amazon WorkSpaces](#)
- [Simple AD](#)

## Attachments

To access additional content that is associated with this document, unzip the following file:  
[attachment.zip](#)

# Run an ASP.NET Core web API Docker container on an Amazon EC2 Linux instance

Created by Vijai Anand Ramalingam (AWS) and Sreelaxmi Pai (AWS)

**Environment:** PoC or pilot

**Technologies:** Containers & microservices; Web & mobile apps

**Workload:** Microsoft

**AWS services:** Amazon EC2; Elastic Load Balancing (ELB)

## Summary

This pattern is for people who are starting to containerize their applications on the Amazon Web Services (AWS) Cloud. When you begin to containerize apps on cloud, usually there are no container orchestrating platforms set up. This pattern helps you quickly set up infrastructure on AWS to test your containerized applications without needing an elaborate container orchestrating infrastructure.

The first step in the modernization journey is to transform the application. If it's a legacy .NET Framework application, you must first change the runtime to ASP.NET Core. Then do the following:

- Create the Docker container image
- Run the Docker container using the built image
- Validate the application before deploying it on any container orchestration platform, such as Amazon Elastic Container Service (Amazon ECS) or Amazon Elastic Kubernetes Service (Amazon EKS).

This pattern covers the build, run, and validate aspects of modern application development on an Amazon Elastic Compute Cloud (Amazon EC2) Linux instance.

## Prerequisites and limitations

### Prerequisites

- An active [Amazon Web Services \(AWS\) account](#)
- An [AWS Identity and Access Management \(IAM\) role](#) with sufficient access to create AWS resources for this pattern
- [Visual Studio Community 2022](#) or later downloaded and installed
- A .NET Framework project modernized to ASP.NET Core
- A GitHub repository

## Product versions

- Visual Studio Community 2022 or later

## Architecture

### Target architecture

This pattern uses an [AWS CloudFormation template](#) to create the highly available architecture shown in the following diagram. An Amazon EC2 Linux instance is launched in a private subnet. AWS Systems Manager Session Manager is used to access the private Amazon EC2 Linux instance and to test the API running in the Docker container.

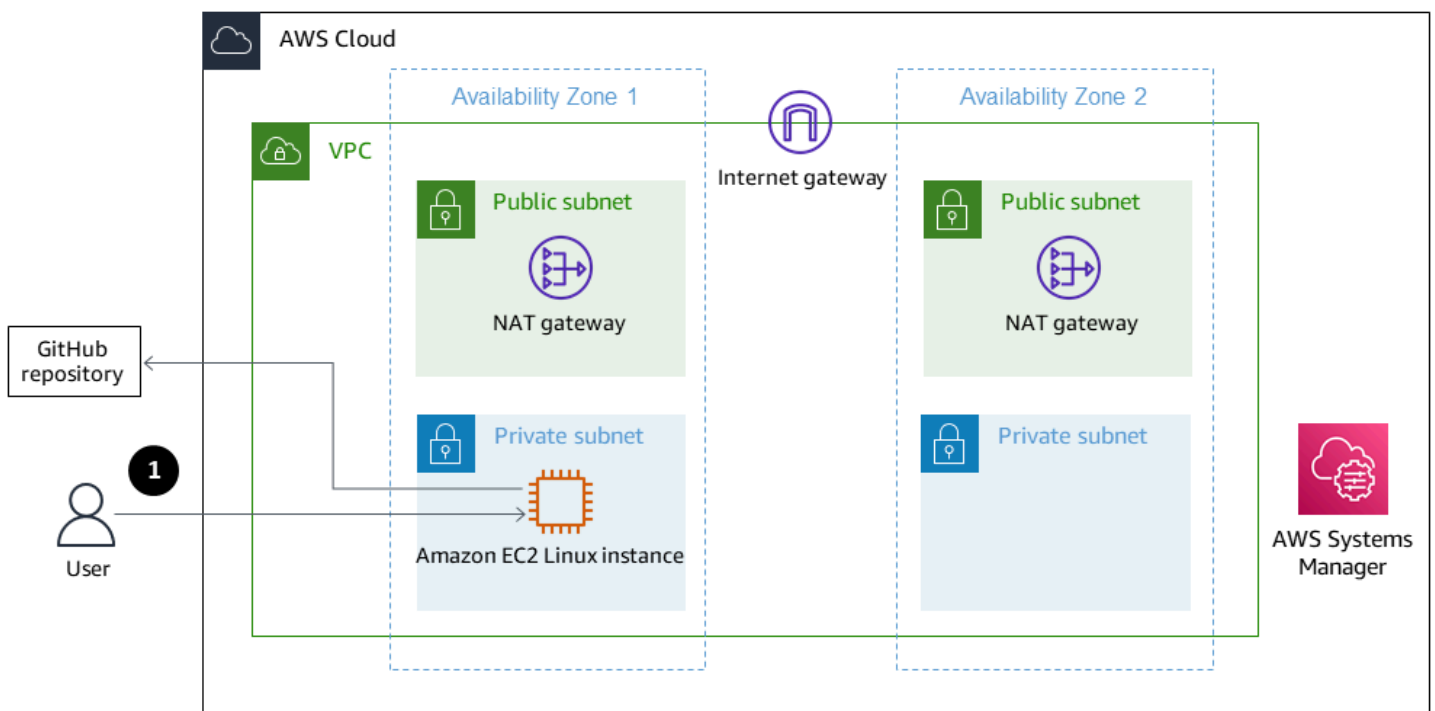

## 1. Access to the Linux instance through Session Manager

# Tools

### AWS services

- [AWS Command Line Interface](#) – AWS Command Line Interface (AWS CLI) is an open source tool for interacting with AWS services through commands in your command line shell. With minimal configuration, you can run AWS CLI commands that implement functionality equivalent to that provided by the browser-based AWS Management Console.
- [AWS Management Console](#) – The AWS Management Console is a web application that comprises and refers to a broad collection of service consoles for managing AWS resources. When you first sign in, you see the console home page. The home page provides access to each service console and offers a single place to access the information you need to perform your AWS related tasks.
- [AWS Systems Manager Session Manager](#) – Session Manager is a fully managed AWS Systems Manager capability. With Session Manager, you can manage your Amazon Elastic Compute Cloud (Amazon EC2) instances. Session Manager provides secure and auditable node management without the need to open inbound ports, maintain bastion hosts, or manage SSH keys.

### Other tools

- [Visual Studio 2022](#) – Visual Studio 2022 is an integrated development environment (IDE).
- [Docker](#) – Docker is a set of platform as a service (PaaS) products that use virtualization at the operating-system level to deliver software in containers.

### Code

```
FROM mcr.microsoft.com/dotnet/aspnet:5.0 AS base
WORKDIR /app
EXPOSE 80
EXPOSE 443

FROM mcr.microsoft.com/dotnet/sdk:5.0 AS build
WORKDIR /src
COPY ["DemoNetCoreWebAPI/DemoNetCoreWebAPI.csproj", "DemoNetCoreWebAPI/"]
RUN dotnet restore "DemoNetCoreWebAPI/DemoNetCoreWebAPI.csproj"
COPY . .
WORKDIR "/src/DemoNetCoreWebAPI"
```

```
RUN dotnet build "DemoNetCoreWebAPI.csproj" -c Release -o /app/build

FROM build AS publish
RUN dotnet publish "DemoNetCoreWebAPI.csproj" -c Release -o /app/publish

FROM base AS final
WORKDIR /app
COPY --from=publish /app/publish .
ENTRYPOINT ["dotnet", "DemoNetCoreWebAPI.dll"]
```

## Epics

### Develop the ASP.NET Core web API

Task	Description	Skills required
Create an example ASP.NET Core web API using Visual Studio.	<p>To create an example ASP.NET Core web API, do the following:</p> <ol style="list-style-type: none"><li>1. Open Visual Studio 2022.</li><li>2. Choose <b>Create a new project</b>.</li><li>3. Select the <b>ASP.NET Core Web API</b> project template, and choose <b>Next</b>.</li><li>4. For the project name, enter <b>DemoNetCoreWebAPI</b>, and choose <b>Next</b>.</li><li>5. Choose <b>Create</b>.</li><li>6. To run the project locally, press F5.</li><li>7. Verify that the default <b>WeatherForecast</b> API endpoint is returning the results using <a href="#">Swagger</a>.</li></ol>	App developer

Task	Description	Skills required
	<p>8. Open the command prompt, navigate to the .csproj project folder, and run the following commands to push the new web API to your GitHub repository.</p> <pre data-bbox="630 569 1029 768">git add --all git commit -m "Initial Version" git push</pre>	

Task	Description	Skills required
Create a Dockerfile.	<p>To create a Dockerfile, do one of the following:</p> <ul style="list-style-type: none"><li>• Create the Dockerfile manually using the sample Dockerfile in the <i>Code</i> section. Based on the requirements, select the appropriate .NET base image. For information about .NET and ASP.NET Core related images, see <a href="#">Docker hub</a>.</li><li>• Create the Dockerfile using Visual Studio and <a href="#">Docker Desktop</a>. In the solution explorer, right click on the project, choose <b>Add-&gt;Docker Support</b>. For <b>Target OS</b>, select <b>Linux</b>. Ensure that the new Dockerfile is in the same path as the solution file (.sln).</li></ul> <p>To push the changes to your GitHub repository, run the following command.</p> <pre>git add --all git commit -m "Dockerfile added" git push</pre>	App developer

## Set up the Amazon EC2 Linux instance

Task	Description	Skills required
Set up the infrastructure.	<p>Launch the <a href="#">AWS CloudFormation template</a> to create the infrastructure, which includes the following:</p> <ul style="list-style-type: none"><li>• A virtual private cloud (VPC), using the <a href="#">AWS VPC Quick Start</a>, with two public and two private subnets spanning two Availability Zones.</li><li>• The required IAM role to enable AWS Systems Manager.</li><li>• In one of the private subnets, an Amazon Linux 2 demo instance with the latest SSM Agent. Although this instance doesn't have any direct connectivity from the internet, it can be accessed securely by using AWS Systems Manager Session Manager without requiring a bastion host.</li></ul> <p><b>Note:</b> Amazon Linux 2 is nearing end of support. For more information, see the <a href="#">Amazon Linux 2 FAQs</a>.</p> <p>To learn more about accessing a private Amazon EC2</p>	App developer, AWS administrator, AWS DevOps



Task	Description	Skills required
	instance using Session Manager without requiring a bastion host, see the <a href="#">Toward a bastion-less world</a> blog post.	
Log in to the Amazon EC2 Linux instance.	<p>To connect to the Amazon EC2 Linux instance in the private subnet, do the following:</p> <ol style="list-style-type: none"><li>1. Open the Amazon EC2 console.</li><li>2. In the navigation pane, choose <b>Instances</b>.</li><li>3. Select the Amazon Linux 2 demo instance, and choose <b>Connect</b>.</li></ol> <p><b>Note:</b> Amazon Linux 2 is nearing end of support. For more information, see the <a href="#">Amazon Linux 2 FAQs</a>.</p> <ol style="list-style-type: none"><li>4. Choose <b>Session Manager</b>.</li><li>5. Choose <b>Connect</b> to open a new terminal window.</li><li>6. Run the following command.</li></ol> <pre>sudo su</pre>	App developer

Task	Description	Skills required
Install and start Docker.	<p>To install and start Docker in the Amazon EC2 Linux instance, do the following:</p> <ol style="list-style-type: none"><li>1. To install Docker, run the following command. <pre>yum install -y docker</pre></li><li>2. To start the Docker service, run the following command. <pre>service docker start</pre></li><li>3. To verify Docker installation, run the following command. <pre>docker info</pre></li></ol>	App developer, AWS administrator, AWS DevOps

Task	Description	Skills required
Install Git and clone the repository.	<p>To install Git on the Amazon EC2 Linux instance and clone the repository from GitHub, do the following.</p> <ol style="list-style-type: none"><li>1. To install Git, run the following command.</li></ol> <pre data-bbox="634 569 1027 646">yum install git -y</pre> <ol style="list-style-type: none"><li>2. To clone the repository, run the following command.</li></ol> <pre data-bbox="634 785 1027 940">git clone https://github.com/&lt;username&gt;/&lt;repo-name&gt;.git</pre> <ol style="list-style-type: none"><li>3. To navigate to the Dockerfile, run the following command.</li></ol> <pre data-bbox="634 1129 1027 1245">cd &lt;repo-name&gt;/DemoNextCoreWebAPI/</pre>	App developer, AWS administrator, AWS DevOps

Task	Description	Skills required
Build and run the Docker container.	<p>To build the Docker image and run the container inside the Amazon EC2 Linux instance, do the following:</p> <ol style="list-style-type: none"><li>1. To create the Docker image, run the following command.</li></ol> <pre>docker build -t aspnetcorewebapiimage -f Dockerfile .</pre> <ol style="list-style-type: none"><li>2. To view all the Docker images, run the following command.</li></ol> <pre>docker images</pre> <ol style="list-style-type: none"><li>3. To create and run the container, run the following command.</li></ol> <pre>docker run -d -p 80:80 --name aspnetcorewebapicontainer aspnetcorewebapiimage</pre>	App developer, AWS administrator, AWS DevOps

## Test the web API

Task	Description	Skills required
Test the web API using the curl command.	To test the web API, run the following command.	App developer

Task	Description	Skills required
	<pre>curl -X GET "http://localhost/WeatherForecast" -H "accept: text/plain"</pre> <p>Verify the API response.</p> <p><b>Note:</b> You can get the curl commands for each endpoint from Swagger when you are running it locally.</p>	

## Clean up resources

Task	Description	Skills required
Delete all resources.	Delete the stack to remove all the resources. This ensures that you aren't charged for any services that you aren't using.	AWS administrator, AWS DevOps

## Related resources

- [Connect to your Linux instance from Windows using PuTTY](#)
- [Create a web API with ASP.NET Core](#)
- [Toward a bastion-less world](#)

# Run message-driven workloads at scale by using AWS Fargate

Created by Stan Zubarev (AWS)

**Environment:** PoC or pilot

**Technologies:** Containers & microservices; Messaging & communications; Databases

**AWS services:** AWS Fargate; Amazon SQS; Amazon DynamoDB

## Summary

This pattern shows how to run message-driven workloads at scale in the AWS Cloud by using containers and AWS Fargate.

Using containers to process data can be helpful when the amount of data an application processes exceeds the limitations of function-based serverless compute services. For example, if an application requires more compute capacity or processing time than what AWS Lambda offers, using Fargate can improve performance.

The following example setup uses the [AWS Cloud Development Kit \(AWS CDK\) in TypeScript](#) to configure and deploy the following resources in the AWS Cloud:

- A Fargate service
- An Amazon Simple Queue Service (Amazon SQS) queue
- An Amazon DynamoDB table.
- An Amazon CloudWatch dashboard

The Fargate service receives and processes messages from the Amazon SQS queue, then stores them in the Amazon DynamoDB table. You can monitor how many Amazon SQS messages are processed and how many DynamoDB items are created by Fargate by using the CloudWatch dashboard.

**Note:** You can also use this pattern's example code to build more complex data processing workloads in event-driven serverless architectures. For more information, see [Run event-driven and scheduled workloads at scale with AWS Fargate](#).

## Prerequisites and limitations

### Prerequisites

- An active AWS account
- The latest version of the [AWS Command Line Interface \(AWS CLI\)](#), installed and configured on your local machine
- [Git](#), installed and configured on your local machine
- The [AWS CDK](#), installed and configured on your local machine
- [Go](#), installed and configured on your local machine
- [Docker](#), installed and configured on your local machine

## Architecture

### Target technology stack

- Amazon SQS
- AWS Fargate
- Amazon DynamoDB

### Target architecture

The following diagram shows an example workflow for running message-driven workloads at scale in the AWS Cloud by using Fargate:

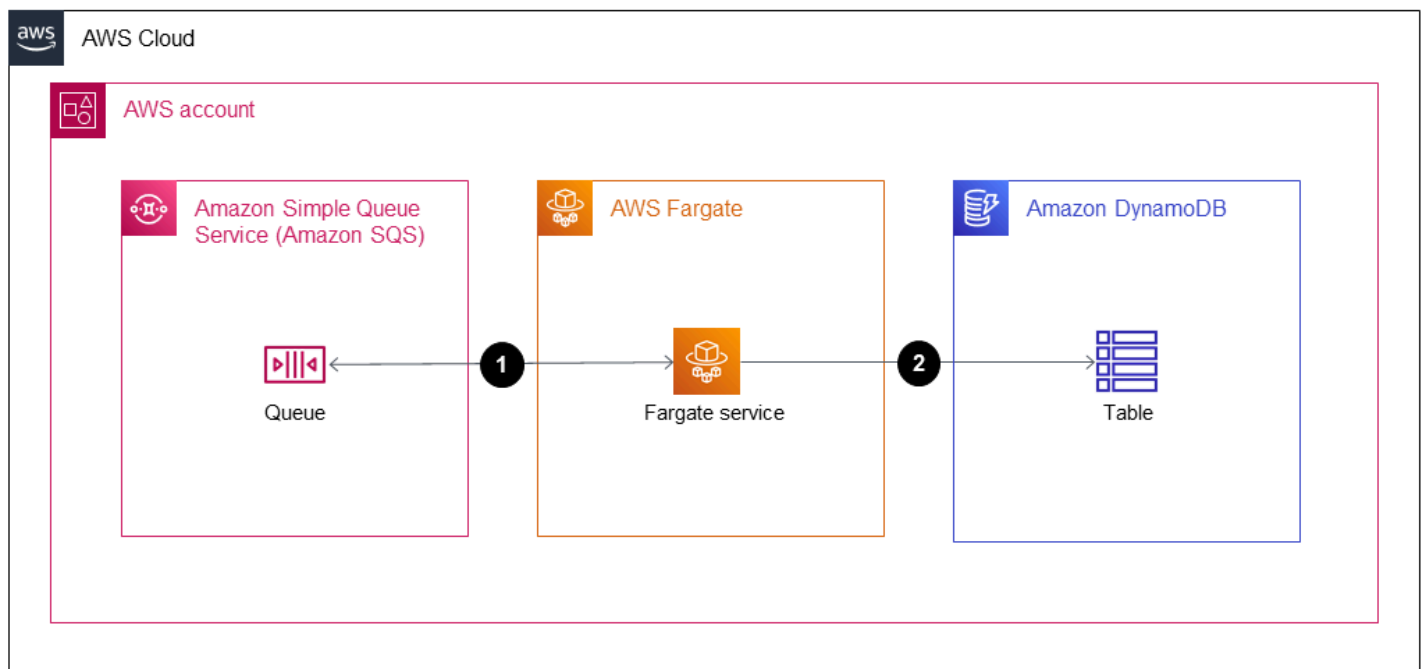

The diagram shows the following workflow:

1. The Fargate service uses [Amazon SQS long polling](#) to receive messages from an Amazon SQS queue.
2. The Fargate service then processes the Amazon SQS messages and stores them in a DynamoDB table.

## Automation and scale

To automate scaling your Fargate task count, you can configure Amazon Elastic Container Service (Amazon ECS) Service Auto Scaling. It's a best practice to configure the scaling policy based on the number of visible messages in your application's Amazon SQS queue.

For more information, see [Scaling based on Amazon SQS](#) in the *Amazon EC2 Auto Scaling User Guide*.

## Tools

### AWS services

- [AWS Fargate](#) helps you run containers without needing to manage servers or Amazon Elastic Compute Cloud (Amazon EC2) instances. It's used in conjunction with Amazon Elastic Container Service (Amazon ECS).



- [Amazon Simple Queue Service \(Amazon SQS\)](#) provides a secure, durable, and available hosted queue that helps you integrate and decouple distributed software systems and components.
- [Amazon DynamoDB](#) is a fully managed NoSQL database service that provides fast, predictable, and scalable performance.
- [Amazon CloudWatch](#) helps you monitor the metrics of your AWS resources and the applications you run on AWS in real time.

## Code

The code for this pattern is available in the GitHub [sqs-fargate-ddb-cdk-go](#) repository.

## Epics

### Create and deploy the resources by using the AWS CDK

Task	Description	Skills required
Clone the GitHub repository.	Clone the GitHub <a href="#">sqs-fargate-ddb-cdk-go</a> repository to your local machine by running the following command:  <pre>git clone https://github.com/aws-samples/sqs-fargate-ddb-cdk-go.git</pre>	App developer
Verify that the AWS CLI is configured to the correct AWS account and that the AWS CDK has the required permissions.	To check if your AWS CLI configuration settings are correct, you can run the following Amazon Simple Storage Service (Amazon S3) <a href="#">ls</a> command:  <pre>aws s3 ls</pre> <p>This procedure also requires the AWS CDK to have</p>	App developer

Task	Description	Skills required
	<p>permissions to provision infrastructure within your AWS account. To grant the required permissions, you must create named AWS profile in AWS CLI and export it as an <b>AWS_PROFILE</b> environment variable.</p> <p><b>Note:</b> If you haven't used the AWS CDK in your AWS account before, you must first provision the required AWS CDK resources. For more information, see <a href="#">Bootstrap ping</a> in the <i>AWS CDK v2 Developer Guide</i>.</p>	

Task	Description	Skills required
Deploy the AWS CDK stack to your AWS account.	<ol style="list-style-type: none"> <li>Build a container image by running the following AWS CLI command:  <code>docker build -t go-fargate .</code></li> <li>Open the AWS CDK directory by running the following command:  <code>cd cdk</code></li> <li>Install the required npm modules by running the following command:  <code>npm i</code></li> <li>Deploy the AWS CDK pattern to your AWS account by running the following command:  <code>cdk deploy --profile \${AWS_PROFILE}</code></li> </ol>	App developer

## Test the setup

Task	Description	Skills required
Send a test message to the Amazon SQS queue.	<p>For instructions, see <a href="#">Sending messages to a queue (console)</a> in the <i>Amazon SQS Developer Guide</i>.</p> <p><b>Test Amazon SQS message example</b></p>	App developer

Task	Description	Skills required
	<pre>{   "message": "hello,   Fargate" }</pre>	
Verify that the test message appears in the Fargate service's CloudWatch logs.	Follow the instructions in <a href="#">Viewing CloudWatch Logs</a> in the <i>Amazon ECS Developer Guide</i> . Make sure that you review the logs for the <b>go-fargate-service</b> log group in the <b>go-service-cluster</b> ECS cluster.	App developer
Verify that the test message appears in the DynamoDB table.	<ol style="list-style-type: none"><li>1. Open the <a href="#">DynamoDB console</a>.</li><li>2. In the left navigation pane, choose Tables. Then, select the following table from the list: <b>sqs-fargate-ddb-table</b>.</li><li>3. Choose <b>Explore table items</b>.</li><li>4. Verify that the test message appears in the <b>Items returned</b> list.</li></ol>	App developer

Task	Description	Skills required
Verify that the Fargate service is sending messages to CloudWatch Logs.	<ol style="list-style-type: none"><li>1. Open the <a href="#">CloudWatch console</a>.</li><li>2. In the left navigation pane, choose <b>Dashboards</b>.</li><li>3. In the Custom Dashboards list, select the dashboard named <b>go-service-dashboard</b>.</li><li>4. Verify that the test message appears in the logs.</li></ol> <p><b>Note:</b> The AWS CDK creates the CloudWatch dashboard in your AWS account automatically.</p>	App developer

## Clean up

Task	Description	Skills required
Delete the AWS CDK stack.	<ol style="list-style-type: none"><li>1. Open your AWS CDK directory in the AWS CLI by running the following command:  <pre>cd cdk</pre></li><li>2. Delete the AWS CDK stack by running the following command:</li></ol>	App developer

Task	Description	Skills required
	<pre>cdk destroy -- profile \${AWS_PRO FILE}</pre>	
Verify that the AWS CDK stack is deleted.	<p>To make sure that the stack was deleted, run the following command:</p> <pre>aws cloudformation list-stacks --query \ "StackSummaries[? contains(StackName ,'SqsFargate')].St ackStatus" \ --profile \${AWS_PRO FILE}</pre> <p>The <code>StackStatus</code> value returned in the command output is <code>DELETE_COMPLETE</code> if the stack is deleted.</p> <p>For more information, see <a href="#">Describing and listing your stacks</a> in the <i>AWS CloudFormation User Guide</i>.</p>	App developer

## Related resources

- [Configuring AWS CLI](#) (*AWS CLI User Guide for Version 2*)
- [API reference](#) (*AWS CDK API Reference*)
- [AWS SDK for Go v2](#) (Go documentation)

# Run stateful workloads with persistent data storage by using Amazon EFS on Amazon EKS with AWS Fargate

Created by Ricardo Morais (AWS), Rodrigo Bersa (AWS), and Lucio Pereira (AWS)

<b>Code repository:</b> <a href="#">Amazon EKS with Fargate and Amazon EFS</a>	<b>Environment:</b> PoC or pilot	<b>Technologies:</b> Containers & microservices; Storage & backup
<b>Workload:</b> Open-source	<b>AWS services:</b> Amazon EFS; Amazon EKS; AWS Fargate	

## Summary

This pattern provides guidance for enabling Amazon Elastic File System (Amazon EFS) as a storage device for containers that are running on Amazon Elastic Kubernetes Service (Amazon EKS) by using AWS Fargate to provision your compute resources.

The setup described in this pattern follows security best practices and provides security at rest and security in transit by default. To encrypt your Amazon EFS file system, it uses an AWS Key Management Service (AWS KMS) key, but you can also specify a key alias that dispatches the process of creating a KMS key.

You can follow the steps in this pattern to create a namespace and Fargate profile for a proof-of-concept (PoC) application, install the Amazon EFS Container Storage Interface (CSI) driver that is used to integrate the Kubernetes cluster with Amazon EFS, configure the storage class, and deploy the PoC application. These steps result in an Amazon EFS file system that is shared among multiple Kubernetes workloads, running over Fargate. The pattern is accompanied by scripts that automate these steps.

You can use this pattern if you want data persistence in your containerized applications and want to avoid data loss during scaling operations. For example:

- **DevOps tools** – A common scenario is to develop a continuous integration and continuous delivery (CI/CD) strategy. In this case, you can use Amazon EFS as a shared file system to store configurations among different instances of the CI/CD tool or to store a cache (for example, an Apache Maven repository) for pipeline stages among different instances of the CI/CD tool.

- **Web servers** – A common scenario is to use Apache as an HTTP web server. You can use Amazon EFS as a shared file system to store static files that are shared among different instances of the web server. In this example scenario, modifications are applied directly to the file system instead of static files being baked into a Docker image.

## Prerequisites and limitations

### Prerequisites

- An active AWS account
- An existing Amazon EKS cluster with Kubernetes version 1.17 or later (tested up to version 1.27)
- An existing Amazon EFS file system to bind a Kubernetes StorageClass and provision file systems dynamically
- Cluster administration permissions
- Context configured to point to the desired Amazon EKS cluster

### Limitations

- There are some limitations to consider when you're using Amazon EKS with Fargate. For example, the use of some Kubernetes constructs, such as DaemonSets and privileged containers, aren't supported. For more information, about Fargate limitations, see the [AWS Fargate considerations](#) in the Amazon EKS documentation.
- The code provided with this pattern supports workstations that are running Linux or macOS.

### Product versions

- AWS Command Line Interface (AWS CLI) version 2 or later
- Amazon EFS CSI driver version 1.0 or later (tested up to version 2.4.8)
- eksctl version 0.24.0 or later (tested up to version 0.158.0)
- jq version 1.6 or later
- kubectl version 1.17 or later (tested up to version 1.27)
- Kubernetes version 1.17 or later (tested up to version 1.27)



---

# Architecture

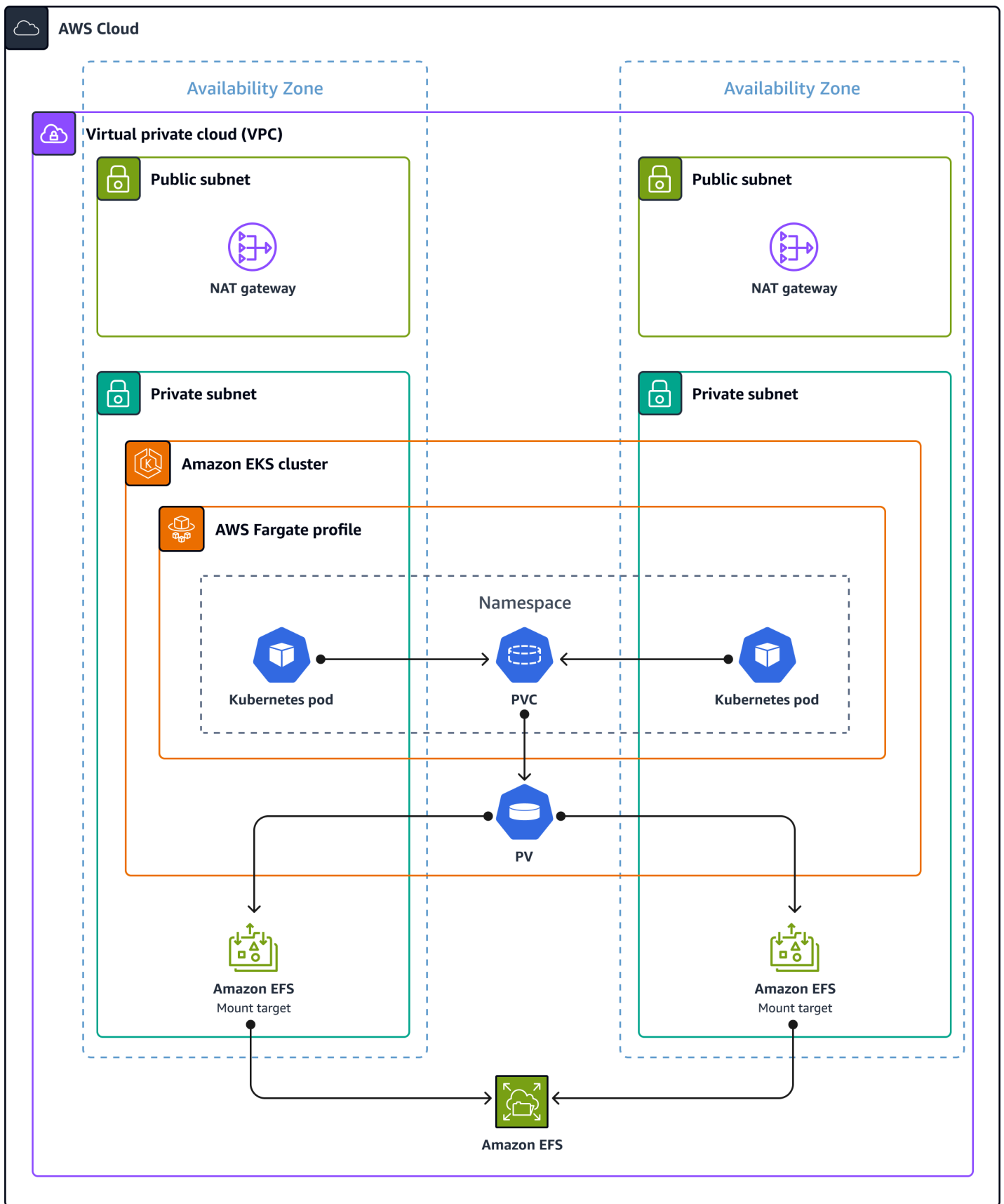

The target architecture is comprised of the following infrastructure:

- A virtual private cloud (VPC)
- Two Availability Zones
- A public subnet with a NAT gateway that provides internet access
- A private subnet with an Amazon EKS cluster and Amazon EFS mount targets (also known as *mount points*)
- Amazon EFS at the VPC level

The following is the environment infrastructure for the Amazon EKS cluster:

- AWS Fargate profiles that accommodate the Kubernetes constructs at the namespace level
- A Kubernetes namespace with:
  - Two application pods distributed across Availability Zones
  - One persistent volume claim (PVC) bound to a persistent volume (PV) at the cluster level
- A cluster-wide PV that is bound to the PVC in the namespace and that points to the Amazon EFS mount targets in the private subnet, outside of the cluster

## Tools

### AWS services

- [AWS Command Line Interface \(AWS CLI\)](#) is an open-source tool that you can use to interact with AWS services from the command line.
- [Amazon Elastic File System \(Amazon EFS\)](#) helps you create and configure shared file systems in the AWS Cloud. In this pattern, it provides a simple, scalable, fully managed, and shared file system for use with Amazon EKS.
- [Amazon Elastic Kubernetes Service \(Amazon EKS\)](#) helps you run Kubernetes on AWS without needing to install or operate your own clusters.
- [AWS Fargate](#) is a serverless compute engine for Amazon EKS. It creates and manages compute resources for your Kubernetes applications.
- [AWS Key Management Service \(AWS KMS\)](#) helps you create and control cryptographic keys to help protect your data.

## Other tools

- [Docker](#) is a set of platform as a service (PaaS) products that use virtualization at the operating-system level to deliver software in containers.
- [eksctl](#) is a command-line utility for creating and managing Kubernetes clusters on Amazon EKS.
- [kubectrl](#) is a command-line interface that helps you run commands against Kubernetes clusters.
- [jq](#) is a command-line tool for parsing JSON.

## Code

The code for this pattern is provided in the GitHub [Persistence Configuration with Amazon EFS on Amazon EKS using AWS Fargate](#) repo. The scripts are organized by epic, in the folders epic01 through epic06, corresponding to the order in the [Epics](#) section in this pattern.

## Best practices

The target architecture includes the following services and components, and it follows [AWS Well-Architected Framework](#) best practices:

- Amazon EFS, which provides a simple, scalable, fully managed elastic NFS file system. This is used as a shared file system among all replications of the PoC application that are running in pods, which are distributed in the private subnets of the chosen Amazon EKS cluster.
- An Amazon EFS mount target for each private subnet. This provides redundancy per Availability Zone within the virtual private cloud (VPC) of the cluster.
- Amazon EKS, which runs the Kubernetes workloads. You must provision an Amazon EKS cluster before you use this pattern, as described in the [Prerequisites](#) section.
- AWS KMS, which provides encryption at rest for the content that's stored in the Amazon EFS file system.
- Fargate, which manages the compute resources for the containers so that you can focus on business requirements instead of infrastructure burden. The Fargate profile is created for all private subnets. It provides redundancy per Availability Zone within the virtual private cloud (VPC) of the cluster.
- Kubernetes Pods, for validating that content can be shared, consumed, and written by different instances of an application.

## Epics

### Provision an Amazon EKS cluster (optional)

Task	Description	Skills required
Create an Amazon EKS cluster.	If you already have a cluster deployed, skip to the next epic. Create an Amazon EKS cluster in your existing AWS account. In the <a href="#">GitHub Repo directory</a> , use one of the patterns to deploy an Amazon EKS cluster by using Terraform or eksctl. For more information, see <a href="#">Creating an Amazon EKS cluster</a> in the Amazon EKS documentation. Note: In the Terraform pattern, there are also examples showing how to: link Fargate profiles to your Amazon EKS cluster, create an Amazon EFS file system, and deploy Amazon EFS CSI driver in your Amazon EKS cluster.	AWS administrator, Terraform or eksctl administrator, Kubernetes administrator
Export environment variables.	Run the env.sh script. This provides the information required in the next steps. <pre>source ./scripts/env.sh Inform the AWS Account ID: &lt;13-digit-account-id&gt; Inform your AWS Region: &lt;aws-Region-code&gt;</pre>	AWS systems administrator

Task	Description	Skills required
	<p>Inform your Amazon EKS Cluster Name:  <code>&lt;amazon-eks-cluster-name&gt;</code></p> <p>Inform the Amazon EFS Creation Token:  <code>&lt;self-generated-uuid&gt;</code></p> <p>If not noted yet, you can get all the information requested above with the following CLI commands.</p> <pre># ACCOUNT ID aws sts get-caller-identity --query "Account" --output text</pre> <pre># REGION CODE aws configure get region</pre> <pre># CLUSTER EKS NAME aws eks list-clusters --query "clusters" --output text</pre> <pre># GENERATE EFS TOKEN uuidgen</pre>	

## Create a Kubernetes namespace and a linked Fargate profile

Task	Description	Skills required
Create a Kubernetes namespace and Fargate	Create a namespace for receiving the application	Kubernetes user with granted permissions

Task	Description	Skills required
<p>profile for application workloads.</p>	<p>workloads that interact with Amazon EFS. Run the <code>create-k8s-ns-and-linked-fargate-profile.sh</code> script. You can choose to use a custom namespace name or the default provided namespace <code>poc-efs-eks-fargate</code>.</p> <p><b>With a custom application namespace name:</b></p> <pre>export \$APP_NAME SPACE=&lt;CUSTOM_NAME&gt; ./scripts/epic01/ create-k8s-ns-and- -linked-fargate-pr ofile.sh \ -c "\$CLUSTER_NAME" -n "\$APP_NAMESPACE"</pre> <p><b>Without a custom application namespace name:</b></p> <pre>./scripts/epic01/c reate-k8s-ns-and-l inked-fargate-prof ile.sh \ -c "\$CLUSTER_NAME"</pre> <p>where <code>\$CLUSTER_NAME</code> is the name of your Amazon EKS cluster. The <code>-n &lt;NAMESPACE&gt;</code> parameter is optional; if not informed, a</p>	

Task	Description	Skills required
	default generated namespace name will be provided.	

## Create an Amazon EFS file system

Task	Description	Skills required
Generate a unique token.	Amazon EFS requires a creation token to ensure idempotent operation (calling the operation with the same creation token has no effect). To meet this requirement, you must generate a unique token through an available technique. For example, you can generate a universally unique identifier (UUID) to use as a creation token.	AWS systems administrator
Create an Amazon EFS file system.	Create the file system for receiving the data files that are read and written by the application workloads. You can create an encrypted or non-encrypted file system. (As a best practice, the code for this pattern creates an encrypted system to enable encryption at rest by default.) You can use a unique, symmetric AWS KMS key to encrypt your file system. If a custom key is not	AWS systems administrator



Task	Description	Skills required
	<p>specified, an AWS managed key is used.</p> <p>Use the create-efs.sh script to create an encrypted or non-encrypted Amazon EFS file system, after you generate a unique token for Amazon EFS.</p> <p><b>With encryption at rest, without a KMS key:</b></p> <pre data-bbox="597 730 1026 1003">./scripts/epic02/c reate-efs.sh \   -c "\$CLUSTER_NAME"  \   -t "\$EFS_CRE ATION_TOKEN"</pre> <p>where <code>\$CLUSTER_NAME</code> is the name of your Amazon EKS cluster and <code>\$EFS_CREATION_TOKEN</code> is a unique creation token for the file system.</p> <p><b>With encryption at rest, with a KMS key:</b></p> <pre data-bbox="597 1486 1026 1801">./scripts/epic02/c reate-efs.sh \   -c "\$CLUSTER_NAME"  \   -t "\$EFS_CRE ATION_TOKEN" \   -k "\$KMS_KEY_ALIAS"</pre>	

Task	Description	Skills required
	<p>where <code>\$CLUSTER_NAME</code> is the name of your Amazon EKS cluster, <code>\$EFS_CREATION_TOKEN</code> is a unique creation token for the file system, and <code>\$KMS_KEY_ALIAS</code> is the alias for the KMS key.</p> <p><b>Without encryption:</b></p> <pre data-bbox="597 699 1027 978">./scripts/epic02/create-efs.sh -d \   -c "\$CLUSTER_NAME" \   -t "\$EFS_CREATION_TOKEN"</pre> <p>where <code>\$CLUSTER_NAME</code> is the name of your Amazon EKS cluster, <code>\$EFS_CREATION_TOKEN</code> is a unique creation token for the file system, and <code>-d</code> disables encryption at rest.</p>	
Create a security group.	Create a security group to allow the Amazon EKS cluster to access the Amazon EFS file system.	AWS systems administrator

Task	Description	Skills required
Update the inbound rule for the security group.	Update the inbound rules of the security group to allow incoming traffic for the following settings: <ul style="list-style-type: none"> <li>• <b>TCP protocol</b> – port 2049</li> <li>• <b>Source</b> – CIDR block ranges for the private subnets in the VPC that contains the Kubernetes cluster</li> </ul>	AWS systems administrator
Add a mount target for each private subnet.	For each private subnet of the Kubernetes cluster, create a mount target for the file system and the security group.	AWS systems administrator

### Install Amazon EFS components into the Kubernetes cluster

Task	Description	Skills required
Deploy the Amazon EFS CSI driver.	Deploy the Amazon EFS CSI driver into the cluster. The driver provisions storage according to persistent volume claims created by applications. Run the <code>create-k8s-efs-csi-sc.sh</code> script to deploy the Amazon EFS CSI driver and the storage class into the cluster.	Kubernetes user with granted permissions

Task	Description	Skills required
	<pre data-bbox="594 212 1026 369">./scripts/epic03/create-k8s-efs-csi-sc.sh</pre> <p data-bbox="594 407 1008 632">This script uses the <code>kubectl</code> utility, so make sure that the context has been configured and point to the desired Amazon EKS cluster.</p>	
Deploy the storage class.	Deploy the storage class into the cluster for the Amazon EFS provisioner ( <code>efs.csi.aws.com</code> ).	Kubernetes user with granted permissions

## Install the PoC application into the Kubernetes cluster

Task	Description	Skills required
Deploy the persistent volume.	<p data-bbox="594 1150 1026 1843">Deploy the persistent volume, and link it to the created storage class and to the ID of the Amazon EFS file system. The application uses the persistent volume to read and write content. You can specify any size for the persistent volume in the storage field. Kubernetes requires this field, but because Amazon EFS is an elastic file system, it does not enforce any file system capacity. You can deploy the persistent volume</p>	Kubernetes user with granted permissions

Task	Description	Skills required
	<p>with or without encryption. (The Amazon EFS CSI driver enables encryption by default, as a best practice.)</p> <p>) Run the <code>deploy-poc-app.sh</code> script to deploy the persistent volume, the persistent volume claim, and the two workloads.</p> <p><b>With encryption in transit:</b></p> <pre data-bbox="594 743 1029 945">./scripts/epic04/deploy-poc-app.sh \   -t "\$EFS_CREATION_TOKEN"</pre> <p>where <code>\$EFS_CREATION_TOKEN</code> is the unique creation token for the file system.</p> <p><b>Without encryption in transit:</b></p> <pre data-bbox="594 1325 1029 1526">./scripts/epic04/deploy-poc-app.sh -d \   -t "\$EFS_CREATION_TOKEN"</pre> <p>where <code>\$EFS_CREATION_TOKEN</code> is the unique creation token for the file system, and <code>-d</code> disables encryption in transit.</p>	

Task	Description	Skills required
Deploy the persistent volume claim requested by the application.	Deploy the persistent volume claim requested by the application, and link it to the storage class. Use the same access mode as the persistent volume you created previously. You can specify any size for the persistent volume claim in the storage field. Kubernetes requires this field, but because Amazon EFS is an elastic file system, it does not enforce any file system capacity.	Kubernetes user with granted permissions
Deploy workload 1.	Deploy the pod that represents workload 1 of the application. This workload writes content to the file <code>/data/out1.txt</code> .	Kubernetes user with granted permissions
Deploy workload 2.	Deploy the pod that represents workload 2 of the application. This workload writes content to the file <code>/data/out2.txt</code> .	Kubernetes user with granted permissions

### Validate file system persistence, durability, and shareability

Task	Description	Skills required
Check the status of the <code>PersistentVolume</code> .	Enter the following command to check the status of the <code>PersistentVolume</code> .	Kubernetes user with granted permissions

Task	Description	Skills required
	<pre>kubectl get pv</pre> <p>For an example output, see the <a href="#">Additional information</a> section.</p>	
Check the status of the PersistentVolumeClaim .	Enter the following command to check the status of the PersistentVolumeClaim . <pre>kubectl -n poc-efs-eks-fargate get pvc</pre> <p>For an example output, see the <a href="#">Additional information</a> section.</p>	Kubernetes user with granted permissions

Task	Description	Skills required
Validate that workload 1 can write to the file system.	<p>Enter the following command to validate that workload 1 is writing to /data/out1.txt .</p> <pre>kubectl exec -ti poc-app1 -n poc-efs-eks-fargate -- tail -f /data/out1.txt</pre> <p>The results are similar to the following:</p> <pre>... Thu Sep  3 15:25:07 UTC 2023 - PoC APP 1 Thu Sep  3 15:25:12 UTC 2023 - PoC APP 1 Thu Sep  3 15:25:17 UTC 2023 - PoC APP 1 ...</pre>	Kubernetes user with granted permissions



Task	Description	Skills required
Validate that workload 2 can write to the file system.	<p>Enter the following command to validate that workload 2 is writing to /data/out 2.txt .</p> <pre>kubectl -n \$APP_NAME SPACE exec -ti poc-app2 -- tail -f /data/out 2.txt</pre> <p>The results are similar to the following:</p> <pre>... Thu Sep  3 15:26:48 UTC 2023 - PoC APP 2 Thu Sep  3 15:26:53 UTC 2023 - PoC APP 2 Thu Sep  3 15:26:58 UTC 2023 - PoC APP 2 ...</pre>	Kubernetes user with granted permissions

Task	Description	Skills required
Validate that workload 1 can read the file written by workload 2.	<p>Enter the following command to validate that workload 1 can read the /data/out2.txt file written by workload 2.</p> <pre>kubectl exec -ti poc-app1 -n poc-efs-eks-fargate -- tail -n 3 /data/out2.txt</pre> <p>The results are similar to the following:</p> <pre>... Thu Sep  3 15:26:48 UTC 2023 - PoC APP 2 Thu Sep  3 15:26:53 UTC 2023 - PoC APP 2 Thu Sep  3 15:26:58 UTC 2023 - PoC APP 2 ...</pre>	Kubernetes user with granted permissions

Task	Description	Skills required
Validate that workload 2 can read the file written by workload 1.	<p>Enter the following command to validate that workload 2 can read the /data/out1.txt file written by workload 1.</p> <pre>kubectl -n \$APP_NAME SPACE exec -ti poc-app2 -- tail -n 3 /data/out 1.txt</pre> <p>The results are similar to the following:</p> <pre>... Thu Sep  3 15:29:22 UTC 2023 - PoC APP 1 Thu Sep  3 15:29:27 UTC 2023 - PoC APP 1 Thu Sep  3 15:29:32 UTC 2023 - PoC APP 1 ...</pre>	Kubernetes user with granted permissions

Task	Description	Skills required
Validate that files are retained after you remove application components.	<p>Next, you use a script to remove the application components (persistent volume, persistent volume claim, and pods), and validate that the files <code>/data/out 1.txt</code> and <code>/data/out 2.txt</code> are retained in the file system. Run the <code>validate-efs-content.sh</code> script by using the following command.</p> <pre data-bbox="594 827 1029 1066">./scripts/epic05/validate-efs-content.sh \     -t "\$EFS_CREATION_TOKEN"</pre> <p>where <code>\$EFS_CREATION_TOKEN</code> is the unique creation token for the file system.</p> <p>The results are similar to the following:</p> <pre data-bbox="594 1444 1029 1856">pod/poc-app-validation created Waiting for pod get Running state... Waiting for pod get Running state... Waiting for pod get Running state... Results from execution of 'find /data' on</pre>	Kubernetes user with granted permissions, System administrator

Task	Description	Skills required
	<pre>validation process pod: /data /data/out2.txt /data/out1.txt</pre>	

## Monitor operations

Task	Description	Skills required
Monitor application logs.	As part of a day-two operation, ship the application logs to Amazon CloudWatch for monitoring.	AWS systems administrator, Kubernetes user with granted permissions
Monitor Amazon EKS and Kubernetes containers with Container Insights.	As part of a day-two operation, monitor the Amazon EKS and Kubernetes systems by using Amazon CloudWatch Container Insights. This tool collects, aggregates, and summarizes metrics from containerized applications at different levels and dimensions. For more information, see the <a href="#">Related resources</a> section.	AWS systems administrator, Kubernetes user with granted permissions
Monitor Amazon EFS with CloudWatch.	As part of a day-two operation, monitor the file systems using Amazon CloudWatch, which collects and processes raw data from Amazon EFS into readable, near real-time metrics. For	AWS systems administrator

Task	Description	Skills required
	more information, see the <a href="#">Related resources</a> section.	

## Clean up resources

Task	Description	Skills required
Clean up all created resources for the pattern.	<p>After you complete this pattern, clean up all resources , to avoid incurring AWS charges. Run the <code>clean-up-resources.sh</code> script to remove all resources after you have finished using the PoC application. Complete one of the following options.</p> <p><b>With encryption at rest, with a KMS key:</b></p> <pre>./scripts/epic06/clean-up-resources.sh \   \   -c "\$CLUSTER_NAME" \   \   -t "\$EFS_CREATION_TOKEN" \   -k "\$KMS_KEY_ALIAS"</pre> <p>where <code>\$CLUSTER_NAME</code> is the name of your Amazon EKS cluster, <code>\$EFS_CREATION_TOKEN</code> is the creation token for the file system, and <code>\$KMS_KEY_</code></p>	Kubernetes user with granted permissions, System administrator

Task	Description	Skills required
	<p>ALIAS is the alias for the KMS key.</p> <p><b>Without encryption at rest:</b></p> <pre>./scripts/epic06/clean-up-resources.sh \   -c "\$CLUSTER_NAME" \   -t "\$EFS_CREATION_TOKEN"</pre> <p>where \$CLUSTER_NAME is the name of your Amazon EKS cluster and \$EFS_CREATION_TOKEN is the creation token for the file system.</p>	

## Related resources

### References

- [AWS Fargate for Amazon EKS now supports Amazon EFS](#) (announcement)
- [How to capture application logs when using Amazon EKS on AWS Fargate](#) (blog post)
- [Using Container Insights](#) (Amazon CloudWatch documentation)
- [Setting Up Container Insights on Amazon EKS and Kubernetes](#) (Amazon CloudWatch documentation)
- [Amazon EKS and Kubernetes Container Insights metrics](#) (Amazon CloudWatch documentation)
- [Monitoring Amazon EFS with Amazon CloudWatch](#) (Amazon EFS documentation)

### GitHub tutorials and examples

- [Static provisioning](#)

- [Encryption in transit](#)
- [Accessing the file system from multiple pods](#)
- [Consuming Amazon EFS in StatefulSets](#)
- [Mounting subpaths](#)
- [Using Amazon EFS access points](#)
- [Amazon EKS Blueprints for Terraform](#)

## Required tools

- [Installing the AWS CLI version 2](#)
- [Installing eksctl](#)
- [Installing kubectl](#)
- [Installing jq](#)

## Additional information

The following is an example output of the `kubectl get pv` command.

NAME	CAPACITY	ACCESS MODES	RECLAIM POLICY	STATUS	CLAIM
poc-app-pv	1Mi	RWX	Retain	Bound	poc-efs-eks-fargate/
poc-app-pvc	efs-sc		3m56s		

The following is an example output of the `kubectl -n poc-efs-eks-fargate get pvc` command.

NAME	STATUS	VOLUME	CAPACITY	ACCESS MODES	STORAGECLASS	AGE
poc-app-pvc	Bound	poc-app-pv	1Mi	RWX	efs-sc	4m34s



## More patterns

- [Assess application readiness for migration to the AWS Cloud by using CAST Highlight](#)
- [Automatically build CI/CD pipelines and Amazon ECS clusters for microservices using AWS CDK](#)
- [Build and push Docker images to Amazon ECR using GitHub Actions and Terraform](#)
- [Containerize mainframe workloads that have been modernized by Blu Age](#)
- [Create a custom log parser for Amazon ECS using a Firelens log router](#)
- [Deploy a CI/CD pipeline for Java microservices on Amazon ECS](#)
- [Deploy an Amazon EKS cluster from AWS Cloud9 using an EC2 instance profile](#)
- [Deploy an environment for containerized Blu Age applications by using Terraform](#)
- [Deploy preprocessing logic into an ML model in a single endpoint using an inference pipeline in Amazon SageMaker](#)
- [Manage blue/green deployments of microservices to multiple accounts and Regions by using AWS code services and AWS KMS multi-Region keys](#)
- [Manage on-premises container applications by setting up Amazon ECS Anywhere with the AWS CDK](#)
- [Migrate from Oracle GlassFish to AWS Elastic Beanstalk](#)
- [Migrate from Oracle WebLogic to Apache Tomcat \(TomEE\) on Amazon ECS](#)
- [Set up a minimum viable data space to share data between organizations](#)
- [Modernize ASP.NET Web Forms applications on AWS](#)
- [Monitor Amazon ECR repositories for wildcard permissions using AWS CloudFormation and AWS Config](#)
- [Set up a CI/CD pipeline for hybrid workloads on Amazon ECS Anywhere by using AWS CDK and GitLab](#)
- [Set up a Helm v3 chart repository in Amazon S3](#)
- [Set up end-to-end encryption for applications on Amazon EKS using cert-manager and Let's Encrypt](#)
- [Simplify Amazon EKS multi-tenant application deployment by using Flux](#)
- [Structure a Python project in hexagonal architecture using AWS Lambda](#)
- [Train and deploy a custom GPU-supported ML model on Amazon SageMaker](#)

# Content delivery

## Topics

- [Send AWS WAF logs to Splunk by using AWS Firewall Manager and Amazon Data Firehose](#)
- [Serve static content in an Amazon S3 bucket through a VPC by using Amazon CloudFront](#)
- [More patterns](#)

# Send AWS WAF logs to Splunk by using AWS Firewall Manager and Amazon Data Firehose

Created by Michael Friedenthal (AWS), Aman Kaur Gandhi (AWS), and JJ Johnson (AWS)

**Environment:** PoC or pilot

**Technologies:** Content delivery; Security, identity, compliance

**Workload:** All other workloads

**AWS services:** AWS Firewall Manager; Amazon Data Firehose; AWS WAF

## Summary

Historically, there were two ways to move data into Splunk: a push or a pull architecture. A *pull architecture* offers delivery data guarantees through retries, but it requires dedicated resources in Splunk that poll data. Pull architectures usually are not real time because of the polling. A *push architecture* in typically has lower latency, is more scalable, and reduces operational complexity and costs. However, it doesn't guarantee delivery and typically requires agents.

Splunk integration with Amazon Data Firehose delivers real-time streaming data to Splunk through an HTTP event collector (HEC). This integration provides the advantages of both push and pull architectures—it guarantees data delivery through retries, is near real-time, and is low latency and low complexity. The HEC quickly and efficiently sends data over HTTP or HTTPS directly to Splunk. HECs are token-based, which eliminates the need to hardcode credentials in an application or in supporting files.

In an AWS Firewall Manager policy, you can configure logging for all of the AWS WAF web ACL traffic in all of your accounts, and you can then use a Firehose delivery stream to send that log data to Splunk for monitoring, visualization, and analysis. This solution provides the following benefits:

- Central management and logging for AWS WAF web ACL traffic in all of your accounts
- Splunk integration with a single AWS account
- Scalability
- Near real-time delivery of log data

- Cost optimization through the use of a serverless solution, so you don't have to pay for unused resources.

## Prerequisites and limitations

### Prerequisites

- An active AWS account that is part of an organization in AWS Organizations.
- You must have the following permissions to enable logging with Firehose:
  - `iam:CreateServiceLinkedRole`
  - `firehose:ListDeliveryStreams`
  - `wafv2:PutLoggingConfiguration`
- AWS WAF and its web ACLs must be configured. For instructions, see [Getting started with AWS WAF](#).
- AWS Firewall Manager must be setup. For instructions, see [AWS Firewall Manager prerequisites](#).
- The Firewall Manager security policies for AWS WAF must be configured. For instructions, see [Getting started with AWS Firewall Manager AWS WAF policies](#).
- Splunk must be setup with a public HTTP endpoint that can be reached by Firehose.

### Limitations

- The AWS accounts must be managed in a single organization in AWS Organizations.
- The web ACL must be in the same Region as the delivery stream. If you are capturing logs for Amazon CloudFront, create the Firehose delivery stream in the US East (N. Virginia) Region, `us-east-1`.
- The Splunk add-on for Firehose is available for paid Splunk Cloud deployments, distributed Splunk Enterprise deployments, and single-instance Splunk Enterprise deployments. This add-on is not supported for free trial Splunk Cloud deployments.

## Architecture

### Target technology stack

- Firewall Manager

- Firehose
- Amazon Simple Storage Service (Amazon S3)
- AWS WAF
- Splunk

## Target architecture

The following image shows how you can use Firewall Manager to centrally log all AWS WAF data and send it to Splunk through Firehose.

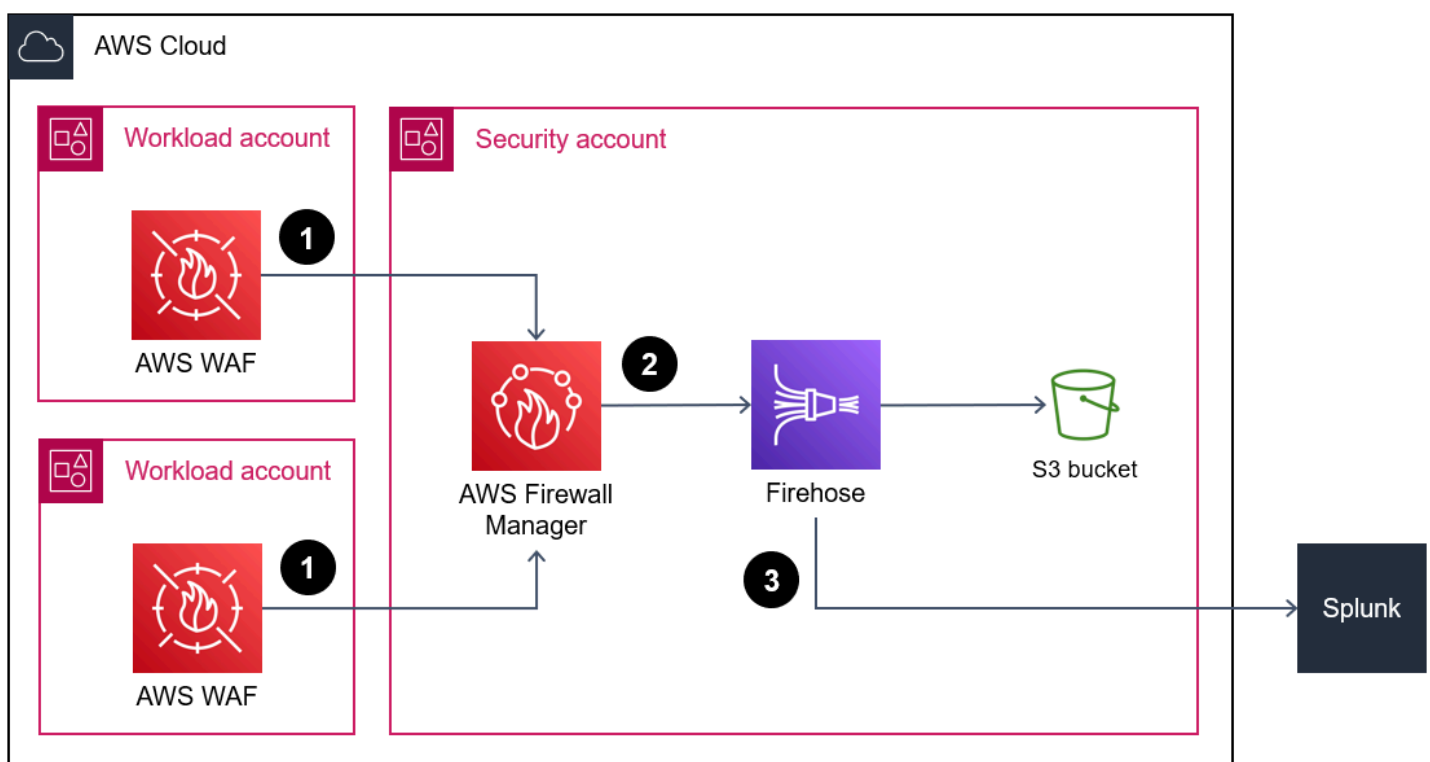

1. The AWS WAF web ACLs send firewall log data to Firewall Manager.
2. Firewall Manager sends the log data to Firehose.
3. The Firehose delivery stream forwards the log data to Splunk and to an S3 bucket. The S3 bucket acts as a backup in the event of an error with the Firehose delivery stream.

## Automation and scale

This solution is designed to scale and accommodate all AWS WAF web ACLs within the organization. You can configure all web ACLs to use the same Firehose instance. However, if you want to set up and use multiple Firehose instances, you can.

## Tools

### AWS services

- [AWS Firewall Manager](#) is a security management service that helps you to centrally configure and manage firewall rules across your accounts and applications in AWS Organizations.
- [Amazon Data Firehose](#) helps you deliver real-time [streaming data](#) to other AWS services, custom HTTP endpoints, and HTTP endpoints owned by supported third-party service providers, such as Splunk.
- [Amazon Simple Storage Service \(Amazon S3\)](#) is a cloud-based object storage service that helps you store, protect, and retrieve any amount of data.
- [AWS WAF](#) is a web application firewall that helps you monitor HTTP and HTTPS requests that are forwarded to your protected web application resources.

### Other tools

- [Splunk](#) helps you monitor, visualize, and analyze log data.

## Epics

### Configure Splunk

Task	Description	Skills required
Install the Splunk App for AWS.	<ol style="list-style-type: none"> <li>1. Sign in to your Splunk heavy forwarder. The default URL is <code>http://&lt;IP address&gt;:8000</code>.</li> <li>2. In the left navigation, next to <b>Apps</b>, choose the gear button.</li> <li>3. Choose <b>Browse more apps</b>.</li> </ol>	Security administrator, Splunk administrator

Task	Description	Skills required
	<ol style="list-style-type: none"><li>4. Search for <b>AWS</b>.</li><li>5. For <b>Splunk App for AWS</b>, choose <b>Install</b>.</li><li>6. Enter your Splunk.com sign-in credentials, accept the terms and conditions, and then choose <b>Login and Install</b>.</li><li>7. Choose <b>Done</b>.</li></ol>	
Install the add-on for AWS WAF.	Repeat the previous instructions to install the <b>AWS Web Application Firewall Add-on</b> for Splunk.	Security administrator, Splunk administrator

Task	Description	Skills required
Install and configure the Splunk add-on for Firehose.	<ol style="list-style-type: none"><li data-bbox="592 226 1027 1711">1. Install and configure the Splunk add-on for Firehose. As part of the installation and configuration, if necessary for your Splunk platform, you set up an HTTP Event Collector and prepare the infrastructure to send the log data to your indexers. See the instructions that correspond to your Splunk deployment:<ul data-bbox="630 856 1027 1291" style="list-style-type: none"><li data-bbox="630 856 1027 982">• <a href="#">Splunk Cloud deployment</a> (Splunk documentation)</li><li data-bbox="630 1010 1027 1136">• <a href="#">Distributed Splunk Enterprise deployment</a> (Splunk documentation)</li><li data-bbox="630 1163 1027 1291">• <a href="#">Single-instance Splunk Enterprise deployment</a> (Splunk documentation)</li></ul><p data-bbox="630 1339 1027 1711"><b>Important:</b> Stop this procedure after you have installed and configured the Splunk add-on. Do not proceed with the instructions for configuring Firehose to send data to the Splunk platform.</p></li><li data-bbox="592 1732 1027 1858">2. Make note of the HTTP event collector token and the HTTP endpoint. You</li></ol>	Security administrator, Splunk administrator



Task	Description	Skills required
	need this value later, when you configure the delivery stream.	

## Create the Firehose delivery stream

Task	Description	Skills required
Grant Firehose access to a Splunk destination.	Configure the access policy that permits Firehose to access a Splunk destination and back up the log data to an S3 bucket. For more information, see <a href="#">Grant Firehose access to a Splunk destination</a> .	Security administrator
Create a Firehose delivery stream.	In the same account where you manage the web ACLs for AWS WAF, create a delivery stream in Firehose. You are required to have an IAM role when creating a delivery stream. Firehose assumes that IAM role and gains access to the specified S3 bucket. For instructions, see <a href="#">Creating a delivery stream</a> . Note the following: <ul style="list-style-type: none"> <li>The delivery stream name must start with <code>aws-waf-logs-</code>.</li> <li>For the source, choose <b>Direct PUT</b>.</li> </ul>	Security administrator

Task	Description	Skills required
	<ul style="list-style-type: none"> <li>For <b>S3 backup mode</b>, choose <b>Backup all events</b>, and then choose an existing bucket or create a new one.</li> <li>For the destination, follow the instructions in <a href="#">Choose Splunk for your destination</a> in the Firehose documentation. For information about the values for Splunk endpoints and endpoint types, see <a href="#">Configure Amazon Data Firehose</a> in the Splunk documentation.</li> </ul> <p>Repeat this process for each token that you configured in the HTTP event collector.</p>	
Test the delivery stream.	Test the delivery stream to validate that it is properly configured. For instructions, see <a href="#">Test using Splunk as the destination</a> in the Firehose documentation.	Security administrator

### Configure Firewall Manager to log data

Task	Description	Skills required
Configure the Firewall Manager policies.	The Firewall Manager policies must be configured to enable logging and to forward logs to the correct Firehose	Security administrator

Task	Description	Skills required
	delivery stream. For more information and instructions, see <a href="#">Configuring logging for an AWS WAF policy</a> .	

## Related resources

### AWS resources

- [Logging web ACL traffic](#) (AWS WAF documentation)
- [Configuring logging for an AWS WAF policy](#) (AWS WAF documentation)
- [Tutorial: Sending VPC Flow Logs to Splunk Using Amazon Data Firehose](#) (Firehose documentation)
- [How do I push VPC flow logs to Splunk using Amazon Data Firehose?](#) (AWS Knowledge Center)
- [Power data ingestion into Splunk using Amazon Data Firehose](#) (AWS blog post)

### Splunk documentation

- [Splunk Add-on for Amazon Data Firehose](#)

# Serve static content in an Amazon S3 bucket through a VPC by using Amazon CloudFront

Created by Angel Emmanuel Hernandez Cebrian

**Environment:** PoC or pilot

**Technologies:** Content delivery; Networking; Security, identity, compliance; Serverless; Web & mobile apps

**AWS services:** Amazon CloudFront; Elastic Load Balancing (ELB); AWS Lambda

## Summary

When you serve static content that is hosted on Amazon Web Services (AWS), the recommended approach is to use an Amazon Simple Storage Service (S3) bucket as the origin and use Amazon CloudFront to distribute the content. This solution has two primary benefits: the convenience of caching static content at edge locations, and the ability to define [web access control lists](#) (web ACLs) for the CloudFront distribution, which helps you secure requests to the content with minimal configuration and administrative overhead.

However, there is a common architectural limitation to the standard, recommended approach. In some environments, you want virtual firewall appliances deployed in a virtual private cloud (VPC) to inspect all content, including static content. The standard approach doesn't route traffic through the VPC for inspection. This pattern provides an alternative architectural solution. You still use a CloudFront distribution to serve static content in an S3 bucket, but the traffic is routed through the VPC by using an Application Load Balancer. An AWS Lambda function then retrieves and returns the content from the S3 bucket.

## Prerequisites and limitations

### Prerequisites

- An active AWS account.
- Static website content hosted in an S3 bucket.

### Limitations

- The resources in this pattern must be in a single AWS Region, but they can be provisioned in different AWS accounts.
- Limits apply to the maximum request and response size that the Lambda function can receive and send, respectively. For more information, see *Limits* in [Lambda functions as targets](#) (Elastic Load Balancing documentation).
- It's important to find a good balance between performance, scalability, security, and cost-effectiveness when using this approach. Despite the high scalability of Lambda, if the number of concurrent Lambda invocations exceeds the maximum quota, some requests are throttled. For more information, see Lambda quotas (Lambda documentation). You also need to consider pricing when using Lambda. To minimize Lambda invocations, make sure that you properly define the cache for the CloudFront distribution. For more information, see [Optimizing caching and availability](#) (CloudFront documentation).

## Architecture

### Target technology stack

- CloudFront
- Amazon Virtual Private Cloud (Amazon VPC)
- Application Load Balancer
- Lambda
- Amazon S3

### Target architecture

The following image shows the suggested architecture when you need to use CloudFront to serve static content from an S3 bucket through a VPC.

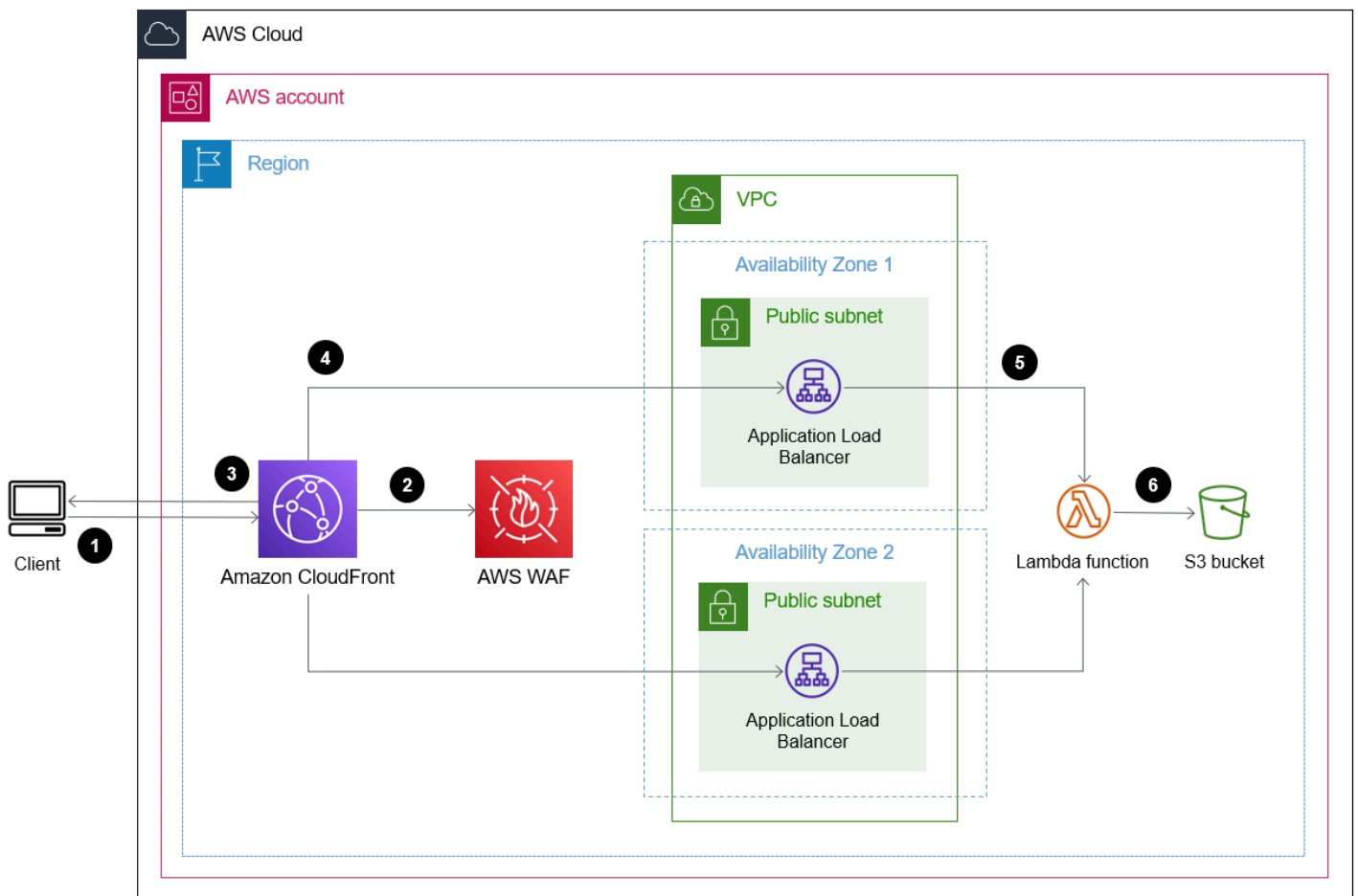

1. The client requests the URL of CloudFront distribution to get a particular website file in the S3 bucket.
2. CloudFront sends the request to AWS WAF. AWS WAF filters the request by using the web ACLs applied to the CloudFront distribution. If the request is determined to be valid, the flow continues. If the request is determined to be invalid, the client receives a 403 error.
3. CloudFront checks its internal cache. If there is a valid key matching the incoming request, the associated value is sent back to the client as a response. If not, the flow continues.
4. CloudFront forwards the request to the URL of the specified Application Load Balancer.
5. The Application Load Balancer has a listener associated with a target group based on a Lambda function. The Application Load Balancer invokes the Lambda function.
6. The Lambda function connects to the S3 bucket, perform a GetObject operation on it, and returns the content as a response.

## Automation and scale

To automate the deployment of static content using this approach, create CI/CD pipelines to update the Amazon S3 buckets that host websites.

The Lambda function scales automatically to handle the concurrent requests, within the quotas and limitations of the service. For more information, see [Lambda function scaling](#) and [Lambda quotas](#) (Lambda documentation). For the other AWS services and features, such as CloudFront and the Application Load Balancer, AWS scales these automatically.

## Tools

- [Amazon CloudFront](#) speeds up distribution of your web content by delivering it through a worldwide network of data centers, which lowers latency and improves performance.
- [Elastic Load Balancing \(ELB\)](#) distributes incoming application or network traffic across multiple targets. In this pattern, you use an [Application Load Balancer](#) provisioned through Elastic Load Balancing to direct traffic to the Lambda function.
- [AWS Lambda](#) is a compute service that helps you run code without needing to provision or manage servers. It runs your code only when needed and scales automatically, so you pay only for the compute time that you use.
- [Amazon Simple Storage Service \(Amazon S3\)](#) is a cloud-based object storage service that helps you store, protect, and retrieve any amount of data.
- [Amazon Virtual Private Cloud \(Amazon VPC\)](#) helps you launch AWS resources into a virtual network that you've defined. This virtual network resembles a traditional network that you'd operate in your own data center, with the benefits of using the scalable infrastructure of AWS.

## Epics

### Use CloudFront to serve static content from Amazon S3 through a VPC

Task	Description	Skills required
Create a VPC.	Create a VPC for hosting the resources deployed in this pattern, such as the Application Load Balancer and the Lambda function. For instructions, see <a href="#">Create a</a>	Cloud architect

Task	Description	Skills required
	<a href="#">VPC</a> (Amazon VPC documentation).	
Create an AWS WAF web ACL.	Create an AWS WAF web ACL. Later in this pattern, you apply this web ACL to the CloudFront distribution. For instructions, see <a href="#">Creating a web ACL</a> (AWS WAF documentation).	Cloud architect
Create the Lambda function.	Create the Lambda function that serves the static content hosted in the S3 bucket as a website. Use the code provided in the <a href="#">Additional information</a> section of this pattern. Customize the code to identify your target S3 bucket.	General AWS
Upload the Lambda function.	Enter the following command to upload the Lambda function code to a .zip file archive in Lambda. <pre>aws lambda update-function-code \ --function-name \ --zip-file fileb://lambda-alb-s3-website.zip</pre>	General AWS



Task	Description	Skills required
Create an Application Load Balancer.	Create an internet-facing Application Load Balancer that points to the Lambda function. For instructions, see <a href="#">Create a target group for the Lambda function</a> (Elastic Load Balancing documentation). For a high-availability configuration, create the Application Load Balancer and attach it to private subnets in different Availability Zones.	Cloud architect

Task	Description	Skills required
Create a CloudFront distribution.	<p>Create a CloudFront distribution that points to the Application Load Balancer you created.</p> <ol style="list-style-type: none"><li>1. Sign in to the AWS Management Console and open the CloudFront console at <a href="https://console.aws.amazon.com/cloudfront/v3/home">https://console.aws.amazon.com/cloudfront/v3/home</a>.</li><li>2. Choose <b>Create Distribution</b>.</li><li>3. On the first page of the <b>Create Distribution Wizard</b>, in the <b>Web</b> section, choose <b>Get Started</b>.</li><li>4. Specify settings for your distribution. For more information, see <a href="#">Values that you specify when you create or update a distribution</a>. Note the following:<ol style="list-style-type: none"><li>a. Set the Application Load Balancer as the origin.</li><li>b. In <b>Distribution settings</b>, choose existing web ACLs that you want to apply through AWS WAF. For more information, see <a href="#">AWS WAF web ACL</a>.</li></ol></li><li>5. Save your changes.</li></ol>	Cloud architect

Task	Description	Skills required
	6. After CloudFront creates your distribution, the value of the <b>Status</b> column for your distribution changes from <b>InProgress</b> to <b>Deployed</b> . If you chose to enable the distribution, it will be ready to process requests after the status switches to <b>Deployed</b> .	

## Related resources

### AWS documentation

- [Optimizing caching and availability](#) (CloudFront documentation)
- [Lambda functions as targets](#) (Elastic Load Balancing documentation)
- [Lambda quotas](#) (Lambda documentation)

### AWS service websites

- [Application Load Balancer](#)
- [Lambda](#)
- [CloudFront](#)
- [Amazon S3](#)
- [AWS WAF](#)
- [Amazon VPC](#)

## Additional information

### Code

The following example Lambda function is written in Node.js. This Lambda function acts as a web server that performs a `GetObject` operation to an S3 bucket that contains the website resources.

```
/**
 * This is an AWS Lambda function created for demonstration purposes.
 *
 * It retrieves static assets from a defined Amazon S3 bucket.
 *
 * To make the content available through a URL, use an Application Load Balancer with a
 * Lambda integration.
 *
 * Set the S3_BUCKET environment variable in the Lambda function definition.
 */

var AWS = require('aws-sdk');

exports.handler = function(event, context, callback) {

    var bucket = process.env.S3_BUCKET;
    var key = event.path.replace('/', '');

    if (key == '') {
        key = 'index.html';
    }

    // Fetch from S3
    var s3 = new AWS.S3();
    return s3.getObject({Bucket: bucket, Key: key},
        function(err, data) {

            if (err) {
                return err;
            }

            var isBase64Encoded = false;
            var encoding = 'utf8';

            if (data.ContentType.indexOf('image/') > -1) {
                isBase64Encoded = true;
                encoding = 'base64'
            }
        })
}
```

```
    var resp = {
      statusCode: 200,
      headers: {
        'Content-Type': data.ContentType,
      },
      body: new Buffer(data.Body).toString(encoding),
      isBase64Encoded: isBase64Encoded
    };

    callback(null, resp);
  }
);
};
```

## More patterns

- [Check an Amazon CloudFront distribution for access logging, HTTPS, and TLS version](#)
- [Deploy a gRPC-based application on an Amazon EKS cluster and access it with an Application Load Balancer](#)
- [Deploy preventative attribute-based access controls for public subnets](#)
- [Deploy resources in an AWS Wavelength Zone by using Terraform](#)
- [Deploy the Security Automations for AWS WAF solution by using Terraform](#)
- [View AWS Network Firewall logs and metrics by using Splunk](#)

# Cost management

## Topics

- [Create detailed cost and usage reports for AWS Glue jobs by using AWS Cost Explorer](#)
- [Create detailed cost and usage reports for Amazon EMR clusters by using AWS Cost Explorer](#)
- [More patterns](#)

# Create detailed cost and usage reports for AWS Glue jobs by using AWS Cost Explorer

Created by Parijat Bhide (AWS) and Aromal Raj Jayarajan (AWS)

**Environment:** Production

**Technologies:** Cost management; Analytics

**AWS services:** AWS Billing and Cost Management; AWS Glue

## Summary

This pattern shows how to track the usage costs of AWS Glue data integration jobs by configuring [user-defined cost allocation tags](#). You can use these tags to create detailed cost and usage reports in AWS Cost Explorer for jobs across multiple dimensions. For example, you can track usage costs at the team, project, or cost center level.

## Prerequisites and limitations

### Prerequisites

- An active AWS account
- One or more [AWS Glue jobs](#) that have user-defined tags activated

## Architecture

### Target technology stack

- AWS Glue
- AWS Cost Explorer

The following diagram shows how you can apply tags to track usage costs for AWS Glue jobs.



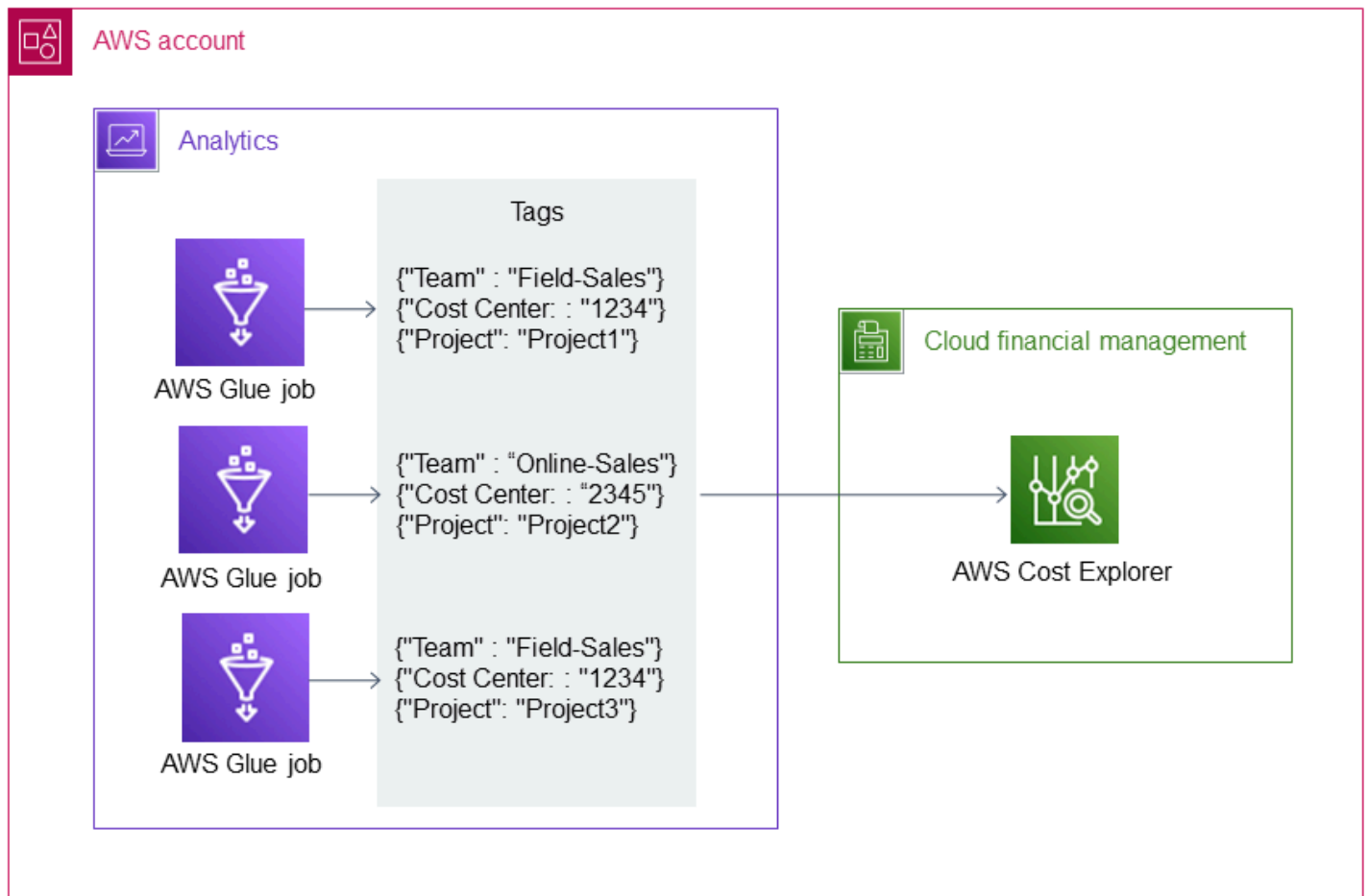

The diagram shows the following workflow:

1. A data engineer or AWS administrator creates user-defined cost allocation tags for the AWS Glue jobs.
2. An AWS administrator activates the tags.
3. The tags report metadata to AWS Cost Explorer.

## Tools

- [AWS Glue](#) is a fully managed extract, transform, and load (ETL) service. It helps you reliably categorize, clean, enrich, and move data between data stores and data streams.
- [AWS Cost Explorer](#) helps you view and analyze your AWS costs and usage.

# Epics

## Create and activate tags for your AWS Glue jobs

Task	Description	Skills required
Create user-defined cost allocation tags for your AWS Glue jobs.	<p><b>To add tags to an existing AWS Glue job</b></p> <ol style="list-style-type: none"><li>1. Sign in to the AWS Management console, and then open the <a href="#">AWS Glue console</a>.</li><li>2. In the left navigation pane, under <b>ETL</b>, choose <b>Jobs</b>.</li><li>3. In the <b>Your jobs</b> section, choose the name of the job that you're tagging.</li><li>4. Choose the <b>Job details</b> tab. Then, expand the <b>Advanced properties</b> section.</li><li>5. For <b>Tags</b>, choose <b>Add new tag</b>.</li><li>6. For <b>Key</b>, enter a name for your tag.</li><li>7. (Optional) For <b>Value</b>, enter a value that you want associated with the key.</li><li>8. (Optional) Repeat steps 5-7 for each tag that you want to create for the job.</li><li>9. Choose <b>Save</b>.</li></ol>	Data engineer

Task	Description	Skills required
	<p><b>To add tags to a new AWS Glue job</b></p> <ol style="list-style-type: none"> <li>1. Create a new AWS Glue job based on your use case requirements. For instructions, see <a href="#">Working with jobs on the AWS Glue Console</a> in the <i>AWS Glue Developer Guide</i>.</li> <li>2. When you configure the <b>Job details</b> settings, follow steps 4-9 of the <b>To add tags to an existing AWS Glue job</b> section of this task.</li> </ol> <p><b>Note:</b> For more information, see <a href="#">AWS tags in AWS Glue</a> in the <i>AWS Glue Developer Guide</i>.</p>	
<p>Activate the user-defined cost allocation tags.</p>	<p>Follow the instructions in <a href="#">Activating user-defined cost allocation tags</a> in the <i>AWS Billing User Guide</i>.</p>	<p>AWS administrator</p>

### Create cost and usage reports for your AWS Glue jobs

Task	Description	Skills required
<p>Create cost and usage reports for your AWS Glue jobs by</p>	<ol style="list-style-type: none"> <li>1. Sign in to the AWS Management Console</li> </ol>	<p>General AWS, AWS administrator</p>

Task	Description	Skills required
using tag filters in AWS Cost Explorer.	<p>and open the <a href="#">AWS Cost Management console</a>.</p> <ol style="list-style-type: none"><li>In the left navigation pane, choose <b>Reports</b>.</li><li>Choose <b>Create new report</b>.</li><li>For <b>Select a report type</b>, choose <b>Cost and usage (recommended)</b>. Then, choose <b>Create Report</b>.</li><li>For <b>Filters</b>, choose <b>Service</b>. The <b>Service</b> dropdown appears.</li><li>Select the check boxes next to <b>Glue</b>. Then, choose <b>Apply filters</b>.</li><li>For <b>Filters</b>, choose <b>Tag</b>. The <b>Tag</b> dropdown appears.</li><li>Choose <b>Team</b>. Then, select the check boxes next to the teams that you've assigned tags to. Exclude any teams that you haven't assigned tags to. Then, choose <b>Apply filters</b>.</li><li>At the top of the chart, choose <b>Tag</b>. Then, choose the tags for the AWS Glue jobs that you want to create a report for.</li><li>At the top of the chart, choose the <b>Last 3 Months</b> dropdown and choose</li></ol>	

Task	Description	Skills required
	<p>the timeframe that you want the report to cover. Then, choose the <b>Monthly</b> dropdown and choose how you want the line items in the report to be aggregated based on timeframe.</p> <p>11 Choose <b>Save as</b>. Then, enter a title for your report.</p> <p>12 Choose <b>Save Report</b>.</p> <p>For more information, see <a href="#">Exploring your data using Cost Explorer</a> in the <i>AWS Cost Management User Guide</i>.</p>	

# Create detailed cost and usage reports for Amazon EMR clusters by using AWS Cost Explorer

Created by Parijat Bhide (AWS) and Aromal Raj Jayarajan (AWS)

**Environment:** Production

**Technologies:** Cost management; Analytics; Big data

**AWS services:** AWS Billing and Cost Management; Amazon EMR

## Summary

This pattern shows how to track the usage costs of Amazon EMR clusters by configuring [user-defined cost allocation tags](#). You can use these tags to create detailed cost and usage reports in AWS Cost Explorer for clusters across multiple dimensions. For example, you can track usage costs at the team, project, or cost center level.

## Prerequisites and limitations

### Prerequisites

- An active AWS account
- One or more [EMR clusters](#) that have user-defined tags activated

## Architecture

### Target technology stack

- Amazon EMR
- AWS Cost Explorer

### Target architecture

The following diagram shows how you can apply tags to track usage costs for specific Amazon EMR clusters.

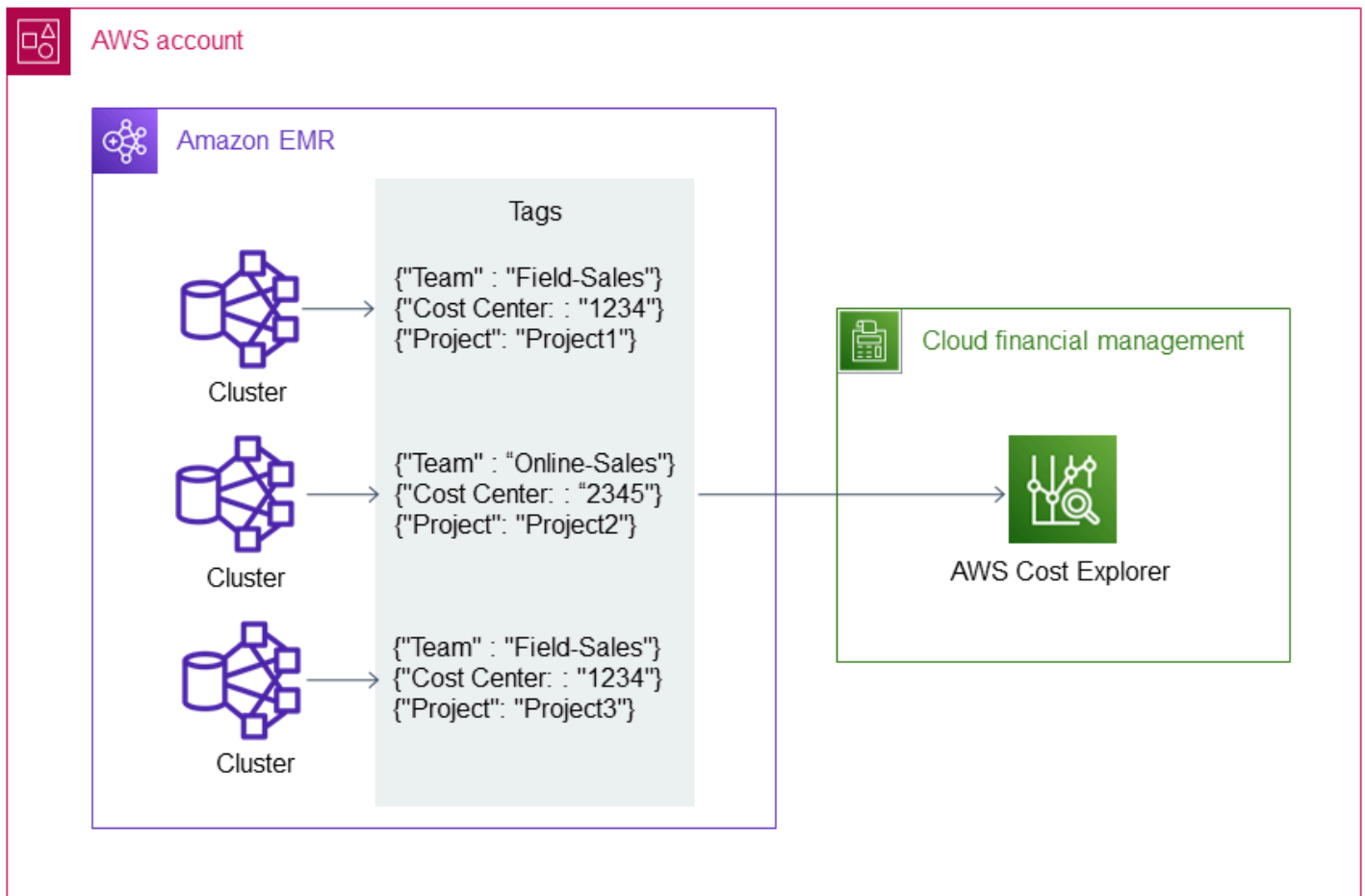

The diagram shows the following workflow:

1. A data engineer or AWS administrator creates user-defined cost allocation tags for the Amazon EMR clusters.
2. An AWS administrator activates the tags.
3. The tags report metadata to AWS Cost Explorer.

## Tools

### Tools

- [Amazon EMR](#) is a managed cluster platform that simplifies running big data frameworks on AWS to process and analyze large amounts of data.
- [AWS Cost Explorer](#) helps you view and analyze your AWS costs and usage.

## Epics

### Create and activate tags for your Amazon EMR clusters

Task	Description	Skills required
Create user-defined cost allocation tags for your Amazon EMR clusters.	<p><b>To add tags to an existing Amazon EMR cluster</b></p> <p>Follow the instructions in <a href="#">Adding tags to an existing cluster</a> in the <i>Amazon EMR Management Guide</i>.</p> <p><b>To add tags to a new Amazon EMR cluster</b></p> <p>Follow the instructions in <a href="#">Add tags to a new cluster</a> in the <i>Amazon EMR Management Guide</i>.</p> <p>For more information about how to set up an Amazon EMR cluster, see <a href="#">Plan and configure clusters</a> in the <i>Amazon EMR Management Guide</i>.</p>	Data engineer
Activate the user-defined cost allocation tags.	Follow the instructions in <a href="#">Activating user-defined cost allocation tags</a> in the <i>AWS Billing User Guide</i> .	AWS administrator



## Create cost and usage reports for your Amazon EMR clusters

Task	Description	Skills required
Create cost and usage reports for your Amazon EMR clusters by using tag filters in AWS Cost Explorer.	<ol style="list-style-type: none"><li>1. Sign in to the AWS Management Console and open the <a href="#">AWS Cost Management console</a>.</li><li>2. In the left navigation pane, choose <b>Reports</b>.</li><li>3. Choose <b>Create new report</b>.</li><li>4. For <b>Select a report type</b>, choose <b>Cost and usage (recommended)</b>. Then, choose <b>Create Report</b>.</li><li>5. For <b>Filters</b>, choose <b>Service</b>. The <b>Service</b> dropdown appears.</li><li>6. Select the check boxes next to <b>EMR (Elastic MapReduce)</b> and <b>EC2-Instances (Elastic Compute Cloud – Compute)</b>. Then, choose <b>Apply filters</b>.</li><li>7. For <b>Filters</b>, choose <b>Tag</b>. The <b>Tag</b> dropdown appears.</li><li>8. Choose <b>Team</b>. Then, select the check boxes next to the teams that you've assigned tags to. Exclude any teams that you haven't assigned tags to. Then, choose <b>Apply filters</b>.</li></ol>	General AWS, AWS administrator

Task	Description	Skills required
	<p>9. At the top of the chart, choose <b>Tag</b>. Then, choose the tags for the Amazon EMR clusters that you want to create a report for.</p> <p>10 At the top of the chart, choose the <b>Last 3 Months</b> dropdown and choose the timeframe that you want the report to cover. Then, choose the <b>Monthly</b> dropdown and choose how you want the line items in the report to be aggregated based on timeframe.</p> <p>11 Choose <b>Save as</b>. Then, enter a title for your report.</p> <p>12 Choose <b>Save Report</b>.</p> <p>For more information, see <a href="#">Exploring your data using Cost Explorer</a> in the <i>AWS Cost Management User Guide</i>.</p>	

## More patterns

- [Automate the creation of AppStream 2.0 resources using AWS CloudFormation](#)
- [Automatically archive items to Amazon S3 using DynamoDB TTL](#)
- [Automatically stop and start an Amazon RDS DB instance using AWS Systems Manager Maintenance Windows](#)
- [Create detailed cost and usage reports for Amazon RDS and Amazon Aurora](#)
- [Delete unused Amazon Elastic Block Store \(Amazon EBS\) volumes by using AWS Config and AWS Systems Manager](#)
- [Estimate storage costs for an Amazon DynamoDB table](#)
- [Estimate the cost of a DynamoDB table for on-demand capacity](#)

# Data lakes

## Topics

- [Automate data ingestion from AWS Data Exchange into Amazon S3](#)
- [Build a data pipeline to ingest, transform, and analyze Google Analytics data using the AWS DataOps Development Kit](#)
- [Configure cross-account access to a shared AWS Glue Data Catalog using Amazon Athena](#)
- [Deploy and manage a serverless data lake on the AWS Cloud by using infrastructure as code](#)
- [Migrate Hadoop data to Amazon S3 by using WANdisco LiveData Migrator](#)
- [More patterns](#)

# Automate data ingestion from AWS Data Exchange into Amazon S3

*Created by Adnan Alvee (AWS) and Manikanta Gona (AWS)*

**Technologies:** Analytics;  
DataLakes

**Environment:** Production

**AWS services:** Amazon S3;  
Amazon CloudWatch; AWS  
Lambda; Amazon SNS

## Summary

This pattern provides an AWS CloudFormation template that enables you to automatically ingest data from AWS Data Exchange into your data lake in Amazon Simple Storage Service (Amazon S3).

AWS Data Exchange is a service that makes it easy to securely exchange file-based data sets in the AWS Cloud. AWS Data Exchange data sets are subscription-based. As a subscriber, you can also access data set revisions as providers publish new data.

The AWS CloudFormation template creates an Amazon CloudWatch Events event and an AWS Lambda function. The event watches for any updates to the data set you have subscribed to. If there is an update, CloudWatch initiates a Lambda function, which copies the data over to the S3 bucket you specify. When the data has been copied successfully, Lambda sends you an Amazon Simple Notification Service (Amazon SNS) notification.

## Prerequisites and limitations

### Prerequisites

- An active AWS account
- Subscription to a data set in AWS Data Exchange

### Limitations

- The AWS CloudFormation template must be deployed separately for each subscribed data set in AWS Data Exchange.

# Architecture

## Target technology stack

- AWS Lambda
- Amazon S3
- AWS Data Exchange
- Amazon CloudWatch
- Amazon SNS

## Target architecture

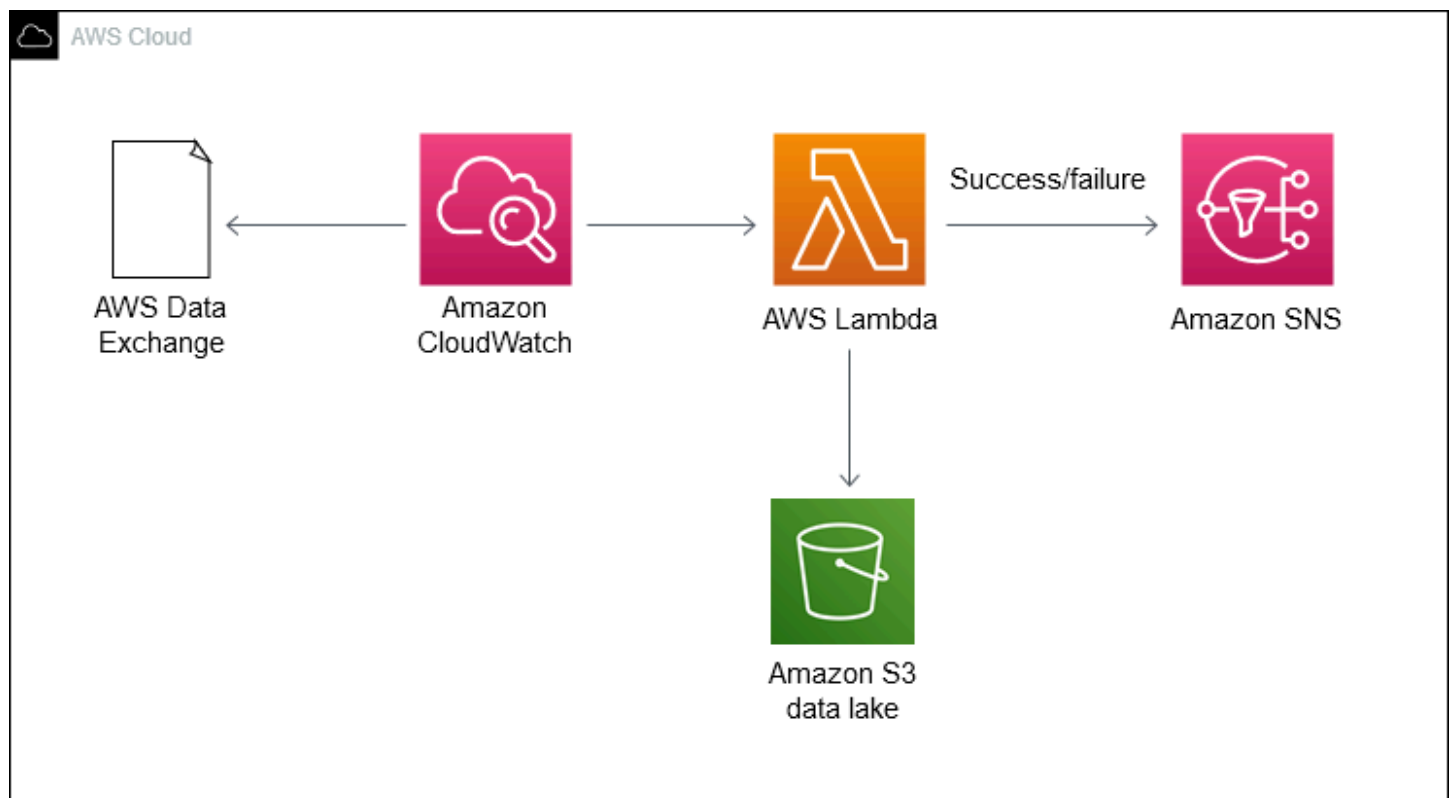

## Automation and scale

You can use the AWS CloudFormation template multiple times for the data sets you want to ingest into the data lake.

## Tools

- [AWS Data Exchange](#) – A service that makes it easy for AWS customers to securely exchange file-based data sets in the AWS Cloud. As a subscriber, you can find and subscribe to hundreds of products from qualified data providers. Then, you can quickly download the data set or copy it to Amazon S3 for use across a variety of AWS analytics and machine learning services. Anyone with an AWS account can be an AWS Data Exchange subscriber.
- [AWS Lambda](#) – A compute service that lets you run code without provisioning or managing servers. AWS Lambda runs your code only when needed and scales automatically, from a few requests per day to thousands per second. You pay only for the compute time you consume; there is no charge when your code isn't running. With AWS Lambda, you can run code for virtually any type of application or backend service with zero administration. AWS Lambda runs your code on a high-availability compute infrastructure and manages all the compute resources, including server and operating system maintenance, capacity provisioning and automatic scaling, code monitoring, and logging.
- [Amazon S3](#) – Storage for the internet. You can use Amazon S3 to store and retrieve any amount of data at any time, from anywhere on the web.
- [Amazon CloudWatch Events](#) – Delivers a near real-time stream of system events that describe changes in AWS resources. Using simple rules that you can quickly set up, you can match events and route them to one or more target functions or streams. CloudWatch Events becomes aware of operational changes as they occur. It responds to these operational changes and takes corrective action as necessary, by sending messages to respond to the environment, activating functions, making changes, and capturing state information. You can also use CloudWatch Events to schedule automated actions that self-initiate at certain times using **cron** or **rate** expressions.
- [Amazon SNS](#) – A web service that enables applications, end-users, and devices to instantly send and receive notifications from the cloud. Amazon SNS provides topics (communication channels) for high-throughput, push-based, many-to-many messaging. Using Amazon SNS topics, publishers can distribute messages to a large number of subscribers for parallel processing, including Amazon Simple Queue Service (Amazon SQS) queues, AWS Lambda functions, and HTTP/S webhooks. You can also use Amazon SNS to send notifications to end users using mobile push, SMS, and email.

## Epics

### Subscribe to a data set

Task	Description	Skills required
Subscribe to a data set.	In the AWS Data Exchange console, subscribe to a dataset. For instructions, see the link in the "Related resources" section.	General AWS
Note the data set attributes.	Note the AWS Region, ID, and revision ID for the data set. You will need this for the AWS CloudFormation template in the next step.	General AWS

### Deploy the AWS CloudFormation template

Task	Description	Skills required
Create an S3 bucket and folder.	If you already have a data lake in Amazon S3, create a folder to store the data to ingest from AWS Data Exchange. If you are deploying the template for testing purposes, create a new S3 bucket, and note the bucket name and folder prefix for the next step.	General AWS
Deploy the AWS CloudFormation template.	Deploy the AWS CloudFormation template that's provided as an attachment to this pattern. Configure	General AWS



Task	Description	Skills required
	<p>the following parameters to correspond to your AWS account, data set, and S3 bucket settings: Dataset AWS Region, Dataset ID, Revision ID, S3 Bucket Name (for example, DOC-EXAMPLE-BUCKET), Folder Prefix (for example, myfolder/), and Email for SNS Notification. You can set the Dataset Name parameter to any name. When you deploy the template, it runs a Lambda function to automatically ingest the first set of data available in the data set. Subsequent ingestion then takes place automatically, as new data arrives in the data set.</p>	

## Related resources

- [Subscribing to data products on AWS Data Exchange](#) (AWS Data Exchange documentation)

## Attachments

To access additional content that is associated with this document, unzip the following file: [attachment.zip](#)

# Build a data pipeline to ingest, transform, and analyze Google Analytics data using the AWS DataOps Development Kit

Created by Anton Kukushkin (AWS) and Rudy Puig (AWS)

<b>Code repository:</b> <a href="#">AWS DDK Examples - Analyzing Google Analytics data with Amazon AppFlow, Amazon Athena, and AWS DataOps Development Kit</a>	<b>Environment:</b> PoC or pilot	<b>Technologies:</b> DataLakes; Analytics; DevOps; Infrastructure
<b>Workload:</b> Open-source	<b>AWS services:</b> Amazon AppFlow; Amazon Athena; AWS CDK; AWS Lambda; Amazon S3	

## Summary

This pattern describes how to build a data pipeline to ingest, transform, and analyze Google Analytics data by using the AWS DataOps Development Kit (DDK) and other AWS services. The AWS DDK is an open-source development framework that helps you build data workflows and modern data architecture on AWS. One of the main objectives of the AWS DDK is to save you the time and effort that's typically devoted to labor-intensive data pipeline tasks, such as orchestrating pipelines, building infrastructure, and creating the DevOps behind that infrastructure. You can offload these labor-intensive tasks to AWS DDK so that you can focus on writing code and other high-value activities.

## Prerequisites and limitations

### Prerequisites

- An active AWS account
- An Amazon AppFlow connector for Google Analytics, [configured](#)
- [Python](#) and [pip](#) (Python's package manager)

- Git, installed and [configured](#)
- AWS Command Line Interface (AWS CLI), [installed](#) and [configured](#)
- AWS Cloud Development Kit (AWS CDK), [installed](#)

### Product versions

- Python 3.7 or later
- pip 9.0.3 or later

## Architecture

### Technology stack

- Amazon AppFlow
- Amazon Athena
- Amazon CloudWatch
- Amazon EventBridge
- Amazon Simple Storage Service (Amazon S3)
- Amazon Simple Queue Service (Amazon SQS)
- AWS DataOps Development Kit (DDK)
- AWS Lambda

### Target architecture

The following diagram shows the event-driven process that ingests, transforms, and analyzes Google Analytics data.

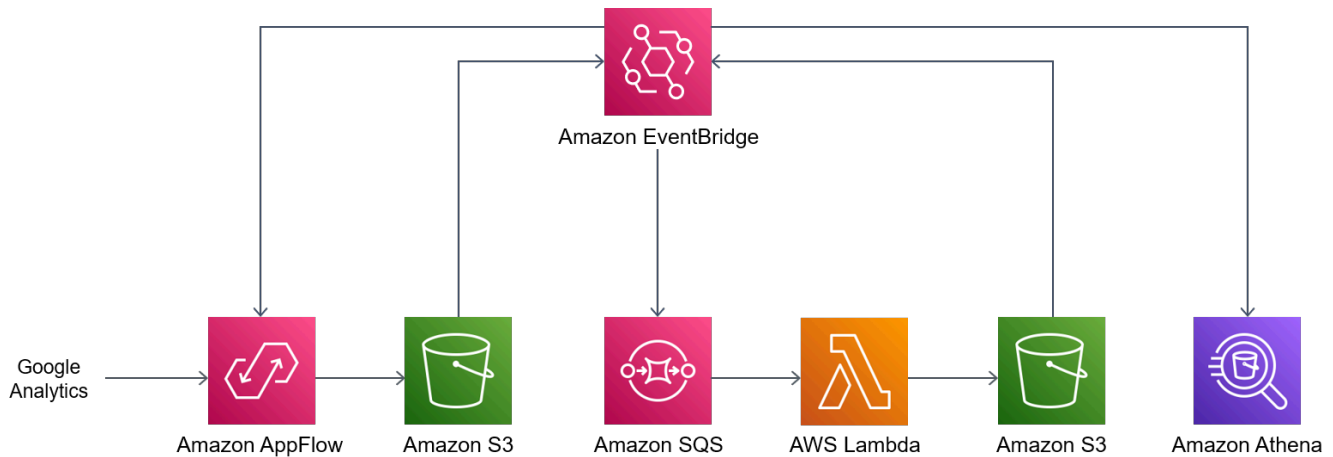

The diagram shows the following workflow:

1. An Amazon CloudWatch scheduled event rule invokes Amazon AppFlow.
2. Amazon AppFlow ingests Google Analytics data into an S3 bucket.
3. After the data is ingested by the S3 bucket, event notifications in EventBridge are generated, captured by a CloudWatch Events rule, and then put into an Amazon SQS queue.
4. A Lambda function consumes events from the Amazon SQS queue, reads the respective S3 objects, transforms the objects to Apache Parquet format, writes the transformed objects to the S3 bucket, and then creates or updates the AWS Glue Data Catalog table definition.
5. An Athena query runs against the table.

## Tools

### AWS tools

- [Amazon AppFlow](#) is a fully-managed integration service that enables you to securely exchange data between software as a service (SaaS) applications.
- [Amazon Athena](#) is an interactive query service that helps you analyze data directly in Amazon S3 by using standard SQL.
- [Amazon CloudWatch](#) helps you monitor the metrics of your AWS resources and the applications you run on AWS in real time.
- [Amazon EventBridge](#) is a serverless event bus service that helps you connect your applications with real-time data from a variety of sources. For example, AWS Lambda functions, HTTP invocation endpoints using API destinations, or event buses in other AWS accounts.

- [Amazon Simple Storage Service \(Amazon S3\)](#) is a cloud-based object storage service that helps you store, protect, and retrieve any amount of data.
- [Amazon Simple Queue Service \(Amazon SQS\)](#) provides a secure, durable, and available hosted queue that helps you integrate and decouple distributed software systems and components.
- [AWS Lambda](#) is a compute service that helps you run code without needing to provision or manage servers. It runs your code only when needed and scales automatically, so you pay only for the compute time that you use.
- [AWS Cloud Development Kit \(CDK\)](#) is a framework for defining cloud infrastructure in code and provisioning it through AWS CloudFormation.
- [AWS DataOps Development Kit \(DDK\)](#) is an open-source development framework to help you build data workflows and modern data architecture on AWS.

## Code

The code for this pattern is available in the GitHub [AWS DataOps Development Kit \(DDK\)](#) and [Analyzing Google Analytics data with Amazon AppFlow, Amazon Athena, and AWS DataOps Development Kit](#) repositories.

## Epics

### Prepare the environment

Task	Description	Skills required
Clone the source code.	To clone the source code, run the following command:  <pre>git clone https://github.com/aws-samples/aws-ddk-examples.git</pre>	DevOps engineer
Create a virtual environment.	Navigate to the source code directory, and then run the following command to create a virtual environment:	DevOps engineer

Task	Description	Skills required
	<pre>cd google-analytics- data-using-appflow/ python &amp;&amp; python3 -m venv .venv</pre>	
Install the dependencies.	<p>To activate the virtual environment and install the dependencies, run the following command:</p> <pre>source .venv/bin/ activate &amp;&amp; pip install -r requirements.txt</pre>	DevOps engineer

## Deploy the application that uses your data pipeline

Task	Description	Skills required
Bootstrap the environment.	<ol style="list-style-type: none"> <li>1. Confirm that the AWS CLI is set up with valid credentials for your AWS account. For more information, see <a href="#">Using named profiles</a> in the AWS CLI documentation.</li> <li>2. Run the <code>cdk bootstrap --profile [AWS_PROFILE]</code> command.</li> </ol>	DevOps engineer
Deploy the data.	To deploy the data pipeline, run the <code>cdk deploy --profile [AWS_PROFILE]</code> command.	DevOps engineer

## Test the deployment

Task	Description	Skills required
Validate stack status.	<ol style="list-style-type: none"><li>1. Open the <a href="#">AWS CloudFormation console</a>.</li><li>2. On the <b>Stacks</b> page, confirm that the status of the stack <code>DdkAppflowAthenaStack</code> is <code>CREATE_COMPLETE</code>.</li></ol>	DevOps engineer

## Troubleshooting

Issue	Solution
Deployment fails during the creation of an <code>AWS::AppFlow::Flow</code> resource and you receive the following error: <code>Connector Profile with name ga-connection does not exist</code>	<p>Confirm that you created an Amazon AppFlow connector for Google Analytics and named it <code>ga-connection</code>.</p> <p>For instructions, see <a href="#">Google Analytics</a> in the Amazon AppFlow documentation.</p>

## Related resources

- [AWS DataOps Development Kit \(DDK\)](#) (GitHub)
- [AWS DDK Examples](#) (GitHub)

## Additional information

AWS DDK data pipelines are composed of one or many stages. In the following code examples, you use `AppFlowIngestionStage` to ingest data from Google Analytics, `SqsToLambdaStage` to handle data transformation, and `AthenaSQLStage` to run the Athena query.

First, the data transformation and ingestion stages are created, as the following code example shows:

```
appflow_stage = AppFlowIngestionStage(
    self,
    id="appflow-stage",
    flow_name=flow.flow_name,
)
sqs_lambda_stage = SqsToLambdaStage(
    self,
    id="lambda-stage",
    lambda_function_props={
        "code": Code.from_asset("./ddk_app/lambda_handlers"),
        "handler": "handler.lambda_handler",
        "layers": [
            LayerVersion.from_layer_version_arn(
                self,
                id="layer",
                layer_version_arn=f"arn:aws:lambda:
{self.region}:336392948345:layer:AWSDataWrangler-Python39:1",
            )
        ],
        "runtime": Runtime.PYTHON_3_9,
    },
)
# Grant lambda function S3 read & write permissions
bucket.grant_read_write(sqs_lambda_stage.function)
# Grant Glue database & table permissions
sqs_lambda_stage.function.add_to_role_policy(
    self._get_glue_db_iam_policy(database_name=database.database_name)
)
athena_stage = AthenaSQLStage(
    self,
    id="athena-sql",
    query_string=[
        (
            "SELECT year, month, day, device, count(user_count) as cnt "
            f"FROM {database.database_name}.ga_sample "
            "GROUP BY year, month, day, device "
            "ORDER BY cnt DESC "
            "LIMIT 10; "
        )
    ],
)
```



```

    output_location=Location(
        bucket_name=bucket.bucket_name, object_key="query-results/"
    ),
    additional_role_policy_statements=[
        self._get_glue_db_iam_policy(database_name=database.database_name)
    ],
)

```

Next, the `DataPipeline` construct is used to "wire" the stages together by using `EventBridge` rules, as the following code example shows:

```

(
    DataPipeline(self, id="ingestion-pipeline")
        .add_stage(
            stage=appflow_stage,
            override_rule=Rule(
                self,
                "schedule-rule",
                schedule=Schedule.rate(Duration.hours(1)),
                targets=appflow_stage.targets,
            ),
        )
        .add_stage(
            stage=sqs_lambda_stage,
            # By default, AppFlowIngestionStage stage emits an event after the flow
run finishes successfully
            # Override rule below changes that behavior to call the the stage when
data lands in the bucket instead
            override_rule=Rule(
                self,
                "s3-object-created-rule",
                event_pattern=EventPattern(
                    source=["aws.s3"],
                    detail={
                        "bucket": {"name": [bucket.bucket_name]},
                        "object": {"key": [{"prefix": "ga-data"}]},
                    },
                    detail_type=["Object Created"],
                ),
                targets=sqs_lambda_stage.targets,
            ),
        )
        .add_stage(stage=athena_stage)
)

```

)

For more code examples, see the GitHub [Analyzing Google Analytics data with Amazon AppFlow, Amazon Athena, and AWS DataOps Development Kit](#) repository.

# Configure cross-account access to a shared AWS Glue Data Catalog using Amazon Athena

Created by Denis Avdonin (AWS)

**Environment:** Production

**Technologies:** DataLakes;  
Analytics; Big data

**Workload:** All other  
workloads

**AWS services:** Amazon  
Athena; AWS Glue

## Summary

This pattern provides step-by-step instructions, including AWS Identity and Access Management (IAM) policy samples, to configure cross-account sharing of a dataset stored in an Amazon Simple Storage Service (Amazon S3) bucket by using the AWS Glue Data Catalog. You can store the dataset in an S3 bucket. The metadata is collected by an AWS Glue crawler and put into the AWS Glue Data Catalog. The S3 bucket and the AWS Glue Data Catalog reside in an AWS account referred to as the *data account*. You can provide access to IAM principals in another AWS account referred to as the *consumer account*. Users can query the data in the consumer account by using the Amazon Athena serverless query engine.

## Prerequisites and limitations

### Prerequisites

- Two active [AWS accounts](#)
- An [S3 bucket](#) in one of the AWS accounts
- [Athena engine version 2](#)
- AWS Command Line Interface (AWS CLI), [installed](#) and [configured](#) (or [AWS CloudShell](#) for running AWS CLI commands)

### Product versions

This pattern works with [Athena engine version 2](#) and [Athena engine version 3](#) only. We recommend that you upgrade to Athena engine version 3. If you can't upgrade from Athena engine version 1 to Athena engine version 3, then follow the approach from [Cross-account AWS Glue Data Catalog access with Amazon Athena](#) in the AWS Big Data Blog.

## Architecture

### Target technology stack

- Amazon Athena
- Amazon Simple Storage Service (Amazon S3)
- AWS Glue
- AWS Identity and Access Management (IAM)
- AWS Key Management Service (AWS KMS)

The following diagram shows an architecture that uses IAM permissions to share data in an S3 bucket in one AWS account (data account) with another AWS account (consumer account) through the AWS Glue Data Catalog.

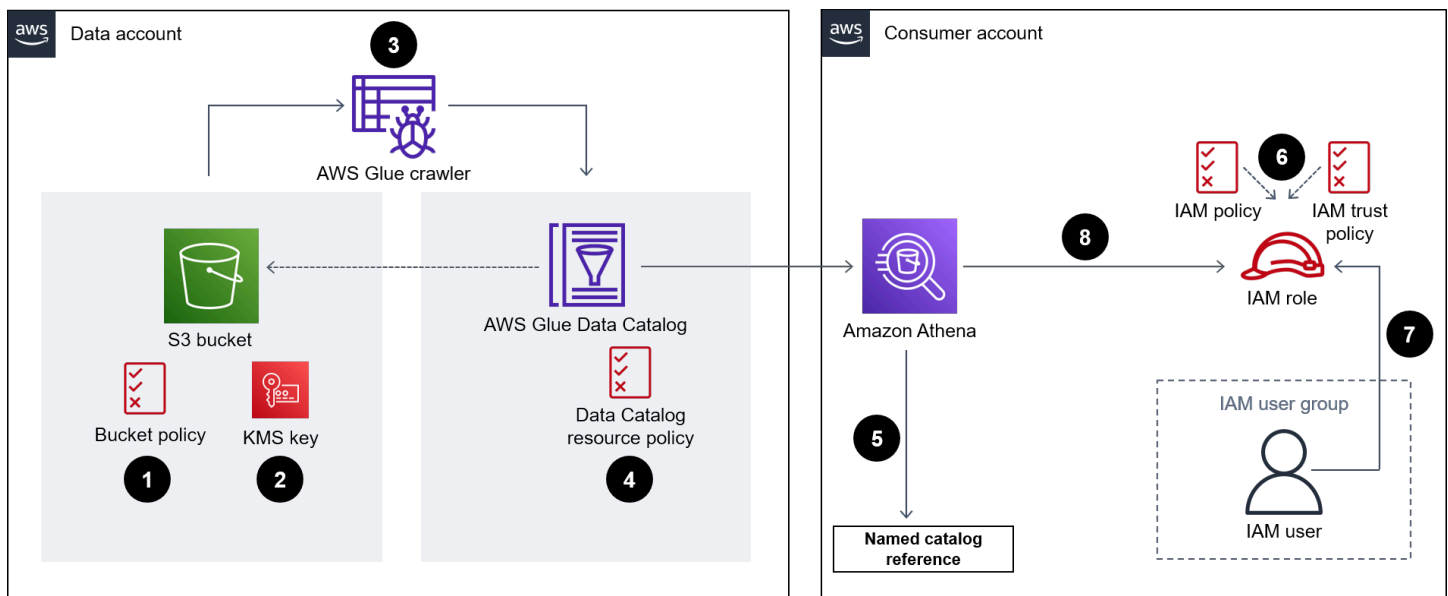

The diagram shows the following workflow:

1. The S3 bucket policy in the data account grants permissions to an IAM role in the consumer account and to the AWS Glue crawler service role in the data account.

2. The AWS KMS key policy in the data account grants permissions to the IAM role in the consumer account and to the AWS Glue crawler service role in the data account.
3. The AWS Glue crawler in the data account discovers the schema of the data that's stored in the S3 bucket.
4. The resource policy of the AWS Glue Data Catalog in the data account grants access to the IAM role in the consumer account.
5. A user creates a named catalog reference in the consumer account by using an AWS CLI command.
6. An IAM policy grants an IAM role in the consumer account access to resources in the data account. The IAM role's trust policy allows users in the consumer account to assume the IAM role.
7. A user in the consumer account assumes the IAM role and accesses objects in the data catalog by using SQL queries.
8. The Athena serverless engine runs the SQL queries.

**Note:** [IAM best practices](#) recommend that you grant permissions to an IAM role and use [identity federation](#).

## Tools

- [Amazon Athena](#) is an interactive query service that helps you analyze data directly in Amazon S3 by using standard SQL.
- [Amazon Simple Storage Service \(Amazon S3\)](#) is a cloud-based object storage service that helps you store, protect, and retrieve any amount of data.
- [AWS Glue](#) is a fully managed extract, transform, and load (ETL) service. It helps you reliably categorize, clean, enrich, and move data between data stores and data streams.
- [AWS Identity and Access Management \(IAM\)](#) helps you securely manage access to your AWS resources by controlling who is authenticated and authorized to use them.
- [AWS Key Management Service \(AWS KMS\)](#) helps you create and control cryptographic keys to protect your data.

# Epics

## Set up permissions in the data account

Task	Description	Skills required
Grant access to data in the S3 bucket.	<p><a href="#">Create an S3 bucket policy</a> based on the following template and assign the policy to the bucket where the data is stored.</p> <pre data-bbox="591 695 1029 1854">{   "Version":   "2012-10-17",   "Statement": [     {       "Effect":       "Allow",       "Principal": {         "AWS": [           "arn:aws:iam::&lt;consumer account id&gt;:role/           &lt;role name&gt;",           "arn:aws:iam::&lt;data account id&gt;:role/           service-role/AWSGlueServiceRole-data-           bucket-crawler"         ]       },       "Action":       "s3:GetObject",       "Resource":       "arn:aws:s3:::data-       bucket/*"     }   ] }</pre>	Cloud administrator

Task	Description	Skills required
	<pre>       "Effect":         "Allow",       "Principal": {         "AWS": [           "arn:aws:iam::&lt;consumer account id&gt;:role/             &lt;role name&gt;",           "arn:aws:iam::&lt;data account id&gt;:role/             service-role/AWSGlueServiceRole-data-             bucket-crawler"         ]       },       "Action":         "s3:ListBucket",       "Resource":         "arn:aws:s3:::data-         bucket"     ]   } </pre> <p>The bucket policy grants permissions to the IAM role in the consumer account and to the AWS Glue crawler service role in the data account.</p>	

Task	Description	Skills required
<p>(If required) Grant access to the data encryption key.</p>	<p>If the S3 bucket is encrypted by an AWS KMS key, grant <code>kms:Decrypt</code> permission on the key to the IAM role in the consumer account and to the AWS Glue crawler service role in the data account.</p> <p>Update the <a href="#">key policy</a> with the following statement:</p> <pre data-bbox="597 716 1026 1625">{   "Effect": "Allow",   "Principal": {     "AWS": [       "arn:aws:iam::&lt;consumer account id&gt;:role/&lt;role name&gt;",       "arn:aws:iam::&lt;data account id&gt;:role/service-role/AWSGlueServiceRole-data-bucket-crawler"     ]   },   "Action": "kms:Decrypt",   "Resource":     "arn:aws:kms:&lt;region&gt;:&lt;data account id&gt;:key/&lt;key id&gt;" }</pre>	<p>Cloud administrator</p>



Task	Description	Skills required
Grant the crawler access to the data.	<p>Attach the following IAM policy to the crawler's service role:</p> <pre data-bbox="594 394 1026 1390">{   "Version":   "2012-10-17",   "Statement": [     {       "Effect":       "Allow",       "Action":       "s3:GetObject",       "Resource":       "arn:aws:s3:::data-       bucket/*"     },     {       "Effect":       "Allow",       "Action":       "s3:ListBucket",       "Resource":       "arn:aws:s3:::data-       bucket"     }   ] }</pre>	Cloud administrator

Task	Description	Skills required
<p>(If required) Grant the crawler access to the data encryption key.</p>	<p>If the S3 bucket is encrypted by an AWS KMS key, grant <code>kms:Decrypt</code> permission on the key to the crawler's service role by attaching the following policy to it:</p> <pre data-bbox="597 537 1026 936">{   "Effect": "Allow",   "Action": "kms:Decrypt",   "Resource":     "arn:aws:kms:&lt;region&gt;:&lt;data account id&gt;:key/&lt;key id&gt;" }</pre>	<p>Cloud administrator</p>

Task	Description	Skills required
<p>Grant the IAM role in the consumer account and the crawler access to the data catalog.</p>	<ol style="list-style-type: none"><li>1. Sign in to the AWS Management Console and open the <a href="#">AWS Glue console</a>.</li><li>2. In the navigation pane, under <b>Data Catalog</b>, choose <b>Settings</b>.</li><li>3. In the <b>Permissions</b> section, add the following statement, and then choose <b>Save</b>.</li></ol> <pre data-bbox="592 835 1027 1833">{   "Version" :   "2012-10-17",   "Statement" : [     {       "Effect" :       "Allow",       "Principal" : {         "AWS" :         [           "arn:aws:iam::&lt;consumer account id&gt;:role/           &lt;role name&gt;",           "arn:aws:iam::&lt;data account id&gt;:role/           service-role/AWSGlueServiceRole-data-           bucket-crawler"         ]       },       "Action" :       "glue:*",</pre>	Cloud administrator

Task	Description	Skills required
	<pre data-bbox="592 205 1031 940">           "Resource         " : [           "arn:aws:glue:&lt;reg ion&gt;:&lt;data account id&gt;:catalog",           "arn:aws:glue:&lt;reg ion&gt;:&lt;data account id&gt;:database/*",           "arn:aws:glue:&lt;reg ion&gt;:&lt;data account id&gt;:table/*"         ]       }     ]   } } </pre> <p data-bbox="592 982 1031 1444">This policy allows all AWS Glue actions on all databases and tables in the data account. You can customize the policy to grant only required permissions to the consumer principals. For example, you can provide read-only access to specific tables or views in a database.</p>	

## Access data from the consumer account

Task	Description	Skills required
Create a named reference for the data catalog.	To create a named data catalog reference, use <a href="#">CloudShell</a> or a locally	Cloud administrator

Task	Description	Skills required
	<p>installed AWS CLI to run the following command:</p> <pre data-bbox="594 327 1029 611">aws athena create-data-catalog --name &lt;shared catalog name&gt; --type GLUE --parameters catalog-id=&lt;data account id&gt;</pre>	

Task	Description	Skills required
Grant the IAM role in the consumer account access to the data.	<p>Attach the following policy to the IAM role in the consumer account to grant the role cross-account access to the data:</p> <pre data-bbox="594 489 1027 1814"> {   "Version":     "2012-10-17",   "Statement": [     {       "Effect":         "Allow",       "Action":         "s3:GetObject",       "Resource":         "arn:aws:s3:::data-bucket/*"     },     {       "Effect":         "Allow",       "Action":         "s3:ListBucket",       "Resource":         "arn:aws:s3:::data-bucket"     },     {       "Effect":         "Allow",       "Action":         "glue:*",       "Resource":         [           "arn:aws:glue:&lt;region&gt;:&lt;data account id&gt;:catalog", </pre>	Cloud administrator

Task	Description	Skills required
	<pre data-bbox="609 247 917 682"> "arn:aws:glue:&lt;reg ion&gt;:&lt;data account id&gt;:database/*",  "arn:aws:glue:&lt;reg ion&gt;:&lt;data account id&gt;:table/*"     ]   } ] } </pre> <p data-bbox="592 741 1015 919">Next, use the following template to specify what users can accept the IAM role in its trust policy:</p> <pre data-bbox="609 976 982 1732"> {   "Version":     "2012-10-17",   "Statement": [     {       "Effect":         "Allow",       "Principa 1": {           "AWS":             "arn:aws:iam::&lt;con sumer account id&gt;:user/ &lt;IAM user&gt;"         },       "Action":         "sts:AssumeRole"     }   ] } </pre> <p data-bbox="592 1791 1015 1873">Finally, grant user permissions to assume the IAM role by</p>	

Task	Description	Skills required
<p>(If required) Grant the IAM role in the consumer account access to the data encryption key.</p>	<p>attaching the same policy to the user group they belong to.</p> <p>If the S3 bucket is encrypted by an AWS KMS key, grant <code>kms:Decrypt</code> permission on the key to the IAM role in the consumer account by attaching the following policy to it:</p> <pre data-bbox="594 747 1029 1142"> {   "Effect": "Allow",   "Action": "kms:Decrypt",   "Resource":     "arn:aws:kms:&lt;region&gt;:&lt;data account id&gt;:key/&lt;key id&gt;" }</pre>	<p>Cloud administrator</p>
<p>Switch to the IAM role in the consumer account to access data.</p>	<p>As a data consumer, <a href="#">switch to the IAM role</a> to access data in the data account.</p>	<p>Data consumer</p>



Task	Description	Skills required
Access the data.	<p>Query data using Athena. For example, open the Athena query editor and run the following query:</p> <pre data-bbox="594 443 1027 642">SELECT *   FROM &lt;shared catalog name&gt;.&lt;database name&gt;.&lt;table name&gt;</pre> <p>Instead of using a named catalog reference, you can also refer to the catalog by its Amazon Resource Name (ARN).</p> <p><b>Note:</b> If you use a dynamic catalog reference in a query or view, surround the reference with escaped double quotation marks (\"). For example:</p> <pre data-bbox="594 1262 1027 1577">SELECT *   FROM \"glue:ar n:aws:glue:&lt;region &gt;:&lt;data account id&gt;:catalog\".&lt;dat abase name&gt;.&lt;table name&gt;</pre> <p>For more information, see <a href="#">Cross-account access to AWS Glue data catalogs</a> in the Amazon Athena User Guide.</p>	Data consumer

## Related resources

- [Cross-account access to AWS Glue data catalogs](#) (Athena documentation)
- [\(AWS CLI\) create-data-catalog](#) (AWS CLI Command Reference)
- [Cross-account AWS Glue Data Catalog access with Amazon Athena](#) (AWS Big Data Blog)
- [Security best practices in IAM](#) (IAM documentation)

## Additional information

### Using Lake Formation as an alternative for cross-account sharing

You can also use AWS Lake Formation to share access to AWS Glue catalog objects across accounts. Lake Formation provides fine-grained access control at the column and row level, tag-based access control, governed tables for ACID transactions, and other functionality. Although Lake Formation is well-integrated with Athena, it does require additional configuration compared to this pattern's IAM-only approach. We recommend that you consider the decision to use Lake Formation or IAM-only access controls within the wider context of your overall solution architecture. Considerations include what other services are involved and how they integrate with both approaches.

# Deploy and manage a serverless data lake on the AWS Cloud by using infrastructure as code

Created by Kirankumar Chandrashekar (AWS) and Abdel Jaidi (AWS)

**Environment:** Production

**Technologies:** DataLakes;  
Analytics; Serverless; DevOps

**Workload:** All other workloads

**AWS services:** Amazon S3; Amazon SQS; AWS CloudFormation; AWS Glue; Amazon CloudWatch; AWS Lambda; AWS Step Functions; Amazon DynamoDB

## Summary

This pattern describes how to use [serverless computing](#) and [infrastructure as code](#) (IaC) to implement and administer a data lake on the Amazon Web Services (AWS) Cloud. This pattern is based on the [serverless data lake framework \(SDLF\)](#) workshop developed by AWS.

SDLF is a collection of reusable resources that accelerate the delivery of enterprise data lakes on the AWS Cloud and helps with faster deployment to production. It is used to implement the foundational structure of a data lake by following best practices.

SDLF implements a continuous integration / continuous deployment (CI/CD) process throughout the code and infrastructure deployment by using AWS services such as AWS CodePipeline, AWS CodeBuild, and AWS CodeCommit.

This pattern uses multiple AWS serverless services to simplify data lake management. These include Amazon Simple Storage Service (Amazon S3) and Amazon DynamoDB for storage, AWS Lambda and AWS Glue for computing, and Amazon CloudWatch Events, Amazon Simple Queue Service (Amazon SQS), and AWS Step Functions for orchestration.

AWS CloudFormation and AWS code services act as the IaC layer to provide reproducible and fast deployments with easy operations and administration.

## Prerequisites and limitations

### Prerequisites

- An active AWS account.
- [AWS Command Line Interface \(AWS CLI\)](#), installed and configured.
- A Git client, installed and configured.
- The [SDLF workshop](#), open in a web browser window and ready to use.

### Architecture

The architecture diagram illustrates an event-driven process with the following steps.

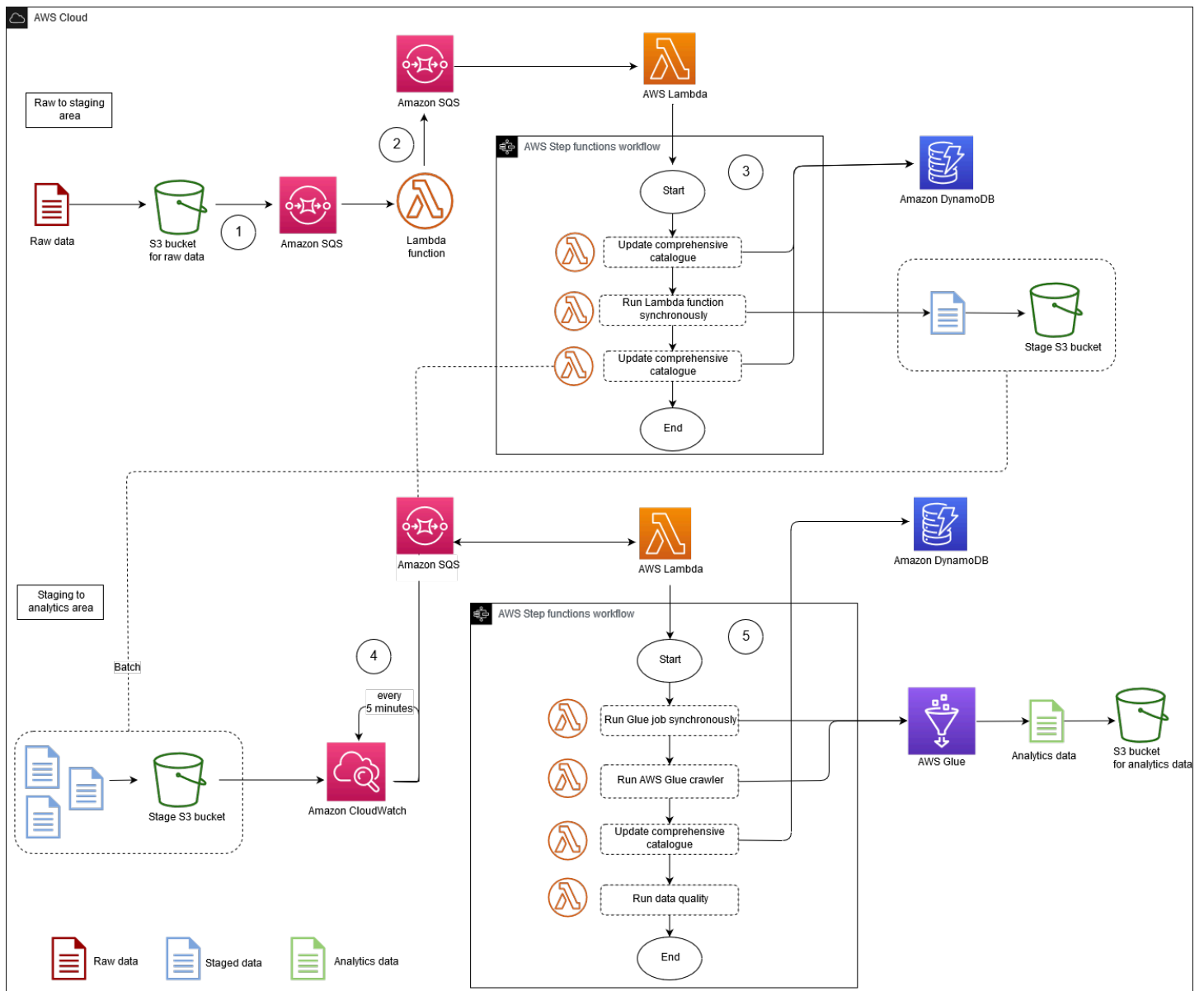

1. After a file is added to the raw data S3 bucket, an Amazon S3 event notification is placed in an SQS queue. Each notification is delivered as a JSON file, which contains metadata such as the S3 bucket name, object key, or timestamp.
2. This notification is consumed by a Lambda function that routes the event to the correct extraction, transformation, and loading (ETL) process based on the metadata. The Lambda function can also use contextual configurations stored in an Amazon DynamoDB table. This step enables decoupling and scaling to multiple applications in the data lake.
3. The event is routed to the first Lambda function in the ETL process, which transforms and moves data from the raw data area to the staging area for the data lake. The first step is to update the comprehensive catalogue. This is a DynamoDB table that contains all the file metadata of the data

lake. Each row in this table holds operational metadata about a single object stored in Amazon S3. A synchronous call is made to a Lambda function that performs a light transformation, which is a computationally inexpensive operation (such as converting a file from one format to another), on the S3 object. Because a new object has been added to the staging S3 bucket, the comprehensive catalog is updated and a message is sent to the SQS queue waiting for the next phase in the ETL.

4. A CloudWatch Events rule triggers a Lambda function every 5 minutes. This function checks if messages were delivered to the SQS queue from the previous ETL phase. If a message was delivered, the Lambda function begins the second function from [AWS Step Functions](#) in the ETL process.
5. A heavy transformation is then applied on a batch of files. This heavy transformation is a computationally expensive operation, such as a synchronous call to an AWS Glue job, AWS Fargate task, Amazon EMR step, or Amazon SageMaker notebook. Table metadata is extracted from the output files by using an AWS Glue crawler, which updates the AWS Glue catalog. File metadata is also added to the comprehensive catalog table in DynamoDB. Finally, a data quality step leveraging [Deequ](#) is also run.

## Technology stack

- Amazon CloudWatch Events
- AWS CloudFormation
- AWS CodePipeline
- AWS CodeBuild
- AWS CodeCommit
- Amazon DynamoDB
- AWS Glue
- AWS Lambda
- Amazon S3
- Amazon SQS
- AWS Step Functions

## Tools

- [Amazon CloudWatch Events](#) – CloudWatch Events delivers a near real-time stream of system events that describe changes in AWS resources.
- [AWS CloudFormation](#) – CloudFormation helps create and provision AWS infrastructure deployments predictably and repeatedly.
- [AWS CodeBuild](#) – CodeBuild is a fully managed build service that compiles your source code, runs unit tests, and produces artifacts that are ready to deploy.
- [AWS CodeCommit](#) – CodeCommit is a version control service hosted by AWS that you can use to privately store and manage assets (such as source code and binary files).
- [AWS CodePipeline](#) – CodePipeline is a continuous delivery service that you can use to model, visualize, and automate the steps required to release your software changes continuously.
- [Amazon DynamoDB](#) – DynamoDB is a fully managed NoSQL database service that provides fast and predictable performance with scalability.
- [AWS Glue](#) – AWS Glue is a fully managed ETL service that makes it easier to prepare and load data for analytics.
- [AWS Lambda](#) – Lambda supports running code without provisioning or managing servers. Lambda runs your code only when needed and scales automatically, from a few requests per day to thousands per second.
- [Amazon S3](#) – Amazon Simple Storage Service (Amazon S3) is a highly scalable object storage service. Amazon S3 can be used for a wide range of storage solutions, including websites, mobile applications, backups, and data lakes.
- [AWS Step Functions](#) – AWS Step Functions is a serverless function orchestrator that makes it easy to sequence AWS Lambda functions and multiple AWS services into business-critical applications.
- [Amazon SQS](#) – Amazon Simple Queue Service (Amazon SQS) is a fully managed message queuing service that helps you decouple and scale microservices, distributed systems, and serverless applications.
- [Deequ](#) – Deequ is a tool that helps you compute data quality metrics for large datasets, define and verify data quality constraints, and stay informed about changes in the data distribution.

### Code repository

The source code and resources for the SDLF are available in the [AWS Labs GitHub repository](#).

## Epics

### Set up the CI/CD pipeline to provision IaC

Task	Description	Skills required
Set up the CI/CD pipeline to manage IaC for the data lake.	Sign in to the AWS Management Console and follow the steps from the <a href="#">Initial setup</a> section of the SDLF workshop. This creates the initial CI/CD resources , such as CodeCommit repositories, CodeBuild environments, and CodePipeline pipelines that provision and manage IaC for the data lake.	DevOps engineer

### Version-control the IaC

Task	Description	Skills required
Clone the CodeCommit repository on your local machine.	Follow the steps from the <a href="#">Deploying the foundations</a> section of the SDLF workshop. This helps you clone the Git repository that hosts IaC into your local environment.  For more information, see <a href="#">Connecting to CodeCommit repositories</a> from the CodeCommit documentation.	DevOps engineer



Task	Description	Skills required
Modify the CloudFormation templates.	<p>Use your local workstation and a code editor to modify the CloudFormation templates according to your use cases or requirements. Commit them to the locally cloned Git repository.</p> <p>For more information, see <a href="#">Working with AWS CloudFormation templates</a> from the AWS CloudFormation documentation.</p>	DevOps engineer
Push the changes to the CodeCommit repository.	<p>Your infrastructure code is now under version control and modifications to your code base are tracked. When you push a change to the CodeCommit repository, CodePipeline automatically applies it to your infrastructure and delivers it to CodeBuild.</p> <p><b>Important:</b> If you use the AWS SAM CLI in CodeBuild, run the <code>sam package</code> and <code>sam deploy</code> commands. If you use AWS CLI, run the <code>aws cloudformation package</code> and <code>aws cloudformation deploy</code> commands.</p>	DevOps engineer

## Related resources

### Set up the CI/CD pipeline to provision IaC

- [SDLF workshop – Initial setup](#)

### Version-control the IaC

- [SDLF workshop – Deploying the foundations](#)
- [Connecting to CodeCommit repositories](#)
- [Working with AWS CloudFormation templates](#)

### Other resources

- [AWS serverless data analytics pipeline reference architecture](#)
- [SDLF documentation](#)

# Migrate Hadoop data to Amazon S3 by using WANdisco LiveData Migrator

Created by Tony Velcich

<b>Source:</b> On-premises Hadoop cluster	<b>Target:</b> Amazon S3	<b>R Type:</b> Rehost
<b>Environment:</b> Production	<b>Technologies:</b> DataLakes; Big data; Hybrid cloud; Migration	<b>Workload:</b> All other workloads
<b>AWS services:</b> Amazon S3		

## Summary

This pattern describes the process for migrating Apache Hadoop data from a Hadoop Distributed File System (HDFS) to Amazon Simple Storage Service (Amazon S3). It uses WANdisco LiveData Migrator to automate the data migration process.

## Prerequisites and limitations

### Prerequisites

- Hadoop cluster edge node where LiveData Migrator will be installed. The node should meet the following requirements:
  - Minimum specification: 4 CPUs, 16 GB RAM, 100 GB storage.
  - 2 Gbps minimum network.
  - Port 8081 accessible on your edge node to access the WANdisco UI.
  - Java 1.8 64-bit.
  - Hadoop client libraries installed on the edge node.
  - Ability to authenticate as the [HDFS superuser](#) (for example, "hdfs").
  - If Kerberos is enabled on your Hadoop cluster, a valid keytab that contains a suitable principal for the HDFS superuser must be available on the edge node.
  - See the [release notes](#) for a list of supported operating systems.

- An active AWS account with access to an S3 bucket.
- An AWS Direct Connect link established between your on-premises Hadoop cluster (specifically the edge node) and AWS.

## Product versions

- LiveData Migrator 1.8.6
- WANdisco UI (OneUI) 5.8.0

## Architecture

### Source technology stack

- On-premises Hadoop cluster

### Target technology stack

- Amazon S3

## Architecture

The following diagram shows the LiveData Migrator solution architecture.

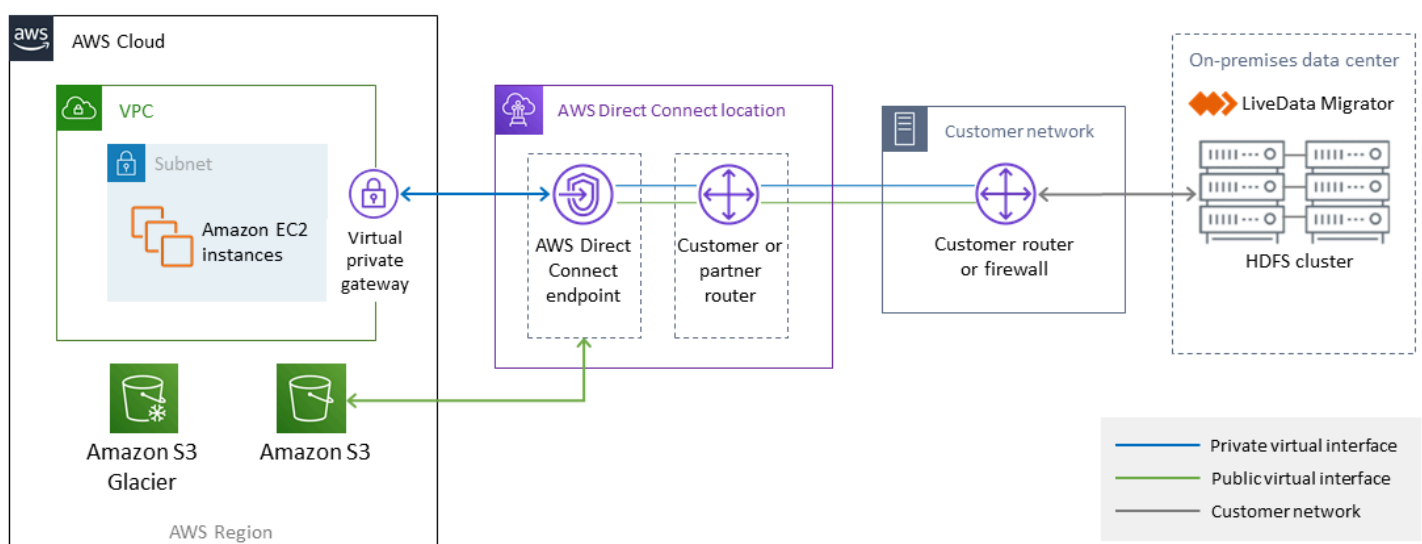

The workflow consists of four primary components for data migration from on-premises HDFS to Amazon S3.

- [LiveData Migrator](#) – Automates the migration of data from HDFS to Amazon S3, and resides on an edge node of the Hadoop cluster.
- [HDFS](#) – A distributed file system that provides high-throughput access to application data.
- [Amazon S3](#) – An object storage service that offers scalability, data availability, security, and performance.
- [AWS Direct Connect](#) – A service that establishes a dedicated network connection from your on-premises data centers to AWS.

## Automation and scale

You will typically create multiple migrations so that you can select specific content from your source file system by path or directory. You can also migrate data to multiple, independent file systems at the same time by defining multiple migration resources.

## Epics

### Configure Amazon S3 storage in your AWS account

Task	Description	Skills required
Sign in to your AWS account.	Sign in to the AWS Management Console and open the Amazon S3 console at <a href="https://console.aws.amazon.com/s3/">https://console.aws.amazon.com/s3/</a> .	AWS experience
Create an S3 bucket.	If you don't already have an existing S3 bucket to use as the target storage, choose the "Create bucket" option on the Amazon S3 console, and specify a bucket name, AWS Region, and bucket settings for block public	AWS experience

Task	Description	Skills required
	<p>access. AWS and WANdisco recommend that you enable the block public access options for the S3 bucket, and set up the bucket access and user permission policies to meet your organization's requirements. An AWS example is provided at <a href="https://docs.aws.amazon.com/AmazonS3/latest/dev/example-walkthroughs-managing-access-example1.html">https://docs.aws.amazon.com/AmazonS3/latest/dev/example-walkthroughs-managing-access-example1.html</a>.</p>	

## Install LiveData Migrator

Task	Description	Skills required
<p>Download the LiveData Migrator installer.</p>	<p>Download the LiveData Migrator installer and upload it to the Hadoop edge node. You can download a free trial of LiveData Migrator at <a href="https://www2.wandisco.com/ldm-trial">https://www2.wandisco.com/ldm-trial</a>. You can also obtain access to LiveData Migrator from AWS Marketplace, at <a href="https://aws.amazon.com/marketplace/pp/B07B8SZND9">https://aws.amazon.com/marketplace/pp/B07B8SZND9</a>.</p>	<p>Hadoop administrator, Application owner</p>
<p>Install LiveData Migrator.</p>	<p>Use the downloaded installer and install LiveData Migrator as the HDFS superuser on an edge node in your Hadoop</p>	<p>Hadoop administrator, Application owner</p>

Task	Description	Skills required
	cluster. See the "Additional information" section for the installation commands.	
Check the status of LiveData Migrator and other services.	Check the status of LiveData Migrator, Hive migrator, and WANdisco UI by using the commands provided in the "Additional information" section.	Hadoop administrator, Application owner

### Configure storage through the WANdisco UI

Task	Description	Skills required
Register your LiveData Migrator account.	Log in to the WANdisco UI through a web browser on port 8081 (on the Hadoop edge node) and provide your details for registration. For example, if you are running LiveData Migrator on a host named myldmhost.example.com, the URL would be: <a href="http://myldmhost.example.com:8081">http://myldmhost.example.com:8081</a>	Application owner
Configure your source HDFS storage.	Provide the configuration details needed for your source HDFS storage. This will include the "fs.defaultFS" value and a user-defined storage name. If Kerberos is enabled, provide the principal and keytab location for	Hadoop administrator, Application owner

Task	Description	Skills required
	<p>LiveData Migrator to use. If NameNode HA is enabled on the cluster, provide a path to the core-site.xml and hdfs-site.xml files on the edge node.</p>	
<p>Configure your target Amazon S3 storage.</p>	<p>Add your target storage as the S3a type. Provide the user-defined storage name and the S3 bucket name. Enter "org.apache.hadoop.fs.s3a.SimpleAWSCredentialProvider" for the Credentials Provider option, and provide the AWS access and secret keys for the S3 bucket. Additional S3a properties will also be needed. For details, see the "S3a Properties" section in the LiveData Migrator documentation at <a href="https://docs.wandisco.com/live-data-migrator/docs/command-reference/#filesystem-add-s3a">https://docs.wandisco.com/live-data-migrator/docs/command-reference/#filesystem-add-s3a</a>.</p>	<p>AWS, Application owner</p>

## Prepare for the migration

Task	Description	Skills required
<p>Add exclusions (if needed).</p>	<p>If you want to exclude specific datasets from migration, add exclusions for the source HDFS storage. These</p>	<p>Hadoop administrator, Application owner</p>



Task	Description	Skills required
	exclusions can be based on file size, file names (based on regex patterns), and modification date.	

## Create and start the migration

Task	Description	Skills required
Create and configure the migration.	Create a migration in the dashboard of the WANdisco UI. Choose your source (HDFS) and target (the S3 bucket). Add new exclusions that you have defined in the previous step. Select either the "Overwrite" or the "Skip if Size Match" option. Create the migration when all fields are complete.	Hadoop administrator, Application owner
Start the migration.	On the dashboard, select the migration you created. Click to start the migration. You can also start a migration automatically by choosing the auto-start option when you create the migration.	Application owner

## Manage bandwidth (optional)

Task	Description	Skills required
Set a network bandwidth limit between the source and target.	In the Storages list on the dashboard, select your source storage and select "Bandwidth Management" in the Grouping list. Clear the unlimited option, and define the maximum bandwidth limit and unit. Choose "Apply."	Application owner, Networking

## Monitor and manage migrations

Task	Description	Skills required
View migration information using the WANdisco UI.	Use the WANdisco UI to view license, bandwidth, storage and migration information. The UI also provides a notification system so you can receive notifications about errors, warnings, or important milestones in your usage.	Hadoop administrator, Application owner
Stop, resume, and delete migrations.	You can stop a migration from transferring content to its target by placing it in the STOPPED state. Stopped migrations can be resumed. Migrations in the STOPPED state can also be deleted.	Hadoop administrator, Application owner

## Related resources

- [LiveData Migrator documentation](#)
- [LiveData Migrator in AWS Marketplace](#)
- [WANdisco support community](#)
- [WANdisco LiveData Migrator demonstration](#) (video)

## Additional information

### Installing LiveData Migrator

You can use the following commands to install LiveData Migrator, assuming that the installer is inside your working directory:

```
su - hdfs
chmod +x livedata-migrator.sh && sudo ./livedata-migrator.sh
```

### Checking the status of LiveData Migrator and other services after installation

Use the following commands to check the status of LiveData Migrator, Hive migrator, and WANdisco UI:

```
service livedata-migrator status
service hivemigrator status
service livedata-ui status
```

## More patterns

- [Build an ETL service pipeline to load data incrementally from Amazon S3 to Amazon Redshift using AWS Glue](#)
- [Deliver DynamoDB records to Amazon S3 using Kinesis Data Streams and Firehose with AWS CDK](#)
- [Ensure an Amazon Redshift cluster is encrypted upon creation](#)
- [Execute Amazon Redshift SQL queries by using Terraform](#)
- [Generate test data using an AWS Glue job and Python](#)
- [Migrate Amazon RDS for Oracle to Amazon RDS for PostgreSQL in SSL mode by using AWS DMS](#)
- [Migrate data to the AWS Cloud by using Starburst](#)
- [Set up a minimum viable data space to share data between organizations](#)
- [Optimize the ETL ingestion of input file size on AWS](#)
- [Orchestrate an ETL pipeline with validation, transformation, and partitioning using AWS Step Functions](#)
- [Transfer large-scale Db2 z/OS data to Amazon S3 in CSV files](#)
- [Visualize Amazon Redshift audit logs using Amazon Athena and Amazon QuickSight](#)

# Databases

## Topics

- [Access on-premises Microsoft SQL Server tables from Microsoft SQL Server on Amazon EC2 using linked servers](#)
- [Add HA to Oracle PeopleSoft on Amazon RDS Custom by using a read replica](#)
- [Assess query performance for migrating SQL Server databases to MongoDB Atlas on AWS](#)
- [Automate cross-Region failover and failback by using DR Orchestrator Framework](#)
- [Automate the replication of Amazon RDS instances across AWS accounts](#)
- [Automatically back up SAP HANA databases using Systems Manager and EventBridge](#)
- [Block public access to Amazon RDS by using Cloud Custodian](#)
- [Configure cross-account access to Amazon DynamoDB](#)
- [Configure read-only routing in an Always On availability group in SQL Server on AWS](#)
- [Connect by using an SSH tunnel in pgAdmin](#)
- [Convert JSON Oracle queries into PostgreSQL database SQL](#)
- [Copy Amazon DynamoDB tables across accounts using AWS Backup](#)
- [Copy Amazon DynamoDB tables across accounts using a custom implementation](#)
- [Create detailed cost and usage reports for Amazon RDS and Amazon Aurora](#)
- [Emulate Oracle RAC workloads using custom endpoints in Aurora PostgreSQL](#)
- [Enable encrypted connections for PostgreSQL DB instances in Amazon RDS](#)
- [Encrypt an existing Amazon RDS for PostgreSQL DB instance](#)
- [Enforce automatic tagging of Amazon RDS databases at launch](#)
- [Estimate the cost of a DynamoDB table for on-demand capacity](#)
- [Estimate storage costs for an Amazon DynamoDB table](#)
- [Estimate the Amazon RDS engine size for an Oracle database by using AWR reports](#)
- [Export Amazon RDS for SQL Server tables to an S3 bucket by using AWS DMS](#)
- [Handle anonymous blocks in Dynamic SQL statements in Aurora PostgreSQL](#)
- [Handle overloaded Oracle functions in Aurora PostgreSQL-Compatible](#)
- [Help enforce DynamoDB tagging](#)
- [Implement cross-Region disaster recovery with AWS DMS and Amazon Aurora](#)

- [Migrate Oracle functions and procedures that have more than 100 arguments to PostgreSQL](#)
- [Migrate Amazon RDS for Oracle DB instances to other accounts that use AMS](#)
- [Migrate Oracle OUT bind variables to a PostgreSQL database](#)
- [Migrate SAP HANA to AWS using SAP HSR with the same hostname](#)
- [Migrate SQL Server to AWS using distributed availability groups](#)
- [Migrate from Oracle 8i or 9i to Amazon RDS for Oracle using SharePlex and AWS DMS](#)
- [Monitor Amazon Aurora for instances without encryption](#)
- [Monitor Oracle GoldenGate logs by using Amazon CloudWatch](#)
- [Replatform Oracle Database Enterprise Edition to Standard Edition 2 on Amazon RDS for Oracle](#)
- [Replicate mainframe databases to AWS by using Precisely Connect](#)
- [Schedule jobs for Amazon RDS for PostgreSQL and Aurora PostgreSQL by using Lambda and Secrets Manager](#)
- [Secure and streamline user access in a Db2 federation database on AWS by using trusted contexts](#)
- [Send notifications for an Amazon RDS for SQL Server database instance by using an on-premises SMTP server and Database Mail](#)
- [Set up disaster recovery for SAP on IBM Db2 on AWS](#)
- [Set up a CI/CD pipeline for database migration by using Terraform](#)
- [Set up an HA/DR architecture for Oracle E-Business Suite on Amazon RDS Custom with an active standby database](#)
- [Set up data replication between Amazon RDS for MySQL and MySQL on Amazon EC2 using GTID](#)
- [Transition roles for an Oracle PeopleSoft application on Amazon RDS Custom for Oracle](#)
- [Unload data from an Amazon Redshift cluster across accounts to Amazon S3](#)
- [Database migration patterns by workload](#)
- [More patterns](#)

# Access on-premises Microsoft SQL Server tables from Microsoft SQL Server on Amazon EC2 using linked servers

Created by Tirumala Dasari (AWS) and Eduardo Valentim (AWS)

**Environment:** PoC or pilot

**Technologies:** Databases

**Workload:** Microsoft

## Summary

This pattern describes how to access on-premises Microsoft SQL Server database tables running on Microsoft Windows, from Microsoft SQL Server databases running or hosted on Amazon Elastic Compute Cloud (Amazon EC2) Windows or Linux instances by using linked servers.

## Prerequisites and limitations

### Prerequisites

- An active AWS account
- Amazon EC2 with Microsoft SQL Server running on Amazon Linux AMI (Amazon Machine Image)
- AWS Direct Connect between the on-premises Microsoft SQL Server (Windows) server and the Windows or Linux EC2 instance

### Product versions

- SQL Server 2016 or later

## Architecture

### Source technology stack

- On-premises Microsoft SQL Server database running on Windows
- Amazon EC2 with Microsoft SQL Server running on Windows AMI or Linux AMI

### Target technology stack

- Amazon EC2 with Microsoft SQL Server running on Amazon Linux AMI
- Amazon EC2 with Microsoft SQL Server running on Windows AMI

## Source and target database architecture

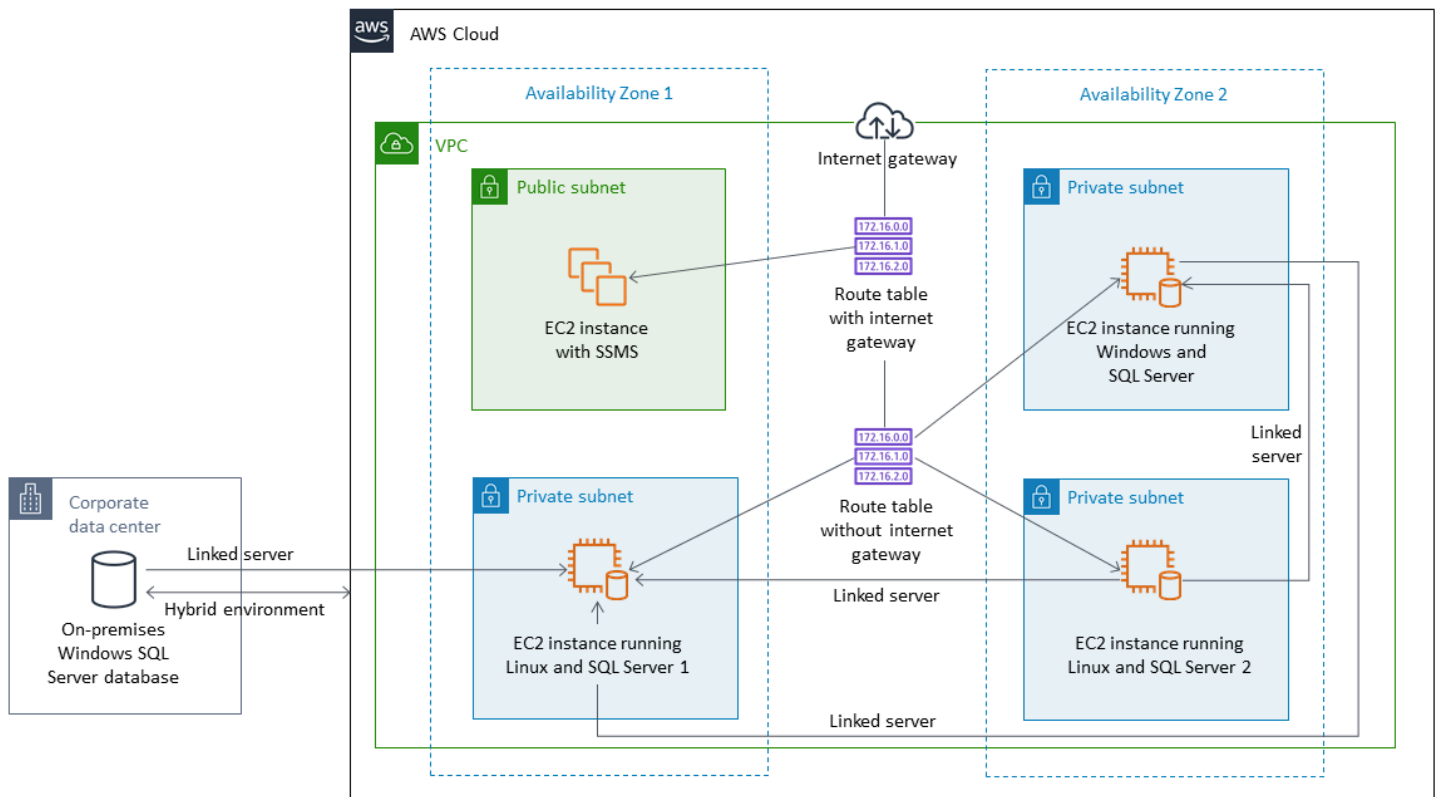

## Tools

- [Microsoft SQL Server Management Studio \(SSMS\)](#) is an integrated environment for managing a SQL Server infrastructure. It provides a user interface and a group of tools with rich script editors that interact with SQL Server.



## Epics

### Change authentication mode to Windows for SQL Server in Windows SQL Server

Task	Description	Skills required
Connect to Windows SQL Server through SSMS.		DBA
Change the authentication mode to Windows in SQL Server from the context (right-click) menu for the Windows SQL Server instance.		DBA

### Restart the Windows MSSQL service

Task	Description	Skills required
Restart the SQL service.	<ol style="list-style-type: none"> <li>1. In SSMS Object Explorer, choose the SQL Server instance.</li> <li>2. Open the context (right-click) menu.</li> <li>3. Choose <b>Restart</b>.</li> </ol>	DBA

### Create new login and choose databases to access in Windows SQL Server

Task	Description	Skills required
In the Security tab, open the context (right-click) menu for Login and select a new login.		DBA
In the General tab, choose SQL Server authentication,		DBA

Task	Description	Skills required
enter a user name, enter the password, and then confirm the password and clear the option for changing the password at the next login.		
In the Server Roles tab, choose Public.		DBA
In the User Mapping tab, choose the database and schema you want to access, and then highlight the database to select database roles.	Select public and db_datareader to access data from the database tables.	DBA
Choose OK to create a user.		DBA

### Add Windows SQL Server IP to Linux SQL Server host file

Task	Description	Skills required
Connect to the Linux SQL Server box through the terminal window.		DBA
Open the /etc/hosts file and add the IP address of the Windows machine with SQL Server.		DBA
Save the hosts file.		DBA

## Create linked server on Linux SQL Server

Task	Description	Skills required
Create a linked server by using the stored procedures <code>master.sys.sp_addlinkedserver</code> and <code>master.dbo.sp_addlinkedserverlogin</code> .	For more information about using these stored procedures, see the <i>Additional information</i> section.	DBA, Developer

## Verify the created linked server and databases in SSMS

Task	Description	Skills required
In Linux SQL Server in SSMS, go to Linked Servers and refresh.		DBA
Expand the created linked servers and catalogs in the left pane.	You'll see the selected SQL Server databases with tables and views.	DBA

## Verify that you can access Windows SQL Server database tables

Task	Description	Skills required
In the SSMS query window, run the query: <code>"select top 3 * from [sqllin].dms_sample_win.dbo.mlb_data"</code> .	Note that the FROM clause uses a four-part syntax: <code>computer.database.schema.table</code> (e.g., <code>SELECT name "SQL2 databases" FROM [sqllin].master.sys.databases</code> ). In our example, we created an alias for SQL2 in the hosts file, so you don't need to enter the actual NetBIOS	DBA, Developer

Task	Description	Skills required
	name between the square brackets. If you do use the actual NetBIOS names, note that AWS defaults to NetBIOS names like Win-xxxx, and SQL Server requires square brackets for names with dashes.	

## Related resources

- [Release notes for SQL Server on Linux](#)

## Additional information

### Using stored procedures to create linked servers

SSMS doesn't support the creation of linked servers for Linux SQL Server, so you have to use these stored procedures to create them:

```
EXEC master.sys.sp_addlinkedserver @server= N'SQLLIN' , @srvproduct= N'SQL Server'  
EXEC master.dbo.sp_addlinkedsrvlogin  
@rmtsrvname=N'SQLLIN',@useself=N'False',@locallogin=NULL,@rmtuser=N'username',@rmtpassword='Te
```

Note 1: Enter the sign-in credentials that you created earlier in Windows SQL Server in the stored procedure `master.dbo.sp_addlinkedsrvlogin`.

Note 2: `@server` name `SQLLIN` and host file entry name `172.12.12.4 SQLLIN` should be the same.

You can use this process to create linked servers for the following scenarios:

- Linux SQL Server to Windows SQL Server through a linked server (as specified in this pattern)
- Windows SQL Server to Linux SQL Server through a linked server

- Linux SQL Server to another Linux SQL Server through a linked server

# Add HA to Oracle PeopleSoft on Amazon RDS Custom by using a read replica

Created by *sampath kathirvel* (AWS)

**Environment:** Production

**Technologies:** Databases;  
Infrastructure

**Workload:** Oracle

**AWS services:** Amazon RDS

## Summary

To run the [Oracle PeopleSoft](#) enterprise resource planning (ERP) solution on Amazon Web Services (AWS), you can use [Amazon Relational Database Service \(Amazon RDS\)](#) or [Amazon RDS Custom for Oracle](#), which supports legacy, custom, and packaged applications that require access to the underlying operating system and database environment. For key factors to consider when planning a migration, see [Oracle database migration strategies](#) in AWS Prescriptive Guidance.

As of this writing, RDS Custom for Oracle doesn't support the [Multi-AZ](#) option, which is available for [Amazon RDS for Oracle](#) as an HA solution using storage replication. Instead, this pattern achieves HA by using a standby database that creates and maintains a physical copy of the primary database. The pattern focuses on the steps to run a PeopleSoft application database on Amazon RDS Custom with HA by using Oracle Data Guard to set up a read replica.

This pattern also changes the read replica to read-only mode. Having your read replica in read-only mode provides additional benefits:

- Offloading read-only workloads from the primary database
- Enabling automatic repair of corrupted blocks by retrieving healthy blocks from the standby database using the Oracle Active Data Guard feature
- Using the Far Sync capability to keep the remote standby database in sync without the performance overhead associated with long-distance redo log transmission.

Using a replica in read-only mode requires the [Oracle Active Data Guard](#) option, which comes at an extra cost because it is a separately licensed feature of Oracle Database Enterprise Edition.

## Prerequisites and limitations

### Prerequisites

- An existing PeopleSoft application on Amazon RDS Custom. If you don't have an application, see the pattern [Migrate Oracle PeopleSoft to Amazon RDS Custom](#).
- A single PeopleSoft application tier. However, you can adapt this pattern to work with multiple application tiers.
- Amazon RDS Custom configured with at least 8 GB of swap space.
- An Oracle Active Data Guard database license for converting the read replica into read-only mode and using it for offloading reporting tasks to the standby. For more information, see the [Oracle Technology Commercial Price List](#).

### Limitations

- General limitations and unsupported configurations for [RDS Custom for Oracle](#)
- Limitations associated with [Amazon RDS Custom for Oracle read replicas](#)

### Product versions

- For Oracle Database versions supported by Amazon RDS Custom, see [RDS Custom for Oracle](#).
- For Oracle Database instance classes supported by Amazon RDS Custom, see [DB instance class support for RDS Custom for Oracle](#).

## Architecture

### Target technology stack

- Amazon RDS Custom for Oracle
- AWS Secrets Manager
- Oracle Active Data Guard
- Oracle PeopleSoft application

### Target architecture

The following diagram shows an Amazon RDS Custom DB instance and an Amazon RDS Custom read replica. The read replica uses Oracle Active Data Guard to replicate to another Availability Zone. You can also use the read replica to offload read traffic on the primary database and for reporting purposes.

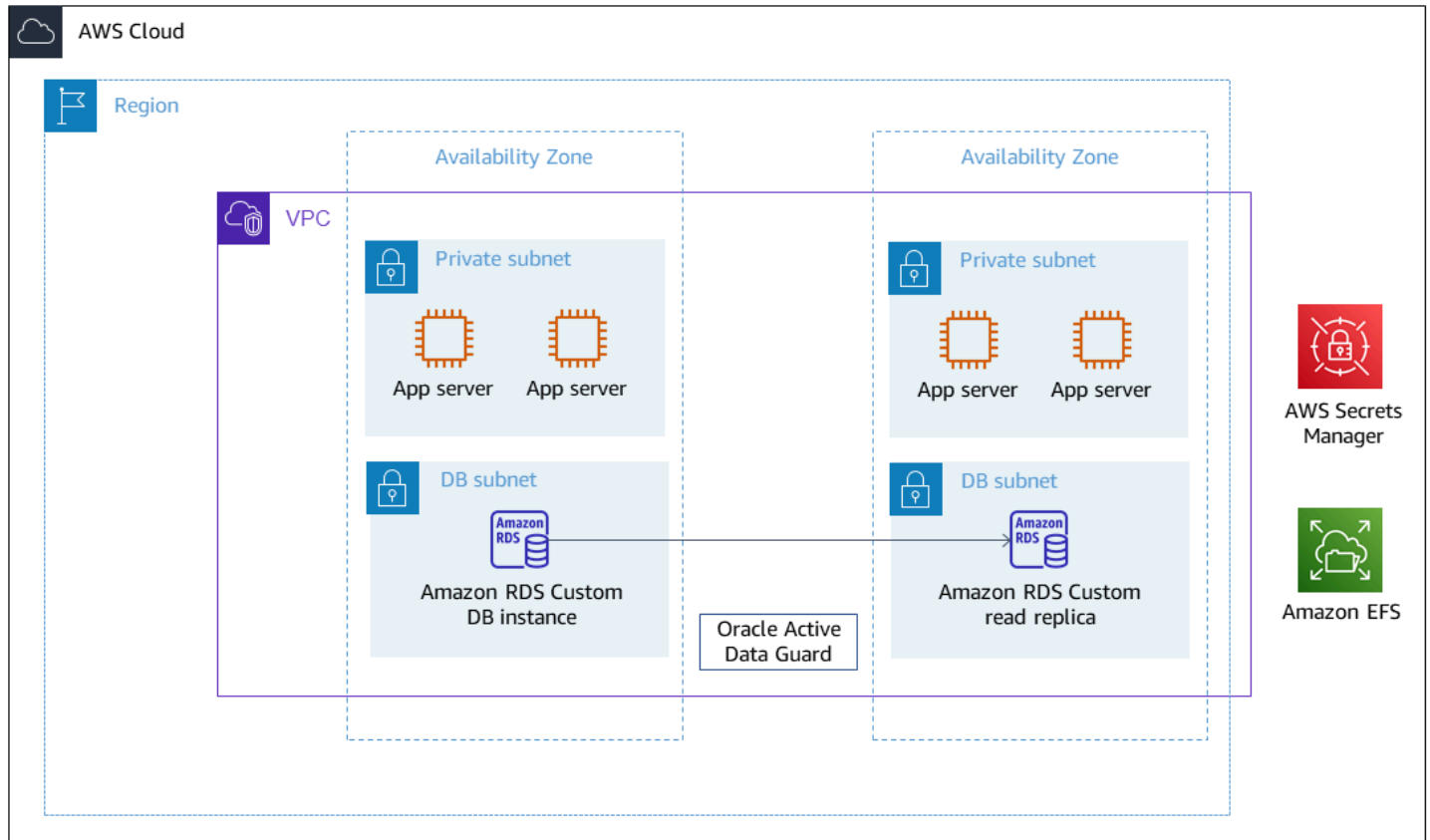

For a representative architecture using Oracle PeopleSoft on AWS, see [Set up a highly available PeopleSoft architecture on AWS](#).

## Tools

### AWS services

- [Amazon RDS Custom for Oracle](#) is a managed database service for legacy, custom, and packaged applications that require access to the underlying operating system and database environment.
- [AWS Secrets Manager](#) helps you replace hardcoded credentials in your code, including passwords, with an API call to Secrets Manager to retrieve the secret programmatically. In this pattern, you retrieve the database user passwords from Secrets Manager for RDS\_DATAGUARD with the secret name `do-not-delete-rds-custom-+<<RDS Resource ID>>+-dg`.



## Other Tools

- [Oracle Data Guard](#) helps you create, maintain, manage, and monitor standby databases.

## Best practices

To work toward a zero data loss (RPO=0) objective, use the MaxAvailability Data Guard protection mode, with the redo transport SYNC+NOAFFIRM setting for better performance. For more information about selecting the database protection mode, see the *Additional information* section.

## Epics

### Create the read replica

Task	Description	Skills required
Create the read replica.	<p>To create a read replica of the Amazon RDS Custom DB instance, follow the instructions in the <a href="#">Amazon RDS documentation</a> and use the Amazon RDS Custom DB instance that you created (see the <i>Prerequisites</i> section) as the source database.</p> <p>By default, the Amazon RDS Custom read replica is created as a physical standby and is in the mounted state. This is intentional to ensure compliance with the Oracle Active Data Guard license.</p> <p>This pattern includes code for setting up a multitenant</p>	DBA

Task	Description	Skills required
	container database (CDB) or a non-CDB instance.	

## Change Oracle Data Guard protection mode to MaxAvailability

Task	Description	Skills required
Access the Data Guard broker configuration on the primary database.	<p>In this example, the Amazon RDS Custom read replica is RDS_CUSTOM_ORCL_D for the Non-CDB instance and RDS_CUSTOM_RDSCDB_B for the CDB instance. The databases for Non-CDB are orcl_a (primary) and orcl_d (standby). The database names for CDB are rdscdb_a (primary) and rdscdb_b (standby).</p> <p>You can connect to the RDS Custom read replica directly or through the primary database. You can find the net service name for your database in the tnsnames.ora file located in the \$ORACLE_HOME/network/admin directory. RDS Custom for Oracle automatically populates these entries for your primary database and your read replicas.</p>	DBA

Task	Description	Skills required
	<p>The password for the RDS_DATAGUARD user is stored in AWS Secrets Manager, with secret name <code>do-not-delete-rds-custom-+&lt;&lt;RDS Resource ID&gt;&gt;+-dg</code>. For more information on how to connect to an RDS Custom instance using the SSH (Secure Shell) key retrieved from Secrets Manager, see <a href="#">Connecting to your RDS Custom DB instance using SSH</a>.</p> <p>To access the Oracle Data Guard broker configuration through the Data Guard command line (<code>dgmgrl</code>), use the following code.</p> <p><b>Non-CDB</b></p> <pre data-bbox="594 1304 1029 1791">\$ dgmgrl RDS_DATAGUARD@RDS_CUSTOM_ORCL_D DGMGRL for Linux:   Release 19.0.0.0.0 -   Production on Fri Sep 30 22:44:49 2022   Version 19.10.0.0.0   Copyright (c) 1982,   2019, Oracle and/or its   affiliates. All rights   reserved.</pre>	

Task	Description	Skills required
	<pre> Welcome to DGMGRL, type "help" for informati on. Password: Connected to "ORCL_D" Connected as SYSDG. DGMGRL&gt; DGMGRL&gt; show database orcl_d Database - orcl_d Role: PHYSICAL STANDBY Intended State: APPLY- ON Transport Lag: 0 seconds (computed 0 seconds ago) Apply Lag: 0 seconds (computed 0 seconds ago) Average Apply Rate: 11.00 KByte/s Instance(s): ORCL SUCCESS DGMGRL&gt; </pre> <p><b>CDB</b></p> <pre> -bash-4.2\$ dgmgrl C##RDS_DATAGUARD@R DS_CUSTOM_RDSCDB_B DGMGRL for Linux: Release 19.0.0.0.0 - Production on Wed Jan 11 20:24:11 2023 Version 19.16.0.0.0 Copyright (c) 1982, 2019, Oracle and/or its affiliates. All rights reserved. </pre>	

Task	Description	Skills required
	<pre>Welcome to DGMGRL, type "help" for informati on. Password: Connected to "RDSCDB_B " Connected as SYSDBG. DGMGRL&gt; DGMGRL&gt; show database rdscdb_b Database - rdscdb_b   Role:   PHYSICAL STANDBY   Intended State:   APPLY-ON   Transport Lag:   0 seconds (computed 1 second ago)   Apply Lag:   0 seconds (computed 1 second ago)   Average Apply Rate:   2.00 KByte/s   Real Time Query:   OFF   Instance(s):   RDSCDB Database Status: SUCCESS DGMGRL&gt;</pre>	

Task	Description	Skills required
<p>Change the log transport setting by connecting to DGMGRL from the primary node.</p>	<p>Change the log transport mode to FastSync, corresponding to the redo transport setting SYNC+NOAF FIRM . To ensure that you have valid settings after the role switch, change it for both the primary database and the standby database.</p> <p><b>Non-CDB</b></p> <pre>DGMGRL&gt; DGMGRL&gt; edit database   orcl_d set property   logxptmode=fastsync; Property "logxptmode"   updated DGMGRL&gt; show database   orcl_d LogXptMode; LogXptMode = 'fastsync '  DGMGRL&gt; edit database   orcl_a set property   logxptmode=fastsync; Property "logxptmode"   updated DGMGRL&gt; show database   orcl_a logxptmode; LogXptMode = 'fastsync '  DGMGRL&gt;</pre> <p><b>CDB</b></p> <pre>DGMGRL&gt; edit database   rdscdb_b set property   logxptmode=fastsyn c;DGMGRL&gt; edit database</pre>	<p>DBA</p>

Task	Description	Skills required
	<pre>rdscdb_b set property logxptmode=fastsync; Property "logxptmode" updated DGMGRL&gt; show database rdscdb_b LogXptMode; LogXptMode = 'fastsync' DGMGRL&gt; edit database rdscdb_a set property logxptmode=fastsync; Property "logxptmode" updated DGMGRL&gt; show database rdscdb_a logxptmode; LogXptMode = 'fastsync' DGMGRL&gt;</pre>	

Task	Description	Skills required
Change the protection mode to MaxAvailability.	<p>Change the protection mode to MaxAvailability by connecting to DGMGRL from the primary node.</p> <p><b>Non-CDB</b></p> <pre>DGMGRL&gt; edit configuration set protection mode as maxavailability; Succeeded. DGMGRL&gt; show configuration; Configuration - rds_dg Protection Mode:   MaxAvailability Members: orcl_a - Primary database orcl_d - Physical standby database Fast-Start Failover:   Disabled Configuration Status: SUCCESS (status updated 38 seconds ago) DGMGRL&gt;</pre> <p><b>CDB</b></p> <pre>DGMGRL&gt; show configuration Configuration - rds_dg Protection Mode:   MaxAvailability Members:   rdscdb_a - Primary database</pre>	DBA



Task	Description	Skills required
	<pre> rdscdb_b - Physical standby database Fast-Start Failover: Disabled Configuration Status: SUCCESS (status updated 57 seconds ago) DGMGRL&gt; </pre>	

## Change the replica status from mount to read-only and enable redo apply

Task	Description	Skills required
Stop redo apply for the standby database.	<p>The read replica is created in MOUNT mode by default. To open it in read-only mode, you first need to turn off redo apply by connecting to DGMGRL from the primary or standby node.</p> <p><b>Non-CDB</b></p> <pre> DGMGRL&gt; show database orcl_d DGMGRL&gt; show database orcl_d Database - orcl_d Role: PHYSICAL STANDBY Intended State: APPLY- ON Transport Lag: 0 seconds (computed 1 second ago) Apply Lag: 0 seconds (computed 1 second ago) Average Apply Rate: 11.00 KByte/s Real Time Query: OFF </pre>	DBA

Task	Description	Skills required
	<pre> Instance(s): ORCL Database Status: SUCCESS DGMGRL&gt; edit database   orcl_d set state=app ly-off; Succeeded. DGMGRL&gt; show database   orcl_d Database - orcl_d Role: PHYSICAL STANDBY Intended State: APPLY- OFF Transport Lag: 0   seconds (computed 1   second ago) Apply Lag: 42 seconds   (computed 1 second ago) Average Apply Rate:   (unknown) Real Time Query: OFF Instance(s): ORCL Database Status: SUCCESS DGMGRL&gt;  <b>CDB</b>  DGMGRL&gt; show configura tionDGMGRL&gt; show configuration Configuration - rds_dg   Protection Mode:   MaxAvailability   Members:     rdscdb_a - Primary   database     rdscdb_b - Physical   standby database </pre>	

Task	Description	Skills required
	<pre> Fast-Start Failover:   Disabled Configuration Status: SUCCESS (status   updated 57 seconds ago) DGMGRL&gt; show database   rdscdb_b; Database - rdscdb_b   Role:   PHYSICAL STANDBY   Intended State:   APPLY-ON   Transport Lag:   0 seconds (computed 1   second ago)   Apply Lag:   0 seconds (computed 1   second ago)   Average Apply Rate:   2.00 KByte/s   Real Time Query:   OFF   Instance(s):   RDSCDB Database Status: SUCCESS DGMGRL&gt; edit database   rdscdb_b set state=app   ly-off; Succeeded. DGMGRL&gt; show database   rdscdb_b; Database - rdscdb_b   Role:   PHYSICAL STANDBY   Intended State:   APPLY-OFF   Transport Lag:   0 seconds (computed 1   second ago) </pre>	

Task	Description	Skills required
	<p>Apply Lag: 0 seconds (computed 1 second ago) Average Apply Rate: (unknown) Real Time Query: OFF Instance(s): RDSCDB Database Status: SUCCESS</p>	

Task	Description	Skills required
<p>Open the read replica instance in read-only mode.</p>	<p>Connect to the standby database by using the TNS entry, and open it in read-only mode by connecting to it from the primary or standby node.</p> <p><b>Non-CDB</b></p> <pre data-bbox="597 619 1027 1862"> \$ sqlplus RDS_DATAGUARD@RDS_CUSTOM_ORCL_D as sysdg -bash-4.2\$ sqlplus RDS_DATAGUARD@RDS_CUSTOM_ORCL_D as sysdg SQL*Plus: Release 19.0.0.0.0 - Production on Fri Sep 30 23:00:14 2022 Version 19.10.0.0.0 Copyright (c) 1982, 2020, Oracle. All rights reserved. Enter password: Last Successful login time: Fri Sep 30 2022 22:48:27 +00:00 Connected to: Oracle Database 19c Enterprise Edition Release 19.0.0.0.0 - Production Version 19.10.0.0.0 SQL&gt; select open_mode from v\$database; OPEN_MODE ----- MOUNTED SQL&gt; alter database open read only; </pre>	<p>DBA</p>

Task	Description	Skills required
	<pre> Database altered. SQL&gt; select open_mode       from v\$database; OPEN_MODE ----- READ ONLY SQL&gt; </pre> <p><b>CDB</b></p> <pre> -bash-4.2\$ sqlplus C##RDS_DATAGUARD@R DS_CUSTOM_RDSCDB_B as sysdg SQL*Plus: Release 19.0.0.0.0 - Productio n on Wed Jan 11 21:14:07 2023 Version 19.16.0.0.0 Copyright (c) 1982, 2022, Oracle. All rights reserved. Enter password: Last Successful login time: Wed Jan 11 2023 21:12:05 +00:00 Connected to: Oracle Database 19c Enterprise Edition Release 19.0.0.0.0 - Production Version 19.16.0.0.0 SQL&gt; select name,open _mode from v\$database; NAME    OPEN_MODE ----- RDSCDB  MOUNTED SQL&gt; alter database open read only; Database altered. </pre>	

Task	Description	Skills required
	<pre>SQL&gt; select name,open _mode from v\$database; NAME    OPEN_MODE ----- RDSCDB  READ ONLY SQL&gt;</pre>	

Task	Description	Skills required
Activate redo apply on the read replica instance.	<p>Activate redo apply on the read replica instance by using DGMGRL from the primary or standby node.</p> <p><b>Non-CDB</b></p> <pre data-bbox="594 520 1029 1768">\$ dgmgrl RDS_DATAG UARD@RDS_CUSTOM_OR CL_D DGMGRL for Linux:   Release 19.0.0.0.0 -   Production on Fri Sep   30 23:02:16 2022 Version 19.10.0.0.0 Copyright (c) 1982,   2019, Oracle and/or its   affiliates. All rights   reserved. Welcome to DGMGRL, type   "help" for informati   on. Password: Connected to "ORCL_D" Connected as SYSDBA. DGMGRL&gt; edit database orcl_d set   state=apply-on; DGMGRL&gt; edit database   orcl_d set state=app   ly-on; Succeeded. DGMGRL&gt; show database   orcl_d Database - orcl_d Role: PHYSICAL STANDBY Intended State: APPLY- ON</pre>	DBA



Task	Description	Skills required
	<pre> Transport Lag: 0 seconds (computed 0 seconds ago) Apply Lag: 0 seconds (computed 0 seconds ago) Average Apply Rate: 496.00 KByte/s Real Time Query: ON Instance(s): ORCL Database Status: SUCCESS DGMGRL&gt; </pre> <p><b>CDB</b></p> <pre> -bash-4.2\$ dgmgrl C##RDS_DATAGUARD@R DS_CUSTOM_RDSCDB_B -bash-4.2\$ dgmgrl C##RDS_DATAGUARD@R DS_CUSTOM_RDSCDB_B DGMGRL for Linux: Release 19.0.0.0.0 - Production on Wed Jan 11 21:21:11 2023 Version 19.16.0.0.0 Copyright (c) 1982, 2019, Oracle and/or its affiliates. All rights reserved. Welcome to DGMGRL, type "help" for informati on. Password: Connected to "RDSCDB_B " Connected as SYSDBG. </pre>	

Task	Description	Skills required
	<pre> DGMGRL&gt; edit database   rdscdb_b set state=app ly-on; Succeeded. DGMGRL&gt; show database   rdscdb_b Database - rdscdb_b   Role: PHYSICAL STANDBY   Intended State: APPLY-ON   Transport Lag: 0 seconds (computed 0 seconds ago)   Apply Lag: 0 seconds (computed 0 seconds ago)   Average Apply Rate: 35.00 KByte/s   Real Time Query:    ON   Instance(s):   RDSCDB Database Status: SUCCESS DGMGRL&gt; show database   rdscdb_b Database - rdscdb_b   Role: PHYSICAL STANDBY   Intended State: APPLY-ON   Transport Lag: 0 seconds (computed 1 second ago)   Apply Lag: 0 seconds (computed 1 second ago)   Average Apply Rate: 16.00 KByte/s   Real Time Query:    ON   Instance(s):   RDSCDB </pre>	

Task	Description	Skills required
	<pre>Database Status: SUCCESS DGMGRL&gt;</pre>	

## Related resources

- [Configuring Amazon RDS as an Oracle PeopleSoft Database](#) (AWS whitepaper)
- [Oracle Data Guard Broker guide](#) (Oracle reference documentation)
- [Data Guard Concepts and Administration](#) (Oracle reference documentation)

## Additional information

### Select your database protection mode

Oracle Data Guard provides three protection modes to configure your Data Guard environment based on your availability, protection, and performance requirements. The following table summarizes these three modes.

Protection mode	Redo transport setting	Description
<b>MAXIMUM PERFORMANCE</b>	ASYNC	<p>For transactions happening on the primary database, redo data is asynchronously transmitted and written to the standby database redo log. Therefore, the performance impact is minimal.</p> <p>MaxPerformance can't provide RPO=0 because of asynchronous log shipping.</p>
<b>MAXIMUM PROTECTION</b>	SYNC+AFFIRM	<p>For transactions on the primary database, redo data is synchronously transmitted</p>

and written to the standby database redo log on disk before the transaction is acknowledged. If the standby database becomes unavailable, the primary database shuts itself down to ensure transactions are protected.

**MAXIMUM AVAILABILITY**

SYNC+AFFIRM

This is similar to MaxProtection mode, except when no acknowledgement is received from the standby database. In that case, it operates as if it were in MaxPerformance mode to preserve the primary database availability until it's able to write its redo stream to a synchronized standby database again.

## SYNC+NOAFFIRM

For transactions on the primary database, redo is synchronously transmitted to the standby database, and the primary waits only for acknowledgement that the redo has been received on the standby, not that it has been written to the standby disk. This mode, which is also known as FastSync, can provide a performance benefit at the expense of potential exposure to data loss in a special case of multiple simultaneous failures.

Read replicas in RDS Custom for Oracle are created with maximum performance protection mode, which is also the default protection mode for Oracle Data Guard. The maximum performance mode provides the lowest performance impact on the primary database, which can help you meet the recovery point objective (RPO) requirement measured in seconds.

To work to achieve a zero data loss (RPO=0) objective, you can customize the Oracle Data Guard protection mode to `MaxAvailability` with the `SYNC+NOAFFIRM` setting for redo transport for better performance. Because commits on the primary database are acknowledged only after the corresponding redo vectors are successfully transmitted to the standby database, the network latency between the primary instance and replica can be crucial for commit-sensitive workloads. We recommend performing load testing for your workload to assess the performance impact when the read replica is customized to run in `MaxAvailability` mode.

Deploying the read replica in the same Availability Zone as the primary database provides lower network latency compared with deploying the read replica in a different Availability Zone. However, deploying the primary and read replicas in the same Availability Zone might not meet your HA requirements because, in the unlikely event of Availability Zone unavailability, both the primary instance and read replica instance are impacted.

# Assess query performance for migrating SQL Server databases to MongoDB Atlas on AWS

Created by Battulga Purevragchaa (AWS), Krishnakumar Sathyanarayana (PeerIslands US Inc), and Babu Srinivasan (MongoDB)

<b>Environment:</b> PoC or pilot	<b>Source:</b> Microsoft SQL Server	<b>Target:</b> MongoDB Atlas or MongoDB Enterprise Advanced
<b>R Type:</b> Replatform	<b>Workload:</b> Microsoft	<b>Technologies:</b> Databases; Migration

## Summary

This pattern provides guidance for loading MongoDB with near real-world data and assessing MongoDB query performance that is as close to the production scenario as possible. The assessment provides input to help you plan your migration to MongoDB from a relational database. The pattern uses [PeerIslands Test Data Generator and Performance Analyzer](#) to test query performance.

This pattern is particularly useful for Microsoft SQL Server migration to MongoDB, because performing schema transformations and loading data from current SQL Server instances to MongoDB can be very complex. Instead, you can load near real-world data into MongoDB, understand MongoDB performance, and fine-tune the schema design before you start the actual migration.

## Prerequisites and limitations

### Prerequisites

- An active AWS account
- Familiarity with [MongoDB Atlas](#)
- Target MongoDB schema
- Typical query patterns

## Limitations

- Data load times and performance will be limited by the MongoDB cluster instance size. We recommend that you choose instances that are recommended for production use to understand real-world performance.
- PeerIslands Test Data Generator and Performance Analyzer currently supports only online data loads and queries. Offline batch processing (for example, loading data into MongoDB by using Spark connectors) isn't yet supported.
- PeerIslands Test Data Generator and Performance Analyzer supports field relations within a collection. It doesn't support relationships across collections.

## Product editions

- This pattern supports both [MongoDB Atlas](#) and [MongoDB Enterprise Advanced](#).

## Architecture

### Target technology stack

- MongoDB Atlas or MongoDB Enterprise Advanced

### Architecture

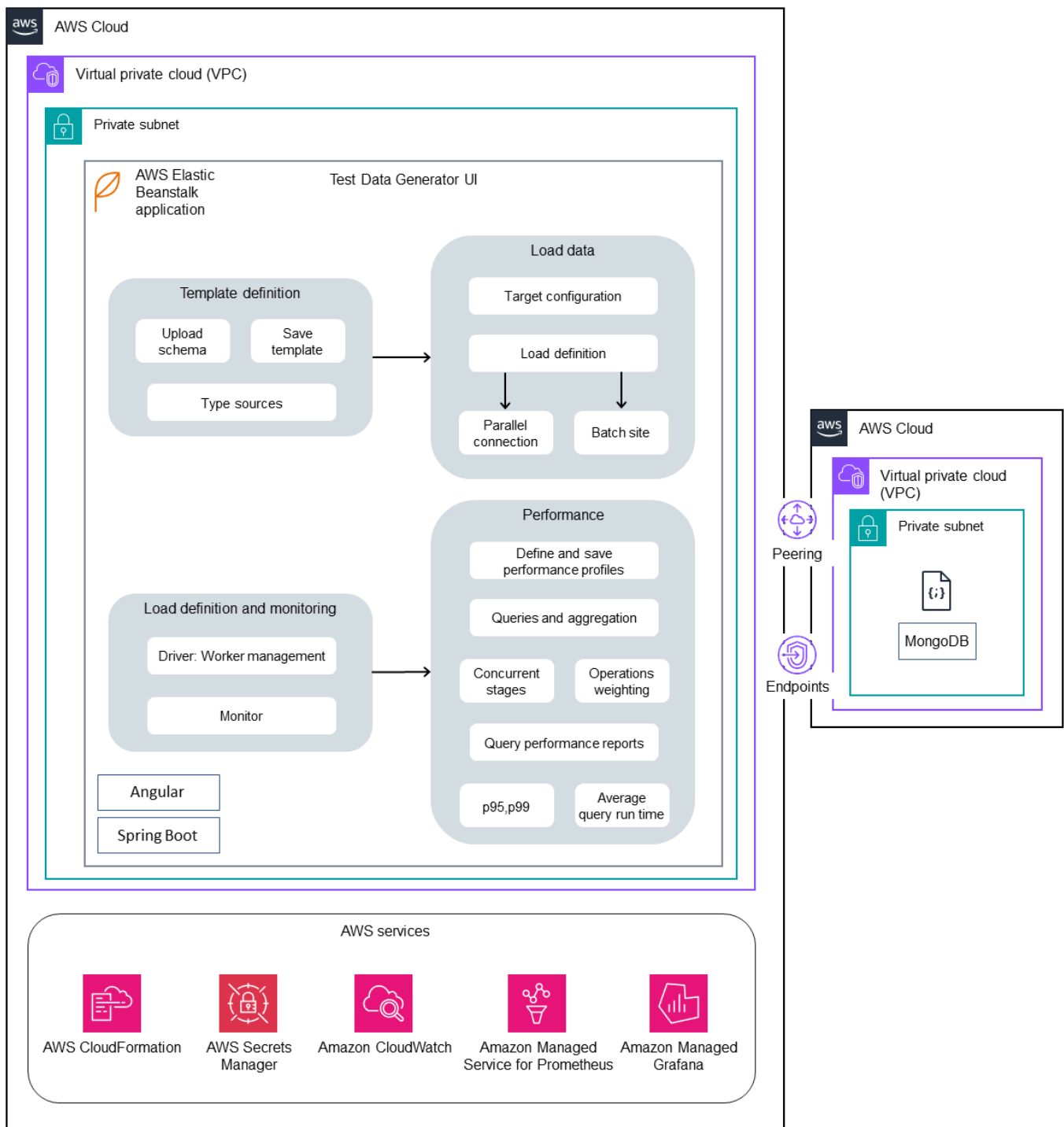

PeerIslands Test Data Generator and Performance Analyzer is built by using Java and Angular, and stores its generated data on Amazon Elastic Block Store (Amazon EBS). The tool consists of two workflows: test data generation and performance testing.



- In test data generation, you create a template, which is the JSON representation of the data model that has to be generated. After you create the template, you can generate the data in a target collection, as defined by the load generation configuration.
- In performance testing, you create a profile. A profile is a multi-stage testing scenario where you can configure create, read, update, and delete (CRUD) operations, aggregation pipelines, the weightage for each operation, and the duration of each stage. After you create the profile, you can run performance testing on the target database based on the configuration.

PeerIslands Test Data Generator and Performance Analyzer stores its data on Amazon EBS, so you can connect Amazon EBS to MongoDB by using any MongoDB-supported connection mechanism, including peering, allow lists, and private endpoints. By default, the tool doesn't include operational components; however, it can be configured with Amazon Managed Service for Prometheus, Amazon Managed Grafana, Amazon CloudWatch, and AWS Secrets Manager if required.

## Tools

- [PeerIslands Test Data Generator and Performance Analyzer](#) includes two components. The Test Data Generator component helps you generate highly customer-specific, real-world data based on your MongoDB schema. The tool is fully UI-driven with a rich data library and can be used to quickly generate billions of records on MongoDB. The tool also provides capabilities to implement relationships between fields in the MongoDB schema. The Performance Analyzer component helps you generate highly customer-specific queries and aggregations, and perform realistic performance testing on MongoDB. You can use the Performance Analyzer to test MongoDB performance with rich load profiles and parameterized queries for your specific use case.

## Best practices

See the following resources:

- [MongoDB Schema Design Best Practices](#) (MongoDB Developer website)
- [Best Practices of Deploying MongoDB Atlas on AWS](#) (MongoDB website)
- [Connecting Applications Securely to a MongoDB Atlas Data Plane with AWS PrivateLink](#) (AWS blog post)
- [Best Practices Guide for MongoDB Performance](#) (MongoDB website)

# Epics

## Understand your source data

Task	Description	Skills required
Understand the database footprint of the current SQL Server source.	Understand your current SQL Server footprint. This can be achieved by running queries against the INFORMATION schema of the database. Determine the number of tables and size of each table. Analyze the index associated with each table. For more information about SQL analysis, see the blog post <a href="#">SQL2Mongo: Data Migration Journey</a> on the PeerIslands website.	DBA
Understand the source schema.	Determine the table schema and the business representation of the data (for example, zip codes, names, and currency). Use your existing entity relationship (ER) diagram or generate the ER diagram from the existing database. For more information, see the blog post <a href="#">SQL2Mongo: Data Migration Journey</a> on the PeerIslands website.	DBA
Understand query patterns.	Document the top 10 SQL queries you use. You can use	DBA

Task	Description	Skills required
	<p>the <code>performance_schema</code> <code>.events_statements_summary_by_digest</code> tables that are available in the database to understand the top queries. For more information, see the blog post <a href="#">SQL2Mongo: Data Migration Journey</a> on the PeerIslands website.</p>	
Understand SLA commitments.	<p>Document the target service-level agreements (SLAs) for database operations. Typical measures include query latency and queries per second. The measures and their targets are typically available in non-functional requirements (NFR) documents.</p>	DBA

## Define the MongoDB schema

Task	Description	Skills required
Define the target schema.	<p>Define various options for the target MongoDB schema. For more information, see <a href="#">Schemas</a> in the MongoDB Atlas documentation. Consider the best practices and design patterns based on the table relations. See <a href="#">Data Model Examples and Patterns</a></p>	MongoDB engineer

Task	Description	Skills required
	in the MongoDB documentation for details.	
Define target query patterns.	Define MongoDB queries and aggregation pipelines. These queries are the equivalent of the top queries you captured for your SQL Server workload. To understand how to construct MongoDB aggregation pipelines, see the <a href="#">MongoDB documentation</a> .	MongoDB engineer
Define the MongoDB instance type.	Determine the size of the instance that you plan to use for testing. For guidance, see the <a href="#">MongoDB documentation</a> .	MongoDB engineer

## Prepare the target database

Task	Description	Skills required
Set up the MongoDB Atlas cluster.	To set up a MongoDB cluster on AWS, follow the instructions in the <a href="#">MongoDB documentation</a> .	MongoDB engineer
Create users in the target database.	Configure the MongoDB Atlas cluster for access and network security by following the instructions in the <a href="#">MongoDB documentation</a> .	MongoDB engineer

Task	Description	Skills required
Create appropriate roles in AWS and configure role-based access control for Atlas.	If required, set up additional users by following the instructions in the <a href="#">MongoDB documentation</a> . Configure <a href="#">authentication and authorization</a> through AWS roles.	MongoDB engineer
Set up Compass for MongoDB Atlas access.	Set up the <a href="#">MongoDB Compass GUI utility</a> for ease of navigation and access.	MongoDB engineer

### Set up the base load by using Test Data Generator

Task	Description	Skills required
Install Test Data Generator.	Install <a href="#">PeerIsland Test Data Generator</a> in your environment.	MongoDB engineer
Configure Test Data Generator to generate the appropriate data.	Create a template by using the data library to generate specific data for each field in the MongoDB schema. For more information, see the <a href="#">MongoDB Data Generator &amp; Perf. Analyzer</a> video.	MongoDB engineer
Horizontally scale Test Data Generator to generate the required load.	Use the template you created to start the load generation against the target collection by configuring the required parallelism. Determine the time frames and scale to generate the necessary data.	MongoDB engineer

Task	Description	Skills required
Validate the load in MongoDB Atlas.	Check the data loaded into MongoDB Atlas.	MongoDB engineer
Generate required indexes on MongoDB.	Define indexes as required, based on query patterns. For best practices, see the <a href="#">MongoDB documentation</a> .	MongoDB engineer

## Conduct performance testing

Task	Description	Skills required
Set up load profiles in Performance Analyzer.	Create a performance testing profile in Performance Analyzer by configuring specific queries and their corresponding weightage, duration of the test run, and stages. For more information, see the <a href="#">MongoDB Data Generator &amp; Perf. Analyzer</a> video.	MongoDB engineer
Run performance testing.	Use the performance testing profile you created to start the test against the target collection by configuring the required parallelism. Horizontally scale the performance test tool to run queries against MongoDB Atlas.	MongoDB engineer

Task	Description	Skills required
Record test results.	Record P95, P99 latency for the queries.	MongoDB engineer
Tune your schema and query patterns.	Modify indexes and query patterns to address any performance issues.	MongoDB engineer

## Close the project

Task	Description	Skills required
Shut down temporary AWS resources.	Delete all temporary resources that you used for Test Data Generator and Performance Analyzer.	AWS administrator
Update performance test results.	Understand MongoDB query performance and compare it against your SLAs. If necessary, fine-tune the MongoDB schema and rerun the process.	MongoDB engineer
Conclude the project.	Close out the project and provide feedback.	MongoDB engineer

## Related resources

- GitHub repository: [S3toAtlas](#)
- Schema: [MongoDB Schema design](#)
- Aggregation pipelines : [MongoDB aggregation pipelines](#)
- MongoDB Atlas sizing : [Sizing tier selection](#)
- Video: [MongoDB Data Generator](#) & Perf. Analyzer

- References: [MongoDB documentation](#)
- Tutorials: [MongoDB developer guide](#), [MongoDB Jumpstart](#)
- AWS Marketplace: [MongoDB Atlas on AWS Marketplace](#)
- AWS Partner Solutions: [MongoDB Atlas on AWS Reference Deployment](#)

Additional resources:

- [SQL analysis](#)
- [MongoDB Developer Community forums](#)
- [MongoDB Performance Tuning Questions](#)
- [Operational Analytics with Atlas and Redshift](#)
- [Application modernization with MongoDB Atlas and AWS Elastic Beanstalk](#)



# Automate cross-Region failover and failback by using DR Orchestrator Framework

Created by Jitendra Kumar (AWS), Oliver Francis (AWS), and Pavithra Balasubramanian (AWS)

**Code repository:** [aws-cross-region-dr-databases](#)

**Environment:** Production

**Technologies:** Databases ; Infrastructure; Migration; Modernization

**AWS services:** Amazon Aurora; AWS CloudFormation; Amazon ElastiCache; Amazon RDS; AWS Step Functions

## Summary

This pattern describes how to use [DR Orchestrator Framework](#) to orchestrate and automate the manual, error-prone steps to perform disaster recovery across Amazon Web Services (AWS) Regions. The pattern covers the following databases:

- Amazon Relational Database Service (Amazon RDS) for MySQL, Amazon RDS for PostgreSQL, or Amazon RDS for MariaDB
- Amazon Aurora MySQL-Compatible Edition or Amazon Aurora PostgreSQL-Compatible Edition (using a centralized file)
- Amazon ElastiCache (Redis OSS)

To demonstrate the functionality of DR Orchestrator Framework, you create two DB instances or clusters. The primary is in the AWS Region us-east-1, and the secondary is in us-west-2. To create these resources, you use the AWS CloudFormation templates in the App-Stack folder of the [aws-cross-region-dr-databases](#) GitHub repository.

## Prerequisites and limitations

### General prerequisites

- DR Orchestrator Framework deployed in both primary and secondary AWS Regions

- Two [Amazon Simple Storage Service](#) buckets
- A [virtual private cloud \(VPC\)](#) with two subnets and an AWS security group

### Engine-specific prerequisites

- **Amazon Aurora** – At least one Aurora global database must be available in two AWS Regions. You can use us-east-1 as the primary Region, and use us-west-2 as the secondary Region.
- **Amazon ElastiCache (Redis OSS)** – An ElastiCache global datastore must be available in two AWS Regions. You can use us-east-1 as the primary Region, and use us-west-2 as the secondary Region.

### Amazon RDS limitations

- DR Orchestrator Framework doesn't check the replication lag before doing a failover or failback. Replication lag must be checked manually.
- This solution has been tested using a primary database instance with one read replica. If you want to use more than one read replica, test the solution thoroughly before implementing it in a production environment.

### Aurora limitations

- Feature availability and support vary across specific versions of each database engine and across AWS Regions. For more information on feature and Region availability for cross-Region replication, see [Cross-Region read replicas](#).
- Aurora global databases have specific configuration requirements for supported Aurora DB instance classes and the maximum number of AWS Regions. For more information, see [Configuration requirements of an Amazon Aurora global database](#).
- This solution has been tested using a primary database instance with one read replica. If you want to use more than one read replica, test the solution thoroughly before implementing it in a production environment.

### ElastiCache limitations

- For information about Region availability for Global Datastore and ElastiCache configuration requirements, see [Prerequisites and limitations](#) in the ElastiCache documentation.

## Amazon RDS product versions

Amazon RDS supports the following engine versions:

- **MySQL** – Amazon RDS supports DB instances running the following versions of [MySQL](#): MySQL 8.0 and MySQL 5.7
- **PostgreSQL** – For information about supported versions of Amazon RDS for PostgreSQL, see [Available PostgreSQL database versions](#).
- **MariaDB** – Amazon RDS supports DB instances running the following versions of [MariaDB](#):
  - MariaDB 10.11
  - MariaDB 10.6
  - MariaDB 10.5

## Aurora product versions

- Amazon Aurora global database switchover requires Aurora MySQL-Compatible with MySQL 5.7 compatibility, version 2.09.1 and higher

For more information, see [Limitations of Amazon Aurora global databases](#).

## ElastiCache (Redis OSS) product versions

Amazon ElastiCache (Redis OSS) supports the following Redis versions:

- Redis 7.1 (enhanced)
- Redis 7.0 (enhanced)
- Redis 6.2 (enhanced)
- Redis 6.0 (enhanced)
- Redis 5.0.6 (enhanced)

For more information, see [Supported ElastiCache \(Redis OSS\) versions](#).

## Architecture

### Amazon RDS architecture

The Amazon RDS architecture includes the following resources:

- The primary Amazon RDS DB instance created in the primary Region (us-east-1) with read/write access for clients
- An Amazon RDS read replica created in the secondary Region (us-west-2) with read-only access for clients
- DR Orchestrator Framework deployed in both the primary and secondary Regions

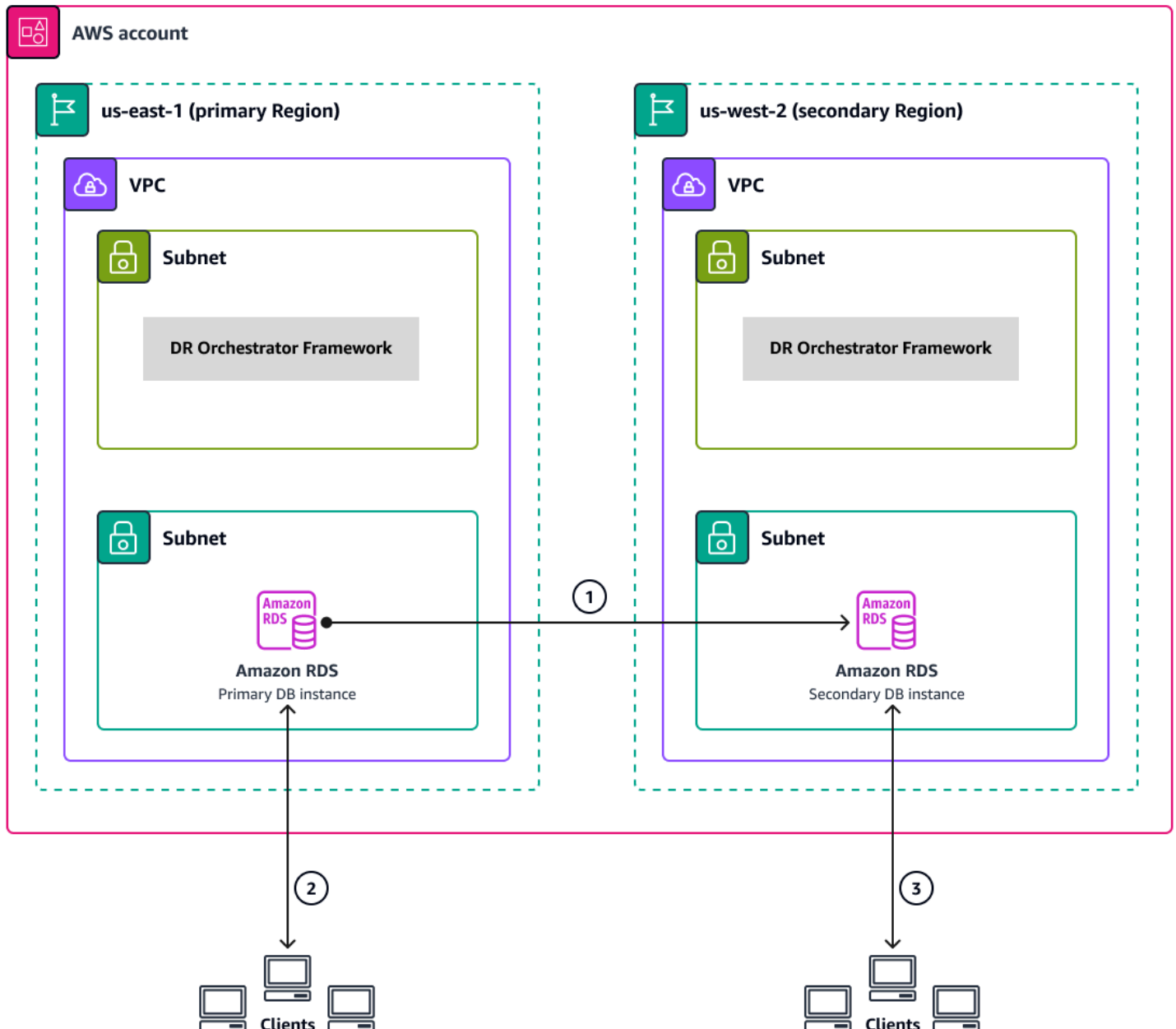

The diagram shows the following:

1. Asynchronous replication between the primary instance and the secondary instance
2. Read/write access for clients in the primary Region
3. Read-only access for clients in the secondary Region

## **Aurora architecture**

The Amazon Aurora architecture includes the following resources:

- The primary Aurora DB cluster created in the primary Region (us-east-1) with an active-writer endpoint
- An Aurora DB cluster created in the secondary Region (us-west-2) with an inactive-writer endpoint
- DR Orchestrator Framework deployed in both the primary and secondary Regions

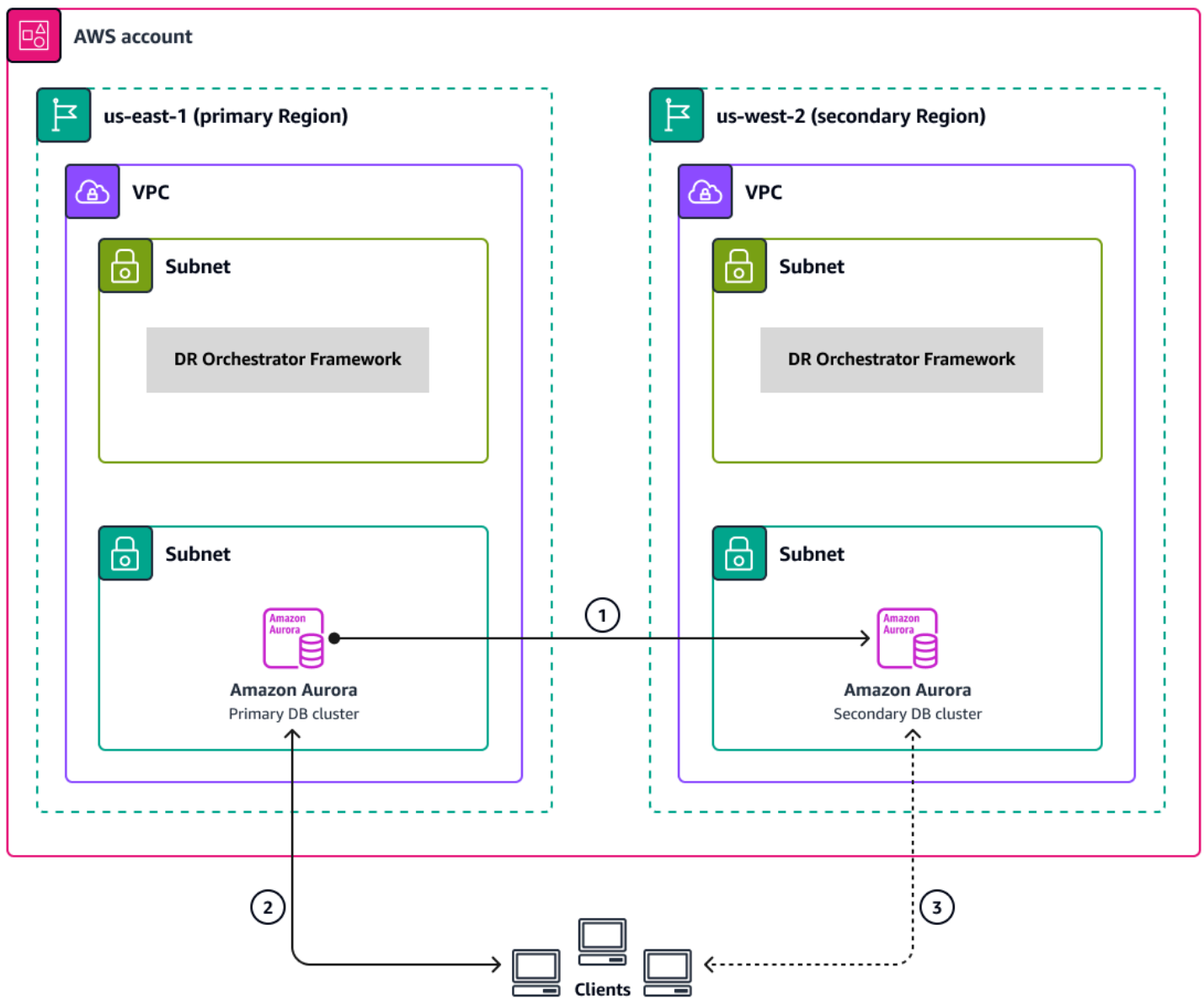

The diagram shows the following:

1. Asynchronous replication between the primary cluster and the secondary cluster
2. The primary DB cluster with an active-writer endpoint
3. The secondary DB cluster with an inactive-writer endpoint

### ElastiCache (Redis OSS) architecture

The Amazon ElastiCache (Redis OSS) architecture includes the following resources:

- An ElastiCache (Redis OSS) global datastore created with two clusters:

1. The primary cluster in the primary Region (us-east-1)
  2. The secondary cluster in the secondary Region (us-west-2)
- An Amazon cross-Region link with TLS 1.2 encryption between the two clusters
  - DR Orchestrator Framework deployed in both primary and secondary Regions

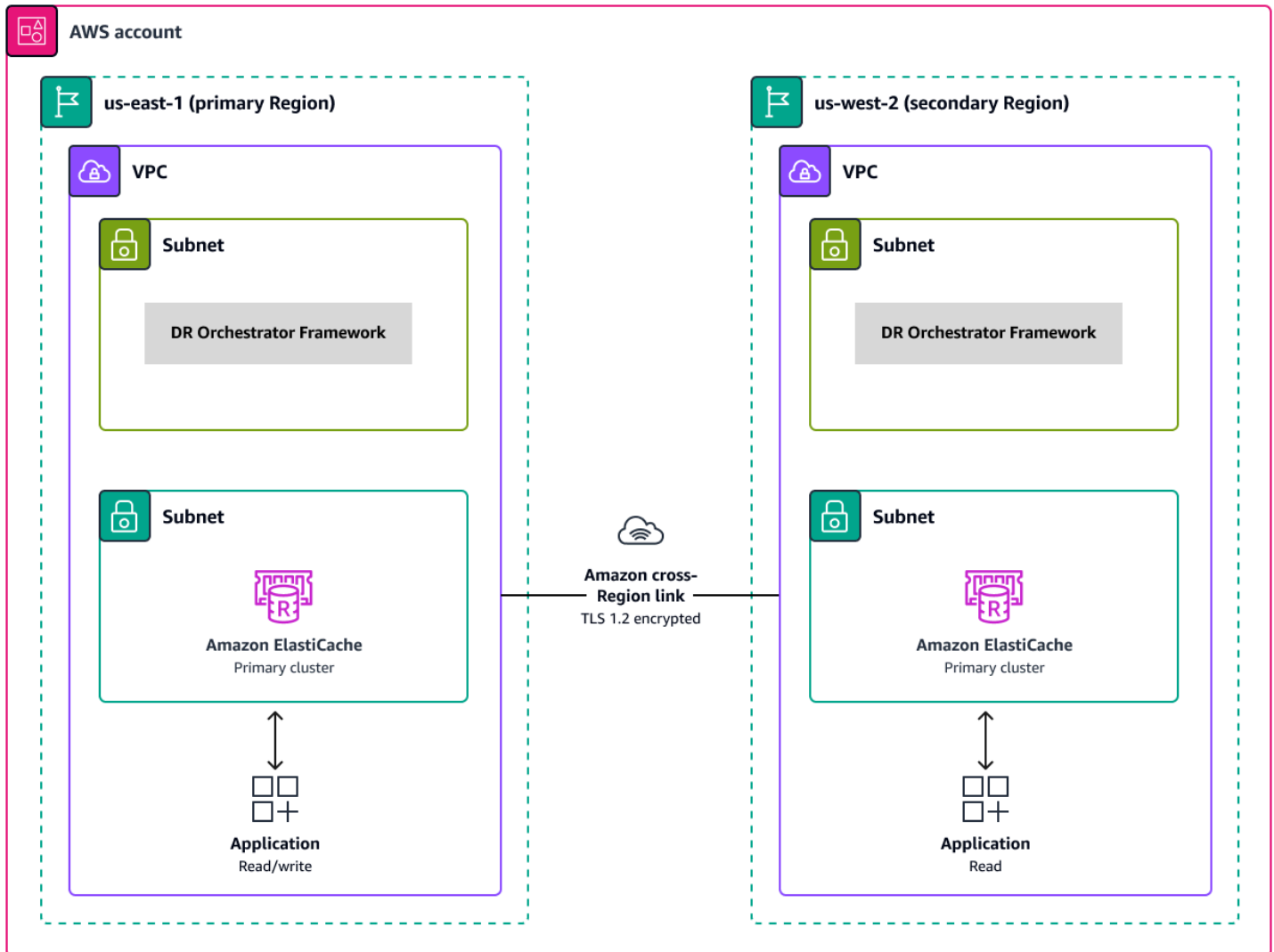

## Automation and scale

DR Orchestrator Framework is scalable and supports the failover or failback of more than one AWS database in parallel.

You can use the following payload code to fail over multiple AWS databases in your account. In this example, three AWS databases (two global databases such as Aurora MySQL-Compatible or Aurora PostgreSQL-Compatible, and one Amazon RDS for MySQL instance) fail over to the DR Region:

```

{
  "StatePayload": [
    {
      "layer": 1,
      "resources": [
        {
          "resourceType": "PlannedFailoverAurora",
          "resourceName": "Switchover (planned failover) of Amazon Aurora global
databases (MySQL)",
          "parameters": {
            "GlobalClusterIdentifier": "!Import dr-globalddb-cluster-mysql-global-
identifier",
            "DBClusterIdentifier": "!Import dr-globalddb-cluster-mysql-cluster-
identifier"
          }
        },
        {
          "resourceType": "PlannedFailoverAurora",
          "resourceName": "Switchover (planned failover) of Amazon Aurora global
databases (PostgreSQL)",
          "parameters": {
            "GlobalClusterIdentifier": "!Import dr-globalddb-cluster-postgres-global-
identifier",
            "DBClusterIdentifier": "!Import dr-globalddb-cluster-postgres-cluster-
identifier"
          }
        },
        {
          "resourceType": "PromoteRDSReadReplica",
          "resourceName": "Promote RDS for MySQL Read Replica",
          "parameters": {
            "RDSInstanceIdentifier": "!Import rds-mysql-instance-identifier",
            "TargetClusterIdentifier": "!Import rds-mysql-instance-global-arn"
          }
        }
      ]
    }
  ]
}

```

## Tools

### AWS services



- [Amazon Aurora](#) is a fully managed relational database engine that's built for the cloud and compatible with MySQL and PostgreSQL.
- [Amazon ElastiCache](#) helps you set up, manage, and scale distributed in-memory cache environments in the AWS Cloud. This pattern uses Amazon ElastiCache (Redis OSS).
- [AWS Lambda](#) is a compute service that helps you run code without needing to provision or manage servers. It runs your code only when needed and scales automatically, so you pay only for the compute time that you use. In this pattern, Lambda functions are used by AWS Step Functions to perform the steps.
- [Amazon Relational Database Service \(Amazon RDS\)](#) helps you set up, operate, and scale a relational database in the AWS Cloud. This pattern supports Amazon RDS for MySQL, Amazon RDS for PostgreSQL, and Amazon RDS for MariaDB.
- [AWS SDK for Python \(Boto3\)](#) helps you integrate your Python application, library, or script with AWS services. In this pattern, Boto3 APIs are used to communicate with the database instances or global databases.
- [AWS Step Functions](#) is a serverless orchestration service that helps you combine AWS Lambda functions and other AWS services to build business-critical applications. In this pattern, Step Functions state machines are used to orchestrate and run the cross-Region failover and failback of the database instances or global databases.

## Code repository

The code for this pattern is available in the [aws-cross-region-dr-databases](#) repository on GitHub.

## Epics

### Install DR Orchestrator Framework

Task	Description	Skills required
Clone the GitHub repository.	To clone the repository, run the following command:  <pre>git clone https://github.com/aws-samples/aws-cross-region-dr-databases.git</pre>	AWS DevOps, AWS administrator

Task	Description	Skills required
Package Lambda functions code in a .zip file archive.	<p>Create the archive files for Lambda functions to include the DR Orchestrator Framework dependencies:</p> <pre>cd &lt;YOUR-LOCAL-GIT-FOLDER&gt;/DR-Orchestration-artifacts  bash scripts/deploy-orchestrator-sh.sh</pre>	AWS administrator
Create S3 buckets.	<p>S3 buckets are needed to store DR Orchestrator Framework along with your latest configuration. Create two S3 buckets, one in the primary Region (us-east-1 ), and one in the secondary Region (us-west-2 ):</p> <ul style="list-style-type: none"><li>• dr-orchestrator-xxxx-us-east-1</li><li>• dr-orchestrator-xxxx-us-west-2</li></ul> <p>Replace xxxxxx with a random value to make the bucket names unique.</p>	AWS administrator

Task	Description	Skills required
Create subnets and security groups.	<p>In both the primary Region (us-east-1 ) and the secondary Region (us-west-2 ), create two subnets and one security group for Lambda function deployment in your VPC:</p> <ul style="list-style-type: none"><li>• subnet-XXXXXXX</li><li>• subnet-YYYYYYY</li><li>• sg-XXXXXXXXXXXXX</li></ul>	AWS administrator

Task	Description	Skills required
Update the DR Orchestrator parameter files.	<p>In the &lt;YOUR-LOCAL-GIT-FOLDER&gt;/DR-Orchestration-artifacts/cloudformation folder, update the following DR Orchestrator parameter files:</p> <ul style="list-style-type: none"><li>• Orchestrator-Deployer-parameters-us-east-1.json</li><li>• Orchestrator-Deployer-parameters-us-west-2.json</li></ul> <p>Use the following parameter values, replacing x and y with the names of your resources:</p> <pre>[   {     "ParameterKey": "TemplateStoreS3BucketName",     "ParameterValue": "dr-orchestrator-xxxxxx-us-east-1"   },   {     "ParameterKey": "TemplateVPCId",     "ParameterValue": "vpc-xxxxxx"   } ]</pre>	AWS administrator

Task	Description	Skills required
	<pre>                 "ParameterKey":                 "TemplateLambdaSub netID1",                 "Paramete rValue": "subnet-x xxxxx"             },             {                 "ParameterKey":                 "TemplateLambdaSub netID2",                 "Paramete rValue": "subnet-y yyyyy"             },             {                 "ParameterKey":                 "TemplateLambdaSec urityGroupID",                 "Paramete rValue": "sg-xxxxx xxxxx"             }         ]             </pre>	

Task	Description	Skills required
Upload the DR Orchestrator Framework code to the S3 bucket.	<p>The code will be safer in an S3 bucket than in the local directory. Upload the DR-Orchestration-artifacts directory , including all files and subfolders, to the S3 buckets.</p> <p>To upload the code, do the following:</p> <ol style="list-style-type: none"><li>1. Sign in to the AWS Management Console.</li><li>2. Navigate to the Amazon S3 console.</li><li>3. Select the dr-orches trator-xxxxxx-us-east-1 bucket .</li><li>4. Choose <b>Upload</b>, and then choose <b>Add folder</b>.</li><li>5. Select the DR-Orches tration-artifacts folder.</li><li>6. Choose <b>Upload</b>.</li><li>7. Select the dr-orches trator-xxxxxx-us-west-2 bucket.</li><li>8. Repeat steps 4–7.</li></ol>	AWS administrator

Task	Description	Skills required
Deploy DR Orchestrator Framework in the primary Region.	<p>To deploy DR Orchestrator Framework in the primary Region (us-east-1 ), run the following commands:</p> <pre>cd &lt;YOUR-LOCAL-GIT-FOLDER&gt;/DR-Orchestration-artifacts/cloudformation  aws cloudformation   deploy \   --region us-east-1 \   --stack-name dr-orchestrator \   --template-file   Orchestrator-Deployer.yaml \   --parameter-overrides   file://Orchestrator-Deployer-parameters-us-east-1.json \   --capabilities   CAPABILITY_AUTO_EXPAND CAPABILITY_NAMED_IAM CAPABILITY_IAM \   --disable-rollback</pre>	AWS administrator

Task	Description	Skills required
Deploy DR Orchestrator Framework in the secondary Region.	<p>In the secondary Region (us-west-2 ), run the following commands:</p> <pre>cd &lt;YOUR-LOCAL-GIT-FOLDER&gt;/DR-Orchestration-artifacts/cloudformation  aws cloudformation   deploy \   --region us-west-2 \   --stack-name dr-orchestrator \   --template-file   Orchestrator-Deployer.yaml \   --parameter-overrides   file://Orchestrator-Deployer-parameters-us-west-2.json \   --capabilities   CAPABILITY_AUTO_EXPAND CAPABILITY_NAMED_IAM CAPABILITY_IAM \   --disable-rollback</pre>	AWS administrator



Task	Description	Skills required
Verify the deployment.	<p>If the AWS CloudFormation command runs successfully, it returns the following output:</p> <pre>Successfully created/ updated stack - dr- orchestrator</pre> <p>Alternatively, you can navigate to the AWS CloudFormation console and verify the status of the <code>dr-orchestrator</code> stack.</p>	AWS administrator

## Create the database instances or clusters

Task	Description	Skills required
Create the database subnets and security groups.	<p>In your VPC, create two subnets and one security group for the DB instance or global database in both the primary (<code>us-east-1</code>) and the secondary (<code>us-west-2</code>) Regions:</p> <ul style="list-style-type: none"> <li><code>subnet-XXXXXX</code></li> <li><code>subnet-XXXXXX</code></li> <li><code>sg-XXXXXXXXXX</code></li> </ul>	AWS administrator
Update the parameter file for the primary DB instance or cluster.	In the <code>&lt;YOUR_LOCAL_GIT_FOLDER&gt;/App-Stack</code> folder, update the parameter file for the primary Region.	AWS administrator

Task	Description	Skills required
	<p><b>Amazon RDS</b></p> <p>In the <code>RDS-MySQL-parameter-us-east-1.json</code> file, update <code>SubnetIds</code> and <code>DBSecurityGroup</code> with the names of resources that you created:</p> <pre data-bbox="597 604 1026 1556"> {   "Parameters": {     "SubnetIds":       "subnet-xxxxxx, subnet-xxxxxx",     "DBSecurityGroup":       "sg-xxxxxxxxx",     "MySQLGlobalIdentifier": "rds-mysql-instance",     "InitialDatabaseName": "mysqldb",     "DBPortNumber":       "3789",     "PrimaryRegion":       "us-east-1",     "SecondaryRegion":       "us-west-2",     "KMSKeyAliasName":       "rds/rds-mysql-instance-KmsKeyId"   } } </pre> <p><b>Amazon Aurora</b></p> <p>In the <code>Aurora-MySQL-parameter-us-east-1.json</code> file, update <code>SubnetIds</code> and <code>DBSecurityGroup</code></p>	

Task	Description	Skills required
	<p>yGroup with the names of resources that you created:</p> <pre data-bbox="594 331 1027 1562"> {   "Parameters": {     "SubnetIds":       "subnet1-xxxxxx,su       bnet2-xxxxxx",     "DBSecurityGroup":       "sg-xxxxxxxxxx",     "GlobalClusterIden       tifier":"dr-globaldb-       cluster-mysql",     "DBClusterName":"d       bcluster-01",     "SourceDBClusterNa       me":"dbcluster-02",     "DBPortNumber":       "3787",     "DBInstanceClass":       "db.r5.large",     "InitialDatabaseNa       me": "sampledb",     "PrimaryRegion":       "us-east-1",     "SecondaryRegion":       "us-west-2",     "KMSKeyAliasName":       "rds/dr-globaldb-c       luster-mysql-KmsKe       yId"   } } </pre> <p><b>Amazon ElastiCache (Redis OSS)</b></p> <p>In the ElastiCache-parameter-us-east-1.json file, update</p>	

Task	Description	Skills required
	<p>SubnetIds and DBSecurityGroup with the names of resources that you created.</p> <pre data-bbox="597 380 1024 1766">{   "Parameters": {     "CacheNodeType":     "cache.m5.large",     "DBSecurityGroup":     "sg-xxxxxxxx",     "SubnetIds":     "subnet-xxxxxx, subnet-xxxxxx",     "EngineVersion":     "5.0.6",     "GlobalReplicationGroupIdSuffix": "demo-redis-global-datastore",     "NumReplicas": "1",     "NumShards": "1",     "ReplicationGroupId": "demo-redis-cluster",     "DBPortNumber":     "3788",     "TransitEncryption": "true",     "KMSKeyAliasName":     "elasticache/demo-redis-global-datastore-kmskeyid",     "PrimaryRegion":     "us-east-1",     "SecondaryRegion":     "us-west-2"   } }</pre>	

Task	Description	Skills required
Deploy your DB instance or cluster in the primary Region.	<p>To deploy your instance or cluster in the primary Region (us-east-1 ), run the following commands based on your database engine.</p> <p><b>Amazon RDS</b></p> <pre>cd &lt;YOUR-LOCAL-GIT-FOLDER&gt;/App-Stack  aws cloudformation   deploy \   --region us-east-1 \   --stack-name rds-mysql   -app-stack \   --template-file RDS-MySQL-Primary.yaml \   --parameter-overrides     file://RDS-MySQL-parameter-us-east-1.json \   --capabilities     CAPABILITY_AUTO_EXPAND CAPABILITY_NAMED_IAM CAPABILITY_IAM \   --disable-rollback</pre> <p><b>Amazon Aurora</b></p> <pre>cd &lt;YOUR-LOCAL-GIT-FOLDER&gt;/App-Stack  aws cloudformation   deploy \   --region us-east-1 \   --stack-name aurora-mysql-app-stack \</pre>	AWS administrator

Task	Description	Skills required
	<pre> --template-file Aurora-MySQL-Primary.yaml \ --parameter-overrides   file://Aurora-MySQL-parameter-us-east-1.json \ --capabilities   CAPABILITY_AUTO_EX   PAND_CAPABILIT   Y_NAMED_IAM CAPABILIT   Y_IAM \ --disable-rollback </pre> <p><b>Amazon ElastiCache (Redis OSS)</b></p> <pre> cd &lt;YOUR-LOCAL-GIT-FOLDER&gt;/App-Stack  aws cloudformation   deploy \ --region us-east-1 -- stack-name elasticache-ds-app-stack \ --template-file   ElastiCache-Primary.yaml \ --parameter-overrides   file://ElastiCache-parameter-us-east-1.json \ --capabilities   CAPABILITY_AUTO_EX   PAND_CAPABILIT   Y_NAMED_IAM CAPABILIT   Y_IAM \ --disable-rollback </pre>	

Task	Description	Skills required
	Verify that the AWS CloudFormation resources deployed successfully.	

Task	Description	Skills required
Update the parameter file for the secondary DB instance or cluster.	<p>In the &lt;YOUR LOCAL GIT FOLDER&gt;/App-Stack folder, update the parameter file for the secondary Region.</p> <p><b>Amazon RDS</b></p> <p>In the RDS-MySQL-parameter-us-west-2.json file, update SubnetIDs and DBSecurityGroup with the names of resources that you created. Update the PrimaryRegionKMSKeyArn with the value of MySQLKmsKeyId taken from the <b>Outputs</b> section of the AWS CloudFormation stack for the primary DB instance:</p> <pre data-bbox="594 1182 1027 1829">{   "Parameters": {     "SubnetIds":       "subnet-aaaaaaaa,       subnet-bbbbbbbb",     "DBSecurityGroup":       "sg-cccccccc",     "MySQLGlobalIdentifier": "rds-mysql-instance",     "InitialDatabaseName": "mysqldb",     "DBPortNumber":       "3789",     "PrimaryRegion":       "us-east-1",</pre>	AWS administrator



Task	Description	Skills required
	<pre> "SecondaryRegion":   "us-west-2",   "KMSKeyAliasName":     "rds/rds-mysql-ins tance-KmsKeyId",   "PrimaryRegionKMSK eyArn": "arn:aws:km s:us-east-1:xxxxxx xxx:key/mrk-xxxxxx xxxxxxxxxxxxxxxx"   } } </pre> <p><b>Amazon Aurora</b></p> <p>In the <code>Aurora-MySQL-parameter-us-west-2.json</code> file, update <code>SubnetIDs</code> and <code>DBSecurityGroup</code> with the names of resources you created. Update the <code>PrimaryRegionKMSKeyArn</code> with the value of <code>AuroraKmsKeyId</code> taken from the <b>Outputs</b> section of the AWS CloudFormation stack for the primary DB instance:</p> <pre> {   "Parameters": {     "SubnetIds":       "subnet1-aaaaaaaa ,subnet2-bbbbbbbbb",     "DBSecurityGroup":       "sg-cccccccc",     "GlobalClusterIden tifier": "dr-globaldb- cluster-mysql", </pre>	

Task	Description	Skills required
	<pre data-bbox="609 212 1015 1018"> "DBClusterName": "dbcluster-01", "SourceDBClusterName": "dbcluster-02", "DBPortNumber": "3787", "DBInstanceClass": "db.r5.large", "InitialDatabaseName": "sampledb", "PrimaryRegion": "us-east-1", "SecondaryRegion": "us-west-2", "KMSKeyAliasName": "rds/dr-globaldb-cluster-mysql-KmsKeyId" } } </pre> <p data-bbox="592 1060 998 1144"><b>Amazon ElastiCache (Redis OSS)</b></p> <p data-bbox="592 1186 1031 1795">In the <code>ElastiCache-parameter-us-west-2.json</code> file, update <code>SubnetIDs</code> and <code>DBSecurityGroup</code> with the names of resources that you created. Update the <code>PrimaryRegionKMSKeyArn</code> with the value of <code>ElastiCacheKmsKeyId</code> taken from the <b>Outputs</b> section of the AWS CloudFormation stack for the primary DB instance:</p>	

Task	Description	Skills required
	<pre>{   "Parameters": {     "CacheNodeType":       "cache.m5.large",     "DBSecurityGroup":       "sg-ccccccccc",     "SubnetIds":       "subnet-aaaaaaaa,       subnet-bbbbbbbbbb",     "EngineVersion":       "5.0.6",     "GlobalReplication       GroupIdSuffix": "demo-       redis-global-datastor       e",     "NumReplicas": "1",     "NumShards": "1",     "ReplicationGroupI       d": "demo-redis-cluste       r",     "DBPortNumber":       "3788",     "TransitEncryption       ": "true",     "KMSKeyAliasName":       "elasticache/demo-       redis-global-datas       tore-KmsKeyId",     "PrimaryRegion":       "us-east-1",     "SecondaryRegion":       "us-west-2"   } }</pre>	

Task	Description	Skills required
Deploy your DB instance or cluster in the secondary Region.	<p>Run the following commands, based on your database engine.</p> <p><b>Amazon RDS</b></p> <pre>cd &lt;YOUR-LOCAL-GIT-FOLDER&gt;/App-Stack  aws cloudformation   deploy \   --region us-west-2 \   --stack-name rds-mysql   -app-stack \   --template-file RDS-MySQL-DR.yaml \   --parameter-overrides     file://RDS-MySQL-parameter-us-west-2.json \   --capabilities     CAPABILITY_AUTO_EXPAND     CAPABILITY_IAM   --disable-rollback</pre> <p><b>Amazon Aurora</b></p> <pre>cd &lt;YOUR-LOCAL-GIT-FOLDER&gt;/App-Stack  aws cloudformation   deploy \   --region us-west-2 \   --stack-name aurora-mysql-app-stack \   --template-file Aurora-MySQL-DR.yaml \</pre>	AWS administrator

Task	Description	Skills required
	<pre> --parameter-overrides   file://Aurora-MySQL-parameter-us-west-2.json \ --capabilities   CAPABILITY_AUTO_EX PAND CAPABILIT Y_NAMED_IAM CAPABILIT Y_IAM \ --disable-rollback </pre> <p><b>Amazon ElastiCache (Redis OSS)</b></p> <pre> cd &lt;YOUR-LOCAL-GIT-FOLDER&gt;/App-Stack  aws cloudformation   deploy \ --region us-west-2 \ --stack-name elasticache-ds-app-stack \ --template-file   ElastiCache-DR.yaml \ --parameter-overrides   file://ElastiCache-parameter-us-west-2.json \ --capabilities   CAPABILITY_AUTO_EX PAND CAPABILIT Y_NAMED_IAM CAPABILIT Y_IAM \ --disable-rollback </pre> <p>Verify that the AWS CloudFormation resources deployed successfully.</p>	

## Related resources

- [Disaster recovery strategy for databases on AWS](#) (AWS Prescriptive Guidance strategy)
- [Automate your DR solution for relational databases on AWS](#) (AWS Prescriptive Guidance guide)
- [Using Amazon Aurora global databases](#)
- [Replication across AWS Regions using global datastores](#)
- [Automate your DR solution for relational databases on AWS](#) (AWS Prescriptive Guidance guide)

# Automate the replication of Amazon RDS instances across AWS accounts

Created by Parag Nagwekar (AWS) and Arun Chandapillai (AWS)

**Environment:** Production

**Technologies:** Databases; DevOps; Serverless; Infrastructure

**Workload:** All other workloads

**AWS services:** AWS Lambda; Amazon RDS; AWS SDK for Python (Boto3); AWS Step Functions; Amazon SNS

## Summary

This pattern shows you how to automate the process of replicating, tracking, and rolling back your Amazon Relational Database Service (Amazon RDS) DB instances across different AWS accounts by using AWS Step Functions and AWS Lambda. You can use this automation to perform large-scale replication of RDS DB instances without any performance impact or operational overhead—regardless of the size of your organization. You can also use this pattern to help your organization comply with mandatory data governance strategies or compliance requirements that call for your data to be replicated and redundant across different AWS accounts and AWS Regions. Cross-account replication of Amazon RDS data at scale is an inefficient and error-prone manual process that can be costly and time-consuming, but the automation in this pattern can help you achieve cross-account replication safely, effectively, and efficiently.

## Prerequisites and limitations

### Prerequisites

- Two AWS accounts
- An RDS DB instance, up and running in the source AWS account
- A subnet group for the RDS DB instance in the destination AWS account

- An AWS Key Management Service (AWS KMS) key created in the source AWS account and shared with the destination account (For more information about policy details, see the *Additional information* section of this pattern.)
- An AWS KMS key in the destination AWS account to encrypt the database in the destination account

### Product versions

- Python 3.9 (using AWS Lambda)
- PostgreSQL 11.3, 13.x, and 14.x

## Architecture

### Technology stack

- Amazon Relational Database Service (Amazon RDS)
- Amazon Simple Notification Service (Amazon SNS)
- AWS Key Management Service (AWS KMS)
- AWS Lambda
- AWS Secrets Manager
- AWS Step Functions

### Target architecture

The following diagram shows an architecture for using Step Functions to orchestrate scheduled, on-demand replication of RDS DB instances from a source account (account A) to a destination account (account B).



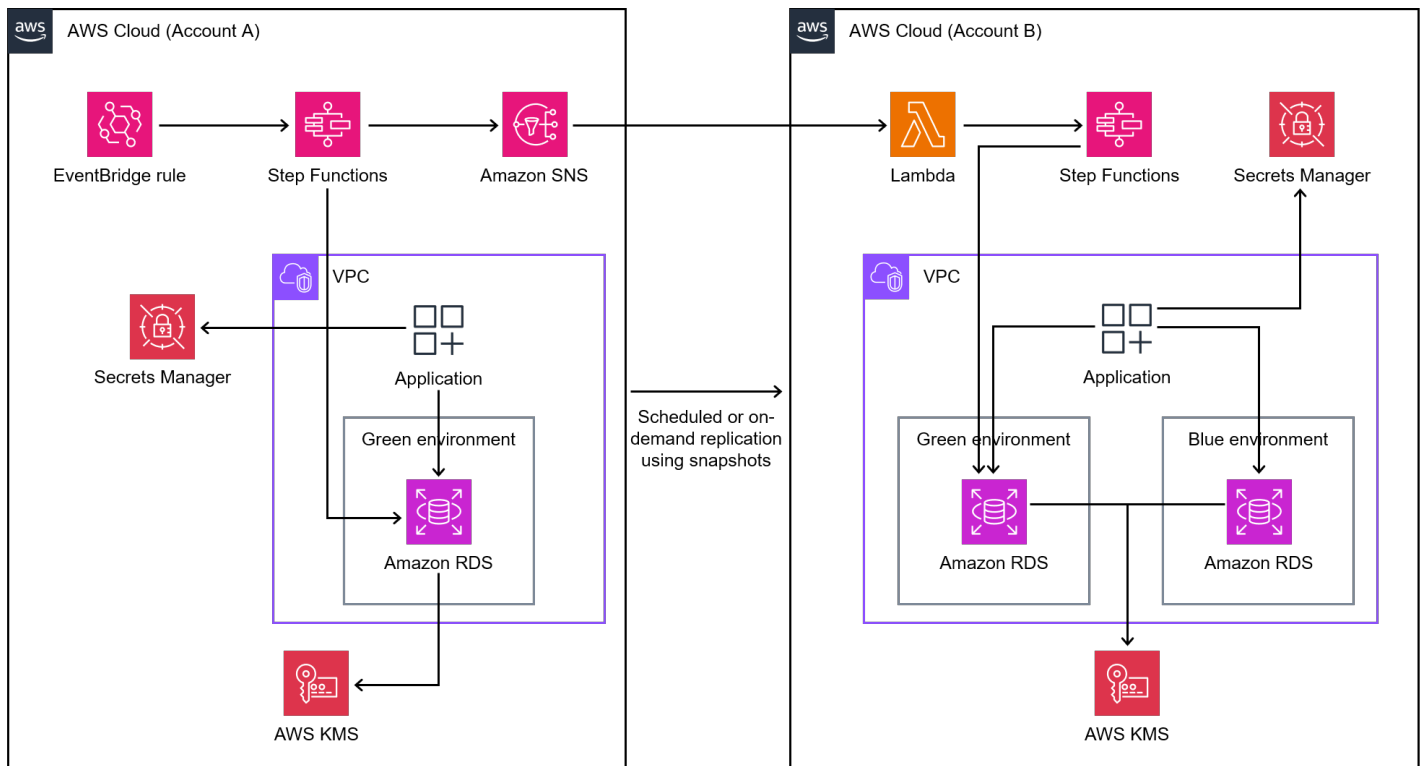

In the source account (account A in the diagram), the Step Functions state machine performs the following:

1. Creates a snapshot from the RDS DB instance in account A.
2. Copies and encrypts the snapshot with an AWS KMS key from account A. To ensure encryption in transit, the snapshot is encrypted whether or not the DB instance is encrypted.
3. Shares the DB snapshot with account B by giving account B access to the snapshot.
4. Pushes a notification to the SNS topic, and then the SNS topic invokes the Lambda function in account B.

In the destination account (account B in the diagram), the Lambda function runs the Step Functions state machine to orchestrate the following:

1. Copies the shared snapshot from account A to account B, while using the AWS KMS key from account A to decrypt the data first and then encrypt the data by using the AWS KMS key in account B.
2. Reads the secret from Secrets Manager to capture the name of the current DB instance.
3. Restores the DB instance from the snapshot with a new name and default AWS KMS key for Amazon RDS.

4. Reads the endpoint of the new database and updates the secret in Secrets Manager with the new database endpoint, and then tags the previous DB instance so that it can be deleted later.
5. Keeps the latest N instances of the databases and deletes all the other instances.

## Tools

### AWS tools

- [Amazon Relational Database Service \(Amazon RDS\)](#) helps you set up, operate, and scale a relational database in the AWS Cloud.
- [Amazon Simple Notification Service \(Amazon SNS\)](#) helps you coordinate and manage the exchange of messages between publishers and clients, including web servers and email addresses.
- [AWS CloudFormation](#) helps you set up AWS resources, provision them quickly and consistently, and manage them throughout their lifecycle across AWS accounts and Regions.
- [AWS Key Management Service \(AWS KMS\)](#) helps you create and control cryptographic keys to help protect your data.
- [AWS Lambda](#) is a compute service that helps you run code without needing to provision or manage servers. It runs your code only when needed and scales automatically, so you pay only for the compute time that you use.
- [AWS SDK for Python \(Boto3\)](#) is a software development kit that helps you integrate your Python application, library, or script with AWS services.
- [AWS Secrets Manager](#) helps you replace hardcoded credentials in your code, including passwords, with an API call to Secrets Manager to retrieve the secret programmatically.
- [AWS Step Functions](#) is a serverless orchestration service that helps you combine Lambda functions and other AWS services to build business-critical applications.

### Code

The code for this pattern is available in the GitHub [Crossaccount RDS Replication](#) repository.

## Epics

### Automate the replication of RDS DB instances across AWS accounts with a single click

Task	Description	Skills required
Deploy the CloudFormation stack in the source account.	<ol style="list-style-type: none"><li>1. Sign in to the AWS Management Console for the source account (account A) and open the <a href="#">CloudFormation console</a>.</li><li>2. In the navigation pane, choose <b>Stacks</b>.</li><li>3. Choose <b>Create stack</b>, and then choose <b>With existing resources (import resources)</b>.</li><li>4. On the <b>Identify resources</b> page, choose <b>Next</b>.</li><li>5. On the <b>Specify template</b> page, select <b>Upload a template</b>.</li><li>6. Choose <b>Choose file</b>, select the Cloudformation-SourceAccountRDS.yaml file from the GitHub <a href="#">Crossaccount RDS Replication</a> repository, and then choose <b>Next</b>.</li><li>7. For <b>Stack name</b>, enter a name for your stack.</li><li>8. In the <b>Parameters</b> section, specify the parameters that are defined in the stack template:</li></ol>	Cloud administrator, Cloud architect

Task	Description	Skills required
	<ul style="list-style-type: none"> <li>• For <b>DestinationAccountNumber</b>, enter the account number for your destination RDS DB instance.</li> <li>• For <b>KeyName</b>, enter your AWS KMS key.</li> <li>• For <b>ScheduleExpression</b>, enter a <a href="#">cron expression</a> (the default is <b>12:00 am daily</b>).</li> <li>• For <b>SourceDBIdentifier</b>, enter the name of the source database.</li> <li>• For <b>SourceDBSnapshotName</b>, enter the name of the snapshot or accept the default.</li> </ul> <p>9. Choose <b>Next</b>.</p> <p>10 On the <b>Configure stack options</b> page, leave the default values, and then choose <b>Next</b>.</p> <p>11 Review your stack configuration, and then choose <b>Submit</b>.</p> <p>12 Choose the <b>Resources</b> tab for your stack, and then note the Amazon Resource Name (ARN) of the SNS topic.</p>	

Task	Description	Skills required
Deploy the CloudFormation stack in the destination account.	<ol style="list-style-type: none"><li>1. Sign in to the AWS Management Console for the destination account (account B) and open the <a href="#">CloudFormation console</a>.</li><li>2. In the navigation pane, choose <b>Stacks</b>.</li><li>3. Choose <b>Create stack</b>, and then choose <b>With existing resources (import resources)</b>.</li><li>4. On the <b>Identify resources</b> page, choose <b>Next</b>.</li><li>5. On the <b>Specify template</b> page, select <b>Upload a template</b>.</li><li>6. Choose <b>file</b>, select the <code>Cloudformation-DestinationAccountRDS.yaml</code> file from the GitHub <a href="#">Crossaccount RDS Replication</a> repository, and then choose <b>Next</b>.</li><li>7. For <b>Stack name</b>, enter a name for your stack.</li><li>8. In the <b>Parameters</b> section, specify the parameters that are defined in the stack template:<ul style="list-style-type: none"><li>• For <b>DatabaseName</b>, enter a name for your database.</li></ul></li></ol>	Cloud architect, DevOps engineer, Cloud administrator

Task	Description	Skills required
	<ul style="list-style-type: none"> <li>• For <b>Engine</b>, enter the database engine type that matches the source database.</li> <li>• For <b>DBInstanceClass</b>, enter the preferred database instance type or accept the default.</li> <li>• For <b>Subnetgroups</b>, enter the existing VPC subnet group. For instructions about creating a subnet group, see <a href="#">Step 2: Create a DB subnet group</a> in the Amazon RDS User Guide.</li> <li>• For <b>SecretName</b>, enter the path and secret name, or accept the default.</li> <li>• For <b>SGID</b>, enter the security group ID of your destination cluster.</li> <li>• For <b>KMSKey</b>, enter the ARN of the KMS key in your destination account.</li> <li>• For <b>NoOfOlderInstances</b>, enter the number of old copies of the RDS DB instances that you want to keep for the rollback.</li> </ul> <p>9. Choose <b>Next</b>.</p> <p>10 On the <b>Configure stack options</b> page, leave the</p>	

Task	Description	Skills required
	<p>default values, and then choose <b>Next</b>.</p> <p>11 Review your stack configuration, and then choose <b>Submit</b>.</p> <p>12 Choose the <b>Resources</b> tab for your stack, and then note the Physical ID and ARN of <code>InvokeStepFunction</code>.</p>	
<p>Verify the creation of the RDS DB instance in the destination account.</p>	<ol style="list-style-type: none"> <li>1. Sign in to the AWS Management Console and open the <a href="#">Amazon RDS console</a>.</li> <li>2. In the navigation pane, choose <b>Databases</b>, and then verify that the new RDS DB instance appears under the new cluster.</li> </ol>	<p>Cloud administrator, Cloud architect, DevOps engineer</p>

Task	Description	Skills required
Subscribe the Lambda function to the SNS topic.	<p>You must run the following AWS Command Line Interface (AWS CLI) commands to subscribe the Lambda function in the destination account (account B) to the SNS topic in the source account (account A).</p> <p>In account A, run following command:</p> <pre>aws sns add-permission \   --label lambda-access \   --aws-account-id \   &lt;DestinationAccount&gt; \   --topic-arn &lt;Arn of \   SNSTopic &gt; \   --action-name Subscribe \   ListSubscriptionsByTopic</pre> <p>In account B, run following command:</p> <pre>aws lambda add-permission \   --function-name &lt;Name \   of InvokeStepFunction \   &gt; \   --source-arn &lt;Arn of \   SNSTopic &gt; \   --statement-id \   function-with-sns \   --action lambda:InvokeFunction \</pre>	Cloud administrator, Cloud architect, DBA



Task	Description	Skills required
	<pre data-bbox="597 205 1026 304">--principal sns.amazo naws.com</pre> <p data-bbox="597 346 1026 430">In account B, run following command:</p> <pre data-bbox="597 472 1026 781">aws sns subscribe \ --protocol "lambda" \ --topic-arn &lt;Arn of SNSTopic&gt; \ --notification-e ndpoint &lt;Arn of InvokeStepFunction&gt;</pre>	

Task	Description	Skills required
<p>Sync the RDS DB instance from the source account with the destination account.</p>	<p>Initiate the on-demand database replication by starting the Step Functions state machine in the source account.</p> <ol style="list-style-type: none"><li>1. Open the <a href="#">Step Functions console</a>.</li><li>2. In the navigation pane, choose <b>State machines</b>.</li><li>3. Choose your state machine.</li><li>4. On the <b>Executions</b> tab, select your function, and then choose <b>Start execution</b> to start the workflow.</li></ol> <p><b>Note:</b> A scheduler is in place to help you run the replication automatically on schedule, but the scheduler is turned off by default. You can find the name of the Amazon CloudWatch rule for the scheduler in the <b>Resources</b> tab of the CloudFormation stack in the destination account. For instructions on how to modify the CloudWatch Events rule, see <a href="#">Deleting or Disabling a CloudWatch Events Rule</a> in the CloudWatch User Guide.</p>	<p>Cloud architect, DevOps engineer, Cloud administrator</p>

Task	Description	Skills required
Roll back your database to any of the previous copies when needed.	<ol style="list-style-type: none"><li>1. Open the <a href="#">Secrets Manager console</a>.</li><li>2. From the list of secrets, choose the secret that you created by using the CloudFormation template earlier. Your application uses the secret to access the database in the destination cluster.</li><li>3. To update the secret value from the details page, in the <b>Secret value</b> section, choose <b>Retrieve secret</b> value, and then choose <b>Edit</b>.</li><li>4. Enter the details of the database endpoint.</li></ol>	Cloud administrator, DBA, DevOps engineer

## Related resources

- [Cross-Region read replicas](#) (Amazon RDS User Guide)
- [Blue/Green Deployments](#) (Amazon RDS User Guide)

## Additional information

You can use the following example policy to share your AWS KMS key across AWS accounts.

```
{
  "Version": "2012-10-17",
  "Id": "cross-account-rds-kms-key",
  "Statement": [
    {
      "Sid": "Enable user permissions",
```

```
    "Effect": "Allow",
    "Principal": {
      "AWS": "arn:aws:iam::<SourceAccount>:root"
    },
    "Action": "kms:*",
    "Resource": "*"
  },
  {
    "Sid": "Allow administration of the key",
    "Effect": "Allow",
    "Principal": {
      "AWS": "arn:aws:iam::<DestinationAccount>:root"
    },
    "Action": [
      "kms:Create*",
      "kms:Describe*",
      "kms:Enable*",
      "kms:List*",
      "kms:Put*",
      "kms:Update*",
      "kms:Revoke*",
      "kms:Disable*",
      "kms:Get*",
      "kms>Delete*",
      "kms:ScheduleKeyDeletion",
      "kms:CancelKeyDeletion"
    ],
    "Resource": "*"
  },
  {
    "Sid": "Allow use of the key",
    "Effect": "Allow",
    "Principal": {
      "AWS": [
        "arn:aws:iam::<DestinationAccount>:root",
        "arn:aws:iam::<SourceAccount>:root"
      ]
    },
    "Action": [
      "kms:Encrypt",
      "kms:Decrypt",
      "kms:ReEncrypt*",
      "kms:GenerateDataKey*",
      "kms:DescribeKey",
```

```
        "kms:CreateGrant"  
    ],  
    "Resource": "*" ]  
]  
}
```

# Automatically back up SAP HANA databases using Systems Manager and EventBridge

Created by Ambarish Satarkar (AWS) and Gaurav Rath (AWS)

<b>Code repository:</b> <a href="#">HDB_Backup_SSM_Document</a>	<b>Environment:</b> Production	<b>Technologies:</b> Databases; Storage & backup
<b>Workload:</b> SAP	<b>AWS services:</b> Amazon EC2; Amazon EventBridge; Amazon S3; AWS Systems Manager	

## Summary

This pattern describes how to automate SAP HANA database backups using AWS Systems Manager, Amazon EventBridge, Amazon Simple Storage Service (Amazon S3), and AWS Backup Agent for SAP HANA.

This pattern provides a shell script-based approach using the `BACKUP DATA` command and removes the need to maintain scripts and job configurations for each operating system (OS) instance across numerous systems.

**Note:** As of April 2023, AWS Backup announced support for SAP HANA databases on Amazon Elastic Compute Cloud (Amazon EC2). For more information, see [SAP HANA databases on Amazon EC2 instances backup](#).

Based on your organization's needs, you can use the AWS Backup service to automatically back up your SAP HANA databases or you can use this pattern.

## Prerequisites and limitations

### Prerequisites

- An existing SAP HANA instance with a supported release in running state on a managed Amazon Elastic Compute Cloud (Amazon EC2) instance that is configured for Systems Manager

- Systems Manager Agent (SSM Agent) 2.3.274.0 or later installed
- An S3 bucket that doesn't have public access enabled
- An `hdbuserstore` key named `SYSTEM`
- An AWS Identity and Access Management (IAM) role for the Automation runbook to run on schedule
- `AmazonSSMManagedInstanceCore` and `ssm:StartAutomationExecution` policies are attached to Systems Manager Automation service role.

## Limitations

- AWS Backint Agent for SAP HANA doesn't support deduplication.
- AWS Backint Agent for SAP HANA doesn't support data compression.

## Product versions

AWS Backint Agent is supported on the following operating systems:

- SUSE Linux Enterprise Server
- SUSE Linux Enterprise Server for SAP
- Red Hat Enterprise Linux for SAP

AWS Backint Agent supports the following databases:

- SAP HANA 1.0 SP12 (single node and multiple nodes)
- SAP HANA 2.0 and later (single node and multiple nodes)

## Architecture

### Target technology stack

- AWS Backint Agent
- Amazon S3
- AWS Systems Manager
- Amazon EventBridge
- SAP HANA

## Target architecture

The following diagram shows the installation scripts that install AWS Backint Agent, the S3 bucket, and Systems Manager and EventBridge, which use a Command document to schedule regular backups.

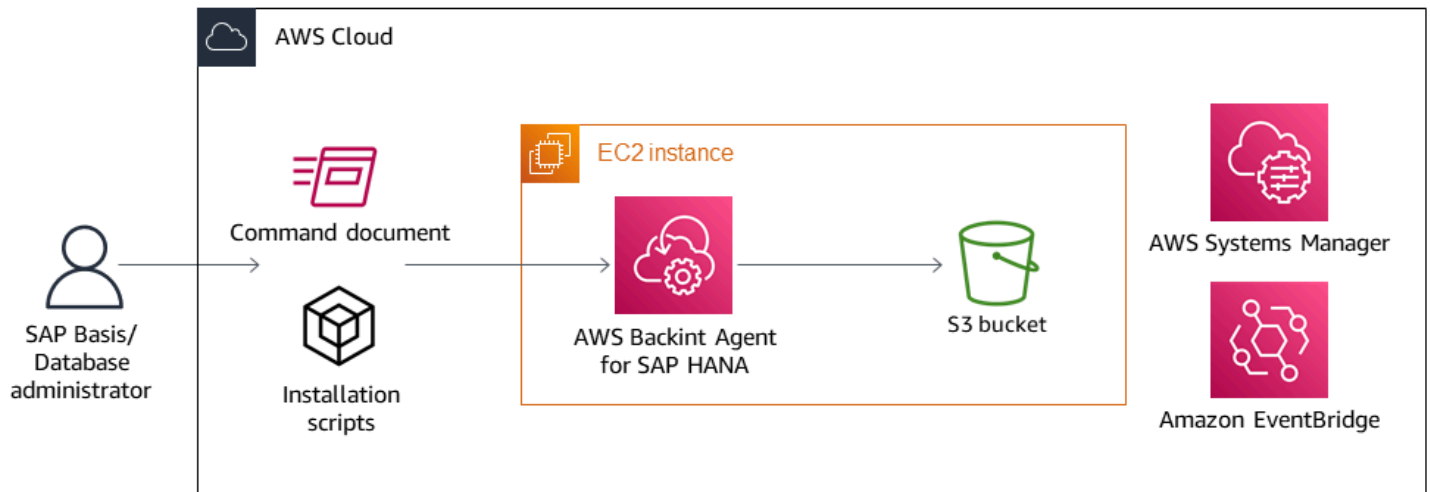

## Automation and scale

- Multiple AWS Backint Agents can be installed by using a Systems Manager Automation runbook.
- Each run of the Systems Manager runbook can scale to  $n$  number of SAP HANA instances, based on target selection.
- EventBridge can automate SAP HANA backups.

## Tools

- [AWS Backint Agent for SAP HANA](#) is a standalone application that integrates with your existing workflows to back up your SAP HANA database to an S3 bucket that you specify in the configuration file. AWS Backint Agent supports full, incremental, and differential backups of SAP HANA databases. It runs on an SAP HANA database server, where backups and catalogs are transferred from the SAP HANA database to the AWS Backint Agent.
- [Amazon EventBridge](#) is a serverless event bus service that you can use to connect your applications with data from a variety of sources. EventBridge delivers a stream of real-time data from your applications, software as a service (SaaS) applications, and AWS services to targets such as AWS Lambda functions, HTTP invocation endpoints using API destinations, or event buses in other accounts.



- [Amazon Simple Storage Service \(Amazon S3\)](#) is an object storage service. You can use Amazon S3 to store and retrieve any amount of data at any time, from anywhere on the web.
- [AWS Systems Manager](#) helps you to view and control your infrastructure on AWS. Using the Systems Manager console, you can view operational data from multiple AWS services and automate operational tasks across your AWS resources.

## Code

The code for this pattern is available in the [aws-backint-automated-backup](#) GitHub repository.

## Epics

### Create an hdbuserstore key SYSTEM

Task	Description	Skills required
Create an hdbuserstore key.	<ol style="list-style-type: none"> <li>1. Navigate to <code>/usr/sap/&lt;SID&gt;/HDB&lt;InstNo&gt;/exe</code>.</li> <li>2. Run the following command, with XX as the SAP HANA database instance number.</li> </ol> <pre>hdbuserstore -i set SYSTEM &lt;hostname&gt;:3XX13@SYSTEMDB SYSTEM</pre> <p>For example, for an SAP HANA host saphanadb with instance number 00, run the following command.</p> <pre>hdbuserstore -i set SYSTEM saphanadb</pre>	AWS administrator, SAP HANA Administrator

Task	Description	Skills required
	:30013@SYSTEMDB SYSTEM	

## Install AWS Backint Agent

Task	Description	Skills required
Install AWS Backint Agent.	Follow the instructions in <a href="#">Install and configure AWS Backint Agent for SAP HANA</a> in the AWS Backint Agent documentation.	AWS administrator, SAP HANA administrator

## Create the Systems Manager Command document

Task	Description	Skills required
Create the Systems Manager Command document.	<ol style="list-style-type: none"> <li>1. Sign in to the AWS Management Console and open the AWS Systems Manager Console.</li> <li>2. Choose <b>Documents</b>, and choose <b>Owned by me</b>.</li> <li>3. Confirm that you are in the same AWS Region as your SAP HANA database.</li> <li>4. Choose <b>Create document, Command or session</b> to create your document.</li> <li>5. Use a unique and descriptive name, with no spaces</li> </ol>	AWS administrator, SAP HANA administrator

Task	Description	Skills required
	<p>(for example, <b>SAP HANA-Backup</b>).</p> <ol style="list-style-type: none"> <li>Make sure that <b>Document type</b> is set to <b>Command document</b>.</li> <li>Under the <b>Content</b> header, there is some sample code. Make sure that you choose the <b>JSON</b> code type, and replace the code with the code from the <code>HDB_Backup_SSM_Document.json</code> file from the <a href="#">GitHub repository</a>.</li> <li>Choose <b>Create document</b>.</li> <li>Check your document in the <b>Owned by me</b> section.</li> </ol>	

### Schedule backups on a regular frequency

Task	Description	Skills required
Schedule regular backups using Amazon EventBridge.	<ol style="list-style-type: none"> <li>Open the Amazon EventBridge console, choose <b>Rules</b>, and choose <b>Create rule</b>.</li> <li>On the <b>Define rule detail</b> screen, enter a unique name and description for your rule, and use the default event bus.</li> </ol>	AWS administrator, SAP HANA administrator

Task	Description	Skills required
	<ol style="list-style-type: none"><li data-bbox="592 212 992 338">3. Under <b>Rule type</b>, choose <b>Schedule</b>, and choose <b>Next</b>.</li><li data-bbox="592 365 992 638">4. On then <b>Define schedule</b> screen, choose the appropriate schedule pattern and cron or rate expression based on the required frequency.</li><li data-bbox="592 665 1024 938">5. On the <b>Select targets</b> screen, for <b>Target type</b>, choose <b>AWS service</b>. Under <b>Select a target</b>, choose <b>Systems Manager Run Command</b>.</li><li data-bbox="592 953 1016 1037">6. Choose the document that you created earlier.</li><li data-bbox="592 1064 1000 1283">7. Under <b>Target key</b> and <b>Target value</b>, provide the instance ID. You can use tag names and tag values to add multiple instances.</li><li data-bbox="592 1310 976 1625">8. Under <b>Configure automation parameters</b>, choose <b>Constant</b> for incremental or differential backups. If you want full backup, choose <b>No Parameters</b>.</li><li data-bbox="592 1652 1000 1871">9. Choose whether to create a new role or to use an existing role. If you use an existing role, make sure that it has the policies</li></ol>	

Task	Description	Skills required
	<p>required to invoke the target.</p> <p>10 Keep the default additional settings, and choose <b>Next</b>.</p> <p>11 The <b>Configure tags</b> screen is optional. Choose <b>next</b>.</p> <p>12 On the <b>Review and create</b> screen, review the rule settings, and choose <b>Create</b>. The rule should be successfully created.</p> <p>You can verify backup success from the S3 bucket path.</p> <pre>s3: /&lt;your_bucket_name&gt;/&lt;target folder&gt;/&lt;SID&gt;/usr/sap/&lt;SID&gt;/SYS/global/hdb/backupint/DB_&lt;SID&gt;/</pre> <p>You can also verify backups from the SAP HANA backup catalog.</p>	

## Related resources

- [AWS Backint Agent for SAP HANA](#)
- [Install and configure AWS Backint Agent for SAP HANA](#)

# Block public access to Amazon RDS by using Cloud Custodian

Created by *abhay kumar (AWS)* and *Dwarika Patra (AWS)*

**Environment:** Production

**Technologies:** Databases;  
Security, identity, compliance

**Workload:** All other  
workloads; Open-source

**AWS services:** Amazon RDS

## Summary

Many organizations run their workloads and services on multiple cloud vendors. In these hybrid cloud environments, the cloud infrastructure needs strict cloud governance, in addition to the security provided by the individual cloud providers. A cloud database such as Amazon Relational Database Service (Amazon RDS) is one important service that must be monitored for any access and permission vulnerabilities. Although you can restrict access to the Amazon RDS database by configuring a security group, you can add a second layer of protection to prohibit actions such as public access. Ensuring public access is blocked will help you with General Data Protection Regulation (GDPR), Health Insurance Portability and Accountability Act (HIPAA), National Institute of Standards and Technology (NIST), and Payment Card Industry Data Security Standard (PCI DSS) compliance.

Cloud Custodian is an open-source rules engine that you can use to enforce access restrictions for Amazon Web Services (AWS) resources such as Amazon RDS. With Cloud Custodian, you can set rules that validate the environment against defined security and compliance standards. You can use Cloud Custodian to manage your cloud environments by helping to ensure compliance with security policies, tag policies, and garbage collection of unused resources and cost management. With Cloud Custodian, you can use a single interface for implementing governance in a hybrid cloud environment. For example, you could use the Cloud Custodian interface to interact with AWS and Microsoft Azure, reducing the effort of working with mechanisms such as AWS Config, AWS security groups, and Azure policies.

This pattern provides instructions for using Cloud Custodian on AWS to enforce restriction of public accessibility on Amazon RDS instances.

## Prerequisites and limitations

### Prerequisites

- An active AWS account
- [A key pair](#)
- AWS Lambda installed

## Architecture

### Target technology stack

- Amazon RDS
- AWS CloudTrail
- AWS Lambda
- Cloud Custodian

### Target architecture

The following diagram shows Cloud Custodian deploying the policy to Lambda, AWS CloudTrail initiating the `CreateDBInstance` event, and the Lambda function setting `PubliclyAccessible` to false on Amazon RDS.

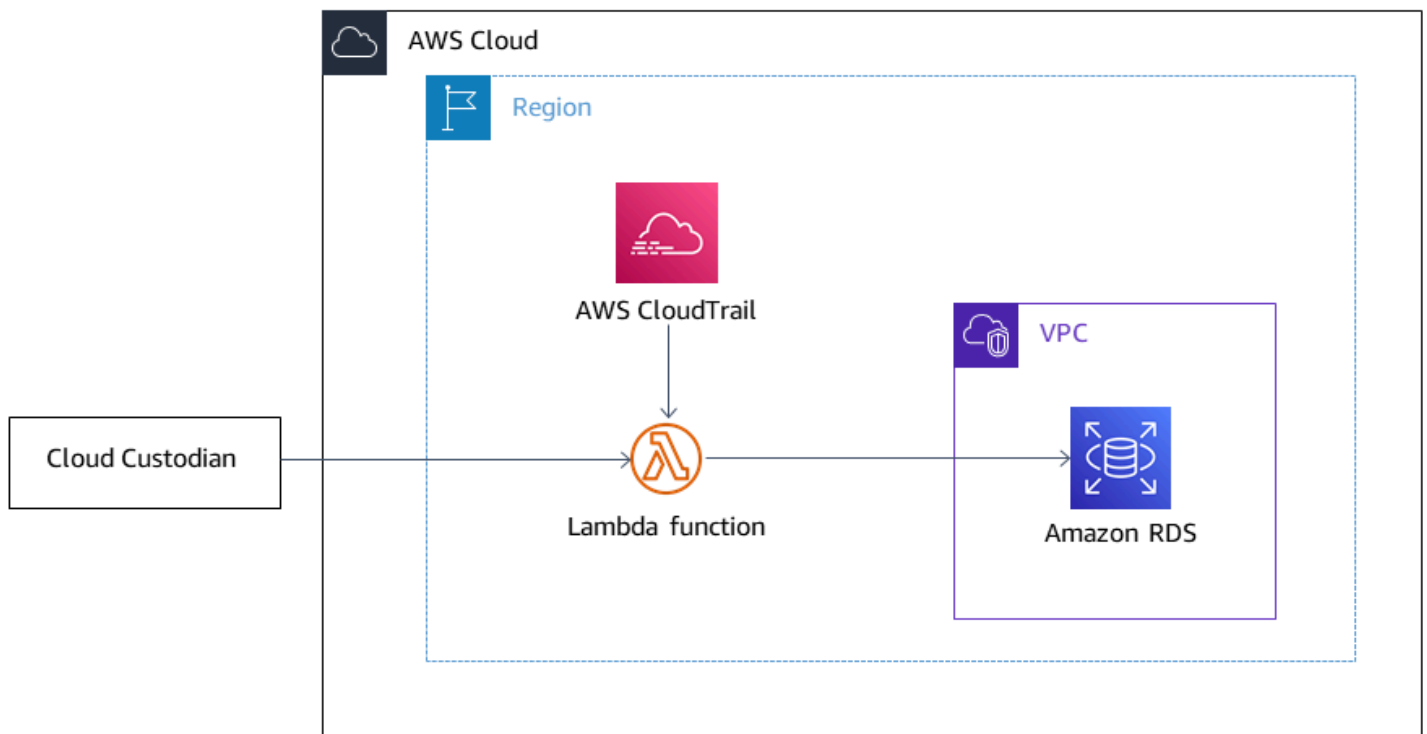

## Tools

### AWS services

- [AWS CloudTrail](#) helps you audit the governance, compliance, and operational risk of your AWS account.
- [AWS Command Line Interface \(AWS CLI\)](#) is an open-source tool that helps you interact with AWS services through commands in your command line shell.
- [AWS Identity and Access Management \(IAM\)](#) helps you securely manage access to your AWS resources by controlling who is authenticated and authorized to use them.
- [AWS Lambda](#) is a compute service that helps you run code without needing to provision or manage servers. It runs your code only when needed and scales automatically, so you pay only for the compute time that you use.
- [Amazon Relational Database Service \(Amazon RDS\)](#) helps you set up, operate, and scale a relational database in the AWS Cloud.

### Other tools

- [Cloud Custodian](#) unifies the tools and scripts that many organizations use to manage their public cloud accounts into one open source tool. It uses a stateless rules engine for policy definition and



enforcement, with metrics, structured outputs, and detailed reporting for cloud infrastructure. It integrates tightly with a serverless runtime to provide real-time remediation and response with low operational overhead.

## Epics

### Set up AWS CLI

Task	Description	Skills required
Install AWS CLI.	To install AWS CLI, follow the instructions in the <a href="#">AWS documentation</a> .	AWS administrator
Set up AWS credentials.	<p>Configure the settings that the AWS CLI uses to interact with AWS, including the AWS Region and the output format that you want to use.</p> <pre>\$&gt;aws configure AWS Access Key ID [None]: &lt;your_access_key_id&gt; AWS Secret Access Key [None]: &lt;your_secret_access_key&gt; Default region name [None]: Default output format [None]:</pre> <p>For more information, see the <a href="#">AWS documentation</a>.</p>	AWS administrator
Create an IAM role.	To create an IAM role with the Lambda execution role, run the following command.	AWS DevOps

Task	Description	Skills required
	<pre>aws iam create-role -- role-name lambda-ex -- assume-role-policy- document '{"Version": "2012-10-17", "Stat ement": [{ "Effect": "Allow", "Principal": {"Service": "lambda.a mazonaws.com"}, "Action": "sts:Assu meRole"}]}'</pre>	

## Set up Cloud Custodian

Task	Description	Skills required
Install Cloud Custodian.	To install Cloud Custodian for your operating system and environment, follow the instructions in the <a href="#">Cloud Custodian documentation</a> .	DevOps engineer
Check the Cloud Custodian schema.	To see the complete list of Amazon RDS resources against which you can run policies, use the following command. <pre>custodian schema aws.rds</pre>	DevOps engineer
Create the Cloud Custodian policy.	Save the code that's under <i>Cloud Custodian policy file</i> in the <i>Additional information</i> section using a YAML extension.	DevOps engineer

Task	Description	Skills required
Define Cloud Custodian actions to change the publicly accessible flag.	<ol style="list-style-type: none"> <li>1. Locate the custodian code (for example, <code>/Users/abcd/custodian/lib/python3.9/site-packages/c7n/resources/rds.py</code>).</li> <li>2. Locate the <code>RDSSetPublicAvailability</code> class in <code>rds.py</code>, and modify this class by using the code that's under <code>c7n/resources/rds.py</code> file in the <i>Additional information</i> section.</li> </ol>	DevOps engineer
Perform a dry run.	<p>(Optional) To check which resources are identified by the policy without running any actions on the resources, use the following command.</p> <pre>custodian run -dryrun &lt;policy_name&gt;.yaml -s &lt;output_directory&gt;</pre>	DevOps engineer

## Deploy the policy

Task	Description	Skills required
Deploy the policy by using Lambda.	To create the Lambda function that will run the policy, use the following command.	DevOps engineer

Task	Description	Skills required
	<pre>custodian run -s policy.yaml</pre> <p>This policy will then be initiated by the AWS CloudTrail CreateDBInstance event.</p> <p>As a result, AWS Lambda will set the publicly accessible flag to false for instances that match the criteria.</p>	

## Related resources

- [AWS Lambda](#)
- [Amazon RDS](#)
- [Cloud Custodian](#)

## Additional information

### Cloud Custodian policy YAML file

```
policies:  
  - name: "block-public-access"  
    resource: rds  
    description: |  
      This Enforcement blocks public access for RDS instances.  
    mode:  
      type: cloudtrail  
    events:  
      - event: CreateDBInstance # Create RDS instance cloudtrail event  
        source: rds.amazonaws.com  
        ids: requestParameters.dbInstanceIdentifier  
        role: arn:aws:iam::1234567890:role/Custodian-compliance-role  
    filters:
```

```

- type: event
  key: 'detail.requestParameters.publiclyAccessible'
  value: true
actions:
- type: set-public-access
  state: false

```

## c7n resources rds.py file

```

@actions.register('set-public-access')
class RDSSetPublicAvailability(BaseAction):

    schema = type_schema(
        "set-public-access",
        state={'type': 'boolean'})
    permissions = ('rds:ModifyDBInstance',)

    def set_accessibility(self, r):
        client = local_session(self.manager.session_factory).client('rds')
        waiter = client.get_waiter('db_instance_available')
        waiter.wait(DBInstanceIdentifier=r['DBInstanceIdentifier'])
        client.modify_db_instance(
            DBInstanceIdentifier=r['DBInstanceIdentifier'],
            PubliclyAccessible=self.data.get('state', False))

    def process(self, rds):
        with self.executor_factory(max_workers=2) as w:
            futures = {w.submit(self.set_accessibility, r): r for r in rds}
            for f in as_completed(futures):
                if f.exception():
                    self.log.error(
                        "Exception setting public access on %s \n %s",
                        futures[f]['DBInstanceIdentifier'], f.exception())

        return rds

```

## Security Hub integration

Cloud Custodian can be integrated with [AWS Security Hub](#) to send security findings and attempt remediation actions. For more information, see [Announcing Cloud Custodian Integration with AWS Security Hub](#).

# Configure cross-account access to Amazon DynamoDB

Created by Shashi Dalmia (AWS), Esteban Serna Parra (AWS), and Imhoertha Ojior (AWS)

**Environment:** Production

**Technologies:** Databases;  
Security, identity, compliance

**AWS services:** Amazon  
DynamoDB; AWS Identity and  
Access Management; AWS  
Lambda

## Summary

This pattern explains the steps for configuring cross-account access to Amazon DynamoDB by using resource-based policies. For workloads that use DynamoDB, it's becoming more common to use [workload isolation strategies](#) to minimize security threats and to meet compliance requirements. Implementing workload isolation strategies often requires cross-account and cross-Region access to DynamoDB resources by using AWS Identity and Access Management (IAM) identity-based policies. This involves setting IAM permissions and establishing a trust relationship between the AWS accounts.

[Resource-based policies for DynamoDB](#) greatly simplify the security posture for cross-account workloads. This pattern provides steps and sample code to demonstrate how you can configure AWS Lambda functions in one AWS account to write data to a DynamoDB database table in a different account.

## Prerequisites and limitations

### Prerequisites

- Two active AWS accounts. This pattern refers to these accounts as *Account A* and *Account B*.
- AWS Command Line Interface (AWS CLI) [installed](#) and [configured](#) to access Account A, to create the DynamoDB table. The other steps in this pattern provide instructions for using the IAM, DynamoDB, and Lambda consoles. If you're planning to use AWS CLI instead, configure it to access both accounts.

### Limitations

- Some AWS services aren't available in all AWS Regions. For Region availability, see [AWS services by Region](#). For specific endpoints, see the [Service endpoints and quotas](#) page, and choose the link for the service.

## Architecture

The following diagram shows a single-account architecture. AWS Lambda, Amazon Elastic Compute Cloud (Amazon EC2), and DynamoDB are all in the same account. In this scenario, Lambda functions and Amazon EC2 instances can access DynamoDB. To grant access to the DynamoDB table, you can create an identity-based policy in IAM, or you can create a resource-based policy in DynamoDB.

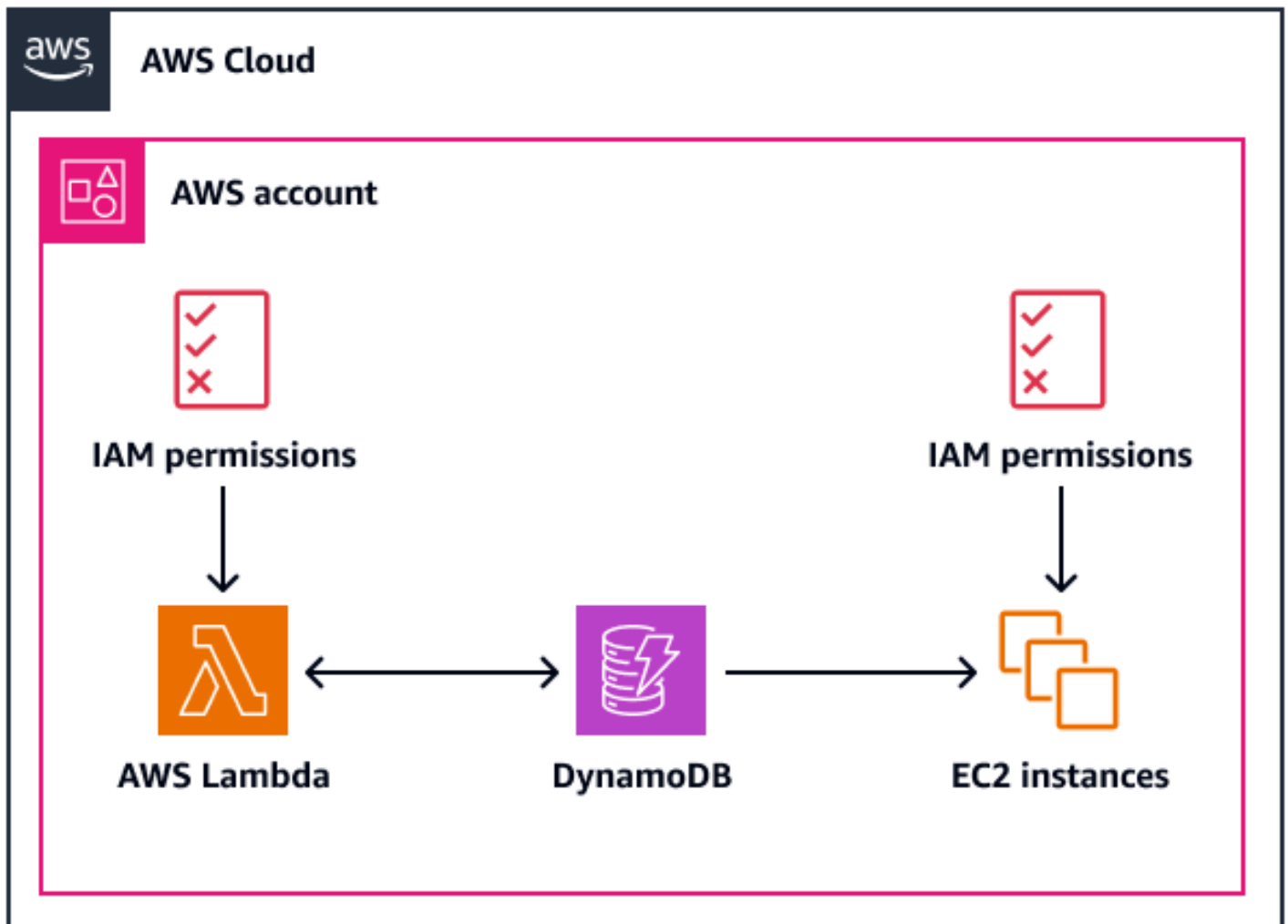

The following diagram shows a multi-account architecture. If resources in one AWS account require access to a DynamoDB table in a different account, you need to set up a resource-based policy

in DynamoDB to grant the required access. For example, in the following diagram, access to the DynamoDB table in Account A is granted to a Lambda function in Account B by using a resource-based policy.

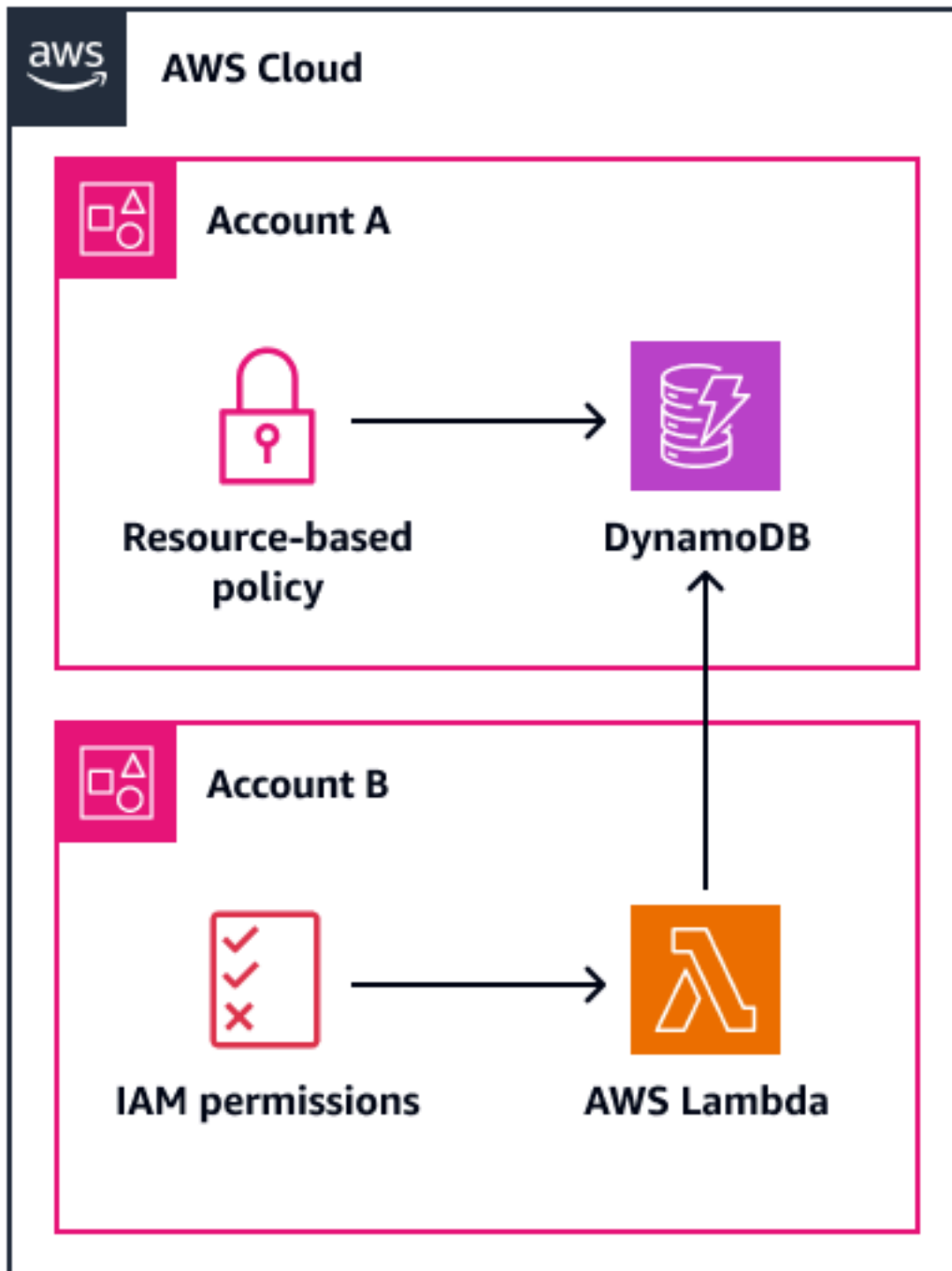

This pattern describes cross-account access between Lambda and DynamoDB. You can use similar steps for other AWS services if the appropriate permissions are configured on both accounts. For example, if you want to provide a Lambda function access to an Amazon Simple Storage Service



(Amazon S3) bucket in Account A, you can create a [resource-based policy](#) in Amazon S3 and add the permissions to the [Lambda execution role](#) in Account B.

## Tools

### AWS services

- [Amazon DynamoDB](#) is a fully managed NoSQL database service that provides fast, predictable, and scalable performance.
- [AWS Identity and Access Management \(IAM\)](#) helps you securely manage access to your AWS resources by controlling who is authenticated and authorized to use them.
- [AWS Lambda](#) is a compute service that helps you run code without needing to provision or manage servers. It runs your code only when needed and scales automatically, so you pay only for the compute time that you use.

### Code

This pattern includes sample code in the [Additional information](#) section to show how you can configure a Lambda function in Account B to write to the DynamoDB table in Account A. The code is provided only for illustration and testing purposes. If you're implementing this pattern in a production environment, use the code as a reference, and customize it for your own environment.

## Best practices

- Follow the [best practices for resource-based policies](#) in the DynamoDB documentation.
- Follow the principle of least privilege and grant the minimum permissions required to perform a task. For more information, see [Grant least privilege](#) and [Security best practices](#) in the IAM documentation.

## Epics

### Create an IAM policy and role in Account B

Task	Description	Skills required
Create a policy in Account B.	This IAM policy allows the <a href="#">PutItem</a> action for a	General AWS

Task	Description	Skills required
	<p>DynamoDB table in Account A.</p> <ol style="list-style-type: none"><li>1. Sign in to Account A in the AWS Management Console.</li><li>2. Open the <a href="#">IAM console</a>.</li><li>3. In the navigation pane, choose <b>Policies</b>, and then choose <b>Create policy</b>.</li><li>4. On the <b>Specify permissions</b> page, for the policy editor, select <b>JSON</b>.</li><li>5. Enter the following policy.</li></ol> <pre data-bbox="630 877 1029 1675">{   "Version":     "2012-10-17",   "Statement": [     {       "Sid": "Statement1",       "Effect":         "Allow",       "Action":         "dynamodb:PutItem",       "Resource":         "arn:aws:dynamodb:         &lt;Region&gt;:&lt;Account-A-ID&gt;:table/Table-Account-A"     }   ] }</pre>	

Task	Description	Skills required
	<ol style="list-style-type: none"><li>7. For <b>Policy name</b>, enter a unique name for your policy, such as <code>DynamoDB-PutItem-Policy</code> .</li><li>8. (Optional) Add a policy description.</li><li>9. Choose <b>Create policy</b>.</li></ol>	

Task	Description	Skills required
Create a role in Account B.	<p>The Lambda function in Account B uses this IAM role to access the DynamoDB table in Account A.</p> <ol style="list-style-type: none"><li>1. Open the <a href="#">IAM console</a>.</li><li>2. In the navigation pane, choose <b>Roles</b>, and then choose <b>Create role</b>.</li><li>3. For <b>Select trusted entity</b>, choose <b>AWS service</b>.</li><li>4. In the <b>Use case</b> section, choose <b>Lambda</b>.</li><li>5. Choose <b>Next: Permissions</b>.</li><li>6. In the <b>Filter policies</b> box, enter <b>DynamoDB</b>.</li><li>7. In the list of DynamoDB policies, choose DynamoDB-PutItem-Policy .</li><li>8. Clear the <b>Filter policies</b> box, and then enter <b>Lambda</b>.</li><li>9. In the list of Lambda policies, choose <b>AWSLambdaExecute</b>.</li><li>10 Choose <b>Next: Name, review, and create</b>.</li><li>11 For <b>Role name</b>, enter a unique name for your role, such as DynamoDB-PutItemAccess .</li></ol>	General AWS

Task	Description	Skills required
	<p>12(Optional) Add a role description.</p> <p>13(Optional) Add metadata to the role by attaching tags as key-value pairs.</p> <p>14Choose <b>Create role</b>.</p> <p>For more information about creating roles, see the <a href="#">IAM documentation</a>.</p>	
<p>Note the role ARN.</p>	<ol style="list-style-type: none"> <li>1. Open the <a href="#">IAM console</a>.</li> <li>2. In the navigation pane, choose <b>Roles</b>.</li> <li>3. In the search box, enter <code>DynamoDB-PutItemAccess</code> , and then choose the role.</li> <li>4. On the summary page for the role, copy the Amazon Resource Name (ARN). You use the ARN when you set up the Lambda function.</li> </ol>	<p>General AWS</p>

## Create a DynamoDB table in Account A

Task	Description	Skills required
<p>Create a DynamoDB table.</p>	<p>Use the following AWS CLI command to create a DynamoDB table.</p> <pre>aws dynamodb create-table \</pre>	<p>General AWS</p>

Task	Description	Skills required
	<pre> --table-name Table- Account-A \ --attribute-defini tions \ Attribute Name=category,Attr ibuteType=S \ Attribute Name=item,Attribut eType=S \ --key-schema \ Attribute Name=category,KeyT ype=HASH \ Attribute Name=item,KeyType= RANGE \ --provisioned-thro ughput \ ReadCapac ityUnits=5,WriteCa pacityUnits=5 \ --resource-policy \ '{   "Version": "2012-10-17",   "Statement": [     {       "Sid": "Statement1",       "Effect": "Allow",       "Principa l": {         "AWS": "arn:aws:iam::&lt;Acc ount-B-ID&gt;:role/&lt;R ole-Name&gt;"       }, </pre>	

Task	Description	Skills required
	<pre data-bbox="592 205 1031 661">        "Action":         "dynamodb:PutItem",         "Resource ": "arn:aws:dynamodb: &lt;Region&gt;:&lt;Account- A-ID&gt;:table/Table- Account-A"     }   ] }'</pre> <p data-bbox="592 703 1003 787">Replace the following in this code sample:</p> <ul data-bbox="592 829 1003 1470" style="list-style-type: none"><li>• &lt;Account-B-ID&gt; is the ID of Account B.</li><li>• &lt;Role-Name&gt; is the name of the IAM role that you created, such as DynamoDB-PutItemAccess .</li><li>• &lt;Region&gt; is the AWS Region where you are creating the DynamoDB table.</li><li>• &lt;Account-A-ID&gt; is the ID of Account A.</li></ul> <p data-bbox="592 1543 1019 1818"><b>Note:</b> You specify the resource-based policy configuration in the create-table statement by using the --resource-policy flag. This policy refers to the</p>	

Task	Description	Skills required
	<p>ARN for the DynamoDB table in Account A.</p> <p>For more information about creating tables, see the <a href="#">DynamoDB documentation</a>.</p>	

## Create a Lambda function in Account B

Task	Description	Skills required
Create a Lambda function to write data to DynamoDB.	<ol style="list-style-type: none"> <li>1. Sign in to Account B in the AWS Management Console.</li> <li>2. Open the <a href="#">Lambda console</a>.</li> <li>3. In the navigation pane, choose <b>Functions</b>, and then choose <b>Create function</b>.</li> <li>4. For <b>Name</b>, enter <code>lambda_write_function</code>.</li> <li>5. For <b>Runtime</b>, choose <b>Python 3.8</b> or later.</li> <li>6. Under <b>Change default execution role</b>, choose <b>Use an existing role</b>.</li> <li>7. For <b>Existing role</b>, choose the IAM role that you created, such as <code>DynamoDB-PutItemAccess</code>.</li> <li>8. Choose <b>Create function</b>.</li> </ol>	General AWS



Task	Description	Skills required
	<p>9. In the <b>Code</b> tab, paste the sample code that is provided in the <a href="#">Additional information</a> section of this pattern. Replace the following in this code sample:</p> <ul style="list-style-type: none"><li>• <code>&lt;Account-A-ID&gt;</code> is the ID of Account A.</li><li>• <code>&lt;Region&gt;</code> is the AWS Region where you created the DynamoDB table.</li></ul> <p>10 Choose <b>Deploy</b>.</p> <p>11 Choose <b>Test</b>. This prompts you to configure a test event. Create a new event with your preferred name, such as <code>MyTestEventForWrite</code>, and then save the configuration.</p> <p>12 Choose <b>Test</b> again. This runs the Lambda function with the event name you provided.</p> <p>13 Check the output from the function. It should indicate that the function accessed the DynamoDB table in Account A and was able to write data to it.</p>	

Task	Description	Skills required
	For more information about creating Lambda functions, see the <a href="#">Lambda documentation</a> .	

## Clean up

Task	Description	Skills required
Delete resources.	<p>To avoid incurring costs associated with the resources created in this pattern, do the following to delete these resources:</p> <ol style="list-style-type: none"> <li>1. In Account B, delete the Lambda function you created to connect to DynamoDB. For instructions, see the <a href="#">Lambda documentation</a>.</li> <li>2. In Account A, delete the DynamoDB table you created. For instructions, see the <a href="#">DynamoDB documentation</a>.</li> <li>3. For security best practices, delete the IAM policy (DynamoDB-PutItem-Policy) when it is no longer needed. For more information, see the <a href="#">IAM documentation</a>.</li> </ol>	General AWS

Task	Description	Skills required
	4. For security best practices , delete the IAM role (DynamoDB-PutItemAccess ) when it is no longer needed. For more information, see the <a href="#">IAM documentation</a> .	

## Troubleshooting

Issue	Solution
When creating the Lambda function, you receive a ResourceNotFoundException error.	Confirm that you have correctly entered the AWS Region and ID of Account A. These are part of the ARN for the DynamoDB table.

## Related resources

- [Getting started with DynamoDB](#) (DynamoDB documentation)
- [Getting started with Lambda](#) (Lambda documentation)
- [Using resource-based policies for DynamoDB](#) (DynamoDB documentation)
- [Creating IAM policies](#) (IAM documentation)
- [Cross-account policy evaluation logic](#) (IAM documentation)
- [IAM JSON policy elements reference](#) (IAM documentation)

## Additional information

### Sample code

```
import boto3
from datetime import datetime

dynamodb_client = boto3.client('dynamodb')
```

```
def lambda_handler(event, context):
    now = datetime.now().isoformat()
    data = dynamodb_client.put_item(TableName='arn:aws:dynamodb:<Region>:<Account-
A-ID>:table/Table-Account-A', Item={"category": {"S": "Fruit"},"item": {"S":
"Apple"},"time": {"S": now}})
    return data
```

**Note:** When the DynamoDB client is instantiated, the ARN of the DynamoDB table is provided instead of the table name. This is required so that the Lambda function connects to the correct DynamoDB table when it runs.

# Configure read-only routing in an Always On availability group in SQL Server on AWS

Created by Subhani Shaik (AWS)

**Environment:** PoC or pilot

**Technologies:** Databases;  
Infrastructure

**Workload:** Microsoft

**AWS services:** AWS Managed  
Microsoft AD; Amazon EC2

## Summary

This pattern covers how to use the standby secondary replica in SQL Server Always On by offloading the read-only workloads from the primary replica to the secondary replica.

Database mirroring has one-to-one mapping. You can't read the secondary database directly, so you must create snapshots. The Always On availability group feature was introduced in Microsoft SQL Server 2012. In later versions, major functionalities have been introduced, including read-only routing. In Always On availability groups, you can read the data directly from the secondary replica by changing the replica mode to read-only.

The Always On availability groups solution supports high availability (HA), disaster recovery (DR), and an alternative to database mirroring. Always On availability groups work at the database level and maximize the availability of a set of user databases.

SQL Server uses the read-only routing mechanism to redirect the incoming read-only connections to the secondary read replica. To achieve this, you should add the following parameters and values in the connection string:

- `ApplicationIntent=ReadOnly`
- `Initial Catalog=<database name>`

## Prerequisites and limitations

### Prerequisites

- An active AWS account with a virtual private cloud (VPC), two Availability Zones, private subnets, and a security group
- Two Amazon Elastic Compute Cloud (Amazon EC2) machines with [SQL Server 2019 Enterprise Edition Amazon Machine Image](#) with [Windows Server Failover Clustering \(WSFC\)](#) configured at the instance level and an Always On availability group configured at the SQL Server level between the primary node (WSFCNODE1) and the secondary node (WSFCNODE2), which are part of the AWS Directory Service for Microsoft Active Directory directory named tagedtalk.com
- One or more nodes configured to accept read-only in the secondary replica
- A listener named SQLAG1 for the Always On availability group
- SQL Server Database Engine running with the same service account on two nodes
- SQL Server Management Studio (SSMS)
- A test database named test

## Product Versions

- SQL Server 2014 and later

## Architecture

### Target technology stack

- Amazon EC2
- AWS Managed Microsoft AD
- Amazon FSx

### Target architecture

The following diagram shows how the Always On availability group (AG) listener redirects queries that contain the `ApplicationIntent` parameter in the connection to the appropriate secondary node.

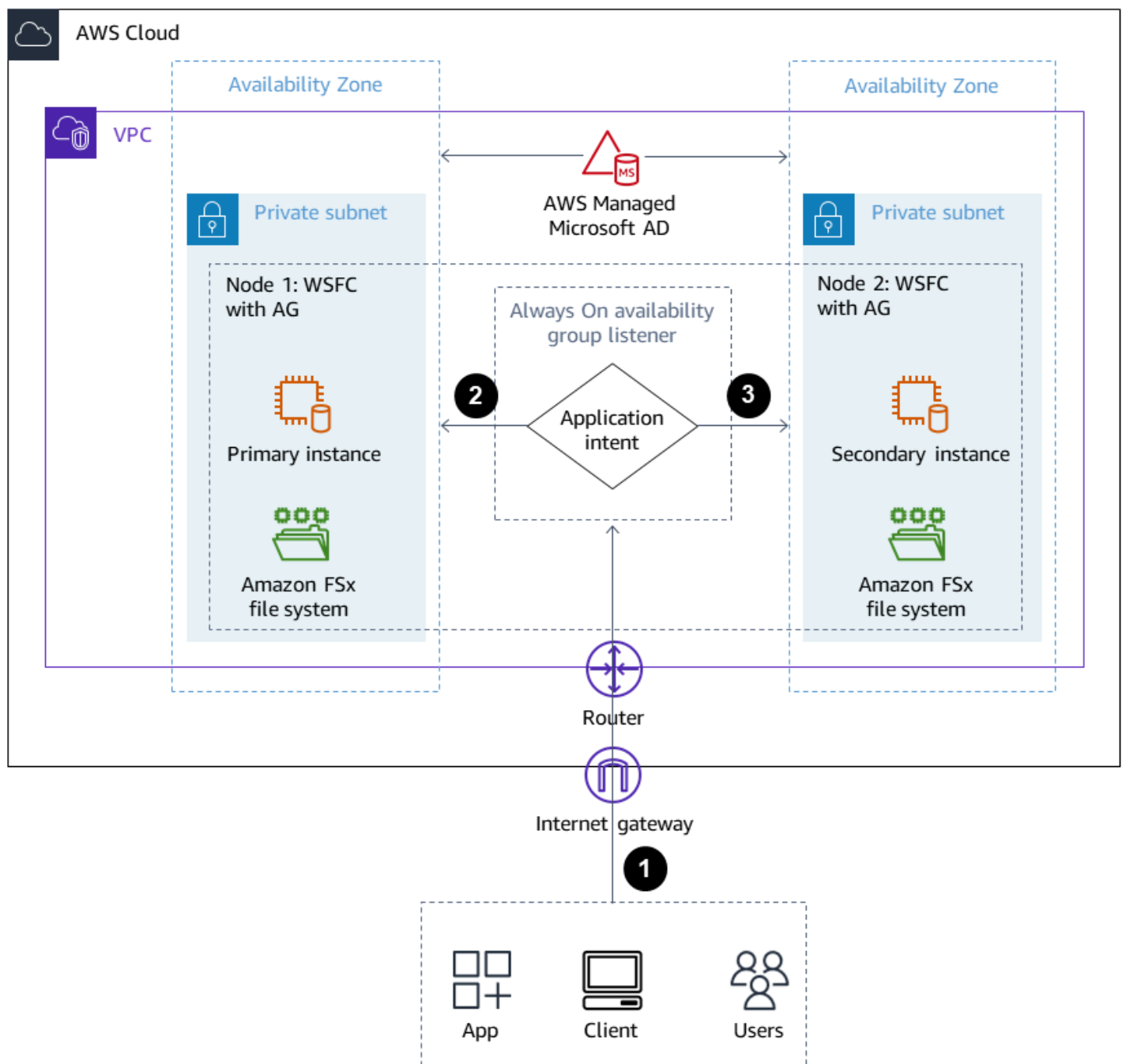

1. A request is sent to the Always On availability group listener.
2. If the connection string does not have the `ApplicationIntent` parameter, the request is sent to the primary instance.
3. If the connection string contains `ApplicationIntent=ReadOnly`, the request is sent to the secondary instance with read-only routing configuration, which is WSFC with an Always On availability group.

## Tools

### AWS services

- [AWS Directory Service for Microsoft Active Directory](#) enables your directory-aware workloads and AWS resources to use Microsoft Active Directory in the AWS Cloud.
- [Amazon Elastic Compute Cloud \(Amazon EC2\)](#) provides scalable computing capacity in the AWS Cloud. You can launch as many virtual servers as you need and quickly scale them up or down.
- [Amazon FSx](#) provides file systems that support industry-standard connectivity protocols and offer high availability and replication across AWS Regions.

### Other services

- SQL Server Management Studio (SSMS) is a tool for connecting, managing, and administering the SQL Server instances.
- sqlcmd is a command-line utility.

## Best practices

For more information about Always On availability groups, see the [SQL Server documentation](#).

## Epics

### Set up read-only routing

Task	Description	Skills required
Update the replicas to read-only.	To update both the primary and the secondary replica to read-only, connect to the primary replica from SSMS, and run the <i>Step 1</i> code from the <i>Additional information</i> section.	DBA
Create the routing URL.	To create routing URL for both replicas, run the <i>Step</i>	DBA



Task	Description	Skills required
	2 code from the <i>Additional information</i> section. In this code, tagechtalk.com is the name of the AWS Managed Microsoft AD directory.	
Create the routing list.	To create the routing list for both replicas, run the Step 3 code from the <i>Additional information</i> section.	DBA
Validate the routing list.	Connect to the primary instance from SQL Server Management Studio, and run the <i>Step 4</i> code from the <i>Additional information</i> section to validate the routing list.	DBA

### Test the read-only routing

Task	Description	Skills required
Connect by using the ApplicationIntent parameter.	<ol style="list-style-type: none"> <li>From SSMS, connect to the Always On availability group listener name with ApplicationIntent=ReadOnly;Initial Catalog=test .</li> <li>The connection is established with the secondary replica. To test this, run the following command to show the connected server name.</li> </ol>	DBA

Task	Description	Skills required
	<pre data-bbox="634 212 1029 369">SELECT SERVERPROPERTY('ComputernamePhysicalNetBios')</pre> <p data-bbox="630 407 997 537">The output will show the current secondary replica name (WSFCNODE2 ).</p>	

Task	Description	Skills required
Perform a failover.	<ol style="list-style-type: none"><li>1. From SSMS, connect to the Always On availability group listener name.</li><li>2. Verify that the primary and secondary database are in sync, with no data loss.</li><li>3. Perform a failover so that the current primary replica becomes the secondary replica, and the secondary replica becomes the primary replica.</li><li>4. From SSMS, connect to the Always On availability group listener name with <code>ApplicationIntent=ReadOnly;Initial Catalog=test</code> .</li><li>5. The connection is established with the secondary replica. To test this, show the connected server name by running the following command. <div data-bbox="630 1436 1029 1593" style="border: 1px solid #ccc; border-radius: 10px; padding: 10px; margin: 10px 0;"><pre>SELECT SERVERPROPERTY('ComputerNamePhysicalNetBios')</pre></div></li></ol> <p>It will display the current secondary replica name (WSFCNODE1 ).</p>	DBA

## Connect by using the sqlcmd command-line utility

Task	Description	Skills required
Connect by using sqlcmd.	<p>To connect from sqlcmd, run the <i>Step 5</i> code from the <i>Additional information</i> section at the command prompt. After you are connected, run the following command to show the connected server name.</p> <pre>SELECT SERVERPROPERTY('ComputerNamePhysicalNetBios') .</pre> <p>The output will display the current secondary replica name (WSFCNODE1 ).</p>	DBA

## Troubleshooting

Issue	Solution
Creating the listener fails with the message 'The WSFC cluster could not bring the Network Name resource online'.	For information, see the Microsoft blog post <a href="#">Create Listener Fails with Message 'The WSFC cluster could not bring the Network Name resource online'</a> .
Potential issues, including other listener issues or network access issues.	See <a href="#">Troubleshoot Always On Availability Groups Configuration (SQL Server)</a> in the Microsoft documentation.

## Related resources

- [Configure read-only routing for an Always On availability group](#)
- [Troubleshoot Always On Availability Groups Configuration \(SQL Server\)](#)

## Additional information

### Step 1. Update the replicas to read-only

```
ALTER AVAILABILITY GROUP [SQLAG1] MODIFY REPLICA ON N'WSFCNODE1' WITH (SECONDARY_ROLE
(ALLOW_CONNECTIONS = READ_ONLY))
GO
ALTER AVAILABILITY GROUP [SQLAG1] MODIFY REPLICA ON N'WSFCNODE2' WITH (SECONDARY_ROLE
(ALLOW_CONNECTIONS = READ_ONLY))
GO
```

### Step 2. Create the routing URL

```
ALTER AVAILABILITY GROUP [SQLAG1] MODIFY REPLICA ON N'WSFCNODE1' WITH (SECONDARY_ROLE
(READ_ONLY_ROUTING_URL = N'TCP://WSFCNode1.tagechtalk.com:1433'))
GO
ALTER AVAILABILITY GROUP [SQLAG1] MODIFY REPLICA ON N'WSFCNODE2' WITH (SECONDARY_ROLE
(READ_ONLY_ROUTING_URL = N'TCP://WSFCNode2.tagechtalk.com:1433'))
GO
```

### Step 3. Create the routing list

```
ALTER AVAILABILITY GROUP [SQLAG1] MODIFY REPLICA ON N'WSFCNODE1' WITH
(PRIMARY_ROLE(READ_ONLY_ROUTING_LIST=('WSFCNODE2', 'WSFCNODE1')));
GO
ALTER AVAILABILITY GROUP [SQLAG1] MODIFY REPLICA ON N'WSFCNODE2' WITH (PRIMARY_ROLE
(READ_ONLY_ROUTING_LIST=('WSFCNODE1', 'WSFCNODE2')));
GO
```

### Step 4. Validate the routing list

```
SELECT AGSrc.replica_server_name AS PrimaryReplica, AGRepl.replica_server_name AS
ReadOnlyReplica, AGRepl.read_only_routing_url AS RoutingURL , AGRL.routing_priority
AS RoutingPriority FROM sys.availability_read_only_routing_lists AGRL INNER JOIN
sys.availability_replicas AGSrc ON AGRL.replica_id = AGSrc.replica_id INNER JOIN
```

```
sys.availability_replicas AGRepl ON AGRL.read_only_replica_id = AGRepl.replica_id  
INNER JOIN sys.availability_groups AV ON AV.group_id = AGSrc.group_id ORDER BY  
PrimaryReplica
```

## Step 5. SQL Command Utility

```
sqlcmd -S SQLAG1,1433 -E -d test -K ReadOnly
```

# Connect by using an SSH tunnel in pgAdmin

Created by Jeevan Shetty (AWS) and Bhanu Ganesh Gudivada (AWS)

**Environment:** Production

**Technologies:** Databases;  
Security, identity, compliance

**Workload:** Open-source

**AWS services:** Amazon RDS;  
Amazon Aurora

## Summary

For security reasons, it's always good to place databases in a private subnet. Queries against the database can be run by connecting through an Amazon Elastic Compute Cloud (Amazon EC2) bastion host in a public subnet on the Amazon Web Services (AWS) Cloud. This requires installing software, such as pgAdmin or DBeaver, which are commonly used by developers or database administrators, on the Amazon EC2 host.

Running pgAdmin on a Linux server and accessing it through a web browser requires the installation of additional dependencies, permissions setup, and configuration.

As an alternate solution, developers or database administrators can connect to a PostgreSQL database by using pgAdmin to enable an SSH tunnel from their local system. In this approach, pgAdmin uses the Amazon EC2 host in the public subnet as an intermediary host before connecting to the database. The diagram in the *Architecture* section shows the setup.

**Note:** Ensure that the security group attached to the PostgreSQL database allows connection on port 5432 from the Amazon EC2 host.

## Prerequisites and limitations

### Prerequisites

- An existing AWS account
- A virtual private cloud (VPC) with a public subnet and a private subnet
- An EC2 instance with a security group attached

- An Amazon Aurora PostgreSQL-Compatible Edition database with a security group attached
- A Secure Shell (SSH) key pair for setting up the tunnel

## Product versions

- pgAdmin version 6.2+
- Amazon Aurora PostgreSQL-Compatible Edition version 12.7+

## Architecture

### Target technology stack

- Amazon EC2
- Amazon Aurora PostgreSQL-Compatible

### Target architecture

The following diagram shows using pgAdmin with an SSH tunnel to connect through an internet gateway to the EC2 instance, which connects to the database.

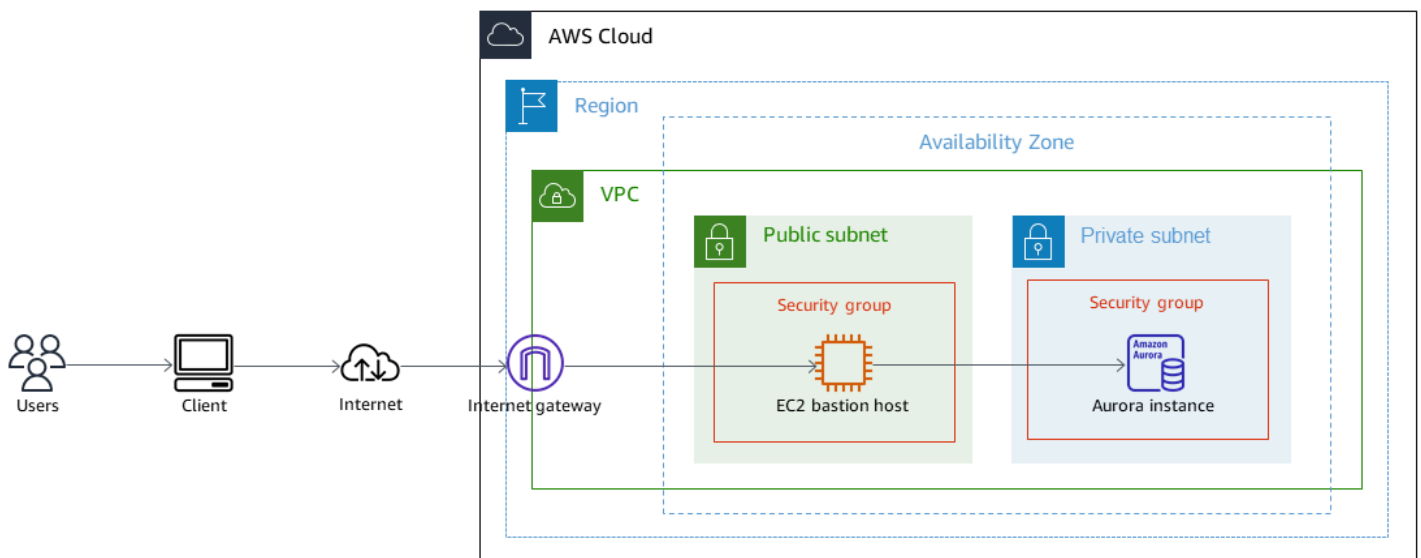

## Tools

### AWS services



- [Amazon Aurora PostgreSQL-Compatible Edition](#) is a fully managed, ACID-compliant relational database engine that helps you set up, operate, and scale PostgreSQL deployments.
- [Amazon Elastic Compute Cloud \(Amazon EC2\)](#) provides scalable computing capacity in the AWS Cloud. You can launch as many virtual servers as you need and quickly scale them up or down.

## Other services

- [pgAdmin](#) is an open-source management tool for PostgreSQL. It provides a graphical interface that helps you create, maintain, and use database objects.

## Epics

### Create the connection

Task	Description	Skills required
Create a server.	In pgAdmin, choose <b>Create</b> , and then choose <b>Server</b> . For additional help with setting up pgAdmin to register a server, configure a connection, and connect through SSH tunneling by using the Server Dialog, see the links in the <i>Related resources</i> section.	DBA
Provide a name for the server.	On the <b>General</b> tab, enter a name.	DBA
Enter the database details.	On the <b>Connection</b> tab, enter values for the following: <ul style="list-style-type: none"> <li>• <b>Host name/address</b></li> <li>• <b>Port</b></li> <li>• <b>Maintenance database</b></li> <li>• <b>Username</b></li> </ul>	DBA

Task	Description	Skills required
	<ul style="list-style-type: none"><li data-bbox="592 212 766 243">• Password</li></ul>	

Task	Description	Skills required
Enter the Amazon EC2 server details.	<p>On the <b>SSH Tunnel</b> tab, provide the details of the Amazon EC2 instance that is in the public subnet.</p> <ul style="list-style-type: none"><li>• Set <b>Use SSH tunneling</b> to <b>Yes</b> to specify that pgAdmin should use an SSH tunnel when connecting to the specified server.</li><li>• In the <b>Tunnel host</b> field, specify the name or IP address of the SSH host (for example, 10.x.x.x).</li><li>• In the <b>Tunnel port</b> field, specify the port of the SSH host (for example, 22).</li><li>• In the <b>Username</b> field, specify the name of a user with login privileges for the SSH host (for example, ec2-user).</li><li>• Specify the type of authentication as <b>Identity file</b> so that pgAdmin will use a private key file when connecting.</li><li>• Include the location of the Privacy Enhanced Mail (PEM) file in the <b>Identity file</b> field. The .pem file is the Amazon EC2 key pair.</li></ul>	DBA

Task	Description	Skills required
Save and connect.	Choose <b>Save</b> to complete the setup and connect to the Aurora PostgreSQL-Compatible database by using the SSH tunnel.	DBA

## Related resources

- [Server Dialog](#)
- [Connect to Server](#)

# Convert JSON Oracle queries into PostgreSQL database SQL

Created by Pinesh Singal (AWS) and Lokesh Gurram (AWS)

<b>Environment:</b> PoC or pilot	<b>Source:</b> Databases: Relational	<b>Target:</b> Amazon RDS PostgreSQL
<b>R Type:</b> Re-architect	<b>Workload:</b> Oracle	<b>Technologies:</b> Databases; Migration
<b>AWS services:</b> Amazon Aurora; Amazon RDS		

## Summary

This migration process for moving from on-premises to the Amazon Web Services (AWS) Cloud uses the AWS Schema Conversion Tool (AWS SCT) to convert the code from an Oracle database into a PostgreSQL database. Most of the code is automatically converted by AWS SCT. However, JSON-related Oracle queries are not automatically converted.

Starting from Oracle 12.2 version, Oracle Database supports various JSON functions that help in converting JSON-based data into ROW-based data. However, AWS SCT doesn't automatically convert JSON-based data into language that is supported by PostgreSQL.

This migration pattern primarily focuses on manually converting the JSON-related Oracle queries with functions such as `JSON_OBJECT`, `JSON_ARRAYAGG`, and `JSON_TABLE` from an Oracle database to a PostgreSQL database.

## Prerequisites and limitations

### Prerequisites

- An active AWS account
- An on-premises Oracle database instance (up and running)
- An Amazon Relational Database Service (Amazon RDS) for PostgreSQL or Amazon Aurora PostgreSQL-Compatible Edition database instance (up and running)

## Limitations

- JSON-related queries require a fixed KEY and VALUE format. Not using that format returns the wrong result.
- If any change in JSON structure adds new KEY and VALUE pairs in the result section, the corresponding procedure or function must be changed in the SQL query.
- Some JSON-related functions are supported in earlier versions of Oracle and PostgreSQL but with fewer capabilities.

## Product versions

- Oracle Database version 12.2 and later
- Amazon RDS for PostgreSQL or Aurora PostgreSQL-Compatible version 9.5 and later
- AWS SCT latest version (tested using version 1.0.664)

## Architecture

### Source technology stack

- An Oracle database instance with version 19c

### Target technology stack

- An Amazon RDS for PostgreSQL or Aurora PostgreSQL-Compatible database instance with version 13

### Target architecture

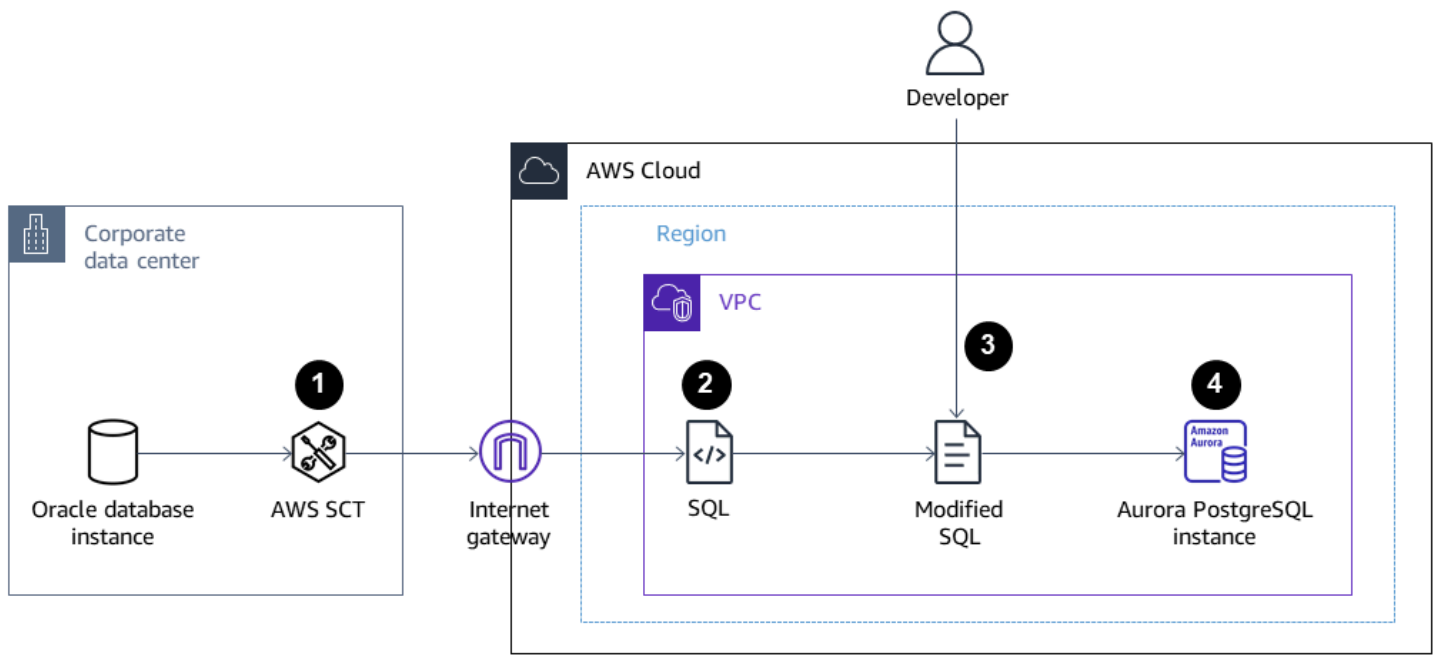

1. Use AWS SCT with the JSON function code to convert the source code from Oracle to PostgreSQL.
2. The conversion produces PostgreSQL-supported migrated .sql files.
3. Manually convert the non-converted Oracle JSON function codes to PostgreSQL JSON function codes.
4. Run the .sql files on the target Aurora PostgreSQL-Compatible DB instance.

## Tools

### AWS services

- [Amazon Aurora](#) is a fully managed relational database engine that's built for the cloud and compatible with MySQL and PostgreSQL.
- [Amazon Relational Database Service \(Amazon RDS\) for PostgreSQL](#) helps you set up, operate, and scale a PostgreSQL relational database in the AWS Cloud.
- [AWS Schema Conversion Tool \(AWS SCT\)](#) supports heterogeneous database migrations by automatically converting the source database schema and a majority of the custom code to a format that's compatible with the target database.

### Other services

- [Oracle SQL Developer](#) is an integrated development environment that simplifies the development and management of Oracle databases in both traditional and cloud-based deployments.
- pgAdmin or DBeaver. [pgAdmin](#) is an open-source management tool for PostgreSQL. It provides a graphical interface that helps you create, maintain, and use database objects. [DBeaver](#) is a universal database tool.

## Best practices

Oracle query has type CAST as the default when using the JSON\_TABLE function. A best practice is to use CAST in PostgreSQL too, using double greater-than characters (>>).

For more information, see *Postgres\_SQL\_Read\_JSON* in the *Additional information* section.

## Epics

### Generate the JSON data in the Oracle and PostgreSQL databases

Task	Description	Skills required
Store the JSON data in the Oracle database.	Create a table in the Oracle database, and store the JSON data in the CLOB column. Use the <i>Oracle_Table_Creation_Insert_Script</i> that's in the <i>Additional information</i> section.	Migration engineer
Store the JSON data in the PostgreSQL database.	Create a table in the PostgreSQL database, and store the JSON data in the TEXT column. Use the <i>Postgres_Table_Creation_Insert_Script</i> that's in the <i>Additional information</i> section.	Migration engineer



## Convert the JSON into ROW format

Task	Description	Skills required
Convert the JSON data on the Oracle database.	Write an Oracle SQL query to read the JSON data into ROW format. For more details and example syntax, see <i>Oracle_SQL_Read_JSON</i> in the <i>Additional information</i> section.	Migration engineer
Convert the JSON data on the PostgreSQL database.	Write a PostgreSQL query to read the JSON data into ROW format. For more details and example syntax, see <i>Postgres_SQL_Read_JSON</i> in the <i>Additional information</i> section.	Migration engineer

## Manually convert the JSON data using the SQL query and report the output in JSON format

Task	Description	Skills required
Perform aggregations and validation on the Oracle SQL query.	<p>To manually convert the JSON data, perform a join, aggregation, and validation on the Oracle SQL query, and report the output in JSON format. Use the code under <i>Oracle_SQL_Read_JSON_Aggregation_Join</i> in the <i>Additional information</i> section.</p> <ol style="list-style-type: none"> <li>1. JOIN – The JSON-formatted data is passed as an</li> </ol>	Migration engineer

Task	Description	Skills required
	<p>input parameter to the query. An inner JOIN is made between this static data and the JSON data in the Oracle DB table <code>aws_test_table</code> .</p> <p>2. Aggregation with validation – The JSON data has KEY and VALUE parameters with values such as <code>accountNumber</code> , <code>parentAccountNumber</code> , <code>businessUnitId</code> and <code>positionId</code> , which are used for SUM and COUNT aggregations.</p> <p>3. JSON format – After the join and the aggregation, the data is reported in JSON format by using <code>JSON_OBJECT</code> and <code>JSON_ARRAYAGG</code> .</p>	

Task	Description	Skills required
Perform aggregations and validation on the Postgres SQL query.	<p>To manually convert the JSON data, perform a join, aggregation, and validation on the PostgreSQL query, and report the output in JSON format. Use the code under <i>Postgres_SQL_JSON_Aggregation_Join</i> in the <i>Additional information</i> section.</p> <ol style="list-style-type: none"><li>1. JOIN – The JSON-formatted data (tab1) is passed as an input parameter to the WITH clause query. A JOIN is made between this static data and the JSON data, which is in the tab table. A JOIN is also made with the WITH clause, which has JSON data in the aws_test_pg_table table.</li><li>2. Aggregation – The JSON data has KEY and VALUE parameters with values such as accountNumber , parentAccountNumber , businessUnitId , and positionId , which are used for the SUM and COUNT aggregations.</li><li>3. JSON format – After the join and the aggregati</li></ol>	Migration engineer

Task	Description	Skills required
	on, the data is reported in JSON format by using <code>JSON_BUILD_OBJECT</code> and <code>JSON_AGG</code> .	

## Convert the Oracle procedure into a PostgreSQL function that contains JSON queries

Task	Description	Skills required
Convert the JSON queries in the Oracle procedure into rows.	For the example Oracle procedure, use the previous Oracle query and the code under <i>Oracle_procedure_with_JSON_Query</i> in the <i>Additional information</i> section.	Migration engineer
Convert the PostgreSQL functions that have JSON queries into row-based data.	For the example PostgreSQL functions, use the previous PostgreSQL query and the code that's under <i>Postgres_function_with_JSON_Query</i> in the <i>Additional information</i> section.	Migration engineer

## Related resources

- [Oracle JSON functions](#)
- [PostgreSQL JSON functions](#)
- [Oracle JSON Functions Examples](#)
- [PostgreSQL JSON function examples](#)
- [AWS Schema Conversion Tool](#)

## Additional information

To convert JSON code from the Oracle database to PostgreSQL database, use the following scripts, in order.

### 1. Oracle\_Table\_Creation\_Insert\_Script

```
create table aws_test_table(id number,created_on date default sysdate,modified_on
date,json_doc clob);

REM INSERTING into EXPORT_TABLE
SET DEFINE OFF;
Insert into aws_test_table (ID,CREATED_ON,MODIFIED_ON,json_doc)
values (1,to_date('02-AUG-2022 12:30:14','DD-MON-YYYY HH24:MI:SS'),to_date('02-AUG-2022
12:30:14','DD-MON-YYYY HH24:MI:SS'),TO_CLOB(q'[{
  "metadata" : {
    "upperLastNameFirstName" : "ABC XYZ",
    "upperEmailAddress" : "abc@gmail.com",
    "profileType" : "P"
  },
  "data" : {
    "onlineContactId" : "032323323",
    "displayName" : "Abc, Xyz",
    "firstName" : "Xyz",
    "lastName" : "Abc",
    "emailAddress" : "abc@gmail.com",
    "productRegistrationStatus" : "Not registered",
    "positionId" : "0100",
    "arrayPattern" : " -'",
    "a]')
|| TO_CLOB(q'[ccount" : {
  "companyId" : "SMGE",
  "businessUnitId" : 7,
  "accountNumber" : 42000,
  "parentAccountNumber" : 32000,
  "firstName" : "john",
  "lastName" : "doe",
  "street1" : "ret0dertcaShr ",
  "city" : "new york",
  "postalcode" : "XY ABC",
  "country" : "United States"
},
"products" : [
```

```

        {
            "appUserGuid" : "i0acc4450000001823fbad478e2eab8a0",
            "id" : "0000000046",
        ]')
|| TO_CLOB(q'[
            "name" : "ProView",
            "domain" : "EREADER",
            "registrationStatus" : false,
            "status" : "11"
        ]
    ]
}
}]')));
Insert into aws_test_table (ID,CREATED_ON,MODIFIED_ON,json_doc) values (2,to_date('02-
AUG-2022 12:30:14','DD-MON-YYYY HH24:MI:SS'),to_date('02-AUG-2022 12:30:14','DD-MON-
YYYY HH24:MI:SS'),TO_CLOB(q'[{
    "metadata" : {
        "upperLastNameFirstName" : "PQR XYZ",
        "upperEmailAddress" : "pqr@gmail.com",
        "profileType" : "P"
    },
    "data" : {
        "onlineContactId" : "54534343",
        "displayName" : "Xyz, pqr",
        "firstName" : "pqr",
        "lastName" : "Xyz",
        "emailAddress" : "pqr@gmail.com",
        "productRegistrationStatus" : "Not registered",
        "positionId" : "0090",
        "arrayPattern" : " -'",
        "account" : {
            "companyId" : "CARS",
            "busin]')
|| TO_CLOB(q'[essUnitId" : 6,
    "accountNumber" : 42001,
    "parentAccountNumber" : 32001,
    "firstName" : "terry",
    "lastName" : "whitlock",
    "street1" : "U0 123",
    "city" : "TOTORON",
    "region" : "NO",
    "postalcode" : "LKM 111",
    "country" : "Canada"
},
    "products" : [

```

```

    {
      "appUserGuid" : "ia744d7790000016899f8cf3f417d6df6",
      "id" : "0000000014",
      "name" : "ProView eLooseleaf",
    ]')
|| TO_CLOB(q'[ "domain" : "EREADER",
      "registrationStatus" : false,
      "status" : "11"
    ]
  ]
}
}]')));

commit;

```

## 2. Postgres\_Table\_Creation\_Insert\_Script

```

create table aws_test_pg_table(id int,created_on date ,modified_on date,json_doc text);
insert into aws_test_pg_table(id,created_on,modified_on,json_doc)
values(1,now(),now(),'{
  "metadata" : {
    "upperLastNameFirstName" : "ABC XYZ",
    "upperEmailAddress" : "abc@gmail.com",
    "profileType" : "P"
  },
  "data" : {
    "onlineContactId" : "032323323",
    "displayName" : "Abc, Xyz",
    "firstName" : "Xyz",
    "lastName" : "Abc",
    "emailAddress" : "abc@gmail.com",
    "productRegistrationStatus" : "Not registered",
    "positionId" : "0100",
    "arrayPattern" : " -",
    "account" : {
      "companyId" : "SMGE",
      "businessUnitId" : 7,
      "accountNumber" : 42000,
      "parentAccountNumber" : 32000,
      "firstName" : "john",
      "lastName" : "doe",
      "street1" : "ret0dertcaShr ",
      "city" : "new york",

```

```
    "postalcode" : "XY ABC",
    "country" : "United States"
  },
  "products" : [
    {
      "appUserGuid" : "i0acc4450000001823fbad478e2eab8a0",
      "id" : "0000000046",
      "name" : "ProView",
      "domain" : "EREADER",
      "registrationStatus" : false,
      "status" : "11"
    }
  ]
}
}');
```

```
insert into aws_test_pg_table(id,created_on,modified_on,json_doc)
values(2,now(),now(),'{
  "metadata" : {
    "upperLastNameFirstName" : "PQR XYZ",
    "upperEmailAddress" : "pqr@gmail.com",
    "profileType" : "P"
  },
  "data" : {
    "onlineContactId" : "54534343",
    "displayName" : "Xyz, pqr",
    "firstName" : "pqr",
    "lastName" : "Xyz",
    "emailAddress" : "a*b**@h**.k**",
    "productRegistrationStatus" : "Not registered",
    "positionId" : "0090",
    "arrayPattern" : " -",
    "account" : {
      "companyId" : "CARS",
      "businessUnitId" : 6,
      "accountNumber" : 42001,
      "parentAccountNumber" : 32001,
      "firstName" : "terry",
      "lastName" : "whitlock",
      "street1" : "U0 123",
      "city" : "TOTORON",
      "region" : "NO",
      "postalcode" : "LKM 111",
```



```

    "country" : "Canada"
  },
  "products" : [
    {
      "appUserGuid" : "ia744d7790000016899f8cf3f417d6df6",
      "id" : "0000000014",
      "name" : "ProView eLooseleaf",
      "domain" : "EREADER",
      "registrationStatus" : false,
      "status" : "11"
    }
  ]
}
}');

```

### 3. Oracle\_SQL\_Read\_JSON

The following code blocks show how to convert Oracle JSON data into row format.

#### *Example query and syntax*

```

SELECT  JSON_OBJECT(
  'accountCounts' VALUE JSON_ARRAYAGG(
    JSON_OBJECT(
      'businessUnitId' VALUE business_unit_id,
      'parentAccountNumber' VALUE parent_account_number,
      'accountNumber' VALUE account_number,
      'totalOnlineContactsCount' VALUE online_contacts_count,
      'countByPosition' VALUE
        JSON_OBJECT(
          'taxProfessionalCount' VALUE tax_count,
          'attorneyCount' VALUE attorney_count,
          'nonAttorneyCount' VALUE non_attorney_count,
          'clerkCount' VALUE clerk_count
        ) ) ) ) FROM
  (SELECT  tab_data.business_unit_id,
    tab_data.parent_account_number,
    tab_data.account_number,
    SUM(1) online_contacts_count,
    SUM(CASE WHEN tab_data.position_id = '0095' THEN 1 ELSE 0 END) tax_count,
    SUM(CASE  WHEN tab_data.position_id = '0100' THEN 1 ELSE 0 END)
attorney_count,
    SUM(CASE  WHEN tab_data.position_id = '0090' THEN 1 ELSE 0 END)
non_attorney_count,

```

```

SUM(CASE WHEN tab_data.position_id = '0050' THEN 1 ELSE 0 END)
clerk_count
FROM aws_test_table scco,JSON_TABLE ( json_doc, '$' ERROR ON ERROR
COLUMNS (
  parent_account_number NUMBER PATH
    '$.data.account.parentAccountNumber',
  account_number NUMBER PATH '$.data.account.accountNumber',
  business_unit_id NUMBER PATH '$.data.account.businessUnitId',
  position_id VARCHAR2 ( 4 ) PATH '$.data.positionId'
) AS tab_data
  INNER JOIN JSON_TABLE ( '{
"accounts": [{
  "accountNumber": 42000,
  "parentAccountNumber": 32000,
  "businessUnitId": 7
}, {
  "accountNumber": 42001,
  "parentAccountNumber": 32001,
  "businessUnitId": 6
}]
}', '$.accounts[*]' ERROR ON ERROR
COLUMNS (
  parent_account_number PATH '$.parentAccountNumber',
  account_number PATH '$.accountNumber',
  business_unit_id PATH '$.businessUnitId')
) static_data
ON ( static_data.parent_account_number = tab_data.parent_account_number
  AND static_data.account_number = tab_data.account_number
  AND static_data.business_unit_id = tab_data.business_unit_id )
GROUP BY
  tab_data.business_unit_id,
  tab_data.parent_account_number,
  tab_data.account_number );

```

The JSON document stores the data as collections. Each collection can have KEY and VALUE pairs. Every VALUE can have nested KEY and VALUE pairs. The following table provides information about reading the specific VALUE from the JSON document.

KEY	HIERARCHY or PATH to be used to get the VALUE	VALUE
profileType	metadata -> profileType	"P"

positionId	data -> positionId	"0100"
accountNumber	data -> account -> accountNumber	42000

In the previous table, the KEY profileType is a VALUE of the metadata KEY. The KEY positionId is a VALUE of the data KEY. The KEY accountNumber is a VALUE of the account KEY, and the account KEY is a VALUE of the data KEY.

### Example JSON document

```
{
  "metadata" : {
    "upperLastNameFirstName" : "ABC XYZ",
    "upperEmailAddress" : "abc@gmail.com",
    "profileType" : "P"
  },
  "data" : {
    "onlineContactId" : "032323323",
    "displayName" : "Abc, Xyz",
    "firstName" : "Xyz",
    "lastName" : "Abc",
    "emailAddress" : "abc@gmail.com",
    "productRegistrationStatus" : "Not registered",
    "positionId" : "0100",
    "arrayPattern" : " -",
    "account" : {
      "companyId" : "SMGE",
      "businessUnitId" : 7,
      "accountNumber" : 42000,
      "parentAccountNumber" : 32000,
      "firstName" : "john",
      "lastName" : "doe",
      "street1" : "ret0dertcaShr ",
      "city" : "new york",
      "postalcode" : "XY ABC",
      "country" : "United States"
    },
    "products" : [
      {
        "appUserGuid" : "i0acc4450000001823fbad478e2eab8a0",
```

```

        "id" : "0000000046",
        "name" : "ProView",
        "domain" : "EREADER",
        "registrationStatus" : false,
        "status" : "11"
    }
]
}
}

```

*SQL query that is used to get the selected fields from the JSON document*

```

select parent_account_number,account_number,business_unit_id,position_id from
  aws_test_table aws,JSON_TABLE ( json_doc, '$' ERROR ON ERROR
COLUMNS (
parent_account_number NUMBER PATH '$.data.account.parentAccountNumber',
account_number NUMBER PATH '$.data.account.accountNumber',
business_unit_id NUMBER PATH '$.data.account.businessUnitId',
position_id VARCHAR2 ( 4 ) PATH '$.data.positionId'
)) as sc

```

In the previous query, JSON\_TABLE is a built-in function in Oracle that converts the JSON data into row format. The JSON\_TABLE function expects parameters in JSON format.

Every item in COLUMNS has a predefined PATH, and there an appropriate VALUE for a given KEY is returned in row format.

*Result from the previous query*

<b>PARENT_AC COUNT_NUMBER</b>	<b>ACCOUNT_NUMBER</b>	<b>BUSINESS_UNIT_ID</b>	<b>POSITION_ID</b>
32000	42000	7	0100
32001	42001	6	0090

#### 4. Postgres\_SQL\_Read\_JSON

*Example query and syntax*

```
select *
```

```
from (  
select (json_doc::json->'data'->'account'->>'parentAccountNumber')::INTEGER as  
parentAccountNumber,  
(json_doc::json->'data'->'account'->>'accountNumber')::INTEGER as accountNumber,  
(json_doc::json->'data'->'account'->>'businessUnitId')::INTEGER as businessUnitId,  
(json_doc::json->'data'->>'positionId')::VARCHAR as positionId  
from aws_test_pg_table) d ;
```

In Oracle, PATH is used to identify the specific KEY and VALUE. However, PostgreSQL uses a HIERARCHY model for reading KEY and VALUE from JSON. The same JSON data mentioned under `Oracle_SQL_Read_JSON` is used in the following examples.

### *SQL query with type CAST not allowed*

(If you force type CAST, the query fails with a syntax error.)

```
select *  
from (  
select (json_doc::json->'data'->'account'->'parentAccountNumber') as  
parentAccountNumber,  
(json_doc::json->'data'->'account'->'accountNumber')as accountNumber,  
(json_doc::json->'data'->'account'->'businessUnitId') as businessUnitId,  
(json_doc::json->'data'->'positionId')as positionId  
from aws_test_pg_table) d ;
```

Using a single greater-than operator (>) will return the VALUE defined for that KEY. For example, KEY: `positionId`, and VALUE: `"0100"`.

Type CAST is not allowed when you use the single greater-than operator (>).

### *SQL query with type CAST allowed*

```
select *  
from (  
select (json_doc::json->'data'->'account'->>'parentAccountNumber')::INTEGER as  
parentAccountNumber,  
(json_doc::json->'data'->'account'->>'accountNumber')::INTEGER as accountNumber,  
(json_doc::json->'data'->'account'->>'businessUnitId')::INTEGER as businessUnitId,  
(json_doc::json->'data'->>'positionId')::varchar as positionId  
from aws_test_pg_table) d ;
```

To use type CAST, you must use the double greater-than operator. If you use the single greater-than operator, the query returns the VALUE defined (for example, KEY: positionId, and VALUE: "0100"). Using the double greater-than operator (>>) will return the actual value defined for that KEY (for example, KEY: positionId, and VALUE: 0100, without double quotation marks).

In the preceding case, parentAccountNumber is type CAST to INT, accountNumber is type CAST to INT, businessUnitId is type CAST to INT, and positionId is type CAST to VARCHAR.

The following tables show query results that explain role of the single greater-than operator (>) and the double greater-than operator (>>).

In the first table, the query uses the single greater-than operator (>). Each column is in JSON type and can't be converted into another data type.

<b>parentAccountNumber</b>	<b>accountNumber</b>	<b>businessUnitId</b>	<b>positionId</b>
2003565430	2003564830	7	"0100"
2005284042	2005284042	6	"0090"
2000272719	2000272719	1	"0100"

In the second table, the query uses the double greater-than operator (>>). Each column supports type CAST based on the column value. For example, INTEGER in this context.

<b>parentAccountNumber</b>	<b>accountNumber</b>	<b>businessUnitId</b>	<b>positionId</b>
2003565430	2003564830	7	0100
2005284042	2005284042	6	0090
2000272719	2000272719	1	0100

## 5. Oracle\_SQL\_JSON\_Aggregation\_Join

### *Example query*

```

SELECT
  JSON_OBJECT(
    'accountCounts' VALUE JSON_ARRAYAGG(
      JSON_OBJECT(
        'businessUnitId' VALUE business_unit_id,
        'parentAccountNumber' VALUE parent_account_number,
        'accountNumber' VALUE account_number,
        'totalOnlineContactsCount' VALUE online_contacts_count,
        'countByPosition' VALUE
          JSON_OBJECT(
            'taxProfessionalCount' VALUE tax_count,
            'attorneyCount' VALUE attorney_count,
            'nonAttorneyCount' VALUE non_attorney_count,
            'clerkCount' VALUE clerk_count
          ) ) ) )
FROM
  (SELECT
    tab_data.business_unit_id,
    tab_data.parent_account_number,
    tab_data.account_number,
    SUM(1) online_contacts_count,
    SUM(CASE WHEN tab_data.position_id = '0095' THEN 1 ELSE 0 END) tax_count,
    SUM(CASE WHEN tab_data.position_id = '0100' THEN 1 ELSE 0 END)
attorney_count,
    SUM(CASE WHEN tab_data.position_id = '0090' THEN 1 ELSE 0 END)
non_attorney_count,
    SUM(CASE WHEN tab_data.position_id = '0050' THEN 1 ELSE 0 END)
clerk_count
  FROM aws_test_table scco,JSON_TABLE ( json_doc, '$' ERROR ON ERROR
  COLUMNS (
    parent_account_number NUMBER PATH
    '$.data.account.parentAccountNumber',
    account_number NUMBER PATH '$.data.account.accountNumber',
    business_unit_id NUMBER PATH '$.data.account.businessUnitId',
    position_id VARCHAR2 ( 4 ) PATH '$.data.positionId'
  ) AS tab_data
  INNER JOIN JSON_TABLE ( '{
"accounts": [{
  "accountNumber": 42000,
  "parentAccountNumber": 32000,
  "businessUnitId": 7
}, {
  "accountNumber": 42001,

```

```
        "parentAccountNumber": 32001,
        "businessUnitId": 6
    ]}
}', '$.accounts[*]' ERROR ON ERROR
COLUMNS (
parent_account_number PATH '$.parentAccountNumber',
account_number PATH '$.accountNumber',
business_unit_id PATH '$.businessUnitId')
) static_data
ON ( static_data.parent_account_number = tab_data.parent_account_number
    AND static_data.account_number = tab_data.account_number
    AND static_data.business_unit_id = tab_data.business_unit_id )
GROUP BY
    tab_data.business_unit_id,
    tab_data.parent_account_number,
    tab_data.account_number
);
```

To convert the row-level data into JSON format, Oracle has built-in functions such as `JSON_OBJECT`, `JSON_ARRAY`, `JSON_OBJECTAGG`, and `JSON_ARRAYAGG`.

- `JSON_OBJECT` accepts two parameters: `KEY` and `VALUE`. The `KEY` parameter should be hardcoded or static in nature. The `VALUE` parameter is derived from table output.
- `JSON_ARRAYAGG` accepts `JSON_OBJECT` as a parameter. This helps in grouping the set of `JSON_OBJECT` elements as a list. For example, if you have a `JSON_OBJECT` element that has multiple records (multiple `KEY` and `VALUE` pairs in the dataset), `JSON_ARRAYAGG` appends the dataset and creates a list. According to the Data Structure language, `LIST` is group of elements. In this context, `LIST` is a group of `JSON_OBJECT` elements.

The following example shows one `JSON_OBJECT` element.

```
{
  "taxProfessionalCount": 0,
  "attorneyCount": 0,
  "nonAttorneyCount": 1,
  "clerkCount": 0
}
```

This next example shows two `JSON_OBJECT` elements, with `LIST` indicated by square braces (`[ ]`).



```
[
  {
    "taxProfessionalCount": 0,
    "attorneyCount": 0,
    "nonAttorneyCount": 1,
    "clerkCount": 0
  },
  {
    "taxProfessionalCount": 2,
    "attorneyCount": 1,
    "nonAttorneyCount": 3,
    "clerkCount": 4
  }
]
```

### Example SQL query

```
SELECT
  JSON_OBJECT(
    'accountCounts' VALUE JSON_ARRAYAGG(
      JSON_OBJECT(
        'businessUnitId' VALUE business_unit_id,
        'parentAccountNumber' VALUE parent_account_number,
        'accountNumber' VALUE account_number,
        'totalOnlineContactsCount' VALUE online_contacts_count,
        'countByPosition' VALUE
          JSON_OBJECT(
            'taxProfessionalCount' VALUE tax_count,
            'attorneyCount' VALUE attorney_count,
            'nonAttorneyCount' VALUE non_attorney_count,
            'clerkCount' VALUE clerk_count
          )
      )
    )
  )
FROM
  (SELECT
    tab_data.business_unit_id,
    tab_data.parent_account_number,
    tab_data.account_number,
    SUM(1) online_contacts_count,
    SUM(CASE WHEN tab_data.position_id = '0095' THEN 1 ELSE 0 END
```

```

        )      tax_count,
SUM(CASE    WHEN tab_data.position_id = '0100' THEN      1      ELSE
0 END
        )      attorney_count,

SUM(CASE    WHEN tab_data.position_id = '0090' THEN      1      ELSE
0 END
        )      non_attorney_count,

SUM(CASE    WHEN tab_data.position_id = '0050' THEN      1      ELSE
0 END
        )      clerk_count

FROM
aws_test_table scco, JSON_TABLE ( json_doc, '$' ERROR ON ERROR
COLUMNS (
parent_account_number NUMBER PATH '$.data.account.parentAccountNumber',
account_number NUMBER PATH '$.data.account.accountNumber',
business_unit_id NUMBER PATH '$.data.account.businessUnitId',
position_id VARCHAR2 ( 4 ) PATH '$.data.positionId'      )
) AS tab_data
INNER JOIN JSON_TABLE ( '{
"accounts": [{
"accountNumber": 42000,
"parentAccountNumber": 32000,
"businessUnitId": 7
}, {
"accountNumber": 42001,
"parentAccountNumber": 32001,
"businessUnitId": 6
}]
}', '$.accounts[*]' ERROR ON ERROR
COLUMNS (
parent_account_number PATH '$.parentAccountNumber',
account_number PATH '$.accountNumber',
business_unit_id PATH '$.businessUnitId')
) static_data ON ( static_data.parent_account_number =
tab_data.parent_account_number
AND static_data.account_number = tab_data.account_number

AND static_data.business_unit_id =
tab_data.business_unit_id )
GROUP BY
tab_data.business_unit_id,

```

```
        tab_data.parent_account_number,  
        tab_data.account_number  
    );
```

*Example output from the previous SQL query*

```
{  
  "accountCounts": [  
    {  
      "businessUnitId": 6,  
      "parentAccountNumber": 32001,  
      "accountNumber": 42001,  
      "totalOnlineContactsCount": 1,  
      "countByPosition": {  
        "taxProfessionalCount": 0,  
        "attorneyCount": 0,  
        "nonAttorneyCount": 1,  
        "clerkCount": 0  
      }  
    },  
    {  
      "businessUnitId": 7,  
      "parentAccountNumber": 32000,  
      "accountNumber": 42000,  
      "totalOnlineContactsCount": 1,  
      "countByPosition": {  
        "taxProfessionalCount": 0,  
        "attorneyCount": 1,  
        "nonAttorneyCount": 0,  
        "clerkCount": 0  
      }  
    }  
  ]  
}
```

## 6. Postgres\_SQL\_JSON\_Aggregation\_Join

The PostgreSQL built-in functions `JSON_BUILD_OBJECT` and `JSON_AGG` convert the ROW-level data into JSON format. PostgreSQL `JSON_BUILD_OBJECT` and `JSON_AGG` are equivalent to Oracle `JSON_OBJECT` and `JSON_ARRAYAGG`.

*Example query*

```

select
JSON_BUILD_OBJECT ('accountCounts',
  JSON_AGG(
    JSON_BUILD_OBJECT ('businessUnitId',businessUnitId
    , 'parentAccountNumber',parentAccountNumber
    , 'accountNumber',accountNumber
    , 'totalOnlineContactsCount',online_contacts_count,
    'countByPosition',
      JSON_BUILD_OBJECT (
        'taxProfessionalCount',tax_professional_count
        , 'attorneyCount',attorney_count
        , 'nonAttorneyCount',non_attorney_count
        , 'clerkCount',clerk_count
      )
    )
  )
)
from (
with tab as (select * from (
select (json_doc::json->'data'->'account'->>'parentAccountNumber')::INTEGER as
parentAccountNumber,
(json_doc::json->'data'->'account'->>'accountNumber')::INTEGER as accountNumber,
(json_doc::json->'data'->'account'->>'businessUnitId')::INTEGER as businessUnitId,
(json_doc::json->'data'->>'positionId')::varchar as positionId
from aws_test_pg_table) a ) ,
tab1 as ( select
(json_array_elements(b.jc -> 'accounts') ->> 'accountNumber')::integer accountNumber,
(json_array_elements(b.jc -> 'accounts') ->> 'businessUnitId')::integer
businessUnitId,
(json_array_elements(b.jc -> 'accounts') ->> 'parentAccountNumber')::integer
parentAccountNumber
from (
select '{
  "accounts": [{
    "accountNumber": 42001,
    "parentAccountNumber": 32001,
    "businessUnitId": 6
  }, {
    "accountNumber": 42000,
    "parentAccountNumber": 32000,
    "businessUnitId": 7
  }]
}'::json as jc) b)

```

```

select
tab.businessUnitId::text,
tab.parentAccountNumber::text,
tab.accountNumber::text,
SUM(1) online_contacts_count,
SUM(CASE WHEN tab.positionId::text = '0095' THEN 1 ELSE 0 END)
  tax_professional_count,
SUM(CASE WHEN tab.positionId::text = '0100' THEN 1 ELSE 0 END)      attorney_count,
SUM(CASE WHEN tab.positionId::text = '0090' THEN      1 ELSE      0 END)
  non_attorney_count,
SUM(CASE WHEN tab.positionId::text = '0050' THEN      1 ELSE      0 END)
  clerk_count
from tab1,tab
where tab.parentAccountNumber::INTEGER=tab1.parentAccountNumber::INTEGER
and tab.accountNumber::INTEGER=tab1.accountNumber::INTEGER
and tab.businessUnitId::INTEGER=tab1.businessUnitId::INTEGER
GROUP BY      tab.businessUnitId::text,
              tab.parentAccountNumber::text,
              tab.accountNumber::text) a;

```

*Example output from the preceding query*

Output from Oracle and PostgreSQL is exactly the same.

```

{
  "accountCounts": [
    {
      "businessUnitId": 6,
      "parentAccountNumber": 32001,
      "accountNumber": 42001,
      "totalOnlineContactsCount": 1,
      "countByPosition": {
        "taxProfessionalCount": 0,
        "attorneyCount": 0,
        "nonAttorneyCount": 1,
        "clerkCount": 0
      }
    },
    {
      "businessUnitId": 7,
      "parentAccountNumber": 32000,
      "accountNumber": 42000,
      "totalOnlineContactsCount": 1,
      "countByPosition": {

```

```

        "taxProfessionalCount": 0,
        "attorneyCount": 1,
        "nonAttorneyCount": 0,
        "clerkCount": 0
    }
}
]
}

```

## 7.Oracle\_procedure\_with\_JSON\_Query

This code converts the Oracle procedure into a PostgreSQL function that has JSON SQL queries. It shows how the query transposes JSON into rows and the reverse.

```

CREATE OR REPLACE PROCEDURE p_json_test(p_in_accounts_json IN varchar2,
  p_out_accunts_json  OUT varchar2)
IS
BEGIN
  /*
  p_in_accounts_json paramter should have following format:
  {
    "accounts": [{
      "accountNumber": 42000,
      "parentAccountNumber": 32000,
      "businessUnitId": 7
    }, {
      "accountNumber": 42001,
      "parentAccountNumber": 32001,
      "businessUnitId": 6
    }]
  }
  */
  SELECT
    JSON_OBJECT(
      'accountCounts' VALUE JSON_ARRAYAGG(
        JSON_OBJECT(
          'businessUnitId' VALUE business_unit_id,
          'parentAccountNumber' VALUE parent_account_number,
          'accountNumber' VALUE account_number,
          'totalOnlineContactsCount' VALUE online_contacts_count,
          'countByPosition' VALUE
            JSON_OBJECT(
              'taxProfessionalCount' VALUE tax_count,

```

```

        'attorneyCount' VALUE attorney_count,
        'nonAttorneyCount' VALUE non_attorney_count,
        'clerkCount' VALUE clerk_count
        ) ) ) )
into p_out_accunts_json
FROM
    (SELECT
        tab_data.business_unit_id,
        tab_data.parent_account_number,
        tab_data.account_number,
        SUM(1) online_contacts_count,
        SUM(CASE WHEN tab_data.position_id = '0095' THEN 1 ELSE 0 END) tax_count,
        SUM(CASE WHEN tab_data.position_id = '0100' THEN 1 ELSE 0 END)
attorney_count,
        SUM(CASE WHEN tab_data.position_id = '0090' THEN 1 ELSE 0 END)
non_attorney_count,
        SUM(CASE WHEN tab_data.position_id = '0050' THEN 1 ELSE 0 END)
clerk_count
    FROM aws_test_table scco,JSON_TABLE ( json_doc, '$' ERROR ON ERROR
    COLUMNS (
        parent_account_number NUMBER PATH '$.data.account.parentAccountNumber',
        account_number NUMBER PATH '$.data.account.accountNumber',
        business_unit_id NUMBER PATH '$.data.account.businessUnitId',
        position_id VARCHAR2 ( 4 ) PATH '$.data.positionId'
    ) AS tab_data
    INNER JOIN JSON_TABLE ( p_in_accunts_json, '$.accunts[*]' ERROR ON ERROR

    COLUMNS (
        parent_account_number PATH '$.parentAccountNumber',
        account_number PATH '$.accountNumber',
        business_unit_id PATH '$.businessUnitId')
    ) static_data
    ON ( static_data.parent_account_number = tab_data.parent_account_number
        AND static_data.account_number = tab_data.account_number
        AND static_data.business_unit_id = tab_data.business_unit_id )
    GROUP BY
        tab_data.business_unit_id,
        tab_data.parent_account_number,
        tab_data.account_number
    );
EXCEPTION
WHEN OTHERS THEN
    raise_application_error(-20001,'Error while running the JSON query');
END;
```

/

### Running the procedure

The following code block explains how you can run the previously created Oracle procedure with example JSON input to the procedure. It also gives you the result or output from this procedure.

```
set serveroutput on;
declare
v_out varchar2(30000);
v_in varchar2(30000):= '{
    "accounts": [{
        "accountNumber": 42000,
        "parentAccountNumber": 32000,
        "businessUnitId": 7
    }, {
        "accountNumber": 42001,
        "parentAccountNumber": 32001,
        "businessUnitId": 6
    }]
}';
begin
    p_json_test(v_in,v_out);
    dbms_output.put_line(v_out);
end;
/
```

### Procedure output

```
{
  "accountCounts": [
    {
      "businessUnitId": 6,
      "parentAccountNumber": 32001,
      "accountNumber": 42001,
      "totalOnlineContactsCount": 1,
      "countByPosition": {
        "taxProfessionalCount": 0,
        "attorneyCount": 0,
        "nonAttorneyCount": 1,
        "clerkCount": 0
      }
    }
  ],
}
```



```

{
  "businessUnitId": 7,
  "parentAccountNumber": 32000,
  "accountNumber": 42000,
  "totalOnlineContactsCount": 1,
  "countByPosition": {
    "taxProfessionalCount": 0,
    "attorneyCount": 1,
    "nonAttorneyCount": 0,
    "clerkCount": 0
  }
}
]
}

```

## 8.Postgres\_function\_with\_JSON\_Query

### *Example function*

```

CREATE OR REPLACE FUNCTION f_pg_json_test(p_in_accounts_json text)
RETURNS text
LANGUAGE plpgsql
AS
$$
DECLARE
  v_out_accunts_json text;
BEGIN
SELECT
JSON_BUILD_OBJECT ('accountCounts',
  JSON_AGG(
    JSON_BUILD_OBJECT ('businessUnitId',businessUnitId
    , 'parentAccountNumber',parentAccountNumber
    , 'accountNumber',accountNumber
    , 'totalOnlineContactsCount',online_contacts_count,
    'countByPosition',
      JSON_BUILD_OBJECT (
        'taxProfessionalCount',tax_professional_count
        , 'attorneyCount',attorney_count
        , 'nonAttorneyCount',non_attorney_count
        , 'clerkCount',clerk_count
      )))
INTO v_out_accunts_json
FROM (
WITH tab AS (SELECT * FROM (

```

```

SELECT (json_doc::json->'data'->'account'->'parentAccountNumber')::INTEGER AS
  parentAccountNumber,
(json_doc::json->'data'->'account'->'accountNumber')::INTEGER AS accountNumber,
(json_doc::json->'data'->'account'->'businessUnitId')::INTEGER AS businessUnitId,
(json_doc::json->'data'->'positionId')::varchar AS positionId
FROM aws_test_pg_table) a ) ,
tab1 AS ( SELECT
(json_array_elements(b.jc -> 'accounts') -> 'accountNumber')::integer accountNumber,
(json_array_elements(b.jc -> 'accounts') -> 'businessUnitId')::integer businessUnitId,
(json_array_elements(b.jc -> 'accounts') -> 'parentAccountNumber')::integer
  parentAccountNumber
FROM (
SELECT p_in_accounts_json::json AS jc) b)
SELECT
tab.businessUnitId::text,
tab.parentAccountNumber::text,
tab.accountNumber::text,
SUM(1) online_contacts_count,
SUM(CASE WHEN tab.positionId::text = '0095' THEN 1 ELSE 0 END)
  tax_professional_count,
SUM(CASE WHEN tab.positionId::text = '0100' THEN 1 ELSE 0 END)      attorney_count,
SUM(CASE WHEN tab.positionId::text = '0090' THEN      1 ELSE      0 END)
  non_attorney_count,
SUM(CASE WHEN tab.positionId::text = '0050' THEN      1 ELSE      0 END)
  clerk_count
FROM tab1,tab
WHERE tab.parentAccountNumber::INTEGER=tab1.parentAccountNumber::INTEGER
AND tab.accountNumber::INTEGER=tab1.accountNumber::INTEGER
AND tab.businessUnitId::INTEGER=tab1.businessUnitId::INTEGER
GROUP BY      tab.businessUnitId::text,
              tab.parentAccountNumber::text,
              tab.accountNumber::text) a;
RETURN v_out_accunts_json;
END;
$$;

```

### Running the function

```

select    f_pg_json_test('{
"accounts": [{
  "accountNumber": 42001,
  "parentAccountNumber": 32001,
  "businessUnitId": 6

```

```
    }, {
      "accountNumber": 42000,
      "parentAccountNumber": 32000,
      "businessUnitId": 7
    }
  ]
}') ;
```

### Function output

The following output is similar to the Oracle procedure output. The difference is that this output is in Text format.

```
{
  "accountCounts": [
    {
      "businessUnitId": "6",
      "parentAccountNumber": "32001",
      "accountNumber": "42001",
      "totalOnlineContactsCount": 1,
      "countByPosition": {
        "taxProfessionalCount": 0,
        "attorneyCount": 0,
        "nonAttorneyCount": 1,
        "clerkCount": 0
      }
    },
    {
      "businessUnitId": "7",
      "parentAccountNumber": "32000",
      "accountNumber": "42000",
      "totalOnlineContactsCount": 1,
      "countByPosition": {
        "taxProfessionalCount": 0,
        "attorneyCount": 1,
        "nonAttorneyCount": 0,
        "clerkCount": 0
      }
    }
  ]
}
```

# Copy Amazon DynamoDB tables across accounts using AWS Backup

*Created by Ramkumar Ramanujam (AWS)*

**Environment:** PoC or pilot

**Technologies:** Databases;  
Migration

**AWS services:** Amazon  
DynamoDB; AWS Backup

## Summary

When working with Amazon DynamoDB on Amazon Web Services (AWS), a common use case is to copy or sync DynamoDB tables in development, testing, or staging environments with the table data that is in the production environment. As a standard practice, each environment uses a different AWS account.

AWS Backup supports cross-Region and cross-account backup and restore of data for DynamoDB, Amazon Simple Storage Service (Amazon S3), and other AWS services. This pattern provides the steps for using AWS Backup cross-account backup and restore to copy DynamoDB tables between AWS accounts.

## Prerequisites and limitations

### Prerequisites

- Two active AWS accounts that belong to the same AWS Organizations organization
- DynamoDB tables in both the accounts.
- AWS Identity and Access Management (IAM) permissions to create and use AWS backup vaults

### Limitations

- Source and target AWS accounts should be part of the same AWS Organizations organization.

## Architecture

### Target technology stack

- AWS Backup
- Amazon DynamoDB

## Target architecture

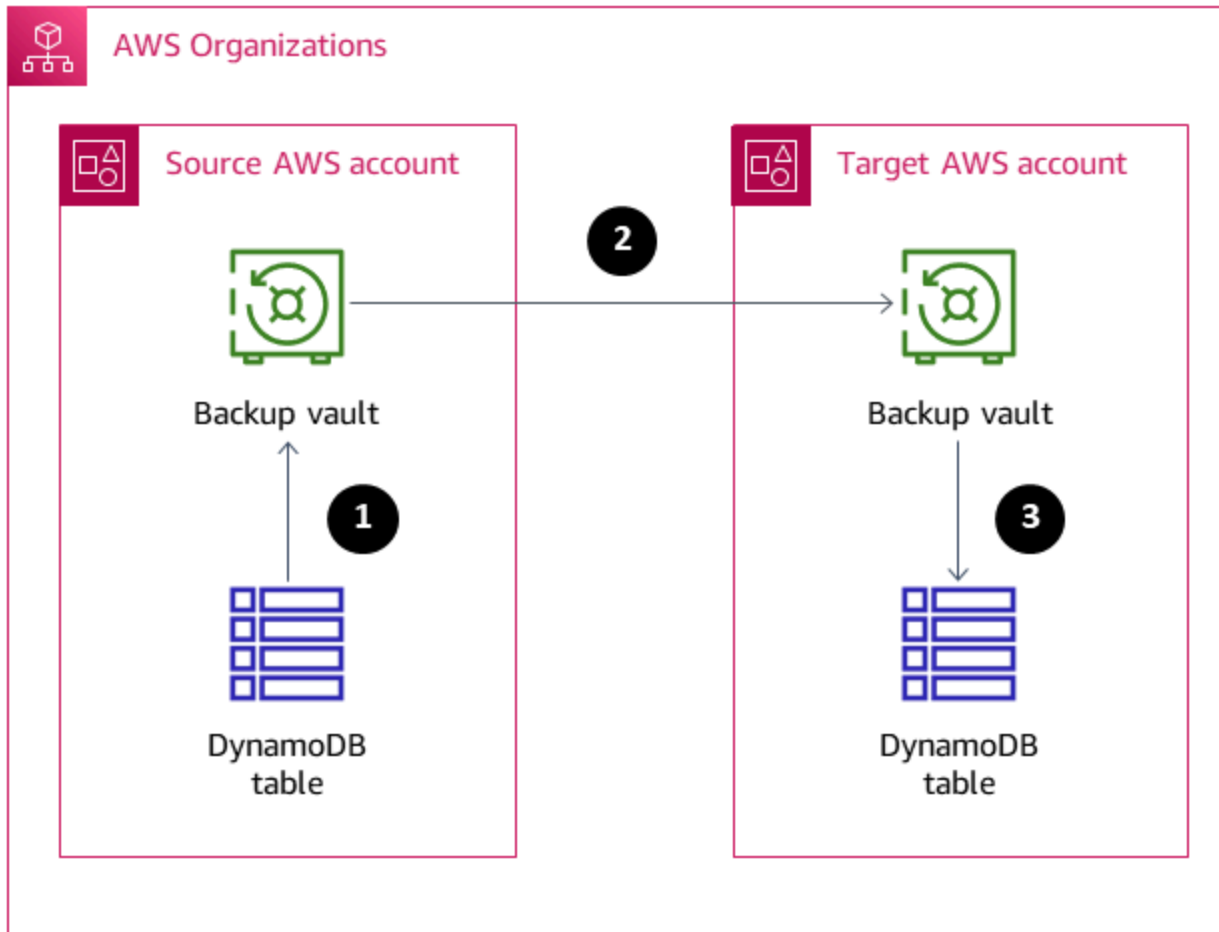

1. Create the DynamoDB table backup in the AWS Backup backup vault in the source account.
2. Copy the backup to the backup vault in the target account.
3. Restore the DynamoDB table in the target account using the backup from the target account backup vault.

## Automation and scale

You can use AWS Backup to schedule backups to run at specific intervals.

## Tools

- [AWS Backup](#) – AWS Backup is a fully-managed service for centralizing and automating data protection across AWS services, in the cloud, and on premises. Using this service, you can configure backup policies and monitor activity for your AWS resources in one place. It allows you to automate and consolidate backup tasks that were previously performed service-by-service, and removes the need to create custom scripts and manual processes.
- [Amazon DynamoDB](#) – Amazon DynamoDB is a fully managed NoSQL database service that provides fast and predictable performance with seamless scalability.

## Epics

### Turn on AWS Backup features in the source and target accounts

Task	Description	Skills required
Turn on advanced features for DynamoDB and cross-account backup.	<p>In both the source and the target AWS accounts, do the following:</p> <ol style="list-style-type: none"><li>1. On the AWS Management Console, open the AWS Backup console.</li><li>2. Choose <b>Settings</b>.</li><li>3. Under <b>Advanced features for Amazon DynamoDB backups</b>, confirm that <b>Advanced features</b> is enabled, or choose <b>Enable</b>.</li><li>4. Under <b>Cross-account management</b>, for <b>Cross-account backup</b>, choose <b>Enable</b>.</li></ol>	AWS DevOps, Migration engineer

## Create backup vaults in the source and target accounts

Task	Description	Skills required
Create backup vaults.	<p>In both the source and the target AWS accounts, do the following:</p> <ol style="list-style-type: none"><li>1. On the AWS Backup console, choose <b>Backup vaults</b>.</li><li>2. Choose <b>Create Backup vault</b>.</li><li>3. Copy the Amazon Resource Name (ARN) of the backup vault and save it.</li></ol> <p>The ARNs of both the source and the target backup vaults will be required when you copying the DynamoDB table backup between the source account and the target account.</p>	AWS DevOps, Migration engineer

## Perform backup and restore using backup vaults

Task	Description	Skills required
In the source account, create a DynamoDB table backup.	<p>To create a backup for the DynamoDB table in the source account, do the following:</p> <ol style="list-style-type: none"><li>1. On the AWS Backup <b>Dashboard</b> page, choose</li></ol>	AWS DevOps, DBA, Migration engineer

Task	Description	Skills required
	<p><b>Create on-demand backup.</b></p> <ol style="list-style-type: none"><li data-bbox="592 310 993 491">2. In the <b>Settings</b> section, for <b>Resource type</b>, select <b>DynamoDB</b>, and then select the table name.</li><li data-bbox="592 512 987 739">3. In the <b>Backup vault</b> dropdown list, select the backup vault that you created in the source account.</li><li data-bbox="592 760 945 848">4. Select the <b>Retention period</b> that you want.</li><li data-bbox="592 869 1024 957">5. Choose <b>Create on-demand backup</b>.</li></ol> <p>A new backup job is created.</p> <p>To monitor the status of the backup job, on the AWS Backup <b>Jobs</b> page, choose the <b>Backup Jobs</b> tab. All active, in-progress, and completed backup jobs are listed in this tab.</p>	



Task	Description	Skills required
Copy the backup from the source account to the target account.	<p>After the backup job is completed, copy the DynamoDB table backup from the backup vault in the source account to the backup vault in target account.</p> <p>To copy the backup vault, in the source account, do the following:</p> <ol style="list-style-type: none"><li>1. On the AWS Backup console, choose <b>Backup vaults</b>.</li><li>2. Under <b>Backups</b>, choose the DynamoDB table backup.</li><li>3. Choose <b>Actions, Copy</b>.</li><li>4. Enter the AWS Region of the target account.</li><li>5. For <b>External vault ARN</b>, enter the ARN of the backup vault that you created in the target account.</li><li>6. To copy backups from the source account to the target account, in the target account backup vault, enable access from a different account.</li></ol>	AWS DevOps, Migration engineer, DBA

Task	Description	Skills required
Restore the backup in the target account.	<p>In the target AWS account, do the following:</p> <ol style="list-style-type: none"><li>1. On the AWS Backup console, choose <b>Backup vaults</b>.</li><li>2. Under <b>Backups</b>, select the backup that you copied from the source account.</li><li>3. Choose <b>Actions, Restore</b>.</li><li>4. Enter the name of the target DynamoDB table that you want to restore.</li></ol>	AWS DevOps, DBA, Migration engineer

## Related resources

- [Using AWS Backup with DynamoDB](#)
- [Creating backup copies across AWS accounts](#)
- [AWS Backup pricing](#)

# Copy Amazon DynamoDB tables across accounts using a custom implementation

Created by Ramkumar Ramanujam (AWS)

<b>Environment:</b> Production	<b>Source:</b> Amazon DynamoDB	<b>Target:</b> Amazon DynamoDB
<b>R Type:</b> N/A	<b>Workload:</b> All other workloads	<b>Technologies:</b> Databases

**AWS services:** Amazon DynamoDB

## Summary

When working with Amazon DynamoDB on Amazon Web Services (AWS), a common use case is to copy or sync DynamoDB tables in development, testing, or staging environments with the table data that are in the production environment. As a standard practice, each environment uses a different AWS account.

DynamoDB now supports cross-account backup using AWS Backup. For information about associated storage costs when using AWS Backup, see [AWS Backup pricing](#). When you use AWS Backup to copy across accounts, the source and target accounts must be part of an AWS Organizations organization. There are other solutions for cross-account backup and restore using AWS services such as AWS Data Pipeline or AWS Glue. Using those solutions, however, increases the application footprint, because there are more AWS services to deploy and maintain.

You can also use Amazon DynamoDB Streams to capture table changes in the source account. Then you can initiate an AWS Lambda function, and make the corresponding changes in the target table in the target account. But that solution applies to use cases in which source and target tables must always be kept in sync. It might not apply to development, testing, and staging environments where data are updated frequently.

This pattern provides steps to implement a custom solution to copy a Amazon DynamoDB table from one account to another. This pattern can be implemented using common programming languages such as C#, Java, and Python. We recommend using a language that is supported by an [AWS SDK](#).

## Prerequisites and limitations

### Prerequisites

- Two active AWS accounts
- DynamoDB tables in both the accounts
- Knowledge of AWS Identity and Access Management (IAM) roles and policies
- Knowledge of how to access Amazon DynamoDB tables using any common programming language, such as C#, Java, or Python

### Limitations

This pattern applies to DynamoDB tables that are around 2 GB or smaller. With additional logic to handle connection or session interruptions, throttling, and failures and retries, it can be used for larger tables.

The DynamoDB scan operation, which reads items from the source table, can fetch only up to 1 MB of data in a single call. For larger tables, greater than 2 GB, this limitation can increase the total time to perform a full table copy.

### Architecture

The following diagram shows the custom implementation between the source and target AWS accounts. IAM policies and security tokens are used with the custom implementation. Data is read from Amazon DynamoDB in the source account and written to DynamoDB in the target account.

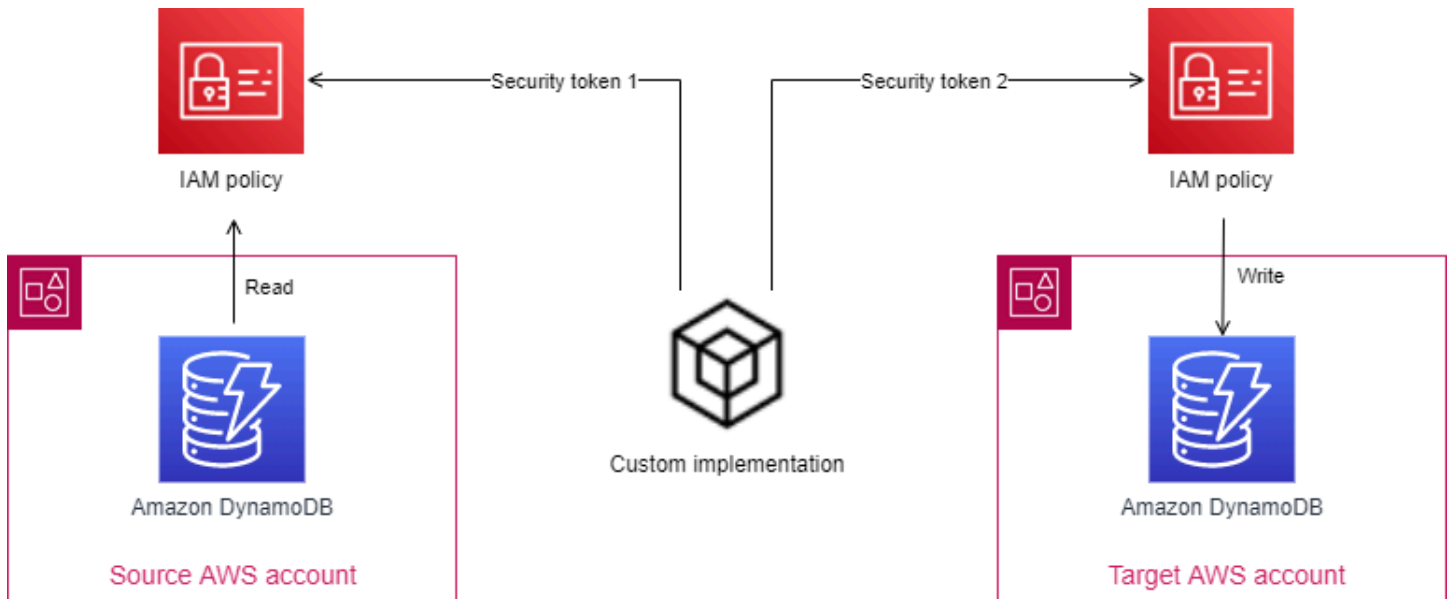

## Automation and scale

This pattern applies to DynamoDB tables that are smaller in size, around 2 GB.

To apply this pattern for larger tables, address the following issues:

- During the table copy operation, two active sessions are maintained, using different security tokens. If the table copy operation takes longer than the token expiration times, you must put in place logic to refresh the security tokens.
- If enough read capacity units (RCUs) and write capacity units (WCUs) are not provisioned, reads or writes on the source or target table might get throttled. Be sure to catch and handle these exceptions.
- Handle any other failures or exceptions and put a retry mechanism in place to retry or continue from where the copy operation failed.

## Tools

### Tools

- [Amazon DynamoDB](#) – Amazon DynamoDB is a fully managed NoSQL database service that provides fast and predictable performance with seamless scalability.
- The additional tools required will differ based on the programming language that you choose for the implementation. For example, if you use C#, you will need Microsoft Visual Studio and the following NuGet packages:

- AWSSDK
- AWSSDK.DynamoDBv2

## Code

The following Python code snippet deletes and recreates a DynamoDB table using the Boto3 library.

Do not use the `AWS_ACCESS_KEY_ID` and `AWS_SECRET_ACCESS_KEY` of an IAM user because these are long-term credentials, which should be avoided for programmatic access to AWS services. For more information about temporary credentials, see the *Best practices* section.

The `AWS_ACCESS_KEY_ID`, `AWS_SECRET_ACCESS_KEY`, and `TEMPORARY_SESSION_TOKEN` used in the following code snippet are temporary credentials fetched from AWS Security Token Service (AWS STS).

```
import boto3
import sys
import json

#args = input-parameters = GLOBAL_SEC_INDEXES_JSON_COLLECTION,
    ATTRIBUTES_JSON_COLLECTION, TARGET_DYNAMODB_NAME, TARGET_REGION, ...

#Input param: GLOBAL_SEC_INDEXES_JSON_COLLECTION
#[{"IndexName":"Test-index", "KeySchema":[{"AttributeName":"AppId", "KeyType":"HASH"},
{"AttributeName":"AppType", "KeyType":"RANGE"}], "Projection":
{"ProjectionType":"INCLUDE", "NonKeyAttributes":["PK", "SK", "OwnerName", "AppVersion"]}]}

#Input param: ATTRIBUTES_JSON_COLLECTION
#[{"AttributeName":"PK", "AttributeType":"S"},
{"AttributeName":"SK", "AttributeType":"S"},
{"AttributeName":"AppId", "AttributeType":"S"},
{"AttributeName":"AppType", "AttributeType":"N"}]

region = args['TARGET_REGION']
target_ddb_name = args['TARGET_DYNAMODB_NAME']

global_secondary_indexes = json.loads(args['GLOBAL_SEC_INDEXES_JSON_COLLECTION'])
attribute_definitions = json.loads(args['ATTRIBUTES_JSON_COLLECTION'])

# Drop and create target DynamoDB table
dynamodb_client = boto3.Session(
```

```
        aws_access_key_id=args['AWS_ACCESS_KEY_ID'],
        aws_secret_access_key=args['AWS_SECRET_ACCESS_KEY'],
        aws_session_token=args['TEMPORARY_SESSION_TOKEN'],
    ).client('dynamodb')

# Delete table
print('Deleting table: ' + target_ddb_name + ' ...')

try:
    dynamodb_client.delete_table(TableName=target_ddb_name)

    #Wait for table deletion to complete
    waiter = dynamodb_client.get_waiter('table_not_exists')
    waiter.wait(TableName=target_ddb_name)
    print('Table deleted.')
except dynamodb_client.exceptions.ResourceNotFoundException:
    print('Table already deleted / does not exist.')
    pass

print('Creating table: ' + target_ddb_name + ' ...')

table = dynamodb_client.create_table(
    TableName=target_ddb_name,
    KeySchema=[
        {
            'AttributeName': 'PK',
            'KeyType': 'HASH' # Partition key
        },
        {
            'AttributeName': 'SK',
            'KeyType': 'RANGE' # Sort key
        }
    ],
    AttributeDefinitions=attribute_definitions,
    GlobalSecondaryIndexes=global_secondary_indexes,
    BillingMode='PAY_PER_REQUEST'
)

waiter = dynamodb_client.get_waiter('table_exists')
waiter.wait(TableName=target_ddb_name)

print('Table created.')
```

# Best practices

## Temporary credentials

As a security best practice, while accessing AWS services programmatically, avoid using the `AWS_ACCESS_KEY_ID` and `AWS_SECRET_ACCESS_KEY` of an IAM user because these are long-term credentials. Always try to use temporary credentials to access AWS services programmatically.

As an example, a developer hardcodes the `AWS_ACCESS_KEY_ID` and `AWS_SECRET_ACCESS_KEY` of an IAM user in the application during development but fails to remove the hardcoded values before pushing changes to code repository. These exposed credentials can be used by unintended or malicious users, which can have serious implications (especially if the exposed credentials have admin privileges). These exposed credentials should be deactivated or deleted immediately by using the IAM console or AWS Command Line Interface (AWS CLI).

To get temporary credentials for programmatic access to AWS services, use AWS STS. Temporary credentials are valid only for the specified time (from 15 minutes up to 36 hours). The maximum allowed duration of temporary credentials varies depending on such factors as role settings and role chaining. For more information about AWS STS, see the [documentation](#).

## Epics

### Set up DynamoDB tables

Task	Description	Skills required
Create DynamoDB tables.	<p>Create DynamoDB tables, with indexes, in both source and target AWS accounts.</p> <p>Set the capacity provisioning as on-demand mode, which allows DynamoDB to scale read/write capacities dynamically based on the workload.</p>	App developer, DBA, Migration engineer



Task	Description	Skills required
	Alternatively, you can use provisioned capacity with 4000 RCUs and 4000 WCUs.	
Populate the source table.	Populate the DynamoDB table in the source account with test data. Having at least 50 MB or more of test data helps you to see the peak and average RCUs consumed during table copy. You can then change the capacity provisioning as needed.	App developer, DBA, Migration engineer

### Set up credentials to access the DynamoDB tables

Task	Description	Skills required
Create IAM roles to access the source and target DynamoDB tables.	<p>Create an IAM role in the source account with permissions to access (read) the DynamoDB table in the source account.</p> <p>Add the source account as a trusted entity for this role.</p> <p>Create an IAM role in the target account with permissions to access (create, read, update, delete) the DynamoDB table in the target account.</p>	App developer, AWS DevOps

Task	Description	Skills required
	Add the target account as a trusted entity for this role.	

### Copy table data from one account to another

Task	Description	Skills required
Get temporary credentials for the IAM roles.	<p>Get temporary credentials for IAM role created in source account.</p> <p>Get temporary credentials for IAM role created in target account.</p> <p>One way to get the temporary credentials for the IAM role is to use AWS STS from the AWS CLI.</p> <pre>aws sts assume-role   --role-arn arn:aws:iam::&lt;account-id&gt;:role/&lt;role-name&gt; --   role-session-name   &lt;session-name&gt; --   profile &lt;profile-name&gt;</pre> <p>Use the appropriate AWS profile (corresponding to the source or target account).</p> <p>For more information about different ways to get temporary credentials, see the following:</p>	App developer, Migration engineer

Task	Description	Skills required
	<ul style="list-style-type: none"><li>• <a href="#">AWS Security Token Service API Reference</a></li><li>• <a href="#">Getting IAM role credentials for CLI access</a></li></ul>	
Initialize the DynamoDB clients for source and target DynamoDB access.	<p>Initialize the DynamoDB clients, which are provided by the AWS SDK, for the source and target DynamoDB tables.</p> <ul style="list-style-type: none"><li>• For the source DynamoDB client, use the temporary credentials fetched from the source account.</li><li>• For the target DynamoDB client, use the temporary credentials fetched from the target account.</li></ul> <p>For more information about making requests by using IAM temporary credentials, see the <a href="#">AWS documentation</a>.</p>	App developer

Task	Description	Skills required
Drop and recreate the target table.	<p>Delete and recreate the target DynamoDB table (along with indexes) in the target account, using the target account DynamoDB client.</p> <p>Deleting all records from a DynamoDB table is a costly operation because it consumes provisioned WCUs. Deleting and recreating the table avoids those extra costs.</p> <p>You can add indexes to a table after you create it, but this takes 2–5 minutes longer. Creating indexes during table creation, by passing the indexes collection to the <code>createTable</code> call, is more efficient.</p>	App developer

Task	Description	Skills required
Perform the table copy.	<p>Repeat the following steps until all data are copied:</p> <ul style="list-style-type: none"><li>• Perform a scan on the table in the source account, using the source DynamoDB client. Each DynamoDB scan retrieves only 1 MB of data from the table, so you must repeat this operation until all items, or records, are read.</li><li>• For each set of scanned items, write the items to the table in the target account, with the target DynamoDB client, using the <code>BatchWriteItem</code> call in AWS SDK for DynamoDB. This reduces the number of <code>PutItem</code> requests made to DynamoDB.</li><li>• <code>BatchWriteItem</code> has a limitation of 25 writes or puts, or up to 16 MB. You must add logic to accumulate scanned items in counts of 25 before calling <code>BatchWriteItem</code>. <code>BatchWriteItem</code> returns a list of items that could not be successfully copied. Using this list, add retry logic to perform another</li></ul>	App developer

Task	Description	Skills required
	<p>BatchWriteItem call with only those items that did not succeed.</p> <p>For more information, see the reference implementation in C# (for dropping, creating, and populating tables) in the <i>Attachments</i> section. An example table config JavaScript Object Notation (JSON) file is also attached.</p>	

## Related resources

- [Amazon DynamoDB documentation](#)
- [Creating an IAM user in your AWS account](#)
- [AWS SDKs](#)
- [Using temporary credentials with AWS resources](#)

## Additional information

This pattern was implemented using C# to copy a DynamoDB table with 200,000 items (average item size of 5 KB and table size of 250 MB). The target DynamoDB table was set up with provisioned capacity of 4000 RCUs and 4000 WCUs.

The complete table copy operation (from source account to target account), including dropping and recreating the table, took 5 minutes. Total capacity units consumed: 30,000 RCUs and approximately 400,000 WCUs.

For more information on DynamoDB capacity modes, see [Read/Write capacity mode](#) in the AWS documentation.

## Attachments

To access additional content that is associated with this document, unzip the following file:

[attachment.zip](#)

# Create detailed cost and usage reports for Amazon RDS and Amazon Aurora

Created by Lakshmanan Lakshmanan (AWS) and Sudarshan Narasimhan

**Environment:** Production

**Technologies:** Databases;  
Cost management; Analytics

**AWS services:** Amazon  
Athena; Amazon Aurora;  
Amazon RDS; AWS Billing and  
Cost Management

## Summary

This pattern shows how to track usage costs for Amazon Relational Database Service (Amazon RDS) or Amazon Aurora clusters by configuring [user-defined cost allocation tags](#). You can use these tags to create detailed cost and usage reports in AWS Cost Explorer for clusters across multiple dimensions. For example, you can track usage costs at the team, project, or cost center level, and then analyze the data in Amazon Athena.

## Prerequisites and limitations

### Prerequisites

- An active AWS account
- One or more [Amazon RDS](#) or [Amazon Aurora](#) instances

### Limitations

For tagging restrictions, see the [AWS Billing User Guide](#).

## Architecture

### Target technology stack

- Amazon RDS or Amazon Aurora
- AWS Cost and Usage Report



- AWS Cost Explorer
- Amazon Athena

## Workflow and architecture

The tagging and analysis workflow consists of these steps:

1. A data engineer, database administrator, or AWS administrator creates user-defined cost allocation tags for the Amazon RDS or Aurora clusters.
2. An AWS administrator activates the tags.
3. The tags report metadata to AWS Cost Explorer.
4. A data engineer, database administrator, or AWS administrator creates a [monthly cost allocation report](#).
5. A data engineer, database administrator, or AWS administrator analyzes the monthly cost allocation report by using Amazon Athena.

The following diagram shows how to apply tags to track usage costs for Amazon RDS or Aurora instances.

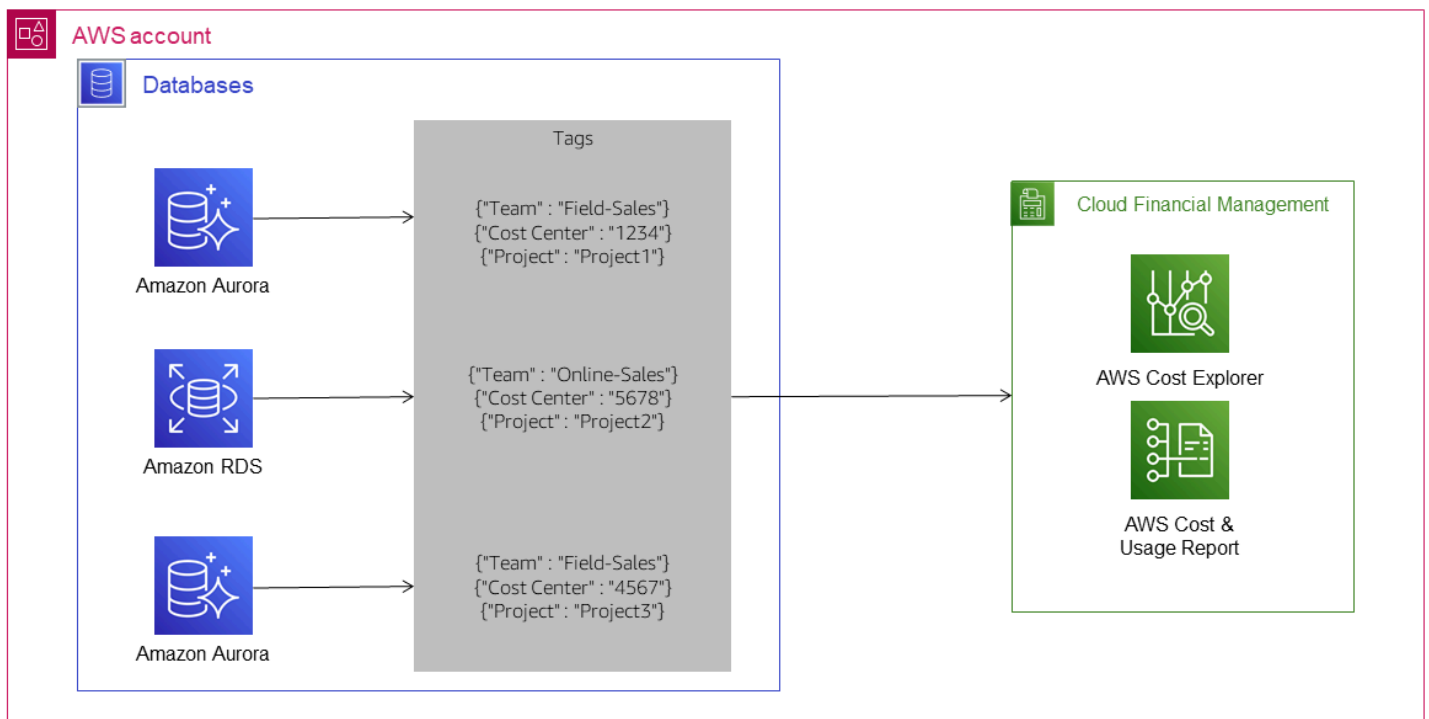

The following architecture diagram shows how the cost allocation report is integrated with Amazon Athena for analysis.

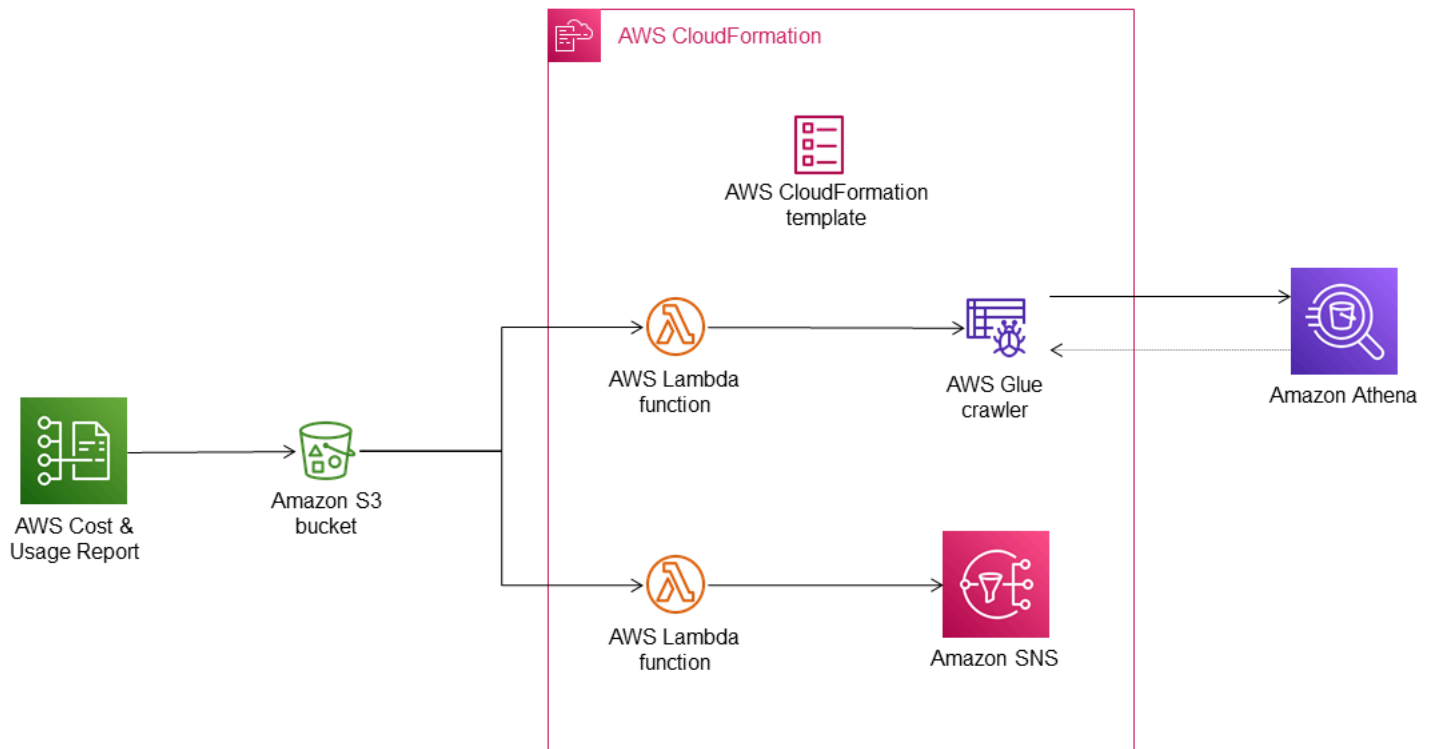

The monthly cost allocation report is stored in an Amazon S3 bucket that you specify. When you set up Athena with the AWS CloudFormation template, as described in the *Epics* section, the template provisions several additional resources, including an AWS Glue crawler, an AWS Glue database, an Amazon Simple Notification System (Amazon SNS) event, AWS Lambda functions, and AWS Identity and Access Management (IAM) roles for the Lambda functions. As new cost data files arrive in the S3 bucket, event notifications are used to forward these files to a Lambda function for processing. The Lambda function initiates an AWS Glue crawler job to create or update the table in the AWS Glue Data Catalog. This table is then used to query data in Athena.

## Tools

- [Amazon Athena](#) is an interactive query service that makes it easy to analyze data in Amazon S3 using standard SQL.
- [Amazon Aurora](#) is a fully managed relational database engine that's built for the cloud and compatible with MySQL and PostgreSQL.

- [Amazon Relational Database Service \(Amazon RDS\)](#) helps you set up, operate, and scale a relational database in the AWS Cloud.
- [AWS CloudFormation](#) is an infrastructure as code (IaC) service that allows you to easily model, provision, and manage AWS and third-party resources.
- [AWS Cost Explorer](#) helps you view and analyze your AWS costs and usage.

## Epics

### Create and activate tags for your Amazon RDS or Aurora cluster

Task	Description	Skills required
Create user-defined cost allocation tags for your Amazon RDS or Aurora cluster.	To add tags to a new or existing Amazon RDS or Aurora cluster, follow the instructions in <a href="#">Adding, listing, and removing tags</a> in the <i>Amazon Aurora User Guide</i> .  <b>Note:</b> For information about how to set up an Amazon Aurora cluster, see the instructions for <a href="#">MySQL</a> and <a href="#">PostgreSQL</a> in the <i>Amazon Aurora User Guide</i> .	AWS administrator, Data engineer, DBA
Activate the user-defined cost allocation tags.	Follow the instructions in <a href="#">Activating user-defined cost allocation tags</a> in the <i>AWS Billing User Guide</i> .	AWS administrator

## Create cost and usage reports

Task	Description	Skills required
Create and configure cost and usage reports for your clusters.	<ol style="list-style-type: none"><li>1. Sign in to the AWS Management Console and open the <a href="#">AWS Billing console</a>.</li><li>2. In the left navigation pane, choose <b>Cost &amp; Usage Reports</b>.</li><li>3. Choose <b>Create report</b>.</li><li>4. Provide a report name, keep the default settings for other options, and then choose <b>Next</b>.</li><li>5. Choose <b>Configure</b> and provide the details of an existing S3 bucket. You can also choose to create a new S3 bucket from this screen. Choose <b>Next</b>.</li><li>6. Verify the default policy that will be applied to your bucket, select the confirmation check box, and then choose <b>Save</b>.</li><li>7. For <b>Report path prefix</b>, specify the prefix you want to prepend to the report name.</li><li>8. For <b>Time granularity</b>, choose <b>Hourly</b>, <b>Daily</b> or <b>Monthly</b>, depending on how often you want data</li></ol>	App owner, AWS administrator, DBA, General AWS, Data engineer

Task	Description	Skills required
	<p>to be collected for the report.</p> <p>9. For <b>Report versioning</b>, choose whether you want new versions of the report to be created separately or overwrite the existing report with each version.</p> <p>10For <b>Enable report data integration for</b>, choose <b>Amazon Athena</b>. Verify that the compression type is set to Parquet.</p> <p>11Choose <b>Next</b>.</p> <p>12Review the report settings, and then choose <b>Review and Complete</b>.</p> <p>The data will be available in 24 hours.</p>	

## Analyze cost and usage report data

Task	Description	Skills required
Analyze the cost and usage report data.	<p>1. Set up and use Athena to analyze the report data. For instructions, see <a href="#">Querying Cost and Usage Reports using Amazon Athena</a> in the <i>AWS Cost and Usage Reports User Guide</i>. We recommend</p>	App owner, AWS administrator, DBA, General AWS, Data engineer

Task	Description	Skills required
	<p>that you use the <a href="#">AWS CloudFormation template provided by Athena</a>.</p> <p>2. Run Athena queries. For example, you can use the following SQL query to check the status of the data refresh.</p> <pre data-bbox="594 661 1029 823">select status from cost_and_usage_data_athena_status</pre> <p>For more information, see <a href="#">Running Amazon Athena queries</a> in the <i>AWS Cost and Usage Reports User Guide</i>.</p> <p><b>Note:</b> When you run your SQL query, make sure that the correct database is selected from the dropdown list.</p>	

## Related resources

### References

- [Setting up Athena using AWS CloudFormation templates](#) (recommended)
- [Setting up Athena manually](#)
- [Running Amazon Athena queries](#)
- [Loading report data to other resources](#)

### Tutorials and videos

- [Analyze Cost and Usage Reports using Amazon Athena](#) (YouTube video)

# Emulate Oracle RAC workloads using custom endpoints in Aurora PostgreSQL

Created by HariKrishna Boorgadda (AWS)

<b>Environment:</b> PoC or pilot	<b>Source:</b> Databases: Relational	<b>Target:</b> Aurora PostgreSQL
<b>R Type:</b> Replatform	<b>Workload:</b> Oracle	<b>Technologies:</b> Databases; Migration
<b>AWS services:</b> Amazon Aurora; Amazon CloudWatch		

## Summary

This pattern describes how to emulate services in an Oracle Real Application Clusters (Oracle RAC) workload by using Amazon Aurora PostgreSQL-Compatible Edition with custom endpoints that distribute workloads across instances within a single cluster. The pattern shows you how to create [custom endpoints](#) for Amazon Aurora databases. Custom endpoints enable you to distribute and load balance workloads across different sets of DB instances in your Aurora cluster.

In an Oracle RAC environment, [services](#) can span one or more instances and facilitate workload balancing based on transaction performance. Service features include end-to-end unattended recovery, rolling changes by workload, and full location transparency. You can use this pattern to emulate some of these features. For example, you can emulate the ability to route connections for reporting applications.

## Prerequisites and limitations

### Prerequisites

- An active AWS account
- A [PostgreSQL JDBC driver](#)
- An [Aurora PostgreSQL-Compatible database](#)
- An Oracle RAC database migrated to an Aurora PostgreSQL-Compatible database



## Limitations

- For limitations that apply to custom endpoints, see [Specifying properties for custom endpoints](#) in the Amazon RDS documentation.

## Architecture

### Source technology stack

- A three-node Oracle RAC database

### Target technology stack

- An Aurora PostgreSQL-Compatible database with two read replicas

### Source architecture

The following diagram shows the architecture of a three-node Oracle RAC database.

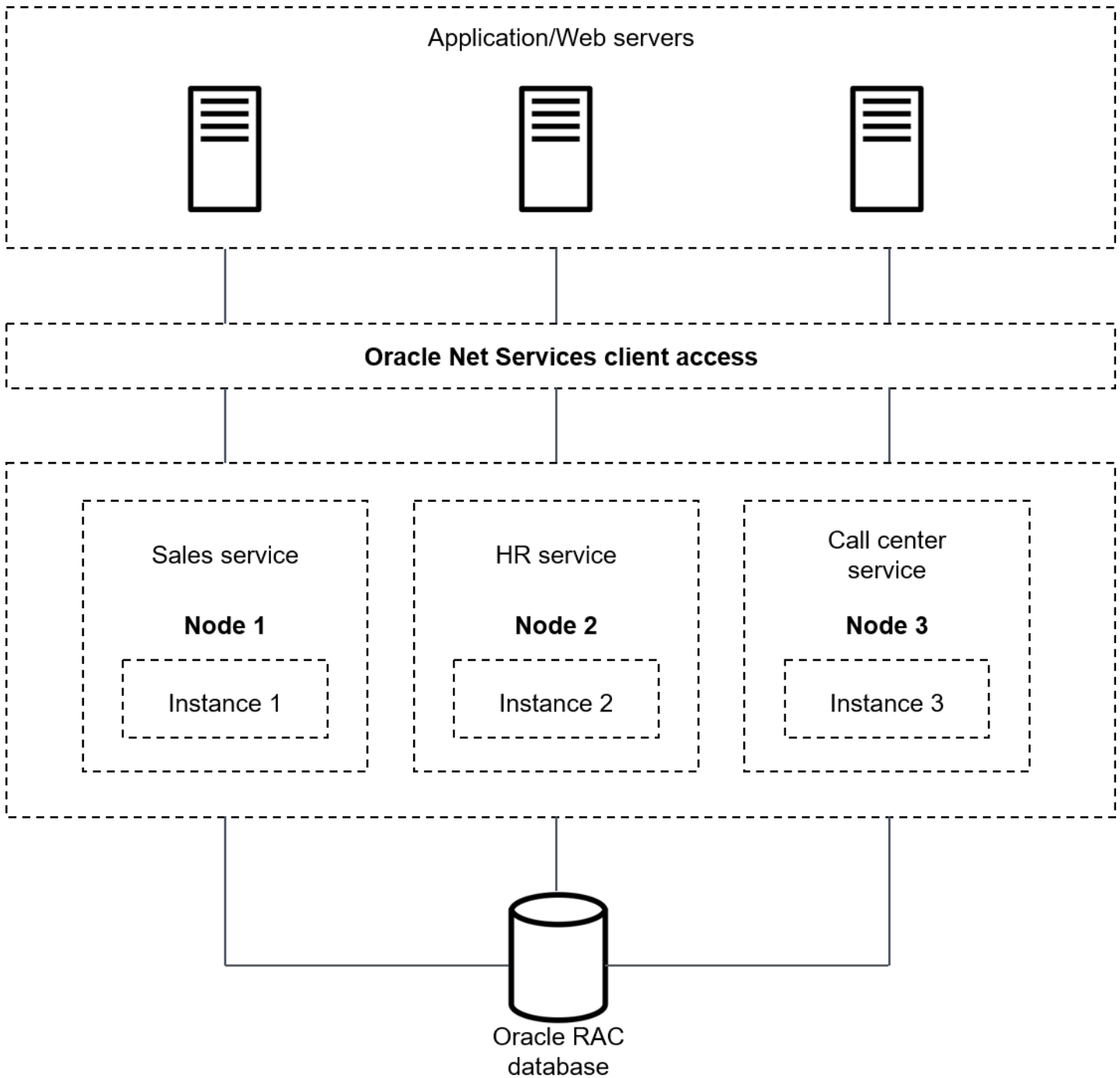

**Target architecture**

The following diagram shows the architecture of an Aurora PostgreSQL-Compatible database with two read replicas. Three different applications/services are using custom endpoints, which serve different application users and redirect the traffic and load between primary and read replicas.

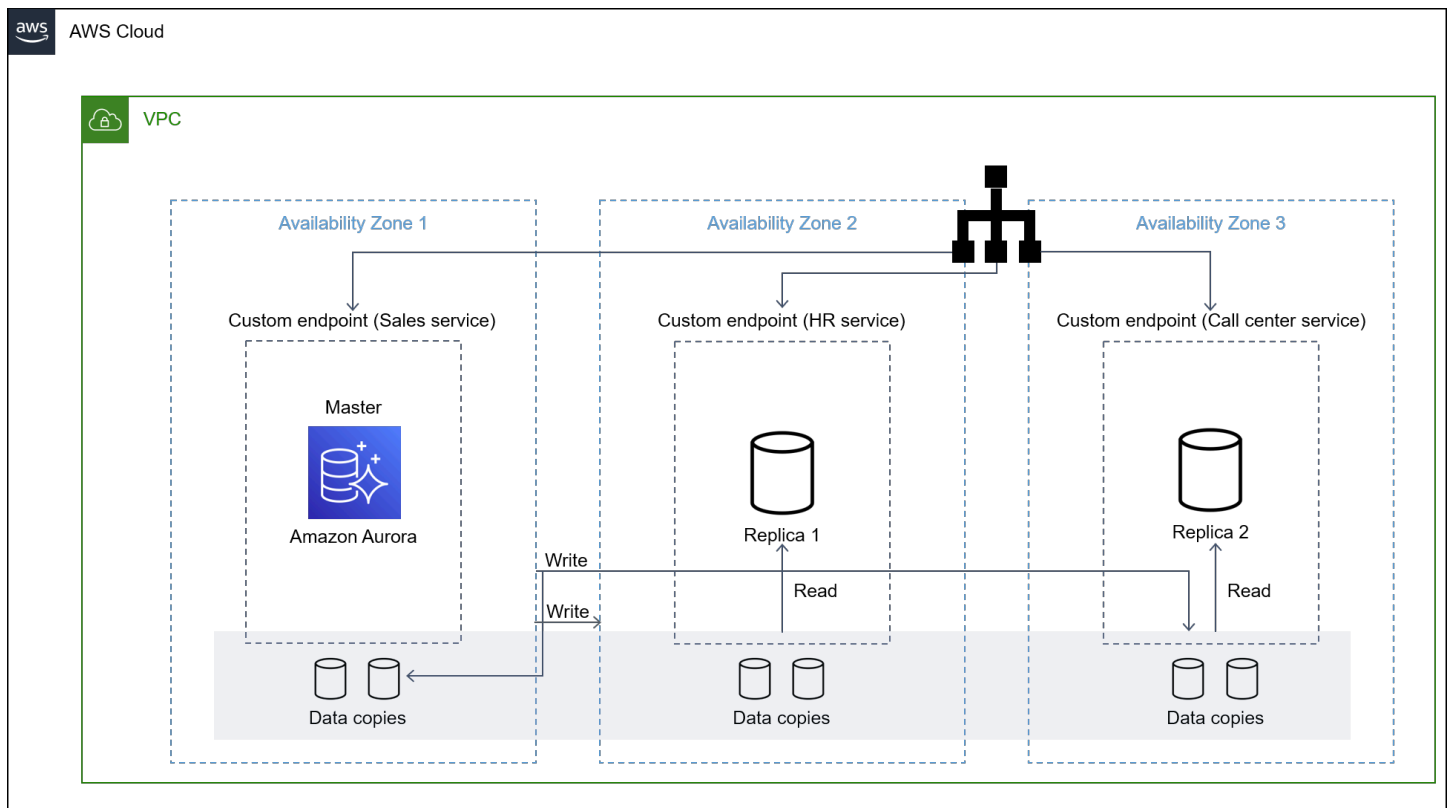

## Tools

- [Amazon Aurora PostgreSQL-Compatible Edition](#) is a fully managed, ACID-compliant relational database engine that helps you set up, operate, and scale PostgreSQL deployments.
- [Amazon CloudWatch](#) helps you monitor the metrics of your AWS resources and the applications that you run on AWS in real time.
- [Amazon Relational Database Service \(Amazon RDS\) for PostgreSQL](#) helps you set up, operate, and scale a PostgreSQL relational database in the AWS Cloud.
- [AWS Command Line Interface \(AWS CLI\)](#) is an open-source tool that helps you interact with AWS services through commands in your command-line shell.

# Epics

## Create the Aurora PostgreSQL-Compatible cluster

Task	Description	Skills required
Create a cluster.	To create the cluster, see <a href="#">Creating a DB cluster and connecting to a database on an Aurora PostgreSQL DB cluster</a> in the Amazon RDS documentation.	AWS administrator
Create a custom parameter group for the workload.	To create a parameter group, see <a href="#">Creating a DB cluster parameter group</a> in the Amazon RDS documentation.	AWS administrator
Create event notifications and alarms.	<p>You can use event notifications and Amazon CloudWatch alarms to notify you when the cluster changes state and to capture metrics when a predefined threshold is met.</p> <p>To create a CloudWatch alarm, see <a href="#">Create a CloudWatch alarm based on a static threshold</a> in the CloudWatch documentation.</p> <p>To create an event notification, see <a href="#">Creating a CloudWatch Events Rule That Triggers on an Event</a> in the CloudWatch documentation.</p>	AWS administrator

## Add replicas to the Aurora PostgreSQL-Compatible DB cluster

Task	Description	Skills required
Add the read replicas to the cluster.	<ol style="list-style-type: none"> <li>1. <a href="#">Create a read replica</a>.</li> <li>2. Add the read replica to the same Availability Zone that your DB cluster is in. <b>Note:</b> You can use a different Availability Zone if you have requirements that must be met for your failover node.</li> </ol>	AWS administrator
Note the read replica endpoint.	Document your read replica endpoint for later use in creating the custom endpoints.	AWS administrator

## Create custom endpoints

Task	Description	Skills required
Enter a name for the custom endpoint.	For each endpoint that you require, create a unique endpoint name related to your workload or application.	AWS administrator
Add the endpoint members.	Add your read replica endpoints to a custom group. For more information, see <a href="#">Editing a custom endpoint</a> in the Amazon RDS documentation.	AWS administrator
(Optional) Add future instances to the cluster.	If you want to add more replicas or endpoints to the	AWS administrator

Task	Description	Skills required
	custom group, see <a href="#">Adding Aurora Replicas to a DB cluster</a> in the Amazon RDS documentation.	
Create the endpoint.	To create the endpoint, see <a href="#">Creating a custom endpoint</a> in the Amazon RDS documentation.	AWS administrator

### Test application connections by using custom endpoints

Task	Description	Skills required
Share the custom endpoint details with the application that points to your workload.	Add your custom endpoint details to the database connection details in the reporting application that you plan to test.	AWS administrator
Connect the workload by using the custom endpoint.	Validate the custom endpoint details in the reporting application.	AWS administrator
Check the connection details from the database.	<ol style="list-style-type: none"> <li>1. Test the user name and connection count for your application.</li> <li>2. Check the load balancing across your workloads to make sure the connections are distributed across different custom endpoints (primary and read replicas).</li> </ol>	AWS administrator

## Related resources

- [Types of Aurora endpoints](#)
- [Membership rules for custom endpoints](#)
- [End-to-end AWS CLI example for custom endpoints](#)
- [Amazon Aurora as an Alternative to Oracle RAC](#)
- [Challenges When Migrating from Oracle to PostgreSQL—and How to Overcome Them](#)

# Enable encrypted connections for PostgreSQL DB instances in Amazon RDS

Created by Rohit Kapoor (AWS)

**Environment:** PoC or pilot

**Technologies:** Databases; Networking; Security, identity, compliance

**Workload:** Open-source

**AWS services:** Amazon RDS; Amazon Aurora

## Summary

Amazon Relational Database Service (Amazon RDS) supports SSL encryption for PostgreSQL DB instances. Using SSL, you can encrypt a PostgreSQL connection between your applications and your Amazon RDS for PostgreSQL DB instances. By default, Amazon RDS for PostgreSQL uses SSL/TLS and expects all clients to connect by using SSL/TLS encryption. Amazon RDS for PostgreSQL supports TLS versions 1.1 and 1.2.

This pattern describes how you can enable encrypted connections for an Amazon RDS for PostgreSQL DB instance. You can use the same process to enable encrypted connections for Amazon Aurora PostgreSQL-Compatible Edition.

## Prerequisites and limitations

- An active AWS account
- An [Amazon RDS for PostgreSQL DB instance](#)
- An [SSL bundle](#)

## Architecture



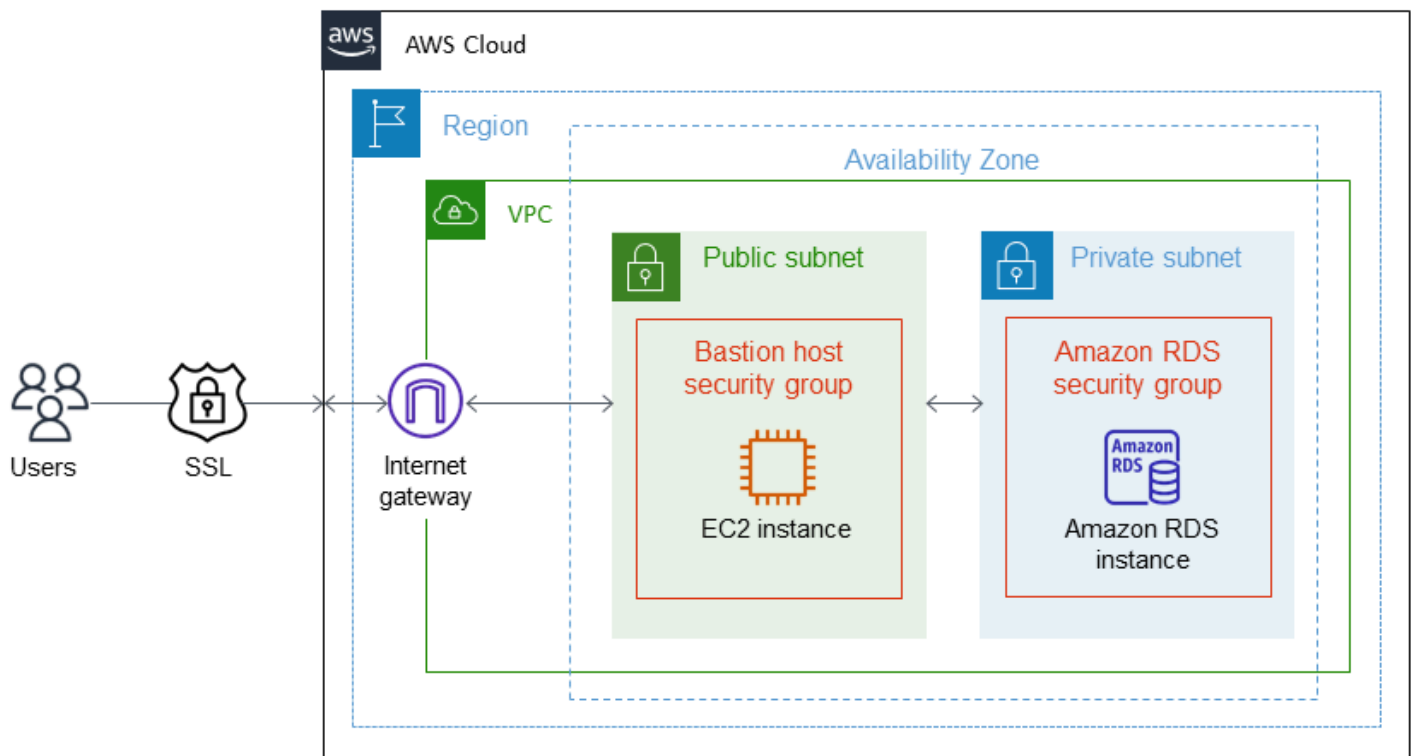

## Tools

- [pgAdmin](#) is an open-source administration and development platform for PostgreSQL. You can use pgAdmin on Linux, Unix, macOS, and Windows to manage your database objects in PostgreSQL 10 and later.
- [PostgreSQL editors](#) provide a more user-friendly interface to help you create, develop, and run queries, and to edit code according to your requirements.

## Best practices

- Monitor unsecure database connections.
- Audit database access rights.
- Make sure that backups and snapshots are encrypted at rest.
- Monitor database access.
- Avoid unrestricted access groups.
- Enhance your notifications with [Amazon GuardDuty](#).
- Monitor policy adherence regularly.

# Epics

## Download a trusted certificate and import it into your trust store

Task	Description	Skills required
Load a trusted certificate to your computer.	<p>To add certificates to the Trusted Root Certification Authorities store for your computer, follow these steps. (These instructions use Window Server as a example.)</p> <ol style="list-style-type: none"><li>1. In Windows Server, choose <b>Start, Run</b>, and then type <b>mmc</b>.</li><li>2. In the console, choose <b>File, Add/Remove Snap-in</b>.</li><li>3. Under <b>Available snap-ins</b>, choose <b>Certificates</b>, and then choose <b>Add</b>.</li><li>4. Under <b>This snap-in will always manage certificates for</b>, choose <b>Computer account, Next</b>.</li><li>5. Choose <b>Local computer, Finish</b>.</li><li>6. If you have no more snap-ins to add to the console, choose <b>OK</b>.</li><li>7. In the console tree, double-click <b>Certificates</b>.</li><li>8. Right-click <b>Trusted Root Certification Authorities</b>.</li></ol>	DevOps engineer, Migration engineer, DBA

Task	Description	Skills required
	<p>9. Choose <b>All Tasks</b>, <b>Import</b> to import the downloaded certificates.</p> <p>10 Follow the steps in the Certificate Import Wizard.</p>	

## Force SSL connections

Task	Description	Skills required
Create a parameter group and set the <code>rds.force_ssl</code> parameter.	<p>If the PostgreSQL DB instance has a custom parameter group, edit the parameter group and change <code>rds.force_ssl</code> to 1.</p> <p>If the DB instance uses the default parameter group that doesn't have <code>rds.force_ssl</code> enabled, create a new parameter group. You can modify the new parameter group by using the Amazon RDS API or manually as in the following instructions.</p> <p>To create a new parameter group:</p> <ol style="list-style-type: none"> <li>1. Sign in to the AWS Management console and open <a href="#">the Amazon RDS console</a> for the AWS Region that hosts the DB instance.</li> </ol>	DevOps engineer, Migration engineer, DBA

Task	Description	Skills required
	<ol style="list-style-type: none"><li>2. In the navigation pane, choose <b>Parameter groups</b>.</li><li>3. Choose <b>Create parameter group</b>, and set the following values:<ul style="list-style-type: none"><li>• For <b>Parameter group family</b>, choose <b>postgres14</b>.</li><li>• For <b>Group name</b>, type <b>pgsql-<code>&lt;database_instance&gt;-ssl</code></b>.</li><li>• For <b>Description</b>, enter a free-form description for the parameter group you're adding.</li><li>• Choose <b>Create</b>.</li></ul></li><li>4. Choose the parameter group that you created.</li><li>5. From <b>Parameter group actions</b>, choose <b>Edit</b>.</li><li>6. Find <b>rds.force_ssl</b> and change its setting to <b>1</b>.  <b>Note:</b> Conduct client-side testing before changing this parameter.</li><li>7. Choose <b>Save changes</b>.</li></ol> <p>To associate the parameter group with your PostgreSQL DB instance:</p>	

Task	Description	Skills required
	<ol style="list-style-type: none"> <li>1. On the Amazon RDS console, in the navigation pane, choose <b>Databases</b>, and then choose the PostgreSQL DB instance.</li> <li>2. Choose <b>Modify</b>.</li> <li>3. Under <b>Additional configuration</b>, choose the new parameter group, and then choose <b>Continue</b>.</li> <li>4. Under <b>Schedule modifications</b>, choose <b>Apply immediately</b>.</li> <li>5. Choose <b>Modify DB instance</b>.</li> </ol> <p>For more information, see the <a href="#">Amazon RDS documentation</a>.</p>	
Force SSL connections.	<p>Connect to the Amazon RDS for PostgreSQL DB instance. Connection attempts that don't use SSL are rejected with an error message. For more information, see the <a href="#">Amazon RDS documentation</a>.</p>	DevOps engineer, Migration engineer, DBA

## Install SSL extension

Task	Description	Skills required
Install the SSL extension.	<ol style="list-style-type: none"> <li>1. Launch a psql or pgAdmin connection as a DBA.</li> </ol>	DevOps engineer, Migration engineer, DBA

Task	Description	Skills required
	<p>2. Call the <code>ssl_is_used()</code> function to determine if SSL is being used.</p> <pre data-bbox="630 373 1029 457">select ssl_is_used();</pre> <p>The function returns <code>t</code> if the connection is using SSL; otherwise, it returns <code>f</code>.</p> <p>3. Install the SSL extension.</p> <pre data-bbox="630 718 1029 919">create extension sslinfo; show ssl; select ssl_cipher();</pre> <p>For more information, see the <a href="#">Amazon RDS documentation</a>.</p>	

## Configure your PostgreSQL client for SSL

Task	Description	Skills required
Configure a client for SSL.	By using SSL, you can start the PostgreSQL server with support for encrypted connections that use TLS protocols. The server listens for both standard and SSL connections on the same TCP port, and negotiates with any connecting client on whether to use SSL. By default, this is a client option.	DevOps engineer, Migration engineer, DBA

Task	Description	Skills required
	<p>If you're using the psql client:</p> <ol style="list-style-type: none"><li>1. Make sure that the Amazon RDS certificate has been loaded to your local computer.</li><li>2. Launch an SSL client connection by adding the following:</li></ol> <pre data-bbox="630 655 1029 1016">psql postgres -h SOMEHOST.amazonaws .com -p 8192 -U someuser sslmode=v erify-full sslrootce rt=rds-ssl-ca-cert .pem select ssl_cipher();</pre> <p>For other PostgreSQL clients:</p> <ul style="list-style-type: none"><li>• Modify the respective application public key parameter. This might be available as an option, as part of your connection string, or as a property on the connection page in GUI tools.</li></ul> <p>Review the following pages for these clients:</p> <ul style="list-style-type: none"><li>• <a href="#">pgAdmin documentation</a></li><li>• <a href="#">JDBC documentation</a></li></ul>	

## Troubleshooting

Issue	Solution
Cannot download the SSL certificate.	Check your connection to the website, and retry downloading the certificate to your local computer.

### Related resources

- [Amazon RDS for PostgreSQL documentation](#)
- [Using SSL with a PostgreSQL DB instance](#) (Amazon RDS documentation)
- [Secure TCP/IP Connections with SSL](#) (PostgreSQL documentation)
- [Using SSL](#) (JDBC documentation)



# Encrypt an existing Amazon RDS for PostgreSQL DB instance

Created by Piyush Goyal (AWS), Shobana Raghu (AWS), and Yaser Raja (AWS)

**Environment:** Production

**Technologies:** Databases;  
Security, identity, compliance

**AWS services:** Amazon RDS;  
AWS KMS; AWS DMS

## Summary

This pattern explains how to encrypt an existing Amazon Relational Database Service (Amazon RDS) for PostgreSQL DB instance in the Amazon Web Services (AWS) Cloud with minimal downtime. This process works for Amazon RDS for MySQL DB instances as well.

You can enable encryption for an Amazon RDS DB instance when you create it, but not after it's created. However, you can add encryption to an unencrypted DB instance by creating a snapshot of your DB instance, and then creating an encrypted copy of that snapshot. You can then restore a DB instance from the encrypted snapshot to get an encrypted copy of your original DB instance. If your project allows for downtime (at least for write transactions) during this activity, this is all you need to do. When the new, encrypted copy of the DB instance becomes available, you can point your applications to the new database. However, if your project doesn't allow for significant downtime for this activity, you need an alternate approach that helps minimize the downtime. This pattern uses the AWS Database Migration Service (AWS DMS) to migrate and continuously replicate the data so that the cutover to the new, encrypted database can be done with minimal downtime.

Amazon RDS encrypted DB instances use the industry standard AES-256 encryption algorithm to encrypt your data on the server that hosts your Amazon RDS DB instances. After your data is encrypted, Amazon RDS handles authentication of access and decryption of your data transparently, with minimal impact on performance. You don't need to modify your database client applications to use encryption.

## Prerequisites and limitations

### Prerequisites

- An active AWS account
- An unencrypted Amazon RDS for PostgreSQL DB instance

- Experience working with (creating, modifying, or stopping) AWS DMS tasks (see [Working with AWS DMS tasks](#) in the AWS DMS documentation)
- Familiarity with AWS Key Management Service (AWS KMS) for encrypting databases (see the [AWS KMS documentation](#))

## Limitations

- You can enable encryption for an Amazon RDS DB instance only when you create it, not after the DB instance is created.
- Data in [unlogged tables](#) will not be restored using snapshots. For more information, review [Best practices for working with PostgreSQL](#).
- You can't have an encrypted read replica of an unencrypted DB instance or an unencrypted read replica of an encrypted DB instance.
- You can't restore an unencrypted backup or snapshot to an encrypted DB instance.
- AWS DMS does not automatically transfers the Sequences therefore additional steps are required to handle this.

For more information, see [Limitations of Amazon RDS encrypted DB instances](#) in the Amazon RDS documentation.

## Architecture

### Source architecture

- Unencrypted RDS DB instance

### Target architecture

- Encrypted RDS DB instance
  - The destination RDS DB instance is created by restoring the DB snapshot copy of the source RDS DB instance.
  - An AWS KMS key is used for encryption while restoring the snapshot.
  - An AWS DMS replication task is used to migrate the data.

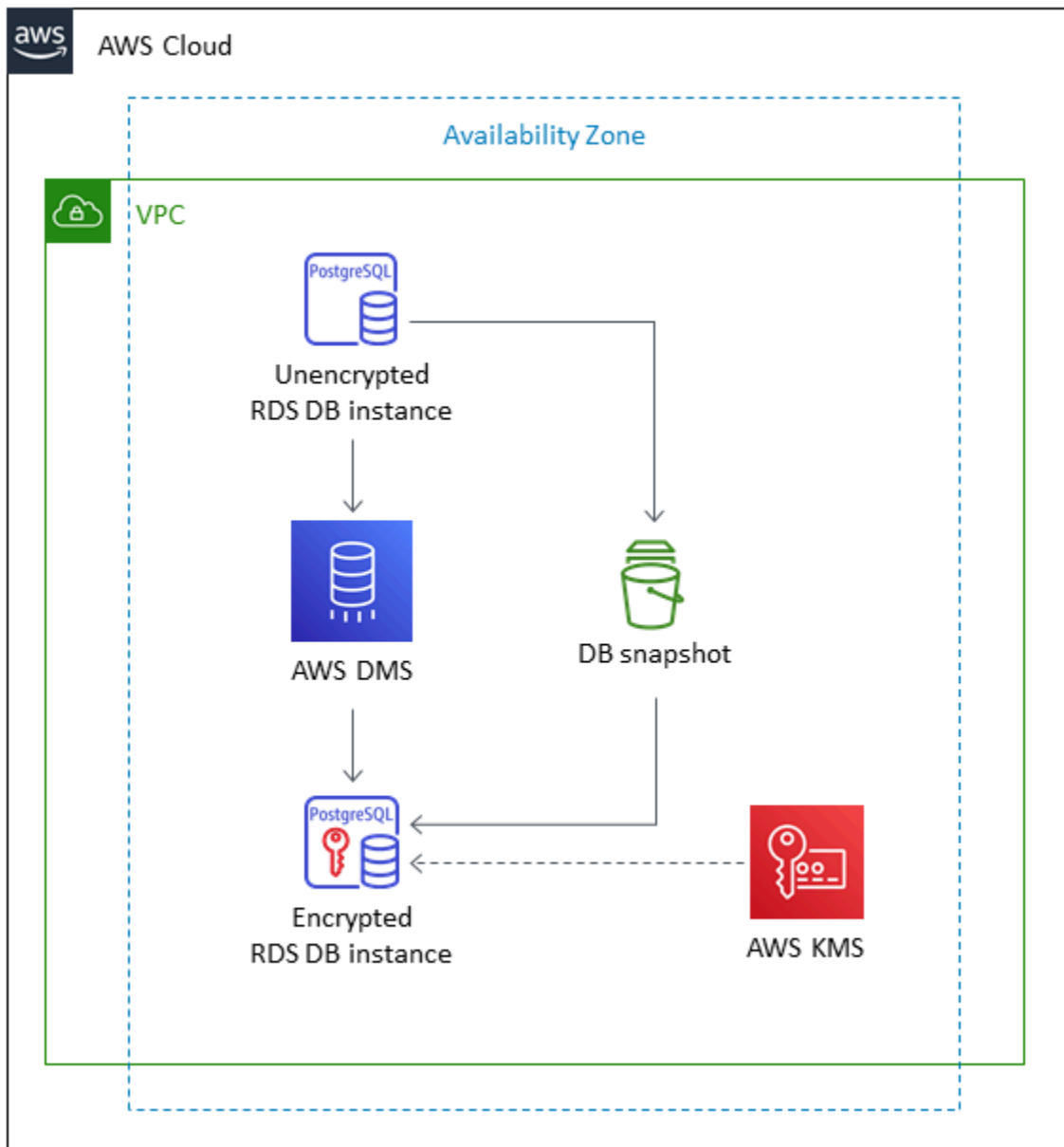

## Tools

### Tools used to enable encryption:

- **AWS KMS key for encryption** – When you create an encrypted DB instance, you can choose a customer managed key or the AWS managed key for Amazon RDS to encrypt your DB instance. If you don't specify the key identifier for a customer managed key, Amazon RDS uses the AWS managed key for your new DB instance. Amazon RDS creates an AWS managed key for Amazon RDS for your AWS account. Your AWS account has a different AWS managed key for Amazon RDS

for each AWS Region. For more information about using KMS keys for Amazon RDS encryption, see [Encrypting Amazon RDS Resources](#).

### Tools used for ongoing replication:

- AWS DMS – You can use AWS Database Migration Service (AWS DMS) to replicate changes from the source DB to the target DB. It is important to keep the source and target DB in sync to keep downtime to a minimum. For information about setting up AWS DMS and creating tasks, see the [AWS DMS documentation](#).

## Epics

### Create a snapshot of the source DB instance and encrypt it

Task	Description	Skills required
Check the details for the source PostgreSQL DB instance.	On the Amazon RDS console, choose the source PostgreSQL DB instance. On the <b>Configuration</b> tab, make sure that encryption isn't enabled for the instance. For a screen illustration, see the <a href="#">Additional information</a> section.	DBA
Create the DB snapshot.	Create a DB snapshot of the instance you want to encrypt. The amount of time it takes to create a snapshot depends on the size of your database. For instructions, see <a href="#">Creating a DB snapshot</a> in the Amazon RDS documentation.	DBA
Encrypt the snapshot.	In the Amazon RDS console navigation pane, choose <b>Snapshots</b> , and select the	DBA

Task	Description	Skills required
	<p>DB snapshot you created. For <b>Actions</b>, choose <b>Copy Snapshot</b>. Provide the destination AWS Region and the name of the DB snapshot copy in the corresponding fields. Select the <b>Enable Encryption</b> checkbox. For <b>Master Key</b>, specify the KMS key identifier to use to encrypt the DB snapshot copy. Choose <b>Copy Snapshot</b>. For more information, see <a href="#">Copying a snapshot</a> in the Amazon RDS documentation.</p>	

## Prepare the target DB instance

Task	Description	Skills required
Restore the DB snapshot.	<p>On the Amazon RDS console, choose <b>Snapshots</b>. Choose the encrypted snapshot that you created. For <b>Actions</b>, choose <b>Restore Snapshot</b>. For <b>DB Instance Identifier</b>, provide a unique name for the new DB instance. Review the instance details, and then choose <b>Restore DB Instance</b>. A new, encrypted DB Instance will be created from your snapshot. For more information, see <a href="#">Restoring from a DB</a></p>	DBA

Task	Description	Skills required
	<a href="#">snapshot</a> in the Amazon RDS documentation.	
Migrate data by using AWS DMS.	On the AWS DMS console, create an AWS DMS task. For <b>Migration type</b> , choose <b>Migrate existing data and replicate ongoing changes</b> . In <b>Task Settings</b> , for <b>Target table preparation mode</b> , choose <b>Truncate</b> . For more information, see <a href="#">Creating a task</a> in the AWS DMS documentation.	DBA
Enable data validation.	In <b>Task Settings</b> , choose <b>Enable validation</b> . This enables you to compare the source data to the target data to verify that the data was migrated accurately.	DBA
Disable constraints on the target DB instance.	<a href="#">Disable any triggers and foreign key constraints</a> on the target DB instance, and then start the AWS DMS task. For more information about disabling triggers and foreign key constraints, see the <a href="#">AWS DMS documentation</a> .	DBA

Task	Description	Skills required
Verify data.	After the full load is complete, verify the data on the target DB instance to see if it matches the source data. For more information, see <a href="#">AWS DMS data validation</a> in the AWS DMS documentation.	DBA

### Cut over to the target DB instance





Task	Description	Skills required
Stop write operations on the source DB instance.	Stop the write operations on the source DB instance so that application downtime can begin. Verify that AWS DMS has completed the replication for the data in the pipeline. Enable triggers and foreign keys on the target DB instance.	DBA
Update database sequences	If the source database contains any sequence numbers, verify and update the sequences in the target database.	DBA
Configure the application endpoint.	Configure your application connections to use the new Amazon RDS DB instance endpoints. The DB instance is now encrypted.	DBA, Application owner

## Related resources

- [Creating an AWS DMS task](#)
- [Monitoring replication tasks using Amazon CloudWatch](#)
- [Monitoring AWS DMS tasks](#)
- [Updating the Amazon RDS encryption key](#)

## Additional information

Checking the encryption for the source PostgreSQL DB instance:

Summary			
DB identifier rds-test	CPU  3.17%	Status  Available	Class db.t2.micro
Role Instance	Current activity  0 Sessions	Engine PostgreSQL	Region & AZ us-east-1a
Connectivity & security   Monitoring   Logs & events   <b>Configuration</b>   Maintenance & backups   Tags			
Instance			
Configuration	Instance class	Storage	Performance Insights
DB instance id rds-test	Instance class db.t2.micro	Encryption  Not Enabled	Performance Insights enabled Yes

Additional notes for this pattern:

- Enable replication on PostgreSQL by setting the `rds.logical_replication` parameter to 1.

**Important note:** Replication slots retain the write ahead log (WAL) files until the files are externally consumed—for example, by `pg_recvlogical`; by extract, transform, and load (ETL) jobs; or by AWS DMS. When you set the `rds.logical_replication` parameter value to 1, AWS DMS sets the `wal_level`, `max_wal_senders`, `max_replication_slots`, and `max_connections` parameters. If logical replication slots are present but there is no consumer for the WAL files retained by the replication slot, you might see an increase in the transaction log disk usage and a constant decrease in free storage space. For more information and steps to resolve this issue, see



the article [How can I identify what is causing the "No space left on device" or "DiskFull" error on Amazon RDS for PostgreSQL?](#) in the AWS Support Knowledge Center.

- Any schema changes that you make to the source DB instance after you create the DB snapshot will not be present on the target DB instance.
- After you create an encrypted DB instance, you can't change the KMS key used by that DB instance. Be sure to determine your KMS key requirements before you create your encrypted DB instance.
- You must disable triggers and foreign keys on the target DB instance before you run the AWS DMS task. You can re-enable these when the task is complete.

# Enforce automatic tagging of Amazon RDS databases at launch

Created by Susanne Kangnoh (AWS) and Archit Mathur (AWS)

**Environment:** Production

**Technologies:** Databases  
; CloudNative; Security,  
identity, compliance

**AWS services:** Amazon RDS;  
Amazon SNS; AWS CloudTrail;  
Amazon CloudWatch

## Summary

Amazon Relational Database Service (Amazon RDS) is a web service that makes it easier to set up, operate, and scale a relational database in the Amazon Web Services (AWS) Cloud. It provides cost-efficient, resizable capacity for an industry-standard relational database and manages common database administration tasks.

You can use tagging to categorize your AWS resources in different ways. Relational database tagging is useful when you have many resources in your account and you want to quickly identify a specific resource based on the tags. You can use Amazon RDS tags to add custom metadata to your RDS DB instances. A tag consists of a user-defined key and value. We recommend that you create a consistent set of tags to meet your organization's requirements.

This pattern provides an AWS CloudFormation template to help you monitor and tag RDS DB instances. The template creates an Amazon CloudWatch Events event that watches for the AWS CloudTrail **CreateDBInstance** event. (CloudTrail captures API calls for Amazon RDS as events.) When it detects this event, it calls an AWS Lambda function that automatically applies tag keys and values that you define. The template also sends out a notification that the instance has been tagged, by using Amazon Simple Notification Service (Amazon SNS).

## Prerequisites and limitations

### Prerequisites

- An active AWS account.
- An Amazon Simple Storage Service (Amazon S3) bucket to upload the Lambda code.
- An email address where you would like to receive tagging notifications.

## Limitations

- The solution supports CloudTrail **CreateDBInstance** events. It does not create notifications for any other events.

## Architecture

### Workflow architecture

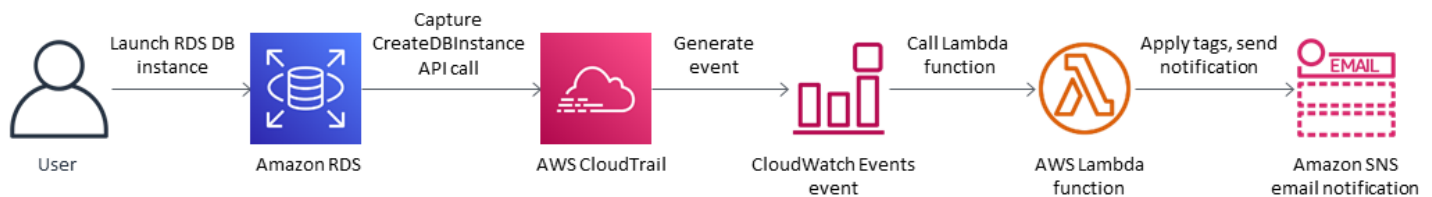

### Automation and scale

- You can use the AWS CloudFormation template multiple times for different AWS Regions and accounts. You need to run the template only once in each Region or account.

## Tools

### AWS services

- [AWS CloudTrail](#) – AWS CloudTrail is an AWS service that helps you with governance, compliance, and operational and risk auditing of your AWS account. Actions taken by a user, role, or an AWS service are recorded as events in CloudTrail.
- [Amazon CloudWatch Events](#) – Amazon CloudWatch Events delivers a near real-time stream of system events that describe changes in AWS resources. CloudWatch Events becomes aware of operational changes as they occur and takes corrective action as necessary, by sending messages to respond to the environment, activating functions, making changes, and capturing state information.
- [AWS Lambda](#) – AWS Lambda is a compute service that supports running code without needing to provision or manage servers. Lambda runs your code only when needed and scales automatically, from a few requests per day to thousands per second. You pay only for the compute time that you consume—there is no charge when your code is not running.

- [Amazon S3](#) – Amazon Simple Storage Service (Amazon S3) is a highly scalable object storage service that can be used for a wide range of storage solutions, including websites, mobile applications, backups, and data lakes.
- [Amazon SNS](#) – Amazon Simple Notification Service (Amazon SNS) is a web service that enables applications, end-users, and devices to instantly send and receive notifications from the cloud.

## Code

This pattern includes an attachment with two files:

- `index.zip` is a compressed file that includes the Lambda code for this pattern.
- `rds.yaml` is a CloudFormation template that deploys the Lambda code.

See the *Epics* section for information about how to use these files.

## Epics

### Deploy the Lambda code

Task	Description	Skills required
Upload the code to an S3 bucket.	Create a new S3 bucket or use an existing S3 bucket to upload the attached <code>index.zip</code> file (Lambda code). This bucket must be in the same AWS Region as the resources (RDS DB instances) that you want to monitor.	Cloud architect
Deploy the CloudFormation template.	Open the Cloudformation console in the same AWS Region as the S3 bucket, and deploy the <code>rds.yaml</code> file that's provided in the attachment. In the next	Cloud architect

Task	Description	Skills required
	epic, provide values for the template parameters.	

### Complete the parameters in the CloudFormation template

Task	Description	Skills required
Provide the S3 bucket name.	Enter the name of the S3 bucket that you created or selected in the first epic. This S3 bucket contains the .zip file for the Lambda code and must be in the same AWS Region as the CloudFormation template and the RDS DB instances that you want to monitor.	Cloud architect
Provide the S3 key.	Provide the location of the Lambda code .zip file in your S3 bucket, without leading slashes (for example, <code>index.zip</code> or <code>controls/index.zip</code> ).	Cloud architect
Provide an email address.	Provide an active email address where you want to receive violation notifications.	Cloud architect
Specify a logging level.	Specify the logging level and verbosity. Info designates detailed informational messages on the application's progress and should be used only for debugging	Cloud architect

Task	Description	Skills required
	. <code>Error</code> designates error events that could still allow the application to continue running. <code>Warning</code> designates potentially harmful situations.	
Enter the tag keys and values for your RDS DB instances.	Enter the required tag keys and values that you want to automatically apply to the RDS instance. For more information, see <a href="#">Tagging Amazon RDS resources</a> in the AWS documentation.	Cloud architect

## Confirm the subscription

Task	Description	Skills required
Confirm the email subscription.	When the CloudFormation template deploys successfully, it sends a subscription email message to the email address you provided. To receive notifications when your instances are tagged, you must confirm this email subscription.	Cloud architect

## Related resources

- [Creating a bucket](#) (Amazon S3 documentation)
- [Tagging Amazon RDS resources](#) (Amazon Aurora documentation)

- [Uploading objects](#) (Amazon S3 documentation)
- [Creating a CloudWatch Events rule that triggers on an AWS API call using AWS CloudTrail](#) (Amazon CloudWatch documentation)

## Attachments

To access additional content that is associated with this document, unzip the following file:  
[attachment.zip](#)

# Estimate the cost of a DynamoDB table for on-demand capacity

Created by Moinul Al-Mamun (AWS)

**Environment:** Production

**Technologies:** Databases;  
CloudNative; Serverless; Cost  
management

**AWS services:** Amazon  
DynamoDB

## Summary

[Amazon DynamoDB](#) is a NoSQL transactional database that provides single-digit millisecond latency even at petabytes scale. This Amazon Web Services (AWS) serverless offering is getting popular because of its consistent performance and scalability. You do not need to provision underlying infrastructure. Your single table can grow up to petabytes.

With on-demand capacity mode, you pay per request for the data reads and writes that your application performs on the tables. AWS charges are based on the accumulated read request units (RRUs) and write request units (WRUs) in a month. DynamoDB monitors the size of your table continuously throughout the month to determine your storage charges. It supports continuous backup with point-in-time-recovery (PITR). DynamoDB monitors the size of your PITR-enabled tables continuously throughout the month to determine your backup charges.

To estimate the DynamoDB cost for a project, it's important to calculate how much RRU, WRU, and storage will be consumed at different stages of your product lifecycle. For a rough cost estimation, you can use [AWS Pricing Calculator](#), but you must provide an approximate number of RRUs, WRUs, and storage requirements for your table. These can be difficult to estimate at the beginning of the project. AWS Pricing Calculator doesn't consider data growth rate or item size, and it doesn't consider the number of reads and writes for the base table and global secondary indexes (GSIs) separately. To use AWS Pricing Calculator, you must estimate all those aspects to assume ballpark figures for WRU, RRU, and storage size to obtain your cost estimation.

This pattern provides a mechanism and a re-usable Microsoft Excel template to estimate basic DynamoDB cost factors, such as write, read, storage, backup and recovery cost, for on-demand capacity mode. It is more granular than AWS Pricing Calculator, and it considers base table and GSIs requirements independently. It also considers the monthly item data growth rate and forecasts costs for three years.



## Prerequisites and limitations

### Prerequisites

- Basic knowledge of DynamoDB and DynamoDB data model design
- Basic knowledge of DynamoDB pricing, WRU, RRU, storage, and backup and recovery (for more information, see [Pricing for On-Demand Capacity](#))
- Knowledge of your data, data model, and item size in DynamoDB
- Knowledge of DynamoDB GSIs

### Limitations

- The template provides you with an approximate calculation, but it isn't appropriate for all configurations. To get a more accurate estimate, you must measure the individual item size for each item in the base table and GSIs.
- For a more accurate estimate, you must consider the expected number of writes (insert, update, and delete) and reads for each item in an average month.
- This pattern supports estimating only write, read, storage, and backup and recovery costs for next few years based on fixed data growth assumptions.

## Tools

### AWS services

- [Amazon DynamoDB](#) is a fully managed NoSQL database service that provides fast, predictable, and scalable performance.

### Other tools

- [AWS Pricing Calculator](#) is a web-based planning tool that you can use to create estimates for your AWS use cases.

## Best practices

To help keep costs low, consider the following DynamoDB design best practices.

- [Partition key design](#) – Use a high-cardinality partition key to distribute load evenly.
- [Adjacency list design pattern](#) – Use this design pattern for managing one-to-many and many-to-many relationships.
- [Sparse index](#) – Use sparse index for your GSIs. When you create a GSI, you specify a partition key and optionally a sort key. Only items in the base table that contain a corresponding GSI partition key appear in the sparse index. This helps to keep GSIs smaller.
- [Index overloading](#) – Use the same GSI for indexing various types of items.
- [GSI write sharding](#) – Shard wisely to distribute data across the partitions for efficient and faster queries.
- [Large items](#) – Store only metadata inside the table, save the blob in Amazon S3, and keep the reference in DynamoDB. Break large items into multiple items, and efficiently index by using sort keys.

For more design best practices, see the [Amazon DynamoDB Developer Guide](#).

## Epics

### Extract item information from your DynamoDB data model

Task	Description	Skills required
Get item size.	<ol style="list-style-type: none"> <li>1. Check how many different types of item you are going to store in your table.</li> <li>2. To calculate the size of each item in kilobytes, add the Key and Value size of each attribute.</li> <li>3. Calculate item size for a base table and for each GSI.</li> </ol>	Data engineer
Estimate the write cost.	To estimate write cost in on-demand capacity mode, first you have to measure how many WRUs will be consumed	Data engineer

Task	Description	Skills required
	<p>in a month. For that, you need to consider the following factors:</p> <ul style="list-style-type: none"><li>• Number of create, update, and delete operations for each item in a month.</li><li>• Number of available GSIs. Consider each index independently.<ul style="list-style-type: none"><li>• Average size of an index item</li><li>• Number of synchronization times on an index</li></ul></li><li>• How many new things (for example, components or products) will be added in the table each month? The number of added things could be different every month, but you can assume an average growth rate based on your business cases.</li></ul> <p>For more information, see the <i>Additional information</i> section.</p>	

Task	Description	Skills required
Estimate the read cost.	<p>To estimate read cost in on-demand mode, first you have to measure how many RRUs will be consumed in a month. For that, you need to consider the following factors:</p> <ul style="list-style-type: none"><li>• Number of available GSIs. Consider each index independently.<ul style="list-style-type: none"><li>• Average size of an index item</li></ul></li><li>• Average number of reads per product per month.</li><li>• Number of total available things (components or products) in the DynamoDB table.</li></ul>	Data engineer, App developer

Task	Description	Skills required
Estimate the storage size and cost.	<p>First, estimate the average monthly storage requirement based on your item size in the table. Then calculate storage cost by multiplying storage size by the per GB storage price for your AWS Region.</p> <p>If you already entered data for estimating the write cost, you don't need to enter it again for calculating storage size. Otherwise, to estimate storage size, you need to consider the following factors:</p> <ul style="list-style-type: none"><li>• Number of data items in a module (product) based on your table design.</li><li>• Average item size in kilobytes.</li><li>• Number of available GSIs. Consider each index independently.<ul style="list-style-type: none"><li>• Average size of an index item</li></ul></li><li>• How many new products will be added in the table each month? The number of new products could be different every month, but you can assume an average growth rate based</li></ul>	Data engineer

Task	Description	Skills required
	on your business cases. This example uses an average of 10 million new products each month.	

### Enter the item and object information in the Excel template

Task	Description	Skills required
Download the Excel template from the Attachments section, and adjust it for your use case table.	<ol style="list-style-type: none"> <li>1. Download the Excel template.</li> <li>2. Adjust the business module and GSIs, based on your table design.</li> </ol>	Data engineer
Enter information in the Excel template.	<ol style="list-style-type: none"> <li>1. Update item information in the sheet. Update data only in orange cells.</li> <li>2. Adjust the object numbers: How much could be added into the table each month?</li> <li>3. Update the WRU and RRU prices per million for your AWS Region.</li> <li>4. Update the storage and backup prices per GB-month for your AWS Region.</li> <li>5. Update the recovery price per GB for your AWS Region.</li> </ol>	Data engineer

Task	Description	Skills required
	In the template, there are three items, or entities: information, metadata, and relationship. There are two GSIs. For your use case, if you need more items, create new rows. If you need more GSIs, copy an existing GSI block, and paste to create as many GSI blocks as you need. Then adjust the SUM and TOTAL column calculations.	

## Related resources

### References

- [Amazon DynamoDB pricing for on-demand capacity](#)
- [AWS Pricing Calculator for DynamoDB](#)
- [Best practices for designing and architecting with DynamoDB](#)
- [Getting started with DynamoDB](#)

### Guides and patterns

- [Modeling data with Amazon DynamoDB](#)
- [Estimate storage costs for an Amazon DynamoDB table](#)

## Additional information

### Write cost calculation example

The DynamoDB data model design shows three items for a product, and an average item size of 4 KB. When you add a new product into the DynamoDB base table, it consumes the number of items

\* (item size/1 KB write unit) =  $3 * (4/1) = 12$  WRU. In this example, for writing 1 KB, the product consumes 1 WRU.

### Read cost calculation example

To get the RRU estimation, consider the average of how many times each item will be read in a month. For example, the Information item will be read, on average, 10 times in a month, and the metadata item will be read two times, and the relationship item will be read five times. In the example template, total RRU for all components = number of new components created each month \* RRU per component per month = 10 million \* 17 RRU = 170 million RRU each month.

Every month, new things (components or products) will be added, and the total number of products will grow over time. So, RRU requirements will also grow over time.

- For the first month RRU, consumption will be 170 million.
- For the second month, RRU consumption will be  $2 * 170$  million = 340 million.
- For the third month RRU consumption will be  $3 * 170$  million = 510 million.

The following graph shows monthly RRU consumption and cost forecasting.

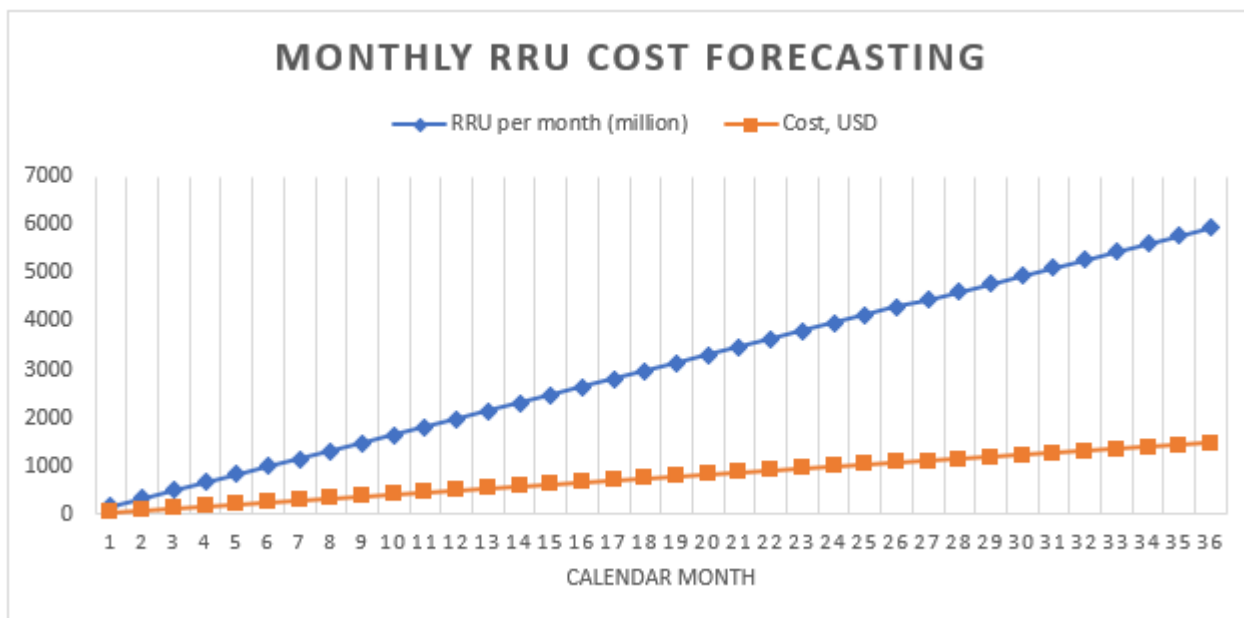

Note that prices within the graph are for illustration only. To create accurate forecasts for your use case, check the AWS pricing page, and use those prices in the Excel sheet.

### Storage, backup, and recovery cost calculation examples



DynamoDB storage, backup and restore all are connected with each other. Backup is directly connected with storage, and recovery is directly connected with backup size. As the table size increases, corresponding storage, backup, and restore costs will increase proportionally.

### *Storage size and cost*

Storage cost will increase over time based on your data growth rate. For example, assume that the average size of a component or product in the base table and GSIs is 11 KB, and 10 million new products will be added every month into your database table. In that case, your DynamoDB table size will grow  $(11 \text{ KB} * 10 \text{ million})/1024/1024 = 105 \text{ GB}$  per month. At the first month, your table storage size will be 105 GB, at second month it will be  $105 + 105 = 210 \text{ GBs}$ , and so on.

- For the first month, storage cost will be  $105 \text{ GB} * \text{storage price per GB for your AWS Region}$ .
- For the second month, storage cost will be  $210 \text{ GB} * \text{storage price per GB for your Region}$ .
- For the third month, storage cost will be  $315 \text{ GB} * \text{storage price per GB for your Region}$ .

For storage size and cost for next three years, see the *Storage size and forecasting* section.

### *Backup cost*

Backup cost will increase over time based on your data growth rate. When you turn on continuous backup with point-in-time-recovery (PITR), continuous backup charges are based on average storage GB-Month. In a calendar month, the average backup size would be the same as your table storage size, although the actual size could be a bit different. As new products will be added every month, the total storage size and the backup size will grow over time. For example, for the first month, the average backup size of 105 GB could grow to 210 GB for the second month.

- For the first month, backup cost will be  $105 \text{ GB-month} * \text{continuous backup price per GB for your AWS Region}$ .
- For the second month, backup cost will be  $210 \text{ GB-month} * \text{continuous backup price per GB for your Region}$ .
- For the third month, backup cost will be  $315 \text{ GB-month} * \text{continuous backup price per GB for your Region}$ .
- and, so on

Backup cost is included in the graph in the *Storage size and cost forecasting* section.

### *Recovery cost*

When you are taking continuous backup with PITR enabled, recovery operation charges are based on the size of the restore. Each time that you restore, you pay based on gigabytes of restored data. If your table size is large and you perform restore multiple times in a month, it will be costly.

To estimate restore cost, this example assumes that you perform a PITR recovery one time each month at the end of the month. The example uses the monthly average backup size as the restore data size for that month. For the first month, the average backup size is 105 GB, and for the recovery at end of the month, the restore data size would be 105 GB. For the second month, it would be 210 GBs, and so on.

Recovery cost will increase over time based on your data growth rate.

- For the first month, recovery cost will be 105 GB \* restore price per GB for your AWS Region.
- For the second month, recovery cost will be 210 GB \* restore price per GB for your Region.
- For the third month, recovery cost will be 315 GB \* restore price per GB for your Region.

For more information, see the Storage, backup and recovery tab in the Excel template and the graph in the following section.

### *Storage size and cost forecasting*

In the template, actual billable storage size is calculated by subtracting the free tier 25 GB per month for the Standard table class. In the sheet, you will get a forecasting graph broken out into monthly values.

The following example chart forecasts monthly storage size in GB, billable storage cost, on-demand backup cost, and recovery cost for next 36 calendar months. All costs are in USD. From the graph, it's clear that storage, backup, and recovery costs increase proportionally to increases in storage size.

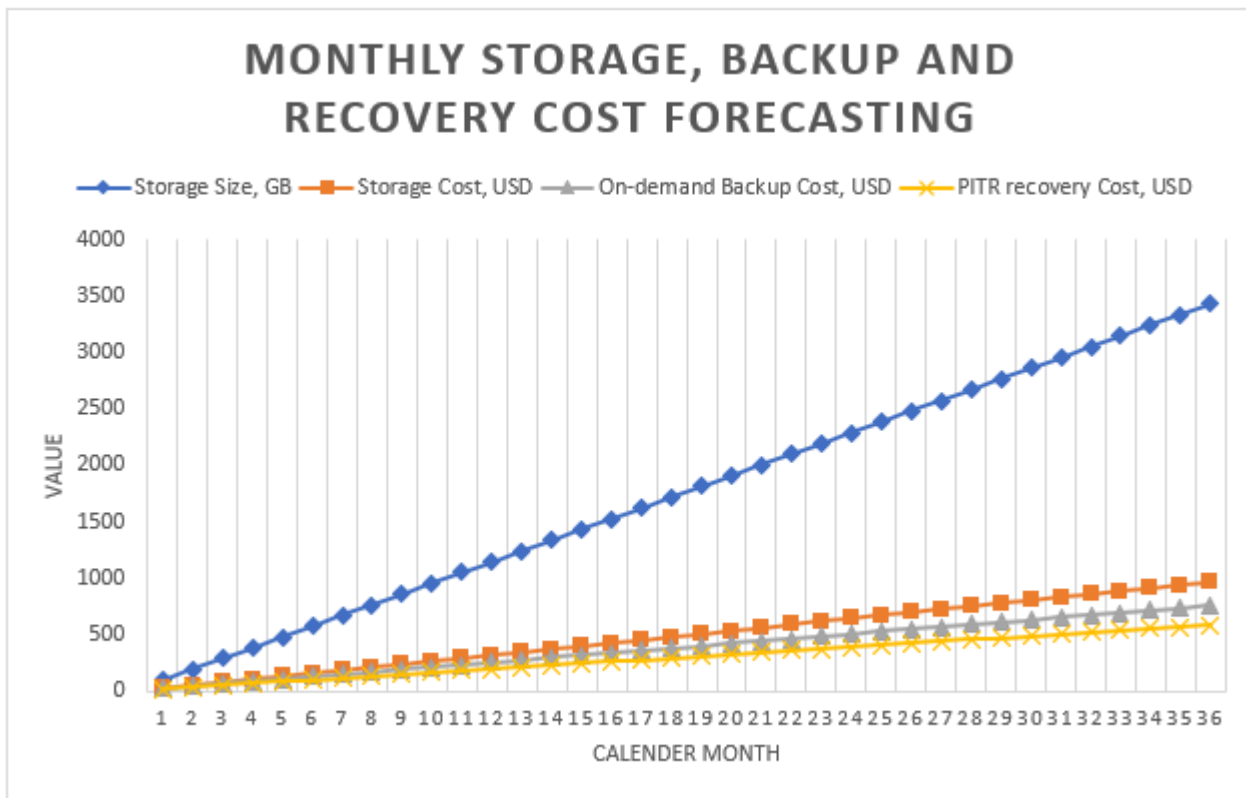

Note that prices used in the graph are for illustration purposes only. To create accurate prices for your use case, check the AWS pricing page, and use those prices in the Excel template.

## Attachments

To access additional content that is associated with this document, unzip the following file: [attachment.zip](#)

# Estimate storage costs for an Amazon DynamoDB table

*Created by Moinul Al-Mamun*

**Environment:** PoC or pilot

**Technologies:** Databases;  
Big data; Cost management;  
Storage & backup

**AWS services:** Amazon  
DynamoDB

## Summary

[Amazon DynamoDB](#) is a NoSQL transactional database that provides single-digit millisecond latency even at petabytes scale. This Amazon Web Services (AWS) serverless offering is getting popular because of its consistent performance and scalability. You do not need to provision storage. Your single table can grow up to petabytes.

DynamoDB monitors the size of your table continuously throughout the month to determine your storage charges. AWS then charges you for the average size of storage in gigabytes. The more that your table grows over time, the more that your storage cost will grow. To calculate storage cost, you can use [AWS Pricing Calculator](#), but you need to provide the approximate size of your table, including global secondary indexes (GSIs), which is really difficult to estimate at the beginning of the project. Also, AWS Pricing Calculator does not consider the data growth rate.

This pattern provides a mechanism and a reusable Microsoft Excel template to calculate DynamoDB storage size and cost. It considers the storage requirements for the base table and the GSIs independently. It calculates storage size by considering the size of your individual items and data growth rate over time.

To get an estimate, insert two pieces of information into the template:

- The individual item size in kilobytes for the base table and GSIs
- How many new objects or products could be added to the table, on average, in a month, (for example, 10 million)

The template will generate a storage and cost forecasting graph for the next three years, which is shown in the following example.

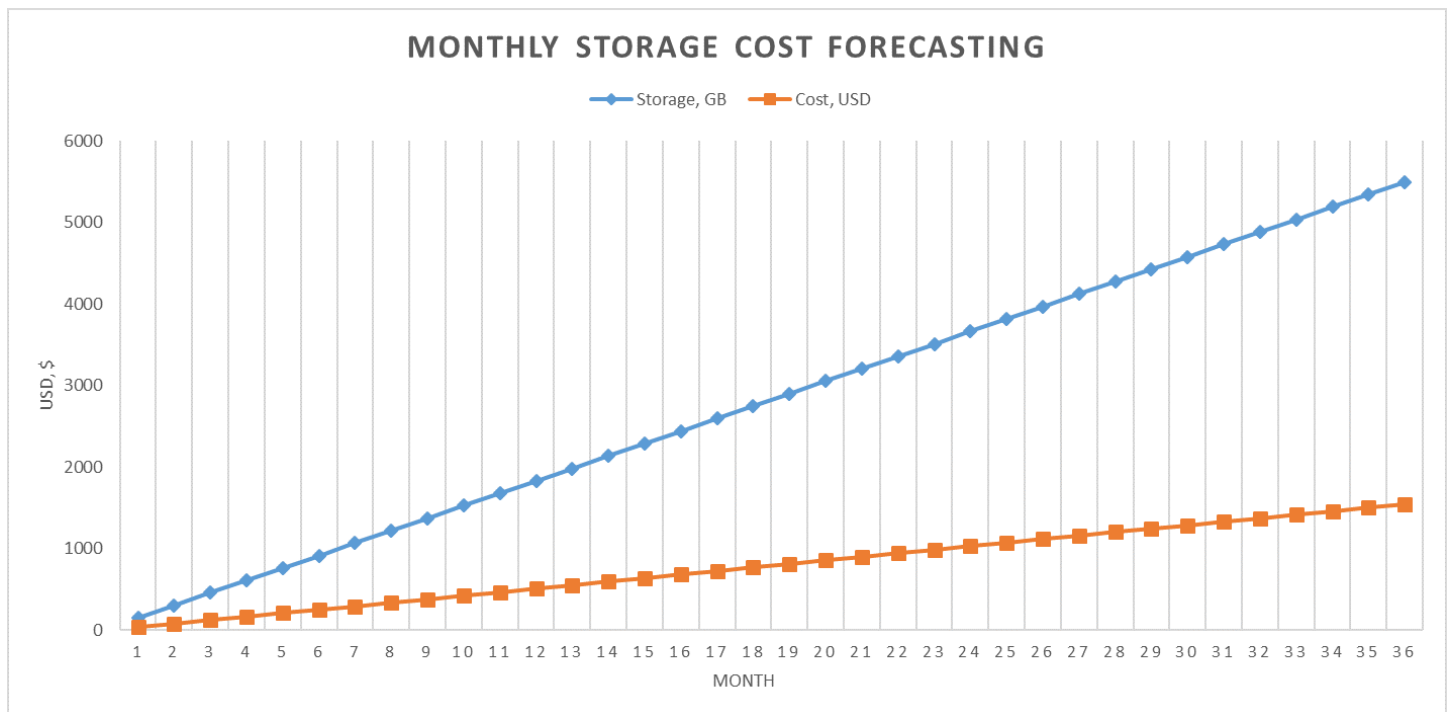

## Prerequisites and limitations

### Prerequisites

- Basic knowledge of DynamoDB, and DynamoDB storage and pricing
- Knowledge of your data, data model, and item size in DynamoDB
- Knowledge of DynamoDB global secondary indexes (GSIs)

### Limitations

- The template provides you with an approximate calculation, but it isn't appropriate for all configurations. To get a more accurate estimate, you must measure the individual item size for each item in the base table and GSIs.
- This pattern supports estimating only storage size and cost for the next few years based on fixed data growth assumptions.

## Tools

### AWS services

- [Amazon DynamoDB](#) is a fully managed NoSQL database service that provides fast, predictable, and scalable performance.

## Other tools

- [AWS Pricing Calculator](#) is a web-based planning tool that you can use to create estimates for your AWS use cases.

## Epics

### Extract item information from your DynamoDB data model

Task	Description	Skills required
Get item size.	<ol style="list-style-type: none"><li>1. Check how many different types of item you are going to store in your table.</li><li>2. To calculate the size of each item in kilobytes add the Key and Value size of each attribute.</li><li>3. Calculate item size for a base table and for each GSI.</li></ol>	Data engineer
Get the number of objects added in a month.	Estimate how many components, or objects, will be added into the DynamoDB table, on average, in one month.	Data engineer

## Enter the item and object information in the Excel template

Task	Description	Skills required
Download Excel sheet from the attached document, and adjust it for your use case table.	<ol style="list-style-type: none"><li>1. Download the Excel template.</li><li>2. Adjust the business module and GSIs, based on your table design.</li></ol>	Data engineer
Enter information in the Excel template.	<ol style="list-style-type: none"><li>1. Update item information into the sheet.</li><li>2. Adjust the object numbers: How much could be added into the table each month?</li><li>3. Update the storage price per GB-month for your AWS Region.</li></ol>	Data engineer

## Related resources

- [Amazon DynamoDB On-Demand pricing](#)
- [AWS Pricing Calculator for DynamoDB](#)

## Additional information

Note that the attached template forecasts only storage size and cost for Standard storage table class. Based on the forecast for storage costs, and considering individual item size and product or object growth rate, you can estimate the following:

- Data export cost
- Backup and recovery cost
- Data storage requirements.

## Amazon DynamoDB data storage cost

DynamoDB monitors the size of your tables continuously to determine your storage charges. DynamoDB measures the size of your billable data by adding the raw byte size of your data plus a per-item storage overhead that depends on the features you have enabled. For more information, see the [DynamoDB Developer Guide](#).

The price for data storage depends on your table class. The first 25 GB stored each month is free if you're using the DynamoDB Standard table class. For more information about storage costs for Standard table class and Standard-Infrequent Access table class in different AWS Regions, see [Pricing for On-Demand Capacity](#).

## Attachments

To access additional content that is associated with this document, unzip the following file: [attachment.zip](#)



# Estimate the Amazon RDS engine size for an Oracle database by using AWR reports

Created by Abhishek Verma (AWS) and Eduardo Valentim (AWS)

<b>Environment:</b> Production	<b>Source:</b> Oracle Database	<b>Target:</b> Amazon RDS or Amazon Aurora
<b>R Type:</b> Re-architect	<b>Workload:</b> Oracle	<b>Technologies:</b> Databases; Migration
<b>AWS services:</b> Amazon RDS; Amazon Aurora		

## Summary

When you migrate an Oracle database to Amazon Relational Database Service (Amazon RDS) or Amazon Aurora, computing the CPU, memory, and disk I/O for the target database is a key requirement. You can estimate the required capacity of the target database by analyzing the Oracle Automatic Workload Repository (AWR) reports. This pattern explains how to use AWR reports to estimate these values.

The source Oracle database could be on premises or hosted on an Amazon Elastic Compute Cloud (Amazon EC2) instance, or it could be an Amazon RDS for Oracle DB instance. The target database could be any Amazon RDS or Aurora database.

**Note:** Capacity estimates will be more precise if your target database engine is Oracle. For other Amazon RDS databases, the engine size can vary due to differences in database architecture.

We recommend that you run the performance test before you migrate your Oracle database.

## Prerequisites and limitations

### Prerequisites

- An Oracle Database Enterprise Edition license and Oracle Diagnostics Pack license in order to download AWR reports.

## Product versions

- All Oracle Database editions for versions 11g (versions 11.2.0.3.v1 and later) and up to 12.2, and 18c,19c.
- This pattern doesn't cover Oracle Engineered Systems or Oracle Cloud Infrastructure (OCI).

## Architecture

### Source technology stack

One of the following:

- An on-premises Oracle database
- An Oracle database on an EC2 instance
- An Amazon RDS for Oracle DB instance

### Target technology stack

- Any Amazon RDS or Amazon Aurora database

### Target architecture

For information about the full migration process, see the pattern [Migrate an Oracle database to Aurora PostgreSQL using AWS DMS and AWS SCT](#).

### Automation and scale

If you have multiple Oracle databases to migrate and you want to use additional performance metrics, you can automate the process by following the steps described in the blog post [Right-size Amazon RDS instances at scale based on Oracle performance metrics](#).

## Tools

- [Oracle Automatic Workload Repository \(AWR\)](#) is a repository that's built into Oracle databases. It periodically gathers and stores system activity and workload data, which is then analyzed by Automatic Database Diagnostic Monitor (ADDM). AWR takes snapshots of system performance data periodically (by default, every 60 minutes) and stores the information (by default, up to 8 days). You can use AWR views and reports to analyze this data.

## Best practices

- To calculate resource requirements for your target database, you can use a single AWR report, multiple AWR reports, or dynamic AWR views. We recommend that you use multiple AWR reports during the peak load period to estimate the resources required to handle those peak loads. In addition, dynamic views provide more data points that help you calculate resource requirements more precisely.
- You should estimate IOPS only for the database that you plan to migrate, not for other databases and processes that use the disk.
- To calculate how much I/O is being used by the database, don't use the information in the Load Profile section of the AWR report. Use the I/O Profile section instead, if it's available, or skip to the Instance Activity Stats section and look at the total values for physical read and write operations.
- When you estimate CPU utilization, we recommend that you use the database metrics method instead of operating system (OS) statistics, because it's based on the CPU used only by databases. (OS statistics also include CPU usage by other processes.) You should also check CPU-related recommendations in the ADDM report to improve performance after migration.
- Consider I/O throughput limits—Amazon Elastic Block Store (Amazon EBS) throughput and network throughput—for the specific instance size when you're determining the right instance type.
- Run the performance test before migration to validate the engine size.

## Epics

### Create an AWR report

Task	Description	Skills required
Enable the AWR report.	To enable the report, follow the instructions in the <a href="#">Oracle documentation</a> .	DBA
Check the retention period.	To check the retention period of the AWR report, use the following query.	DBA

Task	Description	Skills required
Generate the snapshot.	<pre>SQL&gt; SELECT snap_interval,retention FROM dba_hist_wr_control;</pre> <p>If the AWR snapshot interval isn't granular enough to capture the spike of the peak workload, you can generate the AWR report manually. To generate the manual AWR snapshot, use the following query.</p> <pre>SQL&gt; EXEC dbms_workload_repository.create_snapshot;</pre>	DBA
Check recent snapshots.	<p>To check recent AWR snapshots, use the following query.</p> <pre>SQL&gt; SELECT snap_id, to_char(begin_interval_time,'dd/MON/yy hh24:mi') Begin_Interval, to_char(end_interval_time,'dd/MON/yy hh24:mi') End_Interval FROM dba_hist_snapshot ORDER BY 1;</pre>	DBA

## Estimate disk I/O requirements

Task	Description	Skills required
Choose a method.	<p>IOPS is the standard measure of input and output operations per second on a storage device, and includes both read and write operations.</p> <p>If you are migrating an on-premises database to AWS, you need to determine the peak disk I/O used by the database. You can use the following methods to estimate disk I/O for your target database:</p> <ul style="list-style-type: none"> <li>• Load Profile section of the AWR report</li> <li>• Instance Activity Stats section of the AWR report (use this section for Oracle Database 12c or later)</li> <li>• I/O Profile section of the AWR report (use this section for Oracle Database versions before 12c)</li> <li>• AWR views</li> </ul> <p>The following steps describe these four methods.</p>	DBA
Option 1: Use the load profile.	The following table shows an example of the Load Profile section of the AWR report.	DBA

Task	Description	Skills required																																								
	<p><b>Important:</b> For more accurate information, we recommend that you use option 2 (I/O profiles) or option 3 (instance activity statistics) instead of the load profile.</p> <table border="1" data-bbox="592 541 1029 1795"> <thead> <tr> <th></th> <th>Per Seco</th> <th>Per Tran</th> <th>Per Exec</th> <th>Per Call</th> </tr> </thead> <tbody> <tr> <td><b>DB Time</b></td> <td>26.6</td> <td>0.2</td> <td>0.00</td> <td>0.02</td> </tr> <tr> <td><b>DB CPU</b></td> <td>18.0</td> <td>0.1</td> <td>0.00</td> <td>0.01</td> </tr> <tr> <td><b>Backend CPU</b></td> <td>0.2</td> <td>0.0</td> <td>0.00</td> <td>0.00</td> </tr> <tr> <td><b>Redo size (byte)</b></td> <td>2,451.9</td> <td>17,000</td> <td></td> <td></td> </tr> <tr> <td><b>Logi read (block)</b></td> <td>3,371.5</td> <td>23,400</td> <td></td> <td></td> </tr> <tr> <td><b>Block chan</b></td> <td>21,600</td> <td>150,000</td> <td></td> <td></td> </tr> <tr> <td><b>Phys read (block)</b></td> <td>13,500</td> <td>94,400</td> <td></td> <td></td> </tr> </tbody> </table>		Per Seco	Per Tran	Per Exec	Per Call	<b>DB Time</b>	26.6	0.2	0.00	0.02	<b>DB CPU</b>	18.0	0.1	0.00	0.01	<b>Backend CPU</b>	0.2	0.0	0.00	0.00	<b>Redo size (byte)</b>	2,451.9	17,000			<b>Logi read (block)</b>	3,371.5	23,400			<b>Block chan</b>	21,600	150,000			<b>Phys read (block)</b>	13,500	94,400			
	Per Seco	Per Tran	Per Exec	Per Call																																						
<b>DB Time</b>	26.6	0.2	0.00	0.02																																						
<b>DB CPU</b>	18.0	0.1	0.00	0.01																																						
<b>Backend CPU</b>	0.2	0.0	0.00	0.00																																						
<b>Redo size (byte)</b>	2,451.9	17,000																																								
<b>Logi read (block)</b>	3,371.5	23,400																																								
<b>Block chan</b>	21,600	150,000																																								
<b>Phys read (block)</b>	13,500	94,400																																								

Task	Description	Skills required
	<p><b>Phys</b> 3,46 24.1  <b>writ</b>  <b>(blo</b></p> <p><b>Reac</b> 3,58 24.9  <b>IO</b>  <b>requ</b></p> <p><b>Writ</b> 574. 4.0  <b>IO</b>  <b>requ</b></p> <p><b>Reac</b> 106. 0.7  <b>IO</b>  <b>(MB)</b></p> <p><b>Writ</b> 27.1 0.2  <b>IO</b>  <b>(MB)</b></p> <p><b>IM</b> 0.0 0.0  <b>scan</b>  <b>rows</b></p> <p><b>Sess</b>  <b>Logi</b>  <b>Reac</b>  <b>IM:</b></p> <p><b>User</b> 1,24 8.7  <b>calls</b></p> <p><b>Pars</b> 4,62 32.2  <b>(SQL</b></p>	

Task	Description	Skills required
	<p> <b>Hard</b> 8.9 0.1  <b>parts</b>  <b>(SQL</b>    <b>SQL</b> 824.1 5.7  <b>Work</b>  <b>Area</b>  <b>(MB)</b>    <b>Logc</b> 1.7 0.0    <b>Exec</b> 136,1 950.  <b>(SQL</b>    <b>Roll</b> 22.9 0.2  <b>:</b>    <b>Tran</b> 143.  <b>ons:</b> </p> <p>Based on this information, you can calculate IOPs and throughput as follows:</p> <p><i>IOPS = Read I/O requests + Write I/O requests = 3,586.8 + 574.7 = 4134.5</i></p> <p><i>Throughput = Physical read (blocks) + Physical write (blocks) = 13,575.1 + 3,467.3 = 17,042.4</i></p> <p>Because the block size in Oracle is 8 KB, you can</p>	



Task	Description	Skills required
	<p>calculate total throughput as follows:</p> <p><i>Total throughput in MB is</i> <math>17042.4 * 8 * 1024 / 1024 / 1024 = 133.2 \text{ MB}</math></p> <p><b>Warning:</b> Don't use the load profile to estimate the instance size. It isn't as precise as instance activity statistics or I/O profiles.</p>	

Task	Description	Skills required																				
<p>Option 2: Use instance activity statistics.</p>	<p>If you're using an Oracle Database version before 12c, you can use the Instance Activity Stats section of the AWR report to estimate IOPS and throughput. The following table shows an example of this section.</p> <table border="1" data-bbox="592 661 1031 1743"> <thead> <tr> <th data-bbox="609 672 706 703">Statistic</th> <th data-bbox="714 672 803 703">Total</th> <th data-bbox="820 672 917 756">per Second</th> <th data-bbox="933 672 1023 756">per Trans</th> </tr> </thead> <tbody> <tr> <td data-bbox="609 798 706 1029">physical read total IO requests</td> <td data-bbox="714 798 803 882">2,547, ,217</td> <td data-bbox="820 798 917 882">3,610.</td> <td data-bbox="933 798 1023 882">25.11</td> </tr> <tr> <td data-bbox="609 1071 706 1249">physical read total bytes</td> <td data-bbox="714 1071 803 1155">80,776, 6,124,</td> <td data-bbox="820 1071 917 1155">114,48</td> <td data-bbox="933 1071 1023 1155">796,148</td> </tr> <tr> <td data-bbox="609 1291 706 1522">physical write total IO requests</td> <td data-bbox="714 1291 803 1375">534,18</td> <td data-bbox="820 1291 917 1375">757.1</td> <td data-bbox="933 1291 1023 1375">5.27</td> </tr> <tr> <td data-bbox="609 1564 706 1743">physical write total bytes</td> <td data-bbox="714 1564 803 1648">25,517, 8,849,</td> <td data-bbox="820 1564 917 1648">36,168</td> <td data-bbox="933 1564 1023 1648">251,508</td> </tr> </tbody> </table>	Statistic	Total	per Second	per Trans	physical read total IO requests	2,547, ,217	3,610.	25.11	physical read total bytes	80,776, 6,124,	114,48	796,148	physical write total IO requests	534,18	757.1	5.27	physical write total bytes	25,517, 8,849,	36,168	251,508	<p>DBA</p>
Statistic	Total	per Second	per Trans																			
physical read total IO requests	2,547, ,217	3,610.	25.11																			
physical read total bytes	80,776, 6,124,	114,48	796,148																			
physical write total IO requests	534,18	757.1	5.27																			
physical write total bytes	25,517, 8,849,	36,168	251,508																			

Task	Description	Skills required
	<p>Based on this information, you can calculate total IOPS and throughput as follows:</p> $\text{Total IOPS} = 3,610.28 + 757.11 = 4367$ $\text{Total Mbps} = 114,482,426.26 + 36,165,631.84 = 150,648,058.1 / 1024 / 1024 = 143 \text{ Mbps}$	

Task	Description	Skills required																												
Option 3: Use I/O profiles.	<p>In Oracle Database 12c, the AWR report includes an I/O Profiles section that presents all the information in a single table and provides more accurate data about database performance. The following table shows an example of this section.</p> <table border="1" data-bbox="592 701 1026 1732"> <thead> <tr> <th></th> <th>Read +Write Per Second</th> <th>Read per Second</th> <th>Write Per Second</th> </tr> </thead> <tbody> <tr> <td><b>Total</b></td> <td>4,367.</td> <td>3,610.</td> <td>757.1</td> </tr> <tr> <td><b>Datab</b></td> <td>4,161.</td> <td>3,586.</td> <td>574.7</td> </tr> <tr> <td><b>Optim</b></td> <td>0.0</td> <td>0.0</td> <td>0.0</td> </tr> <tr> <td><b>Redo</b></td> <td>179.3</td> <td>2.8</td> <td>176.6</td> </tr> <tr> <td><b>Total (MB):</b></td> <td>143.7</td> <td>109.2</td> <td>34.5</td> </tr> <tr> <td><b>Datab (MB):</b></td> <td>133.1</td> <td>106.1</td> <td>27.1</td> </tr> </tbody> </table>		Read +Write Per Second	Read per Second	Write Per Second	<b>Total</b>	4,367.	3,610.	757.1	<b>Datab</b>	4,161.	3,586.	574.7	<b>Optim</b>	0.0	0.0	0.0	<b>Redo</b>	179.3	2.8	176.6	<b>Total (MB):</b>	143.7	109.2	34.5	<b>Datab (MB):</b>	133.1	106.1	27.1	DBA
	Read +Write Per Second	Read per Second	Write Per Second																											
<b>Total</b>	4,367.	3,610.	757.1																											
<b>Datab</b>	4,161.	3,586.	574.7																											
<b>Optim</b>	0.0	0.0	0.0																											
<b>Redo</b>	179.3	2.8	176.6																											
<b>Total (MB):</b>	143.7	109.2	34.5																											
<b>Datab (MB):</b>	133.1	106.1	27.1																											

Task	Description	Skills required																								
	<table border="1"> <tr> <td><b>Optim</b></td> <td>0.0</td> <td>0.0</td> <td>0.0</td> </tr> <tr> <td><b>Total (MB):</b></td> <td></td> <td></td> <td></td> </tr> <tr> <td><b>Redo (MB):</b></td> <td>7.6</td> <td>2.7</td> <td>4.9</td> </tr> <tr> <td><b>Datab (block</b></td> <td>17,04</td> <td>13,57</td> <td>3,467.3</td> </tr> <tr> <td><b>Via Buffer Cache (block</b></td> <td>5,898</td> <td>5,360</td> <td>537.6</td> </tr> <tr> <td><b>Direct (block</b></td> <td>11,14</td> <td>8,214</td> <td>2,929.7</td> </tr> </table> <p>This table provides the following values for throughput and total IOPS:</p> <p><i>Throughput = 143 MBPS (from the fifth row, labeled Total, second column)</i></p> <p><i>IOPS = 4,367.4 (from the first row, labeled Total Requests, second column)</i></p>	<b>Optim</b>	0.0	0.0	0.0	<b>Total (MB):</b>				<b>Redo (MB):</b>	7.6	2.7	4.9	<b>Datab (block</b>	17,04	13,57	3,467.3	<b>Via Buffer Cache (block</b>	5,898	5,360	537.6	<b>Direct (block</b>	11,14	8,214	2,929.7	
<b>Optim</b>	0.0	0.0	0.0																							
<b>Total (MB):</b>																										
<b>Redo (MB):</b>	7.6	2.7	4.9																							
<b>Datab (block</b>	17,04	13,57	3,467.3																							
<b>Via Buffer Cache (block</b>	5,898	5,360	537.6																							
<b>Direct (block</b>	11,14	8,214	2,929.7																							

Task	Description	Skills required
Option 4: Use AWR views.	<p>You can see the same IOPS and throughput information by using AWR views. To get this information, use the following query:</p> <pre data-bbox="594 489 1029 1125"> break on report compute sum of Value on report select METRIC_NAME, avg(AVERAGE) as "Value" from dba_hist_sysmetric_summary where METRIC_NAME in ('Physical Read Total IO Requests Per Sec', 'Physical Write Total IO Requests Per Sec') group by metric_name; </pre>	DBA

## Estimate CPU requirements

Task	Description	Skills required
Choose a method.	<p>You can estimate the CPU required for the target database in three ways:</p> <ul data-bbox="594 1587 1003 1818" style="list-style-type: none"> <li>• By using the actual available cores of the processor</li> <li>• By using the utilized cores based on OS statistics</li> </ul>	DBA

Task	Description	Skills required
	<ul style="list-style-type: none"><li>• By using the utilized cores based on database statistics</li></ul> <p>If you're looking at utilized cores, we recommend that you use the database metrics method instead of OS statistics, because it's based on the CPU used only by the databases that you're planning to migrate. (OS statistics also include CPU usage by other processes.) You should also check CPU-related recommendations in the ADDM report to improve performance after migration.</p> <p>You can also estimate requirements based on CPU generation. If you are using different CPU generations, you can estimate the required CPU of the target database by following the instructions in the whitepaper <a href="#">Demystifying the Number of vCPUs for Optimal Workload Performance</a>.</p>	

Task	Description	Skills required
Option 1: Estimate requirements based on available cores.	<p>In AWR reports:</p> <ul style="list-style-type: none"><li>• CPUs refer to logical and virtual CPUs.</li><li>• Cores are the number of processors in a physical CPU chipset.</li><li>• A socket is a physical device that connects a chip to a board. Multi-core processors have sockets with several CPU cores.</li></ul> <p>You can estimate available cores in two ways:</p> <ul style="list-style-type: none"><li>• By using OS commands</li><li>• By using the AWR report</li></ul> <p><b>To estimate available cores by using OS commands</b></p> <p>Use the following command to count the cores in the processor.</p> <pre>\$ cat /proc/cpuinfo   grep "cpu cores" uniq cpu cores      : 4 cat /proc/cpuinfo     egrep "core id physical id"   tr -d "\n"     sed s/physical/\\nphysical/g   grep -v ^\$     sort   uniq   wc -l</pre>	DBA



Task	Description	Skills required
	<p>Use the following command to count the sockets in the processor.</p> <pre data-bbox="597 380 1027 575"> grep "physical id" / proc/cpuinfo   sort -u physical id      : 0 physical id      : 1                     </pre> <p><b>Note:</b> We don't recommend using OS commands such as <b>nmon</b> and <b>sar</b> to extract CPU utilization. This is because those calculations include CPU utilization by other processes and might not reflect the actual CPU that is used by the database.</p> <p><b>To estimate available cores by using the AWR report</b></p> <p>You can also derive CPU utilization from the first section of the AWR report. Here's an excerpt from the report.</p> <pre data-bbox="597 1486 1027 1780"> C DB  Inst Inst Sta Rel RA N Id      nun Tim X &lt;DE XXX 1  05- 12.' NQ           Sep 0           23:(                     </pre>	

Task	Description	Skills required												
	<table border="1"> <thead> <tr> <th data-bbox="592 220 673 304">Hosts</th> <th data-bbox="673 220 755 304">Platform</th> <th data-bbox="755 220 836 304">CPU</th> <th data-bbox="836 220 917 304">Cores</th> <th data-bbox="917 220 1031 304">Sockets</th> <th data-bbox="1031 220 1047 304">Memory (GB)</th> </tr> </thead> <tbody> <tr> <td data-bbox="592 346 673 556">&lt;host&gt;</td> <td data-bbox="673 346 755 556">Linux x86-64-bit</td> <td data-bbox="755 346 836 556">80</td> <td data-bbox="836 346 917 556">80</td> <td data-bbox="917 346 1031 556">2</td> <td data-bbox="1031 346 1047 556">441.7</td> </tr> </tbody> </table> <p data-bbox="592 619 1047 1144">In this example, the CPUs count is 80, which indicates that these are logical (virtual) CPUs. You can also see that this configuration has two sockets, one physical processor on each socket (for a total of two physical processors), and 40 cores for each physical processor or socket.</p>	Hosts	Platform	CPU	Cores	Sockets	Memory (GB)	<host>	Linux x86-64-bit	80	80	2	441.7	
Hosts	Platform	CPU	Cores	Sockets	Memory (GB)									
<host>	Linux x86-64-bit	80	80	2	441.7									

Task	Description	Skills required												
<p>Option 2: Estimate CPU utilization by using OS statistics.</p>	<p>You can check the OS CPU usage statistics either directly in the OS (using <b>sar</b> or another host OS utility) or by reviewing the IDLE/(IDLE+BUSY) values from the Operating System Statistics section of the AWR report. You can see the seconds of CPU consumed directly from <b>v\$osstat</b>. The AWR and Statspack reports also show this data in the Operating System Statistics section.</p> <p>If there are multiple databases on the same box, they all have the same <b>v\$osstat</b> values for BUSY_TIME.</p> <table border="1" data-bbox="592 1218 1039 1743"> <thead> <tr> <th>Statistic</th> <th>Value</th> <th>End Value</th> </tr> </thead> <tbody> <tr> <td>FREE_MEMORY_BYTES</td> <td>6,810,672,248</td> <td>12,280,791,232</td> </tr> <tr> <td>INACTIVE_MEMORY_BYTES</td> <td>175,627,336,320</td> <td>160,380,653,568</td> </tr> <tr> <td>SWAP_FREE_BYTES</td> <td>17,145,643,360</td> <td>17,145,872,384</td> </tr> </tbody> </table>	Statistic	Value	End Value	FREE_MEMORY_BYTES	6,810,672,248	12,280,791,232	INACTIVE_MEMORY_BYTES	175,627,336,320	160,380,653,568	SWAP_FREE_BYTES	17,145,643,360	17,145,872,384	<p>DBA</p>
Statistic	Value	End Value												
FREE_MEMORY_BYTES	6,810,672,248	12,280,791,232												
INACTIVE_MEMORY_BYTES	175,627,336,320	160,380,653,568												
SWAP_FREE_BYTES	17,145,643,360	17,145,872,384												

Task	Description	Skills required
	<b>BUSY_TI</b> 1,305,56 ,937	
	<b>IDLE_TIM</b> 4,312,71 ,839	
	<b>IOWAIT_</b> 53,417,1 <b>ME</b> 4	
	<b>NICE_TII</b> 29,815	
	<b>SYS_TIM</b> 148,567, 70	
	<b>USER_TI</b> 1,146,91 ,783	
	<b>LOAD</b> 25 29	
	<b>VM_IN_E</b> 593,920 <b>ES</b>	
	<b>VM_OUT</b> 327,680 <b>TES</b>	
	<b>PHYSICA</b> 474,362, <b>MEMOR'</b> 17,152 <b>TES</b>	
	<b>NUM_CP</b> 80	
	<b>NUM_CP</b> 80 <b>ORES</b>	
	<b>NUM_CP</b> 2 <b>OCKETS</b>	

Task	Description	Skills required
	<p><b>GLOBAL_4,194,30</b>  <b>CEIVE_S</b>  <b>E_MAX</b></p> <p><b>GLOBAL_2,097,15</b>  <b>ND_SIZE</b>  <b>AX</b></p> <p><b>TCP_REC_87,380</b>  <b>VE_SIZE,</b>  <b>EFAULT</b></p> <p><b>TCP_REC_6,291,45</b>  <b>VE_SIZE,</b>  <b>AX</b></p> <p><b>TCP_REC_4,096</b>  <b>VE_SIZE,</b>  <b>IN</b></p> <p><b>TCP_SEM_16,384</b>  <b>SIZE_DE</b>  <b>ULT</b></p> <p><b>TCP_SEM_4,194,30</b>  <b>SIZE_MA</b></p> <p><b>TCP_SEM_4,096</b>  <b>SIZE_MII</b></p>	
	<p>If there are no other major CPU consumers in the system, use the following formula to calculate the percentage of CPU utilization:</p>	

Task	Description	Skills required
	<p><i>Utilization = Busy time / Total time</i></p> <p><i>Busy time = requirements = v\$osstat.BUSY_TIME</i></p> <p><i>C = Total time (Busy + Idle)</i></p> <p><i>C = capacity = v\$ostat.BUSY_TIME + v\$ostat.IDLE_TIME</i></p> <p><i>Utilization = BUSY_TIME / (BUSY_TIME + IDLE_TIME)</i></p> <p><i>= -1,305,569,937 / (1,305,569,937 + 4,312,718,839)</i></p> <p><i>= 23% utilized</i></p>	

Task	Description	Skills required																														
<p>Option 3: Estimate CPU utilization by using database metrics.</p>	<p>If multiple databases are running in the system, you can use the database metrics that appears at the beginning of the report.</p> <table border="1" data-bbox="592 510 1026 1339"> <thead> <tr> <th></th> <th>Snap Id</th> <th>Snap Time</th> <th>Sess</th> <th>Cursor S</th> <th>ession</th> </tr> </thead> <tbody> <tr> <td><b>Begin Snap</b></td> <td>1846</td> <td>28-Sep-09:00</td> <td>1226</td> <td>35.8</td> <td></td> </tr> <tr> <td><b>End Snap</b></td> <td>1854</td> <td>06-Oct-13:00</td> <td>1876</td> <td>41.1</td> <td></td> </tr> <tr> <td><b>Elap</b></td> <td></td> <td>11,70 (min)</td> <td></td> <td></td> <td></td> </tr> <tr> <td><b>DB Time</b></td> <td></td> <td>312,00 (min)</td> <td></td> <td></td> <td></td> </tr> </tbody> </table> <p>To get CPU utilization metrics, use this formula:</p> $\text{Database CPU usage (\% of CPU power available)} = \frac{\text{CPU time}}{\text{NUM\_CPUS} \times \text{elapsed time}}$ <p>where CPU usage is described by <i>CPU time</i> and represents</p>		Snap Id	Snap Time	Sess	Cursor S	ession	<b>Begin Snap</b>	1846	28-Sep-09:00	1226	35.8		<b>End Snap</b>	1854	06-Oct-13:00	1876	41.1		<b>Elap</b>		11,70 (min)				<b>DB Time</b>		312,00 (min)				<p>DBA</p>
	Snap Id	Snap Time	Sess	Cursor S	ession																											
<b>Begin Snap</b>	1846	28-Sep-09:00	1226	35.8																												
<b>End Snap</b>	1854	06-Oct-13:00	1876	41.1																												
<b>Elap</b>		11,70 (min)																														
<b>DB Time</b>		312,00 (min)																														

Task	Description	Skills required
	<p>the time spent on CPU, not the time waiting for CPU. This calculation results in:</p> $= 312,625.40 / 11,759.64$ $/80 = 33\% \text{ of CPU is being used}$ $\text{Number of cores (33\%)} * 80$ $= 26.4 \text{ cores}$ $\text{Total cores} = 26.4 * (120\%)$ $= 31.68 \text{ cores}$ <p>You can use the greater of these two values to calculate the CPU utilization of the Amazon RDS or Aurora DB instance.</p> <p><b>Note:</b> On IBM AIX, the calculated utilization doesn't match the values from the operating system or the database. These values do match on other operating systems.</p>	

## Estimate memory requirements

Task	Description	Skills required
Estimate memory requirements by using memory statistics.	You can use the AWR report to calculate the memory of the source database and match it in the target	DBA



Task	Description	Skills required
	<p>database. You should also check the performance of the existing database and reduce your memory requirements to save costs, or increase your requirements to improve performance. That requires a detailed analysis of the AWR response time and the service-level agreement (SLA) of the application. Use the sum of Oracle system global area (SGA) and program global area (PGA) usage as the estimated memory utilization for Oracle. Add an extra 20 percent for the OS to determine a target memory size requirement. For Oracle RAC, use the sum of the estimated memory utilization on all RAC nodes and reduce the total memory, because it's stored on common blocks.</p> <ol style="list-style-type: none"><li>1. Check for the metrics in the Instance Efficiency Percentage table. The table uses the following terms:<ul style="list-style-type: none"><li>• <i>Buffer Hit %</i> is the percentage of times a particular block was found in the buffer cache instead of performing a physical I/O. For better</li></ul></li></ol>	

Task	Description	Skills required																
	<p>performance, target 100 percent .</p> <ul style="list-style-type: none"> <li>• <i>Buffer Nowait %</i> should be close to 100 percent.</li> <li>• <i>Latch Hit %</i> should be close to 100 percent.</li> <li>• <i>% Non-Parse CPU</i> is the percentage of CPU time spent in non-parsing activities. This value should be close to 100 percent..</li> </ul> <p><b>Instance Efficiency Percentages (target 100%)</b></p> <table border="1" data-bbox="636 989 1052 1772"> <tbody> <tr> <td><b>Buffer Nowait %:</b></td> <td>99.99</td> <td><b>Redo NoWait %:</b></td> <td>100.00</td> </tr> <tr> <td><b>Buffer Hit %:</b></td> <td>99.84</td> <td><b>In-memory Sort %:</b></td> <td>100.00</td> </tr> <tr> <td><b>Library Hit %:</b></td> <td>748.7</td> <td><b>Soft Parse %:</b></td> <td>99.81</td> </tr> <tr> <td><b>Execution to Parse %:</b></td> <td>96.61</td> <td><b>Latch Hit %:</b></td> <td>100.00</td> </tr> </tbody> </table>	<b>Buffer Nowait %:</b>	99.99	<b>Redo NoWait %:</b>	100.00	<b>Buffer Hit %:</b>	99.84	<b>In-memory Sort %:</b>	100.00	<b>Library Hit %:</b>	748.7	<b>Soft Parse %:</b>	99.81	<b>Execution to Parse %:</b>	96.61	<b>Latch Hit %:</b>	100.00	
<b>Buffer Nowait %:</b>	99.99	<b>Redo NoWait %:</b>	100.00															
<b>Buffer Hit %:</b>	99.84	<b>In-memory Sort %:</b>	100.00															
<b>Library Hit %:</b>	748.7	<b>Soft Parse %:</b>	99.81															
<b>Execution to Parse %:</b>	96.61	<b>Latch Hit %:</b>	100.00															

Task	Description	Skills required									
	<p>Parse 72.73 % 99.21  CPU Non-  to Parse  Parse CPU:  Elaps  %:  Flash 0.00  Cache  Hit  %:</p> <p>In this example, all the metrics look fine, so you can use the SGA and PGA for the existing database as the capacity planning requirement.</p> <p>2. Check the memory statistics section and calculate the SGA/PGA.</p> <table border="1" data-bbox="630 1318 1049 1717"> <thead> <tr> <th></th> <th>Begin</th> <th>End</th> </tr> </thead> <tbody> <tr> <td>Host Mem (MB):</td> <td>452,387</td> <td>452,387.3</td> </tr> <tr> <td>SGA use (MB):</td> <td>220,544</td> <td>220,544.0</td> </tr> </tbody> </table>		Begin	End	Host Mem (MB):	452,387	452,387.3	SGA use (MB):	220,544	220,544.0	
	Begin	End									
Host Mem (MB):	452,387	452,387.3									
SGA use (MB):	220,544	220,544.0									

Task	Description	Skills required
	<p><b>PGA use (MB):</b> 36,874.0 45,270.0</p> <p><i>Total instance memory in use = SGA + PGA = 220 GB + 45 GB = 265 GB</i></p> <p>Add 20 percent of buffer:</p> <p><i>Total instance memory = 1.2 * 265 GB = 318 GB</i></p> <p>Because SGA and PGA account for 70 percent of host memory, the total memory requirement is:</p> <p><i>Total host memory = 318/0.7 = 464 GB</i></p> <p><b>Note:</b> When you migrate to Amazon RDS for Oracle, the PGA and SGA are pre-calculated based on a predefined formula. Make sure that the pre-calculated values are close to your estimates.</p>	

## Determine the DB instance type of the target database

Task	Description	Skills required
Determine the DB instance type based on disk I/O, CPU, and memory estimates.	<p>Based on the estimates in the previous steps, the capacity of the target Amazon RDS or Aurora database should be:</p> <ul style="list-style-type: none"><li>• 68 cores of CPU</li><li>• 143 MBPS of throughput</li><li>• 4367 IOPS for disk I/O</li><li>• 464 GB of memory</li></ul> <p>In the target Amazon RDS or Aurora database, you can map these values to the db.r5.16x large instance type, which has a capacity of 32 cores, 512 GB of RAM, and 13,600 Mbps of throughput. For more information, see the AWS blog post <a href="#">Right-size Amazon RDS instances at scale based on Oracle performance metrics</a>.</p>	DBA

## Related resources

- [Aurora DB instance class](#) (Amazon Aurora documentation)
- [Amazon RDS DB instance storage](#) (Amazon RDS documentation)
- [AWS Miner tool](#) (GitHub repository)

# Export Amazon RDS for SQL Server tables to an S3 bucket by using AWS DMS

Created by Subhani Shaik (AWS)

<b>Environment:</b> PoC or pilot	<b>Source:</b> RDS	<b>Target:</b> S3
<b>R Type:</b> N/A	<b>Workload:</b> Microsoft	<b>Technologies:</b> Databases; CloudNative
<b>AWS services:</b> AWS DMS; Amazon RDS; Amazon S3; AWS Secrets Manager; AWS Identity and Access Management		

## Summary

Amazon Relational Database Service (Amazon RDS) for SQL Server doesn't support loading data onto other DB engine linked servers on the Amazon Web Services (AWS) Cloud. Instead, you can use AWS Database Migration Service (AWS DMS) to export Amazon RDS for SQL Server tables to an Amazon Simple Storage Service (Amazon S3) bucket, where the data is available to other DB engines.

AWS DMS helps you migrate databases to AWS quickly and securely. The source database remains fully operational during the migration, minimizing downtime to applications that rely on the database. AWS DMS can migrate your data to and from the most widely used commercial and open-source databases.

This pattern uses AWS Secrets Manager while configuring the AWS DMS endpoints. Secrets Manager helps you protect secrets needed to access your applications, services, and IT resources. You can use the service to rotate, manage, and retrieve database credentials, API keys, and other secrets throughout their lifecycle. Users and applications retrieve secrets with a call to Secrets Manager, reducing the need to hardcode sensitive information. Secrets Manager offers secret rotation with built-in integration for Amazon RDS, Amazon Redshift, and Amazon DocumentDB. Also, the service is extensible to other types of secrets, including API keys and OAuth tokens. With

Secrets Manager, you can control access to secrets by using fine-grained permissions and audit secret rotation centrally for resources in the AWS Cloud, third-party services, and on premises.

## Prerequisites and limitations

### Prerequisites

- An active AWS account
- An S3 bucket
- A virtual private cloud (VPC)
- A DB subnet
- Amazon RDS for SQL Server
- An AWS Identity and Access Management (IAM) role with access (list, get, and put objects) to the S3 bucket on behalf of the Amazon RDS instance.
- Secrets Manager to store the RDS instance credentials.

## Architecture

### Technology stack

- Amazon RDS for SQL Server
- AWS DMS
- Amazon S3
- AWS Secrets Manager

### Target architecture

The following diagram shows the architecture for importing data from the Amazon RDS instance to the S3 bucket with the help of AWS DMS.

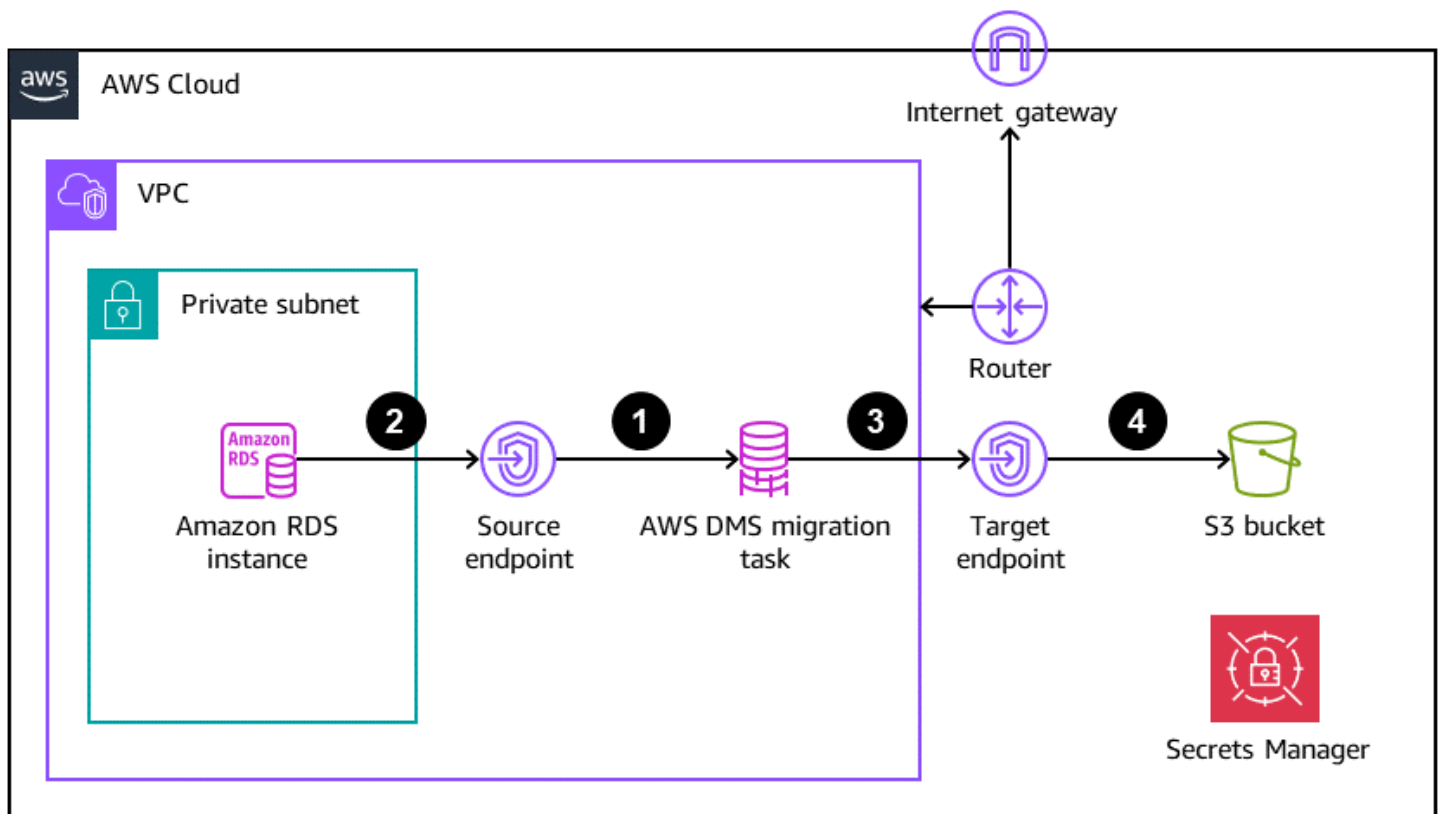

1. The AWS DMS migration task connecting to the source Amazon RDS instance through the source endpoint
2. Copying data from the source Amazon RDS instance
3. The AWS DMS migration task connecting to the target S3 bucket through the target endpoint
4. Exporting copied data to the S3 bucket in comma-separated values (CSV) format

## Tools

### AWS services

- [AWS Database Migration Service \(AWS DMS\)](#) helps you migrate data stores into the AWS Cloud or between combinations of cloud and on-premises setups.
- [AWS Identity and Access Management \(IAM\)](#) helps you securely manage access to your AWS resources by controlling who is authenticated and authorized to use them.
- [Amazon Relational Database Service \(Amazon RDS\)](#) helps you set up, operate, and scale a relational database in the AWS Cloud.



- [Amazon Simple Storage Service \(Amazon S3\)](#) is a cloud-based object storage service that helps you store, protect, and retrieve any amount of data.
- [AWS Secrets Manager](#) helps you replace hardcoded credentials in your code, including passwords, with an API call to Secrets Manager to retrieve the secret programmatically.

### Other services

- [Microsoft SQL Server Management Studio \(SSMS\)](#) is a tool for managing SQL Server, including accessing, configuring, and administering SQL Server components.

## Epics

### Configure the Amazon RDS for SQL Server instance

Task	Description	Skills required
Create the Amazon RDS for SQL Server instance.	<ol style="list-style-type: none"> <li>1. Open the AWS Management Console, choose <b>RDS</b>, and use the <b>Standard create</b> option to create an <b>Amazon RDS</b> instance with the required edition, such as SQL Server Express Edition, SQL Server Standard Edition, or SQL Server Enterprise Edition. For the version, choose 2016 or later.</li> <li>2. Under <b>Templates</b>, choose <b>Dev/Test</b>.</li> </ol>	DBA, DevOps engineer
Set up credentials for the instance.	<ol style="list-style-type: none"> <li>1. Enter a name for the instance.</li> <li>2. Provide a <b>username</b> and password for the Amazon RDS instance.</li> </ol>	DBA, DevOps engineer

Task	Description	Skills required
Configure the instance class, storage, auto scaling, and availability.	<ol style="list-style-type: none"><li data-bbox="592 226 1027 835">1. Select the <b>DB instance class</b> from the list: <b>Standard, Memory Optimized, and Burstable</b> classes. Choose the DB instance type that allocates the computational, network, and memory capacity required by the workloads planned for this DB instance. For more information, see the <a href="#">AWS documentation</a>.</li><li data-bbox="592 856 1027 1129">2. Select the Storage Type from the list: <b>General Purpose SSD, Provisioned IOPS SSD, or Magnetic</b>. Allocate the default storage size as required.</li><li data-bbox="592 1150 1027 1329">3. Choose <b>Enable storage autoscaling</b> to increase the Amazon RDS storage based on your capacity planning.</li><li data-bbox="592 1350 1027 1860">4. A Multi-AZ deployment with a replication instance is supported by AWS DMS. In the event of an outage in the Availability Zone, internal hardware, or network, AWS DMS will create a standby instance and provide high availability (HA) through automatic failover to the standby</li></ol>	DBA, DevOps engineer

Task	Description	Skills required
	<p>replicas. Depending on the size of your import, select the appropriate option.</p>	
<p>Specify the VPC, subnet group, public access, and security group.</p>	<p>Select the <b>VPC, DB subnet groups</b>, and <b>VPC security group</b> as required to create the Amazon RDS instance. Follow the best practices, for example:</p> <ul style="list-style-type: none"> <li>• Do not enable public access to the RDS DB instance.</li> <li>• Do not use the CIDR 0.0.0.0/0 in the security groups.</li> <li>• Use only the required IP address and port details to access the RDS instance.</li> </ul>	<p>DBA, DevOps engineer</p>
<p>Configure monitoring, backup, and maintenance.</p>	<ol style="list-style-type: none"> <li>1. Specify the backup options that you want. By default, automated backups are enabled with a retention period of 7 days.</li> <li>2. Choose the appropriate <b>auto minor version upgrade</b> and <b>Maintenance window</b> settings to apply the pending modifications or maintenance to the database by Amazon RDS.</li> <li>3. Choose <b>Create database</b>.</li> </ol>	<p>DBA, DevOps engineer</p>

## Set up the database and example data

Task	Description	Skills required
Create a table and load the example data.	In the new database, create a table. Use the example code in the <i>Additional information</i> section to load data into the table.	DBA, DevOps engineer

## Set up credentials

Task	Description	Skills required
Create the secret.	<ol style="list-style-type: none"> <li>On the console, choose <b>Secrets Manager</b>, and choose <b>Store a new secret</b>.</li> <li>Enter a username and password for the Amazon RDS for SQL Server database.</li> </ol> <p>This secret will be used for the AWS DMS source endpoint.</p>	DBA, DevOps engineer

## Set up access between the database and the S3 bucket

Task	Description	Skills required
Create an IAM role for access to Amazon RDS.	<ol style="list-style-type: none"> <li>On the console, choose <b>IAM</b>, and create an IAM role that gives an S3 bucket read/write access to Amazon RDS.</li> </ol>	DBA, DevOps engineer

Task	Description	Skills required
	2. Under <b>Feature</b> , select <b>S3 Integration</b> .	

### Create the S3 bucket

Task	Description	Skills required
Create the S3 bucket.	To save the data from Amazon RDS for SQL Server, on the console, choose <b>S3</b> , and then choose <b>Create bucket</b> . Make sure that the S3 bucket is not publicly available.	DBA, DevOps engineer

### Set up access between AWS DMS and the S3 bucket

Task	Description	Skills required
Create an IAM role for AWS DMS to access Amazon S3.	Create an IAM role that allows AWS DMS to list, get, and put objects from the S3 bucket.	DBA, DevOps engineer

### Configure AWS DMS

Task	Description	Skills required
Create the AWS DMS source endpoint.	1. On the console, choose <b>Database Migration Service</b> , and choose <b>Endpoints</b> . Create the <b>Source endpoint</b> , selecting	DBA, DevOps engineer

Task	Description	Skills required
	<p>the <b>Select RDS DB instance</b> check box.</p> <p>2. For the Source engine, select <b>Microsoft SQL Server</b>.</p> <p>3. Under <b>Access to endpoint database</b>, choose <b>AWS Secrets Manager</b>, and enter the secret and IAM role that you created earlier, and the database name.</p> <p>4. Test the source endpoint.</p>	
Create the AWS DMS target endpoint.	<p>Create the <b>Target endpoint</b>, selecting Amazon S3 as the <b>Target engine</b>.</p> <p>Provide the S3 bucket name and folder name for the IAM role that you created previously.</p>	DBA, DevOps engineer
Create the AWS DMS replication instance.	<p>In the same VPC, subnet, and security group, create the AWS DMS replication instance. For more information about choosing an instance class, see the <a href="#">AWS documentation</a>.</p>	DBA, DevOps engineer

Task	Description	Skills required
Create the AWS DMS migration task.	To export the data from Amazon RDS for SQL Server to the S3 bucket, create a database migration task. For the migration type, choose <b>Migrate existing data</b> . Select the AWS DMS endpoints and replication instance that you created.	DBA, DevOps engineer

### Export the data to the S3 bucket

Task	Description	Skills required
Run the database migration task.	To export the SQL Server table data, start the database migration task. The task will export the data from Amazon RDS for SQL Server to the S3 bucket in CSV format.	DBA, DevOps engineer

### Clean up resources

Task	Description	Skills required
Delete the resources.	To avoid incurring extra costs, use the console to delete the resources in the following order:  <ol style="list-style-type: none"><li>1. Migration task</li><li>2. Replication instance</li><li>3. Endpoints</li></ol>	DBA, DevOps engineer

Task	Description	Skills required
	4. S3 bucket 5. Database instance	

## Related resources

- [AWS DMS](#)
- [Amazon S3](#)
- [Amazon RDS for SQL Server](#)
- [Amazon S3 integration](#)

## Additional information

To create the database and table, and to load the example data, use the following code.

```
--Step1: Database creation in RDS SQL Server
CREATE DATABASE [Test_DB]
ON PRIMARY
( NAME = N'Test_DB', FILENAME = N'D:\rdsdbdata\DATA\Test_DB.mdf' , SIZE = 5120KB ,
FILEGROWTH = 10%)
LOG ON
( NAME = N'Test_DB_log', FILENAME = N'D:\rdsdbdata\DATA\Test_DB_log.ldf' , SIZE =
1024KB , FILEGROWTH = 10%)
GO

--Step2: Create Table
USE Test_DB
GO
Create Table Test_Table(ID int, Company Varchar(30), Location Varchar(20))

--Step3: Load sample data.
USE Test_DB
GO
Insert into Test_Table values(1,'AnyCompany','India')
Insert into Test_Table values(2,'AnyCompany','USA')
Insert into Test_Table values(3,'AnyCompany','UK')
Insert into Test_Table values(4,'AnyCompany','Hyderabad')
Insert into Test_Table values(5,'AnyCompany','Banglore')
```





# Handle anonymous blocks in Dynamic SQL statements in Aurora PostgreSQL

Created by anuradha chintha (AWS)

<b>Environment:</b> PoC or pilot	<b>Source:</b> Database Relational	<b>Target:</b> PostgreSQL
<b>R Type:</b> Re-architect	<b>Workload:</b> Oracle; Open-source	<b>Technologies:</b> Databases; Migration
<b>AWS services:</b> Amazon Aurora; Amazon RDS		

## Summary

This pattern shows you how to avoid the error that you get when handling anonymous blocks in Dynamic SQL statements. You receive an error message when you use the AWS Schema Conversion Tool to convert an Oracle database to an Aurora PostgreSQL-Compatible Edition database. To avoid the error, you must know the value of an OUT bind variable, but you can't know the value of an OUT bind variable until after you run the SQL statement. The error results from the AWS Schema Conversion Tool (AWS SCT) not understanding the logic inside the Dynamic SQL statement. AWS SCT can't convert the dynamic SQL statement in PL/SQL code (that is, functions, procedures, and packages).

## Prerequisites and limitations

### Prerequisites

- Active AWS account
- [Aurora PostgreSQL database \(DB\) instance](#)
- [Amazon Relational Database Service \(Amazon RDS\) for Oracle DB instance](#)
- [PostgreSQL interactive terminal \(psql\)](#)
- [SQL \\*Plus](#)
- AWS\_ORACLE\_EXT schema (part of the [AWS SCT extension pack](#)) in your target database

- Latest version of [AWS Schema Conversion Tool \(AWS SCT\)](#) and its required drivers

## Architecture

### Source technology stack

- On-premises Oracle Database 10g and later version

### Target technology stack

- Amazon Aurora PostgreSQL
- Amazon RDS for PostgreSQL
- AWS Schema Conversion Tool (AWS SCT)

### Migration architecture

The following diagram shows how to use AWS SCT and Oracle OUT bind variables to scan your application code for embedded SQL statements and convert the code to a compatible format that an Aurora database can use.

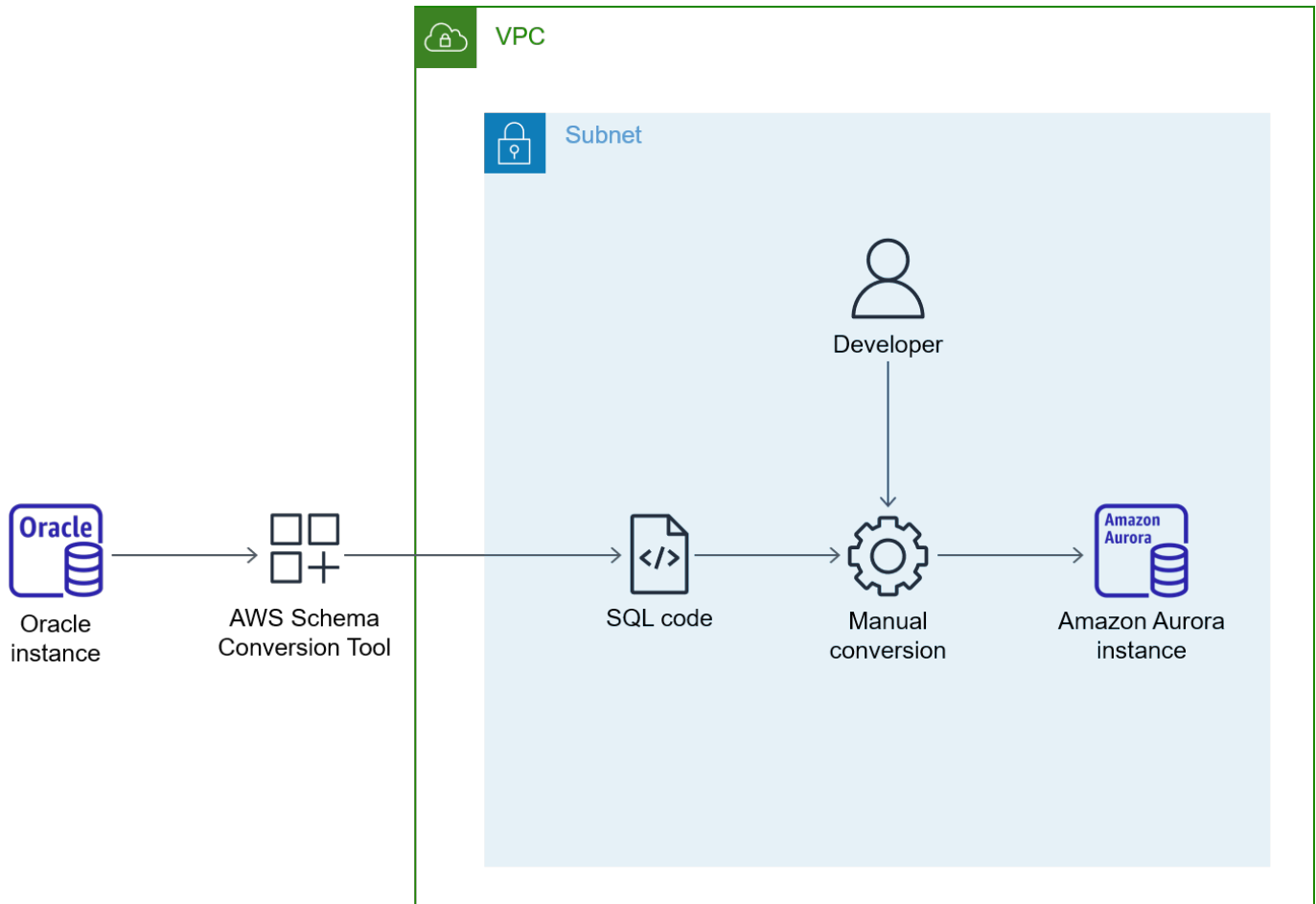

The diagram shows the following workflow:

1. Generate an AWS SCT report for the source database by using Aurora PostgreSQL as the target database.
2. Identify the anonymous block in the Dynamic SQL code block (for which AWS SCT raised the error).
3. Convert the code block manually and deploy the code on a target database.

## Tools

### AWS services

- [Amazon Aurora PostgreSQL-Compatible Edition](#) is a fully managed, ACID-compliant relational database engine that helps you set up, operate, and scale PostgreSQL deployments.
- [Amazon Relational Database Service \(Amazon RDS\) for Oracle](#) helps you set up, operate, and scale an Oracle relational database in the AWS Cloud.

- [AWS Schema Conversion Tool \(AWS SCT\)](#) helps you make heterogeneous database migrations predictable by automatically converting the source database schema and a majority of the database code objects to a format compatible with the target database.

## Other tools

- [pgAdmin](#) enables you to connect to and interact with your database server.
- [Oracle SQL Developer](#) is an integrated development environment that you can use to develop and manage databases in Oracle Database. You can use either [SQL \\*Plus](#) or Oracle SQL Developer for this pattern.

## Epics

### Configure the Oracle source database

Task	Description	Skills required
Create an Oracle instance on Amazon RDS or Amazon EC2.	<p>To create an Oracle DB instance on Amazon RDS, see <a href="#">Creating an Oracle DB instance and connecting to a database on an Oracle DB instance</a> in the Amazon RDS documentation.</p> <p>To create an Oracle DB instance on Amazon Elastic Compute Cloud (Amazon EC2), see <a href="#">Amazon EC2 for Oracle</a> in the AWS Prescriptive Guidance documentation.</p>	DBA
Create a database schema and objects for migration.	You can use Amazon Cloud Directory to create a database schema. For more information, see <a href="#">Create a Schema</a>	DBA

Task	Description	Skills required
	in the Cloud Directory documentation.	
Configure inbound and outbound security groups.	To create and configure security groups, see <a href="#">Controlling access with security groups</a> in the Amazon RDS documentation.	DBA
Confirm that the database is running.	To check the status of your database, see <a href="#">Viewing Amazon RDS events</a> in the Amazon RDS documentation.	DBA

### Configure the target Aurora PostgreSQL database

Task	Description	Skills required
Create an Aurora PostgreSQL instance in Amazon RDS.	To create an Aurora PostgreSQL instance, see <a href="#">Creating a DB cluster and connecting to a database on an Aurora PostgreSQL DB cluster</a> in the Amazon RDS documentation.	DBA
Configure an inbound and outbound security group.	To create and configure security groups, see <a href="#">Provide access to the DB cluster in the VPC by creating a security group</a> in the Aurora documentation.	DBA

Task	Description	Skills required
Confirm that the Aurora PostgreSQL database is running.	To check the status of your database, see <a href="#">Viewing Amazon RDS events</a> in the Aurora documentation.	DBA

## Set up AWS SCT

Task	Description	Skills required
Connect AWS SCT to the source database.	To connect AWS SCT to your source database, see <a href="#">Connecting to PostgreSQL as a source</a> in the AWS SCT documentation.	DBA
Connect AWS SCT to the target database.	To connect AWS SCT to your target database, see the <a href="#">What is the AWS Schema Conversion Tool?</a> in the AWS Schema Conversion Tool User Guide.	DBA
Convert the database schema in AWS SCT and save the automated converted code as a SQL file.	To save AWS SCT converted files, see <a href="#">Saving and applying your converted schema in AWS SCT</a> in the AWS Schema Conversion Tool User Guide.	DBA

## Migrate the code

Task	Description	Skills required
Get the SQL file for manual conversion.	In the AWS SCT converted file, pull the SQL file that requires manual conversion.	DBA

Task	Description	Skills required
Update the script.	Manually update the SQL file.	DBA

## Related resources

- [Amazon RDS](#)
- [Amazon Aurora Features](#)

## Additional information

The following example code shows how to configure the Oracle source database:

```
CREATE or replace PROCEDURE calc_stats_new1 (  
  a NUMBER,  
  b NUMBER,  
  result out NUMBER)  
IS  
BEGIN  
  result:=a+b;  
END;  
/
```

```
set serveroutput on ;  
  
DECLARE  
  a NUMBER := 4;  
  b NUMBER := 7;  
  plsql_block VARCHAR2(100);  
  output number;  
BEGIN  
  plsql_block := 'BEGIN calc_stats_new1(:a, :b, :output); END;';  
  EXECUTE IMMEDIATE plsql_block USING a, b, out output;  
  DBMS_OUTPUT.PUT_LINE('output: ' || output);  
  
END;
```

The following example code shows how to configure the target Aurora PostgreSQL database:



```
w integer,
x integer)
RETURNS integer
AS
$BODY$
DECLARE
begin
return w + x ;
end;
$BODY$
LANGUAGE plpgsql;

CREATE OR REPLACE FUNCTION test_pg.init()
RETURNS void
AS
$BODY$
BEGIN
if aws_oracle_ext.is_package_initialized
    ('test_pg' ) then
    return;
end if;
perform aws_oracle_ext.set_package_initialized
    ('test_pg' );

PERFORM aws_oracle_ext.set_package_variable('test_pg', 'v_output', NULL::INTEGER);
PERFORM aws_oracle_ext.set_package_variable('test_pg', 'v_status', NULL::text);
END;
$BODY$
LANGUAGE plpgsql;

DO $$
declare
v_sql text;
v_output_loc int;
a integer :=1;
b integer :=2;
BEGIN
perform test_pg.init();
--raise notice 'v_sql %',v_sql;
execute 'do $$ declare v_output_l int; begin select * from test_pg.calc_stats_new1('||
a||','||b||') into v_output_l;
```

```
PERFORM aws_oracle_ext.set_package_variable('test_pg', 'v_output', v_output_1) ;
end; $$' ;
v_output_loc := aws_oracle_ext.get_package_variable('test_pg', 'v_output');
raise notice 'v_output_loc %',v_output_loc;
END ;
$$
```

# Handle overloaded Oracle functions in Aurora PostgreSQL-Compatible

Created by Sumana Yanamandra (AWS)

<b>Environment:</b> PoC or pilot	<b>Source:</b> Oracle Database	<b>Target:</b> Aurora PostgreSQL-Compatible
<b>R Type:</b> Replatform	<b>Workload:</b> Oracle	<b>Technologies:</b> Databases; Migration
<b>AWS services:</b> Amazon Aurora		

## Summary

The code you migrate from an on-premises Oracle database to Amazon Aurora PostgreSQL-Compatible Edition might include overloaded functions. These functions have the same definition—that is, the same function name and the same number and data type of input (IN) parameters—but the data type or the number of output (OUT) parameters might differ.

These parameter mismatches can cause problems in PostgreSQL, because it's difficult to determine which function to run. This pattern illustrates how to handle overloaded functions when you migrate your database code to Aurora PostgreSQL-Compatible.

## Prerequisites and limitations

### Prerequisites

- An Oracle database instance as your source database
- An Aurora PostgreSQL-Compatible DB instance as your target database (see [instructions](#) in the Aurora documentation)

### Product versions

- Oracle Database 9i or later

- Oracle SQL Developer version 18.4.0.376
- pgAdmin 4 client
- Aurora PostgreSQL-Compatible version 11 or later (see [Identifying versions of Amazon Aurora PostgreSQL](#) in the Aurora documentation)

## Tools

### AWS services

- [Amazon Aurora PostgreSQL-Compatible Edition](#) is a fully managed, ACID-compliant relational database engine that helps you set up, operate, and scale PostgreSQL deployments.

### Other tools

- [Oracle SQL Developer](#) is a free, integrated development environment for working with SQL in Oracle databases in both traditional and cloud deployments.
- [pgAdmin](#) is an open-source management tool for PostgreSQL. It provides a graphical interface that helps you create, maintain, and use database objects.

## Epics

### Create a simple function

Task	Description	Skills required
Create a function in PostgreSQL that has one input parameter and one output parameter.	The following example illustrates a function named <code>test_overloading</code> in Aurora PostgreSQL-Compatible. This function has two parameters: one input text parameter and one output text parameter.	Data engineer, Aurora PostgreSQL-Compatible

Task	Description	Skills required
	<pre>CREATE OR REPLACE FUNCTION public.te st_overloading(     str1 text,     OUT str2 text) LANGUAGE 'plpgsql' COST 100 VOLATILE AS \$BODY\$ DECLARE BEGIN     str2 := 'Success'; RETURN ; EXCEPTION     WHEN others THEN         RETURN ; END; \$BODY\$;</pre>	
Run the function in PostgreSQL.	<p>Run the function that you created in the previous step.</p> <pre>select public.te st_overloading('Te st');</pre> <p>It should display the following output.</p> <pre>Success</pre>	Data engineer, Aurora PostgreSQL-Compatible

## Overload the function

Task	Description	Skills required
Use the same function name to create an overloaded function in PostgreSQL.	<p>Create an overloaded function in Aurora PostgreSQL-Compatible that uses the same function name as your previous function. The following example is also named <code>test_overloading</code>, but it has three parameters: one input text parameter, one output text parameter, and one output integer parameter.</p> <pre data-bbox="594 915 1029 1885">CREATE OR REPLACE FUNCTION public.test_overloading(     str1 text,     OUT str2 text,     OUT num1 integer) LANGUAGE 'plpgsql'  COST 100 VOLATILE AS \$BODY\$ DECLARE str3 text;  BEGIN      str2 := 'Success';     num1 := 100;  RETURN ; EXCEPTION WHEN others THEN</pre>	Data engineer, Aurora PostgreSQL-Compatible

Task	Description	Skills required
	<pre> RETURN ; END; \$BODY\$; </pre>	
<p>Run the function in PostgreSQL.</p>	<p>When you run this function, it fails with the following error message.</p> <pre> ERROR: cannot change return type of existing function HINT:      Use DROP FUNCTION test_over loading(text) first. </pre> <p>This happens because Aurora PostgreSQL-Compatible doesn't support function overloading directly. It can't identify which function to run, because the number of output parameters is different in the second version of the function, although the input parameters are the same.</p>	<p>Data engineer, Aurora PostgreSQL-Compatible</p>

## Apply the workaround

Task	Description	Skills required
<p>Add INOUT to the first output parameter.</p>	<p>As a workaround, modify the function code by representing the first output parameter as INOUT.</p>	<p>Data engineer, Aurora PostgreSQL-Compatible</p>

Task	Description	Skills required
	<pre>CREATE OR REPLACE FUNCTION public.te st_overloading(     str1 text,     INOUT str2 text,     OUT num1 integer) LANGUAGE 'plpgsql'  COST 100 VOLATILE AS \$BODY\$ DECLARE str3 text; BEGIN      str2 := 'Success';     num1 := 100;  RETURN ; EXCEPTION     WHEN others THEN         RETURN ; END; \$BODY\$;</pre>	



Task	Description	Skills required
Run the revised function.	<p>Run the function that you updated by using the following query. You pass a null value as the second argument of this function, because you declared this parameter as INOUT to avoid the error.</p> <pre data-bbox="597 632 1027 793">select public.test_overloading('Test', null);</pre> <p>The function is now created successfully.</p> <pre data-bbox="597 947 1027 1024">Success, 100</pre>	Data engineer, Aurora PostgreSQL-Compatible
Validate the results.	Verify that the code with the overloaded function was converted successfully.	Data engineer, Aurora PostgreSQL-Compatible

## Related resources

- [Working with Amazon Aurora PostgreSQL](#) (Aurora documentation)
- [Function overloading in Oracle](#) (Oracle documentation)
- [Function overloading in PostgreSQL](#) (PostgreSQL documentation)

# Help enforce DynamoDB tagging

Created by Mansi Suratwala (AWS)

**Environment:** Production

**Technologies:** Databases  
; CloudNative; Security,  
identity, compliance

**Workload:** All other  
workloads

**AWS services:** Amazon  
CloudWatch; Amazon  
DynamoDB; AWS Lambda;  
Amazon SNS

## Summary

This pattern sets up automatic notifications when a predefined Amazon DynamoDB tag is missing or removed from a DynamoDB resource on the Amazon Web Services (AWS) Cloud.

DynamoDB is a fully managed NoSQL database service that provides fast and predictable performance with scalability. DynamoDB lets you offload the administrative burdens of operating and scaling a distributed database. When you use DynamoDB, you don't have to worry about hardware provisioning, setup and configuration, replication, software patching, or cluster scaling.

The pattern uses an AWS CloudFormation template, which creates an Amazon CloudWatch Events event and an AWS Lambda function. The event watches for any new or existing DynamoDB tagging information by using AWS CloudTrail. If a predefined tag is missing or removed, CloudWatch triggers a Lambda function, which sends you an Amazon Simple Notification Service (Amazon SNS) notification informing you of the violation.

## Prerequisites and limitations

### Prerequisites

- An active AWS account
- An Amazon Simple Storage Service (Amazon S3) bucket for the Lambda .zip file that contains the Python script for running the Lambda function

## Limitations

- The solution works only when the TagResource or UntagResource CloudTrail events occur. It does not create notifications for any other events.

## Architecture

### Target technology stack

- Amazon DynamoDB
- AWS CloudTrail
- Amazon CloudWatch
- AWS Lambda
- Amazon S3
- Amazon SNS

### Target architecture

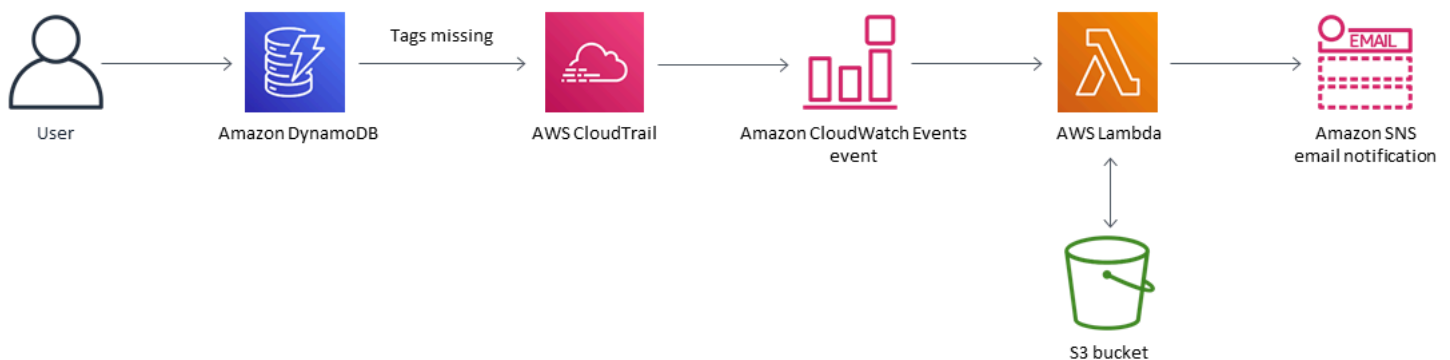

### Automation and scale

You can use the AWS CloudFormation template multiple times for different AWS Regions and accounts. You need to run the template only once in each Region or account.

## Tools

### Tools

- [Amazon DynamoDB](#) – DynamoDB is a fully managed NoSQL database service that provides fast and predictable performance with scalability.

- [AWS CloudTrail](#) – CloudTrail is an AWS service that helps you with governance, compliance, and operational and risk auditing of your AWS account. Actions taken by a user, role, or an AWS service are recorded as events in CloudTrail.
- [Amazon CloudWatch Events](#) – Amazon CloudWatch Events delivers a near-real time stream of system events that describe changes in AWS resources.
- [AWS Lambda](#) – Lambda is a compute service that supports running code without needing to provision or manage servers. Lambda runs your code only when needed and scales automatically, from a few requests per day to thousands per second.
- [Amazon S3](#) – Amazon Simple Storage Service (Amazon S3) is a highly scalable object storage service that can be used for a wide range of storage solutions, including websites, mobile applications, backups, and data lakes.
- [Amazon SNS](#) – Amazon Simple Notification Service (Amazon SNS) is a web service that enables applications, end-users, and devices to instantly send and receive notifications from the cloud.

## Code

- A .zip file of the project is available as an attachment.

## Epics

### Define the S3 bucket

Task	Description	Skills required
Define the S3 bucket.	On the Amazon S3 console, choose or create an S3 bucket with a unique name that does not contain leading slashes. This S3 bucket will host the Lambda code .zip file. Your S3 bucket must be in the same AWS Region as the DynamoDB resource that is being monitored.	Cloud Architect

## Upload the Lambda code to the S3 bucket

Task	Description	Skills required
Upload the Lambda code to the S3 bucket.	Upload the Lambda code .zip file provided in the <i>Attachments</i> section to the S3 bucket. The S3 bucket must be in the same Region as the DynamoDB resource that is being monitored.	Cloud Architect

## Deploy the AWS CloudFormation template

Task	Description	Skills required
Deploy the AWS CloudFormation template.	On the AWS CloudFormation console, deploy the AWS CloudFormation template that's provided in the <i>Attachments</i> section. In the next epic, provide values for the parameters.	Cloud Architect

## Complete the parameters in the AWS CloudFormation template

Task	Description	Skills required
Name the S3 bucket.	Enter the name of the S3 bucket that you created or chose in the first epic.	Cloud Architect
Provide the Amazon S3 key.	Provide the location of the Lambda code .zip file in your S3 bucket, without leading slashes (for example,	Cloud Architect

Task	Description	Skills required
	<code>&lt;folder&gt;/&lt;file-name&gt;.zip</code> ).	
Provide an email address	Provide an active email address to receive Amazon SNS notifications.	Cloud Architect
Define the logging level.	Define the logging level and frequency for your Lambda function. Info designates detailed informational messages on the application's progress. Error designates error events that could still allow the application to continue running. Warning designates potentially harmful situations.	Cloud Architect
Enter the required DynamoDB tag keys.	Be sure that the tags are separated by commas, with no spaces between them (for example, <code>ApplicationId, CreatedBy, Environment, Organization</code> ). The CloudWatch Events event searches for these tags and sends a notification if they are not found.	Cloud Architect

## Confirm the subscription.

Task	Description	Skills required
Confirm the subscription.	When the template successfully deploys, it sends a subscription email to the email address that you provided. To receive violation notifications, you must confirm this email subscription.	Cloud Architect

## Related resources

- [Creating an S3 bucket](#)
- [Uploading files to an S3 bucket](#)
- [Tagging resources in DynamoDB](#)
- [Creating a CloudWatch Events rule that triggers on an AWS API call using AWS CloudTrail](#)

## Attachments

To access additional content that is associated with this document, unzip the following file: [attachment.zip](#)

# Implement cross-Region disaster recovery with AWS DMS and Amazon Aurora

*Created by Mark Hudson (AWS)*

**Environment:** Production

**Technologies:** Databases

**AWS services:** AWS DMS;  
Amazon RDS; Amazon Aurora

## Summary

Natural or human-induced disasters can occur at any time and can impact the availability of services and workloads running in a given Amazon Web Services (AWS) Region. To mitigate the risks, you must develop a disaster recovery (DR) plan that incorporates the built-in cross-Region capabilities of AWS services. For AWS services that do not inherently provide cross-Region functionality, the DR plan must also provide a solution to handle their failover across AWS Regions.

This pattern guides you through a disaster recovery setup involving two Amazon Aurora MySQL-Compatible Edition database clusters in a single Region. To meet DR requirements, the database clusters are configured to use the Amazon Aurora global database feature, with a single database spanning multiple AWS Regions. An AWS Database Migration Service (AWS DMS) task replicates data between the clusters in the local Region. AWS DMS, however, currently doesn't support task failover between Regions. This pattern includes the steps required to work around that limitation and independently configure AWS DMS in both Regions.

## Prerequisites and limitations

### Prerequisites

- Selected primary and secondary AWS Regions that support [Amazon Aurora global databases](#).
- Two independent Amazon Aurora MySQL-Compatible Edition database clusters in a single account in the primary Region.
- Database instance class db.r5 or higher (recommended).
- An AWS DMS task in the primary Region performing ongoing replication between the existing database clusters.



- DR Region resources in place to meet requirements for creating database instances. For more information, see [Working with a DB instance in a VPC](#).

## Limitations

- For the full list of Amazon Aurora global database limitations, see [Limitations of Amazon Aurora global databases](#).

## Product versions

- Amazon Aurora MySQL-Compatible Edition 5.7 or 8.0. For more information, see [Amazon Aurora versions](#).

## Architecture

### Target technology stack

- Amazon Aurora MySQL-Compatible Edition global database cluster
- AWS DMS

### Target architecture

The following diagram shows a global database for two AWS Regions, one with the primary main and reporter databases and AWS DMS replication, and one with the secondary main and reporter databases.

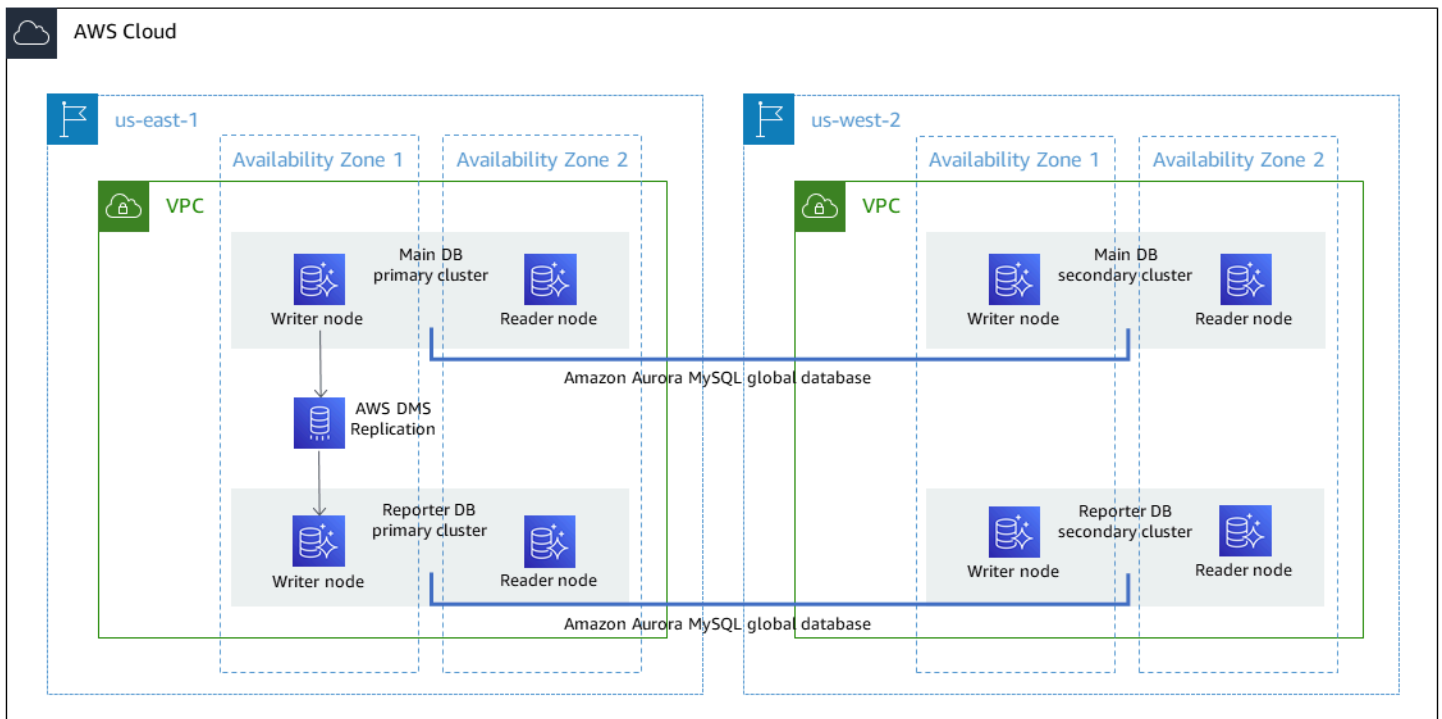

## Automation and scale

You can use AWS CloudFormation to create the prerequisite infrastructure in the secondary Region, such as the virtual private cloud (VPC), subnets, and parameter groups. You can also use AWS CloudFormation to create the secondary clusters in the DR Region and add them to the global database. If you used CloudFormation templates to create the database clusters in the primary Region, you can update or augment them with an additional template to create the global database resource. For more information, see [Creating an Amazon Aurora DB cluster with two DB instances](#) and [Creating a global database cluster for Aurora MySQL](#).

Finally, you can create the AWS DMS tasks in the primary and secondary Regions using CloudFormation after failover and failback events occur. For more information, see [AWS::DMS::ReplicationTask](#).

## Tools

- [Amazon Aurora](#) - Amazon Aurora is a fully managed relational database engine that's compatible with MySQL and PostgreSQL. This pattern uses Amazon Aurora MySQL-Compatible Edition.
- [Amazon Aurora global databases](#) - Amazon Aurora global databases are designed for globally distributed applications. A single Amazon Aurora global database can span multiple AWS Regions. It replicates your data with no impact on database performance. It also enables fast

local reads with low latency in each Region, and it provides disaster recovery from Region-wide outages.

- [AWS DMS](#) - AWS Database Migration Service (AWS DMS) provides one-time migration or on-going replication. An on-going replication task keeps your source and target databases in sync. After it is set up, the on-going replication task continuously applies source changes to the target with minimal latency. All AWS DMS features, such as data validation and transformations, are available for any replication task.

## Epics

### Prepare the existing database clusters in the primary Region

Task	Description	Skills required
Modify the database cluster parameter group.	<p>In the existing database cluster parameter group, activate row-level binary logging by setting the <code>binlog_format</code> parameter to a value of <b>row</b>.</p> <p>AWS DMS requires row-level binary logging for MySQL-compatible databases when performing ongoing replication or change data capture (CDC). For more information, see <a href="#">Using an AWS managed MySQL-compatible database as a source for AWS DMS</a>.</p>	AWS administrator
Update the database binary log retention period.	Using a MySQL client installed on your end-user device or an Amazon Elastic Compute Cloud (Amazon EC2) instance, run the following stored procedure provided by	DBA

Task	Description	Skills required
	<p>Amazon Relational Database Service (Amazon RDS) on the main database cluster's writer node, where XX is the number of hours to retain the logs.</p> <pre>call mysql.rds_set_configuration('binlog retention hours', XX)</pre> <p>Confirm the setting by running the following command.</p> <pre>call mysql.rds_show_configuration;</pre> <p>MySQL-compatible databases managed by AWS purge the binary logs as soon as possible. Therefore, the retention period must be long enough to ensure that the logs are not purged before the AWS DMS task runs. A value of 24 hours is usually sufficient, but the value should be based on the time required to set up the AWS DMS task in the DR Region.</p>	

## Update the existing AWS DMS task in the primary Region

Task	Description	Skills required
Record the AWS DMS task ARN.	<p>Use the Amazon Resource Name (ARN) to obtain the AWS DMS task name for later use. To retrieve the AWS DMS task ARN, view the task in the console or run the following command.</p> <pre data-bbox="594 688 1027 810">aws dms describe-replication-tasks</pre> <p>An ARN looks like the following.</p> <pre data-bbox="594 968 1027 1205">arn:aws:dms:us-east-1:&lt;accountid&gt;:task:ANGHFFMPM246XOZVEUHCNSOVF7MQCLTOZUIRAMY</pre> <p>The characters after the last colon correspond to the task name used in a later step.</p>	AWS administrator
Modify the existing AWS DMS task to record the checkpoint.	<p>AWS DMS creates checkpoints that contain information so that the replication engine knows the recovery point for the change stream. To record checkpoint information, perform the following steps in the console:</p> <ol style="list-style-type: none"><li>1. Stop the AWS DMS task.</li></ol>	AWS administrator

Task	Description	Skills required
	<ol style="list-style-type: none"> <li>Use the JSON editor in the task to set the <code>TaskRecoveryTableEnabled</code> parameter to <b>true</b>.</li> <li>Start the AWS DMS task.</li> </ol>	
Validate checkpoint information.	<p>Using a MySQL client connected to the writer endpoint for the cluster, query the new metadata table in the reporter database cluster to verify that it exists and contains the replication state information. Run the following command.</p> <pre>select * from awsdms_control.awsdms_txn_state;</pre> <p>The task name from the ARN should be found in this table in the <code>Task_Name</code> column.</p>	DBA

## Expand both Amazon Aurora clusters to a DR Region

Task	Description	Skills required
Create base infrastructure in the DR Region.	<p>Create the base components required for the creation of and access to the Amazon Aurora clusters:</p> <ul style="list-style-type: none"> <li>Virtual private cloud (VPC)</li> <li>Subnets</li> </ul>	AWS administrator

Task	Description	Skills required
	<ul style="list-style-type: none"> <li>• Security group</li> <li>• Network access control lists</li> <li>• Subnet group</li> <li>• DB parameter group</li> <li>• DB cluster parameter group</li> </ul> <p>Ensure that the configuration of both parameter groups matches the configuration in the primary Region.</p>	
Add the DR Region to both Amazon Aurora clusters.	Add a secondary Region (the DR Region) to the main and reporter Amazon Aurora clusters. For more information, see <a href="#">Adding an AWS Region to an Amazon Aurora global database</a> .	AWS administrator

## Perform failover

Task	Description	Skills required
Stop the AWS DMS task.	The AWS DMS task in the primary Region will not function properly after failover occurs and should be stopped to avoid errors.	AWS administrator
Perform a managed failover.	Perform a managed failover of the main database cluster to the DR Region. For instructions, see <a href="#">Performing managed planned failovers for Amazon</a>	AWS administrator, DBA

Task	Description	Skills required
	<p><a href="#">Aurora global databases</a>. After failover on the main database cluster is complete, perform the same activity on the reporter database cluster.</p>	
Load data into the main database.	Insert test data into writer node of the main database in the DR database cluster. This data will be used to validate that replication is functioning properly.	DBA
Create the AWS DMS replication instance.	To create the AWS DMS replication instance in the DR Region, see <a href="#">Creating a replication instance</a> .	AWS administrator, DBA
Create the AWS DMS source and target endpoints.	To create the AWS DMS source and target endpoints in the DR Region, see <a href="#">Creating source and target endpoints</a> . The source should point to the writer instance of the main database cluster. The target should point to the writer instance of the reporter database cluster.	AWS administrator, DBA



Task	Description	Skills required
Obtain the replication checkpoint.	<p>To obtain the replication checkpoint, use a MySQL client to query the metadata table by running the following against the writer node in the reporter database cluster in the DR Region.</p> <pre data-bbox="597 583 1026 743">select * from awsdms_control.awsdms_txn_state;</pre> <p>In the table, find the <code>task_name</code> value that corresponds to the AWS DMS task's ARN that exists in the primary Region that you obtained in the second epic.</p>	DBA

Task	Description	Skills required
Create an AWS DMS task.	<p>Using the console, create an AWS DMS task in the DR Region. In the task, specify a migration method of <b>Replicate data changes only</b>. For more information, see <a href="#">Creating a task</a>.</p> <ol style="list-style-type: none"><li>1. In the task settings, use the wizard to specify the following:<ul style="list-style-type: none"><li>• <b>CDC start mode for source transactions</b><ul style="list-style-type: none"><li>– Enable custom CDC start mode</li></ul></li><li>• <b>Custom CDC start point for source transactions</b> – Specify a recovery checkpoint</li></ul></li><li>2. In the <b>Recovery checkpoint</b> box, enter the replication checkpoint value previously obtained through the database query on the <code>awsdms_txn_state</code> table.</li><li>3. In the task settings section, select the JSON editor, and set the <b>TaskRecoveryTableEnabled</b> parameter to <b>true</b>.</li></ol>	AWS administrator, DBA

Task	Description	Skills required
	Set the AWS DMS task <b>Start migration task</b> setting to <b>Automatically on create</b> .	
Record the AWS DMS task ARN.	Use the ARN to obtain the AWS DMS task name for later use. To retrieve the AWS DMS task ARN, run the following command.  <pre>aws dms describe-replication-tasks</pre>	AWS administrator, DBA
Validate the replicated data.	Query the reporter database cluster in the DR Region to confirm that the test data that you loaded into the main database cluster has been replicated.	DBA

## Perform failback

Task	Description	Skills required
Stop the AWS DMS task.	The AWS DMS task in the DR Region will not function properly after failback occurs and should be stopped to avoid errors.	AWS administrator
Perform a managed failback.	Fail back the main database cluster to the primary Region. For instructions, see <a href="#">Performing managed planned failovers for Amazon</a>	AWS administrator, DBA

Task	Description	Skills required
	<p><a href="#">Aurora global databases.</a></p> <p>After the failback on the main database cluster is complete, perform the same activity on the reporter database cluster.</p>	
<p>Obtain the replication checkpoint.</p>	<p>To obtain the replication checkpoint, use a MySQL client to query the metadata table by running the following against the writer node in the reporter database cluster in the DR Region.</p> <pre data-bbox="594 842 1027 999">select * from awsdms_control.awsdms_txn_state;</pre> <p>In the table, find the <code>task_name</code> value that corresponds to the AWS DMS task's ARN that exists in the DR Region that you obtained in the fourth epic.</p>	<p>DBA</p>

Task	Description	Skills required
Update the AWS DMS source and target endpoints.	After the database clusters have failed back, check the clusters in the primary Region to determine which nodes are the writer instances . Then verify the existing AWS DMS source and target endpoints in the primary Region are pointing to the writer instances. If not, update the endpoints with the writer instance Domain Name System (DNS) names.	AWS administrator

Task	Description	Skills required
Create an AWS DMS task.	<p>Using the console, create an AWS DMS task in the primary Region. In the task, specify a migration method of <b>Replicate data changes only</b>. For more information, see <a href="#">Creating a task</a>.</p> <ol style="list-style-type: none"><li>1. In the task settings, use the wizard and specify the following:<ul style="list-style-type: none"><li>• <b>CDC start mode for source transactions</b><ul style="list-style-type: none"><li>– Enable custom CDC start mode</li></ul></li><li>• <b>Custom CDC start point for source transactions</b> – Specify a recovery checkpoint</li></ul></li><li>2. In the <b>Recovery checkpoint</b> box, enter the replication checkpoint value previously obtained through the database query on the <code>awsdms_txn_state</code> table.</li><li>3. Also within the task settings section, select the JSON editor and set the <b>TaskRecoveryTableEnabled</b> parameter to <b>true</b>.</li><li>4. Finally, set the AWS DMS task <b>Start migration task</b></li></ol>	AWS administrator, DBA

Task	Description	Skills required
	<p>setting to <b>Automatically on create</b>.</p>	
<p>Record the AWS DMS task Amazon Resource Name (ARN).</p>	<p>Use the ARN to obtain the AWS DMS task name for later use. To retrieve the AWS DMS task ARN, run the following command:</p> <pre data-bbox="597 604 1026 722">aws dms describe-replication-tasks</pre> <p>The task name will be needed when performing another managed failover or during a DR scenario.</p>	<p>AWS administrator, DBA</p>
<p>Delete AWS DMS tasks.</p>	<p>Delete the original (currently stopped) AWS DMS task in the primary Region and the existing AWS DMS task (currently stopped) in the secondary Region.</p>	<p>AWS administrator</p>

## Related resources

- [Configuring your Amazon Aurora DB cluster](#)
- [Using Amazon Aurora global databases](#)
- [Working with Amazon Aurora MySQL](#)
- [Working with an AWS DMS replication instance](#)
- [Working with AWS DMS endpoints](#)
- [Working with AWS DMS tasks](#)
- [What is AWS CloudFormation?](#)

## Additional information

Amazon Aurora global databases are used in this example for DR because they provide an effective recovery time objective (RTO) of 1 second and a recovery point objective (RPO) of less than 1 minute, both lower than traditional replicated solutions and ideal for DR scenarios.

Amazon Aurora global databases offer many other advantages, including the following:

- Global reads with local latency – Global consumers can access information in a local Region, with local latency.
- Scalable secondary Amazon Aurora DB clusters – Secondary clusters can be scaled independently, adding up to 16 read-only replicas.
- Fast replication from primary to secondary Amazon Aurora DB clusters – Replication has little performance impact on the primary cluster. It occurs at the storage layer, with typical cross-Region replication latencies of less than 1 second.

This pattern also uses AWS DMS for replication. Amazon Aurora databases provide the ability to create read replicas, which can simplify the replication process and the DR setup. However, AWS DMS is often used to replicate when data transformations are required or when the target database requires additional indexes that the source database does not have.



# Migrate Oracle functions and procedures that have more than 100 arguments to PostgreSQL

Created by Srinivas Potlachervoo (AWS)

<b>Environment:</b> PoC or pilot	<b>Source:</b> Oracle	<b>Target:</b> PostgreSQL
<b>R Type:</b> Replatform	<b>Workload:</b> Open-source; Oracle	<b>Technologies:</b> Databases; Migration
<b>AWS services:</b> Amazon RDS; Amazon Aurora		

## Summary

This pattern shows how to migrate Oracle Database functions and procedures that have more than 100 arguments to PostgreSQL. For example, you can use this pattern to migrate Oracle functions and procedures to one of the following PostgreSQL-compatible AWS database services:

- Amazon Relational Database Service (Amazon RDS) for PostgreSQL
- Amazon Aurora PostgreSQL-Compatible Edition

PostgreSQL doesn't support functions or procedures that have more than 100 arguments. As a workaround, you can define a new data type that has type fields that match the source function's arguments. Then, you can create and run a PL/pgSQL function that uses the custom data type as an argument.

## Prerequisites and limitations

### Prerequisites

- An active AWS account
- An [Amazon RDS Oracle database \(DB\) instance](#)
- An [Amazon RDS for PostgreSQL DB instance](#) or an [Aurora PostgreSQL-Compatible DB instance](#)

## Product versions

- Amazon RDS Oracle DB instance versions 10.2 and later
- Amazon RDS PostgreSQL DB instance versions 9.4 and later, or Aurora PostgreSQL-Compatible DB instance versions 9.4 and later
- Oracle SQL Developer version 18 and later
- pgAdmin version 4 and later

## Architecture

### Source technology stack

- Amazon RDS Oracle DB instance versions 10.2 and later

### Target technology stack

- Amazon RDS PostgreSQL DB instance versions 9.4 and later, or Aurora PostgreSQL-Compatible DB instance versions 9.4 and later

## Tools

### AWS services

- [Amazon Relational Database Service \(Amazon RDS\) for PostgreSQL](#) helps you set up, operate, and scale a PostgreSQL relational database in the AWS Cloud.
- [Amazon Aurora PostgreSQL-Compatible Edition](#) is a fully managed, ACID-compliant relational database engine that helps you set up, operate, and scale PostgreSQL deployments.

### Other services

- [Oracle SQL Developer](#) is an integrated development environment that simplifies the development and management of Oracle databases in both traditional and cloud-based deployments.
- [pgAdmin](#) is an open-source management tool for PostgreSQL. It provides a graphical interface that helps you create, maintain, and use database objects.

## Best practices

Make sure that the data type that you create matches the type fields that are included in the source Oracle function or procedure.

## Epics

### Run an Oracle function or procedure that has more than 100 arguments

Task	Description	Skills required
<p>Create or identify an existing Oracle/PLSQL function or procedure that has more than 100 arguments.</p>	<p>Create an Oracle/PLSQL function or procedure that has more than 100 arguments .</p> <p>-or-</p> <p>Identify an existing Oracle/PLSQL function or procedure that has more than 100 arguments.</p> <p>For more information, see sections <a href="#">14.7 CREATE FUNCTION Statement</a> and <a href="#">14.11 CREATE PROCEDURE Statement</a> in the Oracle Database documentation.</p>	<p>Oracle/PLSQL knowledge</p>
<p>Compile the Oracle/PLSQL function or procedure.</p>	<p>Compile the Oracle/PLSQL function or procedure.</p> <p>For more information, see <a href="#">Compiling a function</a> in the Oracle Database documentation.</p>	<p>Oracle/PLSQL knowledge</p>

Task	Description	Skills required
Run the Oracle/PLSQL function.	Run the Oracle/PLSQL function or procedure. Then, save the output.	Oracle/PLSQL knowledge

### Define a new data type that matches the source function's or procedure's arguments

Task	Description	Skills required
Define a new data type in PostgreSQL.	<p>Define a new data type in PostgreSQL that includes all of the same fields that appear in the source Oracle function's or procedure's arguments.</p> <p>For more information, see <a href="#">CREATE TYPE</a> in the PostgreSQL documentation.</p>	PostgreSQL PL/pgSQL knowledge

### Create a PostgreSQL function that includes the new TYPE argument

Task	Description	Skills required
Create a PostgreSQL function that includes the new data type.	<p>Create a PostgreSQL function that includes the new TYPE argument.</p> <p>To review an example function, see the <b>Additional information</b> section of this pattern.</p>	PostgreSQL PL/pgSQL knowledge
Compile the PostgreSQL function.	Compile the function in PostgreSQL. If the new data type fields match the source	PostgreSQL PL/pgSQL knowledge

Task	Description	Skills required
	function's or procedure's arguments, then the function successfully compiles.	
Run the PostgreSQL function.	Run the PostgreSQL function.	PostgreSQL PL/pgSQL knowledge

## Troubleshooting

Issue	Solution
The function returns the following error: <b>ERROR: syntax error near "&lt;statement&gt;"</b>	Make sure that all of the function's statements end with a semicolon (;).
The function returns the following error: <b>ERROR: "&lt;variable&gt;" is not a known variable</b>	Make sure that the variable that's used in the function body is listed within the function's DECLARE section.

## Related resources

- [Working with Amazon Aurora PostgreSQL](#) (*Amazon Aurora User Guide for Aurora*)
- [CREATE TYPE](#) (PostgreSQL documentation)

## Additional information

### Example PostgreSQL function that includes a TYPE argument

```
CREATE OR REPLACE FUNCTION test_proc_new
(
  IN p_rec type_test_proc_args
)
RETURNS void
AS
$BODY$
```

```
BEGIN

  /*
  *****
  The body would contain code to process the input values.
  For our testing, we will display couple of values.
  *****
  */
  RAISE NOTICE USING MESSAGE = CONCAT_WS(' ', 'p_acct_id: ', p_rec.p_acct_id);
  RAISE NOTICE USING MESSAGE = CONCAT_WS(' ', 'p_ord_id: ', p_rec.p_ord_id);
  RAISE NOTICE USING MESSAGE = CONCAT_WS(' ', 'p_ord_date: ', p_rec.p_ord_date);

END;
$BODY$
LANGUAGE plpgsql
COST 100;
```

# Migrate Amazon RDS for Oracle DB instances to other accounts that use AMS

Created by Pinesh Singal (AWS)

<b>Environment:</b> PoC or pilot	<b>Source:</b> Databases: Relational	<b>Target:</b> Amazon RDS for Oracle on AWS Managed Services
<b>R Type:</b> Rehost	<b>Workload:</b> Oracle	<b>Technologies:</b> Databases; Migration; Storage & backup
<b>AWS services:</b> Amazon RDS; AWS Managed Services		

## Summary

This pattern shows you how to migrate an Amazon Relational Database Service (Amazon RDS) for Oracle DB instance from one AWS account to another AWS account. The pattern applies to scenarios where the source AWS account doesn't use AWS Managed Services (AMS) but the target account does use AMS. You can complete the migration by using a [request for change \(RFC\)](#) in AMS instead of using the AWS Management Console to perform database operations. This approach provides minimal downtime for a multi-terabyte Oracle source database with a high number of transactions. For example, the downtime for a 400–900 GB database could last for approximately two or three hours. Database migration time is directly proportionate to the size of the Amazon RDS for Oracle DB instance.

**Important:** This pattern requires you to take a database snapshot of the Amazon RDS for Oracle DB instance in a source account, copy the snapshot to a target account that's using AMS, and then create a new DB instance from that snapshot by raising RFCs.

## Prerequisites and limitations

### Prerequisites

- An active AWS account for the source account

- An active AWS account that uses AMS for the target account
- Amazon RDS for Oracle DB instance, up and running

## Limitations

- The same properties or configurations for the DB instances in the source account are copied over to a new target DB instance on AMS.
- The RFC method that's used in this migration approach has limited features to support Amazon RDS for Oracle. You can access the full features of Amazon RDS for Oracle by using an AWS CloudFormation template to perform the database migration.
- You can experience an application outage for several hours because the migration must be completed during scheduled downtime. During downtime, you stop the DB instance in the source account, and then you go live to a new DB instance in the target account.
- This migration approach doesn't apply to the migration of a DB instance from one AWS Region to another Region within the same AWS account.

## Product versions

- Oracle Database Standard Edition 2 (SE2) 12.1.0.2.v2 instance and later on Amazon RDS for Oracle
- Amazon RDS for Oracle 11g is no longer supported (For more information, see [Amazon RDS for Oracle](#) in the Amazon RDS documentation.)

## Architecture

### Source technology stack

- Oracle Database SE2 12.1.0.2.v2 instance on Amazon RDS for Oracle
- Amazon RDS subnet group
- Amazon RDS option group (if needed)
- Amazon RDS parameter group (if needed)
- Amazon Virtual Private Cloud (Amazon VPC) security group
- AWS Key Management Service (AWS KMS) with AWS managed keys or customer managed keys
- AWS Identity and Access Management (IAM) role (if needed)



## Target technology stack

- Oracle Database SE2 12.1.0.2.v2 instance on Amazon RDS for Oracle
- Amazon RDS subnet group
- Amazon RDS option group (if needed)
- Amazon RDS parameter group (if needed)
- Amazon VPC security group
- AWS Managed Services (AMS)
- AWS KMS with AWS managed keys and customer managed keys
- IAM role (if needed)

## Source and target migration architecture

The following diagram shows the migration of an Amazon RDS for Oracle DB instance in one AWS account to an Amazon RDS for Oracle DB instance in another AWS account that uses AMS.

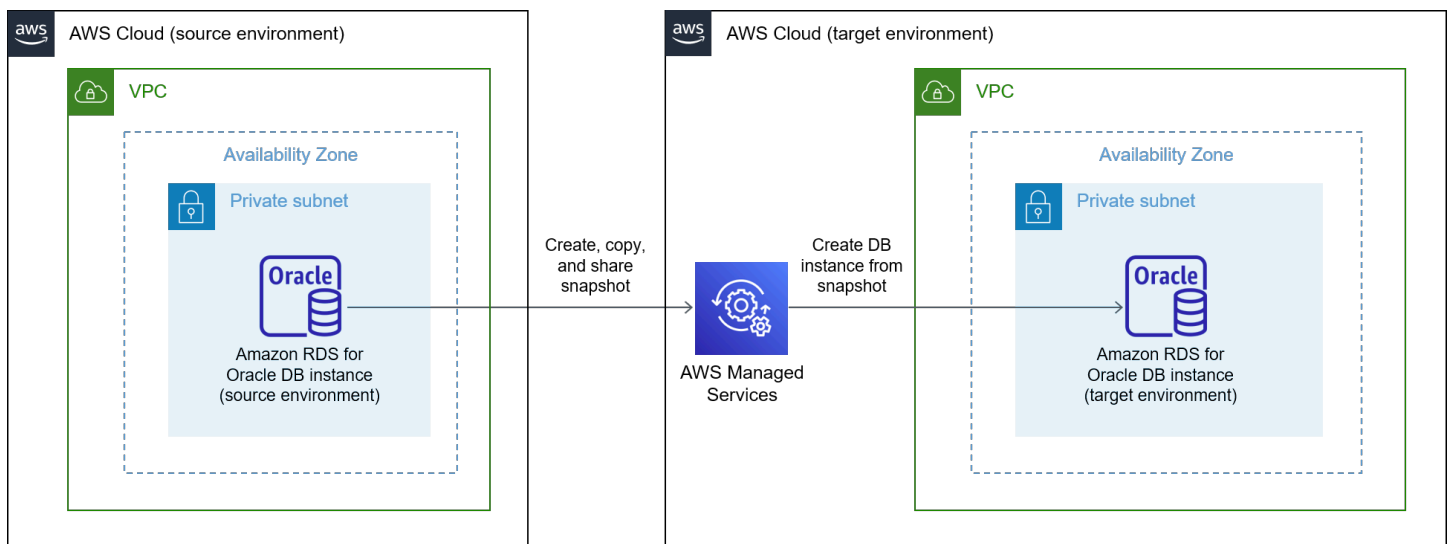

The diagram shows the following workflow:

1. Take a database snapshot of the Amazon RDS for Oracle DB instance in the source account.
2. Copy the snapshot to AMS in the target account.
3. Create a new Amazon RDS for Oracle DB instance from the snapshot in the target account.

## Automation and scale

You can automate and scale the migration by using CloudFormation templates and [creating RFCs in AMS](#). CloudFormation enables you to use all the features of Amazon RDS for Oracle, including the ability to configure and restore the DB instance when you create an Amazon RDS for Oracle DB instance from a snapshot.

## Tools

- [Amazon Relational Database Service \(Amazon RDS\) for Oracle](#) helps you set up, operate, and scale an Oracle relational database in the AWS Cloud.
- [AWS Key Management Service \(AWS KMS\)](#) helps you create and control cryptographic keys to help protect your data.
- [AWS Managed Services \(AMS\)](#) helps you operate your AWS infrastructure more efficiently and securely.

## Epics

### Prepare for cutover on the target account

Task	Description	Skills required
Create a custom AWS KMS key.	<ol style="list-style-type: none"><li>1. Raise an automated RFC called <a href="#">Create KMS key</a> to create a custom KMS key from your target account.</li><li>2. Share your custom KMS key with the source account. <b>Note:</b> You can't share Amazon RDS for Oracle DB instances that use the default <a href="#">AWS managed key</a> for Amazon RDS (aws/rds). Instead, share the DB instance by re-encrypting the DB instance from your KMS key.</li></ol>	AWS, AMS

Task	Description	Skills required
Create a security group.	<p>Raise an automated RFC called <a href="#">Create security group</a> to create a security group for your VPC from your target account.</p> <p>Be sure to specify the following:</p> <ul style="list-style-type: none"><li>• New security group name</li><li>• TCP and UDP ingress and egress rules</li><li>• Standard tags</li></ul>	AWS, AMS

Task	Description	Skills required
(Optional) Review your Amazon RDS resources.	<p>The following resources are created when an Amazon RDS for Oracle DB instance is created:</p> <ul style="list-style-type: none"> <li>• Amazon RDS subnet group (based on the subnet ID)</li> <li>• Amazon RDS option group (based on the snapshot of the source DB instance)</li> <li>• Amazon RDS parameter group (based on the snapshot of the DB instance)</li> </ul> <p>If you want to review the Amazon RDS resources that were created when you created your DB instance, then you can <a href="#">connect to your Oracle DB instance</a> and find your subnet group, option group, and parameter group in the Amazon RDS console.</p>	AWS

### Cut over on the source account

Task	Description	Skills required
Stop the application.	Stop the application and its dependent services. You must stop all traffic to the database in the source account.	App owner

Task	Description	Skills required
Take a manual snapshot.	Manually <a href="#">create a DB snapshot</a> of the Amazon RDS for Oracle DB instance in the source account.	AWS
Stop the DB instance.	<a href="#">Stop the Amazon RDS for Oracle DB instance.</a>	AWS
Copy the snapshot.	<a href="#">Copy the DB snapshot</a> to the same source account, and then use the custom KMS key shared from the target account to re-encrypt the copied DB snapshot file.	AWS
Share the snapshot.	<a href="#">Share the new snapshot</a> (copied with the custom KMS key) with the target account.	AWS

### Cut over on the target account

Task	Description	Skills required
Copy the snapshot.	<p>Raise an automated RFC called <a href="#">Copy RDS snapshot</a> to copy the DB snapshot to the same target account and use the default AWS managed KMS key created for re-encryption.</p> <p>This is required to make the target account the owner of the new snapshot and to enable the Amazon RDS for</p>	AWS, AMS

Task	Description	Skills required
	<p>Oracle DB instance created from the snapshot to be associated with the option group, if needed.</p>	
<p>Create a DB instance from the snapshot.</p>	<p>Raise an automated RFC called <a href="#">Create DB from snapshot</a> to create an Amazon RDS for Oracle DB instance from the snapshot.</p> <p>Be sure to specify the following:</p> <ul style="list-style-type: none"> <li>• New snapshot ID created in the previous step</li> <li>• VPC ID</li> <li>• Subnet ID</li> <li>• RDS instance ID</li> <li>• Standard tags</li> </ul>	<p>AWS, AMS</p>
<p>Attach the instance to the security group and make configuration updates.</p>	<ol style="list-style-type: none"> <li>1. Raise a manual RFC called <a href="#">Update Other</a> to attach the Amazon RDS for Oracle DB instance that you created previously with the VPC security group that you created previously.</li> <li>2. Make any additional changes to the Amazon RDS for Oracle DB instance configuration.</li> </ol>	<p>AWS, AMS</p>

Task	Description	Skills required
Test the DB instance.	<p>Test the new Amazon RDS for Oracle DB instance endpoint connectivity by logging into any instance or application server hosted on the same security group and by using telnet to connect to the 1521 port. For more information, see <a href="#">Connecting to an Amazon RDS DB instance</a> in the Amazon RDS documentation.</p> <p><b>Note:</b> If the primary user login credentials are available, you can test the Amazon RDS for Oracle DB instance by logging in from any SQL client (such as Oracle SQL Developer).</p>	AWS, DBA

## Related resources

- [AWS Managed Services](#) (AWS documentation)
- [How RFCs work](#) (AWS Managed Services documentation)
- [Sharing encrypted snapshots](#) (Amazon RDS User Guide)
- [How can I share an encrypted Amazon RDS DB snapshot with another account?](#) (AWS Knowledge Center)
- [What is Amazon Relational Database Service \(Amazon RDS\)?](#) (Amazon RDS User Guide)
- [Amazon RDS for Oracle](#) (Amazon RDS User Guide)
- [Using the AMS consoles](#) (AWS Managed Services documentation)

## Additional information

### Roll back the migration

If you want to roll back the migration, complete the following steps:

1. Raise a manual RFC (Update Other) from the target account to delete the database stack created in the target account.
2. Update the application configuration to point to the Amazon RDS for Oracle DB instance in the source account.
3. Start the Amazon RDS for Oracle DB instance in the source account.



# Migrate Oracle OUT bind variables to a PostgreSQL database

Created by Bikash Chandra Rout (AWS) and Vinay Paladi (AWS)

<b>Environment:</b> PoC or pilot	<b>Source:</b> Database Relational	<b>Target:</b> RDS/Aurora Postgresql
<b>R Type:</b> Replatform	<b>Workload:</b> Oracle	<b>Technologies:</b> Databases; Migration

**AWS services:** Amazon  
Aurora; Amazon RDS; AWS  
SCT

## Summary

This pattern shows how to migrate Oracle Database OUT bind variables to either one of the following PostgreSQL-compatible AWS database services:

- Amazon Relational Database Service (Amazon RDS) for PostgreSQL
- Amazon Aurora PostgreSQL-Compatible Edition

PostgreSQL doesn't support OUT bind variables. To get the same functionality in your Python statements, you can create a custom PL/pgSQL function that uses the GET and SET package variables instead. To apply these variables, the example wrapper function script that's provided in this pattern uses an [AWS Schema Conversion Tool \(AWS SCT\) extension pack](#).

**Note:** If the Oracle EXECUTE IMMEDIATE statement is a SELECT statement that can return one row at most, it's a best practice to do the following:

- Put OUT bind variables (defines) in the INTO clause
- Put IN bind variables in the USING clause

For more information, see [EXECUTE IMMEDIATE statement](#) in the Oracle documentation.

## Prerequisites and limitations

### Prerequisites

- An active AWS account
- An Oracle Database 10g (or newer) source database in an on-premises data center
- An [Amazon RDS for PostgreSQL DB instance](#) or an [Aurora PostgreSQL-Compatible DB instance](#)

## Architecture

### Source technology stack

- On-premises Oracle Database 10g (or newer) database

### Target technology stack

- An Amazon RDS for PostgreSQL DB instance or an Aurora PostgreSQL-Compatible DB instance

### Target architecture

The following diagram shows an example workflow for migrating Oracle Database OUT bind variables to a PostgreSQL-compatible AWS database.

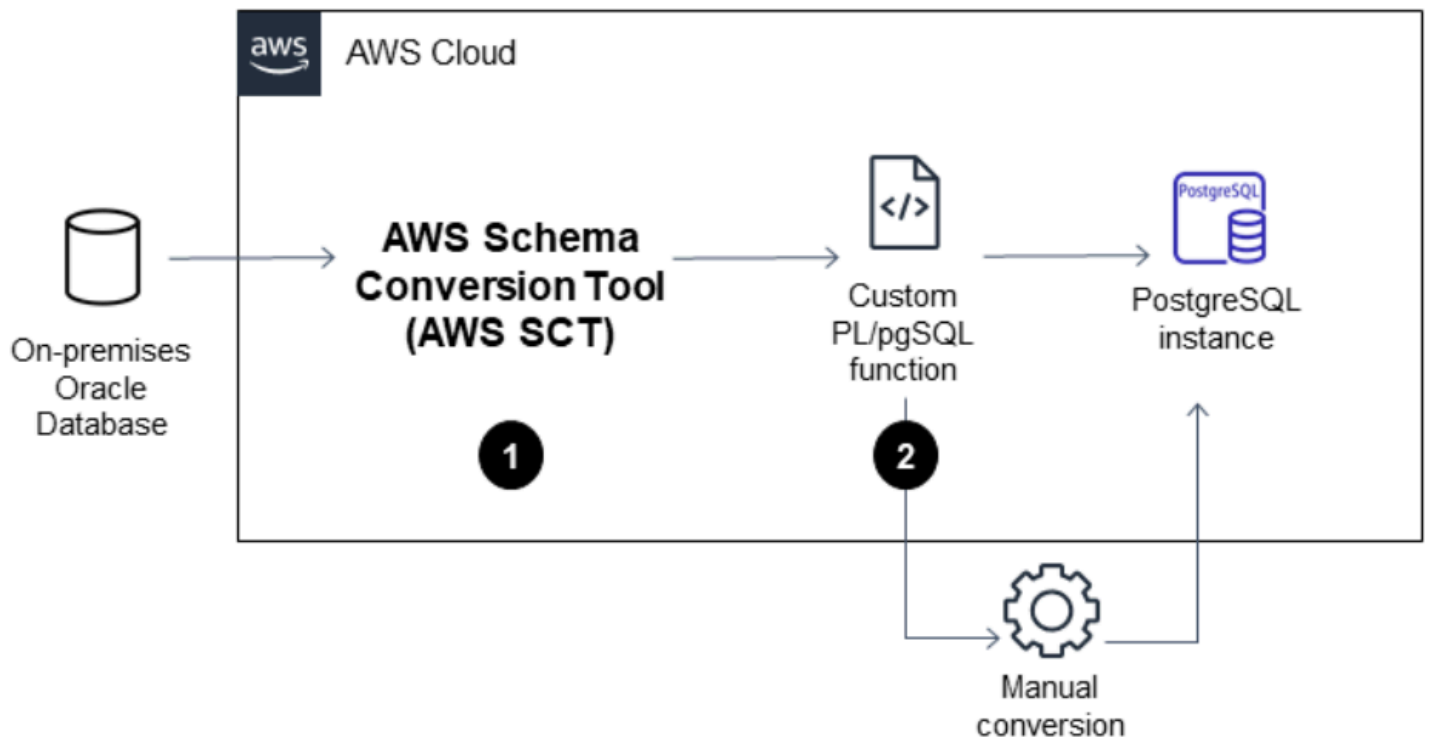

The diagram shows the following workflow:

1. AWS SCT converts the source database schema and a majority of the custom code to a format compatible with the target PostgreSQL-compatible AWS database.
2. Any database objects that can't be converted automatically are flagged by the PL/pgSQL function. Objects that are flagged are then manually converted to complete the migration.

## Tools

- [Amazon Aurora PostgreSQL-Compatible Edition](#) is a fully managed, ACID-compliant relational database engine that helps you set up, operate, and scale PostgreSQL deployments.
- [Amazon Relational Database Service \(Amazon RDS\) for PostgreSQL](#) helps you set up, operate, and scale a PostgreSQL relational database in the AWS Cloud.
- [AWS Schema Conversion Tool \(AWS SCT\)](#) supports heterogeneous database migrations by automatically converting the source database schema and a majority of the custom code to a format compatible with the target database.
- [pgAdmin](#) is an open-source management tool for PostgreSQL. It provides a graphical interface that helps you create, maintain, and use database objects.

## Epics

### Migrate Oracle OUT bind variables by using a custom PL/pgSQL function and AWS SCT

Task	Description	Skills required
<p>Connect to your PostgreSQL-compatible AWS database.</p>	<p>After you've created your DB instance, you can use any standard SQL client application to connect to a database in your DB cluster. For example, you can use <a href="#">pgAdmin</a> to connect to your DB instance.</p> <p>For more information, see either of the following:</p> <ul style="list-style-type: none"> <li>• <a href="#">Connecting to an Amazon RDS DB instance</a> in the <i>Amazon RDS User Guide</i></li> <li>• <a href="#">Connecting to an Amazon Aurora DB cluster</a> in the <i>Amazon Aurora User Guide</i></li> </ul>	<p>Migration engineer</p>
<p>Add the example wrapper function script from this pattern to the target database's main schema.</p>	<p>Copy the example PL/pgSQL wrapper function script from the <b>Additional information</b> section of this pattern. Then, add the function to the target database's main schema.</p> <p>For more information, see <a href="#">CREATE FUNCTION</a> in the PostgreSQL documentation.</p>	<p>Migration engineer</p>
<p>(Optional) Update the search path in the target database's</p>	<p>To improve performance, you can update the PostgreSQ</p>	<p>Migration engineer</p>

Task	Description	Skills required
main schema so that includes the Test_pg schema.	<p>L <b>search_path</b> variable so that it includes the <b>Test_pg</b> schema name. If you include the schema name in the search path, you don't need to specify the name whenever you call the PL/pgSQL function.</p> <p>For more information, see section <a href="#">5.9.3 The Schema Search Path</a> in the PostgreSQL documentation.</p>	

## Related resources

- [AWS Schema Conversion Tool](#)
- [OUT bind variables](#) (Oracle documentation)
- [Improve SQL query performance by using bind variables](#) (Oracle Blog)

## Additional information

### Example PL/pgSQL function

```
/* Oracle */  
  
CREATE or replace PROCEDURE test_pg.calc_stats_new1 (  
    a NUMBER,  
    b NUMBER,  
    result out NUMBER  
)  
  
IS  
BEGIN  
    result:=a+b;  
END;
```

```
/
/* Testing */
set serveroutput on
DECLARE
  a NUMBER := 4;
  b NUMBER := 7;
  plsqli_block VARCHAR2(100);
  output number;
BEGIN
  plsqli_block := 'BEGIN test_pg.calc_stats_new1(:a, :b,:output); END;';
  EXECUTE IMMEDIATE plsqli_block USING a, b,out output; -- calc_stats(a, a, b, a)
  DBMS_OUTPUT.PUT_LINE('output:'||output);
END;

output:11

PL/SQL procedure successfully completed.

--Postgres--

/* Example : 1 */
CREATE OR REPLACE FUNCTION test_pg.calc_stats_new1(
                                                    w integer,
                                                    x integer
                                                    )
RETURNS integer
AS
$BODY$
begin
    return w + x ;
end;
$BODY$
LANGUAGE plpgsql;

CREATE OR REPLACE FUNCTION aws_oracle_ext.set_package_variable(
                                                    package_name name,
                                                    variable_name name,
                                                    variable_value
                                                    anyelement
                                                    )
RETURNS void
LANGUAGE 'plpgsql'
```

```
        COST 100
        VOLATILE
AS $BODY$
begin
    perform set_config
        ( format( '%s.%s',package_name, variable_name )
          , variable_value::text
          , false );
end;
$BODY$;

CREATE OR REPLACE FUNCTION aws_oracle_ext.get_package_variable_record(
    name,
    package_name
    record_name name
)
RETURNS text
LANGUAGE 'plpgsql'
    COST 100
    VOLATILE
AS $BODY$
begin
    execute 'select ' || package_name || '$Init()';

    return aws_oracle_ext.get_package_variable
        (
            package_name := package_name
            , variable_name := record_name || '$REC' );
end;
$BODY$;

--init()--
CREATE OR REPLACE FUNCTION test_pg.init()
RETURNS void
AS
$BODY$
BEGIN
if aws_oracle_ext.is_package_initialized('test_pg' ) then
    return;
end if;
perform aws_oracle_ext.set_package_initialized
    ('test_pg' );
PERFORM aws_oracle_ext.set_package_variable('test_pg', 'v_output', NULL::INTEGER);
```

```
PERFORM aws_oracle_ext.set_package_variable('test_pg', 'v_status', NULL::text);
END;
$BODY$
LANGUAGE plpgsql;

/* callable for 1st Example */

DO $$
declare
v_sql text;
v_output_loc int;
a integer :=1;
b integer :=2;
BEGIN
perform test_pg.init();
--raise notice 'v_sql %',v_sql;
execute 'do $$ declare v_output_l int; begin select * from test_pg.calc_stats_new1('||
a||','||b||') into v_output_l;
PERFORM aws_oracle_ext.set_package_variable('test_pg','v_output', v_output_l) ;
end; $$' ;
v_output_loc := aws_oracle_ext.get_package_variable('test_pg', 'v_output');
raise notice 'v_output_loc %',v_output_loc;
END ;
$$

/*In above Postgres example we have set the value of v_output using v_output_l in the
dynamic anonymous block to mimic the
behaviour of oracle out-bind variable .*/

--Postgres Example : 2 --
CREATE OR REPLACE FUNCTION test_pg.calc_stats_new2(
w integer,
x integer,
inout status text,
out result integer)
AS
$BODY$
DECLARE
begin
result := w + x ;
status := 'ok';
end;
$BODY$
LANGUAGE plpgsql;
```



```
/* callable for 2nd Example */
DO $$
declare
v_sql text;
v_output_loc int;
v_staus text:= 'no';
a integer :=1;
b integer :=2;
BEGIN
perform test_pg.init();
execute 'do $$ declare v_output_l int; v_status_l text; begin select * from
  test_pg.calc_stats_new2('||a||','||b||','''||v_staus||''') into v_status_l,v_output_l;
PERFORM aws_oracle_ext.set_package_variable('test_pg', 'v_output', v_output_l) ;
PERFORM aws_oracle_ext.set_package_variable('test_pg', 'v_status', v_status_l) ;
end; $$' ;
v_output_loc := aws_oracle_ext.get_package_variable('test_pg', 'v_output');
v_staus := aws_oracle_ext.get_package_variable('test_pg', 'v_status');
raise notice 'v_output_loc %',v_output_loc;
raise notice 'v_staus %',v_staus;
END ;
$$
```

# Migrate SAP HANA to AWS using SAP HSR with the same hostname

Created by Pradeep Puliampatta (AWS)

<b>Environment:</b> Production	<b>Source:</b> SAP HANA DB on-premises	<b>Target:</b> SAP HANA DB on AWS
<b>R Type:</b> Rehost	<b>Workload:</b> SAP	<b>Technologies:</b> Databases; Migration
<b>AWS services:</b> AWS Client VPN; AWS Direct Connect; Amazon EBS		

## Summary

SAP HANA migrations to Amazon Web Services (AWS) can be performed using multiple options, including backup and restore, export and import, and SAP HANA System Replication (HSR). The selection of a particular option depends on the network connectivity between source and target SAP HANA databases, the size of the source database, downtime considerations, and other factors.

The SAP HSR option for migrating SAP HANA workloads to AWS works well when there is a stable network between the source and target systems and the entire database (SAP HANA DB replication snapshot) can be completely replicated within 1 day, as stipulated by SAP for network throughput requirements for SAP HSR. The downtime requirements with this approach are limited to performing the takeover on the target AWS environment, SAP HANA DB backup, and post-migration tasks.

SAP HSR supports the use of different hostnames (hostnames mapped to different IP addresses) for replication traffic between the primary, or source, and secondary, or target, systems. You can do this by defining those specific sets of hostnames under the [system\_replication\_hostname\_resolution] section in `global.ini`. In this section, all hosts of the primary and the secondary sites must be defined on each host. For detailed configuration steps, see the [SAP documentation](#).

One key takeaway from this setup is that the hostnames in the primary system must be different from the hostnames in the secondary system. Otherwise, the following errors can be observed.

- "each site must have a unique set of logical hostnames"
- "remoteHost does not match with any host of the source site. All hosts of source and target site must be able to resolve all hostnames of both sites correctly"

However, the number of post-migration steps can be reduced by using the same SAP HANA DB hostname on the target AWS environment.

This pattern provides a workaround for using the same hostname on source and target environments when using the SAP HSR option. With this pattern, you can use the SAP HANA Hostname Rename option. You assign a temporary hostname to the target SAP HANA DB to facilitate hostname uniqueness for SAP HSR. After the migration completes the takeover milestone on the target SAP HANA environment, you can revert the target system hostname back to the hostname of the source system.

## Prerequisites and limitations

### Prerequisites

- An active AWS account.
- A virtual private cloud (VPC) with a virtual private network (VPN) endpoint or a router.
- AWS Client VPN or AWS Direct Connect configured to transfer files from the source to the target.
- SAP HANA databases in both the source and the target environment. The target SAP HANA DB patch level should be equal to or higher than the source SAP HANA DB patch level, within the same SAP HANA Platform edition. For example, replication cannot be set up between HANA 1.0 and HANA 2.0 systems. For more information, see question 15 in SAP Note: 1999880 – FAQ: SAP HANA System Replication.
- SAP application servers in the target environment.
- Amazon Elastic Block Store (Amazon EBS) volumes in the target environment.

### Limitations

The following list of SAP documents covers known issues that are related to this workaround, including constraints regarding SAP HANA dynamic tiering and scale-out migrations:

- 2956397 – Renaming of SAP HANA Database System failed
- 2222694 – When trying to rename the HANA system, the following error appears "Source files are not owned by the original sidadm user (uid = xxxx)"
- 2607227 – hdblcm: register\_rename\_system: Renaming SAP HANA instance failed
- 2630562 – HANA Hostname Rename failed and HANA does not start up
- 2935639 – sr\_register is not using the hostname that is specified under system\_replication\_hostname\_resolution in the global.ini section
- 2710211 – Error: source system and target system have overlapping logical hostnames
- 2693441 – Failed to rename an SAP HANA System due to error
- 2519672 – HANA Primary and Secondary has different system PKI SSFS data and key or unable to check
- 2457129 – SAP HANA System Host Rename is not Permitted when Dynamic Tiering is Part of Landscape
- 2473002 – Using HANA System Replication to migrate scale out system (There are no restrictions provided by SAP in using this hostname rename approach for scale-out SAP HANA systems. However, the procedure must be repeated on each individual host. Other scale-out migration limitations also apply to this approach.)

## Product versions

- This solution applies to SAP HANA DB platform edition 1.0 and 2.0.

## Architecture

### Source setup

An SAP HANA database is installed on the source environment. All the SAP application server connections and DB interfaces use the same hostname for client connections. The following diagram shows the example source hostname hdbhost and its corresponding IP address.

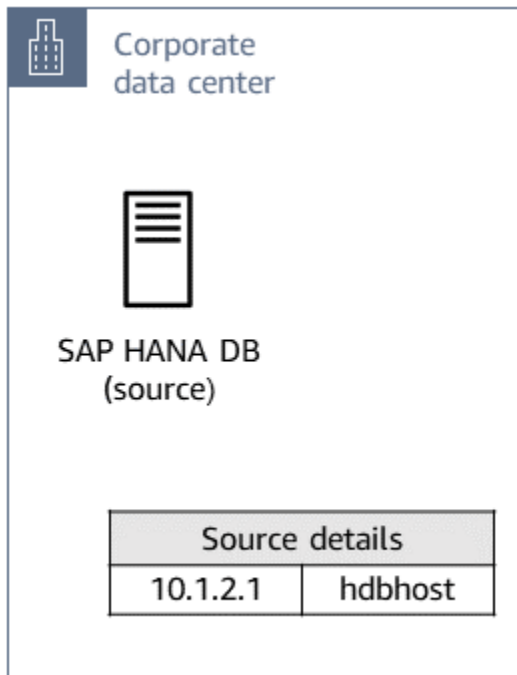

## Target setup

The AWS Cloud target environment uses the same hostname to run an SAP HANA database. The target environment on AWS includes the following:

- SAP HANA database
- SAP application servers
- EBS volumes

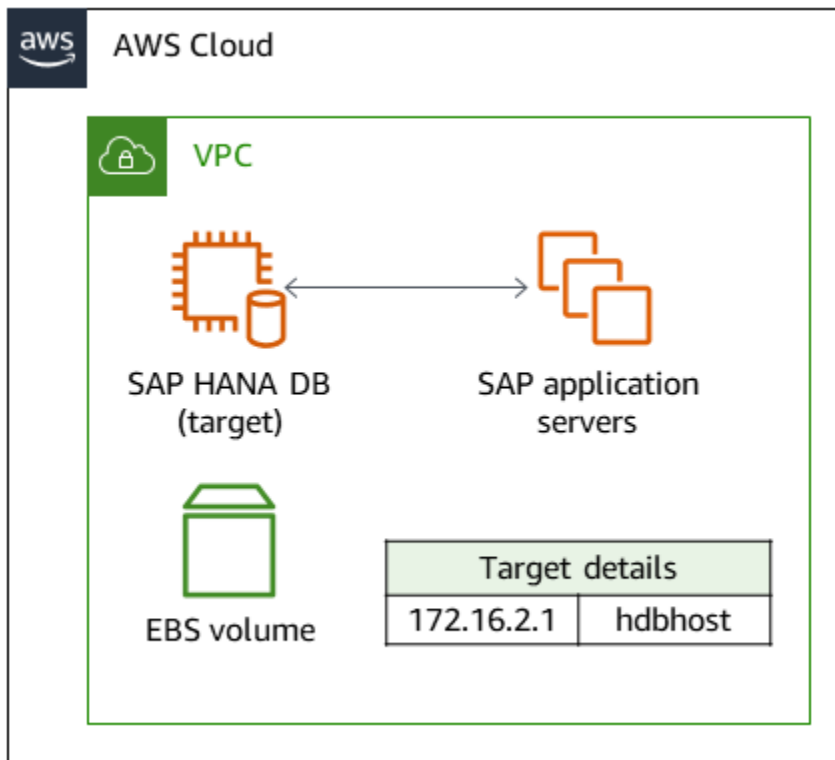

### Intermediate configuration

In the following diagram, the hostname on the AWS target environment is temporarily renamed as temp-host so that the hostnames on the source and target are unique. After the migration completes the takeover milestone on the target environment, the target system virtual hostname is renamed using the original name, hdbhost.

The intermediate configuration includes one of the following options:

- AWS Client VPN with a Client VPN endpoint
- AWS Direct Connect connecting to a router

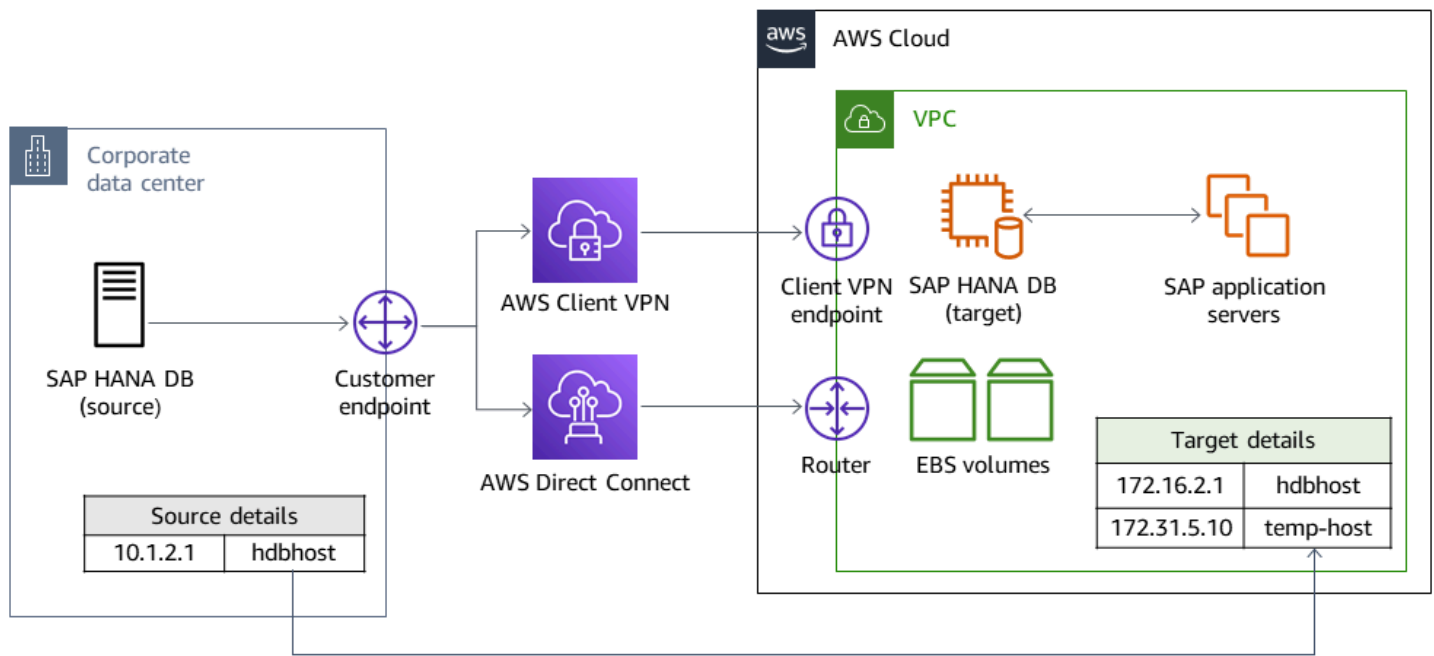

SAP application servers on the AWS target environment can be installed either before replication setup or after the takeover. However, installing the application servers before replication setup can help with reduction of downtime during installation, configuration of high availability, and backups.

## Tools

### AWS services

- [AWS Client VPN](#) is a managed client-based VPN service that enables you to securely access AWS resources and resources in your on-premises network.
- [AWS Direct Connect](#) links your internal network to an AWS Direct Connect location over a standard Ethernet fiber-optic cable. With this connection, you can create virtual interfaces directly to public AWS services, bypassing internet service providers in your network path.
- [Amazon Elastic Block Store \(Amazon EBS\)](#) provides block level storage volumes for use with Amazon Elastic Compute Cloud (Amazon EC2) instances. EBS volumes behave like raw, unformatted block devices. You can mount these volumes as devices on your instances.

### Other tools

- [SAP application servers](#) – SAP application servers provide programmers with a way to express business logic. The SAP application server performs the data processing based on the business logic. The actual data is stored in a database, which is a separate component.
- [SAP HANA cockpit](#) and [SAP HANA Studio](#) – Both SAP HANA cockpit and SAP HANA Studio provide an administrative interface to the SAP HANA database. In SAP HANA Studio, the SAP HANA Administration console is the system view that provides relevant content for SAP HANA database administration.
- [SAP HANA System Replication](#) – SAP HANA System Replication (SAP HSR) is the standard procedure provided by SAP for replicating SAP HANA databases. The required executables for SAP HSR are part of the SAP HANA server kernel itself.

## Epics

### Prepare the source and target environments

Task	Description	Skills required
Install and configure the SAP HANA databases.	In the source and target environments, ensure that the SAP HANA DB is installed and configured according to SAP HANA on best practices. For more information, see <a href="#">SAP HANA on AWS</a> .	SAP Basis administration
Map the IP address.	In the target environment, ensure that the temporary hostname is assigned to an internal IP address.  1. Assign a secondary IPv4 address to the EC2 instance on the AWS Management Console by navigating to <b>EC2, Instance, Actions, Networking, Manage IP</b>	AWS administration



Task	Description	Skills required
	<p><b>address, Assign new IP address.</b></p> <p>2. To assign the same address to the EC2 network adaptor (NIC), from the operating system, as root user, run the command <code>ip addr add &lt;IP&gt;/32 dev eth0</code>, replacing &lt;IP&gt; with the IP address from step 1.</p>	
Resolve target hostnames.	On the secondary SAP HANA DB, confirm that both hostnames (hdbhost and temp-host ) are resolved for the SAP HANA replication networks by updating the relevant hostnames in the <code>/etc/hosts</code> file.	Linux administration
Back up the source and target SAP HANA databases.	Use SAP HANA Studio or the SAP HANA cockpit to perform backups on the SAP HANA databases.	SAP Basis administration

Task	Description	Skills required
Exchange system PKI certificates.	(Applies only to SAP HANA 2.0 and later) Exchange certificates in the system public key infrastructure (PKI) secure store in the file system (SSFS) store between the primary and secondary databases. For more information, see SAP Note 2369981 – Required configuration steps for authentication with SAP HANA System Replication.	SAP Basis administration

## Rename the target SAP HANA DB

Task	Description	Skills required
Stop target client connections.	In the target environment, shut down the SAP application servers and other client connections.	SAP Basis administration
Rename the target SAP HANA DB to the temporary hostname.	<ol style="list-style-type: none"> <li>As root user, rename the target SAP HANA DB hostname to the temporary hostname by using resident hdb1cm. <div data-bbox="630 1570 1027 1728" data-label="Code-Block"> <pre>root \$&gt; cd /hana/shared/&lt;SID/hdb1cm root \$&gt; ./hdb1cm</pre> </div> </li> <li>Choose option 9   rename_system  </li> </ol>	SAP Basis administration

Task	Description	Skills required
	<p>Rename the SAP HANA Database System.</p> <ol style="list-style-type: none"> <li>3. Provide the new name: temp-host .</li> <li>4. You can validate other options as needed. However, be sure that you don't mix up the host rename with a SID change (SAP Note 2598814 – hdblcm: SID rename fails).</li> </ol> <p>The SAP HANA DB stop and start will be controlled by hdblcm.</p>	
Assign replication networks.	<p>In the <code>global.ini</code> file of the source system, under the <code>[system_replication_hostname_resolution]</code> header, provide the source and target replication network details. Then copy the entries to the <code>global.ini</code> file on the target system.</p>	SAP Basis administration
Enable replication on primary.	<p>To enable replication on the source SAP HANA DB, run the following command.</p> <pre>hdbnsutil -sr_enable --name=siteA</pre>	SAP Basis administration

Task	Description	Skills required
Register the target SAP HANA DB as a secondary system.	<p>To register the target SAP HANA DB as a secondary system to source for SAP HSR, choose <b>async</b> replication.</p> <pre data-bbox="597 443 1026 877">(sid)adm \$&gt; HDB stop (sid)adm \$&gt; hdbnsutil - sr_register -name=sit eB -remotehost=hdbhos t / --remoteInstance=00 - replicationMode=async -operationMode=log replay (sid)adm \$&gt; HDB start</pre> <p>Alternatively, you can choose the <code>-online</code> option to register. In that case, you don't need to stop and start the SAP HANA DB.</p>	SAP Basis administration
Validate synchronization.	<p>On the source SAP HANA DB, verify that all the logs are applied on the target system (because it is async replication).</p> <p>To verify the replication, on the source, run the following commands.</p> <pre data-bbox="597 1629 1026 1822">(sid)adm \$&gt; cdp (sid)adm \$&gt; python systemReplicationS tatus.py</pre>	SAP Basis administration

Task	Description	Skills required
Shut down the source SAP application and SAP HANA DB.	During the migration cutover, perform a shutdown of the source system (the SAP application and SAP HANA database).	SAP Basis administration
Perform a takeover at the target.	To perform a takeover at the target on AWS, run the command <code>hdbnsutil -sr_takeover</code> .	SAP Basis administration
On the target SAP HANA DB, turn off replication.	To clear the replication metadata, stop replication on the target system by running the command <code>hdbnsutil -sr_disable</code> .  <b>Note:</b> This is in accordance with SAP Note 2693441 – Failed to rename an SAP HANA System due to error.	SAP Basis administration
Back up the target SAP HANA DB.	After the takeover is successful, we recommend performing a full SAP HANA DB backup.	SAP Basis administration

### Revert to the original hostname in the target system

Task	Description	Skills required
Revert the target SAP HANA DB hostname to the original.	1. To revert the target SAP HANA DB hostname to the original virtual hostname, use resident <code>hdb1cm</code> .	SAP Basis administration

Task	Description	Skills required
	<pre data-bbox="634 226 979 344">root \$&gt; cd /hana/sha red/&lt;SID&gt;/hdblcm root \$&gt; ./hdblcm</pre> <p data-bbox="592 384 997 667">2. Choose option 9   rename_system   Rename the SAP HANA Database System.</p> <p data-bbox="592 583 867 667">3. Provide the new name: hdbhost.</p> <p data-bbox="592 743 1016 1016">You can validate other options as needed. However, be sure that you don't mix up the host rename with a SID change (SAP Note 2598814 – hdblcm: SID rename fails).</p>	
Adjust hdbuserstore.	<p data-bbox="592 1094 1024 1367">Adapt the hdbuserstore details pointing to the source schema/user details. For detailed steps, see the <a href="#">SAP documentation</a>.</p> <p data-bbox="592 1413 1003 1633">To validate this step, run the command <code>R3trans -d</code>. The result should reflect a successful connection to the SAP HANA database.</p>	SAP Basis administration
Start up client connections.	<p data-bbox="592 1686 979 1856">In the target environment, start up the SAP application servers and other client connections.</p>	SAP Basis administration

## Related resources

### SAP references

SAP documentation references are frequently updated by SAP. To stay up to date, see SAP Note 2407186 – How-To Guides & Whitepapers For SAP HANA High Availability.

#### *Additional SAP notes*

- 2550327 – How-To Rename an SAP HANA System
- 1999880 – FAQ: SAP HANA System Replication
- 2078425 – Troubleshooting note for SAP HANA platform lifecycle management tool hdblcm
- 2592227 – FQDN suffix change in HANA systems
- 2048681 – Performing SAP HANA platform lifecycle management administration tasks on multiple-host systems without SSH or root credentials

#### *SAP documents*

- [System Replication Network Connection](#)
- [Host Name Resolution for System Replication](#)

### AWS references

- [Migrating SAP HANA from Other Platforms to AWS](#)

## Additional information

The changes performed by hdblcm as part of the hostname rename activity are consolidated in the following verbose log.

```
All server processes stopped on host 'temp-host' (worker).
  Stopping sapstartsrv service...
  Removing sapservices entry...
  Updating system configuration files...
  Renaming instance...
  Configuring environment scripts...
  Creating sapservices entry...
  Starting service (sapstartsrv)...
  Starting instance <SID> (HDB00) on host 'hdbhost'...
    Starting 7 processes on host 'hdbhost' (worker):
  .....
All server processes started on host 'hdbhost' (worker).
  Registering Instance Service...
  Updating Component List...
  Updating SAP HANA Database Instance Integration on Local Host...
  Regenerating SSL certificates...
  Deploying SAP Host Agent configurations...
SAP HANA Database System renamed
```



# Migrate SQL Server to AWS using distributed availability groups

Created by Praveen Marthala (AWS)

<b>Source:</b> SQL Server On-Premises	<b>Target:</b> SQL Server on EC2	<b>R Type:</b> Rehost
<b>Environment:</b> PoC or pilot	<b>Technologies:</b> Databases; Migration	<b>Workload:</b> Microsoft
<b>AWS services:</b> Amazon EC2		

## Summary

Microsoft SQL Server Always On availability groups provide a high availability (HA) and disaster recovery (DR) solution for SQL Server. An availability group consists of a primary replica that accepts read/write traffic, and up to eight secondary replicas that accept read traffic. An availability group is configured on a Windows Server Failover Cluster (WSFC) with two or more nodes.

Microsoft SQL Server Always On distributed availability groups provide a solution to configure two separate availability groups between two independent WSFCs. The availability groups that are part of the distributed availability group don't have to be in the same data center. One availability group can be on premises, and the other availability group can be on the Amazon Web Services (AWS) Cloud on Amazon Elastic Compute Cloud (Amazon EC2) instances in a different domain.

This pattern outlines steps for using a distributed availability group to migrate on-premises SQL Server databases that are part of an existing availability group to SQL Server with availability groups set up on Amazon EC2. By following this pattern, you can migrate the databases to the AWS Cloud with minimal downtime during cutover. The databases are highly available on AWS immediately after the cutover. You can also use this pattern to change the underlying operating system from on-premises to AWS while keeping the same version of SQL Server.

## Prerequisites and limitations

### Prerequisites

- An active AWS account
- AWS Direct Connect or AWS Site-to-Site VPN
- The same version of SQL Server installed on-premises and on the two nodes on AWS

### **Product versions**

- SQL Server version 2016 and later
- SQL Server Enterprise Edition

## **Architecture**

### **Source technology stack**

- Microsoft SQL Server database with Always On availability groups on premises

### **Target technology stack**

- Microsoft SQL Server database with Always On availability groups on Amazon EC2 on the AWS Cloud

### **Migration architecture**

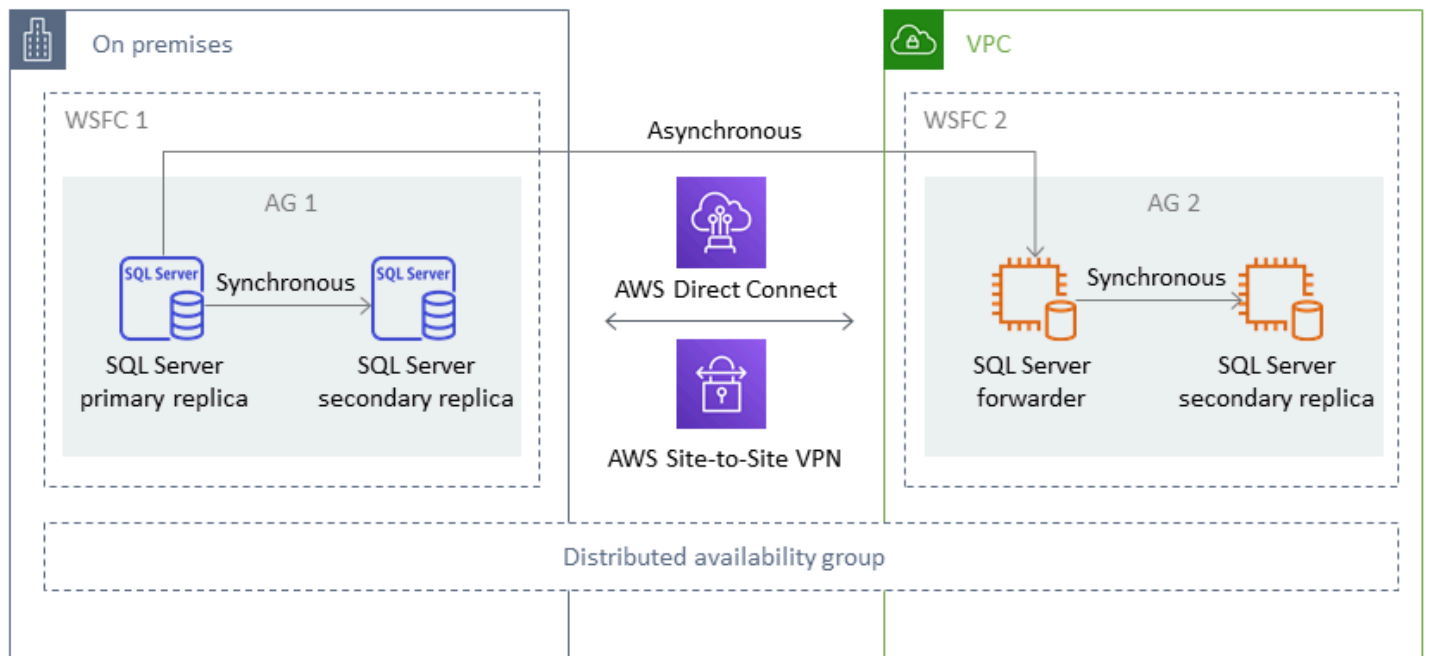

## Terminology

- WSFC 1 – WSFC on premises
- WSFC 2 – WSFC on the AWS Cloud
- AG 1 – First availability group, which is in WSFC 1
- AG 2 – Second availability group, which is in WSFC 2
- SQL Server primary replica – Node in AG 1 that is considered the global primary for all writes
- SQL Server forwarder – Node in AG 2 that receives data asynchronously from the SQL Server primary replica
- SQL Server secondary replica – Nodes in AG 1 or AG 2 that receive data synchronously from the primary replica or the forwarder

## Tools

- [AWS Direct Connect](#) – AWS Direct Connect links your internal network to an AWS Direct Connect location over a standard Ethernet fiber-optic cable. With this connection, you can create *virtual interfaces* directly to public AWS services, bypassing internet service providers in your network path.

- [Amazon EC2](#) – Amazon Elastic Compute Cloud (Amazon EC2) provides scalable computing capacity in the AWS Cloud. You can use Amazon EC2 to launch as many or as few virtual servers as you need, and you can scale out or scale in.
- [AWS Site-to-Site VPN](#) – AWS Site-to-Site VPN supports creating a site-to-site virtual private network (VPN). You can configure the VPN to pass traffic between instances that you launch on AWS and your own remote network.
- [Microsoft SQL Server Management Studio](#) – Microsoft SQL Server Management Studio (SSMS) is an integrated environment for managing SQL Server infrastructure. It provides a user interface and a group of tools with rich script editors that interact with SQL Server.

## Epics

### Set up a second availability group on AWS

Task	Description	Skills required
Create a WSFC on AWS.	Create WSFC 2 on Amazon EC2 instances with two nodes for HA. You will use this failover cluster to create the second availability group (AG 2) on AWS.	Systems administrator, SysOps administrator
Create the second availability group on WSFC 2.	Using SSMS, create AG 2 on two nodes in WSFC 2. The first node in WSFC 2 will act as the forwarder. The second node in WSFC 2 will act as the secondary replica of AG 2.  At this stage, no databases are available in AG 2. This is the starting point for setting up the distributed availability group.	DBA, Developer

Task	Description	Skills required
<p>Create databases with no recovery option on AG 2.</p>	<p>Back up databases on the on-premises availability group (AG 1).</p> <p>Restore the databases to both the forwarder and the secondary replica of AG 2 with no recovery option. While restoring the databases , specify a location with enough disk space for the database data files and the log files.</p> <p>At this stage, the databases are in the restoring state. They are not part of AG 2 or the distributed availability group, and they are not synchronizing.</p>	<p>DBA, Developer</p>

## Configure the distributed availability group

Task	Description	Skills required
<p>Create the distributed availability group on AG 1.</p>	<p>To create the distributed availability group on AG 1, use the <code>CREATE AVAILABILITY GROUP</code> with the <code>DISTRIBUTED</code> option.</p> <ol style="list-style-type: none"> <li>1. Use <code>LISTENER_URL</code> endpoint addresses for AG 1 and AG 2.</li> </ol>	<p>DBA, Developer</p>

Task	Description	Skills required
	<ol style="list-style-type: none"><li data-bbox="591 214 1032 533">2. For AVAILABILITY-MODE, use ASYNCHRONOUS_COMMIT to avoid network latency, if any. This will not impact the performance of the database.</li><li data-bbox="591 558 1032 785">3. For FAILOVER_MODE , use MANUAL. It is the only availability mode that works with distributed availability groups.</li><li data-bbox="591 810 1032 1037">4. To restore the databases manually on AG 2 and have more control on larger databases, use MANUAL for SEEDING_MODE .</li></ol>	

Task	Description	Skills required
Create the distributed availability group on AG 2.	<p>To create the distributed availability group on AG 2, use ALTER AVAILABILITY GROUP with the DISTRIBUTED option.</p> <ol style="list-style-type: none"><li>1. Use LISTENER_URL endpoint addresses for AG 1 and AG 2.</li><li>2. For AVAILABILITY-MODE, use ASYNCHRONOUS_COMMIT to avoid network latency, if any. This will not impact the performance of the database.</li><li>3. For FAILOVER_MODE , use MANUAL. It is the only availability mode that works with distributed availability groups.</li><li>4. To restore the databases manually on AG 2 and have more control on larger databases, use MANUAL for SEEDING_MODE .</li></ol> <p>The distributed availability group is created between AG 1 and AG 2.</p> <p>The databases in AG 2 are not yet configured to take part in</p>	DBA, Developer

Task	Description	Skills required
	the data flow from AG 1 to AG 2.	
Add databases to the forwarder and secondary replica on AG 2.	<p>Add the databases to the distributed availability group by using ALTER DATABASE with the SET HADR AVAILABILITY GROUP option in both the forwarder and the secondary replica on AG 2.</p> <p>This starts asynchronous data flow between databases on AG 1 and AG 2.</p> <p>The global primary takes writes, sends data synchronously to the secondary replica on AG 1, and sends data asynchronously to the forwarder on AG 2. The forwarder on AG 2 sends data synchronously to the secondary replica on AG 2.</p>	DBA, Developer

### Monitor asynchronous data flow between AG 1 and AG 2

Task	Description	Skills required
Use DMVs and SQL Server logs.	Monitor the status of the data flow between two availability groups by using dynamic management views (DMVs) and SQL Server logs.	DBA, Developer



Task	Description	Skills required
	<p>DMVs that are of interest for monitoring include <code>sys.dm_hadr_availability_replica_states</code> and <code>sys.dm_hadr_automatic_seeding</code> .</p> <p>For the status of forwarder synchronization, monitor the <i>synchronized state</i> in the SQL Server log on the forwarder.</p>	

### Perform cutover activities for final migration

Task	Description	Skills required
Stop all traffic to the primary replica.	Stop incoming traffic to the primary replica in AG 1 so that no write activity occurs on the databases and the databases are ready for migration.	App owner, Developer
Change the availability mode of the distributed availability group on AG 1.	<p>On the primary replica, set the availability mode of the distributed availability group to synchronous.</p> <p>After you change the availability mode to synchronous, the data are sent synchronously from the primary replica in AG 1 to the forwarder in AG 2.</p>	DBA, Developer

Task	Description	Skills required
Check the LSNs in both availability groups.	Check the last Log Sequence Numbers (LSNs) in both AG 1 and AG 2. Because no writes are happening in the primary replica in AG 1, the data are synchronized, and last LSNs for both availability groups should match.	DBA, Developer
Update AG 1 to the secondary role.	When you update AG 1 to the secondary role, AG 1 loses the primary replica role and doesn't accept writes, and the data flow between two availability groups stops.	DBA, Developer

### Fail over to the second availability group

Task	Description	Skills required
Manually fail over to AG 2.	<p>On the forwarder in AG 2, alter the distributed availability group to allow data loss. Because you already checked and confirmed that the last LSNs on AG 1 and AG 2 match, data loss is not a concern.</p> <p>When you allow data loss on the forwarder in AG 2, the roles of AG 1 and AG 2 change:</p>	DBA, Developer

Task	Description	Skills required
	<ul style="list-style-type: none"> <li>AG 2 becomes the availability group with the primary replica and secondary replica.</li> <li>AG 1 becomes the availability group with the forwarder and secondary replica.</li> </ul>	
<p>Change the availability mode of the distributed availability group on AG 2.</p>	<p>On the primary replica in AG 2, change the availability mode to asynchronous.</p> <p>This changes the data movement from AG 2 to AG 1, from synchronous to asynchronous. This step is required to avoid network latency between AG 2 and AG 1, if any, and will not impact the performance of the database.</p>	<p>DBA, Developer</p>
<p>Start sending traffic to the new primary replica.</p>	<p>Update the connection string to use the listener URL endpoint on AG 2 for sending traffic to the databases.</p> <p>AG 2 now accepts writes and sends data to the forwarder in AG 1, along with sending data to its own secondary replica in AG 2. Data moves asynchronously from AG 2 to AG 1.</p>	<p>App owner, Developer</p>

## Perform post-cutover activities

Task	Description	Skills required
Drop the distributed availability group on AG 2.	<p>Monitor the migration for the planned amount of time. Then drop the distributed availability group on AG 2 to remove distributed availability group setup between AG 2 and AG 1. This removes the distributed availability group configuration, and data flow from AG 2 to AG 1 stops.</p> <p>At this point, AG 2 is highly available on AWS, with a primary replica that takes writes and a secondary replica in the same availability group.</p>	DBA, Developer
Decommission the on-premises servers.	Decommission the on-premises servers in WSFC 1 that are part of AG 1.	Systems administrator, SysOps administrator

## Related resources

- [Distributed availability groups](#)
- [SQL Docs: Distributed availability groups](#)
- [SQL Docs: Always On availability groups: a high-availability and disaster-recovery solution](#)

# Migrate from Oracle 8i or 9i to Amazon RDS for Oracle using SharePlex and AWS DMS

Created by Ramu Jagini (AWS)

<b>Environment:</b> PoC or pilot	<b>Source:</b> Databases: Relational	<b>Target:</b> Amazon RDS
<b>R Type:</b> Replatform	<b>Workload:</b> Open-source; Oracle	<b>Technologies:</b> Databases; Migration
<b>AWS services:</b> AWS DMS; Amazon RDS		

## Summary

This pattern describes how to migrate an on-premises Oracle 8i or 9i database to an Amazon Relational Database Service (Amazon RDS) for Oracle database. You can use this pattern to complete your migration with reduced downtime by using Quest SharePlex for synchronous replication.

You must use an intermediate Oracle database instance for your migration because AWS Database Migration Service (AWS DMS) doesn't support Oracle 8i or 9i as a source environment. You can use [SharePlex 7.6.3](#) to replicate from previous Oracle database versions to later Oracle database versions. The intermediate Oracle database instance is compatible as a target for SharePlex 7.6.3 and supported as a source for AWS DMS or newer releases of SharePlex. This support enables onward replication of data to the Amazon RDS for Oracle target environment.

Consider that several deprecated data types and features can impact a migration from Oracle 8i or 9i to the latest version of Oracle Database. To mitigate this impact, this pattern uses Oracle 11.2.0.4 as an intermediate database version to help optimize the schema code prior to migrating to the Amazon RDS for Oracle target environment.

## Prerequisites and limitations

### Prerequisites

- An active AWS account

- A source Oracle 8i or 9i database in an on-premises environment
- [Oracle Database 12c Release 2 \(12CR2\)](#) for staging on Amazon Elastic Compute Cloud (Amazon EC2)
- Quest SharePlex 7.6.3 (commercial grade)

## Limitations

- [RDS for Oracle limitations](#)

## Product versions

- Oracle 8i or 9i for the source database
- Oracle 12CR2 for the staging database (must match the Amazon RDS for Oracle version)
- Oracle 12CR2 or later for the target database (Amazon RDS for Oracle)

## Architecture

### Source technology stack

- Oracle 8i or 9i database
- SharePlex

### Target technology stack

- Amazon RDS for Oracle

### Migration architecture

The following diagram shows how to migrate an Oracle 8i or 9i database from an on-premises environment to an Amazon RDS for Oracle DB instance in the AWS Cloud.

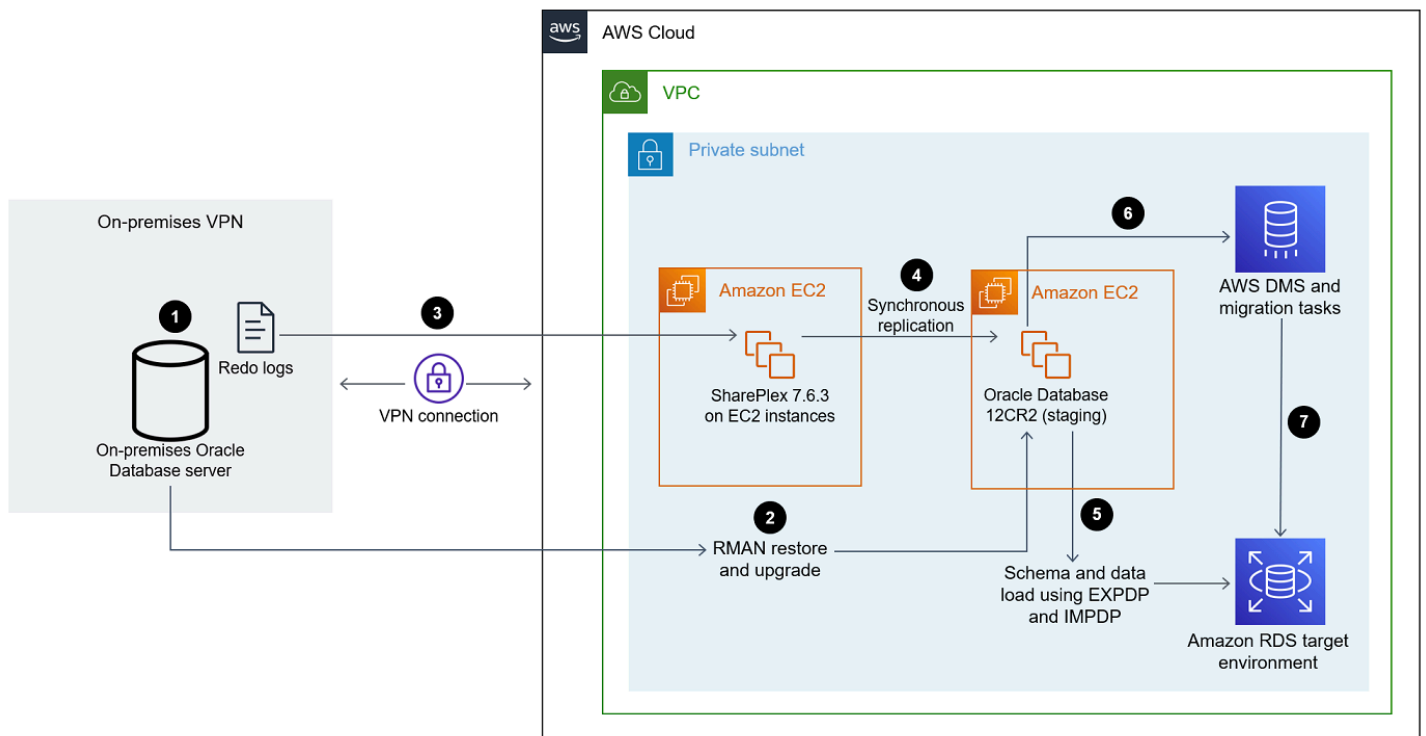

The diagram shows the following workflow:

1. Enable the Oracle source database with archive log mode, force logging, and supplemental logging.
2. Restore the Oracle staging database from the Oracle source database by using Recovery Manager (RMAN) point-in-time recovery and [FLASHBACK\\_SCN](#).
3. Configure SharePlex to read redo logs from the Oracle source database by using [FLASHBACK\\_SCN](#) (used in RMAN).
4. Start SharePlex replication to synchronize data from the Oracle source database to the Oracle staging database.
5. Restore the Amazon RDS for Oracle target database by using EXPDP and IMPDP with [FLASHBACK\\_SCN](#).
6. Configure AWS DMS and its source tasks as the Oracle staging database and Amazon RDS for Oracle as the target database by using [FLASHBACK\\_SCN](#) (used in EXPDP).
7. Start AWS DMS tasks to synchronize data from the Oracle staging database to the Oracle target database.

## Tools

- [Amazon Relational Database Service \(Amazon RDS\)](#) helps you set up, operate, and scale a relational database in the AWS Cloud.
- [AWS Database Migration Service \(AWS DMS\)](#) helps you migrate data stores into the AWS Cloud or between combinations of cloud and on-premises setups.
- [Quest SharePlex](#) is an Oracle-to-Oracle data replication tool for moving data with minimal downtime and no data loss.
- [Recovery Manager \(RMAN\)](#) is an Oracle Database client that performs backup and recovery tasks on your databases. It greatly simplifies backing up, restoring, and recovering database files.
- [Data Pump Export](#) helps you upload data and metadata into a set of operating system files called a dump file set. The dump file set can be imported only by the [Data Pump Import](#) utility or [DBMS\\_DATAPUMP](#) package.

## Epics

### Set up SharePlex and the Oracle staging database on Amazon EC2

Task	Description	Skills required
Create an EC2 instance.	<ol style="list-style-type: none"> <li>1. <a href="#">Create an EC2 instance</a>.</li> <li>2. Install Oracle 12CR2 on the EC2 instance to serve as the Oracle staging database.</li> </ol>	Oracle administration
Prepare the staging database.	<p>Prepare the Oracle staging database for restore as an upgrade on Oracle 12CR2 by taking the RMAN backup from the Oracle 8i or 9i database source environment.</p> <p>For more information, see <a href="#">Oracle 9i Recovery Manager User's Guide</a> and <a href="#">Database</a></p>	Oracle administration



Task	Description	Skills required
	<a href="#">Backup and Recovery User's Guide</a> in the Oracle documentation.	
Configure SharePlex.	Configure the SharePlex source as an on-premises Oracle 8i or 9i database, and configure the target as the Oracle 12CR2 staging database hosted on Amazon EC2.	SharePlex, Oracle administration

### Set up Amazon RDS for Oracle as your target environment

Task	Description	Skills required
Create an Oracle DB instance.	<p>Create an Amazon RDS for Oracle database, and then connect Oracle 12CR2 to the database.</p> <p>For more information, see <a href="#">Creating an Oracle DB instance and connecting to a database on an Oracle DB instance</a> in the Amazon RDS documentation.</p>	DBA
Restore Amazon RDS for Oracle from the staging database.	<ol style="list-style-type: none"> <li>1. Take an EXPDP backup from the Oracle staging database server by using FLASHBACK_SCN .</li> <li>2. Restore Amazon RDS for Oracle from the staging database.</li> </ol>	DBA

Task	Description	Skills required
	For more information, see <a href="#">54 DBMS_DATAPUMP</a> in the Oracle documentation.	

## Set up AWS DMS

Task	Description	Skills required
Create endpoints for the databases.	<p>Create a source endpoint for the Oracle staging database and a target endpoint for the Amazon RDS for Oracle database.</p> <p>For more information, see <a href="#">How do I create source or target endpoints using AWS DMS?</a> in the AWS Knowledge Center.</p>	DBA
Create a replication instance.	<p>Use AWS DMS to launch a replication instance for the Oracle staging database to the Amazon RDS for Oracle database.</p> <p>For more information, see <a href="#">How do I create an AWS DMS replication instance?</a> in the AWS Knowledge Center.</p>	DBA
Create and start replication tasks.	Create AWS DMS replication tasks for change data capture (CDC) by using FLASHBACK_SCN from EXPDP (since the	DBA

Task	Description	Skills required
	<p>full load already happened through EXPDP).</p> <p>For more information, see <a href="#">Creating a task</a> in the AWS DMS documentation.</p>	

## Cut over to Amazon RDS for Oracle

Task	Description	Skills required
Stop the application workload.	Stop the application servers and its applications during the planned cutover window.	App developer, DBA
Validate the synching of the on-premises Oracle staging database with the EC2 instance.	<p>Confirm that all messages have been posted for replication tasks from the SharePlex replication instance to the Oracle staging database on Amazon EC2 by performing a few log switches on the on-premises source database.</p> <p>For more information, see <a href="#">6.4.2 Switching a Log File</a> in the Oracle documentation.</p>	DBA
Validate the synching of the Oracle staging database with the Amazon RDS for Oracle database.	Confirm that all your AWS DMS tasks have no lag and no errors, and then check the validation state of the tasks.	DBA
Stop the replication of SharePlex and Amazon RDS.	If both the SharePlex and AWS DMS replications are not	DBA

Task	Description	Skills required
	showing any errors, then stop both replications.	
Remap the application to Amazon RDS.	Share the Amazon RDS for Oracle endpoint details with the application server and its applications, and then start the application to resume business operations.	App developer, DBA

### Test the AWS target environment

Task	Description	Skills required
Test the Oracle staging database environment on AWS.	<ol style="list-style-type: none"> <li>1. Test the SharePlex replication and verify that there are no sync gaps or replication errors on the Oracle staging database.</li> <li>2. Verify that the application behaves as expected through benchmarks defined in the on-premises environment.</li> </ol>	SharePlex, Oracle administration
Test the Amazon RDS environment.	<ol style="list-style-type: none"> <li>1. Verify that all data propagated to Amazon RDS after replication is error free.</li> <li>2. Point another application to the Amazon RDS DB instance, and then run performance tests to verify expected behavior.</li> </ol>	Oracle administration

Task	Description	Skills required
	For more information, see <a href="#">Amazon RDS for Oracle</a> in the Amazon RDS documentation.	

## Related resources

- [Migrate with confidence](#)
- [Amazon EC2](#)
- [Amazon RDS for Oracle](#)
- [AWS Database Migration Service](#)
- [Debugging Your AWS DMS Migrations: What to Do When Things Go Wrong \(Part 1\)](#)
- [Debugging Your AWS DMS Migrations: What to Do When Things Go Wrong \(Part 2\)](#)
- [Debugging Your AWS DMS Migrations: What to Do When Things Go Wrong? \(Part 3\)](#)
- [SharePlex for Database Replication](#)
- [SharePlex: database replication for any environment](#)

# Monitor Amazon Aurora for instances without encryption

Created by Mansi Suratwala (AWS)

**Environment:** Production

**Technologies:** Databases;  
Security, identity, compliance;  
Storage & backup

**Workload:** Open-source; All  
other workloads

**AWS services:** Amazon  
SNS; Amazon Aurora;  
AWS CloudTrail; Amazon  
CloudWatch; AWS Lambda

## Summary

This pattern provides an Amazon Web Services (AWS) CloudFormation template that you can deploy to set up automatic notifications when an Amazon Aurora instance is created without encryption turned on.

Aurora is a fully managed relational database engine that's compatible with MySQL and PostgreSQL. With some workloads, Aurora can deliver up to five times the throughput of MySQL and up to three times the throughput of PostgreSQL without requiring changes to most of your existing applications.

The CloudFormation template creates an Amazon CloudWatch Events event and an AWS Lambda function. The event uses AWS CloudTrail to monitor for any Aurora instance creation or a point in time restoration of an existing instance. The Cloudwatch Events event initiates the Lambda function, which checks whether encryption is enabled. If encryption is not turned on, the Lambda function sends an Amazon Simple Notification Service (Amazon SNS) notification informing you of the violation.

## Prerequisites and limitations

### Prerequisites

- An active AWS account

## Limitations

- This service control works with Amazon Aurora instances only. It does not support other Amazon Relational Database Service (Amazon RDS) instances.
- The CloudFormation template must be deployed for `CreateDBInstance` and `RestoreDBClusterToPointInTime` only.

## Product versions

- PostgreSQL versions that are supported in Amazon Aurora
- MySQL versions that are supported in Amazon Aurora

## Architecture

### Target technology stack

- Amazon Aurora
- AWS CloudTrail
- Amazon CloudWatch
- AWS Lambda
- Amazon Simple Storage Service (Amazon S3)
- Amazon SNS

### Target architecture

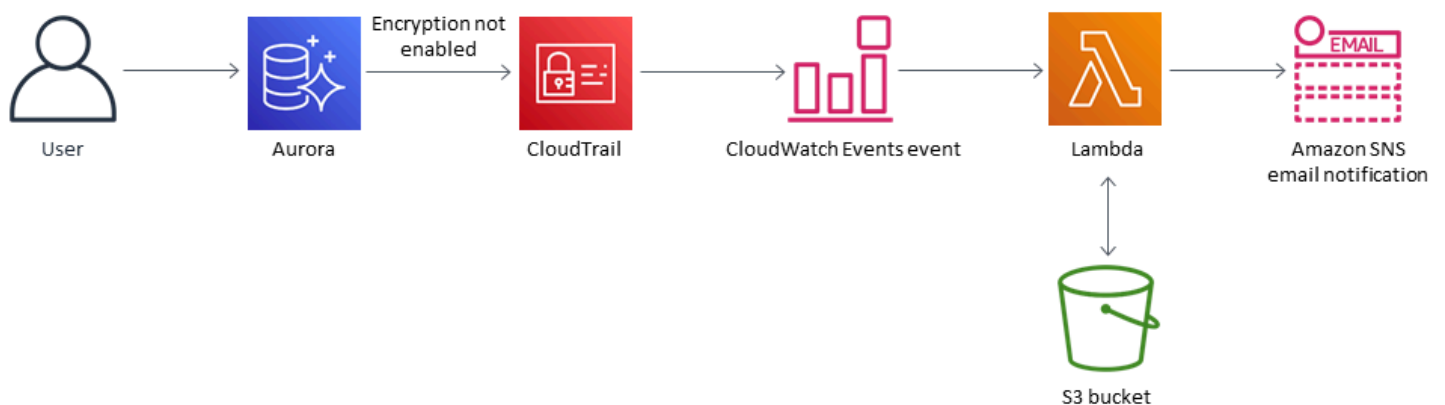

## Automation and scale

You can use the CloudFormation template multiple times for different Regions and accounts. You need to run it only once in each Region or account.

## Tools

### Tools

- [Amazon Aurora](#) – Amazon Aurora is a fully managed relational database engine that's compatible with MySQL and PostgreSQL.
- [AWS CloudTrail](#) – AWS CloudTrail helps you manage governance, compliance, and operational and risk auditing of your AWS account. Actions taken by a user, a role, or an AWS service are recorded as events in CloudTrail.
- [Amazon CloudWatch Events](#) – Amazon CloudWatch Events delivers a near-real-time stream of system events that describe changes in AWS resources.
- [AWS Lambda](#) – AWS Lambda is a compute service that supports running code without provisioning or managing servers. Lambda runs your code only when needed and scales automatically, from a few requests per day to thousands per second.
- [Amazon S3](#) – Amazon Simple Storage Service (Amazon S3) is a highly scalable object storage service that you can use for a wide range of storage solutions, including websites, mobile applications, backups, and data lakes.
- [Amazon SNS](#) – Amazon Simple Notification Service (Amazon SNS) is a managed service that provides message delivery using Lambda, HTTP, email, mobile push notifications, and mobile text messages (SMS).

### Code

A .zip file of the project is available as an attachment.

## Epics

### Create the S3 bucket for the Lambda script

Task	Description	Skills required
Define the S3 bucket.	Open the Amazon S3 console, and choose or create an S3	Cloud architect



Task	Description	Skills required
	bucket. This S3 bucket will host the Lambda code .zip file. Your S3 bucket needs to be in the same Region as Aurora. The S3 bucket name cannot contain leading slashes.	

### Upload the Lambda code to the S3 bucket

Task	Description	Skills required
Upload the Lambda code.	Upload the Lambda code .zip file provided in the <i>Attachments</i> section to the S3 bucket that you defined.	Cloud architect

### Deploy the CloudFormation template

Task	Description	Skills required
Deploy the CloudFormation template.	On the CloudFormation console, deploy the <code>RDS_Aurora_Encryption_At_Rest.yml</code> CloudFormation template that's provided as an attachment to this pattern. In the next epic, provide values for the template parameters.	Cloud architect

## Complete the parameters in the CloudFormation template

Task	Description	Skills required
Provide the S3 bucket name.	Enter the name of the S3 bucket that you created or chose in the first epic.	Cloud architect
Provide the S3 key.	Provide the location of the Lambda code .zip file in your S3 bucket, without leading slashes (for example, <directory>/<file-name>.zip ).	Cloud architect
Provide an email address.	Provide an active email address to receive Amazon SNS notifications.	Cloud architect
Define the logging level.	Define the logging level and frequency for your Lambda function. Info designates detailed informational messages on the application's progress. Error designates error events that could still allow the application to continue running. Warning designates potentially harmful situations.	Cloud architect

## Confirm the subscription

Task	Description	Skills required
Confirm the subscription.	When the template successfully deploys, it sends a	Cloud architect

Task	Description	Skills required
	subscription email message to the email address provided. To receive notifications, you must confirm this email subscription.	

## Related resources

- [Creating an S3 bucket](#)
- [Uploading files to an S3 bucket](#)
- [Creating an Amazon Aurora DB cluster](#)
- [Creating a CloudWatch Events rule that triggers on an AWS API call using AWS CloudTrail](#)

## Attachments

To access additional content that is associated with this document, unzip the following file: [attachment.zip](#)

# Monitor Oracle GoldenGate logs by using Amazon CloudWatch

Created by Chithra Krishnamurthy (AWS)

**Environment:** Production

**Technologies:** Databases

**Workload:** Oracle

**AWS services:** Amazon CloudWatch; Amazon SNS

## Summary

Oracle GoldenGate provides real-time replication between Amazon Relational Database Service (Amazon RDS) for Oracle databases, or between Oracle databases hosted on Amazon Elastic Compute Cloud (Amazon EC2). It supports both unidirectional and bidirectional replication.

When you use GoldenGate for replication, monitoring is critical to verify that the GoldenGate process is up and running, to make sure that the source and target databases are in sync.

This pattern explains the steps to implement Amazon CloudWatch monitoring for a GoldenGate error log, and how to set alarms to send notifications for specific events such as STOP or ABEND so you can take appropriate actions to resume replication quickly.

## Prerequisites and limitations

### Prerequisites

- GoldenGate installed and configured on an EC2 instance, so you can set up CloudWatch monitoring on those EC2 instances. If you want to monitor GoldenGate across AWS Regions for bidirectional replication, you must install the CloudWatch agent in each EC2 instance where the GoldenGate process is running.

### Limitations

- This pattern explains how to monitor the GoldenGate process by using CloudWatch. CloudWatch doesn't monitor replication lag or data synchronization issues during replication. You must run separate SQL queries to monitor replication lag or data-related errors, as explained in the [GoldenGate documentation](#).

## Product versions

- This document is based on the implementation of Oracle GoldenGate 19.1.0.0.4 for Oracle on Linux x86-64. However, this solution is applicable to all major versions of GoldenGate.

## Architecture

### Target technology stack

- GoldenGate binaries for Oracle installed on an EC2 instance
- Amazon CloudWatch
- Amazon Simple Notification Service (Amazon SNS)

### Target architecture

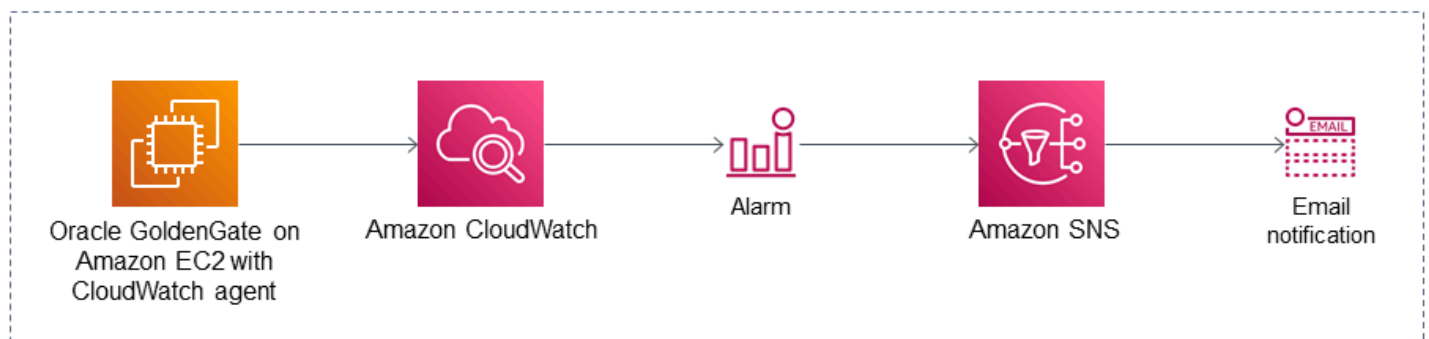

## Tools

### AWS services

- [Amazon CloudWatch](#) is a monitoring service that is used in this pattern to monitor GoldenGate error logs.
- [Amazon SNS](#) is a message notification service that is used in this pattern to send email notifications.

### Other tools

- [Oracle GoldenGate](#) is a data replication tool that you can use for Amazon RDS for Oracle databases or Oracle databases that are hosted on Amazon EC2.

## High-level implementation steps

1. Create an AWS Identity and Access Management (IAM) role for the CloudWatch agent.
2. Attach the IAM role to the EC2 instance where GoldenGate error logs are generated.
3. Install the CloudWatch agent on the EC2 instance.
4. Configure the CloudWatch agent configuration files: `awscli.conf` and `awslogs.conf`.
5. Start the CloudWatch agent.
6. Create metric filters in the log group.
7. Set up Amazon SNS.
8. Create an alarm for the metric filters. Amazon SNS sends email alerts when those filters capture events.

For detailed instructions, see the next section.

## Epics

### Step 1. Create an IAM role for the CloudWatch agent

Task	Description	Skills required
Create the IAM role.	<p>Access to AWS resources requires permissions, so you create IAM roles to include the permissions necessary for each server to run the CloudWatch agent.</p> <p>To create the IAM role:</p> <ol style="list-style-type: none"><li>1. Sign in to the AWS Management Console and open the IAM console at <a href="https://console.aws.amazon.com/iam/">https://console.aws.amazon.com/iam/</a>.</li></ol>	AWS general

Task	Description	Skills required
	<ol style="list-style-type: none"><li>2. In the navigation pane, choose <b>Roles</b>, and then choose <b>Create role</b>.</li><li>3. For <b>Trusted entity type</b>, choose <b>AWS service</b>.</li><li>4. For <b>Common use cases</b>, choose <b>EC2</b>, and then choose <b>Next</b>.</li><li>5. In the list of policies, select the check box next to <b>CloudWatchAgentServerPolicy</b>. If necessary, use the search box to find the policy.</li><li>6. Choose <b>Next</b>.</li><li>7. For <b>Role name</b>, enter a name for your new role, such as <code>goldengate-cw-monitoring-role</code> or another name that you prefer.</li><li>8. (Optional) For <b>Role description</b>, enter a description.</li><li>9. Confirm that <b>CloudWatchAgentServerPolicy</b> appears under <b>Policy name</b>.</li><li>10. (Optional) Add one or more tags (key-value pairs) to organize, track, or control access for this role, and then choose <b>Create role</b>.</li></ol>	

## Step 2. Attach the IAM role to the GoldenGate EC2 instance

Task	Description	Skills required
Attach the IAM role to the EC2 instance where GoldenGate error logs are generated.	<p>The error logs generated by GoldenGate have to be populated to CloudWatch and monitored, so you need to attach the IAM role you created in step 1 to the EC2 instance where GoldenGate is running.</p> <p>To attach an IAM role to an instance:</p> <ol style="list-style-type: none"><li>1. Open the Amazon EC2 console at <a href="https://console.aws.amazon.com/ec2/">https://console.aws.amazon.com/ec2/</a>.</li><li>2. In the navigation pane, choose <b>Instances</b>, and then find the instance where GoldenGate is running.</li><li>3. Select the instance, and then choose <b>Actions, Security, Modify IAM role</b>.</li><li>4. Select the IAM role created in the first step to attach to your instance, and then choose <b>Save</b>.</li></ol>	AWS general



## Steps 3-5. Install and configure the CloudWatch agent on the Goldengate EC2 instance

Task	Description	Skills required
Install the CloudWatch agent on the GoldenGate EC2 instance.	To install the agent, run the command: <pre data-bbox="594 453 1027 569">sudo yum install -y awslogs</pre>	AWS general
Edit the agent configuration files.	<ol style="list-style-type: none"> <li>Run the following command.             <pre data-bbox="634 730 1027 810">sudo su -</pre> </li> <li>Edit this file to update the AWS Region as necessary.             <pre data-bbox="634 947 1027 1178">cat /etc/awslogs/conf [plugins] cwlogs = cwlogs [default] region = us-east-1</pre> </li> <li>Edit the <code>/etc/awslogs/awslogs.conf</code> file to update the file name, log group name, and the date/time format. You must specify the date/time to match the date format in <code>ggseerror.log</code>; otherwise, the log stream won't flow into CloudWatch. For example:             <pre data-bbox="634 1755 1027 1843">datetime_format = %Y- %m-%dT%H:%M:%S%z</pre> </li> </ol>	AWS general

Task	Description	Skills required
	<pre>file = /u03/oracle/ oragg/ggserr.log log_group_name = goldengate_monitor</pre>	
Start the CloudWatch agent.	<p>To start the agent, use the following command.</p> <pre>\$ sudo service awslogsd start</pre> <p>After you start the agent, you can view the log group in the CloudWatch console. The log stream will have the contents of the file.</p>	AWS general

## Step 6. Create metric filters for the log group

Task	Description	Skills required
Create metric filters for the keywords ABEND and STOPPED.	<p>When you create metric filters for the log group, whenever the filters are identified in the error log, it starts an alarm and sends an email notification based on the Amazon SNS configuration.</p> <p>To create metric filters:</p> <ol style="list-style-type: none"> <li>1. Open the CloudWatch console at <a href="https://console.aws.amazon.com/cloudwatch/">https://console.aws.amazon.com/cloudwatch/</a>.</li> </ol>	CloudWatch

Task	Description	Skills required
	<ol style="list-style-type: none"><li>2. Choose the name of the log group.</li><li>3. Choose <b>Actions</b>, and then choose <b>Create metric filter</b>.</li><li>4. For the <b>Filter pattern</b>, specify a pattern such as ABEND.</li><li>5. Choose <b>Next</b>, and then enter a name for your metric filter.</li><li>6. Under <b>Metric details</b>, for <b>Metric namespace</b>, enter a name for the CloudWatch namespace where the metric will be published. If the namespace doesn't already exist, make sure that <b>Create new</b> is selected.</li><li>7. For <b>Metric value</b>, enter 1, because your metric filter is counting occurrences of the keywords in the filter.</li><li>8. Set <b>Unit</b> to <b>None</b>.</li><li>9. Choose <b>Create metric filter</b>. You can find the metric filter that you created from the navigation pane.</li><li>10. Create another metric filter for the STOPPED pattern. Within one log group, you</li></ol>	

Task	Description	Skills required
	can create multiple metric filters and set alarms individually.	

## Step 7. Set up Amazon SNS

Task	Description	Skills required
Create an SNS topic.	<p>In this step, you configure Amazon SNS to create alarms for the metric filters.</p> <p>To create an SNS topic:</p> <ol style="list-style-type: none"> <li>1. Sign in to the Amazon SNS console at <a href="https://console.aws.amazon.com/sns/home">https://console.aws.amazon.com/sns/home</a>.</li> <li>2. In the <b>Create topic</b> box, enter a topic name such as <code>goldengate-alert</code> , and then choose <b>Next step</b>.</li> <li>3. For <b>Type</b>, choose <b>Standard</b>.</li> <li>4. Scroll to the end of the form and choose <b>Create topic</b>. The console opens the new topic's <b>Details</b> page.</li> </ol>	Amazon SNS
Create a subscription.	<p>To create a subscription to the topic:</p> <ol style="list-style-type: none"> <li>1. In the left navigation pane, choose <b>Subscriptions</b>.</li> </ol>	Amazon SNS

Task	Description	Skills required
	<ol style="list-style-type: none"><li>2. On the <b>Subscriptions</b> page, choose <b>Create subscription</b>.</li><li>3. On the <b>Create subscription</b> page, choose the <b>Topic ARN</b> field to see a list of the topics in your AWS account.</li><li>4. Choose the topic that you created in the previous step.</li><li>5. For <b>Protocol</b>, choose <b>Email</b>.</li><li>6. For <b>Endpoint</b>, enter an email address that can receive notifications.</li><li>7. Choose <b>Create subscription</b>. The console opens the new subscription's <b>Details</b> page.</li><li>8. Check your email inbox for a message from AWS Notifications, and then choose <b>Confirm subscription</b> in the email.</li></ol> <p>Amazon SNS opens your web browser and displays a subscription confirmation with your subscription ID.</p>	

## Step 8. Create an alarm to send notifications for the metric filters

Task	Description	Skills required
Create an alarm for the SNS topic.	<p>To create an alarm based on a log group-metric filter:</p> <ol style="list-style-type: none"><li>1. Open the CloudWatch console at <a href="https://console.aws.amazon.com/cloudwatch/">https://console.aws.amazon.com/cloudwatch/</a>.</li><li>2. From the navigation pane, choose <b>Logs</b>, and then choose <b>Log groups</b>.</li><li>3. Choose the log group that includes your metric filter.</li><li>4. Choose <b>Metric filters</b>.</li><li>5. In the <b>Metric filters</b> tab, select the check box for the metric filter that you want to base your alarm on.</li><li>6. Choose <b>Create alarm</b>.</li><li>7. For <b>Conditions</b>, specify the following in each section:<ul style="list-style-type: none"><li>• For <b>Threshold type</b>, choose <b>Static</b>.</li><li>• For <b>Whenever &lt;metric-name&gt; is . . .</b>, choose <b>Greater</b>.</li><li>• For <b>than . . .</b>, specify <b>0</b>.</li></ul></li><li>8. Choose <b>Next</b>.</li><li>9. Under <b>Notification</b>:<ul style="list-style-type: none"><li>• For <b>Alarm state trigger</b>, choose <b>In alarm</b>.</li></ul></li></ol>	CloudWatch

Task	Description	Skills required
	<ul style="list-style-type: none"> <li>• For <b>Send notification to following SNS topic</b>, choose <b>Select an existing topic</b>.</li> <li>• In the email box, select the Amazon SNS topic that you created in the previous step.</li> </ul> <p>10Choose <b>Next</b>.</p> <p>11For <b>Name and description</b>, enter a name and description for your alarm.</p> <p><b>Note:</b> For the description, you can specify the instance name so that the notification email is descriptive.</p> <p>12For <b>Preview and create</b>, check that your configuration is correct, and then choose <b>Create alarm</b>.</p> <p>After these steps, whenever these patterns are detected in the GoldenGate error log file (<code>ggseerr.log</code>) that you are monitoring, you will get an email notification.</p>	

## Troubleshooting

Issue	Solution
The log stream from the GoldenGate error log doesn't flow into CloudWatch.	Check the <code>/etc/awlogs/awlogs.conf</code> file to verify the file name, log group name, and the date/time format. You must specify the date/time to match the date format in <code>ggerror.log</code> . Otherwise, the log stream won't flow into CloudWatch.

### Related resources

- [Amazon CloudWatch documentation](#)
- [Collecting metrics and logs with the CloudWatch agent](#)
- [Amazon SNS documentation](#)



# Replatform Oracle Database Enterprise Edition to Standard Edition 2 on Amazon RDS for Oracle

Created by Lanre (Lan-Ray) showunmi (AWS) and Tarun Chawla (AWS)

<b>Environment:</b> Production	<b>Source:</b> on-premises	<b>Target:</b> Amazon RDS
<b>R Type:</b> Replatform	<b>Workload:</b> Oracle	<b>Technologies:</b> Databases
<b>AWS services:</b> Amazon RDS		

## Summary

Oracle Database Enterprise Edition (EE) is a popular choice for running applications in many enterprises. In some cases, however, applications use few or no Oracle Database EE features, so there is a lack of justification for incurring huge licensing costs. You can achieve cost savings by downgrading such databases to Oracle Database Standard Edition 2 (SE2) when you migrate to Amazon RDS.

This pattern describes how to downgrade from Oracle Database EE to Oracle Database SE2 when migrating from on premises to [Amazon RDS for Oracle](#). The steps presented in this pattern also apply if your EE Oracle database is already running on Amazon RDS or on an [Amazon Elastic Compute Cloud](#) (Amazon EC2) instance.

For more information, see the AWS Prescriptive Guidance guide on how to [Evaluate downgrading Oracle databases to Standard Edition 2 on AWS](#).

## Prerequisites and limitations

### Prerequisites

- An active AWS account
- Oracle Database Enterprise Edition
- A client tool, such as [Oracle SQL Developer](#) or SQL\*Plus, for connecting to and running SQL commands on Oracle database

- Database user for performing the assessment; for example, one of the following:
  - User with sufficient [privileges](#) for running [AWS Schema Conversion Tool \(AWS SCT\)](#) assessment
  - User with sufficient privileges to run SQL queries on Oracle database dictionary tables
- Database user for performing database migration; for example, one of the following:
  - User with sufficient [privileges](#) for running [AWS Database Migration Service \(AWS DMS\)](#)
  - User with sufficient [privileges for performing Oracle Data Pump export and import](#)
  - User with sufficient [privileges for running Oracle GoldenGate](#)

## Limitations

- Amazon RDS for Oracle has a maximum database size. For more information, see [Amazon RDS DB instance storage](#).

## Product versions

The general logic described in this document applies to Oracle versions from 9i and later. For supported versions of self-managed and Amazon RDS for Oracle databases, see the [AWS DMS documentation](#).

To identify feature usage in cases where AWS SCT is not supported, run SQL queries on the source database. To migrate from earlier versions of Oracle where AWS DMS and Oracle Data Pump are not supported, use [Oracle Export and Import utilities](#).

For a current list of supported versions and editions, see [Oracle on Amazon RDS](#) in the AWS documentation. For details on pricing and supported instance classes, see [Amazon RDS for Oracle pricing](#).

## Architecture

### Source technology stack

- Oracle Database Enterprise Edition running on premises or on Amazon EC2

### Target technology stack using native Oracle tools

- Amazon RDS for Oracle running Oracle Database SE2

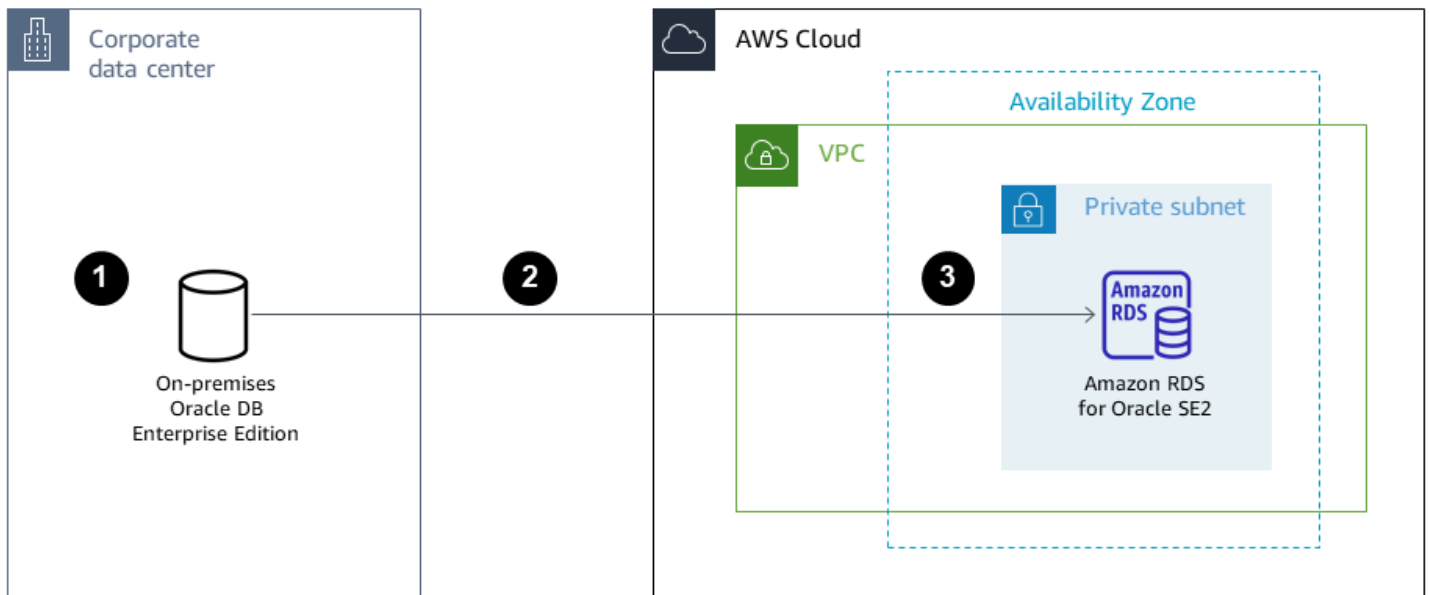

1. Export data by using Oracle Data Pump.
2. Copy dump files to Amazon RDS through a database link.
3. Import dump files to Amazon RDS by using Oracle Data Pump.

### Target technology stack using AWS DMS

- Amazon RDS for Oracle running Oracle Database SE2
- AWS DMS

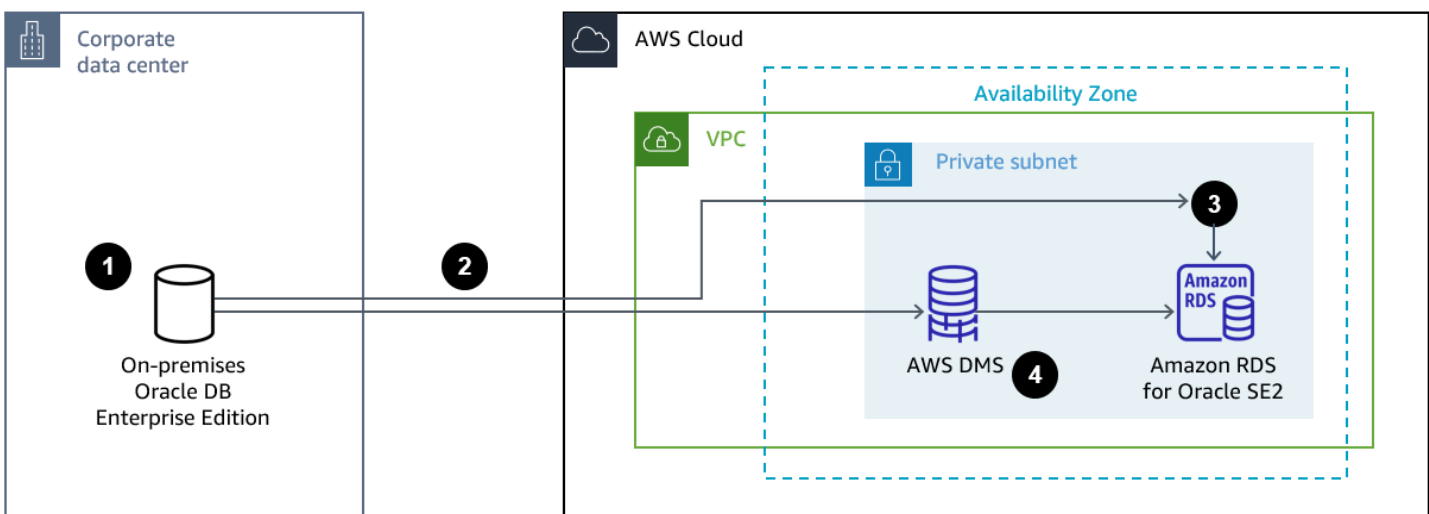

1. Export data by using Oracle Data Pump with FLASHBACK\_SCN.

2. Copy dump files to Amazon RDS through a database link.
3. Import dump files to Amazon RDS by using Oracle Data Pump.
4. Use AWS DMS [change data capture \(CDC\)](#).

## Tools

### AWS services

- [AWS Database Migration Service \(AWS DMS\)](#) helps you migrate data stores into the AWS Cloud or between combinations of cloud and on-premises setups.
- [Amazon Relational Database Service \(Amazon RDS\)](#) helps you set up, operate, and scale a relational database in the AWS Cloud. This pattern uses Amazon RDS for Oracle.
- [AWS SCT](#) provides a project-based user interface to automatically assess, convert, and copy the database schema of your source Oracle database into a format compatible with Amazon RDS for Oracle. AWS SCT enables you to analyze potential cost savings that can be achieved by changing your license type from Enterprise to Standard Edition of Oracle. The **License Evaluation and Cloud Support** section of the AWS SCT report provides detailed information about Oracle features in use so you can make an informed decision while migrating to Amazon RDS for Oracle.

### Other tools

- Native Oracle import and export utilities support moving Oracle data in and out of Oracle databases. Oracle offers two types of database import and export utilities: [Original Export and Import](#) (for earlier releases) and [Oracle Data Pump Export and Import](#) (available in Oracle Database 10g release 1 and later).
- [Oracle GoldenGate](#) offers real-time replication capabilities so that you can synchronize your target database after an initial load. This option can help reduce application downtime during go-live.

# Epics

## Make a pre-migration assessment

Task	Description	Skills required
Validate database requirements for your applications.	Ensure that your applications are certified to run on Oracle Database SE2. Check directly with the software vendor, developer, or application documentation.	App developer, DBA, App owner
Investigate use of EE features directly in the database.	<p>To determine EE feature use, do one of the following:</p> <ul style="list-style-type: none"><li>• <a href="#">Generate an AWS SCT assessment report</a> for your Oracle EE database. The report tells you which features from your current EE database should be removed if you want to change license types.</li><li>• If you have an Oracle Support account, obtain and run the script <code>options_packs_usage_statistics.sql</code> in <a href="#">Support document 1317265.1</a> to generate a report of options and features that are being used on your Oracle database.</li><li>• Query <a href="#">DBA_FEATURE_USAGE_STATISTICS</a></li></ul>	App owner, DBA, App developer

Task	Description	Skills required
	to display details of all features that are in use.	
Identify use of EE features for operational activities.	<p>Database or application administrators sometimes rely on EE-only features for operational activities. Common examples include online maintenance activities (index rebuild, table move) and use of parallelism by batch jobs.</p> <p>These dependencies can be mitigated by modifying your operations where possible. Identify the use of these features and make a decision based on cost compared with benefits.</p> <p>Use the <a href="#">Comparing Oracle Database EE and SE2 features</a> table as a guide to identify features that are available in Oracle Database SE2.</p>	App developer, DBA, App owner

Task	Description	Skills required
Review workload patterns of the EE Oracle database.	<p>Oracle Database SE2 automatically restricts usage to a maximum of 16 CPU threads at any time.</p> <p>If your Oracle EE database is licensed to use the Oracle Diagnostic Pack, use the Automatic Workload Repository (AWR) tool, or DBA_HIST_* views, to analyze database workload patterns to determine whether the maximum limit of 16 CPU threads will negatively impact service levels when you downgrade to SE2.</p> <p>Ensure that your assessment covers periods of peak activity, such as end of day, month, or year processing.</p>	App owner, DBA, App developer

## Prepare the target infrastructure on AWS

Task	Description	Skills required
Deploy and configure networking infrastructure.	Create a <a href="#">virtual private cloud (VPC)</a> and <a href="#">subnets</a> , <a href="#">security groups</a> , and <a href="#">network access control lists</a> .	AWS administrator, Cloud architect, Network administrator, DevOps engineer
Provision the Amazon RDS for Oracle SE2 database.	Provision the target <a href="#">Amazon RDS for Oracle</a> SE2 database to meet your applications'	Cloud administrator, Cloud architect, DBA, DevOps engineer, AWS administrator

Task	Description	Skills required
	<p>performance, availability, and security requirements. We recommend Multi-AZ configuration for production workloads. However, to improve migration performance, you can defer <a href="#">enabling Multi-AZ</a> until after data migration.</p>	
<p>Customize the Amazon RDS environment.</p>	<p>Configure custom <a href="#">parameters</a> and <a href="#">options</a>, and enable additional <a href="#">monitoring</a>. For more information, see <a href="#">Best practices for migrating to Amazon RDS for Oracle</a>.</p>	<p>AWS administrator, AWS systems administrator, Cloud administrator, DBA, Cloud architect</p>

## Perform the migration dry run and application testing

Task	Description	Skills required
<p>Migrate the data (dry run).</p>	<p>Migrate data from the source Oracle EE database to the Amazon RDS for Oracle SE2 database instance using the approach best suited to your specific environment. Select a migration strategy based on factors such as size, complexity, and the available downtime window. Use one or a combination of the following:</p>	<p>DBA</p>



Task	Description	Skills required
	<ul style="list-style-type: none"> <li>Native Oracle tools such as <a href="#">Oracle Data Pump</a> (recommended), Oracle Import-Export utilities, and <a href="#">Oracle GoldenGate</a>.</li> <li>AWS DMS, using the full load with continuous replication through CDC.</li> </ul>	
Validate the target database.	<p>Perform post-migration validation of database storage and code objects. Review migration logs, and fix any identified issues. For more information, see the guide <a href="#">Migrating Oracle databases to the AWS Cloud</a>.</p>	DBA
Test the applications.	<p>Application and database administrators should conduct functional, performance, and operational tests as appropriate. For more information, see <a href="#">Best practices for migrating to Amazon RDS for Oracle</a>.</p> <p>Lastly, obtain sign-offs on test-results from stakeholders.</p>	App developer, App owner, DBA, Migration engineer, Migration lead

## Cut over

Task	Description	Skills required
Refresh data from Oracle Database EE.	<p>Select a data refresh approach based on the application availability requirement. For more information, see the migration methods in <a href="#">Strategies for Migrating Oracle Databases to AWS</a>.</p> <p>For example, you can achieve near-zero downtime by using tools such as Oracle GoldenGate or AWS DMS with ongoing replication. If the downtime window permits, you can perform the final data cutover using offline methods such as Oracle Data Pump or Original Export-Import utilities.</p>	App owner, Cutover lead, DBA, Migration engineer, Migration lead
Point applications to the target database instance.	Update connection parameters in applications and other clients to point to the Amazon RDS for Oracle SE2 database.	App developer, App owner, Migration engineer, Migration lead, Cutover lead
Perform post-migration activities.	Perform post data migration tasks such as enabling Multi-AZ, data validation, and other checks.	DBA, Migration engineer

Task	Description	Skills required
Perform post-cutover monitoring.	Use tools such as <a href="#">Amazon CloudWatch</a> and <a href="#">Amazon RDS Performance Insights</a> to monitor the Amazon RDS for Oracle SE2 database.	App developer, App owner, AWS administrator, DBA, Migration engineer

## Related resources

### AWS Prescriptive Guidance

- [Migrating Oracle databases to the AWS Cloud](#) (guide)
- [Evaluate downgrading Oracle databases to Standard Edition 2 on AWS](#) (guide)
- [Migrate an on-premises Oracle database to Amazon RDS for Oracle](#) (pattern)
- [Migrate an on-premises Oracle database to Amazon RDS for Oracle using Oracle Data Pump](#) (pattern)

### Blog posts

- [Migrating Oracle databases with near-zero downtime using AWS DMS](#)
- [Analyzing performance management in Oracle SE using Amazon RDS for Oracle](#)
- [Managing your SQL plan in Oracle SE with Amazon RDS for Oracle](#)
- [Implementing table partitioning in Oracle Standard Edition: Part 1](#)

# Replicate mainframe databases to AWS by using Precisely Connect

Created by Lucio Pereira (AWS), Balaji Mohan (AWS), and Sayantan Giri (AWS)

<b>Environment:</b> Production	<b>Source:</b> On-premises mainframe	<b>Target:</b> AWS databases
<b>R Type:</b> Re-architect	<b>Workload:</b> All other workloads	<b>Technologies:</b> Databases ; CloudNative; Mainframe; Modernization
<b>AWS services:</b> Amazon DynamoDB; Amazon Keyspaces; Amazon MSK; Amazon RDS; Amazon ElastiCache		

## Summary

This pattern outlines steps for replicating data from mainframe databases to Amazon data stores in near real time by using Precisely Connect. It implements an event-based architecture with Amazon Managed Streaming for Apache Kafka (Amazon MSK) and custom database connectors in the cloud to improve scalability, resilience, and performance.

Precisely Connect is a replication tool that captures data from legacy mainframe systems and integrates it into cloud environments. Data is replicated from mainframes to AWS through change data capture (CDC) by using near real-time message flows with low-latency and high-throughput heterogeneous data pipelines.

This pattern also covers a disaster recovery strategy for resilient data pipelines with multi-Region data replication and failover routing.

## Prerequisites and limitations

### Prerequisites

- An existing mainframe database—for example, IBM DB2, IBM Information Management System (IMS), or Virtual Storage Access Method (VSAM)—that you want to replicate to the AWS Cloud
- An active [AWS account](#)
- [AWS Direct Connect](#) or [AWS Virtual Private Network \(AWS VPN\)](#) from your corporate environment to AWS
- A [virtual private cloud](#) with a subnet that is reachable by your legacy platform

## Architecture

### Source technology stack

A mainframe environment that includes at least one of the following databases:

- IBM IMS database
- IBM DB2 database
- VSAM files

### Target technology stack

- Amazon MSK
- Amazon Elastic Kubernetes Service (Amazon EKS) and Amazon EKS Anywhere
- Docker
- An AWS relational or NoSQL database such as the following:
  - Amazon DynamoDB
  - Amazon Relational Database Service (Amazon RDS) for Oracle, Amazon RDS for PostgreSQL, or Amazon Aurora
  - Amazon ElastiCache for Redis
  - Amazon Keyspaces (for Apache Cassandra)

### Target architecture

#### *Replicating mainframe data to AWS databases*

The following diagram illustrates the replication of mainframe data to an AWS database such as DynamoDB, Amazon RDS, Amazon ElastiCache, or Amazon Keyspaces. The replication occurs

in near real time by using Precisely Capture and Publisher in your on-premises mainframe environment, Precisely Dispatcher on Amazon EKS Anywhere in your on-premises distributed environment, and Precisely Apply Engine and database connectors in the AWS Cloud.

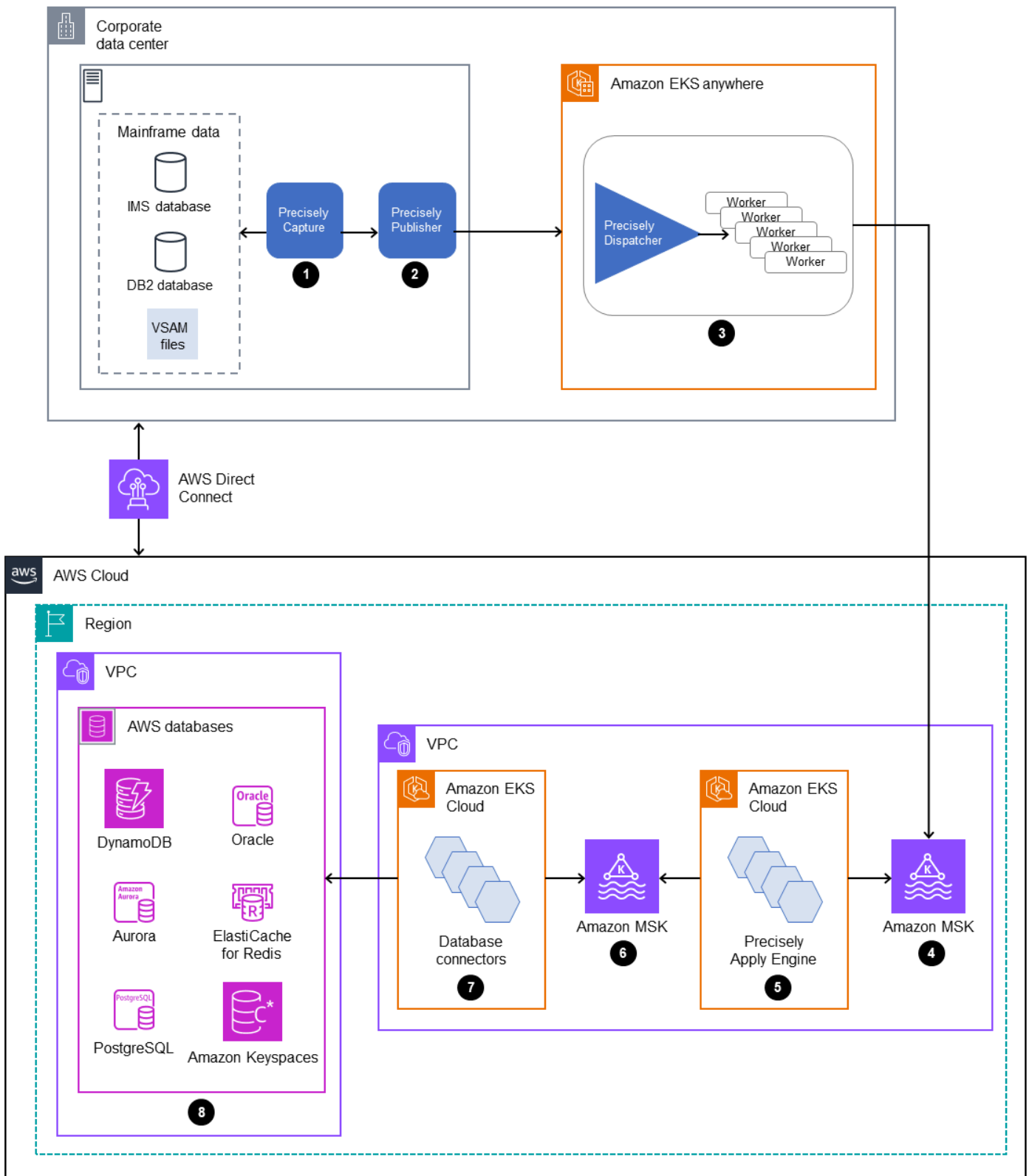

The diagram shows the following workflow:

1. Precisely Capture gets mainframe data from CDC logs and maintains the data in internal transient storage.
2. Precisely Publisher listens for changes in the internal data storage and sends CDC records to Precisely Dispatcher through a TCP/IP connection.
3. Precisely Dispatcher receives the CDC records from Publisher and sends them to Amazon MSK. Dispatcher creates Kafka keys based on the user configuration and multiple worker tasks to push data in parallel. Dispatcher sends an acknowledgment back to Publisher when records have been stored in Amazon MSK.
4. Amazon MSK holds the CDC records in the cloud environment. The partition size of topics depends on your transaction processing system (TPS) requirements for throughput. The Kafka key is mandatory for further transformation and transaction ordering.
5. The Precisely Apply Engine listens to the CDC records from Amazon MSK and transforms the data (for example, by filtering or mapping) based on target database requirements. You can add customized logic to the Precisely SQD scripts. (SQD is Precisely's proprietary language.) The Precisely Apply Engine transforms each CDC record to Apache Avro or JSON format and distributes it to different topics based on your requirements.
6. The target Kafka topics hold CDC records in multiple topics based on the target database, and Kafka facilitates transaction ordering based on the defined Kafka key. The partition keys align with the corresponding partitions to support a sequential process.
7. Database connectors (customized Java applications) listen to the CDC records from Amazon MSK and store them in the target database.
8. You can select a target database based on your requirements. This pattern supports both NoSQL and relational databases.

### *Disaster recovery*

Business continuity is key to your organization's success. The AWS Cloud provides capabilities for high availability (HA) and disaster recovery (DR), and supports your organization's failover and fallback plans. This pattern follows an active/passive DR strategy and provides high-level guidance for implementing a DR strategy that meets your RTO and RPO requirements.

The following diagram illustrates the DR workflow.



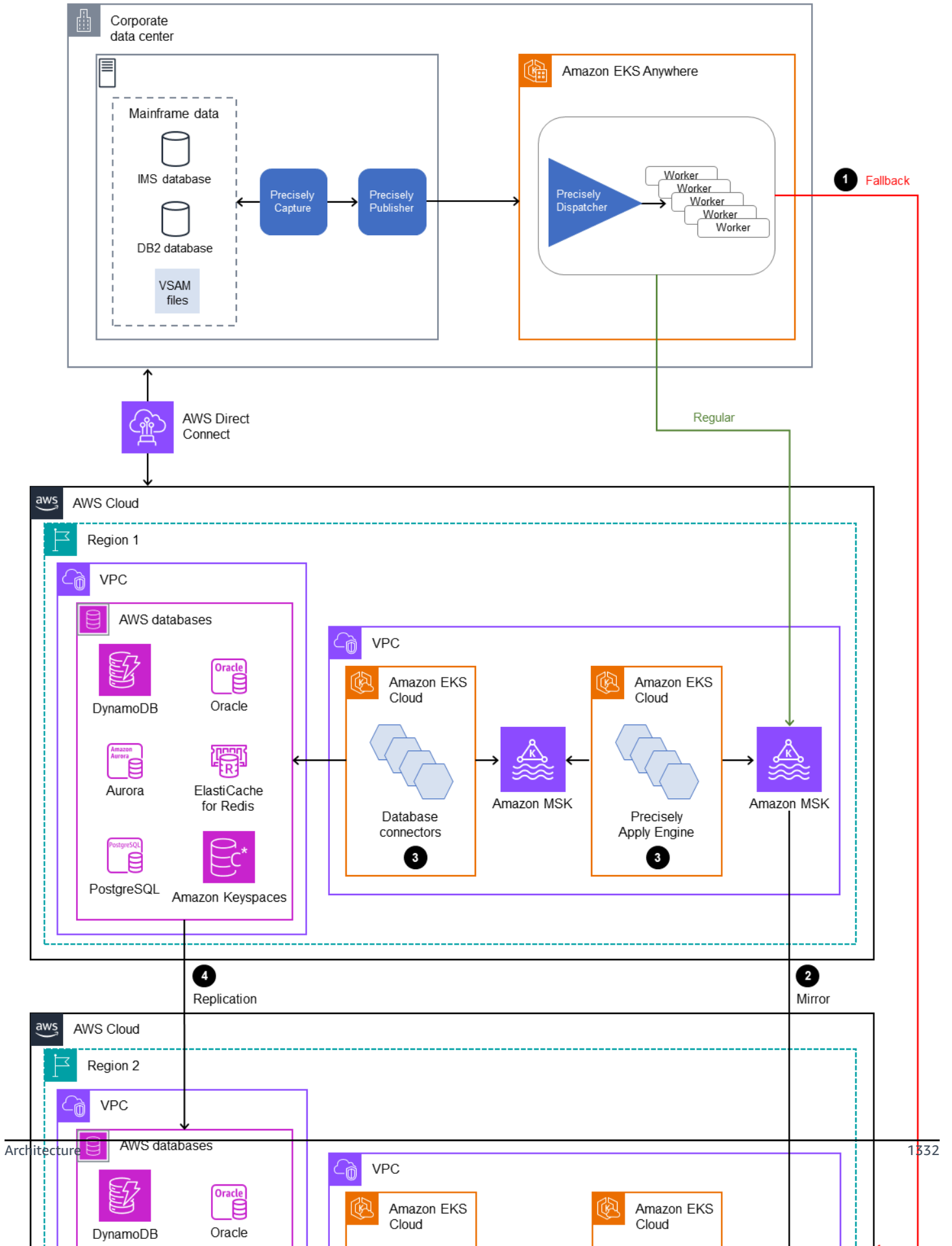

The diagram shows the following:

1. A semi-automated failover is required if any failure happens in AWS Region 1. In the case of failure in Region 1, the system must initiate routing changes to connect Precisely Dispatcher to Region 2.
2. Amazon MSK replicates data through mirroring between Regions, For this reason, during failover, the Amazon MSK cluster in Region 2 has to be promoted as the primary leader.
3. The Precisely Apply Engine and database connectors are stateless applications that can work in any Region.
4. Database synchronization depends on the target database. For example, DynamoDB can use global tables, and ElastiCache can use global datastores.

### *Low-latency and high-throughput processing through database connectors*

Database connectors are critical components in this pattern. Connectors follow a listener-based approach to collect data from Amazon MSK and send transactions to the database through high-throughput and low-latency processing for mission-critical applications (tiers 0 and 1). The following diagram illustrates this process.

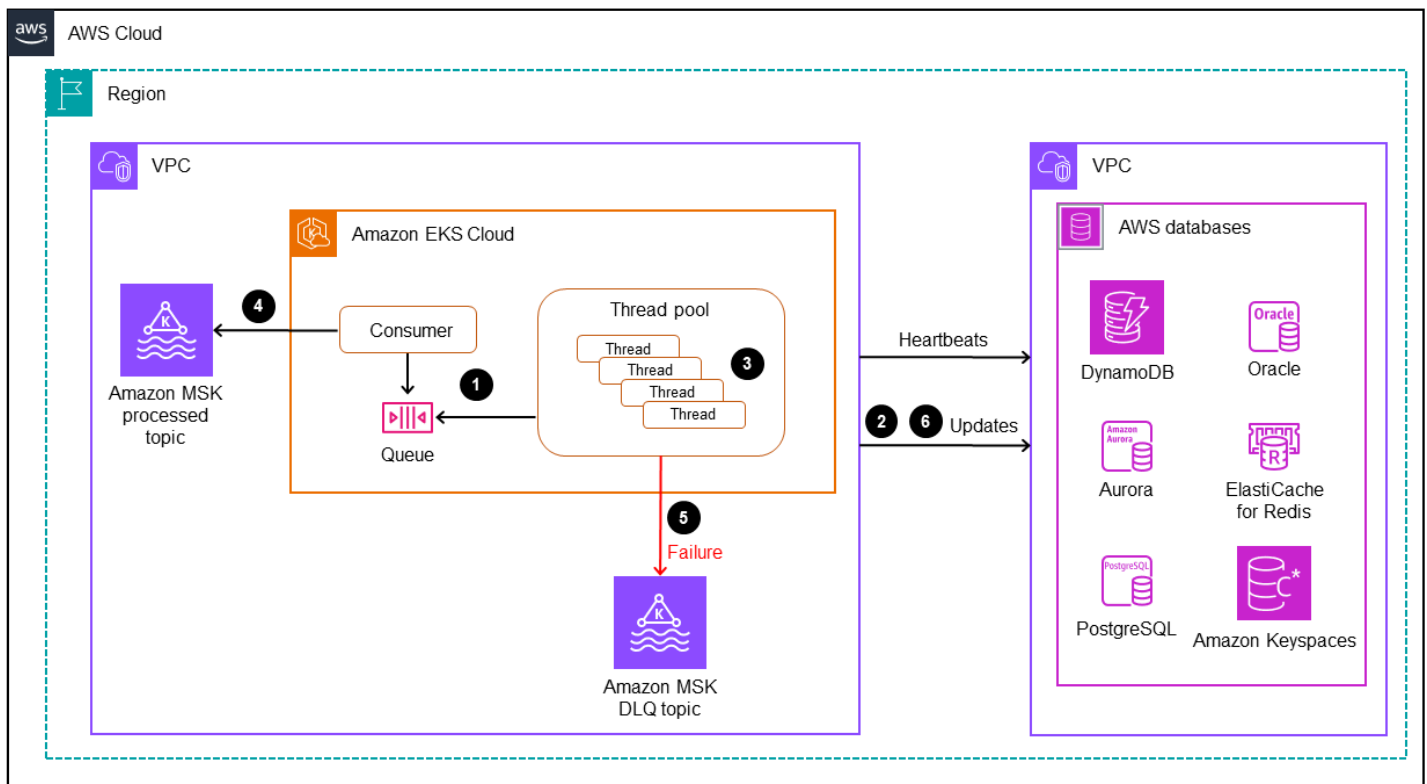

This pattern supports the development of a customized application with single-threaded consumption through a multithreaded processing engine.

1. The connector main thread consumes CDC records from Amazon MSK and sends them to the thread pool for processing.
2. Threads from the thread pool process CDC records and send them to the target database.
3. If all threads are busy, the CDC records are kept on hold by the thread queue.
4. The main thread waits to get all the records cleared from the thread queue and commits offsets into Amazon MSK.
5. The child threads handle failures. If failures happen during processing, the failed messages are sent to the DLQ (dead letter queue) topic.
6. The child threads initiate conditional updates (see [Condition expressions](#) in the DynamoDB documentation), based on the mainframe timestamp, to avoid any duplication or out-of-order updates in the database.

For information about how to implement a Kafka consumer application with multi-threading capabilities, see the blog post [Multi-Threaded Message Consumption with the Apache Kafka Consumer](#) on the Confluent website.

## Tools

### AWS services

- [Amazon Managed Streaming for Apache Kafka \(Amazon MSK\)](#) is a fully managed service that helps you build and run applications that use Apache Kafka to process streaming data.
- [Amazon Elastic Kubernetes Service \(Amazon EKS\)](#) helps you run Kubernetes on AWS without having to install or maintain your own Kubernetes control plane or nodes.
- [Amazon EKS Anywhere](#) helps you deploy, use, and manage Kubernetes clusters that run in your own data centers.
- [Amazon DynamoDB](#) is a fully managed NoSQL database service that provides fast, predictable, and scalable performance.
- [Amazon Relational Database Service \(Amazon RDS\)](#) helps you set up, operate, and scale a relational database in the AWS Cloud.
- [Amazon ElastiCache](#) helps you set up, manage, and scale distributed in-memory cache environments in the AWS Cloud.

- [Amazon Keyspaces \(for Apache Cassandra\)](#) is a managed database service that helps you migrate, run, and scale your Cassandra workloads in the AWS Cloud.

## Other tools

- [Precisely Connect](#) integrates data from legacy mainframe systems such as VSAM datasets or IBM mainframe databases into next-generation cloud and data platforms.

## Best practices

- Find the best combination of Kafka partitions and multi-threaded connectors to balance optimal performance and cost. Multiple Precisely Capture and Dispatcher instances can increase cost because of higher MIPS (million instructions per second) consumption.
- Avoid adding data manipulation and transformation logic to the database connectors. For this purpose, use the Precisely Apply Engine, which provides processing times in microseconds.
- Create periodic request or health check calls to the database (*heartbeats*) in database connectors to warm up the connection frequently and reduce latency.
- Implement thread pool validation logic to understand the pending tasks in the thread queue and wait for all threads to be completed before the next Kafka polling. This helps avoid data loss if a node, container, or process crashes.
- Expose latency metrics through health endpoints to enhance observability capabilities through dashboards and tracing mechanisms.

## Epics

### Prepare the source environment (on premises)

Task	Description	Skills required
Set up the mainframe process (batch or online utility) to start the CDC process from mainframe databases.	<ol style="list-style-type: none"><li>1. Identify the mainframe environment.</li><li>2. Identify the mainframe databases that will be involved in the CDC process.</li></ol>	Mainframe engineer

Task	Description	Skills required
	<ol style="list-style-type: none"><li data-bbox="592 212 992 579">3. In the mainframe environment, develop a process that launches the CDC tool to capture changes in the source database. For instructions, see your mainframe documentation.</li><li data-bbox="592 600 943 730">4. Document the CDC process, including the configuration.</li><li data-bbox="592 751 992 882">5. Deploy the process in both test and production environments.</li></ol>	
Activate mainframe database log streams.	<ol style="list-style-type: none"><li data-bbox="592 930 1024 1150">1. Configure log streams in the mainframe environment to capture CDC logs. For instructions, see your mainframe documentation.</li><li data-bbox="592 1171 987 1302">2. Test the log streams to ensure that they capture the necessary data.</li><li data-bbox="592 1323 964 1453">3. Deploy the log streams in test and production environments.</li></ol>	Mainframe DB specialist

Task	Description	Skills required
Use the Capture component to capture CDC records.	<ol style="list-style-type: none"><li data-bbox="592 226 1027 499">1. Install and configure the Precisely Capture component in the mainframe environment. For instructions, see the <a href="#">Precisely documentation</a>.</li><li data-bbox="592 520 1027 709">2. Test the configuration to ensure that the Capture component works correctly.</li><li data-bbox="592 730 1027 919">3. Set up a replication process to replicate the captured CDC records through the Capture component.</li><li data-bbox="592 940 1027 1066">4. Document the Capture configuration for each source database.</li><li data-bbox="592 1087 1027 1318">5. Develop a monitoring system to ensure that the Capture component collects logs properly over time.</li><li data-bbox="592 1339 1027 1507">6. Deploy the installation and configurations in the test and production environments.</li></ol>	Mainframe engineer, Precisely Connect SME

Task	Description	Skills required
Configure the Publisher component to listen to the Capture component.	<ol style="list-style-type: none"><li data-bbox="591 226 1027 499">1. Install and configure the Precisely Publisher component in the mainframe environment. For instructions, see the <a href="#">Precisely documentation</a>.</li><li data-bbox="591 520 1027 709">2. Test the configuration to ensure that the Publisher component works correctly.</li><li data-bbox="591 730 1027 919">3. Set up a replication process to publish the CDC records to the Precisely Dispatcher component from Publisher.</li><li data-bbox="591 940 1027 1024">4. Document the Publisher configuration.</li><li data-bbox="591 1045 1027 1234">5. Develop a monitoring system to ensure that the Publisher component works properly over time.</li><li data-bbox="591 1255 1027 1402">6. Deploy the installation and configurations in the test and production environments.</li></ol>	Mainframe engineer, Precisely Connect SME

Task	Description	Skills required
Provision Amazon EKS Anywhere in the on-premises distributed environment.	<ol style="list-style-type: none"><li data-bbox="592 226 1027 548">1. Install Amazon EKS Anywhere on the on-premises infrastructure and ensure that it is properly configured. For instructions, see the <a href="#">Amazon EKS Anywhere</a> documentation.</li><li data-bbox="592 569 1027 747">2. Set up a secure network environment for the Kubernetes cluster, including firewalls.</li><li data-bbox="592 768 1027 947">3. Implement and test the sample application deployment to the Amazon EKS Anywhere cluster.</li><li data-bbox="592 968 1027 1104">4. Implement automatic scaling capabilities for the cluster.</li><li data-bbox="592 1125 1027 1251">5. Develop and implement backup and disaster recovery procedures.</li></ol>	DevOps engineer



Task	Description	Skills required
Deploy and configure the Dispatcher component in the distributed environment to publish the topics in the AWS Cloud.	<ol style="list-style-type: none"> <li>1. Configure and containerize the Precisely Dispatcher component. For instructions, see the <a href="#">Precisely documentation</a>.</li> <li>2. Deploy the Dispatcher Docker image into the on-premises Amazon EKS Anywhere environment.</li> <li>3. Set up a secure connection between the AWS Cloud and Dispatcher.</li> <li>4. Develop a monitoring system to ensure that the Dispatcher component works properly over time.</li> <li>5. Deploy the installation and configurations in the test and production environments.</li> </ol>	DevOps engineer, Precisely Connect SME

### Prepare the target environment (AWS)

Task	Description	Skills required
Provision an Amazon EKS cluster in the designated AWS Region.	<ol style="list-style-type: none"> <li>1. Sign in to your AWS account and configure it to ensure that the necessary permissions are in place to create and manage the Amazon EKS cluster.</li> <li>2. Create a virtual private cloud (VPC) and subnets in</li> </ol>	DevOps engineer, Network administrator

Task	Description	Skills required
	<p>the selected AWS Region. For instructions, see the <a href="#">Amazon EKS documentation</a>.</p> <ol style="list-style-type: none"><li>3. Create and configure the necessary network security groups to allow communications between the Amazon EKS cluster and other resources in the VPC. For more information, see the <a href="#">Amazon EKS documentation</a>.</li><li>4. Create the <a href="#">Amazon EKS cluster</a> and configure it with the correct <a href="#">node group</a> size and instance types.</li><li>5. Validate the Amazon EKS cluster by deploying a sample application.</li></ol>	

Task	Description	Skills required
Provision an MSK cluster and configure applicable Kafka topics.	<ol style="list-style-type: none"><li data-bbox="592 226 1015 451">1. Configure your AWS account to ensure that the necessary permissions are in place to create and manage the MSK cluster.</li><li data-bbox="592 472 1015 892">2. Create and configure the necessary network security groups to allow communications between the MSK cluster and other resources in the VPC. For more information, see the <a href="#">Amazon VPC documentation</a>.</li><li data-bbox="592 913 1015 1228">3. Create the MSK cluster and configure it to include the Kafka topics that will be used by the application. For more information, see the <a href="#">Amazon MSK documentation</a>.</li></ol>	DevOps engineer, Network administrator

Task	Description	Skills required
<p>Configure the Apply Engine component to listen to the replicated Kafka topics.</p>	<ol style="list-style-type: none"><li>1. Configure and containerize the <a href="#">Precisely Apply Engine component</a>.</li><li>2. Deploy the Apply Engine Docker image into the Amazon EKS cluster in your AWS account.</li><li>3. Set up the Apply Engine to listen to MSK topics.</li><li>4. Develop and configure a SQD script in the Apply Engine to handle filtering and transformation. For more information, see the <a href="#">Precisely documentation</a>.</li><li>5. Deploy the Apply Engine in test and production environments.</li></ol>	<p>Precisely Connect SME</p>

Task	Description	Skills required
Provision DB instances in the AWS Cloud.	<ol style="list-style-type: none"><li data-bbox="592 226 1026 741">1. Configure your AWS account to ensure that the necessary permissions are in place to create and manage DB clusters and tables. For instructions, see the AWS documentation for the AWS database service you want to use. (See the <a href="#">Resources section</a> for links.)</li><li data-bbox="592 762 1026 888">2. Create a VPC and subnets in the selected AWS Region.</li><li data-bbox="592 909 1026 1182">3. Create and configure the necessary network security groups to allow communications between the DB instances and other resources in the VPC.</li><li data-bbox="592 1203 1026 1392">4. Create the databases and configure them to include the tables that the application will use.</li><li data-bbox="592 1413 1026 1497">5. Design and validate the database schemas.</li></ol>	Data engineer, DevOps engineer

Task	Description	Skills required
Configure and deploy database connectors to listen to the topics published by the Apply Engine.	<ol style="list-style-type: none"> <li>1. Design database connectors to connect the Kafka topics with the AWS databases that you created in the earlier steps.</li> <li>2. Develop the connectors based on the target database.</li> <li>3. Configure the connectors to listen to the Kafka topics that are published by the Apply Engine.</li> <li>4. Deploy the connectors into the Amazon EKS cluster.</li> </ol>	App developer, Cloud architect, Data engineer

## Set up business continuity and disaster recovery

Task	Description	Skills required
Define disaster recovery goals for your business applications.	<ol style="list-style-type: none"> <li>1. Define the RPO and RTO goals for CDC pipelines based on your business needs and impact analysis.</li> <li>2. Define the communication and notification procedures to ensure that all stakeholders are aware of the disaster recovery plan.</li> <li>3. Determine the budget and resources needed to implement the disaster recovery plan.</li> </ol>	Cloud architect, Data engineer, App owner

Task	Description	Skills required
	4. Document the disaster recovery goals, including the RPO and RTO goals.	
Design disaster recovery strategies based on defined RTO/RPO.	<ol style="list-style-type: none"><li>1. Determine the most appropriate disaster recovery strategies for CDC pipelines based on your criticality and recovery requirements.</li><li>2. Define the disaster recovery architecture and topology.</li><li>3. Define the failover and failback procedures for CDC pipelines to ensure that they can be quickly and seamlessly switched to the backup Region.</li><li>4. Document the disaster recovery strategies and procedures and ensure that all stakeholders have a clear understanding of the design.</li></ol>	Cloud architect, Data engineer

Task	Description	Skills required
Provision disaster recovery clusters and configurations.	<ol style="list-style-type: none"><li data-bbox="594 226 1026 359">1. Provision a secondary AWS Region for disaster recovery.</li><li data-bbox="594 380 1026 604">2. In the secondary AWS Region, create an environment that's identical to the primary AWS Region.</li><li data-bbox="594 625 1026 947">3. Configure Apache Kafka MirrorMaker between the primary and secondary Regions. For more information, see the <a href="#">Amazon MSK documentation</a>.</li><li data-bbox="594 968 1026 1100">4. Configure standby applications in the secondary Region.</li><li data-bbox="594 1121 1026 1297">5. Configure database replications between the primary and secondary Regions.</li></ol>	DevOps engineer, Network administrator, Cloud architect



Task	Description	Skills required
Test the CDC pipeline for disaster recovery.	<ol style="list-style-type: none"><li>1. Define the scope and objectives of the disaster recovery test for the CDC pipeline, including the test scenarios and RTO to be achieved.</li><li>2. Identify the test environment and infrastructure for conducting the disaster recovery test.</li><li>3. Prepare the test datasets and script to simulate failure scenarios.</li><li>4. Verify data integrity and consistency to ensure that there is no data loss.</li></ol>	App owner, Data engineer, Cloud architect

## Related resources

### AWS resources

- [Amazon DynamoDB](#)
- [Condition expressions with Amazon DynamoDB](#)
- [Amazon EKS](#)
- [Amazon EKS Anywhere](#)
- [Amazon ElasticCache](#)
- [Amazon Keyspaces](#)
- [Amazon MSK](#)
- [Amazon RDS and Amazon Aurora](#)
- [Amazon VPC](#)

### Precisely Connect resources

- [Precisely Connect Overview](#)
- [Change Data Capture with Precisely Connect](#)

### **Confluent resources**

- [Multi-Threaded Message Consumption with the Apache Kafka Consumer](#)

# Schedule jobs for Amazon RDS for PostgreSQL and Aurora PostgreSQL by using Lambda and Secrets Manager

Created by Yaser Raja (AWS)

<b>Environment:</b> PoC or pilot	<b>Source:</b> Databases: Relational	<b>Target:</b> PostgreSQL on AWS
<b>R Type:</b> N/A	<b>Workload:</b> Open-source	<b>Technologies:</b> Databases
<b>AWS services:</b> AWS Lambda; Amazon RDS; AWS Secrets Manager; Amazon Aurora		

## Summary

For on-premises databases and databases that are hosted on Amazon Elastic Compute Cloud (Amazon EC2) instances, database administrators often use the **cron** utility to schedule jobs.

For example, a job for data extraction or a job for data purging can easily be scheduled using **cron**. For these jobs, database credentials are typically either hard-coded or stored in a properties file. However, when you migrate to Amazon Relational Database Service (Amazon RDS) or Amazon Aurora PostgreSQL-Compatible Edition, you lose the ability to log in to the host instance to schedule **cron** jobs.

This pattern describes how to use AWS Lambda and AWS Secrets Manager to schedule jobs for Amazon RDS for PostgreSQL and Aurora PostgreSQL-Compatible databases after migration.

## Prerequisites and limitations

### Prerequisites

- An active AWS account
- An Amazon RDS for PostgreSQL or Aurora PostgreSQL-Compatible database

### Limitations

- A job must complete within 15 minutes, which is the Lambda function timeout limit. For other limits, see the [AWS Lambda documentation](#).
- Job code must be written in a [language supported by Lambda](#).

## Architecture

### Source technology stack

This stack features jobs written in languages such as Bash, Python, and Java. Database credentials are stored in the properties file, and the job is scheduled using Linux **cron**.

### Target technology stack

This stack has a Lambda function that uses the credentials stored in Secrets Manager to connect to the database and to perform the activity. The Lambda function is initiated at the scheduled interval by using Amazon CloudWatch Events.

### Target architecture

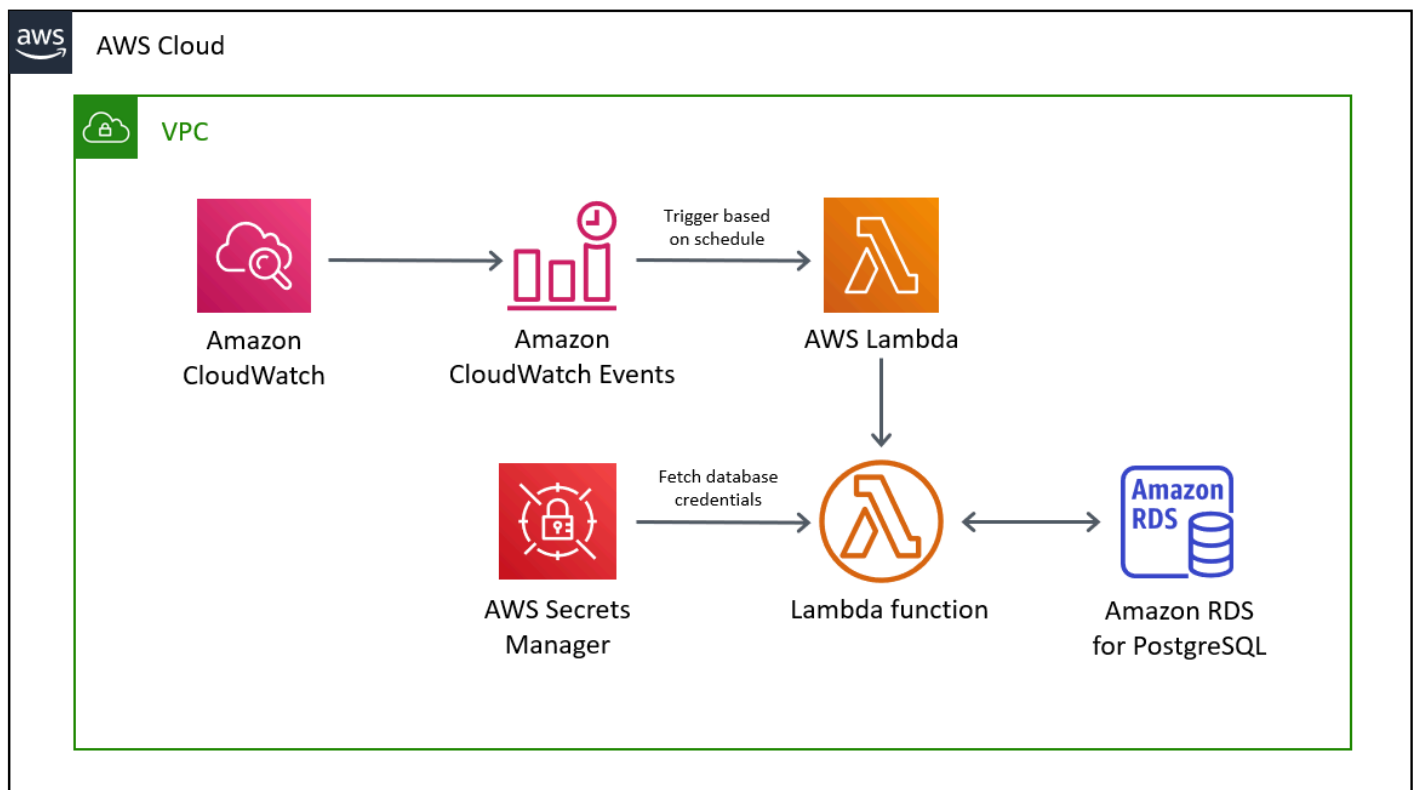

## Tools

- [AWS Lambda](#) is a compute service that lets you run code without provisioning or managing servers. AWS Lambda runs your code only when needed and scales automatically, from a few requests per day to thousands per second. You pay only for the compute time you consume; there is no charge when your code is not running. With AWS Lambda, you can run code for virtually any type of application or backend service with zero administration. AWS Lambda runs your code on a high-availability compute infrastructure and manages all the compute resources, including server and operating system maintenance, capacity provisioning and automatic scaling, code monitoring, and logging. All you need to do is provide your code in one of the [languages that AWS Lambda supports](#).
- [Amazon CloudWatch Events](#) delivers a near real-time stream of system events that describe changes in AWS resources. Using simple rules that you can quickly set up, you can match events and route them to one or more target functions or streams. CloudWatch Events becomes aware of operational changes as they occur. It responds to these operational changes and takes corrective action as necessary, by sending messages to respond to the environment, activating functions, making changes, and capturing state information. You can also use CloudWatch Events to schedule automated actions that self-initiate at certain times using **cron** or **rate** expressions.
- [AWS Secrets Manager](#) helps you protect secrets for accessing your applications, services, and IT resources. You can easily rotate, manage, and retrieve database credentials, API keys, and other secrets throughout their lifecycle. Users and applications retrieve secrets by calling Secrets Manager APIs, which eliminates the need to hard-code sensitive information in plain text. Secrets Manager offers secret rotation with built-in integration for Amazon RDS, Amazon Redshift, and Amazon DocumentDB. The service is extensible to other types of secrets, including API keys and OAuth tokens. Secrets Manager enables you to control access to secrets using fine-grained permissions and to audit secret rotation centrally for resources in the AWS Cloud, third-party services, and on-premises.

## Epics

### Store database credentials in Secrets Manager

Task	Description	Skills required
Create a database user for the Lambda function.	It is a good practice to use separate database users for different parts of your application. If a separate database user already exists for your cron jobs, use that. Otherwise, create a new database user. For more information, see <a href="#">Managing PostgreSQL users and roles</a> (AWS blog post).	DBA
Store database credentials as a secret in Secrets Manager.	Follow the instructions in <a href="#">Create a database secret</a> (Secrets Manager documentation).	DBA, DevOps

### Author the code for the Lambda function

Task	Description	Skills required
Choose a programming language supported by AWS Lambda.	For a list of supported languages, see <a href="#">Lambda runtimes</a> (Lambda documentation).	Developer
Write the logic to fetch the database credentials from Secrets Manager.	For sample code, see <a href="#">How to securely provide database credentials to Lambda functions by using AWS</a>	Developer

Task	Description	Skills required
	<a href="#">Secrets Manager</a> (AWS blog post).	
Write the logic to perform the scheduled database activity.	Migrate your existing code for the scheduling job that you're using on premises to the AWS Lambda function. For more information, see <a href="#">Deploying Lambda functions</a> (Lambda documentation).	Developer

### Deploy the code and create the Lambda function

Task	Description	Skills required
Create the Lambda function deployment package.	This package contains the code and its dependencies. For more information, see <a href="#">Deployment packages</a> (Lambda documentation).	Developer
Create the Lambda function.	In the AWS Lambda console, choose <b>Create function</b> , enter a function name, choose the runtime environment, and then choose <b>Create function</b> .	DevOps
Upload the deployment package.	Choose the Lambda function you created to open its configuration. You can write your code directly in the code section or upload your deployment package. To upload your package, go to the <b>Function code</b> section,	DevOps

Task	Description	Skills required
	choose the <b>Code entry type</b> to upload a .zip file, and then select the package.	
Configure the Lambda function per your requirements.	For example, you can set the <b>Timeout</b> parameter to the duration you expect your Lambda function to take. For more information, see <a href="#">Configuring function options</a> (Lambda documentation).	DevOps
Set permissions for the Lambda function role to access Secrets Manager.	For instructions, see <a href="#">Use secrets in AWS Lambda functions</a> (Secrets Manager documentation).	DevOps
Test the Lambda function.	Initiate the function manually to make sure it works as expected.	DevOps

### Schedule the Lambda function by using CloudWatch Events

Task	Description	Skills required
Create a rule to run your Lambda function on a schedule.	Schedule the Lambda function by using CloudWatch Events. For instructions, see <a href="#">Schedule Lambda functions using CloudWatch Events</a> (CloudWatch Events tutorial).	DevOps



## Related resources

- [AWS Secrets Manager](#)
- [Getting started with Lambda](#)
- [Creating a CloudWatch Events Rule That Triggers on an Event](#)
- [AWS Lambda Limits](#)
- [Query your AWS database from your serverless application](#) (blog post)

# Secure and streamline user access in a Db2 federation database on AWS by using trusted contexts

Created by Sai Parthasaradhi (AWS)

**Environment:** PoC or pilot

**Technologies:** Databases;  
Security, identity, compliance

**Workload:** IBM

**AWS services:** Amazon EC2

## Summary

Many companies are migrating their legacy mainframe workloads to Amazon Web Services (AWS). This migration includes shifting IBM Db2 for z/OS databases to Db2 for Linux, Unix, and Windows (LUW) on Amazon Elastic Compute Cloud (Amazon EC2). During a phased migration from on premises to AWS, users might need to access data in IBM Db2 z/OS and in Db2 LUW on Amazon EC2 until all applications and databases are fully migrated to Db2 LUW. In such remote data-access scenarios, user authentication can be challenging because different platforms use different authentication mechanisms.

This pattern covers how to set up a federation server on Db2 for LUW with Db2 for z/OS as a remote database. The pattern uses a trusted context to propagate a user's identity from Db2 LUW to Db2 z/OS without re-authenticating on the remote database. For more information about trusted contexts, see the [Additional information](#) section.

## Prerequisites and limitations

### Prerequisites

- An active AWS account
- A Db2 instance running on an Amazon EC2 instance
- A remote Db2 for z/OS database running on premises
- The on-premises network connected to AWS through [AWS Site-to-Site VPN](#) or [AWS Direct Connect](#)

# Architecture

## Target architecture

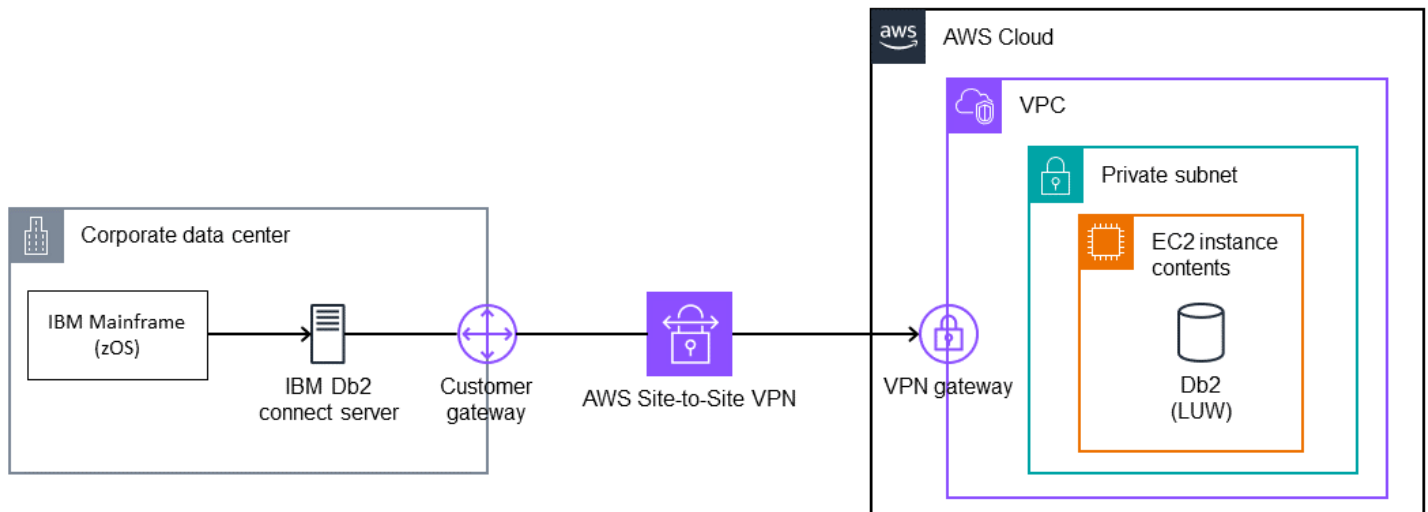

## Tools

### AWS services

- [Amazon Elastic Compute Cloud \(Amazon EC2\)](#) provides scalable computing capacity in the AWS Cloud. You can launch as many virtual servers as you need and quickly scale them up or down.
- [AWS Site-to-Site VPN](#) helps you pass traffic between instances that you launch on AWS and your own remote network.

### Other services

- [db2cli](#) is the Db2 interactive command line interface (CLI) command.

## Epics

### Enable federation on the Db2 LUW database running on AWS

Task	Description	Skills required
Enable federation on the DB2 LUW DB.	To enable federation on DB2 LUW, run the following command.  <pre>update dbm cfg using federated YES</pre>	DBA
Restart the database.	To restart the database, run the following command.  <pre>db2stop force; db2start;</pre>	DBA

### Catalog the remote database

Task	Description	Skills required
Catalog the remote Db2 z/OS subsystem.	To catalog the remote Db2 z/OS database on Db2 LUW running on AWS, use the following example command.  <pre>catalog TCPIP NODE tcpnode REMOTE mainframehost SERVER mainframeport</pre>	DBA
Catalog the remote database.	To catalog the remote database, use the following example command.	DBA

Task	Description	Skills required
	<pre>catalog db dbnam1 as ndbnam1 at node tcpnode</pre>	

## Create the remote server definition

Task	Description	Skills required
<p>Collect user credentials for the remote Db2 z/OS database.</p>	<p>Before proceeding with the next steps, gather the following information:</p> <ul style="list-style-type: none"> <li>• Db2 z/OS subsystem name – The cataloged Db2 z/OS name on LUW from the previous step (for example, ndbnam1)</li> <li>• Db2 z/OS version – The Db2 z/OS subsystem version (for example, 12)</li> <li>• Db2 z/OS user ID – The user with the BIND privilege, which is needed to create only the server definition (for example, dbuser1)</li> <li>• Db2 z/OS password – The password for dbuser1 (for example, dbpasswd)</li> <li>• Db2 z/OS proxy user – The ID of the proxy user, which will be used to establish trusted connection (for example, zproxy)</li> </ul>	<p>DBA</p>

Task	Description	Skills required
	<ul style="list-style-type: none"> <li>• Db2 z/OS proxy password               <ul style="list-style-type: none"> <li>– The password for the zproxy user (for example, zproxy)</li> </ul> </li> </ul>	
Create the DRDA wrapper.	<p>To create the DRDA wrapper, run the following command.</p> <pre data-bbox="597 558 1026 638">CREATE WRAPPER DRDA;</pre>	DBA
Create the server definition.	<p>To create the server definition, run the following example command.</p> <pre data-bbox="597 842 1026 1199">CREATE SERVER ndbserver TYPE DB2/ZOS VERSION 12 WRAPPER DRDA AUTHORIZATION "dbuser1"   PASSWORD "dbpasswd" " OPTIONS ( DBNAME 'ndbnam1', FED_PROXY_USER 'ZPROXY' );</pre> <p>In this definition, FED_PROXY_USER specifies the proxy user that will be used for establishing trusted connections to the Db2 z/OS database. The authorization user ID and password are required only for creating the remote server object in the Db2 LUW database. They won't be used later during runtime.</p>	DBA

## Create user mappings

Task	Description	Skills required
<p>Create a user mapping for the proxy user.</p>	<p>To create a user mapping for proxy user, run the following command.</p> <pre data-bbox="597 499 1024 737">CREATE USER MAPPING FOR ZPROXY SERVER ndbserver OPTIONS (REMOTE_AUTHID 'ZPROXY', REMOTE_PA SSWORD 'zproxy');</pre>	<p>DBA</p>
<p>Create user mappings for each user on Db2 LUW.</p>	<p>Create user mappings for all the users on the Db2 LUW database on AWS who need to access remote data through the proxy user. To create the user mappings, run the following command.</p> <pre data-bbox="597 1136 1024 1413">CREATE USER MAPPING FOR PERSON1 SERVER ndbserver OPTIONS (REMOTE_AUTHID 'USERZID', USE_TRUST ED_CONTEXT 'Y');</pre> <p>The statement specifies that a user on Db2 LUW (PERSON1) can establish a trusted connection to the remote Db2 z/OS database (USE_TRUSTED_CONTEXT 'Y'). After the connection is established through the proxy user, the user can access the</p>	<p>DBA</p>

Task	Description	Skills required
	data by using the Db2 z/OS user ID (REMOTE_AUTHID 'USERZID' ).	

## Create the trusted context object

Task	Description	Skills required
Create the trusted context object.	<p>To create the trusted context object on the remote Db2 z/OS database, use the following example command.</p> <pre>CREATE TRUSTED CONTEXT   CTX_LUW_ZOS   BASED UPON CONNECTION USING SYSTEM AUTHID   ZPROXY   ATTRIBUTES (     ADDRESS '10.10.10.10'   )   NO DEFAULT ROLE   ENABLE   WITH USE FOR PUBLIC   WITHOUT AUTHENTICATION;</pre> <p>In this definition, CTX_LUW_ZOS is an arbitrary name for the trusted context object. The object contains the proxy user ID and the IP address of the server from which the trusted connection must originate. In this example, the server the Db2 LUW database</p>	DBA



Task	Description	Skills required
	on AWS. You can use the domain name instead of the IP address. The clause WITH USE FOR PUBLIC WITHOUT AUTHENTICATION indicates that switching the user ID on a trusted connection is allowed for every user ID. A password doesn't need to be provided.	

## Related resources

- [IBM Resource Access Control Facility \(RACF\)](#)
- [IBM Db2 LUW Federation](#)
- [Trusted contexts](#)

## Additional information

### Db2 trusted contexts

A trusted context is a Db2 database object that defines a trust relationship between a federated server and a remote database server. To define a trusted relationship, the trusted context specifies trust attributes. There are three types of trust attributes:

- The system authorization ID that makes the initial database connection request
- The IP address or domain name from which the connection is made
- The encryption setting for data communications between the database server and the database client

A trusted connection is established when all attributes of a connection request match the attributes specified in any trusted context object defined on the server. There are two types of trusted connections: implicit and explicit. After an implicit trusted connection is established, a user

inherits a role that isn't available to them outside the scope of that trusted connection definition. After an explicit trusted connection is established, users can be switched on the same physical connection, with or without authentication. In addition, Db2 users can be granted roles that specify privileges that are for use only within the trusted connection. This pattern uses an explicit trusted connection.

### *Trusted context in this pattern*

After the pattern is complete, PERSON1 on Db2 LUW accesses remote data from Db2 z/OS by using a federated trusted context. The connection for PERSON1 is established through a proxy user if the connection originates from the IP address or domain name that is specified in the trusted context definition. After the connection is established, PERSON1's corresponding Db2 z/OS user ID is switched without re-authentication, and the user can access the data or objects based on the Db2 privileges set up for that user.

### *Benefits of federated trusted contexts*

- This approach maintains the principle of least privilege by eliminating the use of a common user ID or application ID that would need a superset of all the privileges required by all users.
- The real identity of the user who performs the transaction on both the federated and remote database is always known and can be audited.
- Performance improves because the physical connection is being reused across the users without the need for the federated server to re-authenticate.

# Send notifications for an Amazon RDS for SQL Server database instance by using an on-premises SMTP server and Database Mail

Created by Nishad Mankar (AWS)

**Environment:** PoC or pilot

**Technologies:** Databases;  
Management & governance

**Workload:** Microsoft

**AWS services:** Amazon RDS

## Summary

[Database Mail](#) (Microsoft documentation) sends email messages, such as notifications or alerts, from a Microsoft SQL Server database by using a Simple Mail Transfer Protocol (SMTP) server. The Amazon Relational Database Service (Amazon RDS) for Microsoft SQL Server documentation provides instructions for using Amazon Simple Email Service (Amazon SES) as the SMTP server for Database Mail. For more information, see [Using Database Mail on Amazon RDS for SQL Server](#). As an alternative configuration, this pattern explains how to configure Database Mail to send email from an Amazon RDS for SQL Server database (DB) instance by using an on-premises SMTP server as the mail server.

## Prerequisites and limitations

### Prerequisites

- An active AWS account
- An Amazon RDS DB instance running a Standard or Enterprise edition of SQL Server
- The IP address or hostname of the on-premises SMTP server
- An inbound [security group rule](#) that allows connections to the Amazon RDS for SQL Server DB instance from the IP address of the SMTP server
- A connection, such as an [AWS Direct Connect](#) connection, between your on-premises network and the virtual private cloud (VPC) that contains the Amazon RDS DB instance

## Limitations

- Express editions of SQL Server aren't supported.
- For more information about limitations, see [Limitations](#) in *Using Database Mail on Amazon RDS for SQL Server* in the Amazon RDS documentation.

## Product versions

- Standard and Enterprise editions of [SQL Server versions supported in RDS](#)

## Architecture

### Target technology stack

- Amazon RDS for SQL Server database instance
- Amazon Route 53 forwarding rule
- Database Mail
- On-premises SMTP server
- Microsoft SQL Server Management Studio (SSMS)

### Target architecture

The following image shows the target architecture for this pattern. When an event or action occurs that initiates a notification or alert regarding the database instance, Amazon RDS for SQL Server uses Database Mail to send an email notification. Database Mail uses the on-premises SMTP server to send the email.

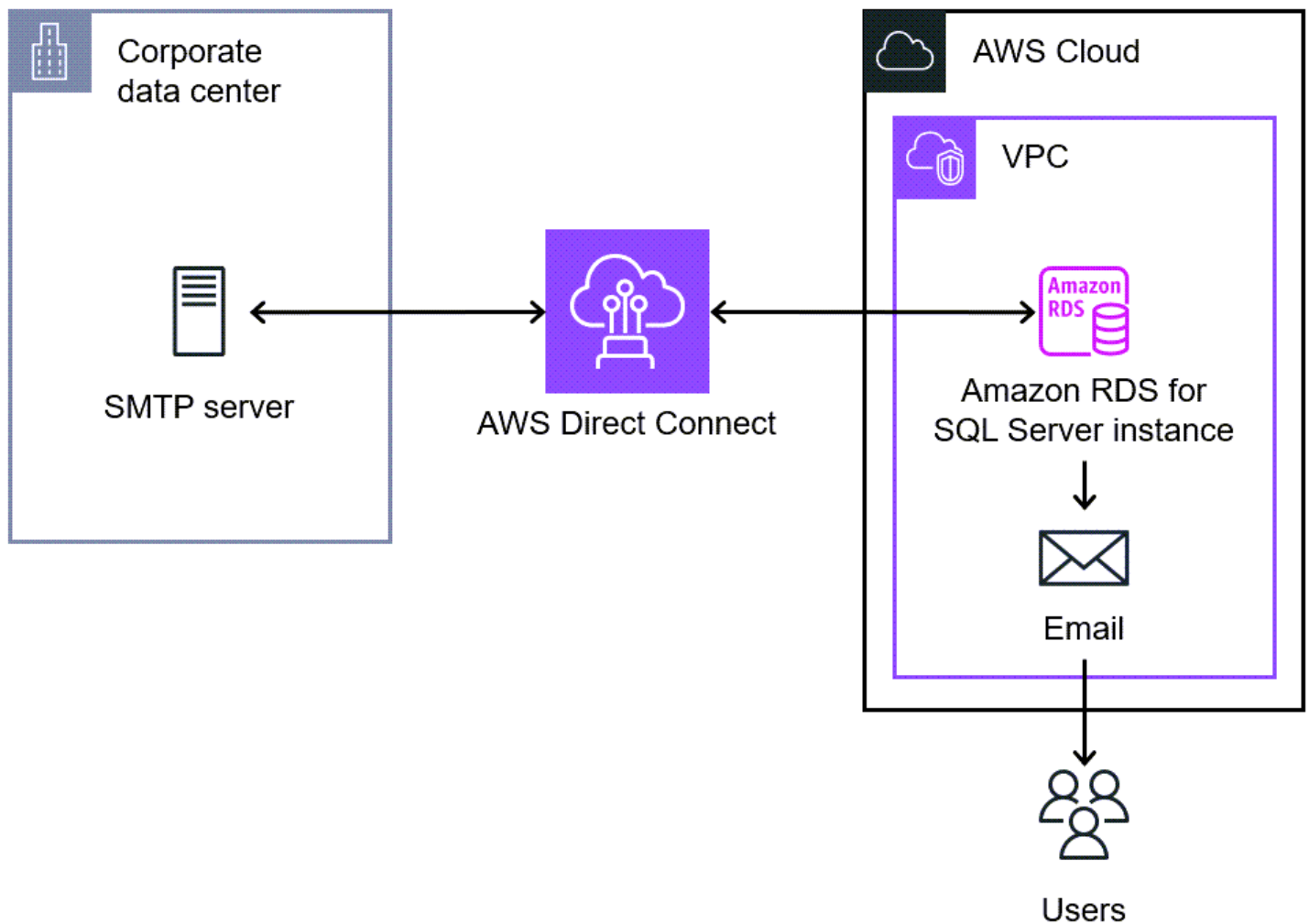

## Tools

### AWS services

- [Amazon Relational Database Service \(Amazon RDS\) for Microsoft SQL Server](#) helps you set up, operate, and scale a SQL Server relational database in the AWS Cloud.
- [Amazon Route 53](#) is a highly available and scalable DNS web service.

### Other tools

- [Database Mail](#) is a tool that sends e-mail messages, such as notifications and alerts, from the SQL Server Database Engine to users.
- [Microsoft SQL Server Management Studio \(SSMS\)](#) is a tool for managing SQL Server, including accessing, configuring, and administering SQL Server components. In this pattern, you use

SSMS to run the SQL commands to set up Database Mail on an Amazon RDS for SQL Server DB instance.

## Epics

### Enable network connectivity with the on-premises SMTP server

Task	Description	Skills required
Remove Multi-AZ from the RDS DB instance.	If you're using a Multi-Zone RDS DB instance, convert the Multi-AZ instance to a Single-AZ instance. When you have finished configuring Database Mail, you will convert the DB instance back to a Multi-AZ deployment. The Database Mail configuration then works in both the primary and secondary nodes. For instructions, see <a href="#">Removing Multi-AZ from a Microsoft SQL Server DB instance</a> .	DBA
Create an allow list for the Amazon RDS endpoint or IP address on the on-premises SMTP server.	The SMTP server is outside of the AWS network. On the on-premises SMTP server, create an allow list that permits the server to communicate with the outbound endpoint or IP address for the Amazon RDS instance or the Amazon Elastic Compute Cloud (Amazon EC2) instance hosted on Amazon RDS. This procedure varies from organization to organization.	DBA

Task	Description	Skills required
	For more information about the DB instance endpoint, see <a href="#">Finding the DB instance endpoint and port number</a> .	
Remove port 25 restrictions.	<p>By default, AWS restricts port 25 on EC2 instances. To remove the port 25 restriction, do the following:</p> <ol style="list-style-type: none"><li>1. Sign in with your AWS account, and then open the <a href="#">Request to remove email sending limitations form</a>.</li><li>2. Enter your email address so that AWS Support can contact you with updates about your request.</li><li>3. Provide the required information in the <b>Use case description</b> field.</li><li>4. Choose <b>Submit</b>.</li></ol> <p><b>Note:</b></p> <ul style="list-style-type: none"><li>• If you have instances in more than one AWS Region, then submit a separate request for each Region.</li><li>• It can take up to 48 hours to process your request.</li></ul>	General AWS

Task	Description	Skills required
Add a Route 53 rule to resolve DNS queries for the SMTP server.	Use Route 53 to resolve DNS queries between your AWS resources and the on-premises SMTP server. You must create a rule that forwards the DNS queries to the SMTP server domain, such as <code>example.com</code> . For instructions, see <a href="#">Creating forwarding rules</a> in the Route 53 documentation.	Network administrator

### Set up Database Mail on the Amazon RDS for SQL Server DB instance

Task	Description	Skills required
Enable Database Mail.	Create a parameter group for Database Mail, set the <code>database mail xps</code> parameter to 1, and then associate the Database Mail parameter group with the target RDS DB instance. For instructions, see <a href="#">Enabling Database Mail</a> in the Amazon RDS documentation. Do not proceed to the <i>Configuring Database Mail</i> section in these instructions. The configuration for the on-premises SMTP server differs from Amazon SES.	DBA



Task	Description	Skills required
Connect to the DB instance.	From a bastion host, use Microsoft SQL Server Management Studio (SSMS) to connect to the Amazon RDS for SQL Server database instance. For instructions, see <a href="#">Connecting to a DB instance running the Microsoft SQL Server database engine</a> . If you encounter any errors, see the connection troubleshooting references in the <a href="#">Related resources</a> section.	DBA

Task	Description	Skills required
Create the profile.	<p>In SSMS, enter the following SQL statement to create the Database Mail profile. Replace the following values:</p> <ul style="list-style-type: none"><li>• For <code>profile_name</code> , enter a name for the new profile.</li><li>• For <code>description</code> , enter a brief description of the new profile.</li></ul> <p>For more information about this stored procedure and its arguments, see <a href="#">sysmail_add_profile_sp</a> in the Microsoft documentation.</p> <pre>EXECUTE msdb.dbo.sysmail_add_profile_sp @profile_name = 'SQL Alerts profile', @description = 'Profile used for sending outgoing notifications using OM SMTP Server.';</pre>	DBA

Task	Description	Skills required
Add principals to the profile.	<p>Enter the following SQL statement to add public or private principals to the Database Mail profile. A <i>principal</i> is an entity that can request SQL Server resources. Replace the following values:</p> <ul style="list-style-type: none"><li>• For <code>profile_name</code> , enter the name of the profile you created previously.</li><li>• For <code>principal_name</code> , enter the name of the database user or role. This value must map to an SQL Server authentication user, a Windows Authentication user, or a Windows Authentication group.</li></ul> <p>For more information about this stored procedure and its arguments, see <a href="#">sysmail_add_principalprofile_sp</a> in the Microsoft documentation.</p> <pre>EXECUTE msdb.dbo. sysmail_add_princi palprofile_sp @profile_name = 'SQL Alerts profile', @principal_name = 'public', @is_default = 1 ;</pre>	DBA

Task	Description	Skills required
Create the account.	<p>Enter the following SQL statement to create the Database Mail account.</p> <p>Replace the following values:</p> <ul style="list-style-type: none"><li>• For <code>account_name</code> , enter a name for the new account.</li><li>• For <code>description</code> , enter a brief description of the new account.</li><li>• For <code>email_address</code> , enter the e-mail address to send the Database Mail messages from.</li><li>• For <code>display_address</code> , enter a display name to use for outgoing messages for this account, such as <code>SQL Server Automated Notification</code> . You can also use the value you entered for <code>email_address</code> .</li><li>• For <code>mailserver_name</code> , enter the name or IP address of the SMTP mail server.</li><li>• For <code>port</code>, leave the value of 25.</li><li>• For <code>enable_ssl</code> , leave the value at 1 or enter 0 if you don't want Database</li></ul>	DBA

Task	Description	Skills required
	<p>Mail to encrypt communication by using SSL.</p> <ul style="list-style-type: none"><li>• For <code>username</code>, enter the username for logging on to the SMTP mail server. If the server doesn't require authentication, enter <code>NULL</code>.</li><li>• For <code>password</code>, enter the password for logging on to the SMTP mail server. If the server doesn't require authentication, enter <code>NULL</code>.</li></ul> <p>For more information about this stored procedure and its arguments, see <a href="#">sysmail_add_account_sp</a> in the Microsoft documentation.</p> <pre>EXECUTE msdb.dbo. sysmail_add_account_sp @account_name = 'SQL Alerts account', @description = 'Database Mail account for sending outgoing notifications.', @email_address = 'xyz@example.com', @display_name = 'xyz@example.com', @mailserver_name = 'test_smtp.example .com', @port = 25, @enable_ssl = 1,</pre>	

Task	Description	Skills required
	<pre>@username = 'SMTP-use rname', @password = 'SMTP-pas sword';</pre>	
Add the account to the profile.	<p>Enter the following SQL statement to add the Database Mail account to the Database Mail profile. Replace the following values:</p> <ul style="list-style-type: none"><li>• For <code>profile_name</code> , enter the name of the profile you created previously.</li><li>• For <code>account_name</code> , enter the name of the account you created previously.</li></ul> <p>For more information about this stored procedure and its arguments, see <a href="#">sysmail_add_profileaccount_sp</a> in the Microsoft documentation.</p> <pre>EXECUTE msdb.dbo. sysmail_add_profil eaccount_sp @profile_name = 'SQL Alerts profile', @account_name = 'SQL Alerts account', @sequence_number = 1;</pre>	DBA

Task	Description	Skills required
(Optional) Add Multi-AZ to the RDS DB instance.	If you want to add Multi-AZ with Database Mirroring (DBM) or Always On Availability Groups (AGs), see the instructions in <a href="#">Adding Multi-AZ to a Microsoft SQL Server DB instance</a> .	DBA

## Related resources

- [Using Database Mail on Amazon RDS for SQL Server](#) (Amazon RDS documentation)
- [Working with file attachments](#) (Amazon RDS documentation)
- [Troubleshooting connections to your SQL Server DB instance](#) (Amazon RDS documentation)
- [Can't connect to Amazon RDS DB instance](#) (Amazon RDS documentation)

# Set up disaster recovery for SAP on IBM Db2 on AWS

Created by Ambarish Satarkar (AWS) and Debasis Sahoo (AWS)

**Environment:** Production

**Technologies:** Databases;  
Operations

**Workload:** SAP

**AWS services:** Amazon EC2;  
AWS Elastic Disaster Recovery

## Summary

This pattern outlines the steps to set up a disaster recovery (DR) system for SAP workloads with IBM Db2 as the database platform, running on the Amazon Web Services (AWS) Cloud. The objective is to provide a low-cost solution for providing business continuity in the event of an outage.

The pattern uses the [pilot light approach](#). By implementing pilot light DR on AWS, you can reduce downtime and maintain business continuity. The pilot light approach focuses on setting up a minimal DR environment in AWS, including an SAP system and a standby Db2 database, that is synchronized with the production environment.

This solution is scalable. You can extend it to a full-scale disaster recovery environment as needed.

## Prerequisites and limitations

### Prerequisites

- An SAP instance running on an Amazon Elastic Compute Cloud (Amazon EC2) instance
- An IBM Db2 database
- An operating system that is supported by the SAP Product Availability Matrix (PAM)
- Different physical database hostnames for production and standby database hosts
- An Amazon Simple Storage Service (Amazon S3) bucket in each AWS Region with [Cross-Region Replication \(CRR\)](#) enabled

### Product versions



- IBM Db2 Database version 11.5.7 or later

## Architecture

### Target technology stack

- Amazon EC2
- Amazon Simple Storage Service (Amazon S3)
- Amazon Virtual Private Cloud (VPC peering)
- Amazon Route 53
- IBM Db2 High Availability Disaster Recovery (HADR)

### Target architecture

This architecture implements a DR solution for SAP workloads with Db2 as the database platform. The production database is deployed in AWS Region 1 and a standby database is deployed in a second Region. The standby database is referred to as the DR system. Db2 Database supports multiple standby databases (up to three). It uses Db2 HADR for setting up the DR database and automating log shipping between the production and standby databases.

In the event of a disaster that makes Region 1 unavailable, the standby database in the DR Region takes over the production database role. SAP application servers can be built in advance or by using [AWS Elastic Disaster Recovery](#) or an Amazon Machine Image (AMI) to meet the recovery time objective (RTO) requirements. This pattern uses an AMI.

Db2 HADR implements a production-standby setup, where production acts as the primary server, and all users are connected to it. All transactions are written to log files, which are transferred to the standby server by using TCP/IP. The standby server updates its local database by rolling forward the transferred log records, which helps to ensure that it is kept in sync with the production server.

VPC peering is used so that instances in the production Region and DR Region can communicate with each other. Amazon Route 53 routes end users to internet applications.

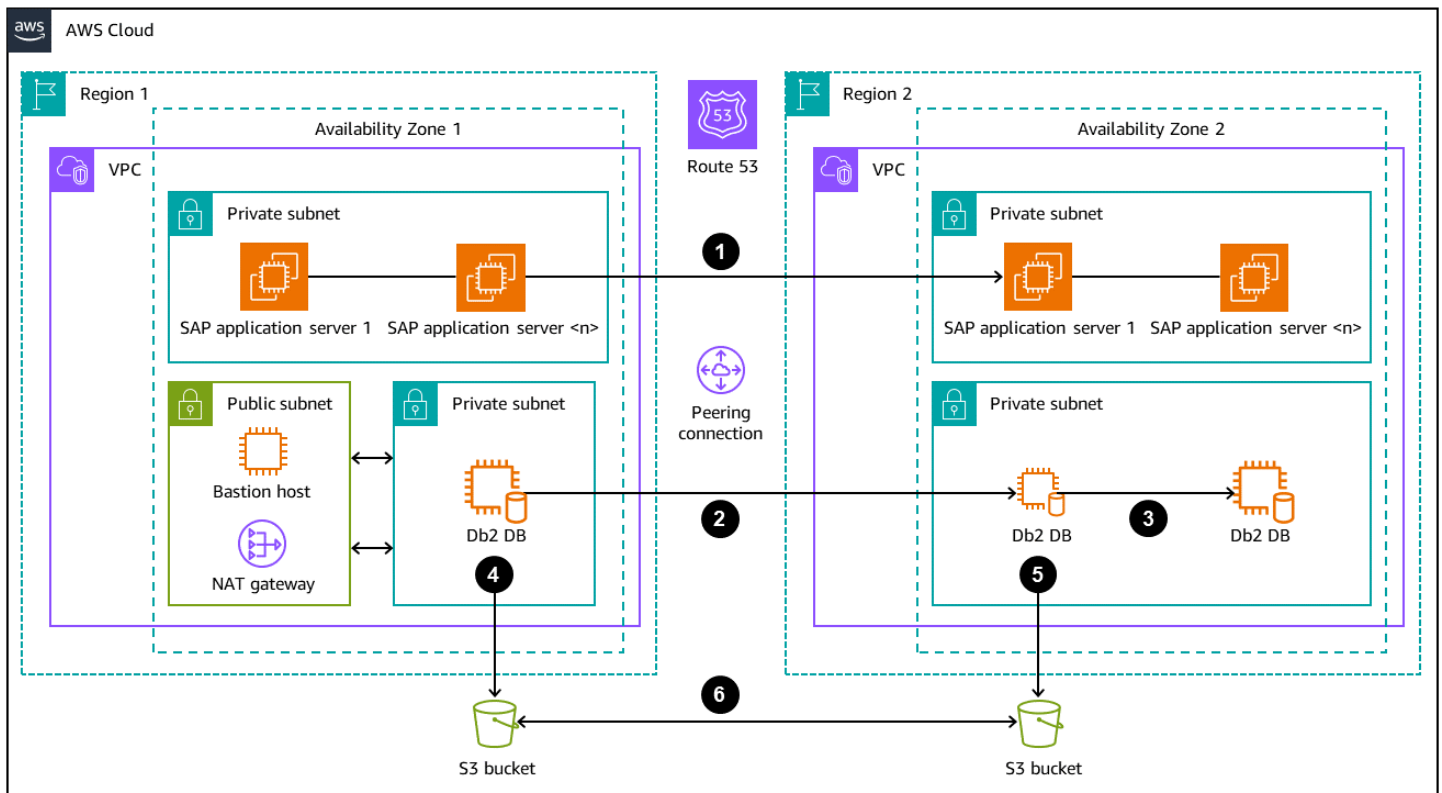

1. [Create an AMI](#) of the application server in Region 1 and [copy the AMI](#) to Region 2. Use the AMI to launch servers in Region 2 in the event of a disaster.
2. Set up Db2 HADR replication between the production database (in Region 1) and the standby database (in Region 2).
3. Change the EC2 instance type to match the production instance in the event of a disaster.
4. In Region 1, LOGARCHMETH1 is set to db2remote: S3 path.
5. In Region 2, LOGARCHMETH1 is set to db2remote: S3 path.
6. Cross-Region Replication is performed between the S3 buckets.

## Tools

### AWS services

- [Amazon Elastic Compute Cloud \(Amazon EC2\)](#) provides scalable computing capacity in the AWS Cloud. You can launch as many virtual servers as you need and quickly scale them up or down.
- [Amazon Route 53](#) is a highly available and scalable DNS web service.

- [Amazon Simple Storage Service \(Amazon S3\)](#) is a cloud-based object storage service that helps you store, protect, and retrieve any amount of data.
- [Amazon Virtual Private Cloud \(Amazon VPC\)](#) helps you launch AWS resources into a virtual network that you've defined. This virtual network resembles a traditional network that you'd operate in your own data center, with the benefits of using the scalable infrastructure of AWS. This pattern uses [VPC peering](#).

## Best practices

- The network plays a key role in deciding the HADR replication mode. For DR across AWS Regions, we recommend that you use Db2 HADR ASYNC or SUPERASYNC mode.
- For more information about replication modes for Db2 HADR, see the [IBM documentation](#).
- You can use the AWS Management Console or the AWS Command Line Interface (AWS CLI) to [create a new AMI](#) of your existing SAP system. You can then use the AMI to recover your existing SAP system or to create a clone.
- [AWS Systems Manager Automation](#) can help with the common maintenance and deployment tasks of EC2 instances and other AWS resources.
- AWS provides multiple native services to monitor and manage your infrastructure and applications on AWS. Services such as Amazon CloudWatch and AWS CloudTrail can be used to monitor your underlying infrastructure and API operations, respectively. For more details, see [SAP on AWS – IBM Db2 HADR with Pacemaker](#).

## Epics

### Prepare the environment

Task	Description	Skills required
Check the system and logs.	<ol style="list-style-type: none"> <li>1. Confirm that the production SAP on Db2 system is set up.</li> <li>2. Confirm that log backup is turned on and configured to save the logs in the S3 bucket. This can</li> </ol>	AWS administrator, SAP Basis administrator

Task	Description	Skills required
	<p>be checked by the Db2 parameter LOGARCHMETH1 .</p> <p>3. Create an AMI of the additional application server.</p>	

## Set up the servers and replication

Task	Description	Skills required
<p>Create the SAP and database servers.</p>	<ol style="list-style-type: none"> <li>1. To deploy the infrastructure for the DR Region, use an AWS CloudFormation script or use an AMI of the production instance. As a part of the pilot light approach, you can use a smaller EC2 instance in the same family as the production instance. For example, if your production instance type is <code>r6i.12xlarge</code> , you can use the <code>r6i.xlarge</code> instance type for the DR build. However, make sure that you allocate the same storage capacity on the DR instance to restore the production database backup.</li> <li>2. Create Amazon Elastic File System (Amazon</li> </ol>	<p>SAP Basis administrator</p>

Task	Description	Skills required
	<p>EFS) mount points for /sapmnt/&lt;SID&gt;/ , and make sure that it is <a href="#">set to be replicated</a> from the primary system.</p> <ol style="list-style-type: none"><li data-bbox="592 457 998 730">3. Take a FULL database backup (online or offline) from the production system. You will use this backup to build the DR database.</li><li data-bbox="592 751 1031 1129">4. In the DR system, use the SAP Software Provisioning Manager (SWPM) system copy method with <b>Using system copy with backup/restore for HA/DR purposes</b> to build the DR SAP system.</li><li data-bbox="592 1150 1015 1470">5. When asked by SWPM, restore the database in DR with the backup that you took from the production. The DR database will be in the rollforward pending state.</li></ol> <p>The rollforward pending state is set by default after the full backup is restored. The rollforward pending state indicates that the database is in the process of being restored and that some</p>	

Task	Description	Skills required
	changes might need to be applied. For more information, see the <a href="#">IBM documentation</a> .	

Task	Description	Skills required
Check the configuration.	<p>1. To set up log archiving for HADR, both the production and DR databases must be able to retrieve logs automatically from all log archive locations. Verify that the LOGARCHMETH1 parameter in the DR database is set to the same location as in the production database. If the same location is not accessible because of Regional limitations, ensure that the DR system can automatically fetch logs from the primary system.</p> <p>2. To enable TCP/IP ports for database replication enablement, modify <code>etc/services</code> in the production and DR hosts by adding the following two entries. In the code, <code>&lt;SID&gt;</code> refers to the System ID (SID) of the Db2 database (for example, PR1).</p> <pre data-bbox="630 1598 1029 1877" style="border: 1px solid #ccc; border-radius: 10px; padding: 10px;"> &lt;SID&gt;_HADR_1 55001/tcp          # DB2 HADR Port1 &lt;SID&gt;_HADR_2 55002/tcp          # DB2 HADR Port2 </pre>	AWS administrator, SAP Basis administrator

Task	Description	Skills required
	<p>Confirm that both ports allow inbound and outbound traffic between both the primary and the standby.</p> <p>3. Check <code>/etc/hosts</code> in the production and DR hosts to confirm that hostnames for both production and standby hosts are pointing to the correct IP addresses.</p>	



Task	Description	Skills required
Set up replication from the production DB to the DR DB (using ASYNC mode).	<p>1. In the production database, run the following commands to update the parameters.</p> <pre data-bbox="630 443 1029 1713"> db2 UPDATE DB CFG FOR   &lt;SID&gt; USING HADR_LOCAL_HOST HOST1 db2 UPDATE DB CFG FOR   &lt;SID&gt; USING HADR_LOCAL_SVC &lt;SID&gt;_HADR_1 db2 UPDATE DB CFG FOR   &lt;SID&gt; USING HADR_REMOTE_HOST HOST2 db2 UPDATE DB CFG FOR   &lt;SID&gt; USING HADR_REMOTE_SVC &lt;SID&gt;_HADR_2 db2 UPDATE DB CFG FOR   &lt;SID&gt; USING HADR_REMOTE_INST db2&lt;sid&gt; db2 UPDATE DB CFG FOR   &lt;SID&gt; USING HADR_TIMEOUT 120 db2 UPDATE DB CFG FOR   &lt;SID&gt; USING HADR_SYNC_MODE ASYNC db2 UPDATE DB CFG FOR   &lt;SID&gt; USING HADR_SPOOL_LIMIT 1000 db2 UPDATE DB CFG FOR   &lt;SID&gt; USING HADR_PEER_WINDOW 240 db2 UPDATE DB CFG FOR   &lt;SID&gt; USING indexrec   RESTART logindexb   uild ON </pre> <p>2. In the DR database, run the following commands to update the parameters.</p>	SAP Basis administrator

Task	Description	Skills required
	<pre> db2 UPDATE DB CFG FOR &lt;SID&gt; USING HADR_LOCA L_HOST HOST2 db2 UPDATE DB CFG FOR &lt;SID&gt; USING HADR_LOCA L_SVC &lt;SID&gt;_HADR_2 db2 UPDATE DB CFG FOR &lt;SID&gt; USING HADR_REMO TE_HOST HOST1 db2 UPDATE DB CFG FOR &lt;SID&gt; USING HADR_REMO TE_SVC &lt;SID&gt;_HADR_1 db2 UPDATE DB CFG FOR &lt;SID&gt; USING HADR_REMO TE_INST db2&lt;sid&gt; db2 UPDATE DB CFG FOR &lt;SID&gt; USING HADR_TIME OUT 120 db2 UPDATE DB CFG FOR &lt;SID&gt; USING HADR_SYNC MODE ASYNC db2 UPDATE DB CFG FOR &lt;SID&gt; USING HADR_SPOO L_LIMIT 1000 db2 UPDATE DB CFG FOR &lt;SID&gt; USING HADR_PEER _WINDOW 240 db2 UPDATE DB CFG FOR &lt;SID&gt; USING indexrec RESTART logindexb uild ON </pre> <p>These parameters are required to provide HADR-related information to both databases. In the Db2 database, HADR gets activated based on the values for each of the</p>	

Task	Description	Skills required
	<p>previously set parameter <code>s</code>. For more information about these parameters, see the <a href="#">IBM documentation</a>.</p> <p>3. Start HADR first on the newly created standby database by using the following command.</p> <pre data-bbox="630 674 1029 873">db2 deactivate db &lt;SID&gt; db2 start hadr on db &lt;SID&gt; as standby</pre> <p>4. Start HADR on the production database by using the following command.</p> <pre data-bbox="630 1104 1029 1304">db2 deactivate db &lt;SID&gt; db2 start hadr on db &lt;SID&gt; as primary</pre> <p>5. Check whether the production and standby Db2 databases are in sync and log shipping is ongoing.</p> <p>To monitor HADR replication status, use the following <code>db2pd</code> command.</p> <pre data-bbox="630 1801 1029 1877">db2pd -d &lt;SID&gt; -hadr</pre>	

Task	Description	Skills required
	For more information about monitoring HADR, see the <a href="#">IBM documentation</a> .	

## Test DR failover tasks

Task	Description	Skills required
Plan the production business downtime for the DR test.	Make sure that you plan the required business downtime on production environment for testing the DR failover scenario.	SAP Basis administrator
Create a test user.	Create a test user (or any test changes) that can be validated in the DR host to confirm log replication after DR failover.	SAP Basis administrator
On the console, stop the production EC2 instances.	Ungraceful shutdown is initiated in this step to mimic a disaster scenario.	AWS systems administrator
Scale up the DR EC2 instance to match the requirements.	On the EC2 console, change the instance type in the DR Region.  1. Stop the instance: If the instance is running, you must stop it before you can change its instance type. On the EC2 console, select	SAP Basis Admin

Task	Description	Skills required
	<p>the instance, and choose <b>Stop</b>.</p> <p>2. Modify the instance type: On the EC2 console, select the instance, and choose <b>Actions, Instance Settings, Change Instance Type</b>. Select the instance type that matches the primary instance, and choose <b>Apply</b>.</p> <p>3. Start the instance: After the instance type change is complete, start the instance from the EC2 console by selecting the instance and choosing <b>Start</b>.</p> <p>4. To start the Db2 database, use the following command.</p> <pre data-bbox="630 1266 1029 1423">db2start       db2 start HADR on       db &lt;SID&gt; as standby</pre>	

Task	Description	Skills required
Initiate takeover.	<p>From the DR system (host 2), initiate the take-over process and bring up the DR database as the primary.</p> <pre data-bbox="597 443 1029 562">db2 takeover hadr on database &lt;SID&gt; by force</pre> <p>Optionally, you can set the following parameters to adjust database memory allocation automatically based on the instance type. The INSTANCE_MEMORY value can be decided based on the dedicated portion of memory to be allocated to the Db2 database.</p> <pre data-bbox="597 1102 1029 1577">db2 update db cfg for &lt;SID&gt; using INSTANCE_ MEMORY &lt;FIXED VALUE&gt; IMMEDIATE; db2 get db cfg for &lt;SID&gt;   grep -i DATABASE_ MEMORY AUTOMATIC IMMEDIATE; db2 update db cfg for &lt;SID&gt; using self_tuni ng_mem ON IMMEDIATE;</pre> <p>Verify the change by using the following commands.</p> <pre data-bbox="597 1738 1029 1829">db2 get db cfg for &lt;SID&gt;   grep -i MEMORY</pre>	SAP Basis administrator

Task	Description	Skills required
	<pre>db2 get db cfg for &lt;SID&gt;   grep -i self_tuning_mem</pre>	
<p>Launch the application server for SAP in the DR Region.</p>	<p>Using the AMI that you made of the production system, <a href="#">launch a new additional application server</a> in the DR Region.</p>	<p>SAP Basis administrator</p>
<p>Perform validation before starting the SAP application.</p>	<ol style="list-style-type: none"> <li>1. Validate the <code>/etc/hosts</code> and <code>/etc/fstab</code> entries.</li> <li>2. Mount <code>/sapmnt/&lt;SID&gt;/</code> on the DR system.</li> <li>3. Validate that the DR file system <code>/sapmnt/&lt;SID&gt;/</code> is synced with the production <code>/sapmnt/&lt;SID&gt;/</code>.</li> <li>4. Log in to <code>&lt;sid&gt;adm</code> user, run <code>R3trans -d</code>, and verify the output in the <code>trans.log</code> file. The <code>trans.log</code> file is generated in the same location where you ran the <code>R3trans -d</code> command.</li> </ol>	<p>AWS administrator, SAP Basis administrator</p>

Task	Description	Skills required
<p>Start the SAP application on the DR system.</p>	<p>Start the SAP application on the DR system by using &lt;sid&gt;adm user. Use the following code, in which XX represents the instance number of your SAP ABAP SAP Central Services (ASCS) server, and YY represents the instance number of your SAP application server.</p> <pre data-bbox="597 730 1026 1167"> sapcontrol -nr XX - function StartService &lt;SID&gt; sapcontrol -nr XX - function StartSystem sapcontrol -nr YY - function StartService &lt;SID&gt; sapcontrol -nr YY - function StartSystem </pre>	<p>SAP Basis administrator</p>
<p>Perform SAP validation.</p>	<p>This is performed as a DR test to provide evidence or to check the data replication success to the DR Region.</p>	<p>Test engineer</p>

### Perform DR failback tasks

Task	Description	Skills required
<p>Start the production SAP and database servers.</p>	<p>On the console, start the EC2 instances that host SAP and the database in the production system.</p>	<p>SAP Basis administrator</p>



Task	Description	Skills required
Start the production database and set up HADR.	<p>Log in to production system (host1) and verify that the DB is in recovery mode by using the following command.</p> <pre>db2start db2 start HADR on db P3V as standby db2 connect to &lt;SID&gt;</pre> <p>Verify that the HADR status is connected . Replication status should be peer.</p> <pre>db2pd -d &lt;SID&gt; -hadr</pre> <p>If the database is not inconsistent and is not at connected and peer status, a backup and restore might be required to bring the database (on host1) in sync with the currently active database (host2 in the DR Region). In that case, restore the DB backup from the database in the host2 DR Region to the database in the host1 production Region.</p>	SAP Basis administrator

Task	Description	Skills required
Fail back the database to the production Region.	<p>In a normal business-as-usual scenario, this step is performed in a scheduled downtime. Applications running on the DR system are stopped, and the database is failed back to the production Region (Region 1) to resume operations from the production Region.</p> <ol style="list-style-type: none"><li>1. Log in to the SAP application server in the DR Region, and stop the SAP application.</li><li>2. Unmount <code>/sapmnt/&lt;SID&gt;</code> from the DR system, making sure that the changes are reverse-replicated to <code>/sapmnt/&lt;SID&gt;</code> of the production system.</li><li>3. Log in to the database server (host1) in the production Region, and perform the takeover. <div data-bbox="630 1495 1029 1612" style="border: 1px solid #ccc; border-radius: 10px; padding: 10px; margin: 10px 0;"><pre>db2 takeover hadr on database &lt;SID&gt;</pre></div></li><li>4. Check the HADR status: <code>HADR_ROLE</code> should be <code>PRIMARY</code> on host1 and <code>StandBy</code> on host2.</li></ol>	SAP Basis administrator

Task	Description	Skills required
	<pre>db2pd -d &lt;SID&gt; -hadr</pre>	
Perform validation before starting the SAP application.	<ol style="list-style-type: none"><li>1. Validate the <code>/etc/hosts</code> and <code>/etc/fstab</code> entries.</li><li>2. Mount <code>/sapmnt/&lt;SID&gt;/</code> on the production system.</li><li>3. Make sure it is in sync with the DR system <code>/sapmnt/&lt;SID&gt;/</code>.</li><li>4. Log in to <code>&lt;sid&gt;adm</code> user, run <code>R3trans -d</code>, and verify the output in the <code>trans.log</code> file. The <code>trans.log</code> file is generated in the same location where you ran the <code>R3trans -d</code> command.</li></ol>	AWS administrator, SAP Basis administrator

Task	Description	Skills required
Start the SAP application.	<p>1. Start the SAP application on the production system using &lt;sid&gt;adm user. Use the following code, in which XX represents the instance number of your SAP ASCS server, and YY represents the instance number of your SAP application server.</p> <pre data-bbox="630 730 1029 1167"> sapconrol -nr XX - function StartService &lt;SID&gt; sapconrol -nr XX - function StartSystem sapconrol -nr YY - function StartService &lt;SID&gt; sapconrol -nr YY - function StartSystem </pre> <p>2. To confirm that applicati on servers are available, log in to SAP and perform checks by using the SICK and SM51 transactions.</p>	SAP Basis administrator

## Troubleshooting

Issue	Solution
Key log files and commands to troubleshoot HADR-related issues	<ul style="list-style-type: none"> <li>• <code>db2 get db cfg   grep -i hadr</code></li> <li>• <code>db2pd -d sid -hadr</code></li> </ul>

Issue	Solution
	<ul style="list-style-type: none"><li>• <code>Db2diag.log</code> (This file is generally located inside the <code>db2dump</code> directory, and the <code>db2dump</code> path is defined by the parameter <code>DIAGPATH</code>.)</li></ul>
SAP note for troubleshooting HADR issues on Db2 UDB	Refer to SAP <a href="#">Note 1154013 - DB6: DB problems in HADR environment</a> . (You need SAP portal credentials to access this note.)

## Related resources

- [Disaster recovery approaches for Db2 databases on AWS](#) (blog post)
- [SAP on AWS – IBM Db2 HADR with Pacemaker](#)
- [Step by Step Procedure to set up HADR replication between DB2 databases](#)
- [Db2 HADR Wiki](#)

## Additional information

Using this pattern, you can set up a disaster recovery system for an SAP system running on the Db2 database. In a disaster situation, business should be able to continue within your defined recovery time objective (RTO) and recovery point objective (RPO) requirements:

- **RTO** is the maximum acceptable delay between the interruption of service and restoration of service. This determines what is considered an acceptable time window when service is unavailable.
- **RPO** is the maximum acceptable amount of time since the last data recovery point. This determines what is considered an acceptable loss of data between the last recovery point and the interruption of service.

For FAQs related to HADR, see [SAP note #1612105 - DB6: FAQ on Db2 High Availability Disaster Recovery \(HADR\)](#). (You need SAP portal credentials to access this note.)

# Set up a CI/CD pipeline for database migration by using Terraform

*Created by Dr. Rahul Sharad Gaikwad (AWS), Aarti Rajput (AWS), Ashish Bhatt (AWS), Aniket Dekate (AWS), Naveen Suthar (AWS), Nadeem Rahaman (AWS), Ruchika Modi (AWS), and Tamilselvan P (AWS)*

**Environment:** PoC or pilot

**Technologies:** Databases;  
DevOps; Migration

**Workload:** Microsoft

**AWS services:** AWS  
CodePipeline; AWS DMS;  
Amazon RDS

## Summary

This pattern is about establishing a continuous integration and continuous deployment (CI/CD) pipeline for managing database migrations in a reliable and automated manner. It covers the process of provisioning the necessary infrastructure, migrating data, and customizing schema changes by using Terraform, which is an infrastructure as code (IaC) tool.

Specifically, the pattern sets up a CI/CD pipeline to migrate an on-premises Microsoft SQL Server database to Amazon Relational Database Service (Amazon RDS) on AWS. You can also use this pattern to migrate a SQL Server database that's on a virtual machine (VM) or in another cloud environment to Amazon RDS.

This pattern addresses the following challenges associated with database management and deployment:

- Manual database deployments are time-consuming, error-prone, and lack consistency across environments.
- Coordinating infrastructure provisioning, data migrations, and schema changes can be complex and difficult to manage.
- Ensuring data integrity and minimizing downtime during database updates is crucial for production systems.

This pattern provides the following benefits:

- Streamlines the process of updating and deploying database changes by implementing a CI/CD pipeline for database migrations. This reduces the risk of errors, ensures consistency across environments, and minimizes downtime.
- Helps improve reliability, efficiency, and collaboration. Enables faster time to market and reduced downtime during database updates.
- Helps you adopt modern DevOps practices for database management, which leads to increased agility, reliability, and efficiency in your software delivery processes.

## Prerequisites and limitations

### Prerequisites

- An active AWS account
- Terraform 0.12 or later installed on your local machine (for instructions, see the [Terraform documentation](#))
- Terraform AWS Provider version 3.0.0 or later from HashiCorp (see the [GitHub repository](#) for this provider)
- Least privilege AWS Identity and Access Management (IAM) policy (see the blog post [Techniques for writing least privilege IAM policies](#))

## Architecture

This pattern implements the following architecture, which provides the complete infrastructure for the database migration process.

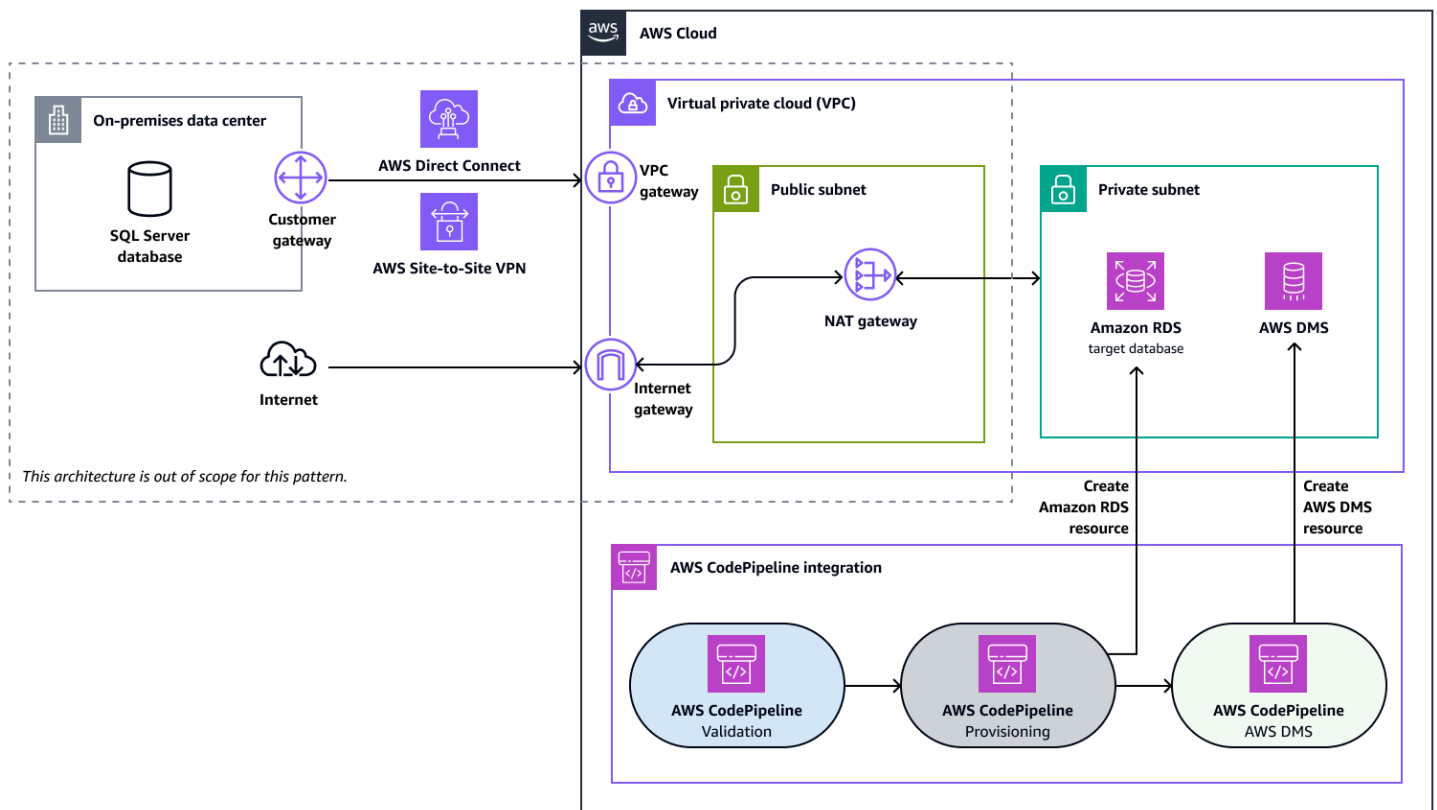

In this architecture:

- The source database is a SQL Server database that is on premises, on a virtual machine (VM), or hosted by another cloud provider. The diagram assumes that the source database is in an on-premises data center.
- The on-premises data center and AWS are connected through a VPN or AWS Direct Connect connection. This provides secure communications between the source database and the AWS infrastructure.
- The target database is an Amazon RDS database that is hosted inside the virtual private cloud (VPC) on AWS with the help of a database provisioning pipeline.
- AWS Database Migration Service (AWS DMS) replicates your on-premises database to AWS. It is used to configure the replication of the source database to the target database.

The following diagram shows the infrastructure set up with different levels of the database migration process, which involves provisioning, AWS DMS setup, and validation.



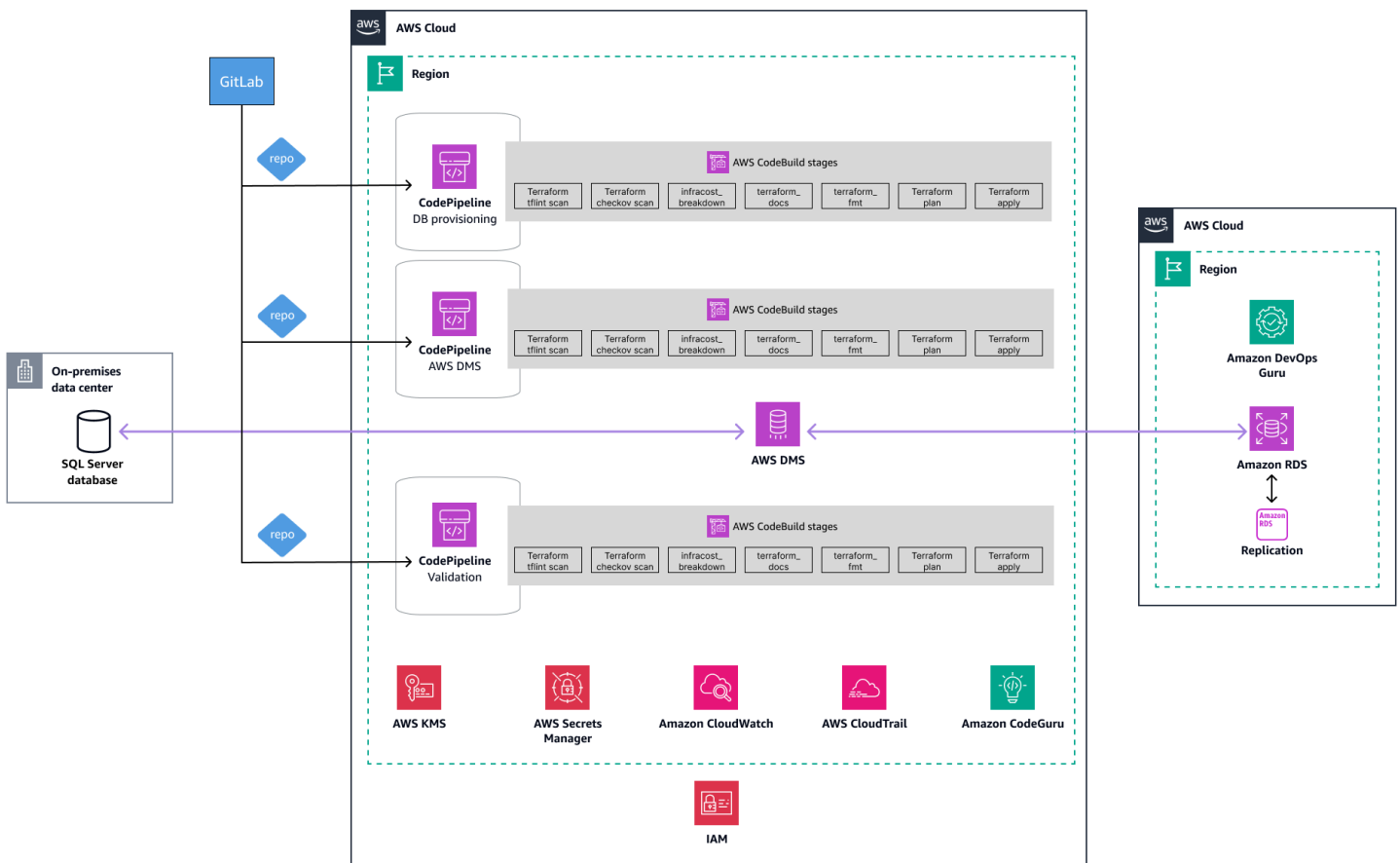

In this process:

- The validation pipeline validates all checks. The integrated pipeline moves to the next step when all necessary validations are complete.
- The DB provisioning pipeline consists of various AWS CodeBuild stages that perform Terraform actions on the provided Terraform code for the database. When these steps are complete, it deploys resources in the target AWS account.
- The AWS DMS pipeline consists of various CodeBuild stages that perform tests and then provision the AWS DMS infrastructure for performing the migration by using IaC.

## Tools

### AWS services and tools

- [AWS CodeBuild](#) is a fully managed continuous integration service that compiles source code, runs tests, and produces ready-to-deploy software packages.

- [AWS CodePipeline](#) is a fully managed continuous delivery service that helps you automate your release pipelines for fast and reliable application and infrastructure updates.
- [Amazon Relational Database Service \(Amazon RDS\)](#) helps you set up, operate, and scale a relational database in the AWS Cloud.
- [Amazon Simple Storage Service \(Amazon S3\)](#) is an object storage service that offers scalability, data availability, security, and performance.
- [AWS Database Migration Service \(AWS DMS\)](#) helps you migrate data stores into the AWS Cloud or between combinations of cloud and on-premises setups.

### Other services

- [Terraform](#) is an IaC tool from HashiCorp that helps you create and manage cloud and on-premises resources.

### Code repository

The code for this pattern is available in the GitHub [Database Migration DevOps Framework using Terraform samples](#) repository.

### Best practices

- Implement automated tests for your database migration to verify the correctness of schema changes and data integrity. This includes unit tests, integration tests, and end-to-end tests.
- Implement a robust backup and restore strategy for your databases, especially before migration. This ensures data integrity and provides a fallback option in case of failures.
- Implement a robust rollback strategy to revert database changes in case of failures or issues during migration. This could involve rolling back to a previous database state or reverting individual migration scripts.
- Set up monitoring and logging mechanisms to track the progress and status of database migrations. This helps you identify and resolve issues quickly.

# Epics

## Set up your local workstation

Task	Description	Skills required
Set up and configure Git on your local workstation.	Install and configure Git on your local workstation by following the instructions in the <a href="#">Git documentation</a> .	DevOps engineer
Create a project folder and add the files from the GitHub repository.	<ol style="list-style-type: none"><li>1. Open the <a href="#">GitHub repository</a> for this pattern.</li><li>2. Choose <b>Code</b> to see cloning options, and copy the URL provided in the HTTPS tab.</li><li>3. Create a folder for your project on your workstation.</li><li>4. Open a terminal and navigate to this folder.</li><li>5. Clone the GitHub repository:<pre>git clone &lt;github-repository-url&gt;</pre>where <code>&lt;github-repository-url&gt;</code> is the URL you copied in step 2.</li><li>6. When cloning is complete, go to the cloned repository in your project folder:<pre>cd &lt;folder-name&gt;/aws-terraform-db-migra</pre></li></ol>	DevOps engineer

Task	Description	Skills required
	<pre>tion-framework-samples</pre> <p>7. Open this project in an integrated development environment (IDE) of your choice.</p>	

## Provision the target architecture

Task	Description	Skills required
Update required parameters.	<p>The <code>ssm-parameters.sh</code> file stores all required AWS Systems Manager parameters. You can configure these parameters with the custom values for your project.</p> <p>In the <code>setup/db-ssm-params</code> folder on your local workstation, open the <code>ssm-parameters.sh</code> file and set these parameters before you run the CI/CD pipeline.</p>	DevOps engineer
Initialize the Terraform configuration.	<p>In the <code>db-cicd-integration</code> folder, enter the following command to initialize your working directory that contains the Terraform configuration files:</p> <pre>terraform init</pre>	DevOps engineer

Task	Description	Skills required
Preview the Terraform plan.	<p>To create a Terraform plan, enter the following command:</p> <pre>terraform plan -var-file="terraform.sample"</pre> <p>Terraform evaluates the configuration files to determine the target state for the declared resources. It then compares the target state against the current state and creates a plan.</p>	DevOps engineer
Verify the plan.	Review the plan and confirm that it configures the required architecture in your target AWS account.	DevOps engineer

Task	Description	Skills required
Deploy the solution.	<ol style="list-style-type: none"> <li data-bbox="592 226 1027 359">1. Enter the following command to apply the plan: <div data-bbox="630 394 1027 554" style="border: 1px solid #ccc; border-radius: 10px; padding: 10px; margin: 10px 0;"> <pre>terraform apply - var-file="terrafo rm.sample"</pre> </div> </li> <li data-bbox="592 569 1027 1031">2. Enter yes to confirm. Terraform creates, updates, or destroys infrastructure to achieve the target state declared in the configuration files. For more information about the sequence, see the <a href="#">Architecture</a> section of this pattern.</li> </ol>	DevOps engineer

## Verify the deployment

Task	Description	Skills required
Validate the deployment.	<p data-bbox="592 1327 1027 1556">Verify the status of the db-cicd-integration pipeline to confirm that the database migration is complete.</p> <ol style="list-style-type: none"> <li data-bbox="592 1598 1027 1780">1. Sign in to the AWS Management Console, and then open the <a href="#">AWS CodePipeline console</a>.</li> </ol>	DevOps engineer

Task	Description	Skills required
	<ol style="list-style-type: none"><li>2. In the navigation pane, choose <b>Pipelines</b>.</li><li>3. Choose the db-cicd-integration pipeline.</li><li>4. Validate that the pipeline execution has completed successfully.</li></ol>	

## Clean up infrastructure after use

Task	Description	Skills required
Clean up the infrastructure.	<ol style="list-style-type: none"><li>1. After your project is complete, clean up the infrastructure you created by using the command: <pre>terraform destroy --var-file=terraform.sample</pre></li><li>2. Enter yes to confirm.</li></ol>	DevOps engineer

## Related resources

### AWS documentation

- [Getting started with a Terraform product](#)

### Terraform documentation

- [Terraform installation](#)
- [Terraform backend configuration](#)

- [Terraform AWS Provider documentation](#)



# Set up an HA/DR architecture for Oracle E-Business Suite on Amazon RDS Custom with an active standby database

Created by Simon Cunningham (AWS) and Nitin Saxena

**Environment:** Production

**Technologies:** Databases;  
Infrastructure

**Workload:** Oracle

**AWS services:** Amazon RDS

## Summary

This pattern describes how you can architect your Oracle E-Business solution on Amazon Relational Database Service (Amazon RDS) Custom for high availability (HA) and disaster recovery (DR) by setting up an Amazon RDS Custom read replica database in another Amazon Web Services (AWS) Availability Zone and converting it to an active standby database. The creation of the Amazon RDS Custom read replica is fully automated through the AWS Management Console.

This pattern doesn't discuss the steps for adding additional application tiers and shared file systems, which can also be part of an HA/DR architecture. For more information about those topics, see the following Oracle Support Notes: 1375769.1, 1375670.1, and 1383621.1 (section 5, *Advanced Cloning Options*). (Access requires an [Oracle Support](#) account.)

To migrate E-Business Suite system to a single-tier, Single-AZ architecture on Amazon Web Services (AWS), see the pattern [Migrate Oracle E-Business Suite to Amazon RDS Custom](#).

Oracle E-Business Suite is an Enterprise Resource Planning (ERP) solution for automating enterprise-wide processes such as financials, human resources, supply chains, and manufacturing. It has a three-tier architecture: client, application, and database. Previously, you had to run your E-Business Suite database on a self-managed [Amazon Elastic Compute Cloud \(Amazon EC2\) instance](#), but you can now benefit from [Amazon RDS Custom](#).

## Prerequisites and limitations

### Prerequisites

- An existing E-Business Suite installation on Amazon RDS Custom; see the pattern [Migrate Oracle E-Business Suite to Amazon RDS Custom](#)
- If you want to change the read replica to read-only and use it to offload reporting to the standby, an [Oracle Active Data Guard database license](#) (see the *Oracle Technology Commercial Price List*)

## Limitations

- Limitations and unsupported configurations for [Oracle databases on Amazon RDS Custom](#)
- Limitations associated with [Amazon RDS Custom for Oracle read replicas](#)

## Product versions

For Oracle Database versions and instance classes supported by Amazon RDS Custom, see [Requirements and limitations for Amazon RDS Custom for Oracle](#).

## Architecture

The following diagram illustrates a representative architecture for E-Business Suite on AWS that includes multiple Availability Zones and application tiers in an active/passive setup. The database uses an Amazon RDS Custom DB instance and Amazon RDS Custom read replica. The read replica uses Active Data Guard to replicate to another Availability Zone. You can also use the read replica to offload read traffic on the primary database and for reporting purposes.

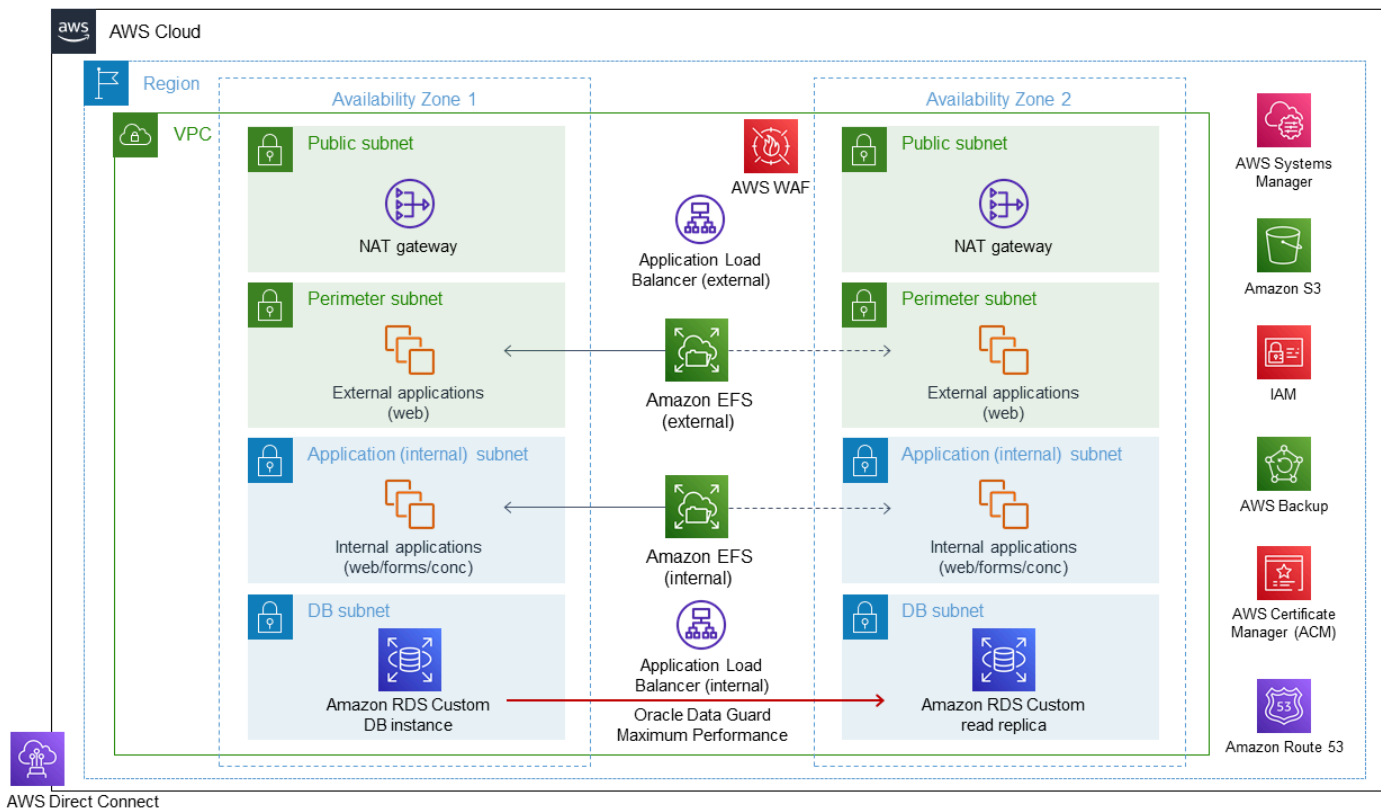

For more information, see [Working with read replicas for Amazon RDS Custom for Oracle](#) in the Amazon RDS documentation.

The Amazon RDS Custom read replica is created by default as mounted. However, if you want to offload some of your read-only workloads to the standby database to reduce the load on your primary database, you can manually change the mode of mounted replicas to read-only by following the steps in the [Epics](#) section. A typical use case for this would be to run your reports from the standby database. Changing to read-only requires an active standby database license.

When you create a read replica on AWS, the system uses Oracle Data Guard broker under the covers. This configuration is automatically generated and set up in Maximum Performance mode as follows:

```
DGMGRL> show configuration
Configuration - rds_dg
  Protection Mode: MaxPerformance
  Members:
    vis_a - Primary database
    vis_b - Physical standby database
  Fast-Start Failover: DISABLED
  Configuration Status:
```

SUCCESS (status updated 58 seconds ago)

## Tools

### AWS services

- [Amazon RDS Custom for Oracle](#) is a managed database service for legacy, custom, and packaged applications that require access to the underlying operating system and database environment. It automates database administration tasks and operations while making it possible for you, as a database administrator, to access and customize your database environment and operating system.

### Other tools

- Oracle Data Guard is a tool that helps you create and manage Oracle standby databases. This pattern uses Oracle Data Guard to set up an active standby database on Amazon RDS Custom.

## Epics

### Create a read replica

Task	Description	Skills required
Create a read replica of the Amazon RDS Custom DB instance.	<p>To create a read replica, follow the instructions in the <a href="#">Amazon RDS documentation</a> and use the Amazon RDS Custom DB instance you created (see the <a href="#">Prerequisites</a> section) as the source database.</p> <p>By default, the Amazon RDS Custom read replica is created as a physical standby and is in the mounted state. This is intentional to ensure</p>	DBA

Task	Description	Skills required
	compliance with the Oracle Active Data Guard license. Follow the next steps to convert the read replica to read-only mode.	

## Change the read replica to a read-only active standby

Task	Description	Skills required
Connect to the Amazon RDS Custom read replica.	<p>Use the following commands to convert your physical standby database to an active standby database.</p> <p><b>Important:</b> These commands require an Oracle active standby license. To get a license, contact your Oracle representative.</p> <pre> \$ sudo su - rdsdb -bash-4.2\$ sql SQL&gt; select process,s tatus,sequence# from v \$managed_standby;  PROCESS    STATUS SEQUENCE# ----- ARCH      CLOSING           3956 ARCH      CONNECTED           0 ARCH      CLOSING           3955 </pre>	DBA

Task	Description	Skills required
	<pre> ARCH          CLOSING               3957 RFS           IDLE               0 RFS           IDLE               3958 MRP0          APPLYING_LOG               3958 SQL&gt; select name,            database_role,            open_mode from v            \$database;  NAME          DATABASE_ ROLE          OPEN_MODE ----- ----- ----- VIS           PHYSICAL STANDBY MOUNTED SQL&gt; alter database        recover managed standby        database cancel; Database altered. Open the standby        database SQL&gt; alter database        open; Database altered. SQL&gt; select name,            database_role,            open_mode from v            \$database;  NAME          DATABASE_ ROLE          OPEN_MODE ----- ----- ----- VIS           PHYSICAL STANDBY READ ONLY                     </pre>	

Task	Description	Skills required
Start media recovery with real-time log apply.	<p>To enable the real-time log apply feature, use the following commands. These convert and validate the standby (read replica) as an active standby database, so you can connect and run read-only queries.</p> <pre data-bbox="597 632 1027 911">SQL&gt; alter database recover managed standby database using current logfile disconnect from session; Database altered</pre>	DBA
Check the database status.	<p>To check the status of the database, use the following command.</p> <pre data-bbox="597 1115 1027 1633">SQL&gt; select name, database_role, open_mode from v \$database; NAME          DATABASE_ROLE               OPEN_MODE ----- ----- ----- VIS          PHYSICAL STANDBY READ ONLY WITH APPLY</pre>	DBA

Task	Description	Skills required
Check redo apply mode.	<p>To check redo apply mode, use the following command.</p> <pre> SQL&gt; select process,s tatus,sequence# from v \$managed_standby; PROCESS    STATUS SEQUENCE# ----- ARCH       CLOSING           3956 ARCH       CONNECTED           0 ARCH       CLOSING           3955 ARCH       CLOSING           3957 RFS        IDLE           0 RFS        IDLE           3958 MRP0       APPLYING_LOG           3958  SQL&gt; select open_mode from v\$database; OPEN_MODE ----- READ ONLY WITH APPLY </pre>	DBA

## Related resources

- [Migrate Oracle E-Business Suite to Amazon RDS Custom](#) (AWS Prescriptive Guidance)
- [Working with Amazon RDS Custom](#) (Amazon RDS documentation)
- [Working with read replicas for Amazon RDS Custom for Oracle](#) (Amazon RDS documentation)



- [Amazon RDS Custom for Oracle – New Control Capabilities in Database Environment](#) (AWS News blog)
- [Migrating Oracle E-Business Suite on AWS](#) (AWS whitepaper)
- [Oracle E-Business Suite architecture on AWS](#) (AWS whitepaper)

# Set up data replication between Amazon RDS for MySQL and MySQL on Amazon EC2 using GTID

*Created by Rajesh Madiwale (AWS)*

**Environment:** PoC or pilot

**Technologies:** Databases

**Workload:** Open-source

## Summary

This pattern describes how to set up data replication on the Amazon Web Services (AWS) Cloud between an Amazon Relational Database Service (Amazon RDS) for MySQL DB instance and a MySQL database on an Amazon Elastic Compute Cloud (Amazon EC2) instance by using MySQL native global transaction identifier (GTID) replication.

With GTIDs, transactions are identified and tracked when they are committed on the originating server and applied by replicas. You don't need to refer to log files when starting a new replica during failover.

## Prerequisites and limitations

### Prerequisites

- An active AWS account
- An Amazon Linux instance deployed

### Restrictions

- This setup requires an internal team to run the read-only queries.
- The source and target MySQL versions must be the same.
- Replication is set up in the same AWS Region and virtual private cloud (VPC).

### Product versions

- Amazon RDS versions 5.7.23 and later, which are the versions that support [GTID](#)

# Architecture

## Source technology stack

- Amazon RDS for MySQL

## Target technology stack

- MySQL on Amazon EC2

## Target architecture

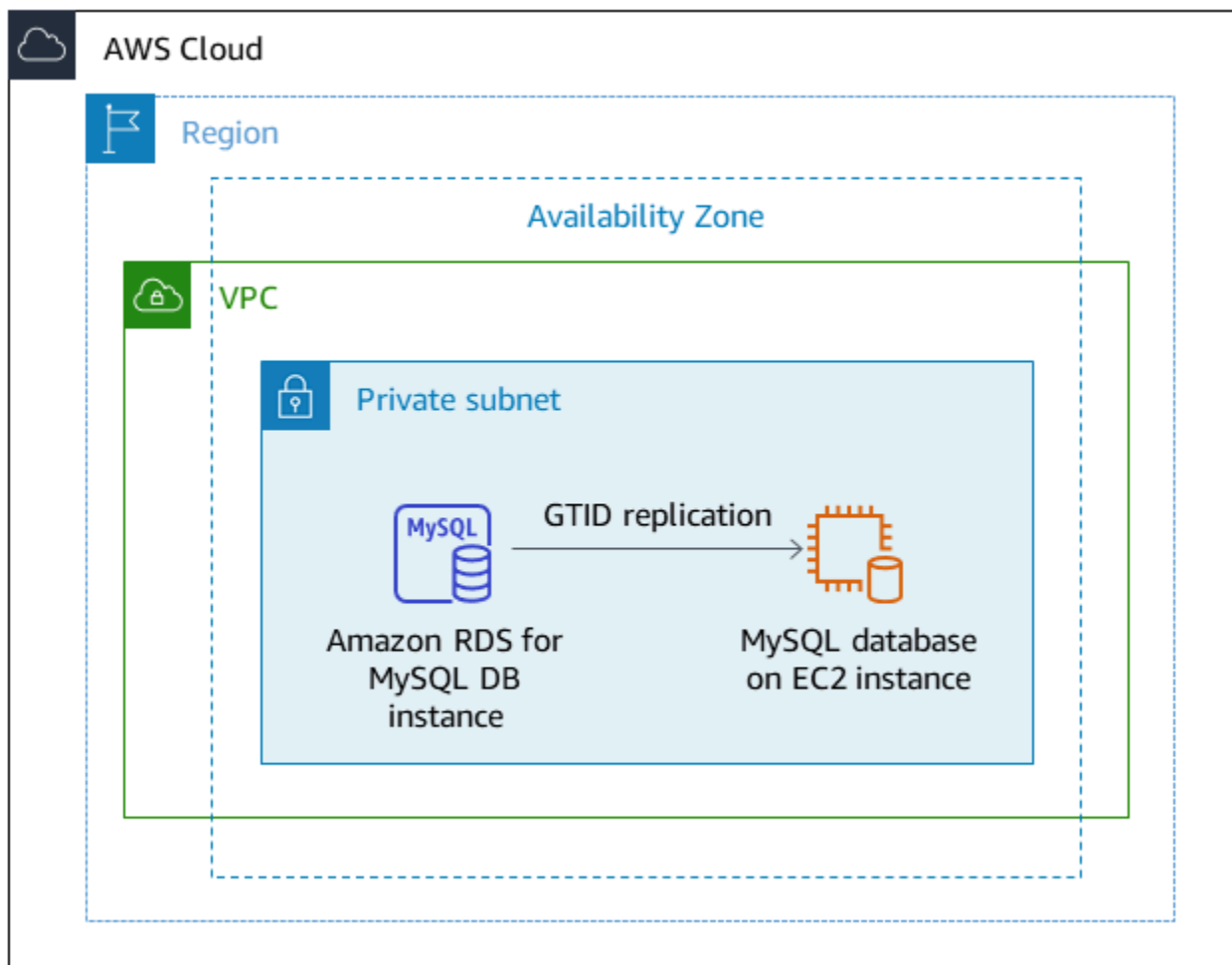

## Tools

### AWS services

- [Amazon Elastic Compute Cloud \(Amazon EC2\)](#) provides scalable computing capacity in the AWS Cloud. You can launch as many virtual servers as you need and quickly scale them up or down.
- [Amazon Relational Database Service \(Amazon RDS\) for MySQL](#) helps you set up, operate, and scale a MySQL relational database in the AWS Cloud.

## Other services

- [Global transaction identifiers \(GTIDs\)](#) are unique identifiers generated for committed MySQL transactions.
- [mysqldump](#) is a client utility for performing logical backups by producing SQL statements that can be run to reproduce the source database object definitions and table data.
- [mysql](#) is the command-line client for MySQL.

## Epics

### Create and prepare the Amazon RDS for MySQL DB instance

Task	Description	Skills required
Create the RDS for MySQL instance.	To create the RDS for MySQL instance, follow the steps in the <a href="#">Amazon RDS documentation</a> , using the parameter values that are covered in the next task.	DBA, DevOps engineer
Enable GTID-related settings in the DB parameter group.	Enable the following parameters in the Amazon RDS for MySQL DB parameter group.  Set <code>enforce_gtid_consistency</code> to <code>on</code> , and set <code>gtid-mode</code> to <code>on</code> .	DBA

Task	Description	Skills required
Reboot the Amazon RDS for MySQL instance.	A reboot is required for the parameter changes to take effect.	DBA
Create a user and grant it replication permissions.	To install MySQL, use the following commands.  <pre>CREATE USER 'repl'@'%'   IDENTIFIED BY 'xxxx'; GRANT REPLICATI ON slave ON *.* TO   'repl'@'%' ; FLUSH PRIVILEGES;</pre>	DBA

## Install and prepare MySQL on the Amazon EC2 instance

Task	Description	Skills required
Install MySQL on Amazon Linux.	To install MySQL, use the following commands.  <pre>sudo yum update sudo wget https://d ev.mysql.com/get/m ysql57-community-r elease-el7-11.noar ch.rpm sudo yum localinstall mysql57-community- release-el7-11.noa rch.rpm sudo yum install mysql- community-server sudo systemctl start mysqld</pre>	DBA

Task	Description	Skills required
Log in to MySQL on the EC2 instance and create the database.	<p>The database name should be the same as the database name in Amazon RDS for MySQL. In the following example, the database name is <code>replication</code> .</p> <pre>create database replication;</pre>	DBA
Edit the MySQL config file, and restart the database.	<p>Edit the <code>my.cnf</code> file that is located in <code>/etc/</code> by adding the following parameters.</p> <pre>server-id=3 gtid_mode=ON enforce_gtid_consist ency=ON replicate-ignore-db =mysql binlog-format=ROW log_bin=mysql-bin</pre> <p>Then restart the <code>mysqld</code> service.</p> <pre>systemctl mysqld restart</pre>	DBA

## Set up replication

Task	Description	Skills required
Export the data dump from the Amazon RDS for MySQL database.	To export the dump from Amazon RDS for MySQL, use the following command.	DBA

Task	Description	Skills required
	<pre>mysqldump --single-transaction -h mydb.xxxxxxx.amazonaws.com -uadmin -p --databases replication &gt; replication-db.sql</pre>	
Restore the .sql dump file in the MySQL database on Amazon EC2.	To import the dump to the MySQL database on Amazon EC2, use the following command. <pre>mysql -D replication -uroot -p &lt; replication-db.sql</pre>	DBA
Configure the MySQL database on Amazon EC2 as a replica.	To start the replication and to check the replication status, log in to the MySQL database on Amazon EC2, and use the following command. <pre>CHANGE MASTER TO MASTER_HOST="mydb.xxxxxxx.amazonaws.com", MASTER_USER="repl", MASTER_PASSWORD="rep123", MASTER_PORT=3306, MASTER_AUTO_POSITION = 1; START SLAVE; SHOW SLAVE STATUS\G</pre>	DBA

## Related resources

- [Amazon EC2 User Guide for Linux Instances](#)
- [Installing MySQL on Linux Using the MySQL Yum Repository](#)
- [Replication with Global Transaction Identifiers](#)
- [Using GTID-based replication for Amazon RDS for MySQL](#)



# Transition roles for an Oracle PeopleSoft application on Amazon RDS Custom for Oracle

Created by *sampath kathirvel* (AWS)

**Environment:** Production

**Technologies:** Databases;  
Infrastructure

**Workload:** Oracle

**AWS services:** Amazon RDS

## Summary

To run the [Oracle PeopleSoft](#) enterprise resource planning (ERP) solution on Amazon Web Services (AWS), you can use [Amazon Relational Database Service \(Amazon RDS\)](#) or [Amazon RDS Custom for Oracle](#), which supports legacy, custom, and packaged applications that require access to the underlying operating system (OS) and database environment. For key factors to consider when planning a migration, see [Oracle database migration strategies](#) in AWS Prescriptive Guidance.

This pattern focuses on the steps to perform an Oracle Data Guard switchover, or role transition, for a PeopleSoft application database running on Amazon RDS Custom as the primary database with a read replica database. The pattern includes steps to configure [fast-start failover \(FSFO\)](#). During this process, the databases in the Oracle Data Guard configuration continue to function in their new roles. Typical use cases for Oracle Data Guard switchover are disaster recovery (DR) drills, scheduled maintenance activities on databases, and [Standby-First Patch Apply](#) rolling patches. For more information, see the blog post [Reduce database patching downtime in Amazon RDS Custom](#).

## Prerequisites and limitations

### Prerequisites

- Completion of the [Add HA to Oracle PeopleSoft on Amazon RDS Custom by using a read replica](#) pattern.

### Limitations

- Limitations and unsupported configurations for [RDS Custom for Oracle](#)

- Limitations associated with [Amazon RDS Custom for Oracle read replicas](#)

## Product versions

- For Oracle Database versions supported by Amazon RDS Custom, see [RDS Custom for Oracle](#).
- For Oracle Database instance classes supported by Amazon RDS Custom, see [DB instance class support for RDS Custom for Oracle](#).

## Architecture

### Technology stack

- Amazon RDS Custom for Oracle

### Target architecture

The following diagram shows an Amazon RDS Custom DB instance and an Amazon RDS Custom read replica. Oracle Data Guard provides role transition during failover for DR.

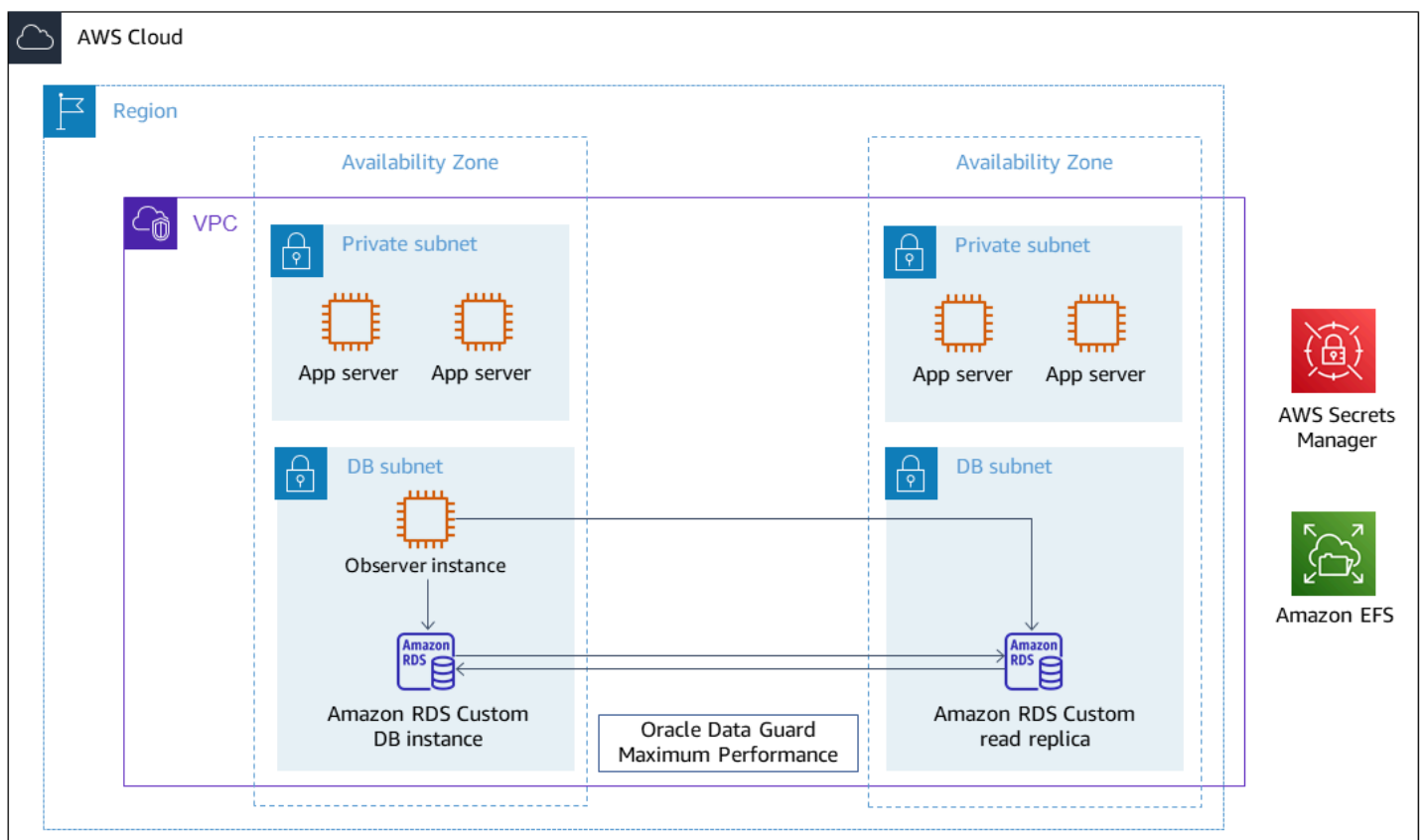

For a representative architecture using Oracle PeopleSoft on AWS, see [Set up a highly available PeopleSoft architecture on AWS](#).

## Tools

### AWS services

- [Amazon RDS Custom for Oracle](#) is a managed database service for legacy, custom, and packaged applications that require access to the underlying OS and database environment.
- [AWS Secrets Manager](#) helps you replace hardcoded credentials in your code, including passwords, with an API call to Secrets Manager to retrieve the secret programmatically. In this pattern, you retrieve the database user passwords from Secrets Manager for RDS\_DATAGUARD with the secret name `do-not-delete-rds-custom-+<<RDS Resource ID>>+-dg`.

### Other services

- [Oracle Data Guard](#) helps you create, maintain, manage, and monitor standby databases. This pattern uses Oracle Data Guard Maximum Performance for transitioning roles ([Oracle Data Guard switchover](#)).

## Best practices

For your production deployment, we recommend launching the observer instance in a third Availability Zone, separate from the primary and read replica nodes.

## Epics

### Initiate role transition

Task	Description	Skills required
Pause database automation for both the primary and the replica.	Although the RDS Custom automation framework doesn't interfere with the role transition process, it's a good practice to pause automation during Oracle Data Guard switchover.	Cloud administrator, DBA

Task	Description	Skills required
	To pause and resume RDS Custom database automation, follow the instructions at <a href="#">Pausing and resuming RDS Custom automation</a> .	

Task	Description	Skills required
<p>Check the Oracle Data Guard status.</p>	<p>To check the Oracle Data Guard status, log in to the primary database. This pattern includes code for using a multitenant container database (CDB) or a non-CDB instance.</p> <p><b>Non-CDB</b></p> <pre data-bbox="597 667 1029 1875"> -bash-4.2\$ dgmgrl RDS_DATAGUARD@RDS_ CUSTOM_ORCL_A DGMGRL for Linux: Release 19.0.0.0.0 - Production on Mon Nov 28 20:55:50 2022 Version 19.10.0.0.0 Copyright (c) 1982, 2019, Oracle and/or its affiliates. All rights reserved. Welcome to DGMGRL, type "help" for informati on. Password: Connected to "ORCL_A" Connected as SYSDBG. DGMGRL&gt; show configura tion Configuration - rds_dg Protection Mode: MaxAvailability Members: orcl_a - Primary database orcl_d - Physical standby database Fast-Start Failover: Disabled </pre>	<p>DBA</p>

Task	Description	Skills required
	<pre> Configuration Status: SUCCESS (status updated 59 seconds ago) DGMGRL&gt;  <b>CDB</b>  CDB-bash-4.2\$ dgmgrl C##RDS_DATAGUARD@R DS_CUSTOM_RDSCDB_A DGMGRL for Linux: Release 19.0.0.0.0 - Production on Wed Jan 18 06:13:07 2023 Version 19.16.0.0.0 Copyright (c) 1982, 2019, Oracle and/or its affiliates. All rights reserved. Welcome to DGMGRL, type "help" for informati on. Password: Connected to "RDSCDB_A " Connected as SYSDBG. DGMGRL&gt; show configura tion Configuration - rds_dg Protection Mode: MaxAvailability Members: rdsbdb_a - Primary database rdsbdb_b - Physical standby database Fast-Start Failover: Disabled Configuration Status: SUCCESS (status updated 52 seconds ago) </pre>	

Task	Description	Skills required
	<pre>DGMGRL&gt;</pre>	
Verify the instance role.	<p>Open the AWS Management Console, and navigate to the Amazon RDS console. In the database's <b>Replication</b> section, on the <b>Connectivity &amp; security</b> tab, verify the instance role for the primary and replica.</p> <p>The primary role should match the Oracle Data Guard primary database, and the replica role should match the Oracle Data Guard physical standby database.</p>	Cloud administrator, DBA

Task	Description	Skills required
Perform the switchover.	<p>To perform the switchover, connect to DGMGRL from the primary node.</p> <p><b>Non-CDB</b></p> <pre>DGMGRL&gt; switchover to orcl_d; Performing switchover NOW, please wait... Operation requires a connection to database "orcl_d" Connecting ... Connected to "ORCL_D" Connected as SYSDG. New primary database "orcl_d" is opening... Operation requires start up of instance "ORCL" on database "orcl_a" Starting instance "ORCL"... Connected to an idle instance. ORACLE instance started. Connected to "ORCL_A" Database mounted. Database opened. Connected to "ORCL_A" Switchover succeeded, new primary is "orcl_d" DGMGRL&gt;</pre> <p><b>CDB</b></p> <pre>DGMGRL&gt; switchover to rdscdb_b</pre>	DBA



Task	Description	Skills required
	<pre>Performing switchover NOW, please wait... New primary database "rdscdb_b" is opening... Operation requires start up of instance "RDSCDB" on database "rdscdb_a" Starting instance "RDSCDB"... Connected to an idle instance. ORACLE instance started. Connected to "RDSCDB_A " Database mounted. Database opened. Connected to "RDSCDB_A " Switchover succeeded , new primary is "rdscdb_b"</pre>	

Task	Description	Skills required
Verify the Oracle Data Guard connection.	<p>After switchover, verify the Oracle Data Guard connection from the primary node to DGMGRL.</p> <p><b>Non-CDB</b></p> <pre>DGMGRL&gt; show configuration; Configuration - rds_dg Protection Mode:   MaxAvailability Members: orcl_d - Primary   database orcl_a - Physical   standby database Fast-Start Failover:   Disabled Configuration Status: SUCCESS (status updated   60 seconds ago) DGMGRL&gt;</pre> <pre>DGMGRL&gt; show configuration lag; Configuration - rds_dg Protection Mode:   MaxAvailability Members: orcl_d - Primary   database orcl_a - Physical   standby database Transport Lag: 0   seconds (computed 0   seconds ago) Apply Lag: 0 seconds   (computed 0 seconds   ago)</pre>	DBA

Task	Description	Skills required
	<pre>Fast-Start Failover:   Disabled Configuration Status: SUCCESS (status updated   44 seconds ago) DGMGRL&gt;</pre> <p><b>CDB</b></p> <pre>DGMGRL&gt; show configura tion DGMGRL&gt; show configura tion Configuration - rds_dg   Protection Mode:   MaxAvailability   Members:     rdscdb_b - Primary   database     rdscdb_a - Physical   standby database Fast-Start Failover:   Disabled Configuration Status: SUCCESS (status   updated 52 seconds ago) DGMGRL&gt;</pre> <pre>DGMGRL&gt; show configura tion lag Configuration - rds_dg   Protection Mode:   MaxAvailability   Members:     rdscdb_b - Primary   database     rdscdb_a - Physical   standby database     Transport Lag:      0 seconds</pre>	

Task	Description	Skills required
	<pre>(computed 0 seconds ago) Apply Lag: 0 seconds (computed 0 seconds ago) Fast-Start Failover: Disabled Configuration Status: SUCCESS (status updated 53 seconds ago) DGMGRL&gt;</pre>	
Verify the instance role on the Amazon RDS console.	After you perform the role switch, the Amazon RDS console shows the new roles under the <b>Replication</b> section on the <b>Connectivity &amp; Security</b> tab under <b>Databases</b> . It might take a few minutes for <b>Replication state</b> to update from empty to <b>Replicating</b> .	DBA

## Configure FSFO

Task	Description	Skills required
Reset the switchover.	Set the switchover back to the primary node.	DBA
Install and start the observer.	An observer process is a DGMGRL client component , typically running in a different machine from the primary and standby	DBA

Task	Description	Skills required
	<p>databases. The ORACLE HOME installation for the observer can be an Oracle Client Administrator installation, or you can install either Oracle Database Enterprise Edition or Personal Edition. For more information about observer installation for your database release, see <a href="#">Installing and Starting the Observer</a>. To configure high availability for the observer process, you might want to do the following:</p> <ul style="list-style-type: none"><li>• Enable <a href="#">EC2 instance automatic recovery</a> for the EC2 instance running your observer. You need to automate the observer startup process as part of the OS startup.</li><li>• Deploy an observer in the EC2 instance and configure an Amazon EC2 Auto Scaling group with size one (1). In the event of EC2 instance failure, the automatic scaling group automatically spins up another EC2 instance.</li></ul> <p>For Oracle 12c Release 2 and later, you can deploy up to</p>	

Task	Description	Skills required
	three observers. One observer is the primary observer, and the rest are backup observers . When the primary observer fails, one of the backup observers takes the primary role.	

Task	Description	Skills required
Connect to DGMGRL from the observer host.	<p>The observer host is configured with <code>tnsnames.ora</code> entries for primary and standby database connectivity. You can enable FSFO with maximum performance protection mode as long as data loss is within the <a href="#">FastStartFailoverLagLimit</a> configuration (value in seconds), However, you must use maximum availability protection mode to work to achieve zero data loss (RPO=0).</p> <p><b>Non-CDB</b></p> <pre>DGMGRL&gt; show configuration; Configuration - rds_dg Protection Mode:   MaxAvailability Members: orcl_a - Primary   database orcl_d - Physical   standby database Fast-Start Failover:   Disabled Configuration Status: SUCCESS (status updated   58 seconds ago) DGMGRL&gt; show configuration lag Configuration - rds_dg Protection Mode:   MaxAvailability</pre>	DBA

Task	Description	Skills required
	<pre> Members: orcl_a - Primary         database orcl_d - Physical         standby database Transport Lag: 0         seconds (computed 1         second ago) Apply Lag: 0 seconds         (computed 1 second ago) Fast-Start Failover:         Disabled Configuration Status: SUCCESS (status updated         5 seconds ago) DGMGRL&gt; </pre> <p><b>CDB</b></p> <pre> -bash-4.2\$ dgmgrl C##RDS_DATAGUARD@R DS_CUSTOM_RDSCDB_A DGMGRL for Linux:   Release 19.0.0.0.0 -   Production on Wed Jan   18 06:55:09 2023 Version 19.16.0.0.0 Copyright (c) 1982,   2019, Oracle and/or   its affiliates. All   rights reserved. Welcome to DGMGRL, type   "help" for informati on. Password: Connected to "RDSCDB_A " Connected as SYSDBG. DGMGRL&gt; show configura tion Configuration - rds_dg </pre>	



Task	Description	Skills required
	<pre>Protection Mode: MaxAvailability Members:   rdsddb_a - Primary   database   rdsddb_b - Physical   standby database Fast-Start Failover: Disabled Configuration Status: SUCCESS (status updated 18 seconds ago) DGMGRL&gt;</pre>	

Task	Description	Skills required
Modify the standby database to be the failover target.	<p>Connect from either the primary node or the observer node to one standby database. (Although your onfiguration could have multiple standby databases , you need to connect to only one at this time.)</p> <p><b>Non-CDB</b></p> <pre>DGMGRL&gt; edit database   orcl_a set property   FastStartFailoverT   arget='orcl_d'; Property "faststar tfailovertarget"   updated DGMGRL&gt; edit database   orcl_d set property   FastStartFailoverT   arget='orcl_a'; Property "faststar tfailovertarget"   updated DGMGRL&gt; show database   orcl_a FastStart   FailoverTarget; FastStartFailoverTar   get = 'orcl_d' DGMGRL&gt; show database   orcl_d FastStart   FailoverTarget; FastStartFailoverTar   get = 'orcl_a' DGMGRL&gt;</pre> <p><b>CDB</b></p>	DBA

Task	Description	Skills required
	<pre>DGMGRL&gt; edit database orcl_a set property FastStartFailoverT arget='rdscdb_b'; Object "orcl_a" was not found DGMGRL&gt; edit database rdscdb_a set property FastStartFailoverT arget='rdscdb_b'; Property "faststar tfailovertarget" updated DGMGRL&gt; edit database rdscdb_b set property FastStartFailoverT arget='rdscdb_a'; Property "faststar tfailovertarget" updated DGMGRL&gt; show database rdscdb_a FastStart FailoverTarget; FastStartFailoverT arget = 'rdscdb_b' DGMGRL&gt; show database rdscdb_b FastStart FailoverTarget; FastStartFailoverT arget = 'rdscdb_a' DGMGRL&gt;</pre>	

Task	Description	Skills required
Configure FastStartFailoverThreshold for the connection to DGMGRL.	<p>The default value is 30 seconds in Oracle 19c, and the minimum value is 6 seconds. A lower value can potentially shorten the recovery time objective (RTO) during the failover. A higher value helps reduce the chance of unnecessary failover transient errors on the primary database.</p> <p>The RDS Custom for Oracle automation framework monitors database health and performs corrective actions every few seconds. Therefore, we recommend setting FastStartFailoverThreshold to a value higher than 10 seconds. The following example configures the threshold value at 35 seconds.</p> <p><b>Non-CBD or CDB</b></p> <pre>DGMGRL&gt; edit configuration set property FastStartFailoverThreshold=35; Property "faststartfailoverthreshold" updated DGMGRL&gt; show configuration FastStart FailoverThreshold;</pre>	DBA

Task	Description	Skills required
	<pre>FastStartFailover Threshold = '35' DGMGRL&gt;</pre>	

Task	Description	Skills required
<p>Enable FSFO by connecting to DGMGRL from the primary or observer node.</p>	<p>If the database doesn't have <a href="#">Flashback Database</a> enabled, the warning message <code>ORA-16827</code> appears. The optional flashback database helps automatically reinstate failed primary databases to a point in time before failover if the <a href="#">FastStartFailoverAutoReinstate</a> configuration property is set to <code>TRUE</code> (which is the default).</p> <p><b>Non-CDB</b></p> <pre>DGMGRL&gt; enable fast_start failover; Warning: ORA-16827: Flashback Database is disabled Enabled in Zero Data Loss Mode. DGMGRL&gt; DGMGRL&gt; show configuration Configuration - rds_dg Protection Mode: MaxAvailability Members: orcl_a - Primary database Warning: ORA-16819: fast-start failover observer not started orcl_d - (*) Physical standby database Warning: ORA-16819: fast-start failover observer not started</pre>	<p>DBA</p>

Task	Description	Skills required
	<pre>Fast-Start Failover:   Enabled in Zero Data   Loss Mode Configuration Status: WARNING (status updated   29 seconds ago) DGMGRL&gt;</pre> <p><b>CDB</b></p> <pre>DGMGRL&gt; enable fast_star t failover; Warning: ORA-16827: Flashback Database is disabled Enabled in Zero Data Loss Mode. DGMGRL&gt; show configura tion; Configuration - rds_dg Protection Mode: MaxAvailability Members:   rdscdb_a - Primary   database Warning: ORA-16819 : fast-start failover observer not started   rdscdb_b - (*) Physical standby database Fast-Start Failover:   Enabled in Zero Data   Loss Mode Configuration Status: WARNING (status   updated 11 seconds ago) DGMGRL&gt;</pre>	

Task	Description	Skills required
<p>Start the observer for FSFO monitoring, and verify the status.</p>	<p>You can start the observer before or after you enable FSFO. If FSFO is already enabled, the observer immediately begins monitoring the status and connections to the primary and target standby databases. If FSFO is not enabled, the observer doesn't start monitoring until after FSFO is enabled.</p> <p>When you start the observer, the primary DB configuration will be displayed without any error messages, as evidenced by the previous <code>show configuration</code> command.</p> <p><b>Non-CDB</b></p> <pre>DGMGRL&gt; start observer; [W000 2022-12-01T06:16:51.271+00:00] FSFO target standby is orcl_d Observer 'ip-10-0-1-89' started [W000 2022-12-01T06:16:51.352+00:00] Observer trace level is set to USER  DGMGRL&gt; show configura tion Configuration - rds_dg</pre>	DBA



Task	Description	Skills required
	<pre> Protection Mode:   MaxAvailability Members: orcl_a - Primary   database orcl_d - (*) Physical   standby database Fast-Start Failover:   Enabled in Zero Data   Loss Mode Configuration Status: SUCCESS (status updated   56 seconds ago) DGMGRL&gt;  DGMGRL&gt; show observer Configuration - rds_dg Primary: orcl_a Active Target: orcl_d Observer "ip-10-0- 1-89" - Master Host Name: ip-10-0-1 -89 Last Ping to Primary: 1   second ago Last Ping to Target: 1   second ago DGMGRL&gt;  <b>CDB</b>  DGMGRL&gt; start observer; Succeeded in opening   the observer file   "/home/oracle/fsfo _ip-10-0-1-56.dat". [W000 2023-01-1 8T07:31:32.589+00:00]   FSFO target standby is   rdscdb_b </pre>	

Task	Description	Skills required
	<pre> Observer 'ip-10-0-1-56' started The observer log file is '/home/oracle/observer_ip-10-0-1-56.log'.  DGMGRL&gt; show configuration Configuration - rds_dg   Protection Mode:   MaxAvailability   Members:     rdscdb_a - Primary database     rdscdb_b - (*)   Physical standby database Fast-Start Failover:   Enabled in Zero Data Loss Mode Configuration Status: SUCCESS (status updated 12 seconds ago) DGMGRL&gt;  DGMGRL&gt; show observer; Configuration - rds_dg   Primary:   rdscdb_a   Active Target:   rdscdb_b Observer "ip-10-0-1-56" - Master   Host Name:     ip-10-0-1-56   Last Ping to Primary:     1 second ago   Last Ping to Target:     2 seconds ago DGMGRL&gt; </pre>	

Task	Description	Skills required
Verify the failover.	<p>In this scenario, a failover test can be performed by manually stopping the primary EC2 instance. Before stopping the EC2 instance, use the <code>tail</code> command to monitor the observer log file based on your configuration. Use DGMGRL to log in to standby database <code>orcl_d</code> with user <code>RDS_DATAGUARD</code> , and check the Oracle Data Guard status. It should show that <code>orcl_d</code> is the new primary database.</p> <p><b>Note:</b> In this failover testing scenario, <code>orcl_d</code> is the non-CDB database.</p> <p>Before failover, the flashback database has been enabled on <code>orcl_a</code>. After the former primary database returns online and starts in MOUNT state, the observer reinstates it into a new standby database. The reinstated database acts as the FSFO target for the new primary database. You can verify the details in observer logs.</p> <pre>DGMGRL&gt; show configuration</pre>	DBA

Task	Description	Skills required
	<pre> Configuration - rds_dg Protection Mode:   MaxAvailability Members: orcl_d - Primary   database Warning: ORA-16824 : multiple warnings,   including fast-start failover-related warnings, detected for the database orcl_a - (*) Physical standby database (disabled) ORA-16661: the standby database needs to be reinstated Fast-Start Failover:   Enabled in Zero Data   Loss Mode Configuration Status: WARNING (status updated   25 seconds ago) DGMGRL&gt; </pre> <p>The following shows example output in <code>observer.log</code> .</p> <pre> \$ tail -f /tmp/observer.log Unable to connect to database using rds_custom_orcl_a [W000 2023-01-1 8T07:50:32.589+00:00] Primary database cannot be reached. [W000 2023-01-1 8T07:50:32.589+00:00] </pre>	

Task	Description	Skills required
	<pre> Fast-Start Failover threshold has expired. [W000 2023-01-1 8T07:50:32.590+00:00] Try to connect to the standby. [W000 2023-01-1 8T07:50:32.590+00: 00] Making a last connection attempt to primary database before proceeding with Fast- Start Failover. [W000 2023-01-1 8T07:50:32.591+00:00] Check if the standby is ready for failover. [S002 2023-01-1 8T07:50:32.591+00:00] Fast-Start Failover started... 2023-01-18T07:50 :32.591+00:00 Initiating Fast-Star t Failover to database "orcl_d"... [S002 2023-01-1 8T07:50:32.592+00:00] Initiating Fast-start Failover. Performing failover NOW, please wait... Failover succeeded, new primary is "orcl_d" 2023-01-18T07:55:3 2.101+00:00 [S002 2023-01-1 8T07:55:32.591+00:00] Fast-Start Failover finished... [W000 2023-01-1 8T07:55:32.591+00:00] </pre>	

Task	Description	Skills required
	<pre> Failover succeeded. Restart pinging. [W000 2023-01-1 8T07:55:32.603+00:00] Primary database has changed to orcl_d. [W000 2023-01-1 8T07:55:33.618+00:00] Try to connect to the primary. [W000 2023-01-1 8T07:55:33.622+00: 00] Try to connect to the primary rds_custo m_orcl_d. [W000 2023-01-1 8T07:55:33.634+00: 00] The standby orcl_a needs to be reinstated [W000 2023-01-1 8T07:55:33.654+00:00] Try to connect to the new standby orcl_a. [W000 2023-01-1 8T07:55:33.654+00: 00] Connection to the primary restored! [W000 2023-01-1 8T07:55:35.654+00: 00] Disconnecting from database rds_custo m_orcl_d. [W000 2023-01-1 8T07:55:57.701+00:00] Try to connect to the new standby orcl_a. ORA-12170: TNS:Connect timeout occurred </pre>	

## Configure connectivity between the Oracle Peoplesoft application and the database

Task	Description	Skills required
Create and start the service in the primary database.	<p>You can avoid application configuration changes during a role transition by using a TNS entry that contains both the primary and standby database endpoints in the configuration. You can define two role-based database services to support both read/write and read-only workloads. In the following example, <code>orcl_rw</code> is the read/write service that's active on the primary database. <code>orcl_ro</code> is the read-only service and is active on the standby database that has been opened in read-only mode.</p> <pre data-bbox="594 1262 1027 1873">SQL&gt; select name,open _mode from v\$database; NAME OPEN_MODE ----- ORCL READ WRITE SQL&gt; exec dbms_serv ice.create_service ('orcl_rw','orcl_r w'); PL/SQL procedure successfully completed . SQL&gt; exec dbms_serv ice.create_service</pre>	DBA

Task	Description	Skills required
	<pre> ('orcl_ro','orcl_r o'); PL/SQL procedure successfully completed .  SQL&gt; exec dbms_serv ice.start_service( 'orcl_rw'); PL/SQL procedure successfully completed . SQL&gt; </pre>	
<p>Start the service in the standby database.</p>	<p>To start the service in the read-only standby database, use the following code.</p> <pre> SQL&gt; select name,open _mode from v\$database; NAME OPEN_MODE ----- ORCL READ ONLY WITH APPLY SQL&gt; exec dbms_serv ice.start_service( 'orcl_ro'); PL/SQL procedure successfully completed . SQL&gt; </pre>	DBA



Task	Description	Skills required
Automate starting the service when the primary DB is restarted.	<p>To automatically start the service in the primary database when it's restarted, use the following code.</p> <pre data-bbox="597 443 1029 1633">SQL&gt; CREATE OR REPLACE   TRIGGER TrgDgServices   after startup on   database   DECLARE   db_role VARCHAR(30);   db_open_mode VARCHAR(30);   BEGIN   SELECT DATABASE_ROLE,     OPEN_MODE INTO db_role,     db_open_mode FROM V   \$DATABASE;   IF db_role = 'PRIMARY'     THEN   DBMS_SERV 2 ICE.START   _SERVICE('orcl_rw');   END IF;   IF db_role = 'PHYSICAL   STANDBY' AND db_open_m   ode LIKE 'READ ONLY%'     THEN   DBMS_SERVICE.START_SER   VICE('orcl_ro');   END IF;   END;   /   Trigger created.   SQL&gt;</pre>	DBA

Task	Description	Skills required
Configure a connection between the read/write and read-only databases.	<p>You can use the following application-configuration example for the read/write and read-only connection.</p> <pre data-bbox="602 443 1029 1845">ORCL_RW = (DESCRIPTION = (CONNECT_TIMEOUT= 120)(RETRY_COUNT=2 0)(RETRY_DELAY=3)( TRANSPORT_CONNECT_ TIMEOUT=3) (ADDRESS_LIST = (ADDRESS = (PROTOCOL = TCP)(HOST=devpsftd b.*****.us-west-2 .rds.amazonaws.com) (PORT=1521)) (ADDRESS = (PROTOCOL = TCP)(HOST=psftread .*****.us-west-2. rds.amazonaws.com) (PORT=1521)) ) (CONNECT_DATA=(SERVIC E_NAME = orcl_rw)) ) ORCL_RO = (DESCRIPTION = (CONNECT_TIMEOUT= 120)(RETRY_COUNT=2 0)(RETRY_DELAY=3)( TRANSPORT_CONNECT_ TIMEOUT=3) (ADDRESS_LIST = (ADDRESS = (PROTOCOL = TCP)(HOST=devpsftd b.*****.us-west-2 .rds.amazonaws.com) (PORT=1521))</pre>	DBA

Task	Description	Skills required
	<pre>(ADDRESS = (PROTOCOL = TCP)(HOST=psftread .*****.us-west-2. ids.amazonaws.com) (PORT=1521)) ) (CONNECT_DATA=(SERVIC E_NAME = orcl_io)) )</pre>	

## Related resources

- [Enabling High Availability with Data Guard on Amazon RDS Custom for Oracle](#) (AWS Technical Guide)
- [Configuring Amazon RDS as an Oracle PeopleSoft Database](#) (AWS whitepaper)
- [Oracle Data Guard Broker guide](#) (Oracle reference documentation)
- [Data Guard Concepts and Administration](#) (Oracle reference documentation)
- [Oracle Data Guard Specific FAN and FCF Configuration Requirements](#) (Oracle reference documentation)

# Unload data from an Amazon Redshift cluster across accounts to Amazon S3

Created by Andrew Kamel (AWS)

**Code repository:** [aws-unload-redshift-to-s3-python](#)

**Environment:** Production

**Technologies:** Databases; Analytics; Serverless

**Workload:** Open-source

**AWS services:** AWS Lambda; Amazon Redshift; Amazon S3; AWS Secrets Manager

## Summary

When you test applications, it's helpful to have production data in your test environment. Using production data can give you a more accurate assessment of the application that you're developing.

This pattern extracts data from an Amazon Redshift cluster in a production environment to an Amazon Simple Storage Service (Amazon S3) bucket in a development environment on Amazon Web Services (AWS).

The pattern steps through the setup of both DEV and PROD accounts, including the following:

- Required resources
- AWS Identity and Access Management (IAM) roles
- Network adjustments to subnets, security groups, and the virtual private cloud (VPC) to support the Amazon Redshift connection
- An example AWS Lambda function with a Python runtime for testing the architecture

To grant access to the Amazon Redshift cluster, the pattern uses AWS Secrets Manager to store the relevant credentials. The benefit is having all the needed information to directly connect to the Amazon Redshift cluster without needing to know where the Amazon Redshift cluster resides. Additionally, you can [monitor use of the secret](#).

The secret saved in Secrets Manager includes the Amazon Redshift cluster's host, database name, port, and relevant credentials.

For information about security considerations when using this pattern, see the [Best practices](#) section.

## Prerequisites and limitations

### Prerequisites

- An [Amazon Redshift cluster running](#) in the PROD account
- An [S3 bucket created](#) in the DEV account
- [VPC peering](#) between the DEV and PROD accounts, with [route tables adjusted](#) accordingly
- [DNS hostnames and DNS resolution enabled](#) for both peered VPCs

### Limitations

- Depending on the amount of data that you want to query, the Lambda function might time out.

If your run takes more time than the maximum Lambda timeout (15 minutes), use an asynchronous approach for your Lambda code. The code example for this pattern uses the [psycopg2](#) library for Python, which doesn't currently support asynchronous processing.

- Some AWS services aren't available in all AWS Regions. For Region availability, see [AWS services by Region](#). For specific endpoints, see the [Service endpoints and quotas](#) page, and choose the link for the service.

## Architecture

The following diagram shows the target architecture, with DEV and PROD accounts.

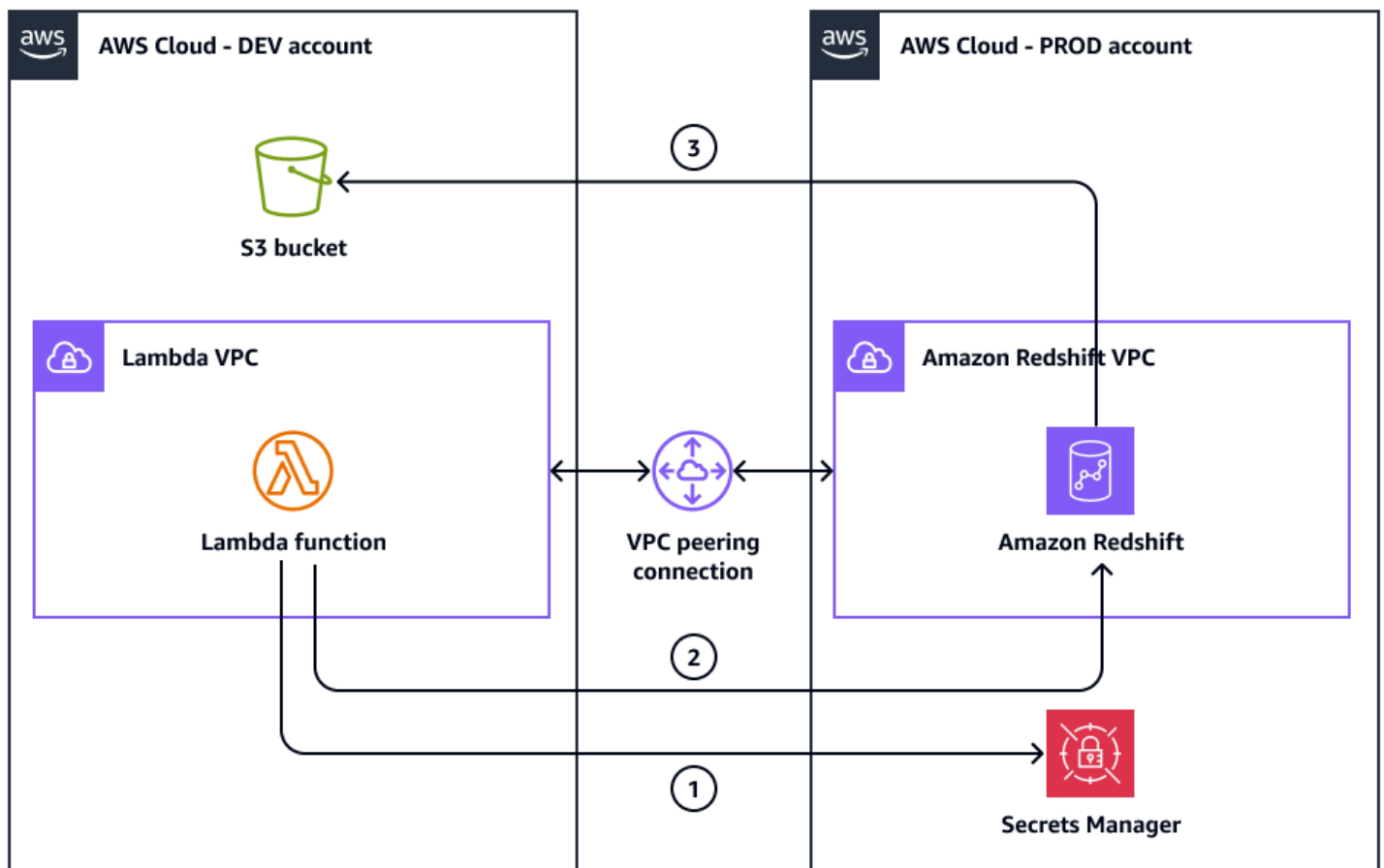

The diagram shows the following workflow:

1. The Lambda function in the DEV account assumes the IAM role that's required to access the Amazon Redshift credentials in Secrets Manager in the PROD account.

The Lambda function then retrieves the Amazon Redshift cluster secret.

2. The Lambda function in the DEV account uses the information to connect to the Amazon Redshift cluster in the PROD account through the peered VPCs.

The Lambda function then sends an unload command to query the Amazon Redshift cluster in the PROD account.

3. The Amazon Redshift cluster in the PROD account assumes the relevant IAM role to access the S3 bucket in the DEV account.

The Amazon Redshift cluster unloads the queried data to the S3 bucket in the DEV account.

## Querying data from Amazon Redshift

The following diagram shows the roles that are used to retrieve the Amazon Redshift credentials and connect to the Amazon Redshift cluster. The workflow is initiated by the Lambda function.

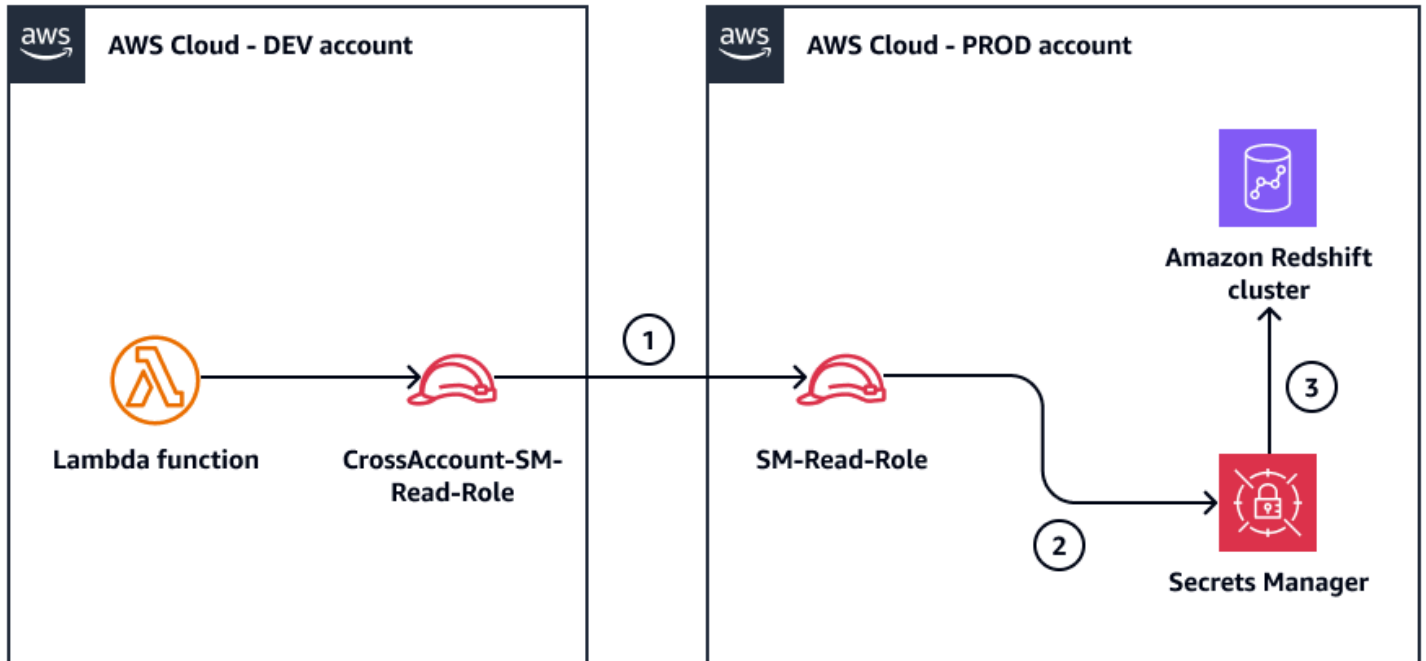

The diagram shows the following workflow:

1. The `CrossAccount-SM-Read-Role` in the DEV account assumes the `SM-Read-Role` in the PROD account.
2. The `SM-Read-Role` role uses the attached policy to retrieve the secret from Secrets Manager.
3. The credentials are used to access the Amazon Redshift cluster.

## Uploading data to Amazon S3

The following diagram shows the cross-account read-write process for extracting data and uploading it to Amazon S3. The workflow is initiated by the Lambda function. The pattern [chains IAM roles in Amazon Redshift](#). The unload command that comes from the Amazon Redshift cluster assumes the `CrossAccount-S3-Write-Role`, and then assumes the `S3-Write-Role`. This role chaining gives Amazon Redshift access to Amazon S3.

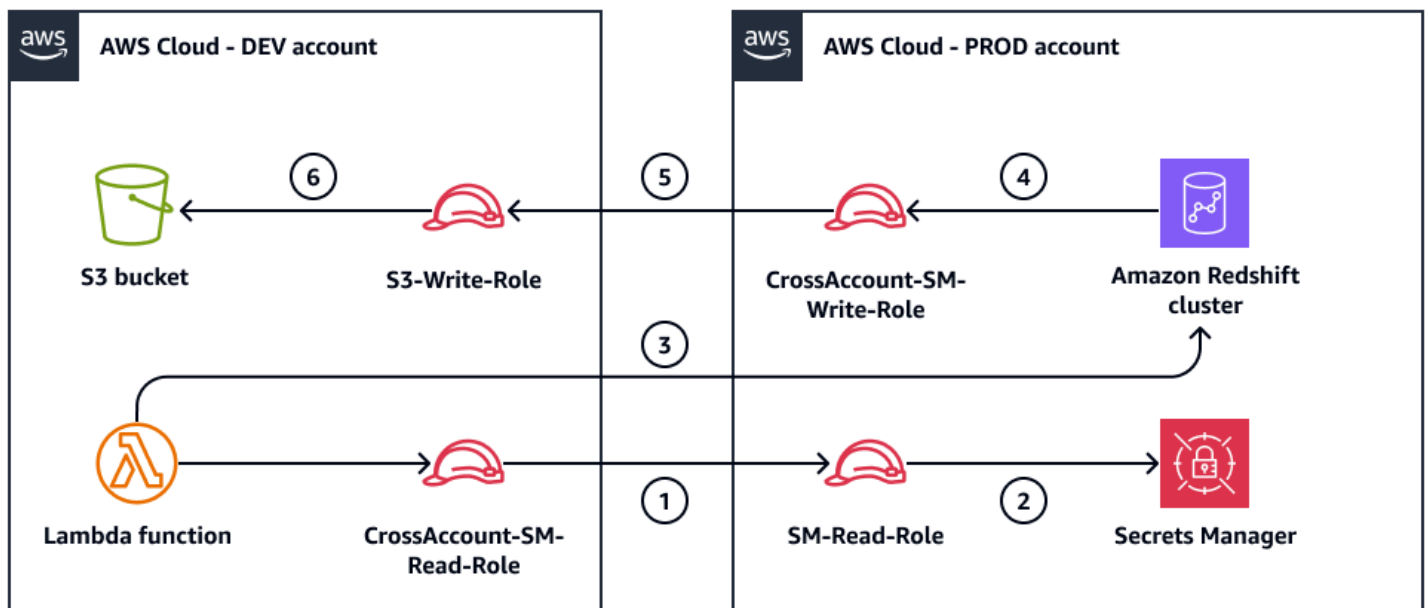

The workflow includes the following steps:

1. The **CrossAccount-SM-Read-Role** in the DEV account assumes the **SM-Read-Role** in the PROD account.
2. The **SM-Read-Role** retrieves the Amazon Redshift credentials from **Secrets Manager**.
3. The **Lambda function** connects to the **Amazon Redshift cluster** and sends a query.
4. The **Amazon Redshift cluster** assumes the **CrossAccount-S3-Write-Role**.
5. The **CrossAccount-S3-Write-Role** assumes the **S3-Write-Role** in the DEV account.
6. The query results are unloaded to the **S3 bucket** in the DEV account.

## Tools

### AWS services

- [AWS Key Management Service \(AWS KMS\)](#) helps you create and control cryptographic keys to help protect your data.
- [AWS Lambda](#) is a compute service that helps you run code without needing to provision or manage servers. It runs your code only when needed and scales automatically, so you pay only for the compute time that you use.
- [Amazon Redshift](#) is a managed petabyte-scale data warehouse service in the AWS Cloud.



- [AWS Secrets Manager](#) helps you replace hardcoded credentials in your code, including passwords, with an API call to Secrets Manager to retrieve the secret programmatically.
- [Amazon Simple Storage Service \(Amazon S3\)](#) is a cloud-based object storage service that helps you store, protect, and retrieve any amount of data.

## Code repository

The code for this pattern is available in the GitHub [unload-redshift-to-s3-python](#) repository.

## Best practices

### Security disclaimer

Before you implement this solution, consider the following important security recommendations:

- Remember that connecting development and production accounts can increase the scope and lower overall security posture. We recommend deploying this solution only temporarily, extracting the required portion of data and then immediately destroying the deployed resources. To destroy the resources, you should delete the Lambda function, remove any IAM roles and policies created for this solution, and revoke any network access that was granted between the accounts.
- Consult your security and compliance teams before copying any data from production to development environments. Personally identifiable information (PII), Protected health information (PHI), and other confidential or regulated data should generally not be copied in this manner. Copy only publicly available, non-confidential information (for example, public stock data from a shop frontend). Consider tokenizing or anonymizing data, or generating synthetic test data, instead of using production data whenever possible. One of the [AWS security principles](#) is to keep people away from data. In other words, developers should not perform operations in the production account.
- Restrict access to the Lambda function in the development account because it can read data from the Amazon Redshift cluster in the production environment.
- To avoid disrupting the production environment, implement the following recommendations:
  - Use a separate, dedicated development account for testing and development activities.
  - Implement strict network access controls and limit traffic between accounts to only what is necessary.
  - Monitor and audit access to the production environment and data sources.

- Implement least-privilege access controls for all resources and services involved.
- Regularly review and rotate credentials, such as AWS Secrets Manager secrets and IAM role access keys.
- Refer to the following security documentation for the services used in this article:
  - [AWS Lambda security](#)
  - [Amazon Redshift security](#)
  - [Amazon S3 security](#)
  - [AWS Secrets Manager security](#)
  - [IAM security best practices](#)

Security is a top priority when accessing production data and resources. Always follow best practices, implement least-privilege access controls, and regularly review and update your security measures.

## Epics

### Query data from Amazon Redshift

Task	Description	Skills required
Create a secret for the Amazon Redshift cluster.	<p>To create the secret for the Amazon Redshift cluster, do the following:</p> <ol style="list-style-type: none"> <li>1. In the PROD account, sign in to the AWS Management Console, and open the Secrets Manager console at <a href="https://console.aws.amazon.com/secretsmanager/">https://console.aws.amazon.com/secretsmanager/</a>.</li> <li>2. Choose <b>Store a new Secret</b>.</li> </ol>	DevOps engineer

Task	Description	Skills required
	<ol style="list-style-type: none"><li>3. Select <b>Credentials for Amazon Redshift data warehouse</b>.</li><li>4. For <b>User name</b> and <b>Password</b>, enter values for your instance, and confirm or choose a value for <b>Encryption key</b>.</li><li>5. Choose the Amazon Redshift data warehouse that your secret will access.</li><li>6. Enter <code>Redshift-Creds-Secret</code> for the secret name.</li><li>7. Complete the remaining the creation steps with the default choices, and then choose <b>Store</b>.</li><li>8. View your secret, and note the <b>Secret ARN</b> value that was generated to identify the secret.</li></ol>	

Task	Description	Skills required
Create a role to access Secrets Manager.	<p>To create the role, do the following:</p> <ol style="list-style-type: none"><li>1. In the PROD account, open the IAM console at <a href="https://console.aws.amazon.com/iam/">https://console.aws.amazon.com/iam/</a>.</li><li>2. Choose <b>Policies</b>.</li><li>3. Choose <b>Create policy</b>.</li><li>4. Choose the <b>JSON</b> tab, and then enter an IAM policy such as the following:</li></ol> <pre data-bbox="634 835 1029 1801">{   "Version":     "2012-10-17",   "Statement": [     {       "Effect":         "Allow",       "Action":         [           "secretsmanager:Ge tResourcePolicy",           "secretsmanager:Ge tSecretValue",           "secretsmanager:De scribeSecret",           "secretsmanager:Li stSecretVersionIds"         ],       "Resource ": [</pre>	DevOps engineer

Task	Description	Skills required
	<pre data-bbox="630 212 1027 863"> "&lt;Redshift-Creds-Secret-ARN&gt;"       ]     },     {       "Effect":         "Allow",       "Action":         "secretsmanager:Li stSecrets",       "Resource ": "*"     }   ] } </pre> <p data-bbox="630 898 1016 1268">Replace Redshift-Creds-Secret-ARN with the Amazon Resource Name (ARN) of the Secrets Manager secret that contains the information and credentials for the Amazon Redshift cluster.</p>	

## Upload data to Amazon S3

Task	Description	Skills required
Create a role to access the S3 bucket.	<p data-bbox="591 1566 992 1696">To create the role for accessing the S3 bucket, do the following:</p> <ol data-bbox="591 1738 992 1873" style="list-style-type: none"> <li data-bbox="591 1738 992 1820">1. In the DEV account, open the IAM console.</li> <li data-bbox="591 1841 992 1873">2. Choose <b>Policies</b>.</li> </ol>	DevOps engineer

Task	Description	Skills required
	<p>3. Choose <b>Create policy</b>.</p> <p>4. Choose the <b>JSON</b> tab, and then enter an IAM policy such as the following:</p> <pre data-bbox="630 436 1029 1879">{   "Version":     "2012-10-17",   "Statement": [     {       "Sid": "kmsstmt"     },     {       "Effect":         "Allow",       "Action": [         "kms:Decr ypt",         "kms:Encr ypt",         "kms:Gene rateDataKey"       ],       "Resource": [         "&lt;kms-key- arn&gt;"       ]     },     {       "Sid":         "s3stmt",       "Effect":         "Allow",       "Action": [         "s3:PutOb ject",         "s3:Get*",         "s3:List*"       ],       "Resource": [         "arn:aws: s3:::mybucket",</pre>	

Task	Description	Skills required
	<pre data-bbox="630 205 1026 466">        "arn:aws: s3::mybucket/*"       ]     }   ] }</pre> <p data-bbox="630 499 1026 1066">Replace mybucket with the name of the S3 bucket that you want to access. Also, if the S3 bucket is encrypted, replace kms-key-arn with the ARN of the AWS Key Management Service (AWS KMS) key used to encrypt the S3 bucket. Otherwise, you don't need the AWS KMS section in the policy.</p> <ol data-bbox="591 1087 1026 1780" style="list-style-type: none"><li>5. Choose <b>Review policy</b>, enter S3-Write-Policy as the policy name, and then choose <b>Create policy</b>.</li><li>6. In the navigation pane, choose <b>Roles</b>.</li><li>7. Choose <b>Create role</b>.</li><li>8. For the trusted entity role, choose <b>Custom trust policy</b>.</li><li>9. Choose <b>Next: Permissions</b>, and then select the <b>S3-Write-Policy</b> policy that you created.</li></ol>	

Task	Description	Skills required
	10Enter S3-Write-Role as the role name, and then choose <b>Create role</b> .	



Task	Description	Skills required
Create the Amazon Redshift role.	<p>To create the Amazon Redshift role, do the following:</p> <ol style="list-style-type: none"><li>1. In the PROD account, open the IAM console.</li><li>2. Choose <b>Policies</b>.</li><li>3. Choose <b>Create policy</b>.</li><li>4. Choose the <b>JSON</b> tab, and then enter an IAM policy such as the following:</li></ol> <pre data-bbox="630 787 1029 1545">{   "Version":     "2012-10-17",   "Statement": [     {       "Sid":         "CrossAccountPolic y",       "Effect":         "Allow",       "Action":         "sts:AssumeRole",       "Resource ": "S3-Write-Role- ARN"     }   ] }</pre> <p>Replace <code>S3-Write-Role-ARN</code> with the ARN for the <code>S3-Write-Role</code> in the DEV account.</p> <ol style="list-style-type: none"><li>5. Choose <b>Review policy</b>, enter <code>S3-Write-Role-</code></li></ol>	DevOps engineer

Task	Description	Skills required
	<p>Assume-<b>Policy</b> as the policy name, and then choose <b>Create policy</b>.</p> <p>6. In the navigation pane, choose <b>Roles</b>, and then choose <b>Create role</b>.</p> <p>7. Choose <b>AWS service</b> as your trusted entity type, and then choose <b>Redshift, Redshift - Customizable</b>.</p> <p>8. Choose <b>Next: Permissions</b>, and then select the <b>S3-Write-Role-Assume-Policy</b> policy that you created.</p> <p>9. Enter <code>CrossAccount-S3-Write-Role</code> as the role name, and then choose <b>Create role</b>.</p> <p>10 <a href="#">Associate the IAM role</a> with your Amazon Redshift cluster.</p>	

## Deploy the Lambda function

Task	Description	Skills required
Deploy the Lambda function.	<p>To deploy a Lambda function in the peered VPC, do the following:</p> <ol style="list-style-type: none"> <li>1. Open the Lambda console at <a href="https://console.aws.amazon.com/lambda/">https://console.aws.amazon.com/lambda/</a>.</li> </ol>	DevOps engineer

Task	Description	Skills required
	<ol style="list-style-type: none"><li>2. Choose <b>Functions</b>.</li><li>3. Choose <b>Create function</b>.</li><li>4. Under <b>Basic information</b>, for <b>Function name</b>, enter a name for your function.</li><li>5. For <b>Runtime</b>, choose <b>Python 3.8</b>.</li><li>6. Expand <b>Change default execution role</b>, and then do the following:<ol style="list-style-type: none"><li>a. Choose <b>Use an existing role</b>.</li><li>b. For <b>Existing role</b>, select the <b>CrossAccount-RM-Read-Role</b> Lambda role that you created previously.</li></ol></li><li>7. Expand <b>Advanced settings</b>, and do the following:<ol style="list-style-type: none"><li>a. Select the <b>Enable VPC</b> check box.</li><li>b. For <b>VPC</b>, select the peered VPC in the DEV account.</li><li>c. For <b>Subnets</b>, select the private subnet.</li><li>d. For <b>Security groups</b>, select the default security group.</li></ol></li><li>8. Choose <b>Create function</b>.</li></ol>	

Task	Description	Skills required
	<p>9. Add the <a href="#">psycopg2</a> library as a <a href="#">layer</a> to the Lambda function.</p> <p><b>Note:</b> You can use an already deployed layer from the <a href="#">psycopg2-lambda-layer</a> repository. Make sure to use the URL based on your AWS Region and Python runtime.</p>	

## Test the architecture

Task	Description	Skills required
Import the required resources.	<p>To import the required resources, run the following commands:</p> <pre>import ast import boto3 import psycopg2 import base64 from botocore.exceptions import ClientError</pre>	App developer
Run the Lambda handler function.	The Lambda function uses AWS Security Token Service (AWS STS) for cross-account access and temporary credential management. The function uses the AssumeRole API operation to temporarily assume the permissions	App developer

Task	Description	Skills required
	<p>of the <code>sm_read_role</code> IAM role.</p> <p>To run the Lambda function, use the following example code:</p> <pre data-bbox="597 506 1024 1871">def lambda_handler(event, context):     sts_client = boto3.client('sts')      # Secrets Manager Configurations     secret_name = "redshift_creds"     sm_region = "eu-west-1"     sm_read_role = "arn:aws:iam::PROD_ACCOUNT_NUMBER:role/SM-Read-Role"      # S3 Bucket Configurations     s3_bucket_path = "s3://mybucket/"     s3_bucket_region = "eu-west-1"     s3_write_role = "arn:aws:iam::DEV_ACCOUNT_NUMBER:role/S3-Write-Role"      # Redshift Configurations     sql_query = "select * from category"     redshift_db = "dev"     redshift_s3_write_role = "arn:aws:"</pre>	

Task	Description	Skills required
	<pre> iam::PROD_ACCOUNT_ NUMBER:role/CrossA ccount-S3-Write-Role"      chained_s3_write_r ole = "%s,%s" %     (redshift_s3_write _role, s3_write_role)      assumed_role_objec t = sts_client.assume_ role(     RoleArn=s m_read_role,     RoleSessi onName="CrossAccou ntRoleAssumption",     ExternalI d="YOUR_EXTERNAL_ID",     )     credentials =     assumed_role_objec t['Credentials']      secret_dict =     ast.literal_eval(g et_secret(credenti als, secret_name, sm_region))     execute_query(secr et_dict, sql_query , s3_bucket_path,     chained_s3_write_r ole, s3_bucket_region, redshift_db)      return {         'statusCode': 200     } </pre>	

Task	Description	Skills required
Get the secret.	<p>To get the Amazon Redshift secret, use the following example code:</p> <pre data-bbox="592 394 1031 1877">def get_secret(credentials, secret_name, sm_region):     # Create a Secrets Manager client     session = boto3.session.Session()     sm_client = session.client(         service_name='secretsmanager',         aws_access_key_id=credentials['AccessKeyId'],         aws_secret_access_key=credentials['SecretAccessKey'],         aws_session_token=credentials['SessionToken'],         region_name=sm_region     )      try:         get_secret_value_response = sm_client.get_secret_value(             SecretId=secret_name         )     except ClientError as e:         print(e)         raise e</pre>	App developer

Task	Description	Skills required
	<pre>        else:             if 'SecretString' in get_secret_value_response:                 return                 get_secret_value_response['SecretString']             else:                 return                 base64.b64decode(get_secret_value_response['SecretBinary'])</pre>	



Task	Description	Skills required
Run the unload command.	<p>To unload the data to the S3 bucket, use the following example code.</p> <pre data-bbox="597 394 1027 1837"> def execute_query(secret_dict, sql_query, s3_bucket_path, chained_s3_write_role, s3_bucket_region, redshift_db):     conn_string = "dbname='%s' port='%s' user='%s' password='%s' host='%s' " \                  % (redshift_db, secret_dict["port"], secret_dict["username"], secret_dict["password"], secret_dict["host"])      con = psycopg2.connect(conn_string)      unload_command = "UNLOAD ('{}') TO '{}' IAM_ROLE '{}' DELIMITER ' ' REGION '{}';" \                      .format(sql_query, s3_bucket_path + str(datetime.datetime.now()) + ".csv",</pre>	App developer

Task	Description	Skills required
	<pre> chained_s3_write_role,  s3_bucket_region)  # Opening a cursor and run query cur = con.cursor() cur.execute(unload _command)  print(cur.fetchone ()) cur.close() con.close() </pre>	

## Clean up

Task	Description	Skills required
Delete the Lambda function.	<p>To avoid incurring unplanned costs, remove the resources and the connection between the DEV and PROD accounts.</p> <p>To remove the Lambda function, do the following:</p> <ol style="list-style-type: none"> <li>1. Open the AWS Lambda console at <a href="https://console.aws.amazon.com/lambda/">https://console.aws.amazon.com/lambda/</a>.</li> <li>2. Locate and select the Lambda function you created.</li> </ol>	DevOps engineer

Task	Description	Skills required
	<ol style="list-style-type: none"><li>3. Choose <b>Actions</b>, and then choose <b>Delete</b>.</li><li>4. Confirm the deletion.</li></ol>	

Task	Description	Skills required
Remove the IAM roles and policies.	<p>Remove the IAM roles and policies from the DEV and PROD accounts.</p> <p>In the DEV account, do the following:</p> <ol style="list-style-type: none"><li>1. Open the IAM console.</li><li>2. Delete the following roles:<ul style="list-style-type: none"><li>• S3-Write-Role</li><li>• CrossAccount-RM-Read-Role (Lambda role)</li></ul></li><li>3. Delete the associated policies:<ul style="list-style-type: none"><li>• S3-Write-Policy</li><li>• The CrossAccount policy for assuming PROD account roles</li></ul></li></ol> <p>In the PROD account, do the following:</p> <ol style="list-style-type: none"><li>1. Open the IAM console.</li><li>2. Delete the following roles:<ul style="list-style-type: none"><li>• SM-Read-Role</li><li>• CrossAccount-S3-Write-Role</li></ul></li><li>3. Delete the associated policies:<ul style="list-style-type: none"><li>• The CrossAccount policy for accessing Secrets Manager</li></ul></li></ol>	DevOps engineer

Task	Description	Skills required
	<ul style="list-style-type: none"><li>• S3-Write-Role-Assume-Policy</li></ul>	
Delete the secret in Secrets Manager.	<p>To delete the secret, do the following:</p> <ol style="list-style-type: none"><li>1. In the PROD account, open the Secrets Manager console.</li><li>2. Locate and select the secret named Redshift-Creds-Secret .</li><li>3. Choose <b>Actions</b>, and then choose <b>Delete secret</b>.</li><li>4. Confirm the deletion.</li></ol>	DevOps engineer

Task	Description	Skills required
Remove VPC peering and security group rules.	<p>To remove VPC peering and security group rules, do the following:</p> <ol style="list-style-type: none"><li>1. In the PROD account, open the Amazon EC2 console at <a href="https://console.aws.amazon.com/ec2/">https://console.aws.amazon.com/ec2/</a>.</li><li>2. Navigate to <b>Security Groups</b>.</li><li>3. Find the security group used by the Amazon Redshift cluster.</li><li>4. Edit the inbound rules, and remove the rule that allows connections from the DEV account's Lambda VPC.</li><li>5. Navigate to <b>VPC Peering Connections</b>, and delete the peering connection.</li></ol>	DevOps engineer
Remove data from the S3 bucket.	<p>To remove the data from Amazon S3, do the following:</p> <ol style="list-style-type: none"><li>1. In the DEV account, open the Amazon S3 console at <a href="https://console.aws.amazon.com/s3/">https://console.aws.amazon.com/s3/</a>.</li><li>2. Locate the bucket you used for data storage.</li><li>3. Delete the objects within the bucket, or delete the entire bucket if it's no longer needed.</li></ol>	DevOps engineer

Task	Description	Skills required
Clean up AWS KMS keys.	<p>If you created any custom AWS KMS keys for encryption, do the following:</p> <ol style="list-style-type: none"><li>1. Open the AWS KMS console at <a href="https://console.aws.amazon.com/kms/">https://console.aws.amazon.com/kms/</a>.</li><li>2. Locate any keys created for this pattern.</li><li>3. Schedule the keys for deletion. (There is a mandatory waiting period for key deletion).</li></ol>	DevOps engineer
Review and delete Amazon CloudWatch logs.	<p>To delete the CloudWatch logs, do the following:</p> <ol style="list-style-type: none"><li>1. Open the CloudWatch console at <a href="https://console.aws.amazon.com/cloudwatch/">https://console.aws.amazon.com/cloudwatch/</a>.</li><li>2. Check for any log groups created by your Lambda function or Amazon Redshift cluster.</li><li>3. Delete these log groups if they are no longer needed.</li></ol>	DevOps engineer

## Related resources

- [Amazon CloudWatch documentation](#)
- [IAM documentation](#)
- [Lambda documentation](#)

- [Amazon Redshift documentation](#)
- [Amazon S3 documentation](#)
- [AWS Secrets Manager documentation](#)
- [AWS security principles](#)

## Additional information

After you unload the data from Amazon Redshift to Amazon S3, you can analyze it by using Amazon Athena.

[Amazon Athena](#) is a big data query service that's beneficial when you need to access large volumes of data. You can use Athena without having to provision servers or databases. Athena supports complex queries, and you can run it on different objects.

As with most AWS services, the main benefit to using Athena is that it provides great flexibility in how you run queries without the added complexity. When you use Athena, you can query different data types, such as CSV and JSON, in Amazon S3 without changing the data type. You can query data from various sources, including outside AWS. Athena reduces complexity because you don't have to manage servers. Athena reads data directly from Amazon S3 without loading or changing the data before you run the query.



# Database migration patterns by workload

## Topics

- [IBM](#)
- [Microsoft](#)
- [N/A](#)
- [Open-source](#)
- [Oracle](#)
- [SAP](#)

## IBM

- [Migrate a Db2 database from Amazon EC2 to Aurora MySQL-Compatible by using AWS DMS](#)
- [Migrate Db2 for LUW to Amazon EC2 by using log shipping to reduce outage time](#)
- [Migrate Db2 for LUW to Amazon EC2 with high availability disaster recovery](#)
- [Migrate from IBM Db2 on Amazon EC2 to Aurora PostgreSQL-Compatible using AWS DMS and AWS SCT](#)
- [Migrate from IBM WebSphere Application Server to Apache Tomcat on Amazon EC2](#)
- [Secure and streamline user access in a Db2 federation database on AWS by using trusted contexts](#)

## Microsoft

- [Accelerate the discovery and migration of Microsoft workloads to AWS](#)
- [Access on-premises Microsoft SQL Server tables from Microsoft SQL Server on Amazon EC2 using linked servers](#)
- [Assess query performance for migrating SQL Server databases to MongoDB Atlas on AWS](#)
- [Change Python and Perl applications to support database migration from Microsoft SQL Server to Amazon Aurora PostgreSQL-Compatible Edition](#)
- [Configure read-only routing in an Always On availability group in SQL Server on AWS](#)
- [Create AWS CloudFormation templates for AWS DMS tasks using Microsoft Excel and Python](#)
- [Export a Microsoft SQL Server database to Amazon S3 by using AWS DMS](#)
- [Export Amazon RDS for SQL Server tables to an S3 bucket by using AWS DMS](#)
- [Ingest and migrate EC2 Windows instances into an AWS Managed Services account](#)
- [Migrate a messaging queue from Microsoft Azure Service Bus to Amazon SQS](#)
- [Migrate a Microsoft SQL Server database from Amazon EC2 to Amazon DocumentDB by using AWS DMS](#)
- [Migrate a Microsoft SQL Server database to Aurora MySQL by using AWS DMS and AWS SCT](#)
- [Migrate a .NET application from Microsoft Azure App Service to AWS Elastic Beanstalk](#)
- [Migrate an on-premises Microsoft SQL Server database to Amazon EC2](#)
- [Migrate an on-premises Microsoft SQL Server database to Amazon RDS for SQL Server](#)
- [Migrate an on-premises Microsoft SQL Server database to Amazon RDS for SQL Server using linked servers](#)
- [Migrate an on-premises Microsoft SQL Server database to Amazon RDS for SQL Server using native backup and restore methods](#)
- [Migrate an on-premises Microsoft SQL Server database to Amazon Redshift using AWS DMS](#)
- [Migrate an on-premises Microsoft SQL Server database to Amazon Redshift using AWS SCT data extraction agents](#)
- [Migrate an on-premises Microsoft SQL Server database to Microsoft SQL Server on Amazon EC2 running Linux](#)
- [Migrate data from Microsoft Azure Blob to Amazon S3 by using Rclone](#)
- [Migrate SQL Server to AWS using distributed availability groups](#)
- [Migrate Windows SSL certificates to an Application Load Balancer using ACM](#)

- [Rehost on-premises workloads in the AWS Cloud: migration checklist](#)
- [Send notifications for an Amazon RDS for SQL Server database instance by using an on-premises SMTP server and Database Mail](#)
- [Set up a CI/CD pipeline for database migration by using Terraform](#)
- [Set up Multi-AZ infrastructure for a SQL Server Always On FCI by using Amazon FSx](#)

## N/A

- [Create an approval process for firewall requests during a rehost migration to AWS](#)
- [Encrypt an existing Amazon RDS for PostgreSQL DB instance](#)
- [Estimate storage costs for an Amazon DynamoDB table](#)
- [Implement cross-Region disaster recovery with AWS DMS and Amazon Aurora](#)

## Open-source

- [Connect by using an SSH tunnel in pgAdmin](#)
- [Create application users and roles in Aurora PostgreSQL-Compatible](#)
- [Enable encrypted connections for PostgreSQL DB instances in Amazon RDS](#)
- [Migrate an on-premises MariaDB database to Amazon RDS for MariaDB using native tools](#)
- [Migrate an on-premises MySQL database to Amazon EC2](#)
- [Migrate an on-premises MySQL database to Amazon RDS for MySQL](#)
- [Migrate an on-premises MySQL database to Aurora MySQL](#)
- [Migrate an on-premises PostgreSQL database to Aurora PostgreSQL](#)
- [Migrate from IBM WebSphere Application Server to Apache Tomcat on Amazon EC2 with Auto Scaling](#)
- [Migrate from Oracle 8i or 9i to Amazon RDS for Oracle using SharePlex and AWS DMS](#)
- [Migrate from Oracle GlassFish to AWS Elastic Beanstalk](#)
- [Migrate from PostgreSQL on Amazon EC2 to Amazon RDS for PostgreSQL using pglogical](#)
- [Migrate on-premises Java applications to AWS using AWS App2Container](#)
- [Migrate on-premises MySQL databases to Aurora MySQL using Percona XtraBackup, Amazon EFS, and Amazon S3](#)
- [Migrate Oracle external tables to Amazon Aurora PostgreSQL-Compatible](#)
- [Migrate Oracle functions and procedures that have more than 100 arguments to PostgreSQL](#)
- [Migrate Redis workloads to Redis Enterprise Cloud on AWS](#)
- [Monitor Amazon Aurora for instances without encryption](#)
- [Restart the AWS Replication Agent automatically without disabling SELinux after rebooting a RHEL source server](#)
- [Schedule jobs for Amazon RDS for PostgreSQL and Aurora PostgreSQL by using Lambda and Secrets Manager](#)
- [Set up data replication between Amazon RDS for MySQL and MySQL on Amazon EC2 using GTID](#)
- [Transport PostgreSQL databases between two Amazon RDS DB instances using pg\\_transport](#)
- [Unload data from an Amazon Redshift cluster across accounts to Amazon S3](#)

# Oracle

- [Add HA to Oracle PeopleSoft on Amazon RDS Custom by using a read replica](#)
- [Configure links between Oracle Database and Aurora PostgreSQL-Compatible](#)
- [Convert JSON Oracle queries into PostgreSQL database SQL](#)
- [Convert VARCHAR2\(1\) data type for Oracle to Boolean data type for Amazon Aurora PostgreSQL](#)
- [Emulate Oracle DR by using a PostgreSQL-compatible Aurora global database](#)
- [Emulate Oracle RAC workloads using custom endpoints in Aurora PostgreSQL](#)
- [Estimate the Amazon RDS engine size for an Oracle database by using AWR reports](#)
- [Handle anonymous blocks in Dynamic SQL statements in Aurora PostgreSQL](#)
- [Handle overloaded Oracle functions in Aurora PostgreSQL-Compatible](#)
- [Incrementally migrate from Amazon RDS for Oracle to Amazon RDS for PostgreSQL using Oracle SQL Developer and AWS SCT](#)
- [Load BLOB files into TEXT by using file encoding in Aurora PostgreSQL-Compatible](#)
- [Migrate Amazon RDS for Oracle DB instances to other accounts that use AMS](#)
- [Migrate Amazon RDS for Oracle to Amazon RDS for PostgreSQL in SSL mode by using AWS DMS](#)
- [Migrate Amazon RDS for Oracle to Amazon RDS for PostgreSQL with AWS SCT and AWS DMS using AWS CLI and AWS CloudFormation](#)
- [Migrate an Amazon RDS for Oracle database to another AWS account and AWS Region using AWS DMS for ongoing replication](#)
- [Migrate an Amazon RDS for Oracle DB instance to another VPC](#)
- [Migrate an on-premises Oracle database to Amazon EC2 by using Oracle Data Pump](#)
- [Migrate an on-premises Oracle database to Amazon OpenSearch Service using Logstash](#)
- [Migrate an on-premises Oracle database to Amazon RDS for MySQL using AWS DMS and AWS SCT](#)
- [Migrate an on-premises Oracle database to Amazon RDS for Oracle](#)
- [Migrate an on-premises Oracle database to Amazon RDS for Oracle by using direct Oracle Data Pump Import over a database link](#)
- [Migrate an on-premises Oracle database to Amazon RDS for Oracle using Oracle Data Pump](#)
- [Migrate an on-premises Oracle database to Amazon RDS for PostgreSQL by using an Oracle bystander and AWS DMS](#)
- [Migrate an on-premises Oracle database to Oracle on Amazon EC2](#)

- [Migrate an Oracle database from Amazon EC2 to Amazon RDS for MariaDB using AWS DMS and AWS SCT](#)
- [Migrate an Oracle database from Amazon EC2 to Amazon RDS for Oracle using AWS DMS](#)
- [Migrate an Oracle database to Amazon DynamoDB using AWS DMS](#)
- [Migrate an Oracle database to Amazon RDS for Oracle by using Oracle GoldenGate flat file adapters](#)
- [Migrate an Oracle Database to Amazon Redshift using AWS DMS and AWS SCT](#)
- [Migrate an Oracle database to Aurora PostgreSQL using AWS DMS and AWS SCT](#)
- [Migrate an Oracle JD Edwards EnterpriseOne database to AWS by using Oracle Data Pump and AWS DMS](#)
- [Migrate an Oracle partitioned table to PostgreSQL by using AWS DMS](#)
- [Migrate an Oracle PeopleSoft database to AWS by using AWS DMS](#)
- [Migrate data from an on-premises Oracle database to Aurora PostgreSQL](#)
- [Migrate from Amazon RDS for Oracle to Amazon RDS for MySQL](#)
- [Migrate from Oracle 8i or 9i to Amazon RDS for PostgreSQL using materialized views and AWS DMS](#)
- [Migrate from Oracle 8i or 9i to Amazon RDS for PostgreSQL using SharePlex and AWS DMS](#)
- [Migrate from Oracle Database to Amazon RDS for PostgreSQL by using Oracle GoldenGate](#)
- [Migrate from Oracle on Amazon EC2 to Amazon RDS for MySQL using AWS DMS and AWS SCT](#)
- [Migrate from Oracle to Amazon DocumentDB using AWS DMS](#)
- [Migrate from Oracle WebLogic to Apache Tomcat \(TomEE\) on Amazon ECS](#)
- [Migrate function-based indexes from Oracle to PostgreSQL](#)
- [Migrate legacy applications from Oracle Pro\\*C to ECPG](#)
- [Migrate Oracle CLOB values to individual rows in PostgreSQL on AWS](#)
- [Migrate Oracle Database error codes to an Amazon Aurora PostgreSQL-Compatible database](#)
- [Migrate Oracle E-Business Suite to Amazon RDS Custom](#)
- [Migrate Oracle native functions to PostgreSQL using extensions](#)
- [Migrate Oracle OUT bind variables to a PostgreSQL database](#)
- [Migrate Oracle PeopleSoft to Amazon RDS Custom](#)
- [Migrate Oracle ROWID functionality to PostgreSQL on AWS](#)
- [Migrate Oracle SERIALLY\\_REUSABLE pragma packages into PostgreSQL](#)



- [Migrate virtual generated columns from Oracle to PostgreSQL](#)
- [Monitor Oracle GoldenGate logs by using Amazon CloudWatch](#)
- [Replatform Oracle Database Enterprise Edition to Standard Edition 2 on Amazon RDS for Oracle](#)
- [Set up an HA/DR architecture for Oracle E-Business Suite on Amazon RDS Custom with an active standby database](#)
- [Set up Oracle UTL\\_FILE functionality on Aurora PostgreSQL-Compatible](#)
- [Transition roles for an Oracle PeopleSoft application on Amazon RDS Custom for Oracle](#)
- [Validate database objects after migrating from Oracle to Amazon Aurora PostgreSQL](#)

## SAP

- [Automatically back up SAP HANA databases using Systems Manager and EventBridge](#)
- [Migrate an on-premises SAP ASE database to Amazon EC2](#)
- [Migrate from SAP ASE to Amazon RDS for SQL Server using AWS DMS](#)
- [Migrate SAP ASE on Amazon EC2 to Amazon Aurora PostgreSQL-Compatible using AWS SCT and AWS DMS](#)
- [Migrate SAP HANA to AWS using SAP HSR with the same hostname](#)
- [Reduce homogeneous SAP migration cutover time by using Application Migration Service](#)
- [Set up disaster recovery for SAP on IBM Db2 on AWS](#)

## More patterns

- [Access an Amazon Neptune database from an Amazon EKS container](#)
- [Access, query, and join Amazon DynamoDB tables using Athena](#)
- [Aggregate data in Amazon DynamoDB for ML forecasting in Athena](#)
- [Allow EC2 instances write access to S3 buckets in AMS accounts](#)
- [Analyze and visualize nested JSON data with Amazon Athena and Amazon QuickSight](#)
- [Authenticate Microsoft SQL Server on Amazon EC2 using AWS Directory Service](#)
- [Automate backups for Amazon RDS for PostgreSQL DB instances by using AWS Batch](#)
- [Automatically archive items to Amazon S3 using DynamoDB TTL](#)
- [Automatically generate a PynamoDB model and CRUD functions for Amazon DynamoDB by using a Python application](#)
- [Automatically remediate unencrypted Amazon RDS DB instances and clusters](#)
- [Automatically stop and start an Amazon RDS DB instance using AWS Systems Manager Maintenance Windows](#)
- [Build a loosely coupled architecture with microservices using DevOps practices and AWS Cloud9](#)
- [Change Python and Perl applications to support database migration from Microsoft SQL Server to Amazon Aurora PostgreSQL-Compatible Edition](#)
- [Configure links between Oracle Database and Aurora PostgreSQL-Compatible](#)
- [Convert and unpack EBCDIC data to ASCII on AWS by using Python](#)
- [Convert the Teradata NORMALIZE temporal feature to Amazon Redshift SQL](#)
- [Convert the Teradata RESET WHEN feature to Amazon Redshift SQL](#)
- [Convert VARCHAR2\(1\) data type for Oracle to Boolean data type for Amazon Aurora PostgreSQL](#)
- [Create application users and roles in Aurora PostgreSQL-Compatible](#)
- [Create AWS CloudFormation templates for AWS DMS tasks using Microsoft Excel and Python](#)
- [Deliver DynamoDB records to Amazon S3 using Kinesis Data Streams and Firehose with AWS CDK](#)
- [Deploy a Cassandra cluster on Amazon EC2 with private static IPs to avoid rebalancing](#)
- [Develop advanced generative AI chat-based assistants by using RAG and ReAct prompting](#)
- [Emulate Oracle DR by using a PostgreSQL-compatible Aurora global database](#)
- [Enable transparent data encryption in Amazon RDS for SQL Server](#)
- [Export a Microsoft SQL Server database to Amazon S3 by using AWS DMS](#)

- [Incrementally migrate from Amazon RDS for Oracle to Amazon RDS for PostgreSQL using Oracle SQL Developer and AWS SCT](#)
- [Load BLOB files into TEXT by using file encoding in Aurora PostgreSQL-Compatible](#)
- [Manage credentials using AWS Secrets Manager](#)
- [Migrate a Db2 database from Amazon EC2 to Aurora MySQL-Compatible by using AWS DMS](#)
- [Migrate a Microsoft SQL Server database from Amazon EC2 to Amazon DocumentDB by using AWS DMS](#)
- [Migrate a Microsoft SQL Server database to Aurora MySQL by using AWS DMS and AWS SCT](#)
- [Migrate a self-hosted MongoDB environment to MongoDB Atlas on the AWS Cloud](#)
- [Migrate a Teradata database to Amazon Redshift using AWS SCT data extraction agents](#)
- [Migrate Amazon RDS for Oracle to Amazon RDS for PostgreSQL in SSL mode by using AWS DMS](#)
- [Migrate Amazon RDS for Oracle to Amazon RDS for PostgreSQL with AWS SCT and AWS DMS using AWS CLI and AWS CloudFormation](#)
- [Migrate an Amazon RDS DB instance to another VPC or account](#)
- [Migrate an Amazon RDS for Oracle database to another AWS account and AWS Region using AWS DMS for ongoing replication](#)
- [Migrate an Amazon RDS for Oracle DB instance to another VPC](#)
- [Migrate an Amazon Redshift cluster to an AWS Region in China](#)
- [Migrate an on-premises MariaDB database to Amazon RDS for MariaDB using native tools](#)
- [Migrate an on-premises Microsoft SQL Server database to Amazon EC2](#)
- [Migrate an on-premises Microsoft SQL Server database to Amazon RDS for SQL Server](#)
- [Migrate an on-premises Microsoft SQL Server database to Amazon RDS for SQL Server using linked servers](#)
- [Migrate an on-premises Microsoft SQL Server database to Amazon RDS for SQL Server using native backup and restore methods](#)
- [Migrate an on-premises Microsoft SQL Server database to Amazon Redshift using AWS DMS](#)
- [Migrate an on-premises Microsoft SQL Server database to Amazon Redshift using AWS SCT data extraction agents](#)
- [Migrate an on-premises Microsoft SQL Server database to Microsoft SQL Server on Amazon EC2 running Linux](#)
- [Migrate an on-premises MySQL database to Amazon EC2](#)
- [Migrate an on-premises MySQL database to Amazon RDS for MySQL](#)

- [Migrate an on-premises MySQL database to Aurora MySQL](#)
- [Migrate an on-premises Oracle database to Amazon EC2 by using Oracle Data Pump](#)
- [Migrate an on-premises Oracle database to Amazon OpenSearch Service using Logstash](#)
- [Migrate an on-premises Oracle database to Amazon RDS for MySQL using AWS DMS and AWS SCT](#)
- [Migrate an on-premises Oracle database to Amazon RDS for Oracle](#)
- [Migrate an on-premises Oracle database to Amazon RDS for Oracle by using direct Oracle Data Pump Import over a database link](#)
- [Migrate an on-premises Oracle database to Amazon RDS for Oracle using Oracle Data Pump](#)
- [Migrate an on-premises Oracle database to Amazon RDS for PostgreSQL by using an Oracle bystander and AWS DMS](#)
- [Migrate an on-premises Oracle database to Oracle on Amazon EC2](#)
- [Migrate an on-premises PostgreSQL database to Aurora PostgreSQL](#)
- [Migrate an on-premises SAP ASE database to Amazon EC2](#)
- [Migrate an on-premises ThoughtSpot Falcon database to Amazon Redshift](#)
- [Migrate an on-premises Vertica database to Amazon Redshift using AWS SCT data extraction agents](#)
- [Migrate an Oracle database from Amazon EC2 to Amazon RDS for MariaDB using AWS DMS and AWS SCT](#)
- [Migrate an Oracle database from Amazon EC2 to Amazon RDS for Oracle using AWS DMS](#)
- [Migrate an Oracle database to Amazon DynamoDB using AWS DMS](#)
- [Migrate an Oracle database to Amazon RDS for Oracle by using Oracle GoldenGate flat file adapters](#)
- [Migrate an Oracle Database to Amazon Redshift using AWS DMS and AWS SCT](#)
- [Migrate an Oracle database to Aurora PostgreSQL using AWS DMS and AWS SCT](#)
- [Migrate an Oracle JD Edwards EnterpriseOne database to AWS by using Oracle Data Pump and AWS DMS](#)
- [Migrate an Oracle partitioned table to PostgreSQL by using AWS DMS](#)
- [Migrate an Oracle PeopleSoft database to AWS by using AWS DMS](#)
- [Migrate data from an on-premises Oracle database to Aurora PostgreSQL](#)
- [Migrate data to the AWS Cloud by using Starburst](#)
- [Migrate Db2 for LUW to Amazon EC2 by using log shipping to reduce outage time](#)

- [Migrate Db2 for LUW to Amazon EC2 with high availability disaster recovery](#)
- [Migrate from Amazon RDS for Oracle to Amazon RDS for MySQL](#)
- [Migrate from Couchbase Server to Couchbase Capella on AWS](#)
- [Migrate from IBM Db2 on Amazon EC2 to Aurora PostgreSQL-Compatible using AWS DMS and AWS SCT](#)
- [Migrate from Oracle 8i or 9i to Amazon RDS for PostgreSQL using materialized views and AWS DMS](#)
- [Migrate from Oracle 8i or 9i to Amazon RDS for PostgreSQL using SharePlex and AWS DMS](#)
- [Migrate from Oracle Database to Amazon RDS for PostgreSQL by using Oracle GoldenGate](#)
- [Migrate from Oracle on Amazon EC2 to Amazon RDS for MySQL using AWS DMS and AWS SCT](#)
- [Migrate from Oracle to Amazon DocumentDB using AWS DMS](#)
- [Migrate from PostgreSQL on Amazon EC2 to Amazon RDS for PostgreSQL using pglogical](#)
- [Migrate from SAP ASE to Amazon RDS for SQL Server using AWS DMS](#)
- [Migrate function-based indexes from Oracle to PostgreSQL](#)
- [Migrate legacy applications from Oracle Pro\\*C to ECPG](#)
- [Migrate on-premises Cloudera workloads to Cloudera Data Platform on AWS](#)
- [Migrate on-premises MySQL databases to Aurora MySQL using Percona XtraBackup, Amazon EFS, and Amazon S3](#)
- [Migrate Oracle Business Intelligence 12c to the AWS Cloud from on-premises servers](#)
- [Migrate Oracle CLOB values to individual rows in PostgreSQL on AWS](#)
- [Migrate Oracle Database error codes to an Amazon Aurora PostgreSQL-Compatible database](#)
- [Migrate Oracle E-Business Suite to Amazon RDS Custom](#)
- [Migrate Oracle external tables to Amazon Aurora PostgreSQL-Compatible](#)
- [Migrate Oracle native functions to PostgreSQL using extensions](#)
- [Migrate Oracle PeopleSoft to Amazon RDS Custom](#)
- [Migrate Oracle ROWID functionality to PostgreSQL on AWS](#)
- [Migrate Oracle SERIALLY\\_REUSABLE pragma packages into PostgreSQL](#)
- [Migrate Redis workloads to Redis Enterprise Cloud on AWS](#)
- [Migrate SAP ASE on Amazon EC2 to Amazon Aurora PostgreSQL-Compatible using AWS SCT and AWS DMS](#)
- [Migrate virtual generated columns from Oracle to PostgreSQL](#)

- [Set up a minimum viable data space to share data between organizations](#)
- [Monitor Amazon ElastiCache clusters for at-rest encryption](#)
- [Monitor ElastiCache clusters for security groups](#)
- [Reduce homogeneous SAP migration cutover time by using Application Migration Service](#)
- [Rotate database credentials without restarting containers](#)
- [Run message-driven workloads at scale by using AWS Fargate](#)
- [Set up a highly available PeopleSoft architecture on AWS](#)
- [Set up Oracle UTL\\_FILE functionality on Aurora PostgreSQL-Compatible](#)
- [Transfer large-scale Db2 z/OS data to Amazon S3 in CSV files](#)
- [Transport PostgreSQL databases between two Amazon RDS DB instances using pg\\_transport](#)
- [Use CloudEndure for disaster recovery of an on-premises database](#)
- [Validate database objects after migrating from Oracle to Amazon Aurora PostgreSQL](#)
- [Verify that new Amazon Redshift clusters launch in a VPC](#)

# DevOps

## Topics

- [Automate AWS resource assessment](#)
- [Install SAP systems automatically by using open-source tools](#)
- [Automate AWS Service Catalog portfolio and product deployment by using AWS CDK](#)
- [Automate event-driven backups from CodeCommit to Amazon S3 using CodeBuild and CloudWatch Events](#)
- [Automate stack set deployment by using AWS CodePipeline and AWS CodeBuild](#)
- [Automatically attach an AWS managed policy for Systems Manager to EC2 instance profiles using Cloud Custodian and AWS CDK](#)
- [Automatically build CI/CD pipelines and Amazon ECS clusters for microservices using AWS CDK](#)
- [Build a loosely coupled architecture with microservices using DevOps practices and AWS Cloud9](#)
- [Build and push Docker images to Amazon ECR using GitHub Actions and Terraform](#)
- [Build and test iOS apps with AWS CodeCommit, AWS CodePipeline, and AWS Device Farm](#)
- [Check AWS CDK applications or CloudFormation templates for best practices by using cdk-nag rule packs](#)
- [Configure mutual TLS authentication for applications running on Amazon EKS](#)
- [Create a custom log parser for Amazon ECS using a Firelens log router](#)
- [Create a pipeline and AMI using CodePipeline and HashiCorp Packer](#)
- [Create a pipeline and deploy artifact updates to on-premises EC2 instances using CodePipeline](#)
- [Create dynamic CI pipelines for Java and Python projects automatically](#)
- [Deploy CloudWatch Synthetics canaries by using Terraform](#)
- [Deploy a CI/CD pipeline for Java microservices on Amazon ECS](#)
- [Use AWS CodeCommit and AWS CodePipeline to deploy a CI/CD pipeline in multiple AWS accounts](#)
- [Deploy a ChatOps solution to manage SAST scan results by using AWS Chatbot custom actions and AWS CloudFormation](#)
- [Deploy a firewall using AWS Network Firewall and AWS Transit Gateway](#)
- [Deploy an AWS Glue job with an AWS CodePipeline CI/CD pipeline](#)
- [Deploy an Amazon EKS cluster from AWS Cloud9 using an EC2 instance profile](#)



- [Deploy code in multiple AWS Regions using AWS CodePipeline, AWS CodeCommit, and AWS CodeBuild](#)
- [Execute Amazon Redshift SQL queries by using Terraform](#)
- [Export AWS Backup reports from across an organization in AWS Organizations as a CSV file](#)
- [Export tags for a list of Amazon EC2 instances to a CSV file](#)
- [Generate an AWS CloudFormation template containing AWS Config managed rules using Troposphere](#)
- [Give SageMaker notebook instances temporary access to a CodeCommit repository in another AWS account](#)
- [Implement a GitHub Flow branching strategy for multi-account DevOps environments](#)
- [Implement a Gitflow branching strategy for multi-account DevOps environments](#)
- [Implement a Trunk branching strategy for multi-account DevOps environments](#)
- [Implement centralized custom Checkov scanning to enforce policy before deploying AWS infrastructure](#)
- [Automatically detect changes and initiate different CodePipeline pipelines for a monorepo in CodeCommit](#)
- [Integrate a Bitbucket repository with AWS Amplify using AWS CloudFormation](#)
- [Launch a CodeBuild project across AWS accounts using Step Functions and a Lambda proxy function](#)
- [Manage blue/green deployments of microservices to multiple accounts and Regions by using AWS code services and AWS KMS multi-Region keys](#)
- [Monitor Amazon ECR repositories for wildcard permissions using AWS CloudFormation and AWS Config](#)
- [Perform custom actions from AWS CodeCommit events](#)
- [Publish Amazon CloudWatch metrics to a CSV file](#)
- [Remove Amazon EC2 entries in the same AWS account from AWS Managed Microsoft AD by using AWS Lambda automation](#)
- [Run unit tests for Python ETL jobs in AWS Glue using the pytest framework](#)
- [Set up a Helm v3 chart repository in Amazon S3](#)
- [Set up a CI/CD pipeline by using AWS CodePipeline and AWS CDK](#)
- [Set up end-to-end encryption for applications on Amazon EKS using cert-manager and Let's Encrypt](#)

- [Simplify Amazon EKS multi-tenant application deployment by using Flux](#)
- [Subscribe multiple email endpoints to an SNS topic by using a custom resource](#)
- [Use Serverspec for test-driven development of infrastructure code](#)
- [Use third-party Git source repositories in AWS CodePipeline](#)
- [Create a CI/CD pipeline to validate Terraform configurations by using AWS CodePipeline](#)
- [More patterns](#)

# Automate AWS resource assessment

Created by Naveen Suthar (AWS), Arun Bagal (AWS), Manish Garg (AWS), and Sandeep Gawande (AWS)

**Code repository:** [infrastructure-assessment-iac-automation](#)

**Environment:** PoC or pilot

**Technologies:** DevOps; Infrastructure; Management & governance; Operations; Serverless

**AWS services:** Amazon Athena; AWS CloudTrail; AWS Lambda; Amazon S3; Amazon QuickSight

## Summary

This pattern describes an automated approach for setting up resource assessment capabilities by using the [AWS Cloud Development Kit \(AWS CDK\)](#). By using this pattern, operations teams gather resource auditing details in an automated manner and view the details of all resources deployed in an AWS account on a single dashboard. This is helpful in the following use cases:

- Identifying infrastructure as code (IaC) tools and isolating resources created by different IaC solutions such as [HashiCorp Terraform](#), [AWS CloudFormation](#), AWS CDK, and [AWS Command Line Interface \(AWS CLI\)](#)
- Fetching resource-auditing information

This solution will also help the leadership team obtain insights about the resources and activities in an AWS account from a single dashboard.

**Note:** [Amazon QuickSight](#) is a paid service. Before running it to analyze data and create a dashboard, review the [Amazon QuickSight pricing](#).

## Prerequisites and limitations

### Prerequisites

- An active AWS account.
- AWS Identity and Access Management (IAM) roles and permissions with access to provision resources
- An [Amazon QuickSight account](#) created with access to [Amazon Simple Storage Service \(Amazon S3\)](#) and [Amazon Athena](#)
- AWS CDK version 2.55.1 or later installed
- [Python](#) version 3.9 or later installed

### Limitations

- This solution is deployed to a single AWS account.
- The solution will not track the events that happened before its deployment unless AWS CloudTrail was already set up and storing data in an S3 bucket.

### Product versions

- AWS CDK version 2.55.1 or later
- Python version 3.9 or later

## Architecture

### Target technology stack

- Amazon Athena
- AWS CloudTrail
- AWS Glue
- AWS Lambda
- Amazon QuickSight
- Amazon S3

### Target architecture

The AWS CDK code will deploy all the resources that are required to set up resource-assessment capabilities in an AWS account. The following diagram shows the process of sending CloudTrail logs to AWS Glue, Amazon Athena, and QuickSight.

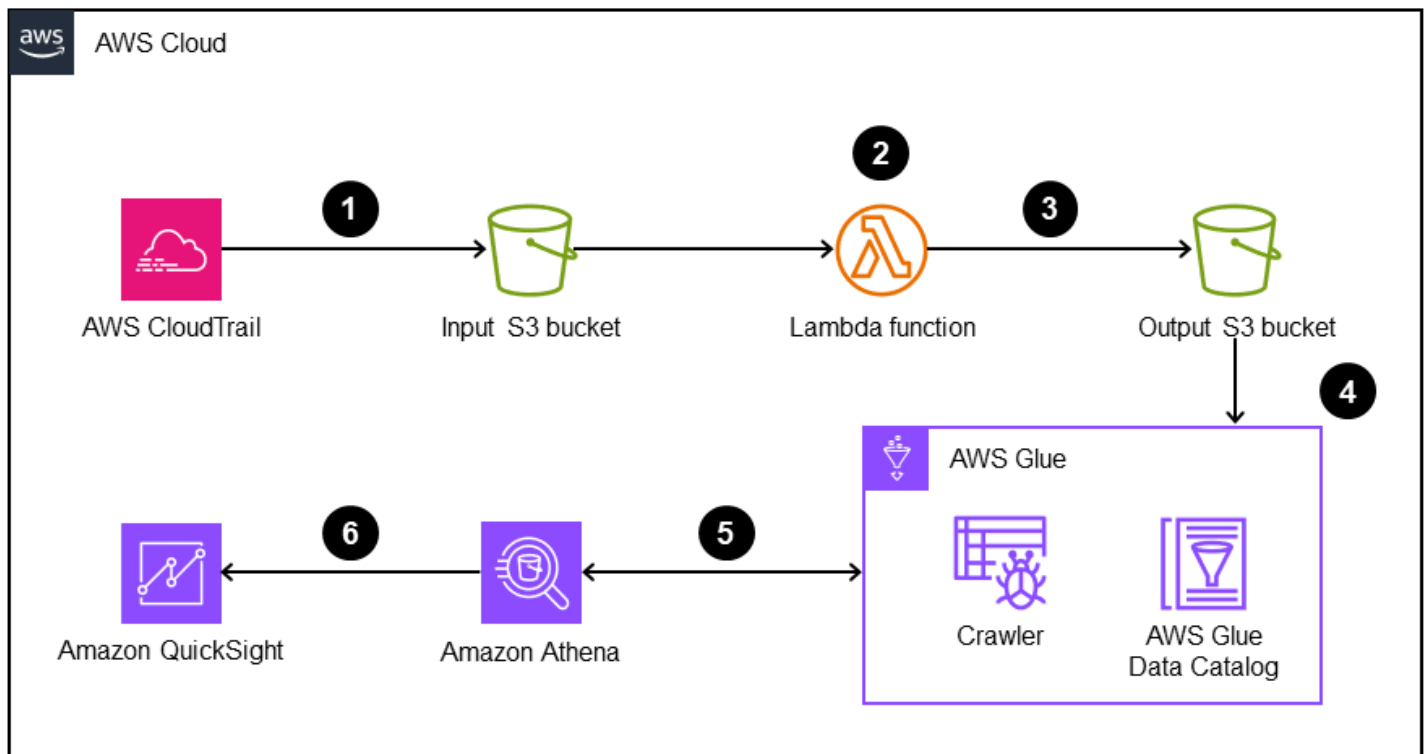

1. CloudTrail sends logs to an S3 bucket for storage.
2. An event notification invokes a Lambda function that processes the logs and generates filtered data.
3. The filtered data is stored in another S3 bucket.
4. An AWS Glue crawler is set up on the filtered data that is in the S3 bucket to create a schema in the AWS Glue Data Catalog table.
5. The filtered data is ready to be queried by Amazon Athena.
6. The queried data is accessed by QuickSight for visualization.

### Automation and scale

- This solution can be scaled from one AWS account to multiple AWS accounts if there is an organization-wide CloudTrail trail in AWS Organizations. By deploying CloudTrail at the organizational level, you can also use this solution to fetch resource-auditing details for all the required resources.

- This pattern uses AWS serverless resources to deploy the solution.

## Tools

### AWS services

- [Amazon Athena](#) is an interactive query service that helps you analyze data directly in Amazon S3 by using standard SQL.
- [AWS Cloud Development Kit \(AWS CDK\)](#) is a software development framework that helps you define and provision AWS Cloud infrastructure in code.
- [AWS CloudFormation](#) helps you set up AWS resources, provision them quickly and consistently, and manage them throughout their lifecycle across AWS accounts and AWS Regions.
- [AWS CloudTrail](#) helps you audit the governance, compliance, and operational risk of your AWS account.
- [AWS Glue](#) is a fully managed extract, transform, and load (ETL) service. It helps you reliably categorize, clean, enrich, and move data between data stores and data streams. This pattern uses an AWS Glue crawler and an AWS Glue Data Catalog table.
- [AWS Lambda](#) is a compute service that helps you run code without needing to provision or manage servers. It runs your code only when needed and scales automatically, so you pay only for the compute time that you use.
- [Amazon QuickSight](#) is a cloud-scale business intelligence (BI) service that helps you visualize, analyze, and report your data in a single dashboard.
- [Amazon Simple Storage Service \(Amazon S3\)](#) is a cloud-based object storage service that helps you store, protect, and retrieve any amount of data.

### Code repository

The code for this pattern is available in the GitHub [infrastructure-assessment-iac-automation](#) repository.

The code repository contains the following files and folders:

- `lib` folder – The AWS CDK construct Python files used to create AWS resources
- `src/lambda_code` – The Python code that is run in the Lambda function
- `requirements.txt` – The list of all Python dependencies that must be installed

- `cdk.json` – The input file to provide values required to spin up resources

## Best practices

Set up monitoring and alerting for the Lambda function. For more information, see [Monitoring and troubleshooting Lambda functions](#). For general best practices when working with Lambda functions, see the [AWS documentation](#).

## Epics

### Set up your environment

Task	Description	Skills required
Clone the repo on your local machine.	To clone the repository, run the command <code>git clone https://github.com/aws-samples/infrastructure-assessment-iac-automation.git</code> .	AWS DevOps, DevOps engineer
Set up the Python virtual environment and install required dependencies.	To set up the Python virtual environment, run the following commands. <div style="border: 1px solid #ccc; border-radius: 10px; padding: 10px; margin: 10px 0;"> <pre>cd infrastructure-assessment-iac-automation python3 -m venv .venv source .venv/bin/activate</pre> </div> To set up the required dependencies, run the command <code>pip install -r requirements.txt</code> .	AWS DevOps, DevOps engineer

Task	Description	Skills required
Set up the AWS CDK environment and synthesize the AWS CDK code.	<ol style="list-style-type: none"> <li>To set up the AWS CDK environment in your AWS account, run the command <code>cdk bootstrap aws://ACCOUNT-NUMBER/REGION</code>.</li> <li>To convert the code to an AWS CloudFormation stack configuration, run the command <code>cdk synth</code>.</li> </ol>	AWS DevOps, DevOps engineer

### Set up AWS credentials on your local machine

Task	Description	Skills required
Export variables for the account and Region where the stack will be deployed.	<p>To provide AWS credentials for AWS CDK by using environment variables, run the following commands.</p> <pre>export CDK_DEFAULT_ACCOUNT=&lt;12 Digit AWS Account Number&gt; export CDK_DEFAULT_REGION=&lt;region&gt;</pre>	AWS DevOps, DevOps engineer
Set up the AWS CLI profile.	To set up the AWS CLI profile for the account, follow the instructions in the <a href="#">AWS documentation</a> .	AWS DevOps, DevOps engineer



## Configure and deploy the resource-assessment tool

Task	Description	Skills required
Deploy resources in the account.	<p>To deploy resources in the AWS account by using AWS CDK, do the following:</p> <ol style="list-style-type: none"><li>1. In the root of the cloned repository, in the <code>cdk.json</code> file, provide inputs for the following parameters:<ul style="list-style-type: none"><li>• <code>s3_context</code></li><li>• <code>ct_context</code></li><li>• <code>kms_context</code></li><li>• <code>lambda_context</code></li><li>• <code>glue_context</code></li><li>• <code>qs_context</code></li></ul></li></ol> <p>These values define resource configurations and nomenclature. Default values are set and can be changed if required.</p> <p><b>Note:</b> To avoid an error saying that the S3 bucket already exists, make sure to provide unique names for <code>s3_context</code> in the <code>ct</code> and <code>output</code> sections.</p> <ol style="list-style-type: none"><li>2. To deploy resources, run the command <code>cdk deploy</code>.</li></ol>	AWS DevOps

Task	Description	Skills required
	<p>The <code>cdk deploy</code> command creates a CloudTrail resource to log events and save the log file in the input S3 bucket. The trail's log files will be processed by the Lambda function. The filtered results are stored in the output S3 bucket and are ready to be consumed by Amazon Athena and Amazon QuickSight.</p>	

Task	Description	Skills required
Run the AWS Glue crawler and create the Data Catalog table.	<p>An <a href="#">AWS Glue crawler</a> is used to keep the data schema dynamic. The solution creates and updates partitions in the <a href="#">AWS Glue Data Catalog table</a> by running the crawler periodically as defined by the AWS Glue crawler scheduler . After the data is available in the output S3 bucket, use the following steps to run the AWS Glue crawler and create the Data Catalog table schema for testing:</p> <ol style="list-style-type: none"><li>1. Sign in to the AWS Management Console and navigate to the AWS Glue console.</li><li>2. In the navigation pane, under <b>Data Catalog</b>, choose <b>Crawlers</b>.</li><li>3. Select the <code>iac-tool-qa-resource-iac-js-on-crawler</code> crawler.</li><li>4. Run the crawler.</li><li>5. After the crawler runs successfully, it creates an AWS Glue Data Catalog table. AWS QuickSight will use the table to visualize the data.</li></ol>	AWS DevOps, DevOps engineer

Task	Description	Skills required
	<b>Note:</b> The AWS CDK code configures the AWS Glue crawler to run at a particular time, but you can also run it on demand.	
Deploy the QuickSight construct.	<ol style="list-style-type: none"><li>1. To deploy the QuickSight construct, uncomment the code between <code>#QuickSight setup - start</code> and <code>#QuickSight setup - ends in resource_iac_tool_stack.py</code>.</li><li>2. After you uncomment, run the <code>cdk deploy</code> command to create QuickSight DataSource and QuickSight DataSet in the QuickSight account.</li></ol>	AWS DevOps, DevOps engineer

Task	Description	Skills required
Create the QuickSight dashboard.	<p>To create the example QuickSight dashboard and analysis, do the following:</p> <ol style="list-style-type: none"><li>1. Navigate to the QuickSight console and select the AWS Region where resources are deployed.</li><li>2. In the navigation pane, choose <b>Datasets</b>, and validate that a dataset named <code>ct-operations-iac-ds</code> has been created in the Amazon QuickSight dataset.</li></ol> <p>If you don't see the dataset, redeploy the QuickSight construct.</p> <ol style="list-style-type: none"><li>3. Select the <code>ct-operations-iac-ds</code> dataset, and choose <b>USE IN ANALYSIS</b>.</li><li>4. Select the default sheet.</li><li>5. Select the respective columns from the field list on the left side.</li><li>6. After selecting the required columns, select the appropriate visual type to view the data.</li></ol> <p>For more information, see <a href="#">Starting an analysis in</a></p>	AWS DevOps, DevOps engineer

Task	Description	Skills required
	<a href="#">Amazon QuickSight</a> and <a href="#">Visual types in Amazon QuickSight</a> .	

### Clean up all AWS resources in the solution

Task	Description	Skills required
Remove the AWS resources.	<ol style="list-style-type: none"> <li>To remove AWS resources deployed by the solution, run the command <code>cdk destroy</code>.</li> <li>Delete all objects from the two S3 buckets, and then remove the buckets.</li> </ol> <p>For more information, see <a href="#">Deleting a bucket</a>.</p>	AWS DevOps, DevOps engineer

### Set up additional features on top of the AWS resource-assessment tool automation

Task	Description	Skills required
Monitor and clean up manually created resources.	(Optional) If your organization has compliance requirements to create resources using IaC tools, you can achieve compliance by using AWS resource-assessment tool automation to fetch manually provisioned resources. You can also use the tool to import the resources to an IaC tool or to re-create them. To	AWS DevOps, DevOps engineer

Task	Description	Skills required
	<p>monitor manually provisioned resources, perform the following high-level tasks:</p> <ol style="list-style-type: none"><li data-bbox="592 388 1023 514">1. Deploy AWS resource-assessment tool automation.</li><li data-bbox="592 535 1023 903">2. Set up a Lambda function to query the Athena tables on a daily basis, find the relevant data about manually provisioned resources, and export it to a comma-separated values (CSV) file.</li><li data-bbox="592 924 1023 1102">3. After the Lambda function runs, a notification with the required data can be sent to respective stakeholders.</li><li data-bbox="592 1123 1023 1260">4. For longer retention, the .csv file can be stored in the S3 bucket.</li><li data-bbox="592 1281 1023 1501">5. Based on the information in the .csv file, delete the manually created resources or import them to an existing IaC solution.</li></ol>	

# Troubleshooting

Issue	Solution
AWS CDK returns errors.	For help with AWS CDK issues, see <a href="#">Troubleshooting common AWS CDK issues</a> .

## Related resources

- [Building Lambda functions with Python](#)
- [Get started with AWS CDK](#)
- [Working with AWS CDK in Python](#)
- [Creating a CloudTrail log trail](#)
- [Get Started with Amazon QuickSight](#)

## Additional information

### Multiple accounts

To set up the AWS CLI credential for multiple accounts, use AWS profiles. For more information, see the *Configure multiple profiles* section in [Set up the AWS CLI](#).

### AWS CDK commands

When working with AWS CDK, keep in mind the following useful commands:

- Lists all stacks in the app

```
cdk ls
```

- Emits the synthesized AWS CloudFormation template

```
cdk synth
```

- Deploys the stack to your default AWS account and Region

```
cdk deploy
```



- Compares the deployed stack with the current state

```
cdk diff
```

- Opens the AWS CDK documentation

```
cdk docs
```

# Install SAP systems automatically by using open-source tools

Created by Guilherme Sesterheim (AWS)

<b>Code repository:</b> <a href="#">Main repository</a>	<b>Environment:</b> Production	<b>Technologies:</b> DevOps
<b>Workload:</b> SAP	<b>AWS services:</b> Amazon EC2; Amazon S3	

## Summary

This pattern shows how to automate SAP systems installation by using open-source tools to create the following resources:

- An SAP S/4HANA 1909 database
- An SAP ABAP Central Services (ASCS) instance
- An SAP Primary Application Server (PAS) instance

HashiCorp Terraform creates the SAP system's infrastructure and Ansible configures the operating system (OS) and installs SAP applications. Jenkins runs the installation.

This setup turns SAP systems installation into a repeatable process, which can help increase deployment efficiency and quality.

**Note:** The example code provided in this pattern works for both high-availability (HA) systems and non-HA systems.

## Prerequisites and limitations

### Prerequisites

- An active AWS account
- An Amazon Simple Storage Service (Amazon S3) bucket that contains all of your SAP media files
- An AWS Identity and Access Management (IAM) principal with an [access key and secret key](#), and that has the following permissions:

- **Read only permissions:** Amazon Route 53, AWS Key Management Service (AWS KMS)
- **Read and write permissions:** Amazon S3, Amazon Elastic Compute Cloud (Amazon EC2), Amazon Elastic File System (Amazon EFS), IAM, Amazon CloudWatch, Amazon DynamoDB
- A Route 53 [private hosted zone](#)
- A subscription to the [Red Hat Enterprise Linux for SAP with HA and Update Services 8.2](#) Amazon Machine Image (AMI) in Amazon Marketplace
- An [AWS KMS customer managed key](#)
- A [Secure Shell \(SSH\) key pair](#)
- An [Amazon EC2 security group](#) that allows SSH connection on port 22 from the hostname where you install Jenkins (the hostname is most likely **localhost**)
- [Vagrant](#) by HashiCorp installed and configured
- [VirtualBox](#) by Oracle installed and configured
- Familiarity with Git, Terraform, Ansible, and Jenkins

## Limitations

- Only SAP S/4HANA 1909 is fully tested for this specific scenario. The example Ansible code in this pattern requires modification if you use another version of SAP HANA.
- The example procedure in this pattern works for Mac OS and Linux operating systems. Some of the commands can be run only in Unix-based terminals. However, you can achieve a similar result by using different commands and a Windows OS.

## Product versions

- SAP S/4HANA 1909
- Red Hat Enterprise Linux (RHEL) 8.2 or higher versions

## Architecture

The following diagram shows an example workflow that uses open-source tools to automate SAP systems installation in an AWS account:

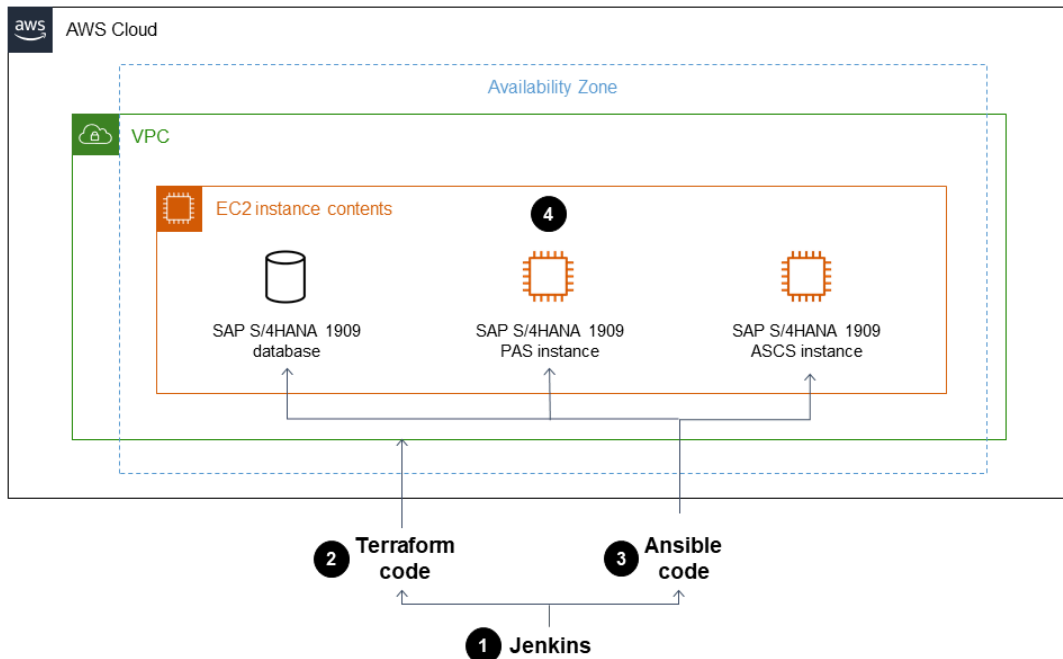

The diagram shows the following workflow:

1. Jenkins orchestrates running the SAP system installation by running Terraform and Ansible code.
2. Terraform code builds the SAP system's infrastructure.
3. Ansible code configures the OS and installs SAP applications.
4. An SAP S/4HANA 1909 database, an ASCS instance, and PAS instance that include all defined prerequisites are installed on an Amazon EC2 instance.

**Note:** The example setup in this pattern automatically creates an Amazon S3 bucket in your AWS account to store the Terraform state file.

## Technology stack

- Terraform
- Ansible
- Jenkins
- An SAP S/4HANA 1909 database

- An SAP ASCS instance
- An SAP PAS instance
- Amazon EC2

## Tools

### AWS services

- [Amazon Elastic Compute Cloud \(Amazon EC2\)](#) provides scalable computing capacity in the AWS Cloud. You can launch as many virtual servers as you need, and quickly scale them up or down.
- [AWS Identity and Access Management \(IAM\)](#) helps you securely manage access to your AWS resources by controlling who is authenticated and authorized to use them.
- [AWS Key Management Service \(AWS KMS\)](#) helps you create and control cryptographic keys to protect your data.
- [Amazon Virtual Private Cloud \(Amazon VPC\)](#) helps you launch AWS resources into a virtual network that you've defined. This virtual network resembles a traditional network that you'd operate in your own data center, with the benefits of using the scalable infrastructure of AWS.

### Other tools

- [HashiCorp Terraform](#) is a command-line interface application that helps you use code to provision and manage cloud infrastructure and resources.
- [Ansible](#) is an open-source configuration as code (CaC) tool that helps automate applications, configurations, and IT infrastructure.
- [Jenkins](#) is an open-source automation server that enables developers to build, test, and deploy their software.

### Code

The code for this pattern is available in the GitHub [aws-install-sap-with-jenkins-ansible](#) repository.

# Epics

## Configure the prerequisites

Task	Description	Skills required
Add your SAP media files to an Amazon S3 bucket.	<p><a href="#">Create an Amazon S3 bucket</a> that contains all of your SAP media files.</p> <p><b>Important:</b> Make sure that you follow the AWS Launch Wizard's folder hierarchy for <b>S/4HANA</b> in the <a href="#">Launch Wizard documentation</a>.</p>	Cloud administrator
Install VirtualBox.	Install and configure <a href="#">VirtualBox</a> by Oracle.	DevOps engineer
Install Vagrant.	Install and configure <a href="#">Vagrant</a> by HashiCorp.	DevOps engineer
Configure your AWS account.	<p>1. Verify that you have an IAM principal with an <a href="#">access key and secret key</a>, and that has the following permissions:</p> <ul style="list-style-type: none"> <li>• <b>Read only permissions:</b> Amazon Route 53, AWS Key Management Service (AWS KMS)</li> <li>• <b>Read and write permissions:</b> Amazon S3, Amazon Elastic Compute Cloud (Amazon EC2), Amazon Elastic File System (Amazon EFS),</li> </ul>	General AWS

Task	Description	Skills required
	<p>IAM, Amazon CloudWatch, Amazon DynamoDB</p> <ol style="list-style-type: none"><li>2. Save the IAM principal's access key and secret key for reference later.</li><li>3. Create a Route 53 <a href="#">private hosted zone</a>, if you don't have one already. Save the zone name (for example, <b>sapteam.net</b>) for reference later.</li><li>4. Subscribe to the <a href="#">Red Hat Enterprise Linux for SAP with HA and Update Services 8.2</a> AMI in Amazon Marketplace. Save the <b>AMI ID</b> (for example, <b>ami-0000000</b>) for reference later.</li><li>5. Create an <a href="#">AWS KMS customer managed key</a>. Save the KMS key's <a href="#">Amazon Resource Name (ARN)</a> for reference later.</li></ol> <p><b>Note:</b> The following is an example AWS KMS customer managed key ARN: <b>arn:aws:kms:us-east-1:123412341234:key/uuid</b></p> <ol style="list-style-type: none"><li>6. Create an <a href="#">SSH key pair</a>. Save the key pair's name</li></ol>	

Task	Description	Skills required
	<p>and .pem file for reference later.</p> <p>7. Create an <a href="#">Amazon EC2 security group</a> that allows SSH connection on port 22 from the hostname where you install Jenkins. Save the <b>security group ID</b> for reference later.</p> <p><b>Note:</b> The hostname is most likely <b>localhost</b>.</p>	

## Build and run your SAP installation

Task	Description	Skills required
Clone the code repository from GitHub.	Clone the <a href="#">aws-install-sap-with-jenkins-ansible</a> repository on GitHub.	DevOps engineer
Start the Jenkins service.	<p>Open the Linux terminal. Then, navigate to the local folder that contains the cloned code repository folder and run the following command:</p> <pre data-bbox="597 1549 1026 1625">sudo vagrant up</pre> <p><b>Note:</b> The Jenkins startup takes about 20 minutes. The command returns a <b>Service</b></p>	DevOps engineer



Task	Description	Skills required
	<b>is up and running</b> message when successful.	
Open Jenkins in a web browser and log in.	<ol style="list-style-type: none"><li>1. In a web browser, enter <b>http://localhost:5555</b>. Jenkins opens.</li><li>2. Log in to Jenkins by using <b>admin</b> for the username and <b>my_secret_pass_from_vault</b> for the password.</li></ol>	DevOps engineer

Task	Description	Skills required
Configure your SAP system installation parameters.	<ol style="list-style-type: none"><li>1. In Jenkins, choose <b>Manage Jenkins</b>. Then, choose <b>Manage Credentials</b>. A list of credential variables that you can configure appears.</li><li>2. Configure all of the following credential variables:<ul style="list-style-type: none"><li>• For <b>AWS_ACCOUNT_CREDENTIALS</b>, enter your IAM principal's access key ID and secret access key ID.</li><li>• For <b>AMI_ID</b>, enter the Red Hat Enterprise Linux for SAP with HA and Update Services 8.2 AMI's AMI ID.</li><li>• For <b>KMS_KEY_ARN</b>, enter your AWS KMS customer managed key's ARN.</li><li>• For <b>SSH_KEYPAIR_NAME</b>, enter the name of your SSH key pair, without entering the <b>.pem</b> file type.</li><li>• For <b>SSH_KEYPAIR_FILE</b>, enter the full name of your key pair's <b>.pem</b> file (for example, <b>mykeypair.pem</b>). Make sure that you also upload the key pairs' <b>.pem</b> file to Jenkins.</li></ul></li></ol>	AWS systems administrator, DevOps engineer

Task	Description	Skills required
	<ul style="list-style-type: none"><li>• For <b>S3_ROOT_FOLDER_INSTALL_FILES</b>, enter the name of the Amazon S3 bucket—and folder, if applicable—(for example, <b>s3://my-media-bucket/S4H1909</b>) that contains your SAP media files.</li><li>• For <b>PRIVATE_DNS_ZONE_NAME</b>, enter the name of your Route 53 private hosted zone (for example, <b>myprivatecompanyurl.net</b>).</li><li>• For <b>VPC_ID</b>, enter the VPC ID (for example, <b>vpc-12345</b>) of the Amazon VPC that you're creating the SAP resources in.</li><li>• For <b>SUBNET_IDS</b>, enter two public subnet IDs if you're working in a test environment (for future HA capabilities). If you're working in a production environment, it's a best practice to use two private subnets with a bastion host.</li><li>• For <b>SECURITY_GROUP_ID</b>, enter the ID of the Amazon EC2 security group that allows SSH connection on port 22 from the hostname where you installed Jenkins.</li></ul>	

Task	Description	Skills required
	<p><b>Note:</b> You can configure the other nonrequired parameters as needed, based on your use case. For example, you can change the SAP system ID (SID) of the instances, default password, names, and tags for your SAP system. All of the required variables have <b>(Required)</b> at the beginning of their names.</p>	

Task	Description	Skills required
Run you SAP system installation.	<ol style="list-style-type: none"><li data-bbox="592 226 1027 405">1. In Jenkins, choose <b>Jenkins Home</b>. Then, choose <b>SAP Hana+ASCS+PAS 3 Instances</b>.</li><li data-bbox="592 426 1027 510">2. Choose <b>Spin up and install</b>. Then, choose <b>Main</b>.</li><li data-bbox="592 531 1027 573">3. Choose <b>Build now</b>.</li></ol> <p data-bbox="592 646 1027 919">For information on the pipeline steps, see the <b>Understanding the pipeline steps</b> section of <a href="#">Automating SAP installation with open-source tools</a> on the AWS Blog.</p> <p data-bbox="592 961 1027 1329"><b>Note:</b> If an error occurs, move your cursor over the red error box that appears and choose <b>Logs</b>. The logs for the pipeline step that errored out appear. Most errors occur because of incorrect parameter settings.</p>	DevOps engineer, AWS systems administrator

## Related resources

- [DevOps for SAP – SAP Installation: From 2 Months to 2 Hours](#) (DevOps Enterprise Summit Video Library)

# Automate AWS Service Catalog portfolio and product deployment by using AWS CDK

Created by Sandeep Gawande (AWS), RAJNEESH TYAGI (AWS), and Viyoma Sachdeva (AWS)

**Code repository:** [aws-cdk-servicelog-automation](#)

**Environment:** PoC or pilot

**Technologies:** DevOps; Infrastructure; Management & governance

**Workload:** Open-source

**AWS services:** AWS Service Catalog; AWS CDK

## Summary

AWS Service Catalog helps you centrally manage catalogs of IT services, or *products*, that are approved for use in your organization's AWS environment. A collection of products is called a *portfolio*, and a portfolio also contains configuration information. With AWS Service Catalog, you can create a customized portfolio for each type of user in your organization and then grant access to the appropriate portfolio. Those users can then quickly deploy any product they need from within the portfolio.

If you have a complex networking infrastructure, such as multi-Region and multi-account architectures, it is recommended that you create and manage Service Catalog portfolios in a single, central account. This pattern describes how to use AWS Cloud Development Kit (AWS CDK) to automate creation of Service Catalog portfolios in a central account, grant end users access to them, and then, optionally, provision products in one or more target AWS accounts. This ready-to-use solution creates the Service Catalog portfolios in the source account. It also, optionally, provisions products in target accounts by using AWS CloudFormation stacks and helps you configure TagOptions for the products:

- **AWS CloudFormation StackSets** – You can use StackSets to launch Service Catalog products across multiple AWS Regions and accounts. In this solution, you have the option to automatically provision products when you deploy this solution. For more information, see [Using AWS CloudFormation StackSets](#) (Service Catalog documentation) and [StackSets concepts](#) (CloudFormation documentation).

- **TagOption library** – You can manage tags on provisioned products by using TagOption library. A *TagOption* is a key-value pair managed in AWS Service Catalog. It is not an AWS tag, but it serves as a template for creating an AWS tag based on the TagOption. For more information, see [TagOption library](#) (Service Catalog documentation).

## Prerequisites and limitations

### Prerequisites

- An active AWS account that you want to use as the source account for administering Service Catalog portfolios.
- If you are using this solution to provision products in one or more target accounts, the target account must already exist and be active.
- AWS Identity and Access Management (IAM) permissions to access AWS Service Catalog, AWS CloudFormation, and AWS IAM.

### Product versions

- AWS CDK version 2.27.0

## Architecture

### Target technology stack

- Service Catalog portfolios in a centralized AWS account
- Service Catalog products deployed in target account

### Target architecture

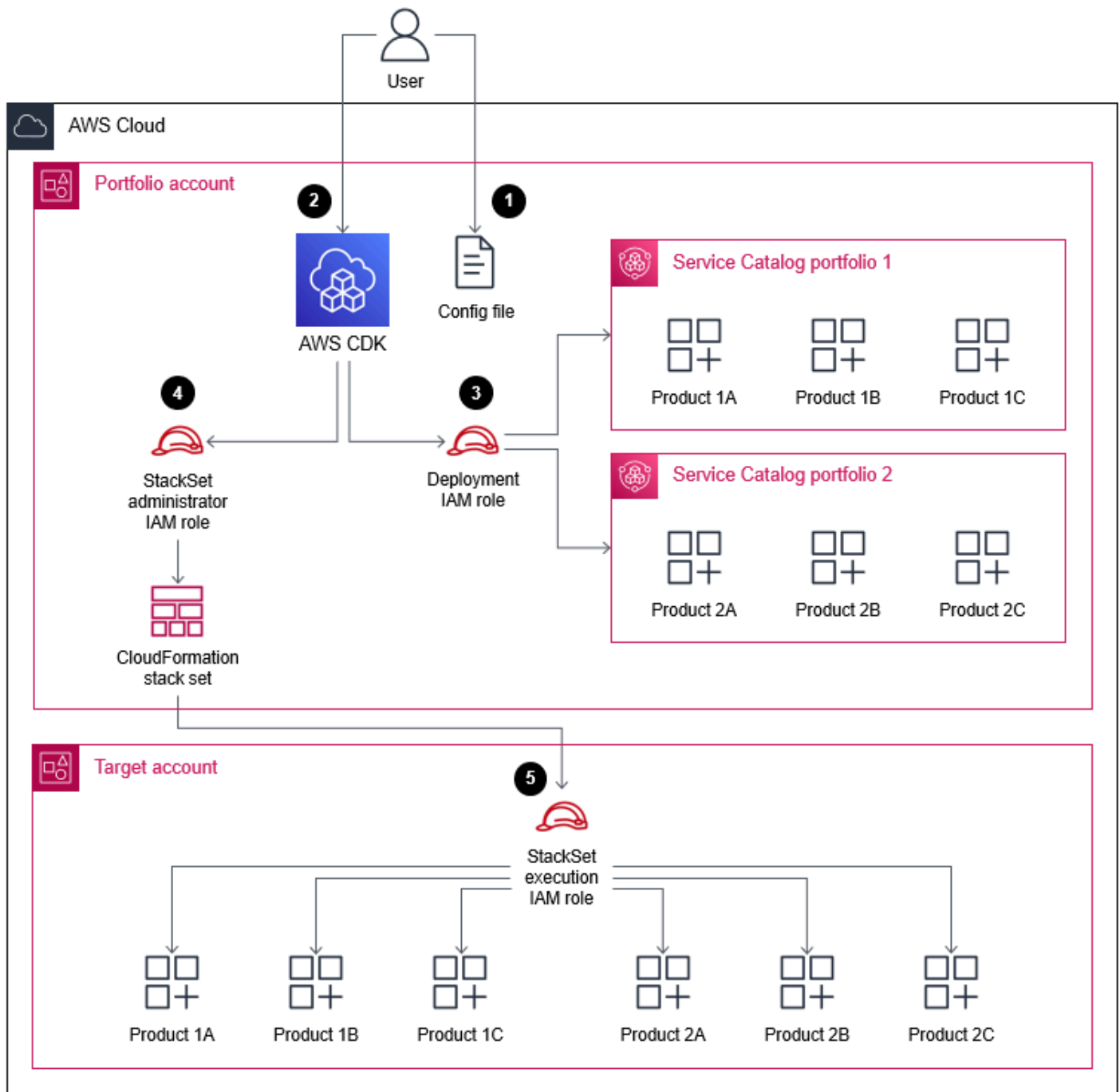

1. In the portfolio (or *source*) account, you update the **config.json** file with the AWS account, AWS Region, IAM role, portfolio, and product information for your use case.
2. You deploy the AWS CDK application.
3. The AWS CDK application assumes the deployment IAM role and creates the Service Catalog portfolios and products defined in the **config.json** file.



If you configured StackSets to deploy products in a target account, the process continues. If you didn't configure StackSets to provision any products, then the process is complete.

4. The AWS CDK application assumes the **StackSet administrator** role and deploys the AWS CloudFormation stack set you defined in the **config.json** file.
5. In the target account, StackSets assumes the **StackSet execution** role and provisions the products.

## Tools

### AWS services

- [AWS Cloud Development Kit \(AWS CDK\)](#) is a software development framework that helps you define and provision AWS Cloud infrastructure in code.
- [AWS CDK Toolkit](#) is a command line cloud development kit that helps you interact with your AWS CDK app.
- [AWS CloudFormation](#) helps you set up AWS resources, provision them quickly and consistently, and manage them throughout their lifecycle across AWS accounts and Regions.
- [AWS Identity and Access Management \(IAM\)](#) helps you securely manage access to your AWS resources by controlling who is authenticated and authorized to use them.
- [AWS Service Catalog](#) helps you centrally manage catalogs of IT services that are approved for AWS. End users can quickly deploy only the approved IT services they need, following the constraints set by your organization.

### Code repository

The code for this pattern is available on GitHub, in the [aws-cdk-servicecatalog-automation](#) repository. The code repository contains the following files and folders:

- **cdk-sevicecatalog-app** – This folder contains the AWS CDK application for this solution.
- **config** – This folder contains the **config.json** file and the CloudFormation template for deploying the products in the Service Catalog portfolio.
- **config/config.json** – This file contains all of the configuration information. You update this file to customize this solution for your use case.
- **config/templates** – This folder contains the CloudFormation templates for the Service Center products.

- **setup.sh** – This script deploys the solution.
- **uninstall.sh** – This script deletes the stack and all of the AWS resources created when deploying this solution.

To use the sample code, follow the instructions in the [Epics](#) section.

## Best practices

- IAM roles used to deploy this solution should adhere to the [principle of least-privilege](#) (IAM documentation).
- Adhere to the [Best practices for developing cloud applications with AWS CDK](#) (AWS blog post).
- Adhere to the [AWS CloudFormation best practices](#) (CloudFormation documentation).

## Epics

### Set up your environment

Task	Description	Skills required
Install the AWS CDK Toolkit.	<p>Make sure you have AWS CDK Toolkit installed. Enter the following command to confirm whether it is installed and check the version.</p> <pre>cdk --version</pre> <p>If AWS CDK Toolkit is not installed, then enter the following command to install it.</p> <pre>npm install -g aws-cdk@2.27.0</pre>	AWS DevOps, DevOps engineer

Task	Description	Skills required
	<p>If AWS CDK Toolkit version is earlier than 2.27.0, then enter the following command to update it to version 2.27.0.</p> <pre data-bbox="597 426 1024 541">npm install -g aws-cdk@2.27.0 --force</pre>	
Clone the repository.	<p>Enter the following command. In <i>Clone the repository</i> in the <a href="#">Additional information</a> section, you can copy the full command containing the URL for the repository. This clones the <a href="#">aws-cdk-servicecatalog-automation</a> repository from GitHub.</p> <pre data-bbox="597 1087 1024 1203">git clone &lt;repository-URL&gt;.git</pre> <p>This creates a <code>cd aws-cdk-servicecatalog-automation</code> folder in the target directory. Enter the following command to navigate into this folder.</p> <pre data-bbox="597 1556 1024 1671">cd aws-cdk-servicecatalog-automation</pre>	AWS DevOps, DevOps engineer

Task	Description	Skills required
Set up AWS credentials.	<p>Enter the following commands. These export the following variables, which define the AWS account and Region where you are deploying the stack.</p> <pre>export CDK_DEFAULT_ACCOUNT=&lt;12-digit AWS account number&gt;</pre> <pre>export CDK_DEFAULT_REGION=&lt;AWS Region&gt;</pre> <p>AWS credentials for AWS CDK are provided through environment variables.</p>	AWS DevOps, DevOps engineer
Configure permissions for end user IAM roles.	<p>If you are going to use IAM roles to grant access to the portfolio and the products in it, the roles must have permissions to be assumed by the <b>servicecatalog.amazonaws.com</b> service principal. For instructions about how to grant these permissions, see <a href="#">Enabling trusted access with Service Catalog</a> (AWS Organizations documentation).</p>	AWS DevOps, DevOps engineer

Task	Description	Skills required
Configure IAM roles required by StackSets.	<p>If you are using StackSets to automatically provision products in target accounts, you need to configure the IAM roles that administer and run the stack set.</p> <ol style="list-style-type: none"><li data-bbox="594 541 1026 1108">1. In the source account, confirm whether the <code>AWSCloudFormationStackSetAdministrationRole</code> already exists. In the target accounts, confirm whether <code>AWSCloudFormationStackSetExecutionRole</code> already exists. If these roles already exist, you can skip to the next epic.</li><li data-bbox="594 1129 1026 1549">2. Follow the instructions in <a href="#">Grant self-managed permissions</a> (IAM documentation) to create the stack set administration role in the portfolio account and create the execution role in each target account.</li></ol>	AWS DevOps, DevOps engineer

## Customize and deploy the solution

Task	Description	Skills required
Create the CloudFormation templates.	In the config/templates folder, create CloudFormation templates for any products that you want to include in your portfolios. For more information, see <a href="#">Working with AWS CloudFormation templates</a> (CloudFormation documentation).	App developer, AWS DevOps, DevOps engineer
Customize the config file.	In the config folder, open the <b>config.json</b> file and define the parameters as appropriate for your use case. The following parameters are required unless otherwise noted: <ul style="list-style-type: none"><li>• In the <b>portfolios</b> section, define the following parameters to create one or more Service Catalog portfolios:<ul style="list-style-type: none"><li>• <b>portfolioName</b> – The name of the portfolio.</li><li>• <b>providerName</b> – The name of the person, team, or organization that manages the portfolio.</li><li>• <b>description</b> – A brief description of the portfolio.</li></ul></li></ul>	App developer, DevOps engineer, AWS DevOps

Task	Description	Skills required
	<ul style="list-style-type: none"><li>• <code>roles</code> – (Optional) Names of any IAM roles that should have access to this portfolio. Users who have this role can access the products in this portfolio.</li><li>• <code>users</code> – (Optional) Names of any IAM users who should have access to this portfolio and its products.</li><li>• <code>groups</code> – (Optional) Names of any IAM user groups that should have access to this portfolio and its products.</li></ul> <p><b>Warning:</b> IAM users have long-term credentials, which presents a security risk. To help mitigate this risk, we recommend that you provide these users with only the permissions they require to perform the task and that you remove these users when they are no longer needed.</p> <p><b>Important:</b> <code>roles</code>, <code>users</code>, and <code>groups</code> are all optional parameters, but if you do not define one of these parameters, then no one</p>	

Task	Description	Skills required
	<p>can view the portfolio products in the Service Catalog console. Define at least one of these parameters. For more information, see <a href="#">Grant permissions to Service Catalog end users</a> (Service Catalog documentation).</p> <ul style="list-style-type: none"><li>• (Optional) In the <code>tagOption</code> section, define <code>TagOptions</code> for the products:<ul style="list-style-type: none"><li>• <code>key</code> – Name of the <code>TagOption</code> key</li><li>• <code>value</code> – Allowed string values for the <code>TagOption</code></li></ul></li></ul> <p>For more information, see <a href="#">TagOption library</a> (Service Catalog documentation).</p> <ul style="list-style-type: none"><li>• In the <code>products</code> section, define the following parameters for the products:<ul style="list-style-type: none"><li>• <code>portfolioName</code> – The name of the portfolio where you want to add the product. You can specify only one portfolio</li><li>• <code>productName</code> – The name of the product.</li></ul></li></ul>	



Task	Description	Skills required
	<ul style="list-style-type: none"><li>• <code>owner</code> – The owner of the product.</li><li>• <code>productVersionName</code> – The name of the product version in string value, such as <code>v1</code>.</li><li>• <code>templatePath</code> – The file path for the CloudFormation template for the product.</li><li>• <code>deployWithStackSets</code> – (Optional) Specify one or more accounts and Regions where you want to use StackSets to automatically provision products in the portfolios. If you use this deployment option, all of the following parameters in this section are required:<ul style="list-style-type: none"><li>• <code>accounts</code> – The target accounts.</li><li>• <code>regions</code> – The target Regions.</li><li>• <code>stackSetAdministrationRoleName</code> – The name of the IAM role used to administer the StackSets configuration. Do not change</li></ul></li></ul>	

Task	Description	Skills required
	<p>this value. This role must have this exact name.</p> <ul style="list-style-type: none"> <li>stackSetExecutionRoleName – The name of the IAM role in the target account that deploys the stack instances. Do not change this value. This role must have this exact name.</li> </ul> <p>For an example of a completed config file, see <i>Sample config file</i> in the <a href="#">Additional information</a> section.</p>	
Deploy the solution.	<p>Enter the following command. This deploys the AWS CDK app and provisions the Service Catalog portfolios and products as specified in the <b>config.json</b> file.</p> <pre>sh +x setup.sh</pre>	App developer, DevOps engineer, AWS DevOps

Task	Description	Skills required
Verify the deployment.	<p>Verify successful deployment by doing the following:</p> <ol style="list-style-type: none"><li>1. Sign in to the AWS Management Console with credentials that can access one or more of the portfolios you defined in the config file.</li><li>2. Open the Service Catalog console at <a href="https://console.aws.amazon.com/servicecatalog/">https://console.aws.amazon.com/servicecatalog/</a>.</li><li>3. In the navigation pane, under <b>Provisioning</b>, choose <b>Products</b>. Verify that you see a list of products that you specified for the portfolio.</li><li>4. Follow the instructions in <a href="#">Launching a product</a> (Service Catalog documentation) to launch one of the available products. Confirm that the available product versions and tags match the values you provided in the config file.</li><li>5. If you chose to automatically provision products in one or more target accounts by using</li></ol>	General AWS

Task	Description	Skills required
	<p>StackSets, do the following :</p> <ol style="list-style-type: none"><li data-bbox="630 310 1013 541">a. Sign in with credentials that give you permissions to view the provisioned products in one of the target accounts.</li><li data-bbox="630 562 1013 793">b. In the Service Catalog console, in the navigation pane, under <b>Provisioning</b>, choose <b>Provisioned products</b>.</li><li data-bbox="630 814 1013 940">c. Confirm that the expected products appear in the list.</li></ol>	

Task	Description	Skills required
(Optional) Update the portfolios and products.	<p>If you want to use this solution to update the portfolios or products or to provision new products:</p> <ol style="list-style-type: none"> <li>1. Make the required changes in the <b>config.json</b> file.</li> <li>2. Add or modify any CloudFormation templates as needed in the <code>config/template</code> folder.</li> <li>3. Redeploy the solution.</li> </ol> <p>For example, you can add additional portfolios or provision more resources. The AWS CDK app implements only the changes. If there are no changes to previously deployed portfolios or products, the redeployment doesn't affect them.</p>	App developer, DevOps engineer, General AWS

## Clean up the solution

Task	Description	Skills required
(Optional) Remove AWS resources deployed by this solution.	<p>If you want to delete a provisioned product, follow the instructions in <a href="#">Deleting provisioned products</a> (Service Catalog documentation).</p>	AWS DevOps, DevOps engineer, App developer

Task	Description	Skills required
	<p>If you want to delete all the resources created by this solution, enter the following command.</p> <pre>sh uninstall.sh</pre>	

## Related resources

- [AWS Service Catalog Construct Library](#) (AWS API Reference)
- [StackSets concepts](#) (CloudFormation documentation)
- [AWS Service Catalog](#) (AWS marketing)
- [Using Service Catalog with the AWS CDK](#) (AWS workshop)

## Additional information

### Additional information

#### Clone the repository

Enter the following command to clone the repository from GitHub.

```
git clone https://github.com/aws-samples/aws-cdk-servicecatalog-automation.git
```

#### Sample config file

The following is a sample **config.json** file with example values.

```
{
  "portfolios": [
    {
      "displayName": "EC2 Product Portfolio",
      "providerName": "User1",
      "description": "Test1",
      "roles": [
        "<Names of IAM roles that can access the products>"
      ]
    }
  ]
}
```

```
    ],
    "users": [
        "<Names of IAM users who can access the products>"
    ],
    "groups": [
        "<Names of IAM user groups that can access the products>"
    ]
},
{
    "displayName": "Autoscaling Product Portfolio",
    "providerName": "User2",
    "description": "Test2",
    "roles": [
        "<Name of IAM role>"
    ]
}
],
"tagOption": [
    {
        "key": "Group",
        "value": [
            "finance",
            "engineering",
            "marketing",
            "research"
        ]
    },
    {
        "key": "CostCenter",
        "value": [
            "01",
            "02",
            "03",
            "04"
        ]
    },
    {
        "key": "Environment",
        "value": [
            "dev",
            "prod",
            "stage"
        ]
    }
}
```

```
],
"products": [
  {
    "portfolioName": "EC2 Product Profile",
    "productName": "Ec2",
    "owner": "owner1",
    "productVersionName": "v1",
    "templatePath": ".././config/templates/template1.json"
  },
  {
    "portfolioName": "Autoscaling Product Profile",
    "productName": "autoscaling",
    "owner": "owner1",
    "productVersionName": "v1",
    "templatePath": ".././config/templates/template2.json",
    "deployWithStackSets": {
      "accounts": [
        "012345678901",
      ],
      "regions": [
        "us-west-2"
      ],
      "stackSetAdministrationRoleName":
"AWSCloudFormationStackSetAdministrationRole",
      "stackSetExecutionRoleName": "AWSCloudFormationStackSetExecutionRole"
    }
  }
]
}
```



# Automate event-driven backups from CodeCommit to Amazon S3 using CodeBuild and CloudWatch Events

Created by Kirankumar Chandrashekar (AWS)

**Environment:** Production

**Technologies:** DevOps;  
Storage & backup

**Workload:** All other  
workloads

**AWS services:** Amazon S3;  
Amazon CloudWatch; AWS  
CodeBuild; AWS CodeCommit

## Summary

On the Amazon Web Services (AWS) Cloud, you can use AWS CodeCommit to host secure Git-based repositories. CodeCommit is a fully managed source control service. However, if a CodeCommit repository is accidentally deleted, its contents are also deleted and [cannot be restored](#).

This pattern describes how to automatically back up a CodeCommit repository to an Amazon Simple Storage Service (Amazon S3) bucket after a change is made to the repository. If the CodeCommit repository is later deleted, this backup strategy provides you with a point-in-time recovery option.

## Prerequisites and limitations

### Prerequisites

- An active AWS account.
- An existing CodeCommit repository, with user access configured according to your requirements. For more information, see [Setting up for AWS CodeCommit](#) in the CodeCommit documentation.
- An S3 bucket for uploading the CodeCommit backups.

### Limitations

- This pattern automatically backs up all of your CodeCommit repositories. If you want to back up individual CodeCommit repositories, you must modify the Amazon CloudWatch Events rule.

## Architecture

The following diagram illustrates the workflow for this pattern.

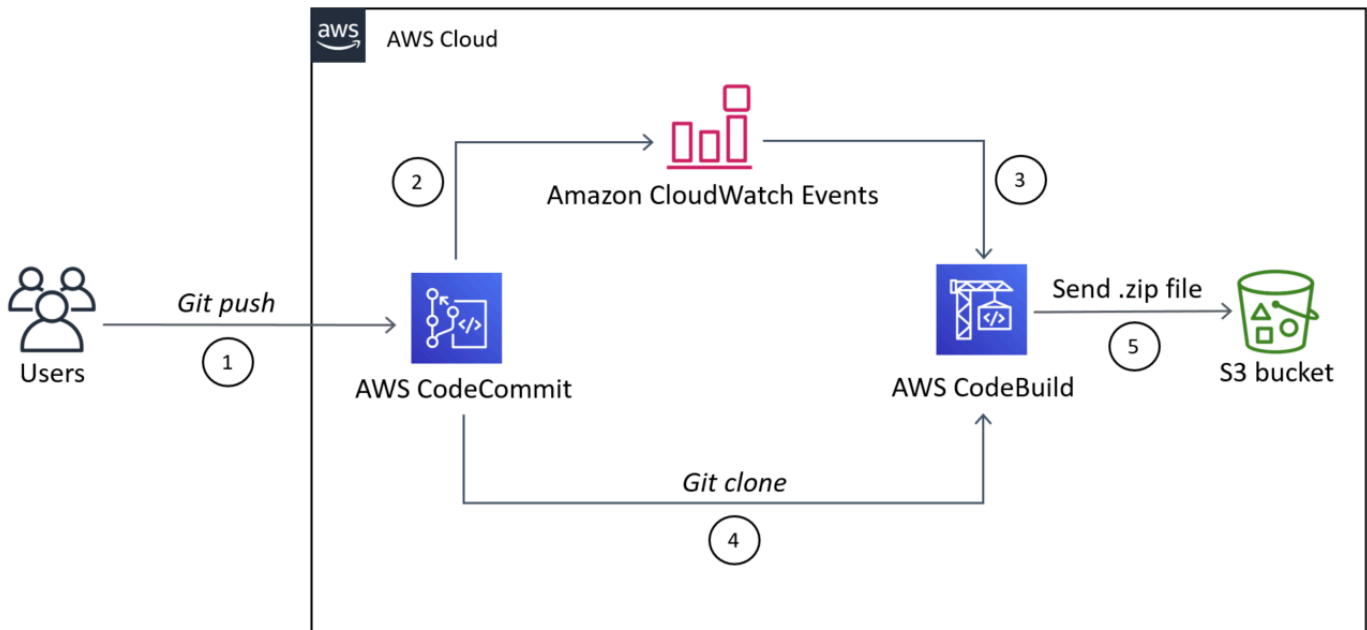

The workflow consists of the following steps:

1. Code is pushed to a CodeCommit repository.
2. The CodeCommit repository notifies CloudWatch Events of a repository change (for example, a `git push` command).
3. CloudWatch Events invokes AWS CodeBuild and sends it the CodeCommit repository information.
4. CodeBuild clones the entire CodeCommit repository and packages it into a `.zip` file.
5. CodeBuild uploads the `.zip` file to an S3 bucket.

## Technology stack

- CloudWatch Events
- CodeBuild
- CodeCommit
- Amazon S3

## Tools

- [Amazon CloudWatch Events](#) – CloudWatch Events delivers a near real-time stream of system events that describe changes in AWS resources.
- [AWS CodeBuild](#) – CodeBuild is a fully managed continuous integration service that compiles source code, runs tests, and produces software packages that are ready to deploy.
- [AWS CodeCommit](#) – CodeCommit is a fully managed source control service that hosts secure Git-based repositories.
- [AWS Identity and Access Management \(IAM\)](#) – IAM is a web service that helps you securely control access to AWS resources.
- [Amazon S3](#) – Amazon Simple Storage Service (Amazon S3) is storage for the internet.

## Epics

### Create a CodeBuild project

Task	Description	Skills required
Create a CodeBuild service role.	Sign in to the AWS Management Console and open the IAM console. Choose <b>Roles</b> , and choose <b>Create role</b> . Create a service role for CodeBuild to clone the CodeCommit repository, upload files to the S3 bucket, and send logs to Amazon CloudWatch. For more	Cloud administrator

Task	Description	Skills required
	information, see <a href="#">Create a CodeBuild service role</a> in the CodeBuild documentation.	
Create a CodeBuild project.	On the CodeBuild console, choose <b>Create CodeBuild project</b> . Create a CodeBuild project by using the <code>buildspec.yml</code> template from the <b>Additional information</b> section. For help with this story, see <a href="#">Create a build project</a> in the CodeBuild documentation.	Cloud administrator

## Create and configure the CloudWatch Events rule

Task	Description	Skills required
Create an IAM role for CloudWatch Events.	On the IAM console, choose <b>Roles</b> and create an IAM role for CloudWatch Events. For more information about this, see <a href="#">CloudWatch Events IAM role</a> in the IAM documentation.  <b>Important:</b> You must add <code>codebuild:StartBuild</code> permissions to the IAM role for CloudWatch Events.	Cloud administrator
Create a CloudWatch Events rule.	1. On the CloudWatch console, choose <b>Events</b> and then choose <b>Rules</b> .	Cloud administrator

Task	Description	Skills required
	<p>Choose <b>Create rule</b>, and use the CloudWatch Events rule from the <i>Additional information</i> section. This creates a rule that listens for event changes (for example, <code>git push</code> or <code>git commit</code> commands) in your CodeCommit repositories. For more information, see <a href="#">Create a CloudWatch Events rule for a CodeCommit source</a> in the AWS CodePipeline documentation.</p> <p>2. Choose <b>Targets</b>, choose <b>Topic</b>, and then choose <b>Configure input</b>. Choose <b>Input transformer</b>, and use the input path and input template from the <i>Additional information</i> section. This ensures that your CodeCommit repository details are parsed and sent as environment variables to the CodeBuild project. For more information, see the <a href="#">input transformer tutorial</a> in the CloudWatch documentation.</p> <p>3. Choose <b>Configure details</b>, and enter a name and</p>	

Task	Description	Skills required
	<p>description for the rule. Choose <b>Create rule</b>.</p> <p><b>Important:</b> This CloudWatch Events rule describes changes in all your CodeCommit repositories. You must modify the CloudWatch Events rule if you want to back up individual CodeCommit repositories or use separate S3 buckets for different repository backups.</p>	

## Related resources

### Creating a CodeBuild project

- [Create a CodeBuild service role](#)
- [Create a CodeBuild project](#)
- [Required permissions for Git client commands](#)

### Creating and configuring a CloudWatch Events rule

- [Create a CloudWatch Events rule for a CodeCommit source](#)
- [Use input transformer to customize what is passed to the event target](#)
- [Create a CloudWatch Events rule that initiates on an event](#)
- [Create a CloudWatch Events IAM role](#)

## Additional information

### CodeBuild buildspec.yml template

```
version: 0.2
```

```

phases:
  install:
    commands:
      - pip install git-remote-codecommit
  build:
    commands:
      - env
      - git clone -b $REFERENCE_NAME codecommit::$REPO_REGION://$REPOSITORY_NAME
      - dt=$(date '+%d-%m-%Y-%H:%M:%S');
      - echo "$dt"
      - zip -yr $dt-$REPOSITORY_NAME-backup.zip ./
      - aws s3 cp $dt-$REPOSITORY_NAME-backup.zip s3:// #substitute a valid S3 Bucket
        Name here

```

## CloudWatch Events rule

```

{
  "source": [
    "aws.codecommit"
  ],
  "detail-type": [
    "CodeCommit Repository State Change"
  ],
  "detail": {
    "event": [
      "referenceCreated",
      "referenceUpdated"
    ]
  }
}

```

## Sample input transformer for the CloudWatch Events rule target

Input path:

```

{"referenceType":"$.detail.referenceType","region":"$.region","repositoryName":"$.detail.reposi

```

Input template (please fill in the values as appropriate):

```

{
  "environmentVariablesOverride": [
    {

```

```
        "name": "REFERENCE_NAME",
        "value": ""
    },
    {
        "name": "REFERENCE_TYPE",
        "value": ""
    },
    {
        "name": "REPOSITORY_NAME",
        "value": ""
    },
    {
        "name": "REPO_REGION",
        "value": ""
    },
    {
        "name": "ACCOUNT_ID",
        "value": ""
    }
]
}
```



# Automate stack set deployment by using AWS CodePipeline and AWS CodeBuild

Created by *Thiyagarajan Mani (AWS)*, *Mihir Borkar (AWS)*, and *Raghu Gowda (AWS)*

**Code repository:** [automated-code-pipeline-stackset-deployment](#)

**Environment:** Production

**Technologies:** DevOps; DevelopmentAndTesting

**AWS services:** AWS CodeBuild; AWS CodeCommit; AWS CodePipeline; AWS Organizations; AWS CloudFormation

## Summary

In your continuous integration and continuous delivery (CI/CD) processes, you might want to deploy applications automatically into all your existing AWS accounts and into new accounts that you add to your organization in AWS Organizations. When you architect a CI/CD solution for this requirement, the [delegated stack set administrator](#) capability of AWS CloudFormation is useful because it enables a layer of security by restricting access to the management account. However, AWS CodePipeline uses the service-managed permissions model to deploy applications into multiple accounts and Regions. You must use the AWS Organizations management account to deploy with stack sets, because AWS CodePipeline doesn't support the delegated stack set administrator feature.

This pattern describes how you can work around this limitation. The pattern uses AWS CodeBuild and a custom script to automate stack set deployment with AWS CodePipeline. It automates these application deployment activities:

- Deploy an application as stack sets into existing organizational units (OUs)
- Extend the deployment of an application into additional OUs and Regions
- Remove a deployed application from all or specific OUs or Regions

## Prerequisites and limitations

### Prerequisites

Before you follow the steps in this pattern:

- Create organizations in your AWS Organizations management account. For instructions, see the [AWS Organizations documentation](#).
- Enable trusted access between AWS Organizations and CloudFormation to use service-managed permissions. For instructions, see [Enable trusted access with AWS Organizations](#) in the CloudFormation documentation.

### Limitations

The code that's supplied with this pattern has the following limitations:

- You can deploy only a single CloudFormation template for an application; multiple template deployment isn't currently supported.
- Customizing the current implementation requires DevOps expertise.
- This pattern doesn't use AWS Key Management System (AWS KMS) keys. However, you can enable this functionality by reconfiguring the CloudFormation template included with this pattern.

## Architecture

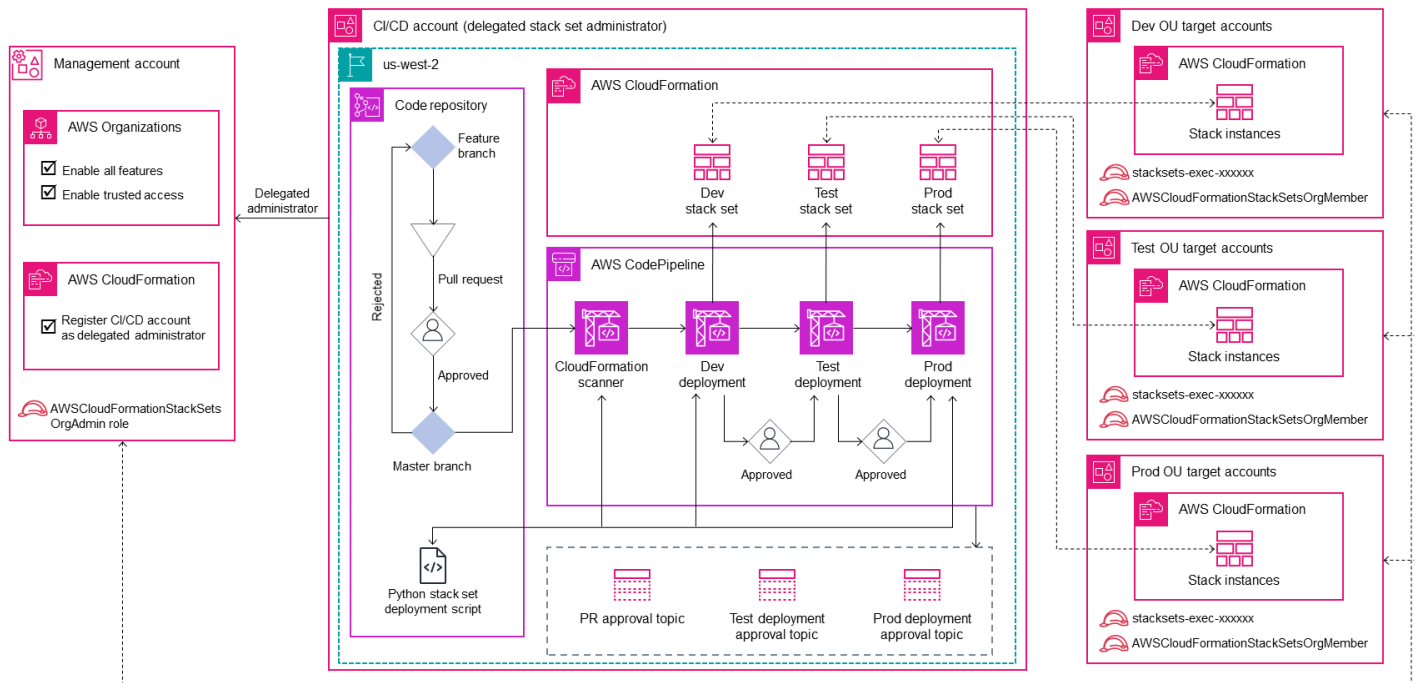

This architecture for the CI/CD deployment pipeline handles the following:

- Restricts direct access to the management account by delegating stack set deployment responsibility to a dedicated CI/CD account as the stack set administrator for application deployments.
- Uses the service-managed permission model to deploy the application automatically whenever a new account is created and mapped under an OU.
- Ensures application version consistency across all accounts at the environment level.
- Uses multiple approval stages at the repository and pipeline levels to provide additional layers of security and governance for the deployed application.
- Overcomes the current limitation of CodePipeline by using a custom-built deployment script in CodeBuild to automatically deploy or remove stack sets and stack instances. For an illustration of the flow control and hierarchy of API calls implemented by the custom script, see the [Additional information](#) section.
- Creates individual stack sets for the development, testing, and production environments. In addition, you can create stack sets that combine multiple OUs and Regions at every stage. For example, you can combine sandbox and development OUs within a development deployment stage.
- Supports application deployment into, or exclusion from, a subset of accounts or list of OUs.

## Automation and scale

You can use the code provided with this pattern to create a AWS CodeCommit repository and a code pipeline for your application. You can then deploy these as stack sets into multiple accounts at the OU level. The code also automates components such as Amazon Simple Notification Service (Amazon SNS) topics to notify approvers, the required AWS Identity and Access Management (IAM) roles, and the service control policy (SCP) to apply in the management account.

## Tools

### AWS services

- [AWS CloudFormation](#) helps you set up AWS resources, provision them quickly and consistently, and manage them throughout their lifecycle across AWS accounts and Regions.
- [AWS CodeBuild](#) is a fully managed build service that helps you compile source code, run unit tests, and produce artifacts that are ready to deploy.
- [AWS CodeCommit](#) is a version control service that helps you privately store and manage Git repositories, without needing to manage your own source control system.
- [AWS CodeDeploy](#) automates deployments to Amazon Elastic Compute Cloud (Amazon EC2) or on-premises instances, AWS Lambda functions, or Amazon Elastic Container Service (Amazon ECS) services.
- [AWS CodePipeline](#) helps you quickly model and configure the different stages of a software release and automate the steps required to release software changes continuously.
- [AWS Organizations](#) is an account management service that helps you consolidate multiple AWS accounts into an organization that you create and centrally manage.
- [Amazon Simple Notification Service \(Amazon SNS\)](#) helps you coordinate and manage the exchange of messages between publishers and clients, including web servers and email addresses.

### Code repository

The code for this pattern is available in the GitHub [automated-code-pipeline-stackset-deployment](#) repository. For the folder structure and other details, see the [readme file](#) for the repository.

## Best practices

This pattern restricts direct access to the management account while deploying the application at the OU level. Adding multiple approval stages to the pipeline and repository process helps provide additional security and governance for the applications and components that you deploy by using this approach.

## Epics

### Configure accounts in AWS Organizations

Task	Description	Skills required
Enable all features in the management account.	Enable all features in the management account for your organization by following the instructions in the <a href="#">AWS Organizations documentation</a> .	AWS administrator, Platform administrator
Create a CI/CD account.	In AWS Organizations, in your organization, create a dedicated CI/CD account, and assign a team to own and control access to the account.	AWS administrator
Add a delegated administrator.	In the management account, register the CI/CD account that you created in the previous step as a delegated stack set administrator. For instructions, see the <a href="#">AWS CloudFormation documentation</a> .	AWS administrator, Platform administrator

## Create an application repository and CI/CD pipeline

Task	Description	Skills required
Clone the code repository.	<ol style="list-style-type: none"><li>1. Clone the code repository that's provided with this pattern to your computer: <pre data-bbox="630 491 1029 730">git clone https://github.com/aws-samples/automated-code-pipeline-stackset-deployment.git</pre></li><li>2. Review the <a href="#">readme file</a> to understand the directory structure and other details.</li></ol>	AWS DevOps
Create SNS topics.	<p>You can use the <code>sns-template.yaml</code> template that's provided in the GitHub repository to create SNS topics and configure subscriptions for approval requests.</p> <ol style="list-style-type: none"><li>1. On the AWS console, sign in to the CI/CD account.</li><li>2. Open the CloudFormation console at <a href="https://console.aws.amazon.com/cloudformation">https://console.aws.amazon.com/cloudformation</a>.</li><li>3. Create a new stack with new resources (standard option).</li><li>4. For <b>Specify template</b>, choose <b>Upload a template file</b>, <b>Choose file</b>, and then select the <code>sns-template</code></li></ol>	AWS DevOps

Task	Description	Skills required
	<p>ate .yaml file from the templates folder of the cloned GitHub repository. Choose <b>Next</b>.</p> <ol style="list-style-type: none"><li>5. Provide a meaningful application stack name.</li><li>6. Specify a prefix for resources.</li><li>7. Choose <b>Next</b>, <b>Next</b>, and <b>Submit</b>.</li><li>8. When the stack has been created successfully, choose the <b>Outputs</b> tab, and note the Amazon Resource Names (ARNs) of the SNS topics for pull requests, the test environment, and the production environment. You'll use this information in subsequent steps.</li></ol>	

Task	Description	Skills required
Create IAM roles for CI/CD components.	<p>You can use the <code>cicd-role-template.yaml</code> template that's provided in the GitHub repository to create IAM roles and policies required by CI/CD components.</p> <ol style="list-style-type: none"><li>1. On the AWS console, sign in to the CI/CD account.</li><li>2. Open the CloudFormation console at <a href="https://console.aws.amazon.com/cloudformation">https://console.aws.amazon.com/cloudformation</a>.</li><li>3. Create a new stack with new resources (standard option).</li><li>4. For <b>Specify template</b>, choose <b>Upload a template file</b>, <b>Choose file</b>, and then select the <code>cicd-role-template.yaml</code> file from the <code>templates</code> folder of the cloned GitHub repository. Choose <b>Next</b>.</li><li>5. Provide a meaningful application stack name.</li><li>6. Enter values for the following parameters:<ul style="list-style-type: none"><li>• The ARN for the permission boundary policy. You can obtain this ARN from the</li></ul></li></ol>	AWS DevOps



Task	Description	Skills required
	<p><b>Policy details</b> section of your permissions boundary policy on the IAM console.</p> <ul style="list-style-type: none"><li>• The ARN for the SNS production approval topic that you noted previously.</li><li>• The ARN for the SNS test approval topic that you noted previously.</li><li>• A prefix for resources created by the template.</li></ul> <p>7. Choose <b>Next</b>, <b>Next</b>, and <b>Submit</b>.</p> <p>8. When the stack has been created successfully, choose the <b>Outputs</b> tab, and note the ARNs of the IAM roles that were created. You'll use this information in subsequent steps.</p>	

Task	Description	Skills required
Create a CodeCommit repository and a code pipeline for your application.	<p>You can use the <code>cicd-pipeline-template.yaml</code> template that's provided in the GitHub repository to create a CodeCommit repository and a code pipeline for your application.</p> <ol style="list-style-type: none"><li>1. On the AWS console, sign in to the CI/CD account.</li><li>2. Open the CloudFormation console at at <a href="https://console.aws.amazon.com/cloudformation">https://console.aws.amazon.com/cloudformation</a>.</li><li>3. Create a new stack with new resources (standard option).</li><li>4. For <b>Specify template</b>, choose <b>Upload a template file</b>, <b>Choose file</b>, and then select the <code>cicd-pipeline-template.yaml</code> file from the <code>templates</code> folder of the cloned GitHub repository. Choose <b>Next</b>.</li><li>5. Provide a meaningful application stack name.</li><li>6. Enter values for the following parameters:<ul style="list-style-type: none"><li>• <b>AppRepositoryName</b><ul style="list-style-type: none"><li>– The name of the CodeCommit repository</li></ul></li></ul></li></ol>	AWS DevOps

Task	Description	Skills required
	<p>that will be created for the application.</p> <ul style="list-style-type: none"><li>• <b>AppRepositoryDescription</b> – A brief description of the CodeCommit repository that will be created for the application.</li><li>• <b>ApplicationName</b> – The name of your application. This string is used as the name of the CodeCommit repository and as the prefix of the CI/CD pipeline.</li><li>• <b>CloudWatchEventRoleARN</b> – The ARN of the CloudWatch event role from the previous task.</li><li>• <b>CodeBuildProjectRoleARN</b> – The ARN of the CodeBuild project role from the previous task.</li><li>• <b>CodePipelineRoleARN</b> – The ARN of the CodePipeline role from the previous task.</li><li>• <b>DeploymentConfigBucket</b> – The Amazon Simple Storage Service (Amazon S3) bucket name where the deployment configura</li></ul>	

Task	Description	Skills required
	<p>tion files and script .zip file will be stored.</p> <ul style="list-style-type: none"> <li>• <b>DeploymentConfigKey</b> – The path and .zip filename (Amazon S3 key).</li> <li>• <b>PRApprovalSNSARN</b> – The ARN for the SNS topic for pull request notifications.</li> <li>• <b>ProdApprovalSNSARN</b> – The ARN for the SNS topic for production approvals.</li> <li>• <b>TESTApprovalSNSARN</b> – The ARN for the SNS topic for test approvals.</li> <li>• <b>TemplateBucket</b> – The name of the S3 bucket in the CI/CD account where the CI/CD pipeline creation template will be stored.</li> </ul> <p>7. Choose <b>Next, Next</b>, and <b>Submit</b>.</p> <p>8. When the stack completes successfully, it creates a CodeCommit repository that has the specified name and a default directory structure, deployment configuration</p>	

Task	Description	Skills required
	files, scripts, and a code pipeline for the repository.	

## Deploy a stack set

Task	Description	Skills required
Clone the application repository.	<p>The CI/CD pipeline template you used previously creates a sample application repository and code pipeline. To clone and verify the repository:</p> <ol style="list-style-type: none"><li>1. Sign in to the CI/CD account.</li><li>2. Find the application repository and CI/CD pipeline that you created in the previous epic.</li><li>3. Copy the URL for the repository and use the git clone command to clone the repository on your local machine.</li><li>4. Verify that the directory structure and files match the following:</li></ol> <pre>root  - deploy_configs      - deployment_config.json  - parameters      - template-parameter-dev.json</pre>	App developer, Data engineer

Task	Description	Skills required
	<pre data-bbox="630 205 1026 541">        - template- parameter-test.json         - template- parameter-prod.json  - templates         - template. yml  - buildspec.yml</pre> <p data-bbox="630 583 1026 1050">where the <code>deploy_configs</code> folder contains the deployment configuration file, and the <code>templates</code> and <code>parameters</code> folders include default files that you'll replace with your own CloudFormation template and parameter files.</p> <p data-bbox="630 1092 1026 1218"><b>Important:</b> Do not customize the folder structure.</p> <p data-bbox="630 1249 1026 1281">5. Create a feature branch.</p>	

Task	Description	Skills required
Add application artifacts.	<p>Update the application repository by using a CloudFormation template.</p> <p><b>Note:</b> This solution supports the deployment of only a single CloudFormation template.</p> <ol style="list-style-type: none"><li>1. Build your CloudFormation template for deploying your application code changes, and name it <code>&lt;application-name&gt;.yaml</code> .</li><li>2. Replace the <code>template.yaml</code> file in the <code>templates</code> folder of the application repository with the CloudFormation template you created in step 1.</li><li>3. Prepare parameter files for each environment (development, testing, and production).</li><li>4. Name the parameter files by using the format <code>&lt;cloudformation-template-name&gt;-parameter-&lt;environment-name&gt;.json</code> .</li><li>5. Replace the default parameter files in the</li></ol>	App developer, Data engineer

Task	Description	Skills required
	parameters folder with your files from step 4.	



Task	Description	Skills required
Update the deployment configuration file.	<p>Update the deployment <code>t_config.json</code> file:</p> <ol style="list-style-type: none"><li>1. In the application repository, navigate to the <code>deploy_configs</code> folder.</li><li>2. Open the file <code>deployment_config.json</code> :</li></ol> <pre data-bbox="630 625 1029 1837">{   "deployment_action":     "&lt;deploy/delete&gt;",   "stack_set_name":     "&lt;stack set name&gt;",   "stack_set_description":     "&lt;stack set description&gt;",   "deployment_targets": {     "dev": {      "org_units": ["list of OUs"],      "regions": ["list of regions"],      "filter_accounts":       ["list of accounts"],      "filter_type":</pre>	App developer, Data engineer

Task	Description	Skills required
	<pre> "&lt;DIFFERENCE/INTERSECTION/UNION&gt;"         },         "test": {             "org_units": ["list of OUs"],             "regions": ["list of regions"],             "filter_accounts": ["list of accounts"],             "filter_type": "&lt;DIFFERENCE/INTERSECTION/UNION&gt;"         },         "prod": {             "org_units": ["list of OUs"],             "regions": ["list of regions"],             "filter_accounts": ["list of accounts"], </pre>	

Task	Description	Skills required
	<pre data-bbox="646 289 977 1255"> "filter_type": "&lt;DIFFERENCE/INTER SECTION/UNION&gt;"      }      },     "cft_capabilities": ["CAPABILITY_IAM", "CAPABILITY_NAMED_IAM"],     "auto_deployment": "&lt;True/False&gt;",     "retain_stacks_on_account_removal": "&lt;True/False&gt;",     "region_deployment_concurrency": "&lt;SEQUENTIAL/PARALLEL&gt;"   } </pre> <p data-bbox="592 1276 945 1501">3. Update the values for deployment action, stack set name, stack set description, and deployment targets.</p> <p data-bbox="630 1549 1010 1869">For example, you can set <code>deployment_action</code> to <code>delete</code> to delete the entire stack set and its associated stack instances. Use <code>deploy</code> to create a new stack set, to update</p>	

Task	Description	Skills required
	<p>an existing stack set, or to add or remove stack instances for additional OUs or Regions. For more examples, see the <a href="#">Additional information</a> section.</p> <p>This pattern creates individual stack sets for each environment by adding the environment name to the stack set name you provide in the deployment configuration file.</p>	

Task	Description	Skills required
Commit changes and deploy the stack set.	<p>Commit the changes you specified in your application template, and merge and deploy the stack set into multiple environments stage by stage:</p> <ol style="list-style-type: none"><li>1. Save all your files and commit changes to the feature branch of your local application repository.</li><li>2. Push the feature branch to the remote repository.</li><li>3. Create a pull request to merge the changes to the main branch.</li></ol> <p>When the pull request has been approved and changes have been merged to the main branch, the CI/CD pipeline will be initiated .</p> <ol style="list-style-type: none"><li>4. When the Dev-deployment stage has completed successfully, check the CloudFormation console, <b>StackSets, Service-Managed</b> tab.</li></ol> <p>You'll see a new stack set with the suffix dev.</p> <ol style="list-style-type: none"><li>5. Check the CodeBuild logs for the Dev-deployment stage for any issues.</li></ol>	App developer, Data engineer

Task	Description	Skills required
	<p>6. Deploy the stack set into the testing and production environments by asking your approvers to approve the deployments for those stages and repeating steps 5 and 6. The stack sets for the testing and production environments have the suffixes test and prod.</p>	

## Troubleshooting

Issue	Solution
<p>Deployment fails with the exception:</p> <p><i>Change the Name of Template Parameter file as &lt;application name&gt;-parameter-&lt;env&gt;.json with, default names are not allowed</i></p>	<p>The CloudFormation template parameter files must follow the naming convention specified . Update the parameter file names and try again.</p>
<p>Deployment fails with the exception:</p> <p><i>Change the Name of CloudFormation Template as &lt;application name&gt;.yml, default template.yml or template.yaml are not allowed</i></p>	<p>The CloudFormation template name must follow the naming convention specified. Update the file name and try again.</p>
<p>Deployment fails with the exception:</p> <p><i>No valid CloudFormation Template and its Parameter File found for {environment name} environment</i></p>	<p>Check the file naming conventions for the CloudFormation template and its parameter file for the specified environment.</p>
<p>Deployment fails with the exception:</p>	<p>You specified an invalid value for the <code>deployment_action</code> parameter in the deployment configuration file. The parameter</p>

Issue	Solution
<i>Invalid deployment action provided in deployment config file. Valid options are 'deploy' and 'delete'.</i>	has two valid values: deploy and delete. Use deploy to create and update the stack sets and their associated stack instances. Use delete only when you want to remove the entire stack set and associated stack instances.

## Related resources

- GitHub [automated-code-pipeline-stackset-deployment](#) repository
- [Enabling all features in your organization](#) (AWS Organizations documentation)
- [Register a delegated administrator](#) (AWS CloudFormation documentation)
- [Account level targets for service-managed Stack Sets](#) (AWS CloudFormation documentation)

## Additional information

### Flow chart

The following flow chart depicts the flow control and hierarchy of API calls implemented by the custom script to automate stack set deployment.

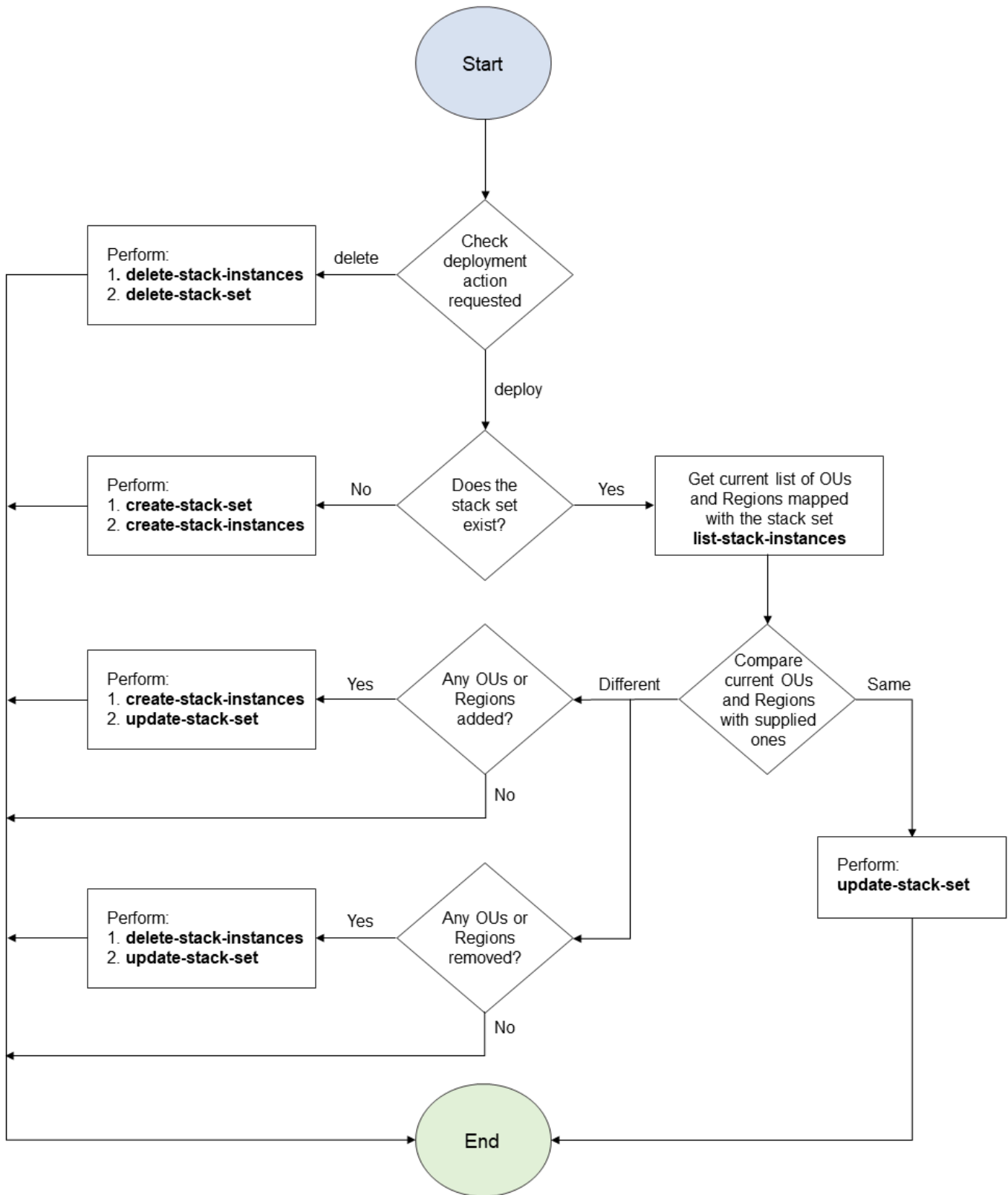

## Sample deployment configuration files



## Creating a new stack set

The following deployment configuration file creates a new stack set called `sample-stack-set` in the AWS Region `us-east-1` in three OUs.

```
{
  "deployment_action": "deploy",
  "stack_set_name": "sample-stack-set",
  "stack_set_description": "this is a sample stack set",
  "deployment_targets": {
    "dev": {
      "org_units": ["dev-org-unit-1"],
      "regions": ["us-east-1"],
      "filter_accounts": [],
      "filter_type": ""
    },
    "test": {
      "org_units": ["test-org-unit-1"],
      "regions": ["us-east-1"],
      "filter_accounts": [],
      "filter_type": ""
    },
    "prod": {
      "org_units": ["prod-org-unit-1"],
      "regions": ["us-east-1"],
      "filter_accounts": [],
      "filter_type": ""
    }
  },
  "cft_capabilities": ["CAPABILITY_IAM", "CAPABILITY_NAMED_IAM"],
  "auto_deployment": "True",
  "retain_stacks_on_account_removal": "True",
  "region_deployment_concurrency": "PARALLEL"
}
```

## Deploying an existing stack set to another OU

If you deploy the configuration shown in the previous example and you want to deploy the stack set to an additional OU called `dev-org-unit-2` in the development environment, the deployment configuration file might look like the following.

```
{
  "deployment_action": "deploy",
```

```
"stack_set_name": "sample-stack-set",
"stack_set_description": "this is a sample stack set",
"deployment_targets": {
    "dev": {
        "org_units": ["dev-org-unit-1", "dev-org-
unit-2"],
        "regions": ["us-east-1"],
        "filter_accounts": [],
        "filter_type": ""
    },
    "test": {
        "org_units": ["test-org-unit-1"],
        "regions": ["us-east-1"],
        "filter_accounts": [],
        "filter_type": ""
    },
    "prod": {
        "org_units": ["prod-org-unit-1"],
        "regions": ["us-east-1"],
        "filter_accounts": [],
        "filter_type": ""
    }
},
"cft_capabilities": ["CAPABILITY_IAM", "CAPABILITY_NAMED_IAM"],
"auto_deployment": "True",
"retain_stacks_on_account_removal": "True",
"region_deployment_concurrency": "PARALLEL"
}
```

## Deploying an existing stack set to another AWS Region

If you deploy the configuration shown in the previous example and you want to deploy the stack set to an additional AWS Region (us-east-2) in the development environment for two OUs (dev-org-unit-1 and dev-org-unit-2), the deployment configuration file might look like the following.

**Note:** The resources in the CloudFormation template must be valid and Region-specific.

```
{
    "deployment_action": "deploy",
    "stack_set_name": "sample-stack-set",
    "stack_set_description": "this is a sample stack set",
    "deployment_targets": {
```

```

        "dev": {
            "org_units": ["dev-org-unit-1", "dev-org-
unit-2"],
            "regions": ["us-east-1", "us-east-2"],
            "filter_accounts": [],
            "filter_type": ""
        },
        "test": {
            "org_units": ["test-org-unit-1"],
            "regions": ["us-east-1"],
            "filter_accounts": [],
            "filter_type": ""
        },
        "prod": {
            "org_units": ["prod-org-unit-1"],
            "regions": ["us-east-1"],
            "filter_accounts": [],
            "filter_type": ""
        }
    },
    "cft_capabilities": ["CAPABILITY_IAM", "CAPABILITY_NAMED_IAM"],
    "auto_deployment": "True",
    "retain_stacks_on_account_removal": "True",
    "region_deployment_concurrency": "PARALLEL"
}

```

## Removing a stack instance from an OU or AWS Region

Let's say that the deployment configuration shown in the previous example has been deployed. The following configuration file removes the stack instances from both Regions of the OU dev-org-unit-2.

```

{
    "deployment_action": "deploy",
    "stack_set_name": "sample-stack-set",
    "stack_set_description": "this is a sample stack set",
    "deployment_targets": {
        "dev": {
            "org_units": ["dev-org-unit-1"],
            "regions": ["us-east-1", "us-east-2"],
            "filter_accounts": [],
            "filter_type": ""
        },
    },
}

```

```

        "test": {
            "org_units": ["test-org-unit-1"],
            "regions": ["us-east-1"],
            "filter_accounts": [],
            "filter_type": ""
        },
        "prod": {
            "org_units": ["prod-org-unit-1"],
            "regions": ["us-east-1"],
            "filter_accounts": [],
            "filter_type": ""
        }
    },
    "cft_capabilities": ["CAPABILITY_IAM", "CAPABILITY_NAMED_IAM"],
    "auto_deployment": "True",
    "retain_stacks_on_account_removal": "True",
    "region_deployment_concurrency": "PARALLEL"
}

```

The following configuration file removes the stack instance from the AWS Region us-east-1 for both OUs in the development environment.

```

{
    "deployment_action": "deploy",
    "stack_set_name": "sample-stack-set",
    "stack_set_description": "this is a sample stack set",
    "deployment_targets": {
        "dev": {
            "org_units": ["dev-org-unit-1", "dev-org-
unit-2"],
            "regions": ["us-east-2"],
            "filter_accounts": [],
            "filter_type": ""
        },
        "test": {
            "org_units": ["test-org-unit-1"],
            "regions": ["us-east-1"],
            "filter_accounts": [],
            "filter_type": ""
        },
        "prod": {
            "org_units": ["prod-org-unit-1"],

```

```

        "regions": ["us-east-1"],
        "filter_accounts": [],
        "filter_type": ""
    },
    },
    "cft_capabilities": ["CAPABILITY_IAM", "CAPABILITY_NAMED_IAM"],
    "auto_deployment": "True",
    "retain_stacks_on_account_removal": "True",
    "region_deployment_concurrency": "PARALLEL"
}

```

## Deleting the entire stack set

The following deployment configuration file deletes the entire stack set and all its associated stack instances.

```

{
  "deployment_action": "delete",
  "stack_set_name": "sample-stack-set",
  "stack_set_description": "this is a sample stack set",
  "deployment_targets": {
    "dev": {
      "org_units": ["dev-org-unit-1", "dev-org-
unit-2"],
      "regions": ["us-east-2"],
      "filter_accounts": [],
      "filter_type": ""
    },
    "test": {
      "org_units": ["test-org-unit-1"],
      "regions": ["us-east-1"],
      "filter_accounts": [],
      "filter_type": ""
    },
    "prod": {
      "org_units": ["prod-org-unit-1"],
      "regions": ["us-east-1"],
      "filter_accounts": [],
      "filter_type": ""
    }
  },
  "cft_capabilities": ["CAPABILITY_IAM", "CAPABILITY_NAMED_IAM"],
  "auto_deployment": "True",
}

```

```
"retain_stacks_on_account_removal": "True",
"region_deployment_concurrency": "PARALLEL"
}
```

## Excluding an account from deployment

The following deployment configuration file excludes the account 111122223333, which is part of the OU dev-org-unit-1, from deployment.

```
{
  "deployment_action": "deploy",
  "stack_set_name": "sample-stack-set",
  "stack_set_description": "this is a sample stack set",
  "deployment_targets": {
    "dev": {
      "org_units": ["dev-org-unit-1"],
      "regions": ["us-east-1"],
      "filter_accounts": ["111122223333"],
      "filter_type": "DIFFERENCE"
    },
    "test": {
      "org_units": ["test-org-unit-1"],
      "regions": ["us-east-1"],
      "filter_accounts": [],
      "filter_type": ""
    },
    "prod": {
      "org_units": ["prod-org-unit-1"],
      "regions": ["us-east-1"],
      "filter_accounts": [],
      "filter_type": ""
    }
  },
  "cft_capabilities": ["CAPABILITY_IAM", "CAPABILITY_NAMED_IAM"],
  "auto_deployment": "True",
  "retain_stacks_on_account_removal": "True",
  "region_deployment_concurrency": "PARALLEL"
}
```

## Deploying the application to a subset of accounts in an OU

The following deployment configuration file deploys the application to only three accounts (111122223333, 444455556666, and 777788889999) in the OU dev-org-unit-1.

```
{
  "deployment_action": "deploy",
  "stack_set_name": "sample-stack-set",
  "stack_set_description": "this is a sample stack set",
  "deployment_targets": {
    "dev": {
      "org_units": ["dev-org-unit-1"],
      "regions": ["us-east-1"],
      "filter_accounts": ["111122223333",
"444455556666", "777788889999"],
      "filter_type": "INTERSECTION"
    },
    "test": {
      "org_units": ["test-org-unit-1"],
      "regions": ["us-east-1"],
      "filter_accounts": [],
      "filter_type": ""
    },
    "prod": {
      "org_units": ["prod-org-unit-1"],
      "regions": ["us-east-1"],
      "filter_accounts": [],
      "filter_type": ""
    }
  },
  "cft_capabilities": ["CAPABILITY_IAM", "CAPABILITY_NAMED_IAM"],
  "auto_deployment": "True",
  "retain_stacks_on_account_removal": "True",
  "region_deployment_concurrency": "PARALLEL"
}
```

# Automatically attach an AWS managed policy for Systems Manager to EC2 instance profiles using Cloud Custodian and AWS CDK

Created by Ali Asfour (AWS) and Aaron Lennon (AWS)

**Environment:** PoC or pilot

**Technologies:** DevOps;  
DevelopmentAndTesting;  
Management & governance;  
Security, identity, compliance;  
Infrastructure

**Workload:** Open-source

**AWS services:** Amazon SNS;  
Amazon SQS; AWS CodeBuild  
; AWS CodePipeline; AWS  
Systems Manager; AWS  
CodeCommit

## Summary

You can integrate Amazon Elastic Compute Cloud (Amazon EC2) instances with AWS Systems Manager to automate operational tasks and provide more visibility and control. To integrate with Systems Manager, EC2 instances must have an installed [AWS Systems Manager Agent \(SSM Agent\)](#) and an AmazonSSMManagedInstanceCore AWS Identity and Access Management (IAM) policy attached to their instance profiles.

However, if you want to ensure that all EC2 instance profiles have the AmazonSSMManagedInstanceCore policy attached, you can face challenges updating new EC2 instances that don't have instance profiles or EC2 instances that have an instance profile but don't have the AmazonSSMManagedInstanceCore policy. It can also be difficult to add this policy across multiple Amazon Web Services (AWS) accounts and AWS Regions.

This pattern helps solve these challenges by deploying three [Cloud Custodian](#) policies in your AWS accounts:



- The first Cloud Custodian policy checks for existing EC2 instances that have an instance profile but don't have the `AmazonSSMManagedInstanceCore` policy. The `AmazonSSMManagedInstanceCore` policy is then attached.
- The second Cloud Custodian policy checks for existing EC2 instances without an instance profile and adds a default instance profile that has the `AmazonSSMManagedInstanceCore` policy attached.
- The third Cloud Custodian policy creates [AWS Lambda functions](#) in your accounts to monitor the creation of EC2 instances and instance profiles. This ensures that the `AmazonSSMManagedInstanceCore` policy is automatically attached when an EC2 instance is created.

This pattern uses [AWS DevOps](#) tools to achieve a continuous, at-scale deployment of the Cloud Custodian policies to a multi-account environment, without provisioning a separate compute environment.

## Prerequisites and limitations

### Prerequisites

- Two or more active AWS accounts. One account is the *security account* and the others are *member accounts*.
- Permissions to provision AWS resources in the security account. This pattern uses [administrator permissions](#), but you should grant permissions according to your organization's requirements and policies.
- Ability to assume an IAM role from the security account to member accounts and create the required IAM roles. For more information about this, see [Delegate access across AWS accounts using IAM roles](#) in the IAM documentation.
- AWS Command Line Interface (AWS CLI), installed and configured. For testing purposes, you can configure AWS CLI by using the `aws configure` command or setting environment variables. **Important:** This isn't recommended for production environments and we recommend that this account is only granted least privilege access. For more information about this, see [Grant least privilege](#) in the IAM documentation.
- The `devops-cdk-cloudcustodian.zip` file (attached), downloaded to your local computer.
- Familiarity with Python.

- The required tools (Node.js, AWS Cloud Development Kit (AWS CDK), and Git), installed and configured. You can use the `install-prerequisites.sh` file in the `devops-cdk-cloudcustodian.zip` file to install these tools. Make sure you run this file with root privileges.

## Limitations

- Although this pattern can be used in a production environment, make sure that all IAM roles and policies meet your organization's requirements and policies.

## Package versions

- Cloud Custodian version 0.9 or later
- TypeScript version 3.9.7 or later
- Node.js version 14.15.4 or later
- npm version 7.6.1 or later
- AWS CDK version 1.96.0 or later

## Architecture

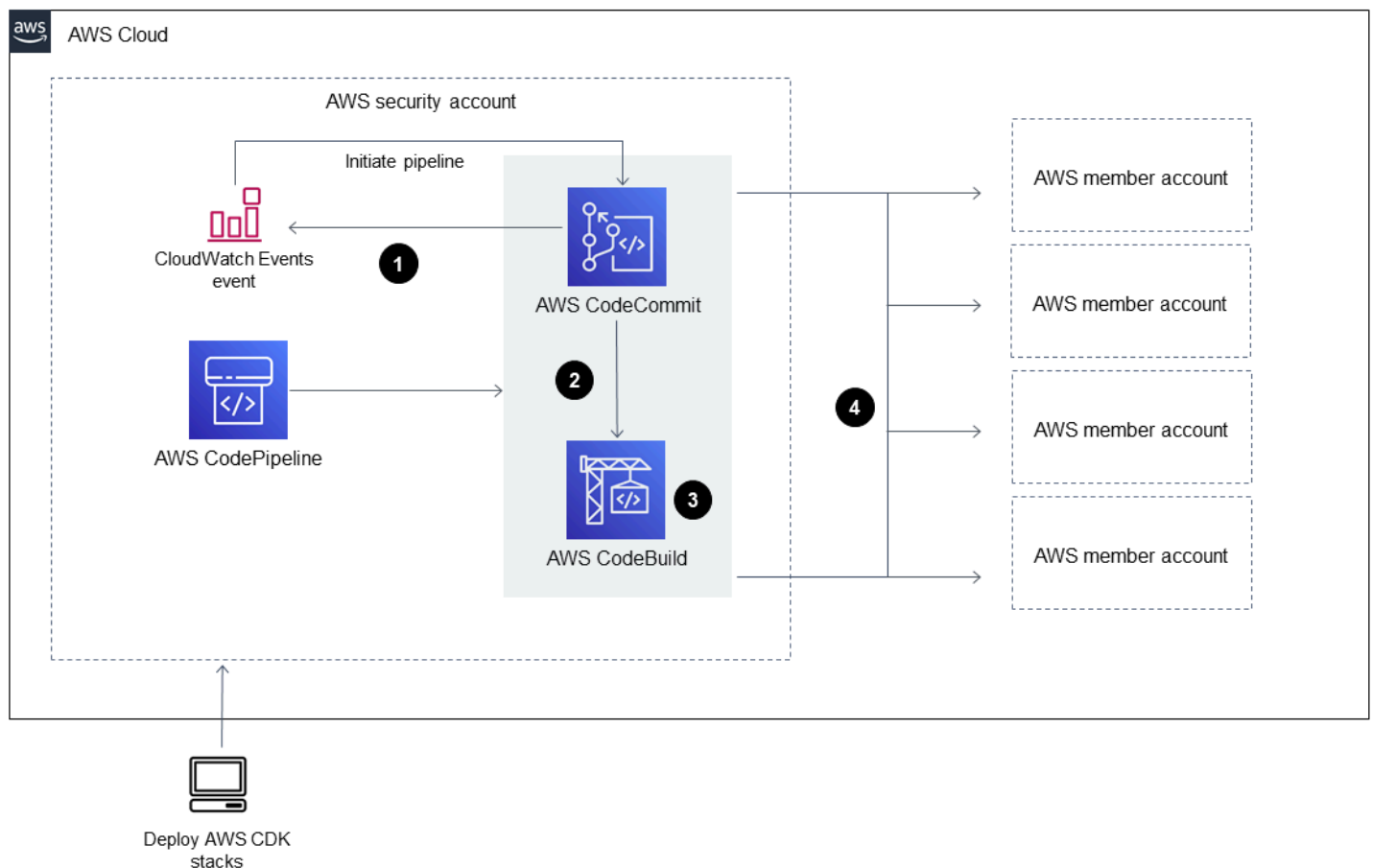

The diagram shows the following workflow:

1. Cloud Custodian policies are pushed to an AWS CodeCommit repository in the security account. An Amazon CloudWatch Events rule automatically initiates the AWS CodePipeline pipeline.
2. The pipeline fetches the most recent code from CodeCommit and sends it to the continuous integration part of the continuous integration and continuous delivery (CI/CD) pipeline handled by AWS CodeBuild.
3. CodeBuild performs the complete DevSecOps actions, including policy syntax validation on the Cloud Custodian policies, and runs these policies in `--dryrun` mode to check which resources are identified.
4. If there are no errors, the next task alerts an administrator to review the changes and approve the deployment into the member accounts.

## Technology stack

- AWS CDK

- CodeBuild
- CodeCommit
- CodePipeline
- IAM
- Cloud Custodian

## Automation and scale

The AWS CDK pipelines module provisions a CI/CD pipeline that uses CodePipeline to orchestrate the building and testing of source code with CodeBuild, in addition to the deployment of AWS resources with AWS CloudFormation stacks. You can use this pattern for all member accounts and Regions in your organization. You can also extend the Roles creation stack to deploy other IAM roles in your member accounts.

## Tools

- [AWS Cloud Development Kit \(AWS CDK\)](#) is a software development framework for defining cloud infrastructure in code and provisioning it through AWS CloudFormation.
- [AWS Command Line Interface \(AWS CLI\)](#) is an open-source tool that enables you to interact with AWS services using commands in your command-line shell.
- [AWS CodeBuild](#) is a fully managed build service in the cloud.
- [AWS CodeCommit](#) is a version control service that you can use to privately store and manage assets.
- [AWS CodePipeline](#) is a continuous delivery service you can use to model, visualize, and automate the steps required to release your software.
- [AWS Identity and Access Management](#) is a web service that helps you securely control access to AWS resources.
- [Cloud Custodian](#) is a tool that unifies the dozens of tools and scripts most organizations use for managing their public cloud accounts into one open-source tool.
- [Node.js](#) is a JavaScript runtime built on Google Chrome's V8 JavaScript engine.

## Code

For a detailed list of modules, account functions, files, and deployment commands used in this pattern, see the README file in the `devops-cdk-cloudcustodian.zip` file (attached).

# Epics

## Set up the pipeline with AWS CDK

Task	Description	Skills required
Set up the CodeCommit repository.	<ol style="list-style-type: none"><li>1. Unzip the <code>devops-cdk-cloudcustodian.zip</code> file (attached) in the working directory on your local computer.</li><li>2. Sign in to the AWS Management Console for your security account, open the CodeCommit console, and then create a new <code>devops-cdk-cloudcustodian</code> repository.</li><li>3. Change into the project directory and set up the CodeCommit repository as the origin, commit the changes, and then push them to the origin branch by running the following commands:<ul style="list-style-type: none"><li>• <code>cd devops-cdk-cloudcustodian</code></li><li>• <code>git init --initial-branch=main</code></li><li>• <code>git add . git commit -m 'initial commit'</code></li><li>• <code>git remote add origin https://git-codeco</code></li></ul></li></ol>	Developer

Task	Description	Skills required
	<pre>commit.us-east-1.amazonaws.com/v1/devops-cdk-cloudcustodian</pre> <ul style="list-style-type: none"><li>• <code>git push origin main</code></li></ul> <p>For more information about this, see <a href="#">Creating a CodeCommit repository</a> in the AWS CodeCommit documentation.</p>	
Install the required tools.	<p>Use the <code>install-prerequisites.sh</code> file to install all the required tools on Amazon Linux. This doesn't include AWS CLI because it comes pre-installed.</p> <p>For more information about this, see the <a href="#">Prerequisites</a> section of <a href="#">Getting started with the AWS CDK</a> in the AWS CDK documentation.</p>	Developer

Task	Description	Skills required
Install the required AWS CDK packages.	<ol style="list-style-type: none"><li>1. Set up your virtual environment by running the following command in AWS CLI: <code>\$ python3 -m venv .env</code></li><li>2. Activate your virtual environment by running the following command: <code>\$ source .env/bin/activate</code></li><li>3. After the virtual environment is activated, install the required dependencies by running the following command: <code>\$ pip install -r requirements.txt</code></li><li>4. To add additional dependencies (for example, other AWS CDK libraries), add them to the <code>requirements.txt</code> file, and then run the following command: <code>pip install -r requirements.txt</code></li></ol> <p>The following packages are required by AWS CDK and are included in the <code>requirements.txt</code> file:</p> <ul style="list-style-type: none"><li>• <code>aws-cdk.aws-cloudwatch</code></li></ul>	Developer

Task	Description	Skills required
	<ul style="list-style-type: none"> <li>• <code>aws-cdk.aws-codebuild</code></li> <li>• <code>aws-cdk.aws-codecommit</code></li> <li>• <code>aws-cdk.aws-codedeploy</code></li> <li>• <code>aws-cdk.aws-codepipeline</code></li> <li>• <code>aws-cdk.aws-codepipeline-actions</code></li> <li>• <code>aws-cdk.aws-events</code></li> <li>• <code>aws-cdk.aws-eventstargets</code></li> <li>• <code>aws-cdk.aws-iam</code></li> <li>• <code>aws-cdk.aws-logs</code></li> <li>• <code>aws-cdk.aws-s3</code></li> <li>• <code>aws-cdk.aws-sns</code></li> <li>• <code>aws-cdk.aws-sns-subscriptions</code></li> <li>• <code>aws-cdk.aws-sqs</code></li> <li>• <code>aws-cdk.core</code></li> </ul>	

## Configure your environment

Task	Description	Skills required
Update the required variables.	Open the <code>vars.py</code> file in the root folder of your CodeCommit repository and update the following variables:	Developer



Task	Description	Skills required
	<ul style="list-style-type: none"><li>• Update <code>var_deploy_region = 'us-east-1'</code> with the AWS Region where you want the pipeline to be deployed.</li><li>• Update <code>var_codecommit_repo_name = "cdk-cloudcustodian"</code> with the name of your CodeCommit repository.</li><li>• Update <code>var_codecommit_branch_name = "main"</code> with name of the CodeCommit branch.</li><li>• Update <code>var_admin_email='notifyadmin@email.com'</code> with the email address for the administrator that approves changes.</li><li>• Update <code>var_slack_webhook_url = https://hooks.slack.com/services/T0000000/B00000000/XXXXXXXXXXXXXXXXXXXXXXX</code> with the Slack webhook used to send Cloud Custodian notifications when changes are made.</li></ul>	

Task	Description	Skills required
	<ul style="list-style-type: none"><li>• Update <code>var_orgId = 'o-yyyyyyyyyyy'</code> with your organization ID.</li><li>• Update <code>security_account = '123456789011'</code> with the AWS account ID for the account where the pipeline is deployed.</li><li>• Update <code>member_accounts = ['111111111111', '111111111112', '111111111113']</code> with the member accounts where you want to bootstrap the AWS CDK stack and deploy the required IAM roles.</li><li>• Set <code>cdk_boots_trap_member_accounts = True</code> to <code>True</code> if you want the pipeline to automatically bootstrap the AWS CDK to your member accounts. If set to <code>True</code> this also requires the name of an existing IAM role in the member accounts that can be assumed from the security account. This IAM role must also have the required permissions to bootstrap the AWS CDK.</li></ul>	

Task	Description	Skills required
	<ul style="list-style-type: none"><li>Update <code>cdk_boots_trap_role = 'AWSControlTowerExecution'</code> with the existing IAM role in the member accounts that can be assumed from the security account. This role must also permission to bootstrap the AWS CDK. <b>Note:</b> This only applies if <code>cdk_bootstrap_member_accounts</code> is set to <code>True</code>.</li></ul>	

Task	Description	Skills required
Update the account.yml file with the member account information.	<p>To run the <a href="#">c7n-org Cloud Custodian</a> tool against multiple accounts, you must place the <code>accounts.yml</code> config file in the root of the repository. The following is a sample Cloud Custodian config file for AWS:</p> <pre> accounts: - account_id: '123123123123'   name: account-1   regions:   - us-east-1   - us-west-2   role: arn:aws:iam::123123123123:role/CloudCustodian   vars:     charge_code: xyz   tags:   - type:prod   - division:some   division   - partition:us   - scope:pci </pre>	Developer

## Bootstrap the AWS accounts

Task	Description	Skills required
Bootstrap the security account.	Bootstrap the <code>deploy_account</code> with the <code>cloudcustodian_stack</code> applicati	Developer

Task	Description	Skills required
	<p>on by running the following command:</p> <pre data-bbox="594 327 1029 531">cdk bootstrap -a python3 cloudcustodian/cl oudcustodian_stack.py</pre>	
<p>Option 1 - Automatically bootstrap the member accounts.</p>	<p>If the <code>cdk_bootstrap_member_accounts</code> variable is set to <code>True</code> in the <code>vars.py</code> file, the accounts specified in the <code>member_accounts</code> variable are automatically bootstrapped by the pipeline.</p> <p>If required, you can update <code>*cdk_bootstrap_role*</code> with an IAM role that you can assume from the security account and that has the required permissions to bootstrap the AWS CDK.</p> <p>New accounts added to the <code>member_accounts</code> variable are automatically bootstrapped by the pipeline so that the required roles can be deployed.</p>	<p>Developer</p>

Task	Description	Skills required
Option 2 - Manually bootstrap the member accounts.	<p>Although we don't recommend using this approach, you can set the value of <code>cdk_bootstrap_member_accounts</code> to <code>False</code> and perform this step manually by running the following command:</p> <pre data-bbox="594 632 1027 1787">\$ cdk bootstrap -a 'python3 cloudcustodian/member_account_roles_stack.py' \ --trust {security_account_id} \ --context assume-role-credentials:writeIamRoleName={role_name} \ --context assume-role-credentials:readIamRoleName={role_name} \ --mode=ForWriting \ --context bootstrap=true \ --cloudformation-execution-policies arn:aws:iam::aws:policy/AdministratorAccess</pre>	Developer

Task	Description	Skills required
	<p><b>Important:</b> Make sure that you update the <code>{security_account_id}</code> and <code>{role_name}</code> values with the name of an IAM role that you can assume from the security account and that has the required permissions to bootstrap the AWS CDK.</p> <p>You can also use other approaches to bootstrap the member accounts, for example, with AWS CloudFormation. For more information about this, see <a href="#">Bootstrapping</a> in the AWS CDK documentation.</p>	

## Deploy the AWS CDK stacks

Task	Description	Skills required
Create the IAM roles in the member accounts.	<p>Run the following command to deploy the <code>member_account_roles_stack</code> stack and create the IAM roles in the member accounts:</p> <pre>cdk deploy --all -a 'python3 cloudcustodian/member_account_roles_stack.py' --require-approval never</pre>	Developer

Task	Description	Skills required
Deploy the Cloud Custodian pipeline stack.	Run the following command to create the Cloud Custodian <code>cloudcustodian_stack.py</code> pipeline that is deployed into the security account:  <pre>cdk deploy -a 'python3 cloudcustodian/cloudcustodian_stack.py'</pre>	Developer

## Related resources

- [Getting started with the AWS CDK](#)

## Attachments

To access additional content that is associated with this document, unzip the following file: [attachment.zip](#)



# Automatically build CI/CD pipelines and Amazon ECS clusters for microservices using AWS CDK

Created by Varsha Raju (AWS)

**Environment:** PoC or pilot

**Technologies:** DevOps;  
Containers & microservices;  
Modernization; Infrastructure

**AWS services:** AWS  
CodeBuild; AWS CodeCommit;  
AWS CodePipeline; Amazon  
ECS; AWS CDK

## Summary

This pattern describes how to automatically create the continuous integration and continuous delivery (CI/CD) pipelines and underlying infrastructure for building and deploying microservices on Amazon Elastic Container Service (Amazon ECS). You can use this approach if you want to set up proof-of-concept CI/CD pipelines to show your organization the benefits of CI/CD, microservices, and DevOps. You can also use this approach to create initial CI/CD pipelines that you can then customize or change according to your organization's requirements.

The pattern's approach creates a production environment and non-production environment that each have a virtual private cloud (VPC) and an Amazon ECS cluster configured to run in two Availability Zones. These environments are shared by all your microservices and you then create a CI/CD pipeline for each microservice. These CI/CD pipelines pull changes from a source repository in AWS CodeCommit, automatically build the changes, and then deploy them into your production and non-production environments. When a pipeline successfully completes all of its stages, you can use URLs to access the microservice in the production and non-production environments.

## Prerequisites and limitations

### Prerequisites

- An active Amazon Web Services (AWS) account.
- An existing Amazon Simple Storage Service (Amazon S3) bucket that contains the `starter-code.zip` file (attached).
- AWS Cloud Development Kit (AWS CDK), installed and configured in your account. For more information about this, see [Getting started with the AWS CDK](#) in the AWS CDK documentation.

- Python 3 and pip, installed and configured. For more information about this, see the [Python documentation](#).
- Familiarity with AWS CDK, AWS CodePipeline, AWS CodeBuild, CodeCommit, Amazon Elastic Container Registry (Amazon ECR), Amazon ECS, and AWS Fargate.
- Familiarity with Docker.
- An understanding of CI/CD and DevOps.

### Limitations

- General AWS account limits apply. For more information about this, see [AWS service quotas](#) in the AWS General Reference documentation.

### Product versions

- The code was tested using Node.js version 16.13.0 and AWS CDK version 1.132.0.

## Architecture

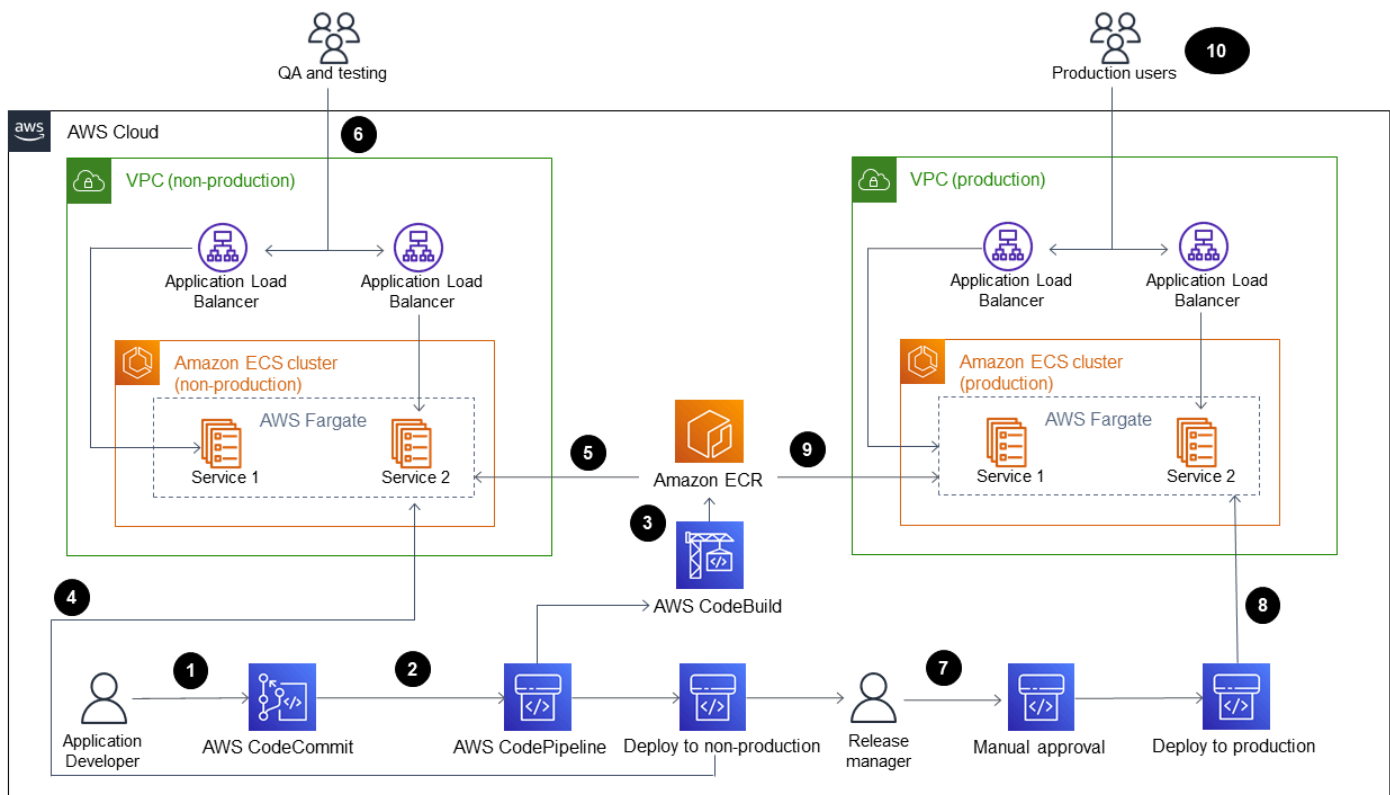

The diagram shows the following workflow:

1. An application developer commits code to a CodeCommit repository.
2. A pipeline is initiated.
3. CodeBuild builds and pushes the Docker image to an Amazon ECR repository
4. CodePipeline deploys a new image to an existing Fargate service in a non-production Amazon ECS cluster.
5. Amazon ECS pulls the image from the Amazon ECR repository into a non-production Fargate service.
6. Testing is performed using a non-production URL.
7. The release manager approves the production deployment.
8. CodePipeline deploys the new image to an existing Fargate service in a production Amazon ECS cluster
9. Amazon ECS pulls the image from the Amazon ECR repository into the production Fargate service.
- 10 Production users access your feature by using a production URL.

## Technology stack

- AWS CDK
- CodeBuild
- CodeCommit
- CodePipeline
- Amazon ECR
- Amazon ECS
- Amazon VPC

## Automation and scale

You can use this pattern's approach to create pipelines for microservices deployed in a shared AWS CloudFormation stack. The automation can create more than one Amazon ECS cluster in each VPC and also create pipelines for microservices deployed in a shared Amazon ECS cluster. However, this requires that you provide new resource information as inputs to the pipeline stack.

## Tools

- [AWS CDK](#) – AWS Cloud Development Kit (AWS CDK) is a software development framework for defining cloud infrastructure in code and provisioning it through AWS CloudFormation.
- [AWS CodeBuild](#) – AWS CodeBuild is a fully managed build service in the cloud. CodeBuild compiles your source code, runs unit tests, and produces artifacts that are ready to deploy.
- [AWS CodeCommit](#) – AWS CodeCommit is a version control service that enables you to privately store and manage Git repositories in the AWS Cloud. CodeCommit eliminates the need for you to manage your own source control system or worry about scaling its infrastructure.
- [AWS CodePipeline](#) – AWS CodePipeline is a continuous delivery service you can use to model, visualize, and automate the steps required to release your software. You can quickly model and configure the different stages of a software release process. CodePipeline automates the steps required to release your software changes continuously.
- [Amazon ECS](#) – Amazon Elastic Container Service (Amazon ECS) is a highly scalable, fast container management service that is used for running, stopping, and managing containers on a cluster. You can run your tasks and services on a serverless infrastructure that is managed by AWS Fargate. Alternatively, for more control over your infrastructure, you can run your tasks and services on a cluster of Amazon Elastic Compute Cloud (Amazon EC2) instances that you manage.
- [Docker](#) – Docker helps developers to pack, ship, and run any application as a lightweight, portable, and self-sufficient container.

## Code

The code for this pattern is available in the `cicdstarter.zip` and `starter-code.zip` files (attached).

## Epics

### Set up your environment

Task	Description	Skills required
Set up the working directory for AWS CDK.	1. Create a directory named <code>cicdproject</code> on your local machine.	AWS DevOps, Cloud infrastructure

Task	Description	Skills required
	<ol style="list-style-type: none"><li>2. Download the <code>cicdstarter.zip</code> file (attached) into the <code>cicdproject</code> directory and unzip it. This creates a folder named <code>cicdstarter</code>.</li><li>3. Run the <code>cd &lt;user-home&gt;/cicdproject/cicdstarter</code> command.</li><li>4. Set up the Python virtual environment by running the <code>python3 -m venv .venv</code> command.</li><li>5. Run the <code>source ./venv/bin/activate</code> command.</li><li>6. Configure your AWS environment by running the <code>aws configure</code> command or by using the following environment variables:<ul style="list-style-type: none"><li>• <code>AWS_ACCESS_KEY_ID</code></li><li>• <code>AWS_SECRET_ACCESS_KEY</code></li><li>• <code>AWS_DEFAULT_REGION</code></li></ul></li></ol>	

## Create the shared infrastructure

Task	Description	Skills required
Create the shared infrastructure.	<ol style="list-style-type: none"><li data-bbox="592 331 1027 464">1. In your working directory, run the <code>cd cicdvpc-ecs</code> command.</li><li data-bbox="592 485 1027 716">2. Run the <code>pip3 install -r requirements.txt</code> command to install all required Python dependencies</li><li data-bbox="592 737 1027 911">3. Run the <code>cdk bootstrap</code> command to set the AWS environment for the AWS CDK.</li><li data-bbox="592 932 1027 1213">4. Run the <code>cdk synth --context aws_account=&lt;aws_account_ID&gt; --context aws_region=&lt;aws-region&gt;</code> command.</li><li data-bbox="592 1234 1027 1516">5. Run the <code>cdk deploy --context aws_account=&lt;aws_account_ID&gt; --context aws_region=&lt;aws-region&gt;</code> command.</li><li data-bbox="592 1537 1027 1864">6. The AWS CloudFormation stack creates the following infrastructure:<ul style="list-style-type: none"><li data-bbox="630 1686 990 1864">• A non-production VPC named <code>cicd-vpc-ecs/cicd-vpc-nonprod</code></li></ul></li></ol>	AWS DevOps, Cloud infrastructure

Task	Description	Skills required
	<ul style="list-style-type: none"><li>• A production VPC named <code>cicd-vpc-ecs/cicd-vpc-prod</code></li><li>• A non-production Amazon ECS cluster named <code>cicd-ecs-nonprod</code></li><li>• A production Amazon ECS cluster named <code>cicd-ecs-prod</code></li></ul>	
Monitor the AWS CloudFormation stack.	<ol style="list-style-type: none"><li>1. Sign in to the AWS Management Console, open the AWS CloudFormation console, and then choose the <code>cicd-vpc-ecs</code> stack from the list.</li><li>2. In the stack details pane, choose the <b>Events</b> tab and monitor the progress of your stack creation.</li></ol>	AWS DevOps, Cloud infrastructure

Task	Description	Skills required
Test the AWS CloudFormation stack.	<ol style="list-style-type: none"> <li>After the <code>cicd-vpc-ecs</code> AWS CloudFormation stack is created, ensure that the <code>cicd-vpc-ecs/cicd-vpc-nonprod</code> and <code>cicd-vpc-ecs/cicd-vpc-prod</code> VPCs are created.</li> <li>Ensure that the <code>cicd-ecs-nonprod</code> and <code>cicd-ecs-prod</code> Amazon ECS clusters are created.</li> </ol> <p><b>Important:</b> Make sure that you record the IDs for the two VPCs and the security group IDs for the default security groups in both VPCs.</p>	AWS DevOps, Cloud infrastructure

### Create a CI/CD pipeline for a microservice

Task	Description	Skills required
Create the infrastructure for the microservice.	<ol style="list-style-type: none"> <li>Name your microservice. For example, this pattern uses <code>myservice1</code> as the microservice's name.</li> <li>In your working directory run the <code>cd &lt;working-directory&gt;/cdpipeline</code> command.</li> </ol>	AWS DevOps, Cloud infrastructure



Task	Description	Skills required
	<ol style="list-style-type: none"><li>3. Run the <code>pip3 install -r requirements.txt</code> command.</li><li>4. Run the full <code>cdk synth</code> command that is available in the <i>Additional information</i> section of this pattern.</li><li>5. Run the full <code>cdk deploy</code> command that is available in the <i>Additional information</i> section of this pattern.</li></ol> <p><b>Note:</b> You can also provide the values for both commands by using the <code>cdk.json</code> file in the directory.</p>	
Monitor the AWS CloudFormation stack.	Open the AWS CloudFormation console and monitor the progress of the <code>myservice-1-cicd-stack</code> stack. Eventually, the status changes to <code>CREATE_COMPLETE</code> .	AWS DevOps, Cloud infrastructure

Task	Description	Skills required
Test the AWS CloudFormation stack.	<ol style="list-style-type: none"><li data-bbox="592 226 1027 457">1. On the AWS CodeCommit console, verify that a repository named <code>myservice1</code> exists and contains the starter code.</li><li data-bbox="592 478 1027 657">2. On the AWS CodeBuild console, verify that a build project named <code>myservice1</code> exists.</li><li data-bbox="592 678 1027 909">3. On the Amazon ECR console, verify that an Amazon ECR repository named <code>myservice1</code> exists.</li><li data-bbox="592 930 1027 1245">4. On the Amazon ECS console, verify that a Fargate service named <code>myservice1</code> exists in both a non-production and production Amazon ECS cluster.</li><li data-bbox="592 1266 1027 1633">5. On the Amazon Elastic Compute Cloud (Amazon EC2) console, verify that the non-production and production Application Load Balancers are created. Record the DNS names of the ALBs.</li><li data-bbox="592 1654 1027 1833">6. On the AWS CodePipeline console, verify that a pipeline named <code>myservice1</code> exists. It</li></ol>	

Task	Description	Skills required
	<p>must have Source, Build, Deploy-NonProd , and Deploy-Prod stages. The pipeline should also have an in progress status.</p> <ol style="list-style-type: none"><li>7. Monitor the pipeline until all stages are complete.</li><li>8. Manually approve it for production.</li><li>9. In a browser window, enter the DNS names of the ALBs.</li><li>10. The application should display Hello World in the non-production and production URLs.</li></ol>	

Task	Description	Skills required
Use the pipeline.	<ol style="list-style-type: none"> <li>1. Open the CodeCommit repository that you created earlier and open the <code>index.js</code> file.</li> <li>2. Replace <code>Hello World</code> with <code>Hello CI/CD</code>.</li> <li>3. Save and commit the changes to the main branch.</li> <li>4. Verify that the pipeline initiates and that the change goes through the <code>Build</code>, <code>Deploy-NonProd</code>, and <code>Deploy-Prod</code> stages.</li> <li>5. Manually approve the production.</li> <li>6. Both production and non-production URLs should now display <code>Hello CI/CD</code>.</li> </ol>	AWS DevOps, Cloud infrastructure
Repeat this epic for each microservice.	Repeat the tasks in this epic to create a CI/CD pipeline for each of your microservices.	AWS DevOps, Cloud infrastructure

## Related resources

- [Using Python with AWS CDK](#)
- [AWS CDK Python reference](#)
- [Creating an AWS Fargate service using the AWS CDK](#)

## Additional information

### cdk synth command

```
cdk synth --context aws_account=<aws_account_number> --context
aws_region=<aws_region> --context vpc_nonprod_id=<id_of_non_production
VPC> --context vpc_prod_id=<id_of_production_VPC> --context
ecssg_nonprod_id=< default_security_group_id_of_non-production_VPC>
--context ecssg_prod_id=<default_security_group_id_of_production_VPC>
--context code_commit_s3_bucket_for_code=<S3 bucket name> --context
code_commit_s3_object_key_for_code=<Object_key_of_starter_code> --context
microservice_name=<name_of_microservice>
```

### cdk deploy command

```
cdk deploy --context aws_account=<aws_account_number> --context
aws_region=<aws_region> --context vpc_nonprod_id=<id_of_non_production_VPC>
--context vpc_prod_id=<id_of_production_VPC> --context ecssg_nonprod_id=<
default_security_group_id_of_non-production_VPC> --context
ecssg_prod_id=<default_security_group_id_of_production_VPC> --
context code_commit_s3_bucket_for_code=<S3 bucket name> --context
code_commit_s3_object_key_for_code=<Object_key_of_starter_code> --context
microservice_name=<name_of_microservice>
```

## Attachments

To access additional content that is associated with this document, unzip the following file:

[attachment.zip](#)

# Build a loosely coupled architecture with microservices using DevOps practices and AWS Cloud9

Created by Alexandre Nardi (AWS)

**Environment:** PoC or pilot

**Technologies:** DevOps;  
Serverless; Web & mobile  
apps; Databases

**AWS services:** AWS Cloud9;  
AWS CloudFormation; AWS  
CodePipeline; Amazon  
DynamoDB; AWS CodeComm  
it

## Summary

This pattern demonstrates how to develop a typical web application in a serverless architecture, for developers and development leads who are beginning to test DevOps practices on Amazon Web Services (AWS). It builds a sample application that creates a storefront and backend for browsing and purchasing books, and provides a microservice that can be developed independently. The pattern uses AWS Cloud9 as a development environment, an Amazon DynamoDB database as a data store, and AWS services such as AWS CodePipeline and AWS CodeBuild for continuous integration and continuous deployment (CI/CD) functionality.

The pattern guides you through the following development activities:

- Creating a standard AWS Cloud9 development environment
- Using AWS CloudFormation templates to create a web application and a microservice for books
- Using AWS Cloud9 to modify the front-end, commit changes, and test changes
- Creating and testing a CI/CD pipeline to the microservice
- Automating unit tests

The code for this pattern is provided in GitHub, in the [AWS DevOps End-to-End Workshop](#) repository.

## Prerequisites and limitations

### Prerequisites

- An active AWS account
- Files from the [AWS DevOps End-to-End Workshop](#) downloaded to your computer

**Important:** Building this demo application in your AWS account creates and consumes AWS resources. You are responsible for the cost of the AWS services and resources used to create and run the application. After you finish your work, be sure to remove all resources to avoid ongoing charges. For cleanup instructions, see the *Epics* section.

## Limitations

This walkthrough is intended for demonstration and development purposes only. To use it in a production environment, see [Security best practices](#) in the AWS Identity and Access Management (IAM) documentation, and make the necessary changes to IAM roles, Amazon DynamoDB, and other services used. The web application is derived from the [AWS Bookstore Demo App](#); for additional considerations, see the [Known limitations](#) section of the README file.

## Architecture

The architecture of the bookstore application is illustrated in the [Architecture](#) section of the README file for the [AWS Bookstore Demo App](#).

From a deployment perspective, the Bookstore Demo App uses a single CloudFormation template to deploy all services and objects in one stack. This pattern makes a few changes to demonstrate how a particular developer or team could work in a specific product (Books), and update it independently from the rest of the application. For this reason, the code for this pattern separates the AWS Lambda functions and related objects for the Books microservice into a second CloudFormation template, which creates a Books stack. That makes it possible to see the microservice being updated by using CI/CD practices. In the following diagram, the dashed border identifies the Books microservice.

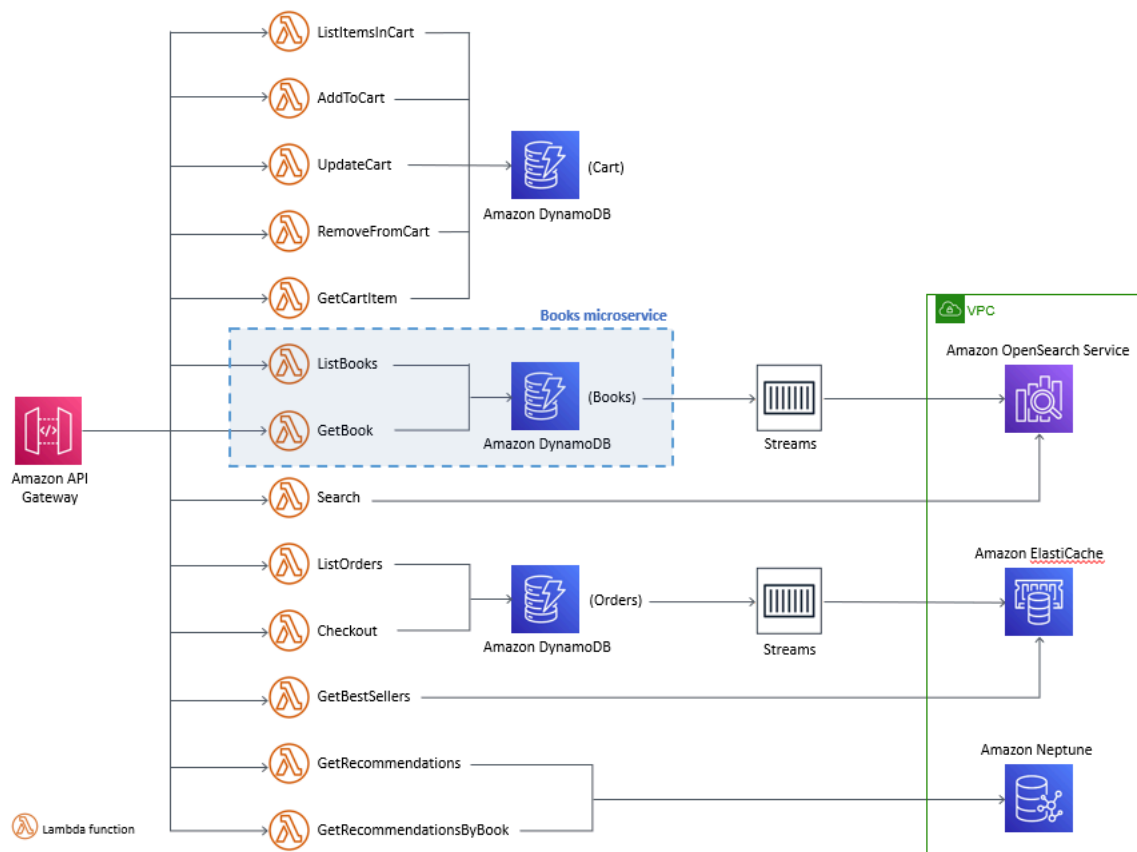

## Tools

### Tools

- Jest framework for JavaScript testing
- Python 3.9

### Code

The source code and templates for this pattern are available on GitHub, in the [AWS DevOps End-to-End Workshop](#) repository. Before you follow the steps in the *Epics* section, download all the files from the repository to your computer.

**Note:** The *Epics* section provides the high-level steps for this walkthrough, to give you general information about the process. To complete each step, see the [README file](#) in the AWS DevOps End-to-End Workshop repository for detailed instructions.



The [AWS DevOps End-to-End Workshop](#) repository extends the [AWS Bookstore Demo App](#) repository and uses a modified version of the [AWS Cloud9 Bootstrapping](#) code to create the AWS Cloud9 IDE.

## Best practices

Using the Bookstore application is straightforward. Here are some recommended best practices:

- When you install the application, you can use a project name of your choice or use the default name (demobookstore) for convenience.
- After you have the application up and running, it's a good practice to shut down the Amazon Neptune database if you want to keep testing for another day, because the database instance could result in additional charges. However, be aware that the database will automatically be started after seven days.
- For code details, see the documentation for the [AWS Bookstore Demo App](#) repository. It describes each microservice and table.
- For additional best practices, see the *Some challenges if you have time...* section of the [README file](#) in the AWS DevOps End-to-End Workshop repository. We recommend that you review the information to dive deep into additional features for security and to practice decoupling services.

## Epics

### Download the source code

Task	Description	Skills required
Download the source code from GitHub.	The source code and templates for this pattern are available in GitHub, in the <a href="#">AWS DevOps End-to-End Workshop</a> repository. Before you follow the next steps in the <i>Epics</i> section, download all the files from the repository to your computer.	App developer

Task	Description	Skills required
	<p><b>Note:</b> The <i>Epics</i> section provides the high-level steps for this walkthrough, to give you general information about the process. To complete each step, see the <a href="#">README file</a> in the AWS DevOps End-to-End Workshop repository for detailed instructions.</p> <p>The <a href="#">AWS DevOps End-to-End Workshop</a> repository extends the <a href="#">AWS Bookstore Demo App</a> repository and uses a modified version of the <a href="#">AWS Cloud9 Bootstrapping</a> code to create the AWS Cloud9 IDE.</p>	

## Build the Bookstore web application and the Books microservice

Task	Description	Skills required
<p>Create the front-end and Lambda functions for the Bookstore app.</p>	<ol style="list-style-type: none"> <li>Log in to the <a href="#">CloudFormation console</a>, and deploy the DemoBookstoreMainTemplate.yml template to create the DemoBookStoreStack stack. This creates the front-end and Lambda functions that are outside the Books microservice.</li> </ol>	<p>Developer</p>

Task	Description	Skills required
	2. In the <b>Outputs</b> tab of the stack, note the website URL under the <b>WebApplication</b> label.	
Create the Books microservice.	On the <a href="#">CloudFormation console</a> , deploy the DemoBookstoreBooksServiceTemplate.yml template to create the DemoBooksServiceStack stack.	Developer
Test your application.	Use the website URL from the DemoBookStoreStack stack to access the Bookstore application.	Developer

## Use the Cloud9 environment to maintain your application

Task	Description	Skills required
Create an AWS Cloud9 IDE.	On the <a href="#">CloudFormation console</a> , deploy the C9EnvironmentTemplate.yml template to create an AWS Cloud9 environment.	Developer, Developer lead
Create CodeCommit repositories.	1. Log in to the <a href="#">AWS CodeCommit console</a> , and verify that you have a demobookstore-WebAssets repository, which contains the code for the front-end application.	Developer

Task	Description	Skills required
	<ol style="list-style-type: none"> <li>2. Create a repository for the Books microservice called <code>demobookstore-BooksService</code> .</li> <li>3. Clone the two repositories in AWS Cloud9 (<code>demobookstore-WebAssets</code> and <code>demobookstore-BooksService</code> ) by using the <code>git clone</code> command.</li> </ol>	
Change the code in the frontend and check the pipeline.	<ol style="list-style-type: none"> <li>1. Use AWS Cloud9 to make some code changes on a webpage. This will update the <code>demobookstore-WebAssets</code> repository.</li> <li>2. On the <a href="#">AWS CodePipeline console</a>, verify that <b>demobookstore-Assets-Pipeline</b> is running.</li> <li>3. Test your web application by refreshing it from the browser (<b>Ctrl+F5</b> on Firefox).</li> </ol>	Developer

## Implement a CI/CD pipeline for the Books microservice

Task	Description	Skills required
Add the YAML files for the build and service update.	<ol style="list-style-type: none"> <li>1. In AWS Cloud9, upload the <code>buildspec.yml</code> and <code>DemoBookstoreBooks</code></li> </ol>	Developer

Task	Description	Skills required
	<p>ServiceUpdateTemplate.yml files.</p> <ul style="list-style-type: none"><li>• buildspec.yml has building instructions, and also includes testing instructions for automated tests. They are commented at this point, and will be used later.</li><li>• DemoBookstoreBooksServiceUpdateTemplate.yml is an updated version of DemoBookstoreBooksServiceTemplate.yml, to be used in the deployment stage of the pipeline.</li></ul> <p>2. Commit and push the files.</p>	

Task	Description	Skills required
Create an S3 bucket for the build pipeline.	<p>To create an S3 bucket, follow the instructions in the <a href="#">Amazon S3 documentation</a>.</p> <ul style="list-style-type: none"><li>The bucket name must be globally unique; for example, demobooks-tore-books-service-pipeline-bucket-YYYYMMDDHHMM .</li><li>Clear the <b>Block all public access</b> check box, and select the <b>I acknowledge...</b> check box.</li></ul>	Developer
Use IAM to create a role for CloudFormation deployment.	Create a demobookstore-CloudFormation-role role and attach the AdministratorAccess policy. In the next epic, you can reconfigure this role for minimum permissions.	Developer
Create a new pipeline to automate building and deploying the Books microservice.	Create a pipeline (for example, <b>demobookstore-BooksService-Pipeline</b> ) with Commit, Build, and Deploy stages, as described in the <a href="#">README file</a> .	Developer
Test your microservice in AWS Cloud9.	Make a change in the <b>ListBooks</b> function and see the pipeline working.	Developer

Task	Description	Skills required
Automate the unit test for the ListBooks Lambda function.	In the AWS Cloud9 IDE, enable the build to run unit tests, and check the test results. For instructions, see the <a href="#">README file</a> .	Developer

### (Optional) Implement additional functionality

Task	Description	Skills required
Make your solution secure.	Configure demobookstore-CloudFormation-role to have minimum permissions, and check other used roles as well.	Developer
Eliminate dependencies in the CloudFormation templates.	The method for exchanging information between the DemoBookstoreMainTemplate.yml template and the DemoBookstoreBooksServiceTemplate.yml template is based on outputs and imports. Passing values between these two templates adds dependencies. To eliminate the dependencies, consider using <a href="#">AWS Systems Manager Parameter Store</a> .	Developer
Create a Cart microservice.	Use the Books microservice as an example for taking shopping cart-rela	Developer

Task	Description	Skills required
	ted functions out of the DemoBookstoreMainTemplate.yml template and creating a Cart microservice.	

## Clean up

Task	Description	Skills required
Delete the S3 buckets.	<p>On the <a href="#">Amazon S3 console</a>, delete the following buckets that are associated with the sample web application:</p> <ul style="list-style-type: none"> <li>Two buckets created for the AWS Bookstore Demo App. The buckets names start with the stack name you provided for AWS CloudFormation when you created the frontend; for example, <b>DemoBookstoreStack</b>.</li> <li>One bucket for the build pipeline; for example, <b>demobookstore-books-service-pipeline-bucket-<code>&lt;YYYYMMDDHHMM&gt;</code></b>.</li> </ul>	Developer
Delete the stacks.	On the <a href="#">CloudFormation console</a> , delete the stacks associated with the sample web applicaton:	Developer



Task	Description	Skills required
	<ul style="list-style-type: none"> <li>• DemoBooksServiceStack</li> <li>• DemoBookStoreStack</li> </ul> <p>The removal could take more than 90 minutes. If the removal fails, delete them again, and also delete any manual resources (for example, the VPC or network interfaces) based on notifications.</p>	
Delete the IAM roles.	<p>On the <a href="#">IAM console</a>, delete the following roles:</p> <ul style="list-style-type: none"> <li>• demobookstore-Cloudformation-role</li> <li>• demobookstore-BooksService-BuildProject-service-role</li> </ul> <p>For step-by-step instructions, see the <a href="#">IAM documentation</a>.</p>	Developer

## Related resources

- [AWS Bookstore Demo App](#)
- [AWS Cloud9 Bootstrapping example](#)
- [Creating a stack on the AWS CloudFormation console](#) (AWS CloudFormation documentation)
- [Creating a bucket](#) (Amazon S3 documentation)

## Additional information

For detailed, step-by-step instructions, see the [README file](#) in the [AWS DevOps End-to-End Workshop](#) GitHub repository.

**About the May 2023 update:** This pattern was updated to use newer versions of Node and Python. We updated many of the packages in the source code and removed Glyphicon because it's no longer free. We also removed all dependencies on the [AWS Bookstore Demo App](#) repository, so the two repositories can now evolve independently.

# Build and push Docker images to Amazon ECR using GitHub Actions and Terraform

Created by Ruchika Modi (AWS)

<b>Code repository:</b> <a href="#">docker-ecr-actions-workflow</a>	<b>Environment:</b> Production	<b>Technologies:</b> DevOps; Containers & microservices; Infrastructure
<b>Workload:</b> All other workloads	<b>AWS services:</b> Amazon ECR	

## Summary

This pattern explains how you can create reusable GitHub workflows to build your Dockerfile and push the resulting image to Amazon Elastic Container Registry (Amazon ECR). The pattern automates the build process of your Dockerfiles by using Terraform and GitHub Actions. This minimizes the possibility of human error and substantially reduces deployment time.

A GitHub push action to the main branch of your GitHub repository initiates the deployment of resources. The workflow creates a unique Amazon ECR repository based on the combination of the GitHub organization and repository name. It then pushes the Dockerfile image to the Amazon ECR repository.

## Prerequisites and limitations

### Prerequisites

- An active AWS account.
- An active GitHub account.
- A [GitHub repository](#).
- Terraform version 1 or later [installed and configured](#).
- An Amazon Simple Storage Service (Amazon S3) bucket for the [Terraform backend](#).

- An [Amazon DynamoDB](#) table for Terraform state locking and consistency. The table must have a partition key named `LockID` with a type of `String`. If this isn't configured, state locking will be disabled.
- An AWS Identity and Access Management (IAM) role that has permissions to set up the Amazon S3 backend for Terraform. For configuration instructions, see the [Terraform documentation](#).

## Limitations

This reusable code has been tested only with GitHub Actions.

## Architecture

### Target technology stack

- Amazon ECR repository
- GitHub Actions
- Terraform

### Target architecture

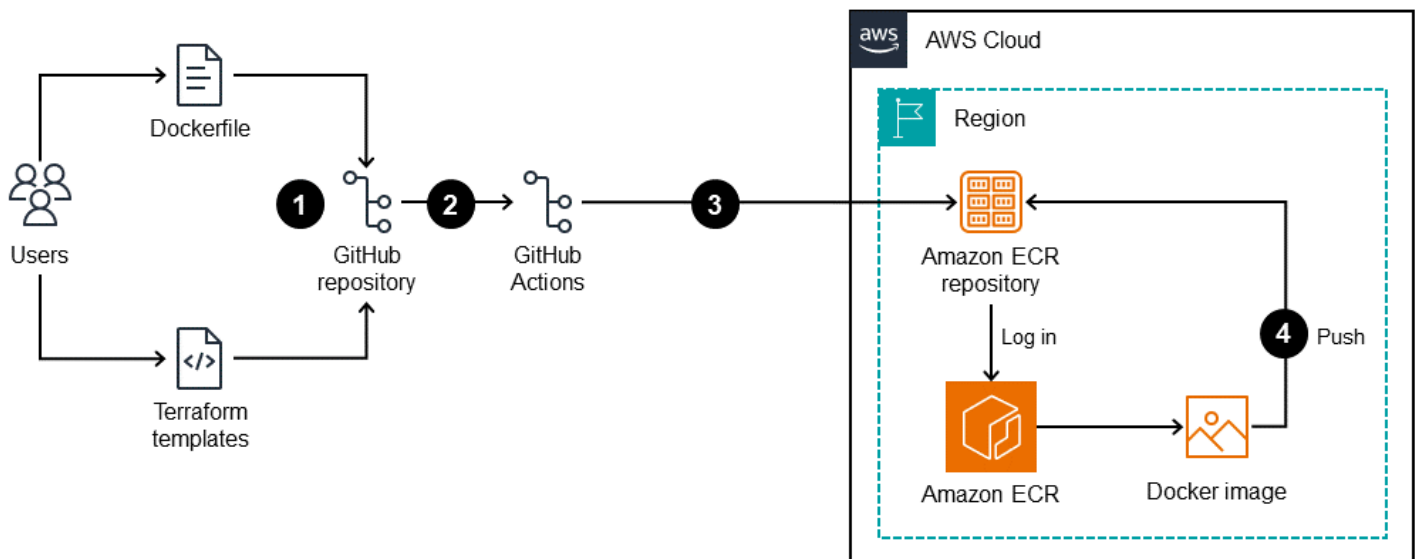

The diagram illustrates the following:

1. A user adds a Dockerfile and Terraform templates to the GitHub repository.

2. These additions initiate a GitHub Actions workflow.
3. The workflow checks whether an Amazon ECR repository exists. If not, it creates the repository based on the GitHub organization and repository name.
4. The workflow builds the Dockerfile and pushes the image to the Amazon ECR repository.

## Tools

### Amazon services

- [Amazon Elastic Container Registry \(Amazon ECR\)](#) is a managed container registry service that's secure, scalable, and reliable.

### Other tools

- [GitHub Actions](#) is integrated into the GitHub platform to help you create, share, and run workflows within your GitHub repositories. You can use GitHub Actions to automate tasks such as building, testing, and deploying your code.
- [Terraform](#) is an open source infrastructure as code (IaC) tool from HashiCorp that helps you create and manage cloud and on-premises infrastructure.

### Code repository

The code for this pattern is available in the GitHub [Docker ECR Actions Workflow](#) repository.

- When you create GitHub Actions, Docker workflow files are saved in the `/.github/workflows/` folder of this repository. The workflow for this solution is in the [workflow.yaml](#) file.
- The `e2e-test` folder provides a sample Dockerfile for reference and testing.

## Best practices

- For best practices for writing Dockerfiles, see the [Docker documentation](#).
- Use a [VPC endpoint for Amazon ECR](#). VPC endpoints are powered by AWS PrivateLink, a technology that enables you to privately access Amazon ECR APIs through private IP addresses. For Amazon ECS tasks that use the Fargate launch type, the VPC endpoint enables the task to pull private images from Amazon ECR without assigning a public IP address to the task.

## Epics

### Set up the OIDC provider and GitHub repository

Task	Description	Skills required
Configure OpenID Connect.	Create an OpenID Connect (OIDC) provider. You will use the provider in the trust policy for the IAM role used in this action. For instructions, see <a href="#">Configuring OpenID Connect in Amazon Web Services</a> in the GitHub documentation.	AWS administrator, AWS DevOps, General AWS
Clone the GitHub repository.	Clone the GitHub <a href="#">Docker ECR Actions Workflow</a> repository into your local folder: <div style="border: 1px solid #ccc; border-radius: 10px; padding: 10px; margin-top: 10px;"> <pre>\$git clone https://github.com/aws-samples/docker-ecr-actions-workflow</pre> </div>	DevOps engineer

### Customize the GitHub reusable workflow and deploy the Docker image

Task	Description	Skills required
Customize the event that initiates the Docker workflow.	The workflow for this solution is in <a href="#">workflow.yaml</a> . This script is currently configured to deploy resources when it receives the <code>workflow_dispatch</code> event. You can customize this configuration by changing the event to	DevOps engineer

Task	Description	Skills required
	workflow_call and calling the workflow from another parent workflow.	

Task	Description	Skills required
Customize the workflow.	<p>The <a href="#">workflow.yaml</a> file is configured to create a dynamic, reusable GitHub workflow. You can edit this file to customize the default configuration, or you can pass the input values from the GitHub Actions console if you're using the <code>workflow_dispatch</code> event to initiate deployment manually.</p> <ul style="list-style-type: none"><li>• Make sure to specify the correct AWS account ID and target Region.</li><li>• Create an Amazon ECR lifecycle policy (see <a href="#">sample policy</a>) and update the default path (<code>e2e-test/policy.json</code>) accordingly.</li><li>• The workflow file requires two IAM roles as input:<ul style="list-style-type: none"><li>• An IAM role that has permissions to set up the Amazon S3 backend for Terraform (see the <a href="#">Prerequisites</a> section). You can update the default role name <code>workload-assumable-role</code> in the <code>.yaml</code> file accordingly.</li></ul></li></ul>	DevOps engineer



Task	Description	Skills required
	<ul style="list-style-type: none"> <li>An IAM role that has permissions to access GitHub. This role is also used in the Amazon ECR policy to restrict Amazon ECR operations. For more information, see the <a href="#">data.tf file</a>.</li> </ul>	
Deploy the Terraform templates.	The workflow automatically deploys the Terraform templates that create the Amazon ECR repository, based on the GitHub event you configured. These templates are available as .tf files at the <a href="#">root of the Github repository</a> .	AWS DevOps, DevOps engineer

## Troubleshooting

Issue	Solution
Issues or errors when you configure Amazon S3 and DynamoDB as the Terraform remote backend.	Follow the instructions in the <a href="#">Terraform documentation</a> to set up the required permissions on the Amazon S3 and DynamoDB resources for the remote backend configuration.
Unable to run or start the workflow with the <code>workflow_dispatch</code> event.	The workflow that's configured to deploy from the <code>workflow_dispatch</code> event will work only if the workflow is configured on the main branch as well.

## Related resources

- [Reusing workflows](#) (GitHub documentation)
- [Triggering a workflow](#) (GitHub documentation)

# Build and test iOS apps with AWS CodeCommit, AWS CodePipeline, and AWS Device Farm

Created by Abdullahi Olaoye (AWS)

<b>R Type:</b> N/A	<b>Source:</b> On-premises DevOps processes	<b>Target:</b> CI/CD pipeline for iOS apps development on AWS
<b>Created by:</b> AWS	<b>Environment:</b> PoC or pilot	<b>Technologies:</b> Web & mobile apps; DevOps
<b>AWS services:</b> AWS CodeCommit; AWS CodePipeline; AWS Device Farm		

## Summary

This pattern outlines the steps for creating a continuous integration and continuous delivery (CI/CD) pipeline that uses AWS CodePipeline to build and test iOS applications on real devices on AWS. The pattern uses AWS CodeCommit to store the application code, the Jenkins open-source tool to build the iOS application, and AWS Device Farm to test the built application on real devices. These three phases are orchestrated together in a pipeline by using AWS CodePipeline.

This pattern is based on the post [Building and testing iOS and iPadOS apps with AWS DevOps and mobile services](#) on the AWS DevOps blog. For detailed instructions, see the blog post.

## Prerequisites and limitations

### Prerequisites

- An active AWS account
- An Apple developer account
- Build server (macOS)
- [Xcode](#) version 11.3 (installed and set up on the build server)

- AWS Command Line Interface (AWS CLI) [installed](#) and [configured](#) on the workstation
- Basic knowledge of [Git](#)

## Limitations

- The application build server must be running macOS.
- The build server must have a public IP address, so CodePipeline can connect to it remotely to initiate builds.

## Architecture

### Source technology stack

- An on-premises iOS application build process that involves using a simulator or manual test on physical devices

### Target technology stack

- An AWS CodeCommit repository for storing application source code
- A Jenkins server for application builds using Xcode
- An AWS Device Farm device pool for testing applications on real devices

### Target architecture

When a user commits changes to the source repository, the pipeline (AWS CodePipeline) fetches the code from the source repository, initiates a Jenkins build, and passes the application code to Jenkins. After the build, the pipeline retrieves the build artifact and starts an AWS Device Farm job to test the application against a device pool.

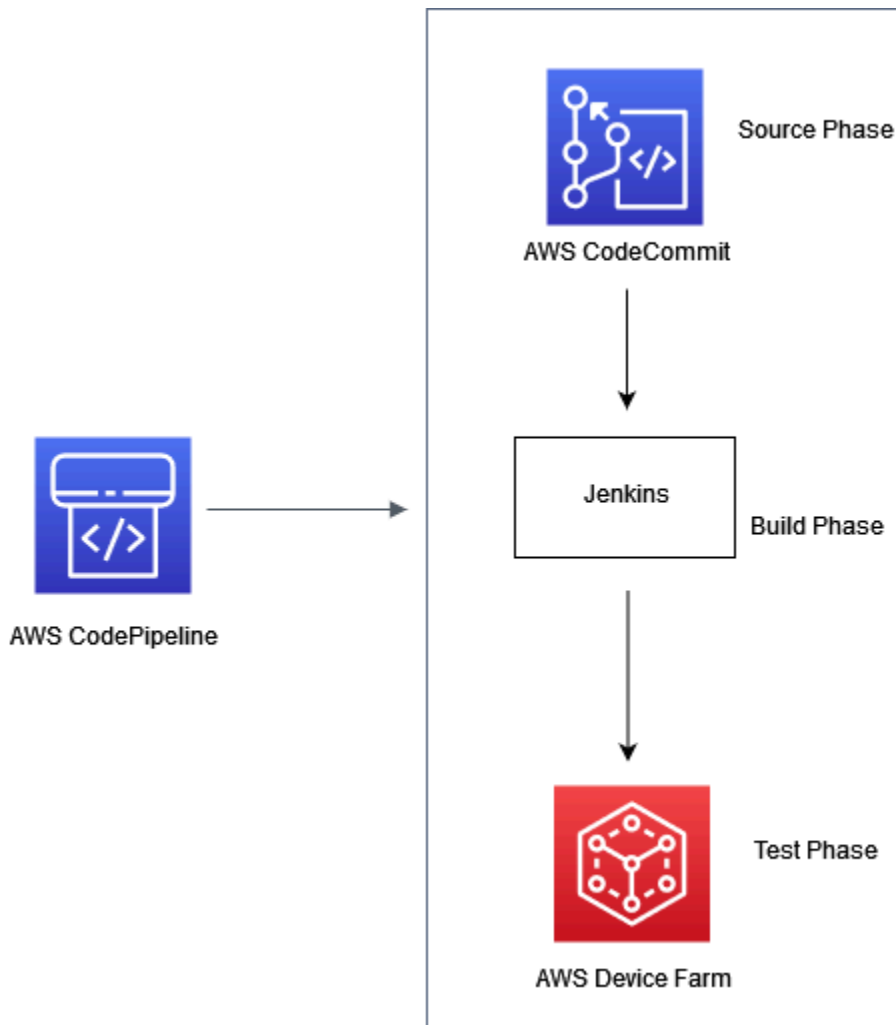

## Tools

- [AWS CodePipeline](#) is a fully managed continuous delivery service that helps you automate your release pipelines for fast and reliable application and infrastructure updates. CodePipeline automates the build, test, and deploy phases of your release process every time there is a code change, based on the release model you define.
- [AWS CodeCommit](#) is a fully managed source control service that hosts secure Git-based repositories. It makes it easy for teams to collaborate on code in a secure and highly scalable ecosystem. CodeCommit eliminates the need to operate your own source control system or worry about scaling its infrastructure.
- [AWS Device Farm](#) is an application testing service that lets you improve the quality of your web and mobile apps by testing them across an extensive range of desktop browsers and real mobile devices, without having to provision and manage any testing infrastructure.

- [Jenkins](#) is an open-source automation server that enables developers to build, test, and deploy their software.

## Epics

### Set up the build environment

Task	Description	Skills required
Install Jenkins on the build server that's running macOS.	Jenkins will be used for building the application, so you must first install it on the build server. To get detailed instructions for this and subsequent tasks, see the AWS blog post <a href="#">Building and testing iOS and iPadOS apps with AWS DevOps and mobile services</a> and other resources in the <a href="#">Related resources</a> section at the end of this pattern.	DevOps
Configure Jenkins.	Follow the on-screen instructions to configure Jenkins.	DevOps
Install the AWS CodePipeline plugin for Jenkins.	This plugin must be installed on the Jenkins server in order for Jenkins to interact with the AWS CodePipeline service.	DevOps
Create a Jenkins freestyle project.	In Jenkins, create a freestyle project. Configure the project to specify triggers and other build configuration options.	DevOps

## Configure AWS Device Farm

Task	Description	Skills required
Create a Device Farm project.	Open the AWS Device Farm console. Create a project and a device pool for testing. For instructions, see the blog post.	Developer

## Configure the source repository

Task	Description	Skills required
Create a CodeCommit repository.	Create a repository where the source code will be stored.	DevOps
Commit your application code to the repository.	Connect to the CodeCommit repository you created. Push the code from your local machine to the repository.	DevOps

## Configure the pipeline

Task	Description	Skills required
Create a pipeline in AWS CodePipeline.	Open the AWS CodePipeline console, and create a pipeline. The pipeline orchestrates all the phases of the CI/CD process. For instructions, see the AWS blog post <a href="#">Building and testing iOS and iPadOS apps with AWS DevOps and mobile services</a> .	DevOps

Task	Description	Skills required
Add a test stage to the pipeline.	To add a test stage and integrate it with AWS Device Farm, edit the pipeline.	DevOps
Initiate the pipeline.	To start the pipeline and the CI/CD process, choose <b>Release change</b> .	DevOps

## View application test results

Task	Description	Skills required
Review test results.	In the AWS Device Farm console, select the project you created, and review the results of the tests. The console will show the details of each test.	Developer

## Related resources

### Step-by-step instructions for this pattern

- [Building and testing iOS and iPadOS apps with AWS DevOps and mobile services](#) (AWS DevOps blog post)

### Configure AWS Device Farm

- [AWS Device Farm console](#)

### Configure the source repository

- [Create an AWS CodeCommit repository](#)
- [Connect to an AWS CodeCommit repository](#)



## Configure the pipeline

- [AWS CodePipeline console](#)

## Additional resources

- [AWS CodePipeline documentation](#)
- [AWS CodeCommit documentation](#)
- [AWS Device Farm documentation](#)
- [Jenkins documentation](#)
- [Jenkins installation on macOS](#)
- [AWS CodePipeline plugin for Jenkins](#)
- [Xcode installation](#)
- AWS CLI [Installation](#) and [configuration](#)
- [Git documentation](#)

# Check AWS CDK applications or CloudFormation templates for best practices by using cdk-nag rule packs

Created by Arun Donti

**Environment:** Production

**Technologies:** DevOps;  
Security, identity, compliance

**Workload:** Open-source

**AWS services:** AWS CDK

## Summary

This pattern explains how you can use the [cdk-nag](#) utility to check [AWS Cloud Development Kit \(AWS CDK\)](#) applications for best practices by using a combination of rule packs. **cdk-nag** is an open-source project that was inspired by [cfn\\_nag](#). It implements rules in evaluation packs such as AWS Solutions Library, Health Insurance Portability and Accountability Act (HIPAA), and National Institute of Standards and Technology (NIST) 800-53 by using [AWS CDK Aspects](#). You can check your AWS CDK applications for best practices by using the rules in these packs, detect and remediate code based on best practices, and suppress the rules that you don't want to use in your evaluations.

You can also use **cdk-nag** to check your AWS CloudFormation templates by using the [cloudformation-include](#) module.

For information about all available packs, see the [Rules](#) section of the [cdk-nag](#) repository. Evaluation packs are available for:

- [AWS Solutions Library](#)
- [HIPAA security](#)
- [NIST 800-53 rev 4](#)
- [NIST 800-53 rev 5](#)
- [Payment Card Industry Data Security Standard \(PCI DSS\) 3.2.1](#)

## Prerequisites and limitations

### Prerequisites

- An application that uses the [AWS CDK](#)

### Tools

- [AWS CDK](#) – Cloud Development Kit (AWS CDK) is a software development framework for defining cloud infrastructure in code and provisioning it through AWS CloudFormation.
- [AWS CloudFormation](#) – AWS CloudFormation helps you model and set up your AWS resources, provision them quickly and consistently, and manage them throughout their lifecycle. You can use a template to describe your resources and their dependencies, and you can launch and configure them together as a stack, instead of managing resources individually. You can manage and provision stacks across multiple AWS accounts and AWS Regions.

### Epics

#### Integrate cdk-nag with your AWS CDK application

Task	Description	Skills required
Learn about cdk-nag.	Navigate to the <a href="#">cdk-nag</a> GitHub repository and read through the documentation.	App developer
Install the cdk-nag package in your AWS CDK application.	To use <b>cdk-nag</b> in your AWS CDK application, you must install it first. <b>cdk-nag</b> is available to download from PyPI, npm, NuGet, and Apache Maven. For the latest information about available versions and download locations, see the <a href="#">Readme file</a> in the repository.	App developer

Task	Description	Skills required
Choose your NagPacks.	<p><b>cdk-nag</b> has different packs of rules called <i>NagPacks</i>. Each NagPack contains rules that conform to a specific standard. For example, the AWS Solutions NagPack contains general best practices, and the NIST 800-53 rev 5 NagPack can help with compliance. You can apply multiple NagPacks to your application, and you can add and remove packs as necessary. For a list of available packs, see the <a href="#">Readme file</a> in the GitHub repository. For information about the individual rules in each pack, see the <a href="#">Rules section</a> of the GitHub repository.</p>	App developer

Task	Description	Skills required
Integrate cdk-nag into your AWS CDK application.	<p>You can integrate <b>cdk-nag</b> into your application on an applicationwide level, or integrate it into individual stages or stacks in your application. For example, to integrate the AWS Solutions and HIPAA security NagPacks into an AWS CDK v2 TypeScript application on an applicationwide level, you can use the following code:</p> <pre data-bbox="597 871 1026 1864">import { App, Aspects }   from 'aws-cdk-lib'; import { CdkTestStack } from '../lib/cdk-test-stack'; import { AwsSolutionsChecks, HIPAASecurityChecks } from   'cdk-nag';  const app = new App(); new CdkTestStack(app,   'CdkNagDemo'); // Simple rule informational messages Aspects.of(app).add(new AwsSolutionsChecks()); // Additional explanations on the purpose of triggered rules Aspects.of(app).add(new HIPAASecurityChecks({ verbose: true }));</pre>	App developer

## Related resources

- [cdk-nag code repository](#)
- [cdk-nag in Construct Hub](#)

# Configure mutual TLS authentication for applications running on Amazon EKS

*Created by Mahendra Siddappa (AWS)*

**Environment:** PoC or pilot

**Technologies:** DevOps;  
Security, identity, compliance

**AWS services:** Amazon EKS;  
Amazon Route 53

## Summary

Certificate-based mutual Transport Layer Security (TLS) is an optional TLS component that provides two-way peer authentication between servers and clients. With mutual TLS, clients must provide an X.509 certificate during the session negotiation process. The server uses this certificate to identify and authenticate the client.

Mutual TLS is a common requirement for Internet of Things (IoT) applications and can be used for business-to-business applications or standards such as [Open Banking](#).

This pattern describes how to configure mutual TLS for applications running on an Amazon Elastic Kubernetes Service (Amazon EKS) cluster by using an NGINX ingress controller. You can enable built-in mutual TLS features for the NGINX ingress controller by annotating the ingress resource. For more information about mutual TLS annotations on NGINX controllers, see [Client certificate authentication](#) in the Kubernetes documentation.

**Important:** This pattern uses self-signed certificates. We recommend that you use this pattern only with test clusters, and not in production environments. If you want to use this pattern in a production environment, you can use [AWS Private Certificate Authority \(AWS Private CA\)](#) or your existing public key infrastructure (PKI) standard to issue private certificates.

## Prerequisites and limitations

### Prerequisites

- An active Amazon Web Services (AWS) account.
- An existing Amazon EKS cluster.

- AWS Command Line Interface (AWS CLI) version 1.7 or later, installed and configured on macOS, Linux, or Windows.
- The kubectl command line utility, installed and configured to access the Amazon EKS cluster. For more information about this, see [Installing kubectl](#) in the Amazon EKS documentation.
- An existing Domain Name System (DNS) name to test the application.

## Limitations

- This pattern uses self-signed certificates. We recommend that you use this pattern only with test clusters, and not in production environments.

## Architecture

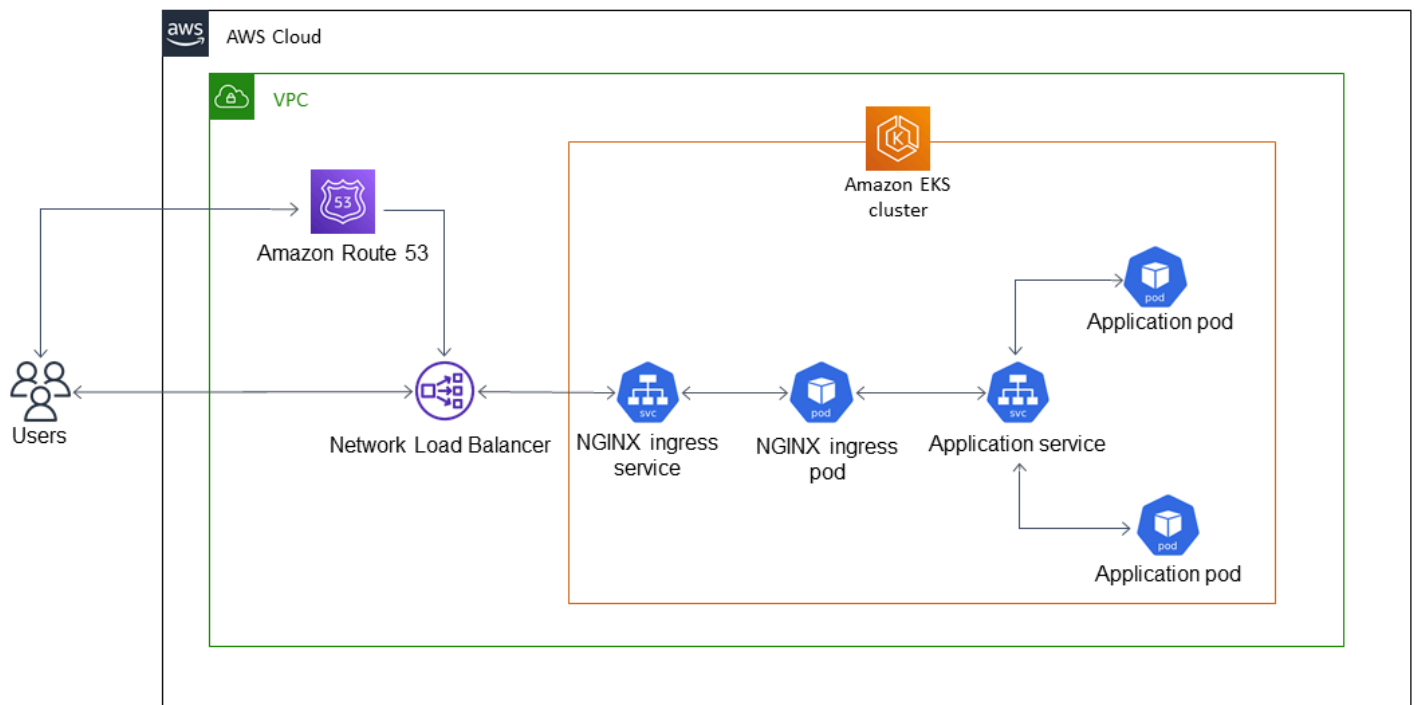

## Technology stack

- Amazon EKS
- Amazon Route 53
- Kubectl



## Tools

- [Amazon Elastic Kubernetes Service \(Amazon EKS\)](#) helps you run Kubernetes on AWS without needing to install or maintain your own Kubernetes control plane or nodes.
- [Amazon Route 53](#) is a highly available and scalable DNS web service.
- [Kubectrl](#) is a command line utility that you use to interact with an Amazon EKS cluster.

## Epics

### Generate the self-signed certificates

Task	Description	Skills required
Generate the CA key and certificate.	Generate the certificate authority (CA) key and certificate by running the following command. <pre>openssl req -x509 -sha256 -newkey rsa:4096 -keyout ca.key -out ca.crt -days 356 -nodes -subj '/CN=Test Cert Authority'</pre>	DevOps engineer
Generate the server key and certificate, and sign with the CA certificate.	Generate the server key and certificate, and sign with the CA certificate by running the following command. <pre>openssl req -new -newkey rsa:4096 -keyout server.key -out server.csr -nodes -subj '/CN= &lt;your_domain_name&gt;' &amp;&amp; openssl x509 -req -sha256 -days 365 -in server.csr -</pre>	DevOps engineer

Task	Description	Skills required
<p>Generate the client key and certificate, and sign with the CA certificate.</p>	<pre data-bbox="594 205 1024 346">CA ca.crt -CAkey ca.key -set_serial 01 -out server.crt</pre> <p data-bbox="594 384 1024 562"><b>Important:</b> Make sure sure that you replace &lt;your_domain_name&gt; with your existing domain name.</p> <pre data-bbox="594 821 1024 1262">openssl req -new - newkey rsa:4096 - keyout client.key - out client.csr -nodes -subj '/CN=Test' &amp;&amp; openssl x509 -req - sha256 -days 365 -in client.csr -CA ca.crt -CAkey ca.key -set_seri al 02 -out client.crt</pre>	<p>DevOps engineer</p>

## Deploy the NGINX ingress controller

Task	Description	Skills required
<p>Deploy the NGINX ingress controller in your Amazon EKS cluster.</p>	<p>Deploy the NGINX ingress controller by using the following command.</p> <pre data-bbox="594 1709 1024 1879">kubectl apply -f https://raw.github usercontent.com/ku bernetes/ingress-n</pre>	<p>DevOps engineer</p>

Task	Description	Skills required
	<pre>ginx/controller-v1 .7.0/deploy/static /provider/aws/depl oy.yaml</pre>	
Verify that the NGINX ingress controller service is running.	<p>Verify that the NGINX ingress controller service is running by using the following command.</p> <pre>kubectl get svc -n ingress-nginx</pre> <p><b>Important:</b> Make sure that the field of service address contains the Network Load Balancer's domain name.</p>	DevOps engineer

### Create a namespace in the Amazon EKS cluster to test mutual TLS

Task	Description	Skills required
Create a namespace in the Amazon EKS cluster.	<p>Create a namespace called <code>mtls</code> in your Amazon EKS cluster by running the following command.</p> <pre>kubectl create ns mtls</pre> <p>This deploys the sample application to test mutual TLS.</p>	DevOps engineer

## Create the deployment and service for the sample application

Task	Description	Skills required
Create the Kubernetes deployment and service in the mtls namespace.	<p>Create a file named <code>mtls.yaml</code> . Paste the following code into the file.</p> <pre>kind: Deployment apiVersion: apps/v1 metadata:   name: mtls-app   labels:     app: mtls spec:   replicas: 1   selector:     matchLabels:       app: mtls   template:     metadata:       labels:         app: mtls     spec:       containers:       - name: mtls-app         image: hashicorp/http-echo         args:           - "-text=mTLS             is working"  ---  kind: Service apiVersion: v1 metadata:   name: mtls-service spec:   selector:     app: mtls</pre>	DevOps engineer

Task	Description	Skills required
	<pre>ports:   - port: 5678 #     Default port for image</pre> <p>Create the Kubernetes deployment and service in the <code>mtls</code> namespace by running the following command.</p> <pre>kubectl create -f   mtls.yaml -n mtls</pre>	
Verify that the Kubernetes deployment is created.	<p>Run the following command to verify that the deployment is created and has one pod in available status.</p> <pre>kubectl get deploy -n   mtls</pre>	DevOps engineer
Verify that the Kubernetes service is created.	<p>Verify that the Kubernetes service is created by running the following command.</p> <pre>kubectl get service -n   mtls</pre>	DevOps engineer

### Create a secret in the `mtls` namespace

Task	Description	Skills required
Create a secret for the ingress resource.	Run the following command to create a secret for the NGINX ingress controller by	DevOps engineer

Task	Description	Skills required
	<p>using the certificates that you created earlier.</p> <pre data-bbox="594 331 1029 646">kubect1 create secret   generic mtls-certs   --from-file=tls.cr t=server.crt --from- file=tls.key=server. key --from-file=ca.crt =ca.crt -n mtl</pre> <p>Your secret has a server certificate for the client to identify the server and a CA certificate for the server to verify the client certificates.</p>	

### Create the ingress resource in the mtl namespace

Task	Description	Skills required
<p>Create the ingress resource in the mtl namespace.</p>	<p>Create a file named <code>ingress.yaml</code> . Paste the following code into the file (replace <code>&lt;your_domain_name&gt;</code> with your existing domain name).</p> <pre data-bbox="594 1520 1029 1850">apiVersion: networkin g.k8s.io/v1 kind: Ingress metadata:   annotations:     nginx.ingress.kube rnetes.io/auth-tls- verify-client: "on"</pre>	<p>DevOps engineer</p>

Task	Description	Skills required
	<pre>    nginx.ingress.kube netes.io/auth-tls- secret: mtls/mtls-certs   name: mtls-ingress spec:   ingressClassName:   nginx   rules:   - host: ".*.&lt;your_ domain_name&gt;"     http:       paths:       - path: /         pathType: Prefix         backend:           service:             name: mtl- service             port:               number: 2678           tls:             - hosts:               - ".*.&lt;your_ domain_name&gt;"               secretName: mtl- certs</pre> <p>Create the ingress resource in the mtl namespace by running the following command.</p> <pre>kubectl create -f ingress.yaml -n mtl</pre> <p>This means that the NGINX ingress controller can route</p>	

Task	Description	Skills required
	<p>traffic to your sample application.</p>	
Verify that the ingress resource is created.	<p>Verify that the ingress resource is created by running the following command.</p> <pre>kubectl get ing -n mtls</pre> <p><b>Important:</b> Make sure that the address of the ingress resource shows the load balancer created for the NGINX ingress controller.</p>	DevOps engineer

### Configure DNS to point the hostname to the load balancer

Task	Description	Skills required
Create CNAME record that points to the load balancer for the NGINX ingress controller.	<p>Sign in to the AWS Management Console, open the Amazon Route 53 console, and create a Canonical Name (CNAME) record that points <code>mtls.&lt;your_domain_name&gt;</code> to the load balancer for the NGINX ingress controller.</p> <p>For more information, see <a href="#">Creating records by using the Route 53 console</a> in the Route 53 documentation.</p>	DevOps engineer



## Test the application

Task	Description	Skills required
Test mutual TLS setup without certificates.	<p>Run the following command.</p> <pre>curl -k https://m tls.&lt;your_domain_n ame&gt;</pre> <p>You should receive the "400 No required SSL certificate was sent" error response.</p>	DevOps engineer
Test mutual TLS setup with certificates.	<p>Run the following command.</p> <pre>curl -k https://m tls.&lt;your_domain_n ame&gt; --cert client.crt --key client.key</pre> <p>You should receive the "mTLS is working" response.</p>	DevOps engineer

## Related resources

- [Creating records by using the Amazon Route 53 console](#)
- [Using a Network Load Balancer with the NGINX ingress controller on Amazon EKS](#)
- [Client Certificate Authentication](#)

# Create a custom log parser for Amazon ECS using a Firelens log router

Created by Varun Sharma (AWS)

**Environment:** Production

**Technologies:** DevOps;  
Containers & microservices

**Workload:** All other  
workloads

**AWS services:** Amazon ECS

## Summary

Firelens is a log router for Amazon Elastic Container Service (Amazon ECS) and AWS Fargate. You can use Firelens to route container logs from Amazon ECS to Amazon CloudWatch and other destinations (for example, [Splunk](#) or [Sumo Logic](#)). Firelens works with [Fluentd](#) or [Fluent Bit](#) as the logging agent, which means that you can use [Amazon ECS task definition parameters](#) to route logs.

By choosing to parse logs at the source level, you can analyze your logging data and perform queries to more efficiently and effectively respond to operational issues. Because different applications have different logging patterns, you need to use a custom parser that structures the logs and makes searching easier at your end destination.

This pattern uses a Firelens log router with a custom parser to push logs to CloudWatch from a sample Spring Boot application running on Amazon ECS. You can then use Amazon CloudWatch Logs Insights to filter the logs based on custom fields that are generated by the custom parser.

## Prerequisites and limitations

### Prerequisites

- An active Amazon Web Services (AWS) account.
- AWS Command Line Interface (AWS CLI), installed and configured on your local machine.
- Docker, installed and configured on your local machine.
- An existing Spring Boot-based containerized application on Amazon Elastic Container Registry (Amazon ECR).

# Architecture

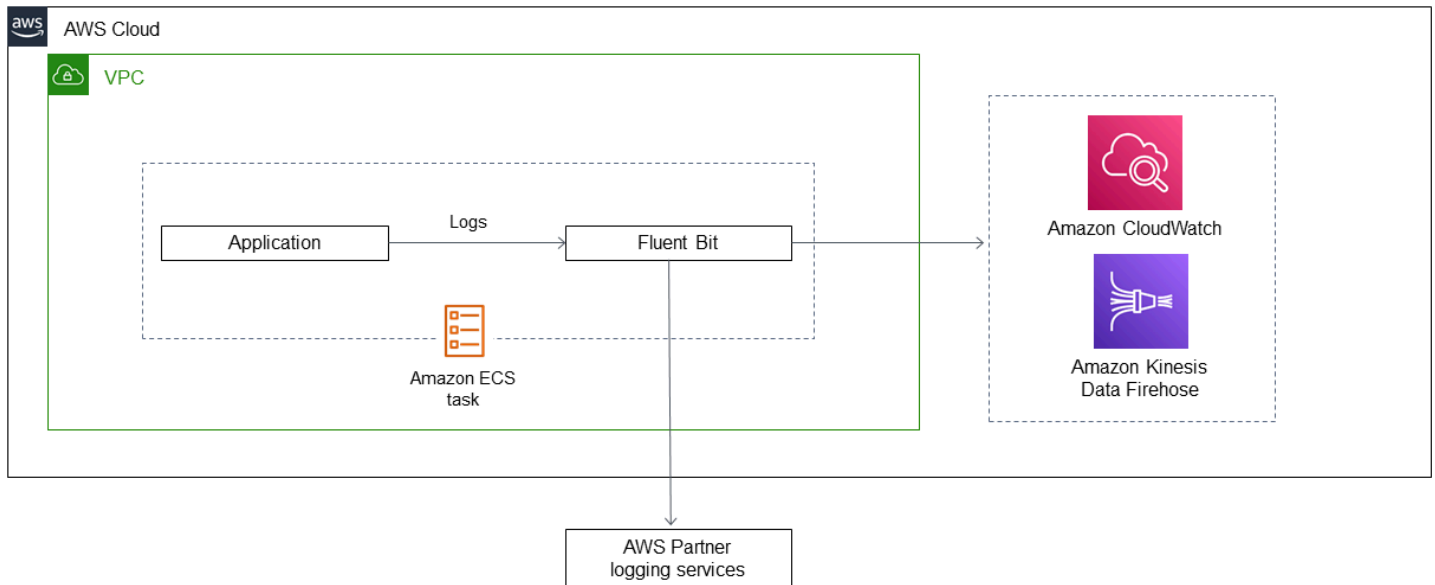

## Technology stack

- CloudWatch
- Amazon ECR
- Amazon ECS
- Fargate
- Docker
- Fluent Bit

## Tools

- [Amazon ECR](#) – Amazon Elastic Container Registry (Amazon ECR) is an AWS managed container image registry service that is secure, scalable, and reliable.
- [Amazon ECS](#) – Amazon Elastic Container Service (Amazon ECS) is a highly scalable, fast container management service that makes it easy to run, stop, and manage containers on a cluster.
- [AWS Identity and Access Management \(IAM\)](#) – IAM is a web service for securely controlling access to AWS services.
- [AWS CLI](#) – AWS Command Line Interface (AWS CLI) is an open-source tool that enables you to interact with AWS services using commands in your command-line shell.

- [Docker](#) – Docker is an open platform for developing, shipping, and running applications.

## Code

The following files are attached to this pattern:

- `customFluentBit.zip` – Contains the files to add the custom parsing and configurations.
- `firelens_policy.json` – Contains the policy document to create an IAM policy.
- `Task.json` – Contains a sample task definition for Amazon ECS.

## Epics

### Create a custom Fluent Bit image

Task	Description	Skills required
Create an Amazon ECR repository.	<p>Sign in to the AWS Management Console, open the Amazon ECR console, and create a repository called <code>fluentbit_custom</code> .</p> <p>For more information about this, see <a href="#">Creating a repository</a> in the Amazon ECR documentation.</p>	Systems administrator, Developer
Unzip the <code>customFluentBit.zip</code> package.	<ol style="list-style-type: none"> <li>1. Download the <code>customFluentBit.zip</code> package (attached) to your local machine.</li> <li>2. Unzip to the <code>customFluentBit</code> directory by running the following command: <code>unzip -d</code></li> </ol>	

Task	Description	Skills required
	<p>customFluentBit.zip</p> <p>3. The directory contains the following files that are required for adding the custom parsing and configurations:</p> <ul style="list-style-type: none"><li>• parsers/springboot_parser.conf – Contains the parser directive and defines the regular expression (regex) pattern for the custom parser. You can add the regex pattern for your specific parser.</li><li>• conf/pars_e_springboot.conf – Contains the filter and the service directive.</li><li>• The Dockerfile</li></ul>	

Task	Description	Skills required
Create the custom Docker image.	<ol style="list-style-type: none"><li>1. Change the directory to <code>customFluentBit</code> .</li><li>2. Open the Amazon ECR console, choose the <code>fluentbit_custom</code> repository, and then choose <b>View push commands</b>.</li><li>3. Upload your project.</li><li>4. After the upload is complete, copy the build's URL. This URL is required when you create a container in Amazon ECS</li></ol> <p>For more information about this, see <a href="#">Pushing a Docker image</a> in the Amazon ECR documentation.</p>	Systems administrator, Developer

## Set up the Amazon ECS cluster

Task	Description	Skills required
Create an Amazon ECS cluster.	<p>Create an Amazon ECS cluster by following the instructions from the <i>Networking only template</i> section of <a href="#">Creating a cluster</a> in the Amazon ECS documentation.</p> <p><b>Note:</b> Make sure that you choose <b>Create VPC</b> to create</p>	Systems administrator, Developer

Task	Description	Skills required
	a new virtual private cloud (VPC) for your Amazon ECS cluster.	

## Set up the Amazon ECS task

Task	Description	Skills required
Set up the Amazon ECS task execution IAM role.	<p>Create an Amazon ECS task execution IAM role by using the AmazonECS TaskExecutionRolePolicy managed policy. For more information about this, see <a href="#">Amazon ECS task execution IAM role</a> in the Amazon ECS documentation.</p> <p><b>Note:</b> Make sure that you record the IAM role's Amazon Resource Name (ARN).</p>	Systems administrator, Developer
Attach the IAM policy to the Amazon ECS task execution IAM role.	<ol style="list-style-type: none"> <li>1. Create an IAM policy by using the <code>firelens_policy.json</code> (attached) policy document. For more information about this, see <a href="#">Creating policies on the JSON tab</a> in the IAM documentation.</li> <li>2. Attach this policy to the Amazon ECS task execution IAM role that you created earlier. For more information about this, see <a href="#">Adding</a></li> </ol>	Systems administrator, Developer

Task	Description	Skills required
	<a href="#">IAM policies (AWS CLI)</a> in the IAM documentation.	



Task	Description	Skills required
Set up the Amazon ECS task definition.	<ol style="list-style-type: none"><li>1. Update the following sections in the <code>Task.json</code> sample task definition (attached):<ul style="list-style-type: none"><li>• Update the <code>executionRoleArn</code> and <code>taskRoleArn</code> with the ARN of the task execution IAM role</li><li>• Update the <code>imageInContainerDefinitions</code> with the custom Fluent Bit Docker image that you created earlier</li><li>• Update the <code>imageInContainerDefinitions</code> with your application image's name</li></ul></li><li>2. Open the Amazon ECS console, choose <b>Task Definitions</b>, choose <b>Create new task definition</b>, and then choose <b>Fargate</b> on the <b>Select compatibilities</b> page.</li><li>3. Choose <b>Configure via Json</b>, paste the updated <code>Task.json</code> file into the text area, and then choose <b>Save</b>.</li><li>4. Create the task definition.</li></ol>	Systems administrator, Developer

Task	Description	Skills required
	For more information about this, see <a href="#">Creating a task definition</a> in the Amazon ECS documentation.	

## Run the Amazon ECS task

Task	Description	Skills required
Run the Amazon ECS task.	<p>On the Amazon ECS console, choose <b>Clusters</b>, choose the cluster that you created earlier, and then run the standalone task.</p> <p>For more information about this, see <a href="#">Run a standalone task</a> in the Amazon ECS documentation.</p>	Systems administrator, Developer

## Verify the CloudWatch logs

Task	Description	Skills required
Verify the logs.	<ol style="list-style-type: none"> <li>1. Open the CloudWatch console, choose <b>Log groups</b>, and then choose <code>/aws/ecs/container-insights/{{cluster_ARN}}/firelens/application</code>.</li> <li>2. Verify the logs, particularly the custom fields added by the custom parser.</li> </ol>	Systems administrator, Developer

Task	Description	Skills required
	3. Use CloudWatch to filter logs based on the custom fields.	

## Related resources

- [Docker basics for Amazon ECS](#)
- [Amazon ECS on AWS Fargate](#)
- [Configuring basic service parameters](#)

## Attachments

To access additional content that is associated with this document, unzip the following file: [attachment.zip](#)

# Create a pipeline and AMI using CodePipeline and HashiCorp Packer

Created by Akash Kumar (AWS)

<b>Environment:</b> PoC or pilot	<b>Source:</b> DevOps	<b>Target:</b> Amazon Machine Images(AMI)
<b>R Type:</b> Rehost	<b>Workload:</b> All other workloads	<b>Technologies:</b> DevOps; Modernization; Web & mobile apps

## Summary

This pattern provides code samples and steps to create both a pipeline in the Amazon Web Services (AWS) Cloud by using AWS CodePipeline and an Amazon Machine Image (AMI) by using HashiCorp Packer. The pattern is based on the [continuous integration](#) practice, which automates the building and testing of code with a Git-based version control system. In this pattern, you create and clone a code repository by using AWS CodeCommit. Then, create a project and configure your source code by using AWS CodeBuild. Finally, create an AMI that gets committed to your repository.

## Prerequisites and limitations

### Prerequisites

- An active AWS account
- An Amazon Linux AMI for launching Amazon Elastic Compute Cloud (Amazon EC2) instances
- [HashiCorp Packer](#) 0.12.3 or later
- Amazon CloudWatch Events (optional)
- Amazon CloudWatch Logs (optional)

## Architecture

The following diagram shows an example of application code that automates the creation of an AMI by using this pattern's architecture.

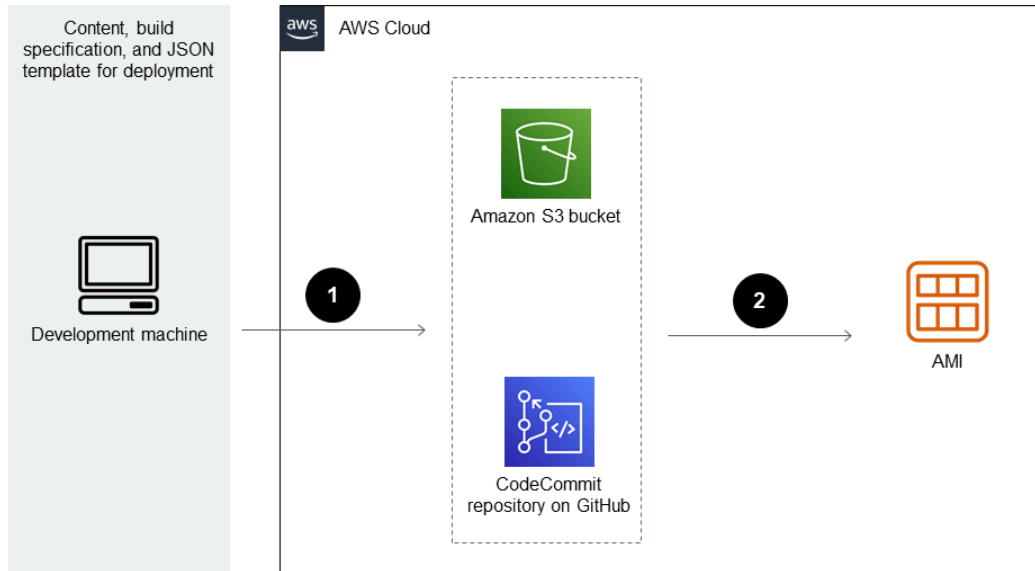

The diagram shows the following workflow:

1. The developer commits code changes to a private CodeCommit Git repository. Then, CodePipeline uses CodeBuild to initiate the build and add new [artifacts](#) that are ready for deployment to the Amazon Simple Storage Service (Amazon S3) bucket.
2. CodeBuild uses Packer to bundle and package the AMI based on a JSON template. If enabled, CloudWatch Events can automatically start the pipeline when a change occurs in the source code.

## Technology stack

- CodeBuild
- CodeCommit
- CodePipeline
- CloudWatch Events (optional)

## Tools

- [AWS CodeBuild](#) – AWS CodeBuild is a fully managed build service in the cloud. CodeBuild compiles your source code, runs unit tests, and produces artifacts that are ready to deploy.
- [AWS CodeCommit](#) – AWS CodeCommit is a version control service that enables you to privately store and manage Git repositories in the AWS Cloud. CodeCommit eliminates the need for you to manage your own source control system or worry about scaling its infrastructure.
- [AWS CodePipeline](#) – AWS CodePipeline is a continuous delivery service that you can use to model, visualize, and automate the steps required to release your software.
- [HashiCorp Packer](#) – HashiCorp Packer is an open-source tool for automating the creation of identical machine images from a single source configuration. Packer is lightweight, runs on every major operating system, and creates machine images for multiple platforms in parallel.

## Code

This pattern includes the following attachments:

- `buildspec.yml` – This file uses CodeBuild to build and create an artifact for deployment.
- `amazon-linux_packer-template.json` – This file uses Packer to create an Amazon Linux AMI.

## Epics

### Set up the code repository

Task	Description	Skills required
Create the repository.	<a href="#">Create a CodeCommit repository.</a>	AWS systems administrator
Clone the repository.	<a href="#">Connect to the CodeCommit repository by cloning the repository.</a>	App developer
Push the source code to the remote repository.	1. <a href="#">Create a commit</a> to add the <code>buildspec.yml</code> and <code>amazon-linux_packer</code>	App developer

Task	Description	Skills required
	<p>r-template.json files to your local repository.</p> <p>2. <a href="#">Push the commit</a> from your local repository to the remote CodeCommit repository.</p>	

## Create a CodeBuild project for the application

Task	Description	Skills required
Create a build project.	<ol style="list-style-type: none"> <li>1. Sign in to the AWS Management console, open the <a href="#">AWS CodeBuild console</a>, and then choose <b>Create build project</b>.</li> <li>2. For <b>Project name</b>, enter the name of your project.</li> <li>3. For <b>Source provider</b>, choose <b>AWS CodeCommit</b>.</li> <li>4. For <b>Repository</b>, choose the repository where you want to build the code pipeline.</li> <li>5. For <b>Environment image</b>, choose <b>Managed image</b> or <b>Custom image</b>.</li> <li>6. For <b>Operating system</b>, choose <b>Ubuntu</b>.</li> <li>7. For <b>RunTime(s)</b>, choose <b>Standard</b>.</li> <li>8. For <b>Image</b>, choose <b>aws/codebuild/standard:4.0</b>.</li> </ol>	App developer, AWS systems administrator

Task	Description	Skills required
	<p>9. For <b>Image version</b>, choose <b>Always use the latest image for this runtime version</b>.</p> <p>10 For <b>Environment</b>, choose <b>Linux</b>.</p> <p>11 Choose the <b>Privileged</b> check box.</p> <p>12 For <b>Service role</b>, choose <b>New service role</b> or <b>Existing service role</b>.</p> <p>13 For <b>Build specifications</b>, choose <b>Use a buildspec file</b> or <b>Insert build commands</b>.</p> <p>14 (Optional) For <b>Type</b> in the <b>Artifacts</b> section, choose <b>No artifacts</b>.</p> <p>15 (Recommended) To upload build output logs to CloudWatch Logs, choose <b>CloudWatch logs</b>.</p> <p>16 (Optional) To upload build output logs to Amazon S3, choose the <b>S3 logs</b> check box.</p> <p>17 Choose <b>Create build project</b>.</p>	



## Set up the pipeline

Task	Description	Skills required
Pipeline name	<ol style="list-style-type: none"><li>1. Sign in to the AWS Management console, open the <a href="#">AWS CodePipeline console</a>, and then choose <b>Create pipeline</b>.</li><li>2. For <b>Pipeline name</b>, enter a name for the pipeline.</li><li>3. For <b>Service role</b>, choose <b>New service role</b> or <b>Existing service role</b>.</li><li>4. For <b>Role name</b>, enter a name for your role.</li><li>5. In the <b>Advanced settings</b> section, for <b>Artifact store</b>, choose <b>Default location</b> if you want Amazon S3 to create a bucket and store the artifacts in the bucket. To use an existing S3 bucket, choose <b>Custom location</b>. Choose <b>Next</b>.</li><li>6. For <b>Source provider</b>, choose <b>AWS CodeCommit</b>.</li><li>7. For <b>Repository name</b>, choose the repository that you cloned earlier. For <b>Branch name</b>, choose your source code branch.</li><li>8. For <b>Change detection options</b>, choose <b>Amazon CloudWatch Events</b></li></ol>	App developer, AWS systems administrator

Task	Description	Skills required
	<p><b>(recommended)</b> to start the pipeline or <b>AWS CodePipeline</b> to periodically check for changes. Choose <b>Next</b>.</p> <p>9. For <b>Build provider</b>, choose <b>AWS CodeBuild</b>.</p> <p>10 For <b>Project Name</b>, choose the build project that you created in the <i>Create a CodeBuild project for the application</i> epic.</p> <p>11 Choose your build options and then choose <b>Next</b>.</p> <p>12 Choose <b>Skip deploy stage</b>.</p> <p>13 Choose <b>Create pipeline</b>.</p>	

## Related resources

- [Working with repositories in AWS CodeCommit](#)
- [Working with build projects](#)
- [Working with pipelines in CodePipeline](#)

## Attachments

To access additional content that is associated with this document, unzip the following file: [attachment.zip](#)

# Create a pipeline and deploy artifact updates to on-premises EC2 instances using CodePipeline

Created by Akash Kumar (AWS)

<b>Environment:</b> PoC or pilot	<b>Source:</b> DevOps	<b>Target:</b> Amazon EC2/On-Premises
<b>R Type:</b> Rehost	<b>Technologies:</b> DevOps; Modernization; Web & mobile apps	<b>AWS services:</b> AWS CodeBuild; AWS CodeCommit; AWS CodeDeploy; AWS CodePipeline

## Summary

This pattern provides code samples and steps to create a pipeline in the Amazon Web Services (AWS) Cloud and deploy updated [artifacts](#) to on-premises Amazon Elastic Compute Cloud (Amazon EC2) instances in AWS CodePipeline. The pattern is based on the [continuous integration](#) practice. This practice automates the building and testing of code with a Git-based version control system. In this pattern, you create and clone a code repository by using AWS CodeCommit. Then, you create a project and configure your source code by using AWS CodeBuild. Finally, you create your application and configure its target environment for on-premises EC2 instances by using AWS CodeDeploy.

## Prerequisites and limitations

### Prerequisites

- An active AWS account
- [User-defined tags](#) to identify EC2 instances during deployment
- [CodeDeploy agent](#), installed on EC2 instances
- Your required runtime software, installed on EC2 instances
- [Amazon Corretto 8](#) for the Java Development Kit
- [Apache Tomcat](#) web server, installed

- Amazon CloudWatch Events (optional)
- A key pair to log in to the web server (optional)
- An Apache Maven application project for a web application

## Architecture

The following diagram shows an example Java web application that's deployed to on-premises EC2 instances by using this pattern's architecture.

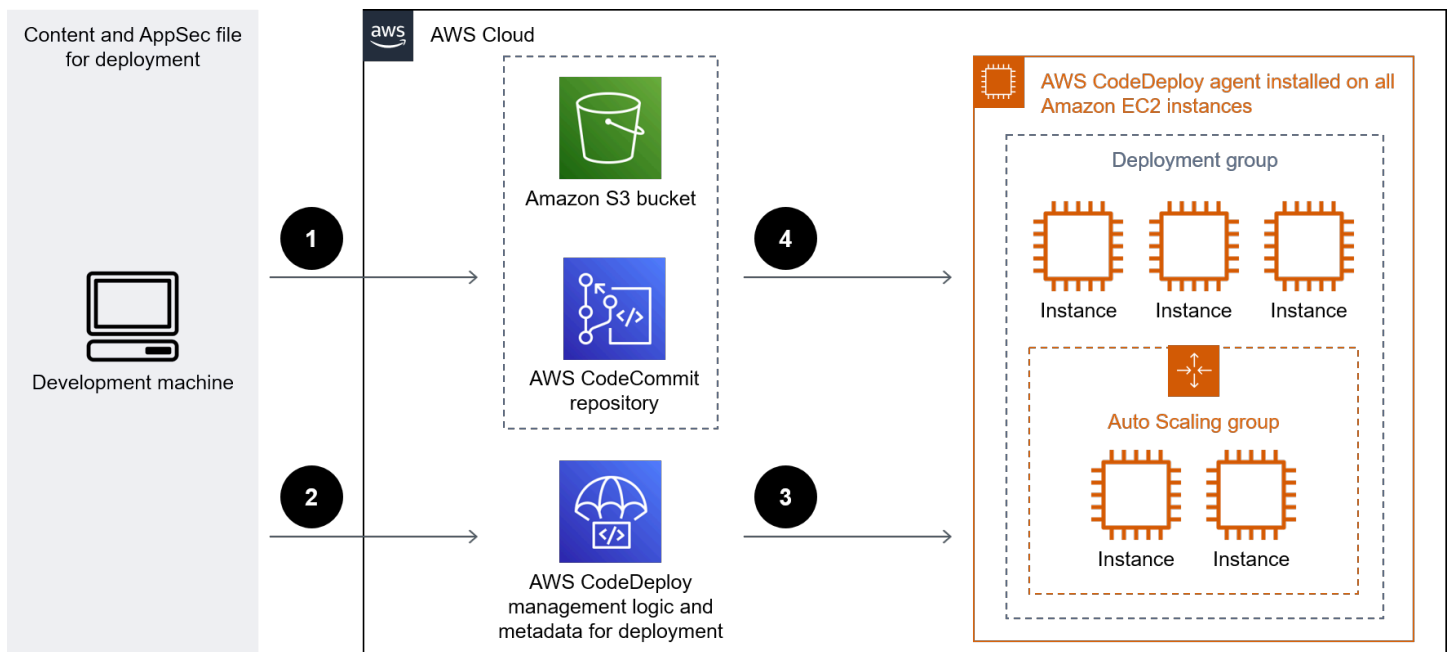

The diagram shows the following workflow:

1. The developer commits code changes to a private CodeCommit Git repository.
2. CodePipeline uses CodeBuild to initiate the build and add new artifacts that are ready for deployment in the Amazon Simple Storage Service (Amazon S3) bucket.
3. CodePipeline uses the CodeDeploy agent to pre-install any dependencies required for the deployment artifact changes.
4. CodePipeline uses the CodeDeploy agent to deploy the artifacts from the S3 bucket to target EC2 instances. If enabled, CloudWatch Events can automatically start the pipeline when a change occurs in the source code.

## Technology stack

- CodeBuild
- CodeCommit
- CodeDeploy
- CodePipeline
- CloudWatch Events (optional)

## Tools

- [AWS CodeBuild](#) is a fully managed build service that helps you compile source code, run unit tests, and produce artifacts that are ready to deploy. CodeBuild compiles your source code, runs unit tests, and produces artifacts that are ready to deploy.
- [AWS CodeCommit](#) is a version control service that helps you privately store and manage Git repositories, without needing to manage your own source control system.
- [AWS CodeDeploy](#) automates deployments to Amazon Elastic Compute Cloud (Amazon EC2) or on-premises instances, AWS Lambda functions, or Amazon Elastic Container Service (Amazon ECS) services.
- [AWS CodePipeline](#) helps you quickly model and configure the different stages of a software release and automate the steps required to release software changes continuously.

## Code

This pattern includes the following attachments:

- `buildspec.yml` – This file specifies the actions that CodeBuild requires to build and create an artifact for deployment.
- `appspec.yml` – This file specifies the actions that CodeDeploy requires to create an application and configure a target environment for on-premises EC2 instances.
- `install_dependencies.sh` – This file installs dependencies for the Apache Tomcat web server.
- `start_server.sh` – This file starts the Apache Tomcat web server.
- `stop_server.sh` – This file stops the Apache Tomcat web server.

## Epics

### Set up the code repository

Task	Description	Skills required
Create the repository.	<a href="#">Create a CodeCommit repository.</a>	AWS systems administrator
Clone the repository.	<a href="#">Connect to the CodeCommit repository by cloning the repository.</a>	App developer
Push the source code to the remote repository.	<ol style="list-style-type: none"> <li>1. <a href="#">Create a commit</a> to add the <code>buildspec.yml</code> and <code>appspec.yml</code> files to your local repository.</li> <li>2. <a href="#">Push the commit</a> from your local repository to the remote CodeCommit repository.</li> </ol>	App developer

### Create a CodeBuild project for the application

Task	Description	Skills required
Create a build project.	<ol style="list-style-type: none"> <li>1. Sign in to the AWS Management Console, open the <a href="#">AWS CodeBuild console</a>, and then choose <b>Create build project</b>.</li> <li>2. For <b>Project name</b>, enter the name of your project.</li> <li>3. For <b>Source provider</b>, choose <b>AWS CodeCommit</b>.</li> </ol>	AWS administrator, App developer

Task	Description	Skills required
	<p>4. For <b>Repository</b>, choose the repository where you want to build the code pipeline.</p> <p>5. For <b>Environment image</b>, choose <b>Managed image</b> or <b>Custom image</b>.</p> <p>6. For <b>Operating system</b>, choose <b>Amazon Linux 2</b>.</p> <p><b>Note:</b> Amazon Linux 2 is nearing end of support. For more information, see the <a href="#">Amazon Linux 2 FAQs</a>.</p> <p>7. For <b>RunTime(s)</b>, choose <b>Standard</b>.</p> <p>8. For <b>Image</b>, choose <b>aws/codebuild/amazonlinux2-aarch64-standard:2.0</b>.</p> <p>9. For <b>Image version</b>, choose <b>Always use the latest image for this runtime version</b>.</p> <p>10For <b>Service role</b>, choose <b>New service role</b> or <b>Existing service role</b>.</p> <p>11For <b>Build specifications</b>, choose <b>Use a buildspec file</b> or <b>Insert build commands</b>.</p> <p>12(Optional) Choose <b>Add artifact to configure artifacts</b>.</p>	

Task	Description	Skills required
	<p>13(Optional) To upload build output logs to Amazon CloudWatch, choose <b>CloudWatch logs</b>.</p> <p>14Choose <b>Create build project</b>.</p>	

## Configure artifact deployment for on-premises EC2 instances

Task	Description	Skills required
Create the application.	<ol style="list-style-type: none"> <li>1. Sign in to the AWS Management Console, open the <a href="#">AWS CodeDeploy console</a>, and then choose <b>Create application</b>.</li> <li>2. For <b>Application name</b>, enter a name for your application.</li> <li>3. For <b>Compute platform</b>, choose <b>EC2/On-premises</b>.</li> <li>4. Choose <b>Create application</b> and then choose <b>Create deployment group</b>.</li> <li>5. For <b>Deployment group name</b>, enter a name.</li> <li>6. Create a <a href="#">service role</a> for CodeDeploy. <b>Note:</b> The service role must have permissions to grant CodeDeploy access to your target environment.</li> </ol>	AWS systems administrator, App developer



Task	Description	Skills required
	<p>7. For <b>Service role</b>, choose the service role that you created in step 6.</p> <p>8. For <b>Deployment type</b>, choose either <b>In-place</b> or <b>Blue/green</b> based on your business requirements.</p> <p>9. For <b>Environment configuration</b>, choose the options that meet your business requirements.</p> <p>10(Optional) <a href="#">Create a target group</a> for your load balancer separately in the Amazon EC2 console, and then go back to the <b>Create deployment group</b> page of the AWS CodeDeploy console to choose your load balancer and target group.</p> <p>11Choose <b>Create deployment group</b>.</p>	

## Set up the pipeline

Task	Description	Skills required
Create the pipeline.	<p>1. Sign in to the AWS Management Console, open the <a href="#">AWS CodePipeline</a></p>	AWS systems administrator, App developer

Task	Description	Skills required
	<p><a href="#">ine console</a>, and then choose <b>Create pipeline</b>.</p> <ol style="list-style-type: none"><li>For <b>Pipeline name</b>, enter a name for the pipeline.</li><li>For <b>Service role</b>, choose <b>New service role</b> or <b>Existing service role</b>.</li><li>For <b>Role name</b>, enter a name for your role.</li><li>In the <b>Advanced settings</b> section, for <b>Artifact store</b>, choose <b>Default location</b> if you want Amazon S3 to create a bucket and store the artifacts in the bucket. To use an existing S3 bucket, choose <b>Custom location</b>. Choose <b>Next</b>.</li><li>For <b>Source provider</b>, choose <b>AWS CodeCommit</b>.</li><li>For <b>Repository name</b>, choose the repository that you cloned earlier. For <b>Branch name</b>, choose your source code branch.</li><li>For <b>Change detection options</b>, choose <b>Amazon CloudWatch Events (recommended)</b> or <b>AWS CodePipeline</b>. Choose <b>Next</b>.</li><li>For <b>Build provider</b>, choose <b>AWS CodeBuild</b>.</li></ol>	

Task	Description	Skills required
	<p>10 For <b>Project Name</b>, choose the build project that you created in the <i>Create a CodeBuild project for the application</i> section of this pattern.</p> <p>11 Choose your build options and then choose <b>Next</b>.</p> <p>12 For <b>Deploy provider</b>, choose <b>AWS CodeDeploy</b>.</p> <p>13 Choose an application name and deployment group, and then choose <b>Next</b>.</p> <p>14 Choose <b>Create pipeline</b>.</p>	

## Related resources

- [Working with repositories in AWS CodeCommit](#)
- [Working with build projects](#)
- [Working with applications in CodeDeploy](#)
- [Working with pipelines in CodePipeline](#)

## Attachments

To access additional content that is associated with this document, unzip the following file: [attachment.zip](#)

# Create dynamic CI pipelines for Java and Python projects automatically

Created by Aromal Raj Jayarajan (AWS), Amarnath Reddy (AWS), MAHESH RAGHUNANDANAN (AWS), and Vijesh Vijayakumaran Nair (AWS)

<b>Code repository:</b> <a href="#">automated-ci-pipeline-creation</a>	<b>Environment:</b> PoC or pilot	<b>Technologies:</b> DevOps; Infrastructure; Serverless
<b>Workload:</b> All other workloads	<b>AWS services:</b> AWS CodeBuild; AWS CodePipeline; AWS Lambda; AWS Step Functions; AWS CodeCommit	

## Summary

This pattern shows how to create dynamic continuous integration (CI) pipelines for Java and Python projects automatically by using AWS developer tools.

As technology stacks diversify and development activities increase, it can become difficult to create and maintain CI pipelines that are consistent across an organization. By automating the process in AWS Step Functions, you can make sure that your CI pipelines are consistent in their usage and approach.

To automate the creation of dynamic CI pipelines, this pattern uses the following variable inputs:

- Programming language (Java or Python only)
- Pipeline name
- Required pipeline stages

**Note:** Step Functions orchestrates pipeline creation by using multiple AWS services. For more information about the AWS services used in this solution, see the **Tools** section of this pattern.

## Prerequisites and limitations

### Prerequisites

- An active AWS account
- An Amazon S3 bucket in the same AWS Region that this solution is being deployed
- An AWS Identity and Access Management (IAM) [principal](#) that has the AWS CloudFormation permissions required to create the resources needed for this solution

## Limitations

- This pattern supports Java and Python projects only.
- The IAM roles provisioned in this pattern follow the principle of least privilege. The IAM roles' permissions must be updated based on the specific resources that your CI pipeline needs to create.

## Architecture

### Target technology stack

- AWS CloudFormation
- AWS CodeBuild
- AWS CodeCommit
- AWS CodePipeline
- IAM
- Amazon Simple Storage Service (Amazon S3)
- AWS Systems Manager
- AWS Step Functions
- AWS Lambda
- Amazon DynamoDB

### Target architecture

The following diagram shows an example workflow for creating dynamic CI pipelines for Java and Python projects automatically by using AWS developer tools.

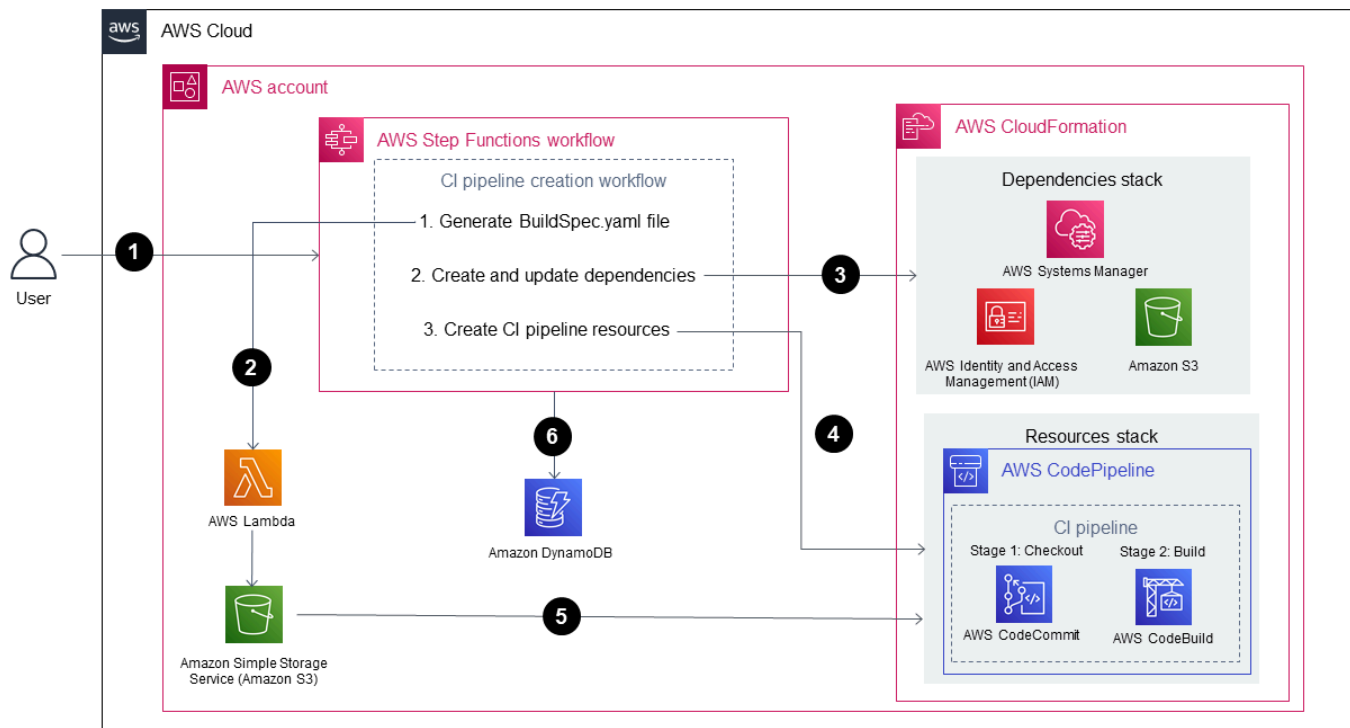

The diagram shows the following workflow:

1. An AWS user provides the input parameters for CI pipeline creation in JSON format. This input starts a Step Functions workflow (*state machine*) that creates a CI pipeline by using AWS developer tools.
2. A Lambda function reads a folder named **input-reference**, which is stored in an Amazon S3 bucket, and then generates a **buildspec.yml** file. This generated file defines the CI pipeline stages and is stored back in the same Amazon S3 bucket that stores the parameter references.
3. Step Functions checks the CI pipeline creation workflow's dependencies for any changes, and updates the dependencies stack as needed.
4. Step Functions creates the CI pipeline resources in a CloudFormation stack, including a CodeCommit repository, CodeBuild project, and a CodePipeline pipeline.
5. The CloudFormation stack copies the sample source code for the selected technology stack (Java or Python) and the **buildspec.yml** file to the CodeCommit repository.
6. CI pipeline runtime details are stored in a DynamoDB table.

## Automation and scale

- This pattern is for use in a single development environment only. Configuration changes are required for use across multiple development environments.
- To add support for more than one CloudFormation stack, you can create additional CloudFormation templates. For more information, see [Getting started with AWS CloudFormation](#) in the CloudFormation documentation.

## Tools

### Tools

- [AWS Step Functions](#) is a serverless orchestration service that helps you combine AWS Lambda functions and other AWS services to build business-critical applications.
- [AWS Lambda](#) is a compute service that helps you run code without needing to provision or manage servers. It runs your code only when needed and scales automatically, so you pay only for the compute time that you use.
- [AWS CodeBuild](#) is a fully managed build service that helps you compile source code, run unit tests, and produce artifacts that are ready to deploy.
- [AWS CodeCommit](#) is a version control service that helps you privately store and manage Git repositories, without needing to manage your own source control system.
- [AWS CodePipeline](#) helps you quickly model and configure the different stages of a software release and automate the steps required to release software changes continuously.
- [AWS Identity and Access Management \(IAM\)](#) helps you securely manage access to your AWS resources by controlling who is authenticated and authorized to use them.
- [AWS Key Management Service \(AWS KMS\)](#) helps you create and control cryptographic keys to help protect your data.
- [Amazon Simple Storage Service \(Amazon S3\)](#) is a cloud-based object storage service that helps you store, protect, and retrieve any amount of data.
- [AWS CloudFormation](#) helps you set up AWS resources, provision them quickly and consistently, and manage them throughout their lifecycle across AWS accounts and Regions.
- [Amazon DynamoDB](#) is a fully managed NoSQL database service that provides fast, predictable, and scalable performance.
- [AWS Systems Manager Parameter Store](#) provides secure, hierarchical storage for configuration data management and secrets management.

## Code

The code for this pattern is available in the GitHub [automated-ci-pipeline-creation](#) repository. The repository contains the CloudFormation templates required to create the target architecture outlined in this pattern.

## Best practices

- Don't enter credentials (*secrets*) such as tokens or passwords directly into CloudFormation templates or Step Functions action configurations. If you do, the information will be displayed in the DynamoDB logs. Instead, use AWS Secrets Manager to set up and store secrets. Then, reference the secrets stored in Secrets Manager within the CloudFormation templates and Step Functions action configurations as needed. For more information, see [What is AWS Secrets Manager](#) in the Secrets Manager documentation.
- Configure server-side encryption for CodePipeline artifacts stored in Amazon S3. For more information, see [Configure server-side encryption for artifacts stored in Amazon S3 for CodePipeline](#) in the CodePipeline documentation.
- Apply least-privilege permissions when configuring IAM roles. For more information, see [Apply least-privilege permissions](#) in the IAM documentation.
- Make sure that your Amazon S3 bucket is not publicly accessible. For more information, see [Configuring block public access setting for your S3 buckets](#) in the Amazon S3 documentation.
- Make sure that you activate versioning for your Amazon S3 bucket. For more information, see [Using versioning in S3 buckets](#) in the Amazon S3 documentation.
- Use IAM Access Analyzer when configuring IAM policies. The tool provides actionable recommendations to help you author secure and functional IAM policies. For more information, see [Using AWS Identity and Access Management Access Analyzer](#) in the IAM documentation.
- When possible, define specific access conditions when configuring IAM policies.
- Activate Amazon CloudWatch logging for monitoring and auditing purposes. For more information, see [What is Amazon CloudWatch Logs?](#) in the CloudWatch documentation.



# Epics

## Configure the prerequisites

Task	Description	Skills required
Create an Amazon S3 bucket.	<p>Create an Amazon S3 bucket (or use an existing bucket) to store the required CloudFormation templates, source code, and input files for the solution.</p> <p>For more information, see <a href="#">Step 1: Create your first S3 bucket</a> in the Amazon S3 documentation.</p> <p><b>Note:</b> The Amazon S3 bucket must be in the same AWS Region that you're deploying the solution to.</p>	AWS DevOps
Clone the GitHub repository.	<p>Clone the GitHub <a href="#">automated-ci-pipeline-creation</a> repository by running the following command in a terminal window:</p> <pre data-bbox="597 1461 1027 1661">git clone https://github.com/aws-samples/automated-ci-pipeline-creation.git</pre> <p>For more information, see <a href="#">Cloning a repository</a> in the GitHub documentation.</p>	AWS DevOps

Task	Description	Skills required
Upload the Solution Templates folder from the cloned GitHub repository to your Amazon S3 bucket.	<p>Copy the contents from the cloned <b>Solution-Templates</b> folder and upload them into the Amazon S3 bucket that you created.</p> <p>For more information, see <a href="#">Uploading objects</a> in the Amazon S3 documentation.</p> <p><b>Note:</b> Make sure that you upload the contents of the <b>Solution-Templates</b> folder only. You can upload the files at the Amazon S3 bucket's root level only.</p>	AWS DevOps

## Deploy the solution

Task	Description	Skills required
Create a CloudFormation stack to deploy the solution by using the template.yml file in the cloned GitHub repository.	<ol style="list-style-type: none"><li>1. Sign into the AWS Management Console and then open the <a href="#">AWS CloudFormation console</a>.</li><li>2. Choose <b>Create stack</b>. A dropdown list appears.</li><li>3. In the dropdown list, select <b>With new resources (standard)</b>. The <b>Create stack</b> page opens.</li><li>4. In the <b>Specify template</b> section, select the</li></ol>	AWS administrator, AWS DevOps

Task	Description	Skills required
	<p>checkbox next to <b>Upload a template file</b>.</p> <ol style="list-style-type: none"><li>5. Select <b>Choose file</b>. Then, navigate to the cloned GitHub repository's root folder and select the <b>template.yml</b> file. Then, choose <b>Open</b>.</li><li>6. Choose <b>Next</b>. The <b>Specify stack details</b> page opens.</li><li>7. In the <b>Parameters</b> section, specify the following parameters:<ul style="list-style-type: none"><li>• For <b>S3Templat</b> <b>eBucketName</b>, enter the name of the Amazon S3 bucket that you created earlier, which contains the source code and references for this solution. Make sure that the bucket name parameter is in lowercase .</li><li>• For <b>DynamoDBTable</b>, enter a name for the DynamoDB table that the CloudFormation stack creates.</li><li>• For <b>StateMachineName</b>, enter a name for the Step Functions state machine that the</li></ul></li></ol>	

Task	Description	Skills required
	<p>CloudFormation stack creates.</p> <p>8. Choose <b>Next</b>. The <b>Configure stack options</b> page opens.</p> <p>9. On the <b>Configure stack options</b> page, choose <b>Next</b>. Don't change any of the default values. The <b>Review</b> page opens.</p> <p>10 Review the stack creation settings. Then, choose <b>Create stack</b> to launch your stack.</p> <p><b>Note:</b> While your stack is being created, it's listed on the <b>Stacks</b> page with a status of <b>CREATE_IN_PROGRESS</b>. Make sure that you wait for the stack's status to change to <b>CREATE_COMPLETE</b> before completing the remaining steps in this pattern.</p>	

## Test the setup

Task	Description	Skills required
Run the step function that you created.	1. Sign in to the AWS Management Console	AWS administrator, AWS DevOps

Task	Description	Skills required
	<p>and then open the <a href="#">Step Functions console</a>.</p> <ol style="list-style-type: none"><li>Open the step function that you created.</li><li>Choose <b>Start execution</b>. Then, enter your input values for the workflow in JSON format (see the following example inputs).</li><li>Choose <b>Start execution</b>.</li></ol> <p><b>JSON formatting</b></p> <pre>{   "details": {     "tech_stack":       "Name of the Tech Stack       (python/java)",     "project_name":       "Name of the Project       that you want to create       with",     "pre_build":       "Choose the step if       it required in the       buildspec.yml file       i.e., yes/no",     "build": "Choose the       step if it required in       the buildspec.yml file       i.e., yes/no",     "post_build":       "Choose the step if       it required in the       buildspec.yml file       i.e., yes/no",     "reports": "Choose       the step if it required</pre>	

Task	Description	Skills required
	<pre>in the buildspec.yml file i.e., yes/no", } }</pre> <p data-bbox="592 422 971 457"><b>Java JSON input example</b></p> <pre>{   "details": {     "tech_stack": "java",     "project_name": "pipeline-java-pjt",     "pre_build": "yes",     "build": "yes",     "post_build": "yes",     "reports": "yes"   } }</pre> <p data-bbox="592 1087 1015 1123"><b>Python JSON input example</b></p> <pre>{   "details": {     "tech_stack": "python",     "project_name": "pipeline-python-p jst",     "pre_build": "yes",     "build": "yes",     "post_build": "yes",     "reports": "yes"   } }</pre>	

Task	Description	Skills required
<p>Confirm that the CodeCommit repository for the CI pipeline was created.</p>	<ol style="list-style-type: none"><li>1. Sign in to the AWS Management Console and then open the <a href="#">CodeCommit console</a>.</li><li>2. On the <b>Repositories</b> page, verify that the name of the CodeCommit repository that you created appears in the list of repositories. The name of the repository is appended with the following: <b>pipeline-java-pjt-Repo</b></li><li>3. Open the CodeCommit repository and validate that the sample source code along with <b>buildspec.yml</b> files are pushed to the main branch.</li></ol>	<p>AWS DevOps</p>

Task	Description	Skills required
Check the CodeBuild project resources.	<ol style="list-style-type: none"><li>1. Sign in to the AWS Management Console and then open the <a href="#">CodeBuild console</a>.</li><li>2. On the <b>Build projects</b> page, verify that the name of the CodeBuild project that you created appears in the list of projects. The name of the project is appended with the following: <b>pipeline-java-pjt-Build</b></li><li>3. Select the name of your CodeBuild project to open the project. Then, review and validate the following configurations:<ul style="list-style-type: none"><li>• <b>Project Configuration</b></li><li>• <b>Source</b></li><li>• <b>Environment</b></li><li>• <b>Buildspec</b></li><li>• <b>Batch Configuration</b></li><li>• <b>Artifacts</b></li></ul></li></ol>	AWS DevOps



Task	Description	Skills required
Validate the CodePipeline stages.	<ol style="list-style-type: none"><li>1. Sign in to the AWS Management Console and then open the <a href="#">CodePipeline console</a>.</li><li>2. On the <b>Pipelines</b> page, verify that the name of the pipeline that you created appears in the list of pipelines. The name of the pipeline is appended with the following: <b>pipeline-java-pjt-Pipeline</b></li><li>3. Select the name of your pipeline to open the pipeline. Then, review and validate each stage of the pipeline, including <b>Commit</b> and <b>Deploy</b>.</li></ol>	AWS DevOps
Confirm that the CI pipeline ran successfully.	<ol style="list-style-type: none"><li>1. In the <a href="#">CodePipeline console</a>, on the <b>Pipelines</b> page, select the name of your pipeline to view the pipeline's status.</li><li>2. Verify that each stage of the pipeline has a <b>Succeeded</b> status.</li></ol>	AWS DevOps

## Clean up your resources

Task	Description	Skills required
Delete the resources stack in CloudFormation.	<p>Delete the CI pipeline's resources stack in CloudFormation.</p> <p>For more information, see <a href="#">Deleting a stack on the AWS CloudFormation console</a> in the CloudFormation documentation.</p> <p><b>Note:</b> Make sure that you delete the stack named <b>&lt;project_name&gt;-stack</b>.</p>	AWS DevOps
Delete the CI pipeline's dependencies in Amazon S3 and CloudFormation.	<ol style="list-style-type: none"><li>1. Empty the Amazon S3 bucket named <b>DeploymentArtifactBucket</b>. For more information, see <a href="#">Emptying a bucket</a> in the Amazon S3 documentation.</li><li>2. Delete the CI pipeline's dependency stack in CloudFormation. For more information, see <a href="#">Deleting a stack on the AWS CloudFormation console</a> in the CloudFormation documentation.</li></ol> <p><b>Note:</b> Make sure that you delete the stack named <b>pipeline-creation-dependencies-stack</b>.</p>	AWS DevOps

Task	Description	Skills required
Delete the Amazon S3 template bucket.	<p>Delete the Amazon s3 bucket that you created in the <b>Configure the prerequisites</b> section of this pattern, which stores the templates for this solution.</p> <p>For more information, see <a href="#">Deleting a bucket</a> in the Amazon S3 documentation.</p>	AWS DevOps

## Related resources

- [Creating a Step Functions state machine that uses Lambda](#) (AWS Step Functions documentation)
- [AWS Step Functions WorkFlow Studio](#) (AWS Step Functions documentation)
- [DevOps and AWS](#)
- [How does AWS CloudFormation work?](#) (AWS CloudFormation documentation)
- [Complete CI/CD with AWS CodeCommit, AWS CodeBuild, AWS CodeDeploy, and AWS CodePipeline](#) (AWS blog post)
- [IAM and AWS STS quotas, name requirements, and character limits](#) (IAM documentation)

# Deploy CloudWatch Synthetics canaries by using Terraform

Created by Dhrubajyoti Mukherjee (AWS) and Jean-Francois Landreau (AWS)

**Code repository:** [Deploy CloudWatch Synthetics canaries with Terraform](#)

**Environment:** Production

**Technologies:** DevOps; Business productivity; DevelopmentAndTesting; Infrastructure; Web & mobile apps

**AWS services:** Amazon CloudWatch; Amazon S3; Amazon SNS; Amazon VPC; AWS Identity and Access Management

## Summary

It's important to validate the health of a system from a customer perspective and confirm that customers are able to connect. This is more difficult when the customers don't constantly call the endpoint. [Amazon CloudWatch Synthetics](#) supports the creation of canaries, which can test both public and private endpoints. By using canaries, you can know the status of a system even if it isn't in use. These canaries are either Node.js Puppeteer scripts or Python Selenium scripts.

This pattern describes how to use HashiCorp Terraform to deploy canaries that test private endpoints. It embeds a Puppeteer script that tests whether a URL returns 200-OK. The Terraform script can then be integrated with the script that deploys the private endpoint. You can also modify the solution to monitor public endpoints.

## Prerequisites and limitations

### Prerequisites

- An active Amazon Web Services (AWS) account with a virtual private cloud (VPC) and private subnets
- The URL of the endpoint that can be reached from the private subnets

- Terraform installed in the deployment environment

## Limitations

The current solution works for the following CloudWatch Synthetics runtime versions:

- syn-nodejs-puppeteer-3.4
- syn-nodejs-puppeteer-3.5
- syn-nodejs-puppeteer-3.6
- syn-nodejs-puppeteer-3.7

As new runtime versions are released, you might need to update the current solution. You will also need to modify the solution to keep up with security updates.

## Product versions

- Terraform 1.3.0

## Architecture

Amazon CloudWatch Synthetics is based on CloudWatch, Lambda, and Amazon Simple Storage Service (Amazon S3). Amazon CloudWatch offers a wizard to create the canaries and a dashboard that displays the status of the canary runs. The Lambda function runs the script. Amazon S3 stores the logs and screenshots from the canary runs.

This pattern simulates a private endpoint through an Amazon Elastic Compute Cloud (Amazon EC2) instance deployed in the targeted subnets. The Lambda function requires elastic network interfaces in the VPC where the private endpoint is deployed.

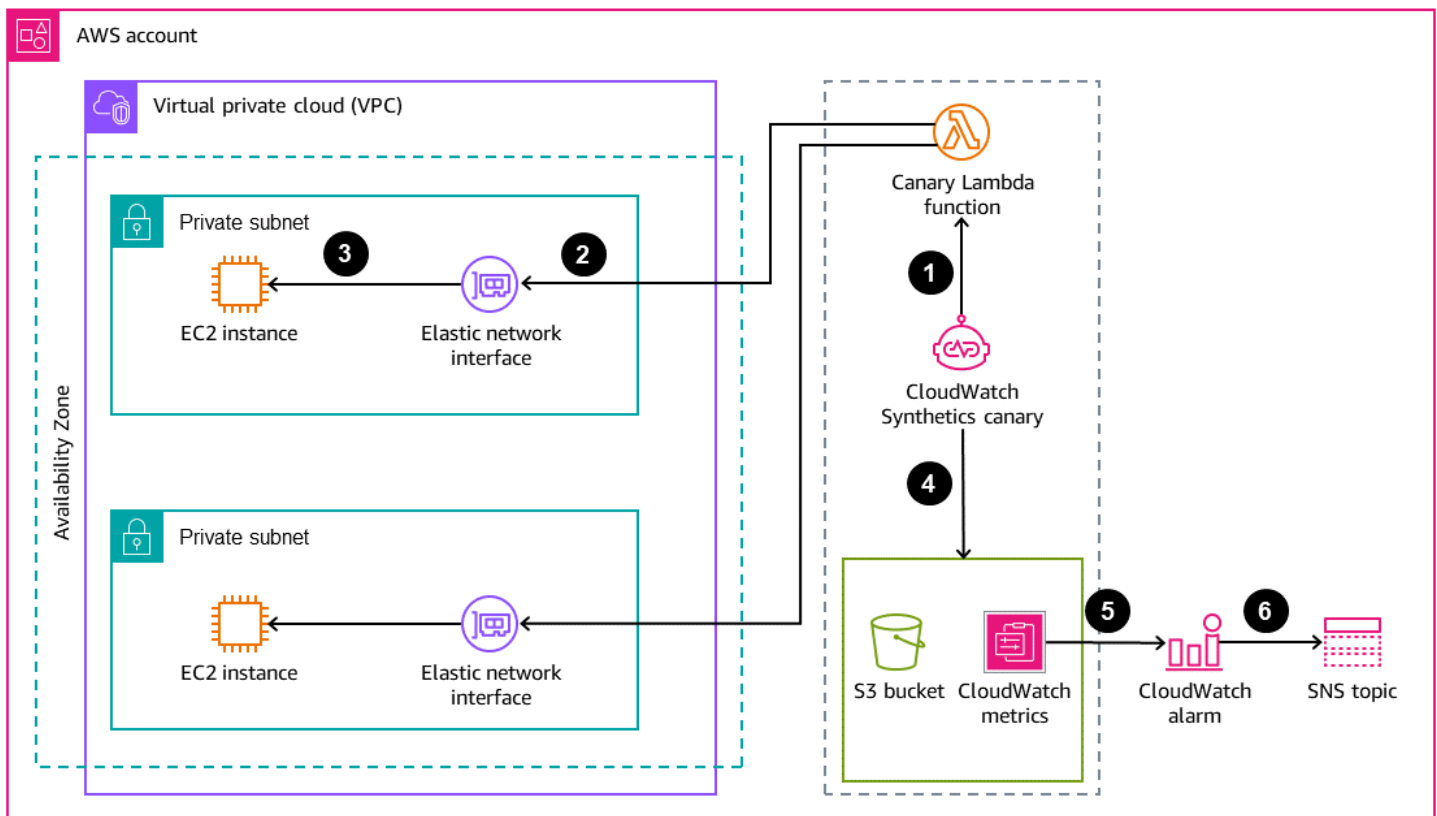

The diagram shows the following:

1. The Synthetics canary initiates the canary Lambda function.
2. The canary Lambda function connects to the elastic network interface.
3. The canary Lambda function monitors the status of the endpoint.
4. The Synthetics canary pushes run data to the S3 bucket and CloudWatch metrics.
5. A CloudWatch alarm is initiated based on the metrics.
6. The CloudWatch alarm initiates the Amazon Simple Notification Service (Amazon SNS) topic.

## Tools

### AWS services

- [Amazon CloudWatch](#) helps you monitor the metrics of your AWS resources and the applications you run on AWS in real time.

- [AWS Lambda](#) is a compute service that helps you run code without needing to provision or manage servers. It runs your code only when needed and scales automatically, so you pay only for the compute time that you use.
- [Amazon Simple Notification Service \(Amazon SNS\)](#) helps you coordinate and manage the exchange of messages between publishers and clients, including web servers and email addresses.
- [Amazon Simple Storage Service \(Amazon S3\)](#) is a cloud-based object storage service that helps you store, protect, and retrieve any amount of data.
- [Amazon Virtual Private Cloud \(Amazon VPC\)](#) helps you launch AWS resources into a virtual network that you've defined. This virtual network resembles a traditional network that you'd operate in your own data center, with the benefits of using the scalable infrastructure of AWS. This pattern uses VPC endpoints and elastic network interfaces.

### Other services

- [HashiCorp Terraform](#) is an open-source infrastructure as code (IaC) tool that helps you use code to provision and manage cloud infrastructure and resources. This pattern uses Terraform to deploy the infrastructure.
- [Puppeteer](#) is a Node.js library. The CloudWatch Synthetics runtime uses the Puppeteer framework.

### Code

The solution is available in the GitHub [cloud watch-synthetics-canary-terraform](#) repository. For more information, see the *Additional information* section.

## Epics

### Implement the solution for monitoring a private URL

Task	Description	Skills required
Gather requirements for monitoring the private URL.	Gather the full URL definition: domain, parameters, and headers. To communicate privately to Amazon S3 and	Cloud architect, Network administrator

Task	Description	Skills required
	Amazon CloudWatch, use VPC endpoints. Note how the VPC and subnets are accessible to the endpoint. Consider the frequency of canary runs.	



Task	Description	Skills required
Modify the existing solution to monitor the private URL.	<p>Modify the <code>terraform.tfvars</code> file:</p> <ul style="list-style-type: none"><li>• <code>name</code> – The name of your canary.</li><li>• <code>runtime_version</code> – The runtime version of the canary. We recommend using <code>syn-nodejs-puppeteer-3.7</code>.</li><li>• <code>take_screenshot</code> – Whether a screenshot should be taken.</li><li>• <code>api_hostname</code> – The hostname of the endpoint that is monitored.</li><li>• <code>api_path</code> – The path of the endpoint that is monitored.</li><li>• <code>vpc_id</code> – The VPC ID that is used by the canary Lambda function.</li><li>• <code>subnet_ids</code> – The subnet IDs that are used by the canary Lambda function.</li><li>• <code>frequency</code> – The run frequency of the canary in minutes.</li><li>• <code>alert_sns_topic</code> – The SNS topic to which the CloudWatch alarm notification is sent.</li></ul>	Cloud architect

Task	Description	Skills required
Deploy and operate the solution.	<p>To deploy the solution, do the following:</p> <ol style="list-style-type: none"> <li>From the <code>cloudwatch-synthetics-canary-terraform</code> directory in your development environment, initialize Terraform.           <pre data-bbox="630 663 1029 747">terraform init</pre> </li> <li>Plan and review the changes.           <pre data-bbox="630 877 1029 961">terraform plan</pre> </li> <li>Deploy the solution.           <pre data-bbox="630 1050 1029 1134">terraform apply</pre> </li> </ol>	Cloud architect, DevOps engineer

## Troubleshooting

Issue	Solution
Deletion of the provisioned resources gets stuck.	Manually delete the canary Lambda function, corresponding elastic network interface, and security group, in that order.

## Related resources

- [Using synthetic monitoring](#)
- [Monitor API Gateway endpoints with Amazon CloudWatch Synthetics](#) (blog post)

## Additional information

### Repository artifacts

The repository artifacts are in the following structure.

```
.
### README.md
### main.tf
### modules
#   ### canary
#   ### canary-infra
### terraform.tfvars
### tf.plan
### variable.tf
```

The `main.tf` file contains the core module, and it deploys two submodules:

- `canary-infra` deploys the infrastructure required for the canaries.
- `canary` deploys the canaries.

The input parameters for the solution are located in the `terraform.tfvars` file. You can use the following code example to create one canary.

```
module "canary" {
  source = "./modules/canary"
  name   = var.name
  runtime_version = var.runtime_version
  take_screenshot = var.take_screenshot
  api_hostname = var.api_hostname
  api_path = var.api_path
  reports-bucket = module.canary_infra.reports-bucket
  role = module.canary_infra.role
  security_group_id = module.canary_infra.security_group_id
  subnet_ids = var.subnet_ids
  frequency = var.frequency
  alert_sns_topic = var.alert_sns_topic
}
```

The corresponding `.var` file follows.

```
name      = "my-canary"
runtime_version = "syn-nodejs-puppeteer-3.7"
take_screenshot = false
api_hostname = "mydomain.internal"
api_path = "/path?param=value"
vpc_id = "vpc_id"
subnet_ids = ["subnet_id1"]
frequency = 5
alert_sns_topic = "arn:aws:sns:eu-central-1:111111111111:yyyyy"
```

## Cleaning up the solution

If you are testing this in a development environment, you can clean up the solution to avoid accruing costs.

1. On the AWS Management Console, navigate to the Amazon S3 console. Empty the Amazon S3 bucket that the solution created. Make sure to take a backup of the data, if required.
2. In your development environment, from the `cloudwatch-synthetics-canary-terraform` directory, run the `destroy` command.

```
terraform destroy
```

# Deploy a CI/CD pipeline for Java microservices on Amazon ECS

Created by Vijay Thompson (AWS) and Sankar Sangubotla (AWS)

**Environment:** PoC or pilot

**Technologies:** DevOps;  
Containers & microservices

**AWS services:** AWS  
CodeBuild; Amazon EC2  
Container Registry; Amazon  
ECS; AWS Fargate; AWS  
CodePipeline

## Summary

This pattern guides you through the steps for deploying a continuous integration and continuous delivery (CI/CD) pipeline for Java microservices on an existing Amazon Elastic Container Service (Amazon ECS) cluster by using AWS CodeBuild. When the developer commits the changes, the CI/CD pipeline is initiated and the build process starts in CodeBuild. When the build is complete, the artifact is pushed to Amazon Elastic Container Registry (Amazon ECR) and the latest build from Amazon ECR is picked up and pushed to the Amazon ECS service.

## Prerequisites and limitations

### Prerequisites

- An existing Java microservices application running on Amazon ECS
- Familiarity with AWS CodeBuild and AWS CodePipeline

## Architecture

### Source technology stack

- Java microservices running on Amazon ECS
- Code repository in Amazon ECR
- AWS Fargate

### Source architecture

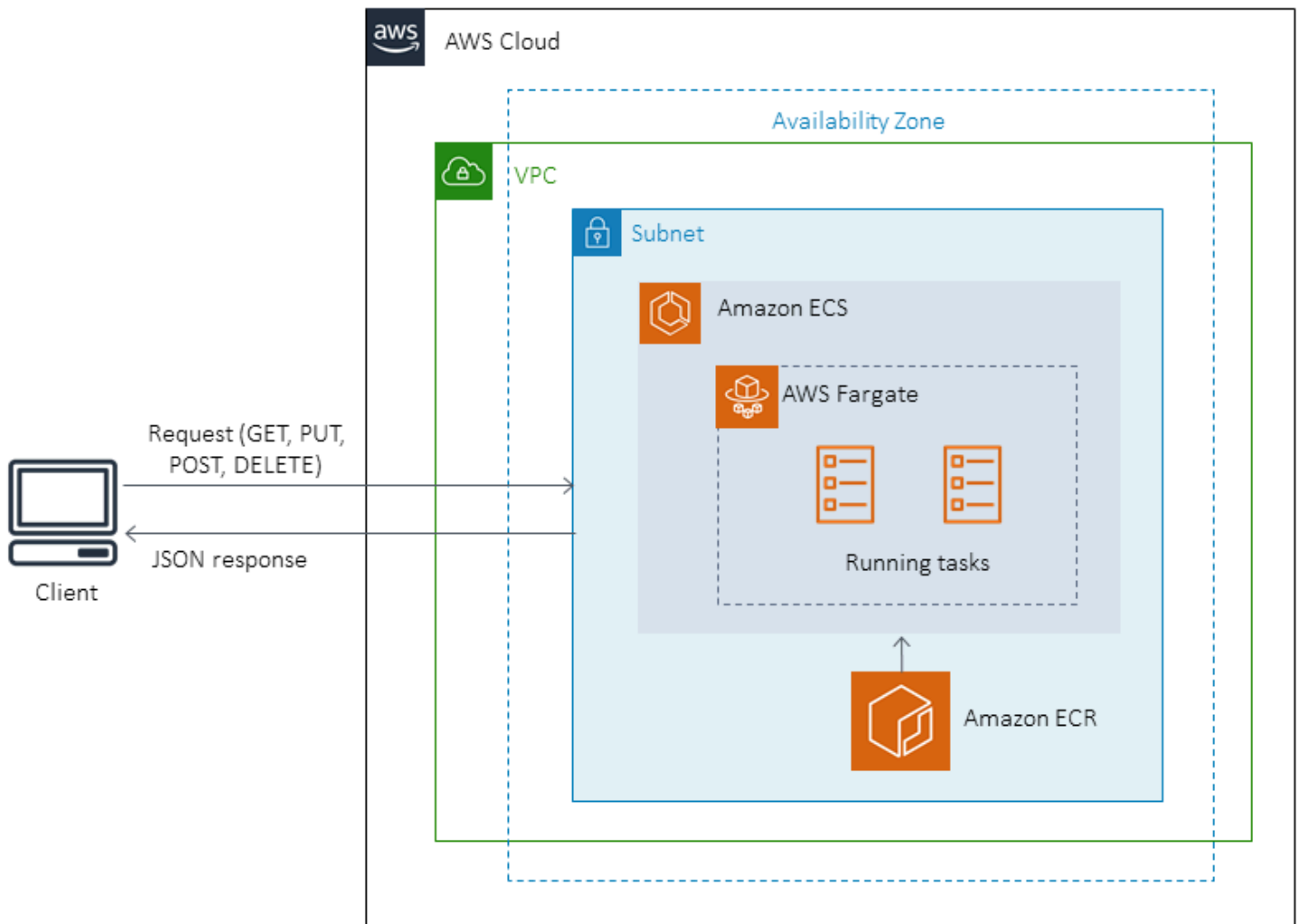

**Target technology stack**

- Amazon ECR
- Amazon ECS
- AWS Fargate
- AWS CodePipeline
- AWS CodeBuild

**Target architecture**

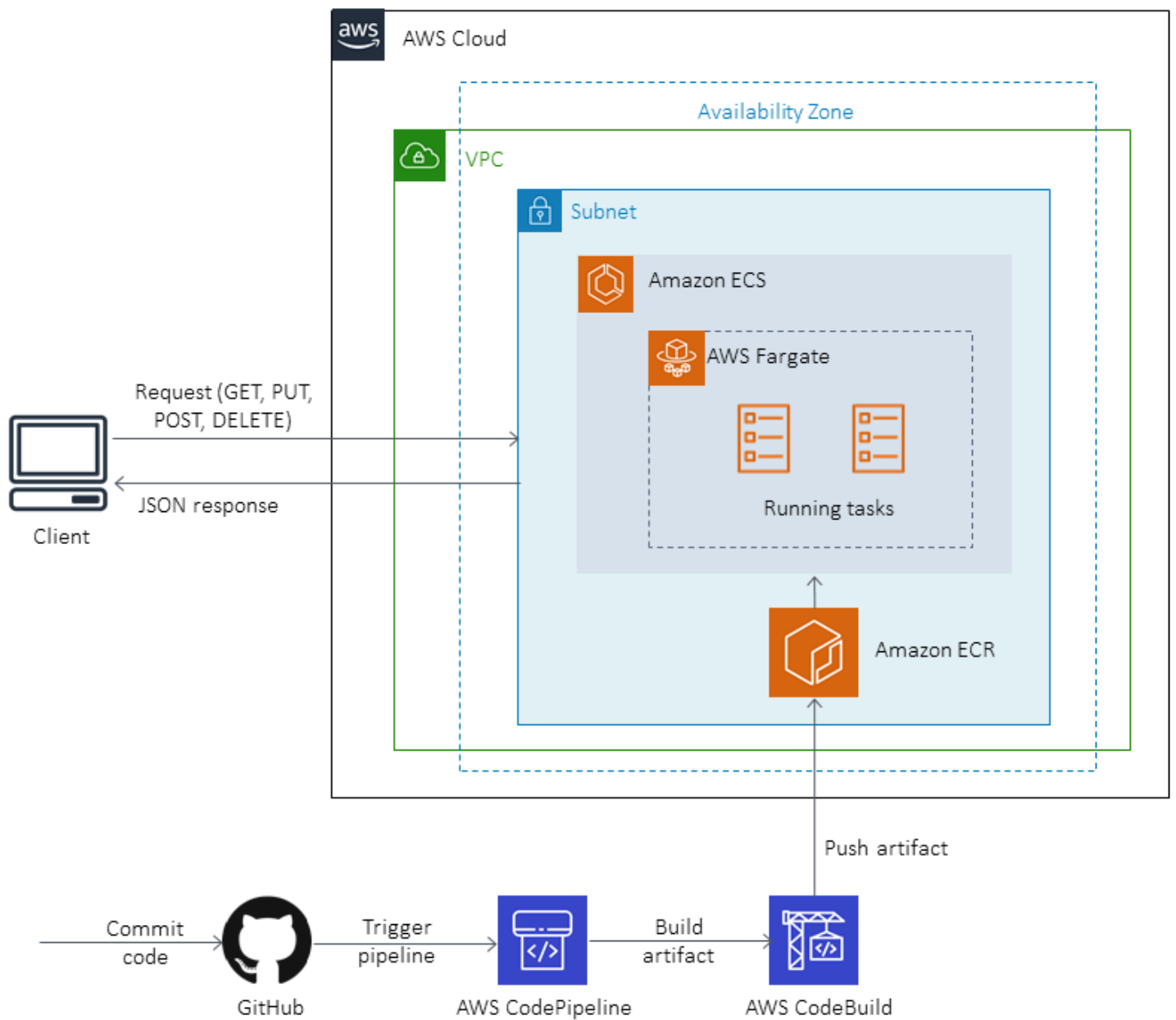

## Automation and scale

CodeBuild buildspec.yml file:

```
version: 0.2

phases:
  pre_build:
    commands:
      - echo Logging in to Amazon ECR...
      - aws --version
```

```
- $(aws ecr get-login --region $AWS_DEFAULT_REGION --no-include-email)
- REPOSITORY_URI=$AWS_ACCOUNT_ID.dkr.ecr.$AWS_DEFAULT_REGION.amazonaws.com/
$IMAGE_REPO
- COMMIT_HASH=$(echo $CODEBUILD_RESOLVED_SOURCE_VERSION | cut -c 1-7)
- IMAGE_TAG=build-$(echo $CODEBUILD_BUILD_ID | awk -F":" '{print $2}')
build:
  commands:
    - echo Build started on `date`
    - echo building the Jar file
    - mvn clean install
    - echo Building the Docker image...
    - docker build -t $REPOSITORY_URI:$BUILD_TAG .
    - docker tag $REPOSITORY_URI:$BUILD_TAG $REPOSITORY_URI:$IMAGE_TAG
post_build:
  commands:
    - echo Build completed on `date`
    - echo Pushing the Docker images...
    - docker push $REPOSITORY_URI:$BUILD_TAG
    - docker push $REPOSITORY_URI:$IMAGE_TAG
    - echo Writing image definitions file...
    - printf '[{"name":"%s","imageUri":"%s"}]' $DOCKER_CONTAINER_NAME
$REPOSITORY_URI:$IMAGE_TAG > imagedefinitions.json
    - cat imagedefinitions.json
artifacts:
  files:
    - imagedefinitions.json
    - target/DockerDemo.jar
```

## Tools

### AWS services

- [AWS CodeBuild](#) is a fully managed build service that helps you compile source code, run unit tests, and produce artifacts that are ready to deploy. AWS CodeBuild scales continuously and processes multiple builds concurrently, so your builds are not left in the queue.
- [AWS CodePipeline](#) helps you quickly model and configure the different stages of a software release and automate the steps required to release software changes continuously. You can integrate AWS CodePipeline with third-party services like GitHub, or use an AWS services such as AWS CodeCommit or Amazon ECR.
- [Amazon Elastic Container Registry \(Amazon ECR\)](#) is a fully managed registry that makes it easy for developers to store, manage, and deploy Docker container images. Amazon ECR is integrated



with Amazon ECS to simplify your development-to-production workflow. Amazon ECR hosts your images in a highly available and scalable architecture so you can deploy containers for your applications reliably. Integration with AWS Identity and Access Management (IAM) provides resource-level control of each repository.

- [Amazon Elastic Container Service \(Amazon ECS\)](#) highly scalable, high-performance container orchestration service that supports Docker containers and allows you to easily run and scale containerized applications on AWS. Amazon ECS eliminates the need for you to install and operate your own container orchestration software, manage and scale a cluster of virtual machines, or schedule containers on those virtual machines.
- [AWS Fargate](#) is a compute engine for Amazon ECS that allows you to run containers without having to manage servers or clusters. With AWS Fargate, you no longer have to provision, configure, and scale clusters of virtual machines to run containers. This removes the need to choose server types, decide when to scale your clusters, or optimize cluster packing.

## Other tools

- [Docker](#) is a platform that lets you build, test, and deliver applications in packages called *containers*.
- [Git](#) is a distributed version-control system for tracking changes in source code during software development. It is designed for coordinating work among programmers, but it can be used to track changes in any set of files. Its goals include speed, data integrity, and support for distributed, non-linear workflows. You can also use AWS CodeCommit as an alternative to Git.

## Epics

### Set up the build project in AWS CodeBuild

Task	Description	Skills required
Create a CodeBuild build project.	In the <a href="#">AWS CodeBuild console</a> , create a build project, and specify its name.	App developer, AWS systems administrator
Select the source.	This pattern uses Git for the code repository, so choose <b>GitHub</b> from the list of	App developer, AWS systems administrator

Task	Description	Skills required
	available options. Choose a public repository or from your GitHub account.	
Select a repository.	Select the repository from which you want to build the code.	App developer, AWS systems administrator
Select the environment.	You can select from a list of managed images or opt for a custom image using Docker. This pattern uses the following managed image: <ul data-bbox="591 835 1013 1178" style="list-style-type: none"><li>• Amazon Linux 2 (<b>Note:</b> Amazon Linux 2 is nearing end of support. For more information, see the <a href="#">Amazon Linux 2 FAQs.</a>)</li><li>• Runtime: Standard</li><li>• Image version 1.0</li></ul>	App developer, AWS systems administrator
Choose a service role.	You can create a service role or select from a list of existing roles.	App developer, AWS systems administrator

Task	Description	Skills required
Add environment variables.	<p>In the <b>Additional configuration</b> section, configure the following environment variables:</p> <ul style="list-style-type: none"><li>• <b>AWS_DEFAULT_REGION</b> for the default AWS Region</li><li>• <b>AWS_ACCOUNT_ID</b> for the user account number</li><li>• <b>IMAGE_REPO</b> for the Amazon ECR private repository</li><li>• <b>BUILD_TAG</b> for the version of the build (<b>latest</b> build is the value for this variable)</li><li>• <b>DOCKER_CONTAINER_NAME</b> for the name of the container in the task</li></ul> <p>These variables are placeholders in the <code>buildspec.yml</code> file and will be replaced with their respective values.</p>	App developer, AWS systems administrator

Task	Description	Skills required
Create a buildspec file.	You can create a <code>buildspec.yml</code> file at the same location as <code>pom.xml</code> and add the configuration that is provided in this pattern, or use the online buildspec editor and add the configuration. Configure the environmental variables with the appropriate values by following the steps provided.	App developer, AWS systems administrator
Configure the project for artifacts.	(Optional) Configure the build project for artifacts, if required.	App developer, AWS systems administrator
Configure Amazon CloudWatch Logs.	(Optional) Configure Amazon CloudWatch Logs for the build project, if required. This step is optional but recommended.	App developer, AWS systems administrator
Configure Amazon S3 logs.	(Optional) Configure Amazon Simple Storage Service (Amazon S3) logs for the build project, if you want to store the logs.	App developer, AWS systems administrator

## Configure the pipeline in AWS CodePipeline

Task	Description	Skills required
Create a pipeline.	On the <a href="#">AWS CodePipeline console</a> , create a pipeline and specify its name. For	App developer, AWS systems administrator

Task	Description	Skills required
	more information about creating a pipeline, see the <a href="#">AWS CodePipeline documentation</a> .	
Select a service role.	Create a service role or select from the list of existing service roles. If you are creating a service role, provide a name for the role and select the option for CodePipeline to create the role.	App developer, AWS systems administrator
Choose an artifact store.	In <b>Advanced settings</b> , if you want Amazon S3 to create a bucket and store the artifacts in it, use the default location for the artifact store. Or, select a custom location and specify an existing bucket. You can also choose to encrypt the artifact by using an encryption key.	App developer, AWS systems administrator
Specify the source provider.	For <b>Source provider</b> , choose <b>GitHub (Version 2)</b> .	App developer, AWS systems administrator
Select the repository and branch of the code.	If you are not logged in, provide the connection details to connect to GitHub, and then select the repository name and branch name.	App developer, AWS systems administrator

Task	Description	Skills required
Change detection options.	Choose <b>Start the pipeline on source code change</b> and move to the next page.	App developer, AWS systems administrator
Select a build provider.	For <b>Build provider</b> , choose <b>AWS CodeBuild</b> , and then provide the AWS Region and project name details for the build project.  For <b>Build type</b> , choose <b>Single build</b> .	App developer, AWS systems administrator
Choose a deploy provider.	For <b>Deploy provider</b> , choose Amazon ECS. Choose the cluster name, the service name, the image definitions file, if any, and a deployment timeout value, if required. Choose <b>Create pipeline</b> .	App developer, AWS systems administrator

## Related resources

- [AWS ECS documentation](#)
- [AWS ECR documentation](#)
- [AWS CodeBuild documentation](#)
- [AWS CodeCommit documentation](#)
- [AWS CodePipeline documentation](#)
- [Build a Continuous Delivery Pipeline for Your Container Images with Amazon ECR as Source](#) (blog post)

# Use AWS CodeCommit and AWS CodePipeline to deploy a CI/CD pipeline in multiple AWS accounts

Created by Kirankumar Chandrashekar (AWS) and Abdal Garuba (AWS)

**Environment:** PoC or pilot

**Technologies:** DevOps

**Workload:** All other workloads

**AWS services:** AWS CodeCommit; AWS CodePipeline

## Summary

This pattern shows you how to deploy a continuous integration and continuous delivery (CI/CD) pipeline for your application code workloads in separate Amazon Web Services (AWS) accounts for DevOps, developer, staging, and production workflows.

You can use a [multiple AWS account strategy](#) to provide a high level of [resource or security isolation](#), [optimize costs](#), and separate out your production workflow.

Your application's code remains identical in all these separate AWS accounts and is maintained on a central AWS CodeCommit repository hosted by your DevOps account. Your developer, staging, and production accounts have separate Git branches in this CodeCommit repository.

For example, when code is committed to the developer Git branch in your central CodeCommit repository, Amazon EventBridge in your DevOps account notifies EventBridge in your developer account of the repository changes. In your developer account, AWS CodePipeline and the [source stage](#) go into InProgress status. The source stage is configured from the developer Git branch in the central CodeCommit repository and CodePipeline assumes a [service role](#) for the DevOps account.

The contents of the CodeCommit repository in the developer branch are uploaded to an artifact store in an Amazon Simple Storage Service (Amazon S3) bucket and encrypted with an AWS Key Management Service (AWS KMS) key. After the source stage's status changes to Succeeded in CodePipeline, the code will be transitioned to the next stage of the [pipeline execution](#).

# Prerequisites and limitations

## Prerequisites

- Existing AWS accounts for each required environment (DevOps, developer, staging, and production). These accounts can be hosted by [AWS Organizations](#).
- AWS Command Line Interface (AWS CLI), [installed](#) and [configured](#).

## Architecture

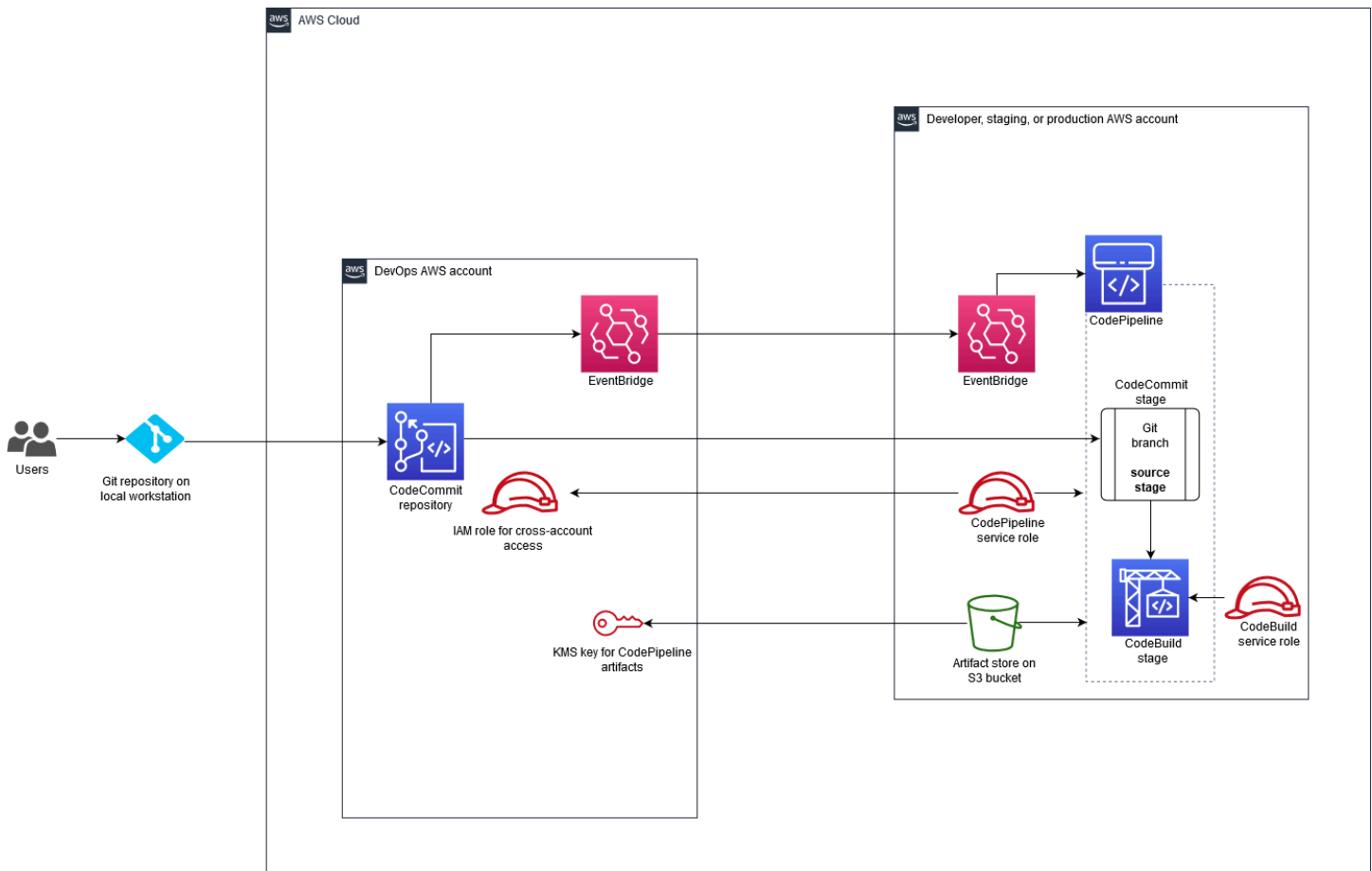

## Technology stack

- AWS CodeBuild
- AWS CodeCommit
- AWS CodePipeline
- Amazon EventBridge



- AWS Identity and Access Management (IAM)
- AWS KMS
- AWS Organizations
- Amazon S3

## Tools

- [AWS CodeBuild](#) – CodeBuild is a fully managed continuous integration service that compiles source code, runs tests, and produces software packages that are ready to deploy.
- [AWS CodeCommit](#) – CodeCommit is a fully-managed source-control service that hosts secure Git-based repositories
- [AWS CodePipeline](#) – CodePipeline is a fully managed continuous delivery service that helps you automate your release pipelines for fast and reliable application and infrastructure updates.
- [Amazon EventBridge](#) – EventBridge is a serverless event bus service for connecting your applications with data from a variety of sources.
- [AWS Identity and Access Management \(IAM\)](#) – IAM helps you to manage access to AWS services and resources securely.
- [AWS KMS](#) – AWS Key Management Service (AWS KMS) helps you create and manage cryptographic keys and control their use across a wide range of AWS services and in your applications.
- [Amazon S3](#) – Amazon Simple Storage Service (Amazon S3) is storage for the internet.

## Epics

### Create resources in your DevOps AWS account

Task	Description	Skills required
Create a CodeCommit repository.	Sign in to the AWS Management Console for your DevOps account, and open the CodeCommit console. Create a repository and set up all the required Git	DevOps engineer

Task	Description	Skills required
	branches for your developer, staging, and production AWS accounts. For help with this and other stories, see the “Related resources” section.	
Create access credentials for the CodeCommit repository.	On the IAM console, create access credentials to allow application developers to push and pull the application’s code base from the CodeCommit repository.	DevOps engineer
Create an IAM role for CodePipeline service roles.	On the IAM console, create an IAM role that can be used by all your CodePipeline service roles to access the central CodeCommit repository.	Cloud administrator
Set up the EventBridge rules for your other AWS accounts.	On the Amazon EventBridge console, set up rules to send notifications about relevant CodeCommit repository changes to EventBridge in the individual developer, staging, and production AWS accounts.	Cloud administrator
Create an AWS KMS key.	On the AWS KMS console, create a KMS key that allows CodePipeline in your individual developer, staging, and production AWS accounts to encrypt and decrypt artifacts.	Cloud administrator

## Create resources in your other AWS accounts

Task	Description	Skills required
Set up EventBridge to receive events from the DevOps AWS account.	Sign in to the AWS Management Console for one of your individual AWS accounts (developer, staging, or production). On the Amazon EventBridge console, set up EventBridge to receive CodeCommit repository change events from your DevOps account.	Cloud administrator
Create an S3 bucket.	On the Amazon S3 console, create an S3 bucket to store CodePipeline artifacts.	Cloud administrator
Create all required AWS resources for CodePipeline stages.	Create all the other AWS resources that will be required by the CodePipeline stages. These resources will vary depending on the role of each AWS account in your CI/CD pipeline.	Cloud administrator
Create an IAM role.	On the IAM console, create an IAM role for the CodePipeline service role. This service role must be able to assume the IAM role in the DevOps account to access the CodeCommit repository.	Cloud administrator
Create a pipeline in CodePipeline.	On the CodePipeline console, create a pipeline. Then create a source stage that points to	Cloud administrator

Task	Description	Skills required
	the CodeCommit repository in the DevOps account for its individual Git branch.	
Repeat the steps for all your AWS accounts.	Repeat these steps for all the AWS accounts that are required as part of your CI/CD strategy.	Cloud administrator

## Related resources

### Create resources in your DevOps AWS account

- [Create a CodeCommit repository](#)
- [Set up a CodeCommit repository](#)
- [Create and share a branch in your CodeCommit repository](#)
- [Create access credentials for the CodeCommit repository](#)
- [Create an IAM role for CodePipeline service roles](#)
- [Set up rule in EventBridge](#)
- [Create an AWS KMS key](#)
- [Set up account policies and roles for CodePipeline](#)

### Create resources in your other AWS accounts

- [Turn on EventBridge to receive events from your DevOps AWS account](#)
- [Create an S3 bucket for CodePipeline artifacts](#)
- [Create all other necessary AWS resources for CodePipeline stages](#)
- [Create an IAM role for CodePipeline service role](#)
- [Create a pipeline in CodePipeline](#)
- [Create a pipeline in CodePipeline that uses resources from another AWS account](#)

### Other resources

- [Establish your best practice AWS environment](#)
- [Authentication and access control for CodeCommit](#)

# Deploy a ChatOps solution to manage SAST scan results by using AWS Chatbot custom actions and AWS CloudFormation

Created by Anand Bukkapatnam Tirumala (AWS)

**Code repository:** [chatops-slack](#)

**Environment:** Production

**Technologies:** DevOps; Security, identity, compliance; Messaging & communications; Business productivity; Customer engagement; Web & mobile apps

**AWS services:** AWS Chatbot; AWS CloudFormation; AWS KMS; AWS Lambda; Amazon SES; Amazon SNS; Amazon S3; AWS Identity and Access Management; AWS Step Functions; AWS CodeBuild; AWS Secrets Manager

## Summary

This pattern presents a comprehensive solution that uses AWS Chatbot to streamline the management of static application security testing (SAST) scan failures reported through SonarQube. This innovative approach integrates custom actions and notifications into a conversational interface, enabling efficient collaboration and decision-making processes within development teams.

In today's fast-paced software development environment, managing SAST scan results efficiently is crucial for maintaining code quality and security. However, many organizations face the following significant challenges:

- Delayed awareness of critical vulnerabilities because of inefficient notification systems
- Slow decision-making processes caused by disconnected approval workflows

- Lack of immediate, actionable responses to SAST scan failures
- Fragmented communication and collaboration around security findings
- Time-consuming and error-prone manual infrastructure setup for security tooling

These issues often lead to increased security risks, delayed releases, and reduced team productivity. To address these challenges effectively requires a solution that can streamline SAST result management, enhance team collaboration, and automate infrastructure provisioning.

Key features of the solution include:

- **Customized notifications** – Real-time alerts and notifications are delivered directly to team chat channels, ensuring prompt awareness and action on SAST scan vulnerabilities or failures.
- **Conversational approvals** – Stakeholders can initiate and complete approval workflows for SAST scan results seamlessly within the chat interface, accelerating decision-making processes.
- **Custom actions** – Teams can define and execute custom actions based on SAST scan outcomes, such as automatically triggering email messages for quality gate failures, enhancing responsiveness to security issues.
- **Centralized collaboration** – All SAST scan-related discussions, decisions, and actions are kept within a unified chat environment, fostering improved collaboration and knowledge-sharing among team members.
- **Infrastructure as code (IaC)** – The entire solution is wrapped with AWS CloudFormation templates, enabling faster and more reliable infrastructure provisioning while reducing manual setup errors.

## Prerequisites and limitations

### Prerequisites

- An active AWS account.
- An AWS Identity and Access Management (IAM) role with permissions to create and manage resources associated with the AWS services listed in [Tools](#).
- A Slack workspace.
- AWS Chatbot added to the required Slack workspace as a plugin. For more information, see [Add apps to your Slack workspace](#) in the Slack documentation. Keep a note of the Slack workspace ID as shown on the AWS Management Console after successful registration.

- A configured AWS Chatbot client, with the workspace ID readily available for input in the AWS CloudFormation console. For instructions, see [Configure a Slack client](#) in the *AWS Chatbot Administrator Guide*.
- A source email account that is created and verified in Amazon Simple Email Service (Amazon SES) to send out approval email messages. For setup instructions, see [Creating and verifying email identities](#) in the *Amazon Simple Email Service Developer Guide*.
- A destination email address for receiving approval notifications. This address can be a shared inbox or a specific team distribution list.
- An operational SonarQube instance that's accessible from your AWS account. For more information, see the [SonarQube installation instructions](#).
- A SonarQube [user token](#) with permissions to trigger and create projects through the pipeline.

## Limitations

- Custom actions for AWS Chatbot are currently not supported through AWS CloudFormation. The creation of custom action buttons is a manual process in this solution.
- Some AWS services aren't available in all AWS Regions. For Region availability, see [AWS services by Region](#). For specific endpoints, see [Service endpoints and quotas](#), and choose the link for the service.

## Architecture

The following diagram shows the workflow and architecture components for this pattern.



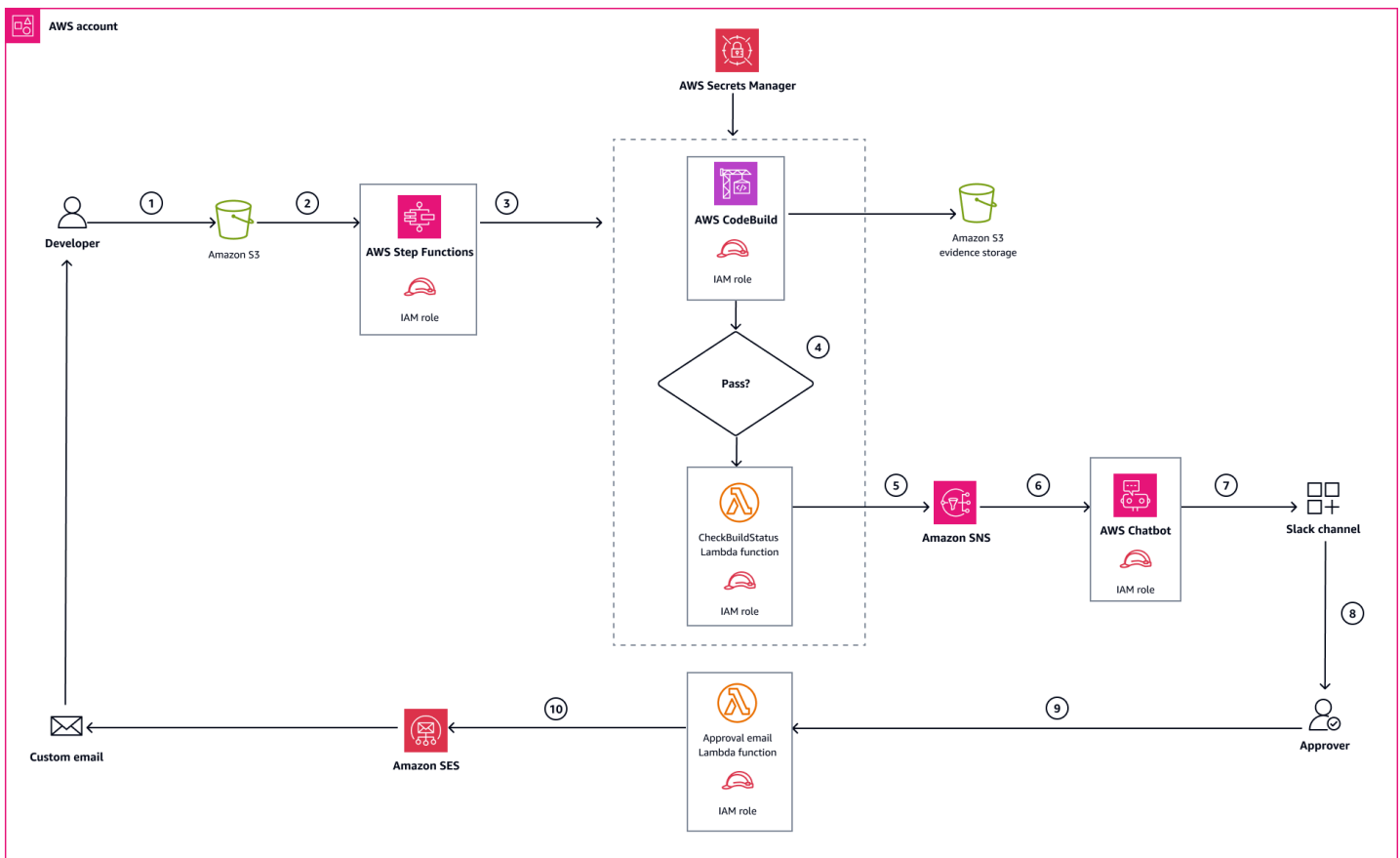

The diagram shows the automated code quality assurance workflow:

### 1. Code preparation and upload:

- The developer compresses the codebase into a .zip file.
- The developer manually uploads the .zip file to a designated Amazon Simple Storage Service (Amazon S3) bucket.

### 2. Amazon S3 event trigger and AWS Step Functions orchestration:

- The Amazon S3 upload event triggers a Step Functions workflow.
- Step Functions orchestrates a SAST scan using SonarQube.
- The workflow monitors the AWS CodeBuild job status to determine next actions. If CodeBuild succeeds (quality gate pass), the workflow terminates. If CodeBuild fails, an AWS Lambda function is invoked for diagnostics. For more details, see **AWS Step Functions logic** later in this section.

### 3. AWS CodeBuild execution:

- The CodeBuild job executes a SonarQube scan on the uploaded codebase.

- Scan artifacts are stored in a separate Amazon S3 bucket for auditing and analysis.
4. Failure analysis (Lambda function):
    - On CodeBuild failure, the CheckBuildStatus Lambda function is triggered.
    - On CodeBuild success, the process is terminated and no further action is needed.
  5. Lambda function analyzes failure cause (quality gate failure or other issues)
    - The CheckBuildStatus function creates a custom payload with detailed failure information.
    - The CheckBuildStatus function publishes the custom payload to an Amazon Simple Notification Service (Amazon SNS) topic.
  6. Notification system:
    - Amazon SNS forwards the payload to AWS Chatbot for Slack integration.
  7. Slack integration:
    - AWS Chatbot posts a notification in the designated Slack channel.
  8. Approval process:
    - Approvers review the failure details in the Slack notification.
    - Approvers can initiate approval using the **Approve** button in Slack.
  9. Approval handler:
    - An Approval Lambda function processes the approval action from Slack.
    - The Approval function generates a custom message for developer notification.
    - The Approval function publishes the custom message to Amazon SES.
  10. Developer notification:
    - Amazon SES sends an email message to the developer with next steps or required actions.

This workflow combines manual code upload with automated quality checks, provides immediate feedback through Slack, and allows for human intervention when necessary, ensuring a robust and flexible code review process.

## AWS Step Functions logic

As shown in the previous architecture diagram, if the quality gate pass on SonarQube fails, the workflow goes to the CheckBuildStatus Lambda function. The CheckBuildStatus function triggers a notification on the Slack channel. Each notification includes information with suggested next steps. Following are the types of notifications:

- **Application has failed in code security scan** – The user receives this notification when the uploaded code did not pass the SonarQube security scan. The user can choose **APPROVE** to accept the build. However, the notification advises the user to beware of potential poor code quality and security risks. The notification includes the following details:
  - Next steps: Error: Quality gate status: FAILED – View details at the provided URL.
  - Triage the vulnerabilities as mentioned in the document at the provided URL.
  - CodeBuild details are available at the location at the provided URL.
- **Application scan pipeline has failed because of some other reason** – The user receives this notification when the pipeline failed for some reason other than failing the code security scan. The notification includes the following details:
  - For next steps, go to the link provided for further troubleshooting.

To see screenshots of the notifications as they appear in a Slack channel, go to the [assets folder](#) in the GitHub chatops-slack repository.

The following diagram shows an example of Step Functions step status after the quality gate pass fails.

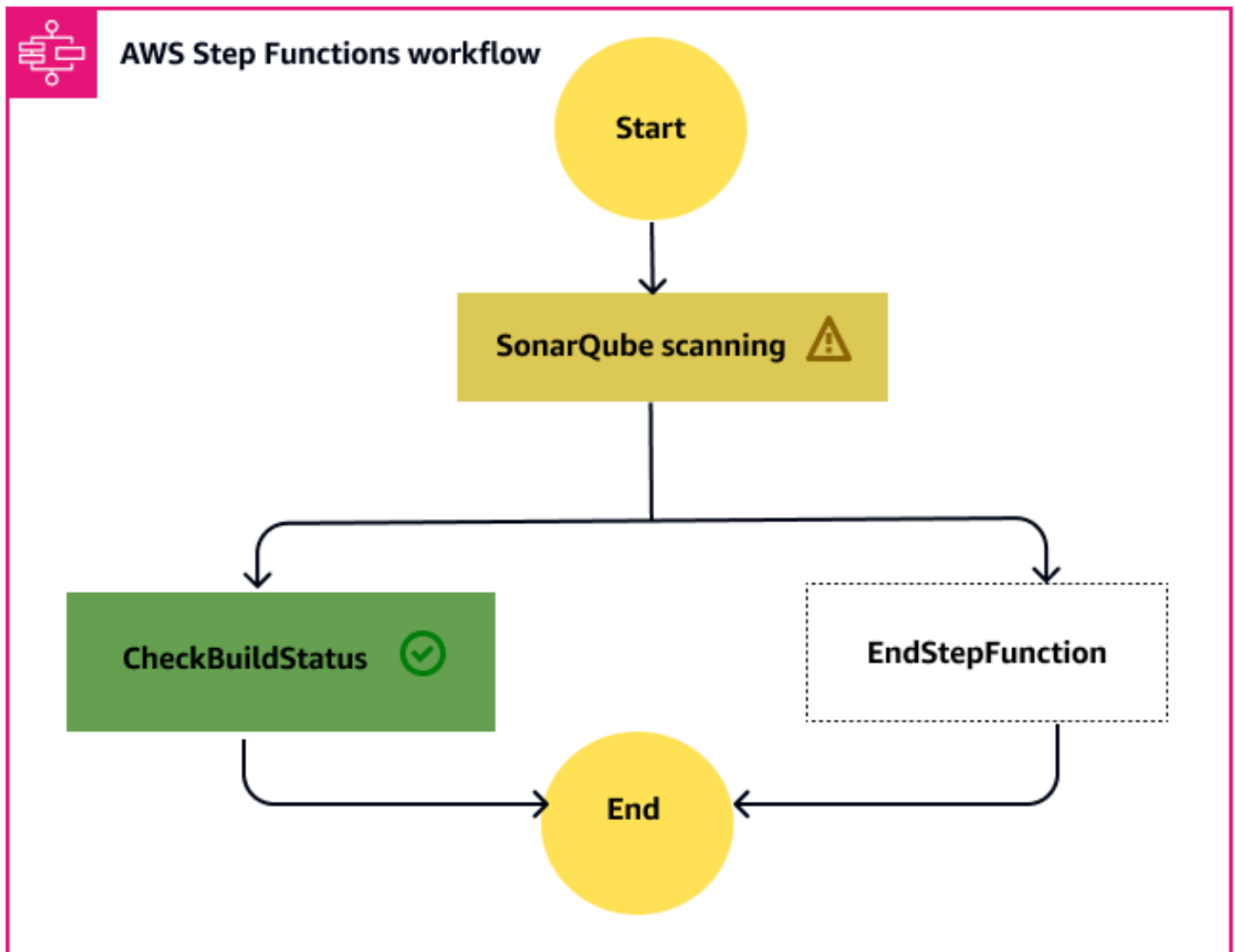

## Tools

### AWS services

- [AWS Chatbot](#) enables you to use Amazon Chime, Microsoft Teams, and Slack chat channels to monitor and respond to operational events in your AWS applications.
- [AWS CloudFormation](#) helps you set up AWS resources, provision them quickly and consistently, and manage them throughout their lifecycle across AWS accounts and AWS Regions.
- [AWS CodeBuild](#) is a fully managed build service that helps you compile source code, run unit tests, and produce artifacts that are ready to deploy.
- [AWS Identity and Access Management \(IAM\)](#) helps you securely manage access to your AWS resources by controlling who is authenticated and authorized to use them.

- [AWS Key Management Service \(AWS KMS\)](#) helps you create and control cryptographic keys to help protect your data.
- [AWS Lambda](#) is a compute service that helps you run code without needing to provision or manage servers. It runs your code only when needed and scales automatically, so you pay only for the compute time that you use.
- [AWS Secrets Manager](#) helps you replace hardcoded credentials in your code, including passwords, with an API call to Secrets Manager to retrieve the secret programmatically.
- [Amazon Simple Email Service \(Amazon SES\)](#) helps you send and receive email messages by using your own email addresses and domains.
- [Amazon Simple Notification Service \(Amazon SNS\)](#) helps you coordinate and manage the exchange of messages between publishers and clients, including web servers and email addresses.
- [Amazon Simple Storage Service \(Amazon S3\)](#) is a cloud-based object storage service that helps you store, protect, and retrieve any amount of data.
- [AWS Step Functions](#) is a serverless orchestration service that helps you combine AWS Lambda functions and other AWS services to build business-critical applications.

## Other tools

- [Slack](#), a Salesforce offering, is an AI-powered conversational platform that provides chat and video collaboration, automates processes with no code, and supports information sharing.
- [SonarQube](#) is an on-premises analysis tool designed to detect coding issues in over 30 languages, frameworks, and IaC platforms.

## Code repository

The code for this pattern is available in the GitHub [chatops-slack](#) repository.

## Best practices

- **CloudFormation stack management** – If you encounter any failures during CloudFormation stack execution, we recommend that you delete the failed stack. Then, re-create it with the correct parameter values. This approach supports a clean deployment and helps avoid potential conflicts or partial implementations.

- **Shared inbox email configuration** – When you configure the `SharedInboxEmail` parameter, use a common distribution list that's accessible to all relevant developers. This approach promotes transparency and helps important notifications reach the relevant team members.
- **Production approval workflow** – For production environments, restrict access to the Slack channel that's used for build approvals. Only designated approvers should be members of this channel. This practice maintains a clear chain of responsibility and enhances security by limiting who can approve critical changes.
- **IAM permissions** – Follow the principle of least privilege and grant the minimum permissions required to perform a task. For more information, see [Grant least privilege](#) and [Security best practices](#) in the IAM documentation.

## Epics

### Perform initial setup

Task	Description	Skills required
Clone the repository.	To clone the <a href="#">chatops-slack</a> repository for this pattern, use the following command.  <pre>git clone "git@github.com:aws-samples/chatops-slack.git"</pre>	AWS DevOps, Build lead, DevOps engineer, Cloud administrator
Create the .zip files that contain Lambda code.	Create the .zip files for the AWS Lambda function code for the <code>CheckBuildStatus</code> and <code>ApprovalEmail</code> functionality. To create <code>notification.zip</code> and <code>approval.zip</code> , use the following commands.  <pre>cd chatops-slack/src</pre>	AWS DevOps, Build lead, DevOps engineer, Cloud administrator

Task	Description	Skills required
	<pre>chmod -R 775 *</pre> <pre>zip -r approval.zip approval</pre> <pre>zip -r notification.zip notification</pre>	

## Deploy the pre-requisite stack file

Task	Description	Skills required
Execute the <code>pre-requisite.yml</code> stack file.	<p>The <code>pre-requisite.yml</code> CloudFormation stack file deploys the initial resources that are required before you execute the <code>app-security.yml</code> stack file. To execute the <code>pre-requisite.yml</code> file, do the following:</p> <ol style="list-style-type: none"> <li>1. Sign in to the AWS Management Console, and open the <a href="#">AWS CloudFormation</a> console. Choose <b>Create stack</b>, and then choose <b>With new resources (standard)</b> from the dropdown list.</li> <li>2. On the <b>Create stack</b> page, choose <b>Choose an existing template</b> and <b>Upload</b></li> </ol>	AWS administrator, AWS DevOps, Build lead, DevOps engineer

Task	Description	Skills required
	<p>a <b>template file</b>. Then, choose <b>Choose file</b> and select <b>pre-requisite.yml</b>. Choose <b>Next</b>.</p> <p>3. On the <b>Specify stack details</b> page, enter values for the parameters as described in <a href="#">Additional information</a>. Then, choose <b>Next</b>.</p> <p>4. On the <b>Configure stack options</b> page, choose the IAM role for creating the resources as described in <a href="#">Prerequisites</a>. Then, choose <b>Next</b>.</p> <p>5. On the <b>Review and create</b> page, choose <b>Submit</b>.</p> <p>6. On the details page for the stack, choose the <b>Resources</b> and <b>Outputs</b> tabs. Make a note of the values for the <code>S3Lambda</code>, <code>CKMSKeyArn</code>, and <code>CKMSKeyId</code> parameters that are used in the following steps.</p>	



Task	Description	Skills required
Upload the .zip files to the Amazon S3 bucket.	Upload the notification.zip and approval.zip files that you created earlier to the Amazon S3 bucket named S3LambdaBucket. The app-security.yml CloudFormation stack file uses S3LambdaBucket to provision the Lambda function.	AWS DevOps, Build lead, DevOps engineer, AWS systems administrator

### Execute the app-security.yml stack file

Task	Description	Skills required
Execute the app-security.yml stack file.	<p>The app-security.yml stack file deploys the remaining infrastructure for the notification and the approval system. To execute the app-security.yml file, do the following:</p> <ol style="list-style-type: none"> <li>1. Sign in to the AWS Management Console, and open the <a href="#">AWS CloudFormation</a> console. Choose <b>Create stack</b>, and then choose <b>With new resources (standard)</b> from the dropdown list.</li> <li>2. On the <b>Create stack</b> page, choose <b>Choose an existing template</b> and <b>Upload</b></li> </ol>	AWS DevOps, AWS systems administrator, DevOps engineer, Build lead

Task	Description	Skills required
	<p>a <b>template file</b>. Then, choose <b>Choose file</b> and select <b>app-security.yml</b>. Choose <b>Next</b>.</p> <p>3. On the <b>Specify stack details</b> page, enter values for the parameters as described in <a href="#">Additional information</a>. Then, choose <b>Next</b>.</p> <p>4. On the <b>Configure stack options</b> page, choose the IAM role for creating the resources as described in <a href="#">Prerequisites</a>. Then, choose <b>Next</b>.</p> <p>5. On the <b>Review and create</b> page, choose <b>Submit</b>.</p>	

Task	Description	Skills required
Test the notification setup.	<p>To test the notification setup, do the following:</p> <ol style="list-style-type: none"><li>1. Open the <a href="#">Amazon SNS console</a>. In the left navigation pane, choose <b>Topics</b>.</li><li>2. Select the topic name that ends with <b>LambdaToAWSSlackChatbot</b>.</li><li>3. On the topic's details page, choose <b>Publish message</b>.</li><li>4. On the <b>Publish message to topic</b> page, for <b>Message body to send to the endpoint</b>, enter the following:</li></ol> <pre data-bbox="630 1073 1027 1549">{   "version": "1.0",   "source":   "custom",   "content": {     "description": ":warning : This is a test notification"   } }</pre> <ol style="list-style-type: none"><li>5. Choose <b>Publish message</b>.</li></ol> <p>After the test message is delivered successfully, you should see a notification on the Slack channel. For more</p>	AWS DevOps, AWS systems administrator, DevOps engineer, Build lead

Task	Description	Skills required
	information, see <a href="#">Test notifications from AWS services to Slack</a> in the <i>AWS Chatbot Administrator Guide</i> .	

## Set up approval flow

Task	Description	Skills required
Configure custom Lambda action.	<p>To set up the custom AWS Lambda action, do the following:</p> <ol style="list-style-type: none"> <li>1. Choose the vertical ellipsis button on the bottom of the delivery notification in your Slack channel.</li> <li>2. In <b>Manage actions</b>, choose <b>Create</b>.</li> <li>3. Enter a custom action name, for example, <b>Approve</b>. This name is a unique identifier for your custom action.</li> <li>4. Enter a name for your custom action button, for example, <b>Approve</b>. This name is shown on a button on your notification. This name should be 20 characters or less and can incorporate emojis.</li> <li>5. For <b>Custom action type</b>, select <b>Lambda action</b>.</li> </ol>	AWS administrator, AWS DevOps, Build lead, DevOps engineer, Slack Admin

Task	Description	Skills required
	<p>6. Choose <b>Next</b>.</p> <p>7. Select the AWS account and AWS Region where you want to deploy this action.</p> <p>8. Choose <b>Load Lambdas</b>.</p> <p>9. In <b>Define Lambda Function</b>, select a Lambda function that ends with <b>ApprovalEmailLambda</b>. Then, choose <b>Next</b>.</p> <p>10. To create the <b>Approve</b> button, choose <b>Save</b> on the <b>Display criteria</b> page.</p>	
Validate approval flow.	<p>To validate that the approval flow works as expected, choose the <b>Approve</b> button in Slack.</p> <p>Slackbot should send a notification on the message thread with the confirmation string <b>Approval Email sent successfully</b>.</p>	AWS administrator, AWS DevOps, DevOps engineer, Slack Admin

## Troubleshooting

Issue	Solution
Slack misconfigurations	<p>For information about troubleshooting issues related to Slack misconfigurations, see <a href="#">Troubleshooting AWS Chatbot</a> in the <i>AWS Chatbot Administrator Guide</i>.</p>

Issue	Solution
Scan failed because of some other reason	<p>This error means that the code build task has failed. To troubleshoot the issue, go to the link that's in the message. The failure of the code build task might have the following possible causes:</p> <ul style="list-style-type: none"><li>• The application is not packaged properly. The <code>sonar-scanner</code> command can't find the <code>sonar.project.env.properties</code> file.</li><li>• The values for the <code>SonarFileName</code> , <code>SonarFileDirectory</code> , or <code>SonarToken</code> parameters are incorrect. Check the values, and then execute the stack files again.</li><li>• The Sonar host is not reachable.</li><li>• Other issues that you can use the logs to troubleshoot.</li></ul>

## Related resources

### AWS documentation

- [Configure a Slack client](#)
- [Creating a custom action](#)
- [Creating an email address identity procedure](#)
- [Tutorial: Get started with Slack](#)

### Other resources

- [Add apps to your Slack workspace](#) (Slack documentation)
- [Generating and using tokens](#) (SonarQube documentation)
- [Introduction to the server installation](#) (SonarQube documentation)

## Additional information

This solution emphasizes AWS Chatbot custom actions for release management purposes. However, you can reuse the solution by modifying the Lambda code for your specific use case and build on top of it.

### Parameters of CloudFormation stack files

The following table shows the parameters and their descriptions for the CloudFormation stack file `pre-requisite.yml`.

Key	Description
StackName	The name of the CloudFormation stack.
S3LambdaBucket	The name of the Amazon S3 bucket where you upload the Lambda code. The name must be globally unique.
SonarToken	The SonarQube user token as described in <a href="#">Prerequisites</a> .

The following table shows the parameters and their descriptions for the CloudFormation stack file `app-security.yml`.

Key	Description
CKMSKeyArn	The AWS KMS key Amazon Resource Name (ARN) that is used in IAM roles and Lambda functions created in this stack.
CKMSKeyId	The AWS KMS key ID that is used in the Amazon SNS topic created in this stack.
EnvironmentType	The name of the client environment for deployment of the application scan pipeline. Select the environment name from the dropdown list of allowed values.

S3LambdaBucket	The name of the Amazon S3 bucket that contains the <code>approval.zip</code> and <code>notification.zip</code> files.
SESEmail	The name of the registered email identity in Amazon SES as described in <a href="#">Prerequisites</a> . This identity is the source email address.
SharedInboxMail	The destination email address to which the scan notifications are sent.
SlackChannelId	The channel ID of the Slack channel where you want the notifications sent. To find the channel ID, right-click the channel name in <b>Channel Details</b> on the Slack app. The channel ID is at the bottom.
SlackWorkspaceId	The Slack workspace ID as described in <a href="#">Prerequisites</a> . To find the Slack workspace ID, sign in to the AWS Management Console, open the AWS Chatbot console, and choose <b>Configured clients, Slack, WorkspaceID</b> .
StackName	The name of the CloudFormation stack.
SonarFileDirectory	The directory that contains the <code>sonar.project.&lt;env&gt;.properties</code> file.
SonarFileName	The name of the <code>sonar.project.&lt;env&gt;.properties</code> file.
SourceCodeZip	The name of the <code>.zip</code> file that contains the <code>sonar.project.&lt;env&gt;.properties</code> file and the source code.



# Deploy a firewall using AWS Network Firewall and AWS Transit Gateway

Created by Shrikant Patil (AWS)

**Code repository:** [aws-network-firewall-deployment-with-transit-gateway](#)

**Environment:** PoC or pilot

**Technologies:** DevOps; Networking; Security, identity, compliance

**AWS services:** AWS Network Firewall; AWS Transit Gateway; Amazon VPC; Amazon CloudWatch

## Summary

This pattern shows you how to deploy a firewall by using AWS Network Firewall and AWS Transit Gateway. The Network Firewall resources are deployed by using an AWS CloudFormation template. Network Firewall automatically scales with your network traffic and can support hundreds of thousands of connections, so that you don't have to worry about building and maintaining your own network security infrastructure. A transit gateway is a network transit hub that you can use to interconnect your virtual private clouds (VPCs) and on-premises networks.

In this pattern, you also learn to include an inspection VPC in your network architecture. Finally, this pattern explains how to use Amazon CloudWatch to provide real-time activity monitoring for your firewall.

**Tip:** It's a best practice to avoid using a Network Firewall subnet to deploy other AWS services. This is because Network Firewall can't inspect traffic from sources or destinations within a firewall's subnet.

## Prerequisites and limitations

### Prerequisites

- An active AWS account
- AWS Identity and Access Management (IAM) role and policy permissions

- CloudFormation template permissions

## Limitations

You could have issues with domain filtering and a different kind of configuration could be necessary. For more information, see [Stateful domain list rule groups in AWS Network Firewall](#) in the Network Firewall documentation.

## Architecture

### Technology stack

- Amazon CloudWatch Logs
- Amazon VPC
- AWS Network Firewall
- AWS Transit Gateway

### Target architecture

The following diagram shows how to use Network Firewall and Transit Gateway to inspect your traffic:

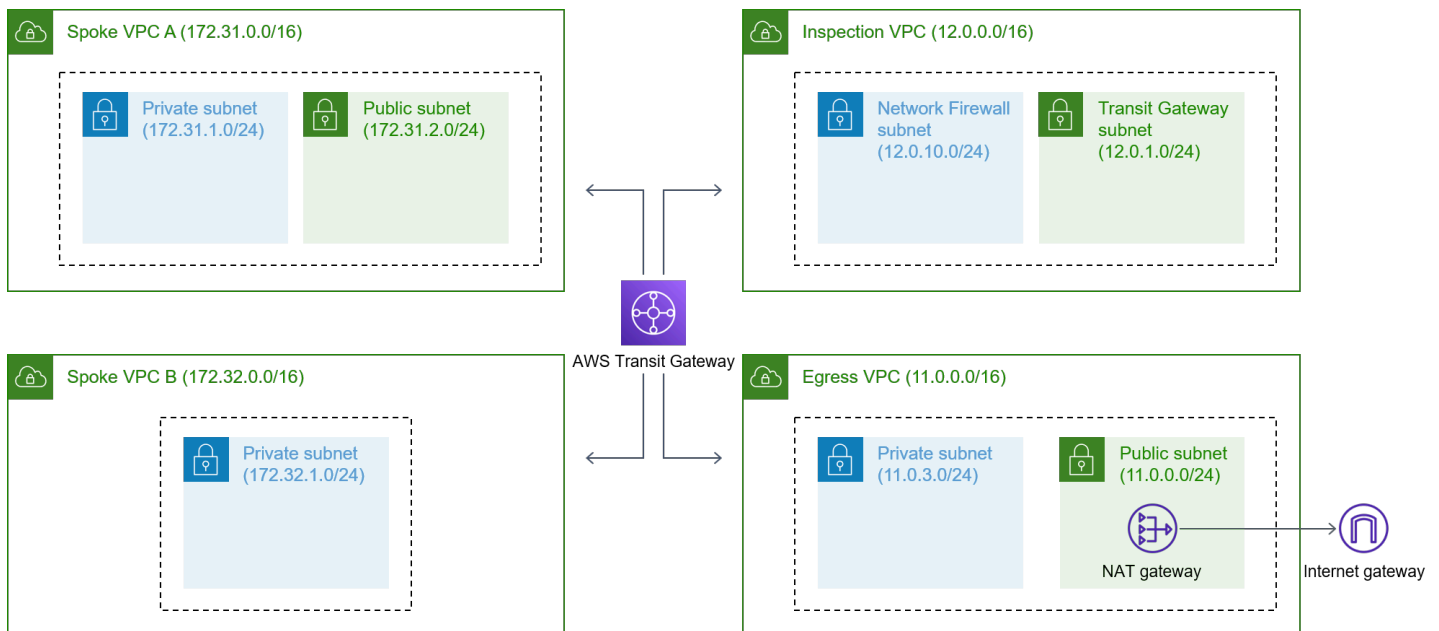

The architecture includes the following components:

- Your application is hosted in the two spoke VPCs. The VPCs are monitored by Network Firewall.
- The egress VPC has direct access to the internet gateway but is not protected by Network Firewall.
- The inspection VPC is where Network Firewall is deployed.

## Automation and scale

You can use [CloudFormation](#) to create this pattern by using [infrastructure as code](#).

## Tools

### AWS services

- [Amazon CloudWatch Logs](#) helps you centralize the logs from all your systems, applications, and AWS services so you can monitor them and archive them securely.
- [Amazon Virtual Private Cloud \(Amazon VPC\)](#) helps you launch AWS resources into a virtual network that you've defined. This virtual network resembles a traditional network that you'd operate in your own data center, with the benefits of using the scalable infrastructure of AWS.
- [AWS Network Firewall](#) is a stateful, managed, network firewall and intrusion detection and prevention service for VPCs in the AWS Cloud.
- [AWS Transit Gateway](#) is a central hub that connects VPCs and on-premises networks.

### Code

The code for this pattern is available in the GitHub [AWS Network Firewall deployment with Transit Gateway](#) repository. You can use the CloudFormation template from this repository to deploy a single inspection VPC that uses Network Firewall.

## Epics

### Create the spoke VPC and inspection VPC

Task	Description	Skills required
Prepare and deploy the CloudFormation template.	1. Download the <code>cloudformation/aws_nw_fw.yml</code>	AWS DevOps

Task	Description	Skills required
	<ol style="list-style-type: none"> <li>1. template from the GitHub <a href="#">repository</a>.</li> <li>2. Update the template with your values.</li> <li>3. Deploy the template.</li> </ol>	

## Create the transit gateway and routes

Task	Description	Skills required
Create a transit gateway.	<ol style="list-style-type: none"> <li>1. Sign in to the AWS Management Console and open the <a href="#">Amazon VPC console</a>.</li> <li>2. On the navigation pane, choose <b>Transit gateways</b>.</li> <li>3. Choose <b>Create transit gateway</b>.</li> <li>4. For <b>Name tag</b>, enter a name for the transit gateway.</li> <li>5. For <b>Description</b>, enter a description for the transit gateway.</li> <li>6. For <b>Amazon side Autonomous System Number (ASN)</b>, leave the default ASN value.</li> <li>7. Select the <b>DNS support</b> option.</li> <li>8. Select the <b>VPN ECMP support</b> option.</li> </ol>	AWS DevOps

Task	Description	Skills required
	<p>9. Select the <b>Default route table association</b> option. This option automatically associates the transit gateway attachments with the default route table for the transit gateway.</p> <p>10 Select the <b>Default route table propagation</b> option. This option automatically propagates the transit gateway attachments to the default route table for the transit gateway.</p> <p>11 Choose <b>Create transit gateway</b>.</p>	
<p>Create transit gateway attachments.</p>	<p><a href="#">Create a transit gateway attachment</a> for the following:</p> <ul style="list-style-type: none"> <li>• An <b>Inspection</b> attachment in the inspection VPC and Transit Gateway subnet</li> <li>• A <b>SpokeVPCA</b> attachment in the spoke VPCA and private subnet</li> <li>• A <b>SpokeVPCB</b> attachment in the spoke VPCB and private subnet</li> <li>• An <b>EgressVPC</b> attachment in the egress VPC and private subnet</li> </ul>	<p>AWS DevOps</p>

Task	Description	Skills required
Create a transit gateway route table.	<ol style="list-style-type: none"><li>1. <a href="#">Create a transit gateway route table</a> for the spoke VPC. This route table must be associated to all the VPCs other than the inspection VPC.</li><li>2. <a href="#">Create a transit gateway route table</a> for the firewall. This route table must be associated to the inspection VPC only.</li><li>3. Add a route to the transit gateway route table for the firewall:<ul style="list-style-type: none"><li>• For <code>0.0.0/0</code>, use the <b>EgressVPC</b> attachment.</li><li>• For the <b>SpokeVPCA</b> CIDR block, use the <b>SpokeVPC1</b> attachment.</li><li>• For the <b>SpokeVPCB</b> CIDR block, use the <b>SpokeVPC2</b> attachment.</li></ul></li><li>4. Add a route to the transit gateway route table for the spoke VPC. For <code>0.0.0/0</code>, use the <b>Inspection VPC</b> attachment.</li></ol>	AWS DevOps

## Create the firewall and routes

Task	Description	Skills required
Create a firewall in the inspection VPC.	<ol style="list-style-type: none"><li>1. Sign in to the AWS Management Console and open the <a href="#">Amazon VPC console</a>.</li><li>2. In the navigation pane, under <b>Network Firewall</b>, choose <b>Firewalls</b>.</li><li>3. Choose <b>Create firewall</b>.</li><li>4. For <b>Name</b>, enter the name that you want to use to identify this firewall. You can't change the name of a firewall after you create it.</li><li>5. For <b>VPC</b>, select your inspection VPC.</li><li>6. For <b>Availability Zone</b> and <b>Subnet</b>, select the zone and firewall subnet that you identified.</li><li>7. In the <b>Associated firewall policy</b> section, choose <b>Associate an existing firewall policy</b>, and then select the firewall policy that you created earlier.</li><li>8. Choose <b>Create firewall</b>.</li></ol>	AWS DevOps
Create a firewall policy.	<ol style="list-style-type: none"><li>1. Sign in to the AWS Management Console and open the <a href="#">Amazon VPC console</a>.</li></ol>	AWS DevOps

Task	Description	Skills required
	<ol style="list-style-type: none"><li>2. In the navigation pane, under <b>Network Firewall</b>, choose <b>Firewall policies</b>.</li><li>3. On the <b>Describe firewall policy</b> page, choose <b>Create firewall policy</b>.</li><li>4. For <b>Name</b>, enter the name that you want to use for the firewall policy. You'll use the name to identify the policy when you associate the policy with your firewall later in this pattern. You can't change the name of a firewall policy after you create it.</li><li>5. Choose <b>Next</b>.</li><li>6. On the <b>Add rule groups</b> page, in the <b>Stateless rule group</b> section, choose <b>Add stateless rule groups</b>.</li><li>7. In the <b>Add from existing rule groups</b> dialog box, select the check box for the stateless rule group that you created earlier. Choose <b>Add rule groups</b>. <b>Note:</b> At the bottom of the page, the firewall policy's capacity counter shows the capacity consumed by adding this rule group next to the maximum capacity</li></ol>	



Task	Description	Skills required
	<p>allowed for a firewall policy.</p> <p>8. Set the stateless default action to <b>Forward to stateful rules</b>.</p> <p>9. In the <b>Stateful rule group</b> section, choose <b>Add stateful rule groups</b>, and then select the check box for the stateful rule group that you created earlier. Choose <b>Add rule groups</b>.</p> <p>10 Choose <b>Next</b> to step through the rest of the setup wizard, and then choose <b>Create firewall policy</b>.</p>	

Task	Description	Skills required
Update your VPC route tables.	<p><b>Inspection VPC route tables</b></p> <ol style="list-style-type: none"><li>1. In the ANF subnet route table (Inspection-ANFRT), add <code>0.0.0/0</code> to the Transit Gateway ID.</li><li>2. In the Transit Gateway subnet route table (Inspection-TGWRT ), add <code>0.0.0/0</code> to the <b>EgressVPC</b>.</li></ol> <p><b>SpokeVPCA route table</b></p> <p>In the private route table, add <code>0.0.0.0/0</code> to the Transit Gateway ID.</p> <p><b>Spoke VPCB route table</b></p> <p>In the private route table, add <code>0.0.0.0/0</code> to the Transit Gateway ID.</p> <p><b>Egress VPC route tables</b></p> <p>In the egress public route table, add the <b>SpokeVPCA</b> and <b>Spoke VPCB</b> CIDR block to the Transit Gateway ID. Repeat the same step for the private subnet.</p>	AWS DevOps

## Set up CloudWatch to perform real-time network inspection

Task	Description	Skills required
Update the firewall's logging configuration.	<ol style="list-style-type: none"><li>1. Sign in to the AWS Management Console and open the <a href="#">Amazon VPC console</a>.</li><li>2. In the navigation pane, under <b>Network Firewall</b>, choose <b>Firewalls</b>.</li><li>3. In the <b>Firewalls</b> page, choose the name of the firewall that you want to edit.</li><li>4. Choose the <b>Firewall details</b> tab. In the <b>Logging</b> section, choose <b>Edit</b>.</li><li>5. Adjust the <b>Log type</b> selections as needed. You can configure logging for alert and flow logs.<ul style="list-style-type: none"><li>• Alert – Sends logs for traffic that matches any stateful rule where the action is set to <b>Alert</b> or <b>Drop</b>. For more information about stateful rules and rule groups, see <a href="#">Rule groups in AWS Network Firewall</a>.</li><li>• Flow – Sends logs for all network traffic that the stateless engine</li></ul></li></ol>	AWS DevOps

Task	Description	Skills required
	<p>forwards to the stateful rules engine.</p> <p>6. For each selected log type, choose the destination type, and then provide the information for the logging destination. For more information, see <a href="#">AWS Network Firewall logging destinations</a> in the Network Firewall documentation.</p> <p>7. Choose <b>Save</b>.</p>	

## Verify the setup

Task	Description	Skills required
Launch an EC2 instance to test the setup.	<a href="#">Launch two Amazon Elastic Compute Cloud (Amazon EC2) instances</a> in the spoke VPC: one for Jumpbox and one for test connectivity.	AWS DevOps
Check the metrics.	Metrics are grouped first by the service namespace and then by the various dimension combinations within each namespace. The CloudWatch namespace for Network Firewall is <code>AWS/NetworkFirewall</code> .	AWS DevOps

Task	Description	Skills required
	<ol style="list-style-type: none"><li data-bbox="592 212 1008 390">1. Sign in to the AWS Management Console and open the <a href="#">CloudWatch console</a>.</li><li data-bbox="592 411 964 493">2. In the navigation pane, choose <b>Metrics</b>.</li><li data-bbox="592 514 1000 690">3. On the <b>All metrics</b> tab, choose the Region, and then choose <b>AWS/NetworkFirewall</b>.</li></ol>	

## Related resources

- [Simple single zone architecture with an internet gateway](#)
- [Multi zone architecture with an internet gateway](#)
- [Architecture with an internet gateway and a NAT gateway](#)

# Deploy an AWS Glue job with an AWS CodePipeline CI/CD pipeline

Created by Bruno Klein (AWS) and Luis Henrique Massao Yamada (AWS)

**Environment:** Production

**Technologies:** DevOps; Big data

**AWS services:** AWS Glue; AWS CodeCommit; AWS CodePipeline; AWS Lambda

## Summary

This pattern demonstrates how you can integrate Amazon Web Services (AWS) CodeCommit and AWS CodePipeline with AWS Glue, and use AWS Lambda to launch jobs as soon as a developer pushes their changes to a remote AWS CodeCommit repository.

When a developer submits a change to an extract, transform, and load (ETL) repository and pushes the changes to AWS CodeCommit, a new pipeline is invoked. The pipeline initiates a Lambda function that launches an AWS Glue job with these changes. The AWS Glue job performs the ETL task.

This solution is helpful in the situation where businesses, developers, and data engineers want to launch jobs as soon as changes are committed and pushed to the target repositories. It helps achieve a higher level of automation and reproducibility, therefore avoiding errors during the job launch and lifecycle.

## Prerequisites and limitations

### Prerequisites

- An active AWS account
- [Git](#) installed on the local machine
- [Amazon Cloud Development Kit \(Amazon CDK\)](#) installed on the local machine
- [Python](#) installed on the local machine
- The code in the *Attachments* section

## Limitations

- The pipeline is finished as soon as the AWS Glue job is successfully launched. It does not wait for the conclusion of the job.
- The code provided in the attachment is intended for demo purposes only.

## Architecture

### Target technology stack

- AWS Glue
- AWS Lambda
- AWS CodePipeline
- AWS CodeCommit

### Target architecture

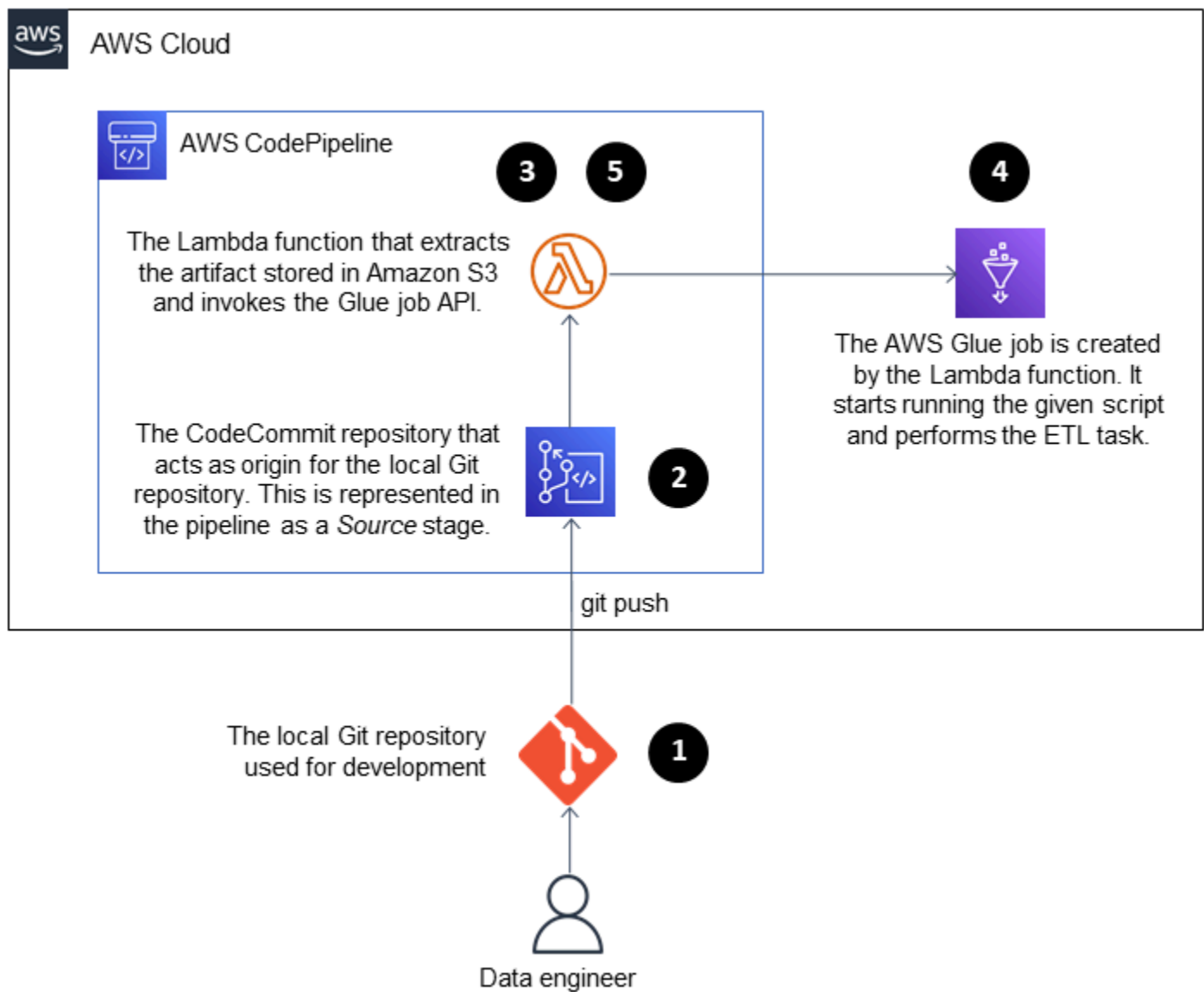

The process consists of these steps:

1. The developer or data engineer makes a modification in the ETL code, commits, and pushes the change to AWS CodeCommit.
2. The push initiates the pipeline.
3. The pipeline initiates a Lambda function, which calls `codecommit:GetFile` on the repository and uploads the file to Amazon Simple Storage Service (Amazon S3).
4. The Lambda function launches a new AWS Glue job with the ETL code.
5. The Lambda function finishes the pipeline.



## Automation and scale

The sample attachment demonstrates how you can integrate AWS Glue with AWS CodePipeline. It provides a baseline example that you can customize or extend for your own use. For details, see the *Epics* section.

## Tools

- [AWS CodePipeline](#) – AWS CodePipeline is a fully managed [continuous delivery](#) service that helps you automate your release pipelines for fast and reliable application and infrastructure updates.
- [AWS CodeCommit](#) – AWS CodeCommit is a fully managed [source control](#) service that hosts secure, Git-based repositories.
- [AWS Lambda](#) – AWS Lambda is a serverless compute service that lets you run code without provisioning or managing servers.
- [AWS Glue](#) – AWS Glue is a serverless data integration service that makes it easy to discover, prepare, and combine data for analytics, machine learning, and application development.
- [Git client](#) – Git provides GUI tools, or you can use the command line or a desktop tool to check out the required artifacts from GitHub.
- [AWS CDK](#) – The AWS CDK is an open source software development framework that helps you define your cloud application resources by using familiar programming languages.

## Epics

### Deploy the sample code

Task	Description	Skills required
Configure the AWS CLI.	Configure the AWS Command Line Interface (AWS CLI) to target and authenticate with your current AWS account. For instructions, see the <a href="#">AWS CLI documentation</a> .	Developer, DevOps engineer
Extract the sample project files.	Extract the files from the attachment to create a folder	Developer, DevOps engineer

Task	Description	Skills required
Deploy the sample code.	<p>that contains the sample project files.</p> <p>After you extract the files, run the following commands from the extract location to create a baseline example:</p> <pre data-bbox="594 554 1029 1031">cdk bootstrap cdk deploy git init git remote add origin &lt;code-commit-repository-url&gt; git stage . git commit -m "adds sample code" git push --set-upstream origin main</pre> <p>After the last command, you can monitor the status of the pipeline and the AWS Glue job.</p>	Developer, DevOps engineer
Customize the code.	Customize the code for the etl.py file in accordance with your business requirements. You can revise the ETL code, modify the pipeline stages, or extend the solution.	Data engineer

## Related resources

- [Getting started with the AWS CDK](#)
- [Adding jobs in AWS Glue](#)

- [Source action integrations in CodePipeline](#)
- [Invoke an AWS Lambda function in a pipeline in CodePipeline](#)
- [AWS Glue programming](#)
- [AWS CodeCommit GetFile API](#)

## Attachments

To access additional content that is associated with this document, unzip the following file:  
[attachment.zip](#)

# Deploy an Amazon EKS cluster from AWS Cloud9 using an EC2 instance profile

Created by Sagar Panigrahi (AWS)

**Environment:** Production

**Technologies:** DevOps;  
Containers & microservices

**Workload:** All other  
workloads

**AWS services:** Amazon EKS;  
AWS Cloud9; AWS Identity  
and Access Management;  
AWS CloudFormation

## Summary

This pattern describes how to use AWS Cloud9 and AWS CloudFormation to create an Amazon Elastic Kubernetes Service (Amazon EKS) cluster that can be operated without enabling programmatic access for users in your Amazon Web Services (AWS) account.

AWS Cloud9 is a cloud-based integrated development environment (IDE) that helps you write, run, and debug your code by using a browser. AWS Cloud9 is used as a control center that provisions an Amazon EKS cluster by using Amazon Elastic Compute Cloud (Amazon EC2) instance profiles and AWS CloudFormation templates.

You can use this pattern if you don't want to create AWS Identity and Access Management (IAM) users and want to use IAM roles instead. Role-based access control (RBAC) regulates access to resources based on the roles of individual users. This pattern demonstrates how to update RBAC within an Amazon EKS cluster to allow access to a specific IAM role.

The pattern's setup also helps your DevOps team use AWS Cloud9 features to maintain and develop infrastructure as code (IaC) resources for creating Amazon EKS infrastructure.

## Prerequisites and limitations

### Prerequisites

- An active AWS account.

- Permissions to create IAM roles and policies for the account. The IAM role for the user must include the `AWSCloud9Administrator` policy. The `AWSServiceRoleForAmazonEKS` and `eksNodeRoles` roles must also be created because they are required to create an Amazon EKS cluster.
- Knowledge of Kubernetes concepts.

## Limitations

- This pattern describes how to create a basic Amazon EKS cluster. For production clusters, you must update the AWS CloudFormation template.
- The pattern doesn't deploy additional Kubernetes components (for example, [Fluentd](#), [ingress controllers](#), or [storage controllers](#)).

## Architecture

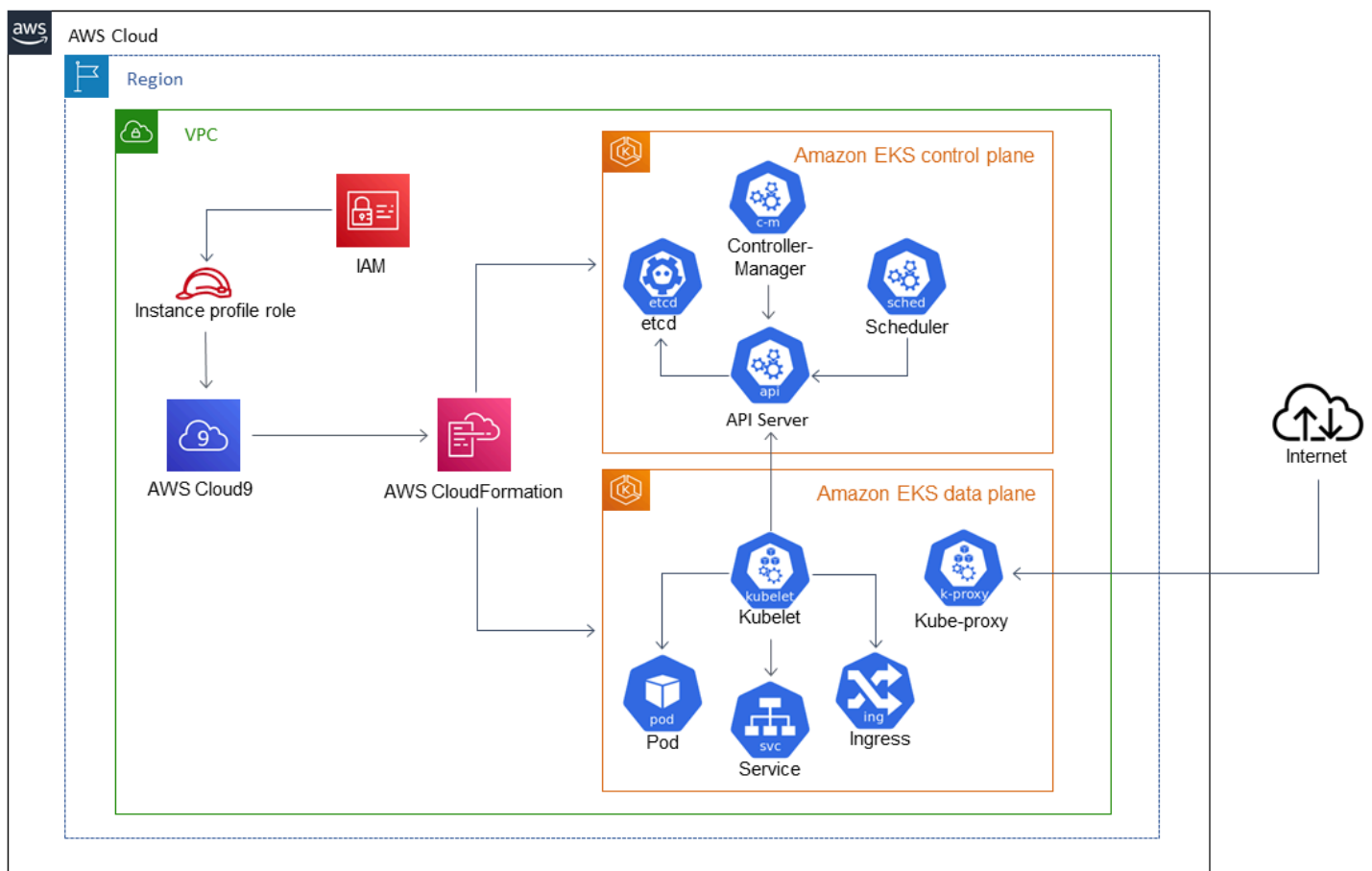

## Technology stack

- AWS Cloud9
- AWS CloudFormation
- Amazon EKS
- IAM

## Automation and scale

You can expand this pattern and incorporate it into continuous integration and continuous deployment (CI/CD) pipelines to automate the complete provisioning of Amazon EKS.

## Tools

- [AWS CloudFormation](#) – AWS CloudFormation helps you model and set up your AWS resources so that you can spend less time managing those resources and more time focusing on your applications.
- [AWS Cloud9](#) – AWS Cloud9 offers a rich code-editing experience with support for several programming languages and runtime debuggers, and a built-in terminal.
- [AWS CLI](#) – AWS Command Line Interface (AWS CLI) is an open-source tool that enables you to interact with AWS services using commands in your command-line shell.
- [Kubect1](#) – `kubect1` is a command line utility that you can use to interact with an Amazon EKS cluster.

## Epics

### Create the IAM roles for the EC2 instance profile

Task	Description	Skills required
Create the IAM policy.	Sign in to the AWS Management Console, open the IAM console, choose <b>Policies</b> , and then choose	Cloud administrator

Task	Description	Skills required
	<p><b>Create policy.</b> Choose the <b>JSON</b> tab and paste the contents from the policy-role-eks-instance-profile-for-cloud9.json file (attached).</p> <p>Resolve any security warnings, errors, or general warnings generated during the policy validation, and then choose <b>Review policy</b>. Enter a <b>Name</b> for the policy. We recommend that you use <code>eks-instance-profile-for-cloud9</code> for the policy name.</p> <p>Review the policy <b>Summary</b> to see the permissions that are granted by your policy. Then choose <b>Create policy</b>.</p>	

Task	Description	Skills required
Create an IAM role using the policy.	<p>On the IAM console, choose <b>Roles</b> and then choose <b>Create role</b>. Choose <b>AWS Service</b> and then choose <b>EC2</b> from the list.</p> <p>Choose <b>Next: Permissions</b> and search for the IAM policy that you created earlier. Choose the appropriate tags for your requirements.</p> <p>In the <b>Review</b> section, enter a name for the role. We recommend that you use <code>role-eks-instance-profile-for-cloud9</code> for the role name. Then choose <b>Create role</b>.</p>	Cloud administrator

## Create an IAM policy and role for the Amazon EKS RBAC

Task	Description	Skills required
Create the IAM policy.	<p>On the IAM console, choose <b>Policies</b> and then choose <b>Create policy</b>. Choose the <b>JSON</b> tab and paste the contents from the <code>policy-for-eks-rbac.json</code> file (attached).</p> <p>Resolve any security warnings, errors, or general warnings generated during the policy validation, and</p>	Cloud administrator



Task	Description	Skills required
	<p>then choose <b>Review policy</b>. Enter a <b>Name</b> for the policy. We recommend that you use <code>policy-for-eks-rbac</code> for the policy name. Review the policy <b>Summary</b> to see the permissions that are granted by your policy. Then choose <b>Create policy</b>.</p>	
<p>Create an IAM role using the policy.</p>	<p>On the IAM console, choose <b>Roles</b> and then choose <b>Create role</b>. Choose <b>AWS Service</b> and then choose <b>EC2</b> from the list. Choose <b>Next: Permissions</b> and search for the IAM policy that you created earlier. Choose the appropriate tags for your requirements.</p> <p>In the <b>Review</b> section, enter a name for the role. We recommend that you use <code>role-eks-admin-for-rbac</code> for the role name. Then choose <b>Create role</b>.</p>	<p>Cloud administrator</p>

## Create the AWS Cloud9 environment

Task	Description	Skills required
<p>Create the AWS Cloud9 environment.</p>	<p>Open the AWS Cloud9 console and choose <b>Create environment</b>. On the <b>Name</b></p>	<p>Cloud administrator</p>

Task	Description	Skills required
	<p><b>environment</b> page, enter a name for your environment. We recommend that you use <code>eks-management-env</code> for the environment name. Configure the remaining settings according to your requirements and then choose <b>Next step</b>.</p> <p>On the <b>Review</b> page, choose <b>Create environment</b>. Wait while AWS Cloud9 creates your environment. This can take several minutes.</p> <p>For more information about the available configuration options, see <a href="#">Creating an EC2 environment</a> in the AWS Cloud9 documentation.</p>	
Remove the temporary IAM credentials for AWS Cloud9.	<p>After your AWS Cloud9 environment is provisioned, choose <b>Settings</b> in the gear icon. Under <b>Preferences</b>, choose <b>AWS settings</b> and then choose <b>Credentials</b>.</p> <p>Turn off <b>AWS managed temporary credentials</b> and close the tab.</p>	Cloud administrator

Task	Description	Skills required
<p>Attach the EC2 instance profile to the underlying EC2 instance.</p>	<p>Open the Amazon EC2 console and choose the EC2 instance that matches your environment in AWS Cloud9. If you used the name that we recommended, the EC2 instance is called <code>aws-cloud9-eks-management-env</code>.</p> <p>Choose the EC2 instance, choose <b>Actions</b>, and then choose <b>Instance settings</b>. Choose <b>Attach/replace IAM role</b>. Search for <code>role-eks-instance-profile-for-cloud9</code> or the name of the IAM role that you created earlier, and then choose <b>Apply</b>.</p>	<p>Cloud administrator</p>

## Create the Amazon EKS cluster

Task	Description	Skills required
<p>Create the Amazon EKS cluster.</p>	<p>Download and open the <code>eks-cfn.yaml</code> (attached) template for AWS CloudFormation. Edit the template according to your requirements.</p> <p>Open the AWS Cloud9 environment and choose <b>New file</b>. Paste the AWS</p>	<p>Cloud administrator</p>

Task	Description	Skills required
	<p>CloudFormation template that you created earlier into the field. We recommend that you use eks-cfn.yaml for the template name.</p> <p>In the AWS Cloud9 terminal, run the following command to create the Amazon EKS cluster:</p> <pre>aws cloudformation create-stack -- stack-name eks-clust er --template-body file://eks-cfn.yam l --region &lt;your_AWS _Region&gt;</pre> <p>If the AWS CloudFormation call is successful, you receive the AWS CloudFormation stack's Amazon Resource Name (ARN) in your output. The stack creation can take between 10 to 20 minutes.</p>	

Task	Description	Skills required
Verify the Amazon EKS cluster's status.	<p>On the AWS CloudFormation console, open the <b>Stacks</b> page and then choose the stack name.</p> <p>The stack is created when the stack status code shows <code>CREATE_COMPLETE</code> . For more information, see <a href="#">Viewing AWS CloudFormation stack data and resources</a> in the AWS CloudFormation documentation.</p>	Cloud administrator

### Access the Kubernetes resources in the Amazon EKS cluster

Task	Description	Skills required
Install kubectl in the AWS Cloud9 environment.	Install kubectl in your AWS Cloud9 environment by following the instructions from <a href="#">Installing kubectl</a> in the Amazon EKS documentation.	Cloud administrator
Update the new Amazon EKS configuration in AWS Cloud9.	<p>Run the following command in the AWS Cloud9 terminal to update the kubeconfig from the Amazon EKS cluster to the AWS Cloud9 environment:</p> <pre>aws eks update-kubeconfig --name EKS-DEV2 --region &lt;your_AWS_Region&gt;</pre>	Cloud administrator

Task	Description	Skills required
	<p><b>Important:</b> EKS-DEV2 is the name of the Amazon EKS cluster in the AWS CloudFormation template that you used to create the cluster.</p> <p>Run the <code>kubectl get all -A</code> command to view all Kubernetes resources.</p>	

Task	Description	Skills required
Add the administrator IAM role to the Kubernetes RBAC.	<p>Run the following command in your AWS Cloud9 terminal to open the RBAC configuration map for Amazon EKS in edit mode:</p> <pre>kubectl edit cm/aws-auth -n kube-system</pre> <p>Append the following lines under the mapRoles section:</p> <pre>- groups: - system:masters rolearn: &lt;ARN_of_IAM_role_from_second_epic&gt; username: eksadmin</pre> <p>Lint the YAML-formatted file to avoid syntax errors. Save the file using <code>vi</code> commands and then exit the file.</p> <p><b>Note:</b> By adding this section, you inform the Kubernetes RBAC that <code>&lt;ARN_of_IAM_role_from_second_epic&gt;</code> is to receive full administrator access on the Amazon EKS cluster. This means that the identified IAM role can carry out administrative actions on the Kubernetes cluster. AWS adds the existing section under</p>	Cloud administrator

Task	Description	Skills required
	mapRoles while the Amazon EKS cluster is provisioned.	

## Related resources

### References

- [Modular and scalable Amazon EKS architecture \(Quick Start\)](#)
- [Managing users or IAM roles for your Amazon EKS cluster](#)
- [AWS CloudFormation template to create a new Amazon EKS control plane](#)

## Attachments

To access additional content that is associated with this document, unzip the following file: [attachment.zip](#)



# Deploy code in multiple AWS Regions using AWS CodePipeline, AWS CodeCommit, and AWS CodeBuild

Created by Anand Krishna Varanasi (AWS)

**Created by:** AWS

**Environment:** PoC or pilot

**Technologies:** Management & governance; DevOps

**AWS services:** AWS CodeCommit; AWS CodePipeline; AWS CodeBuild

## Summary

This pattern demonstrates how to build infrastructure or architecture across multiple Amazon Web Services (AWS) Regions by using AWS CloudFormation. It includes continuous integration (CI)/continuous deployment (CD) across multiple AWS Regions for faster deployments. The steps in this pattern have been tested for the creation of an AWS CodePipeline job to deploy to three AWS Regions as an example. You can change the number of Regions based on your use case.

## Prerequisites and limitations

### Prerequisites

- An active AWS account.
- Two AWS Identity and Access Management (IAM) roles for AWS CodeBuild and AWS CloudFormation with proper policies for CodeBuild to perform the CI tasks of testing, bundling, packaging the artifacts, and deploying to multiple AWS Regions in parallel. **Note:** Cross-check the policies created by CodePipeline to verify that CodeBuild and AWS CloudFormation have proper permissions in the CI and CD phases.
- A CodeBuild role with the *AmazonS3FullAccess* and *CloudWatchFullAccess* policies. These policies give CodeBuild access to watch events of AWS CodeCommit through Amazon CloudWatch and to use Amazon Simple Storage Service (Amazon S3) as an artifact store.

- An AWS CloudFormation role with the following policies, which give AWS CloudFormation, in the final Build stage, the ability to create or update AWS Lambda functions, push or watch Amazon CloudWatch logs, and to create and update change sets.
  - *AWSLambdaFullAccess*
  - *AWSCodeDeployFullAccess*
  - *CloudWatchFullAccess*
  - *AWSCloudFormationFullAccess*
  - *AWSCodePipelineFullAccess*

## Architecture

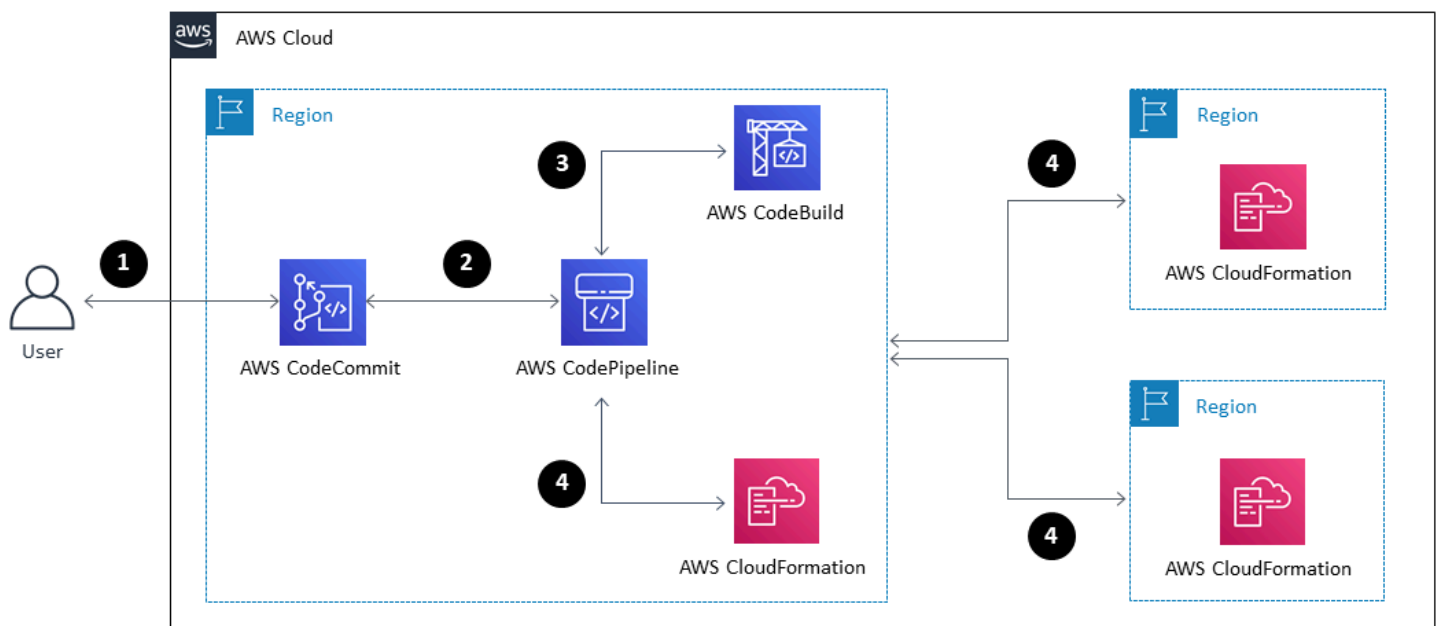

This pattern's multiple-Region architecture and workflow comprise the following steps.

1. You send your code to a CodeCommit repository.
2. Upon receiving any code update or commit, CodeCommit invokes a CloudWatch event, which in turn starts a CodePipeline job.
3. CodePipeline engages the CI that is handled by CodeBuild. The following tasks are performed.
  - Testing of the AWS CloudFormation templates (optional)
  - Packaging of the AWS CloudFormation templates for each Region included in the deployment. For example, this pattern deploys in parallel to three AWS Regions, so CodeBuild packages the

AWS CloudFormation templates into three S3 buckets, one in each specified Region. The S3 buckets are used by CodeBuild as artifact repositories only.

4. CodeBuild packages the artifacts as input for next Deploy phase, which runs in parallel in the three AWS Regions. If you specify a different number of Regions, CodePipeline will deploy to those Regions.

## Tools

### Tools

- [AWS CodePipeline](#) – CodePipeline is a continuous delivery service you can use to model, visualize, and automate the steps required to release your software changes continuously.
- [AWS CodeBuild](#) – CodeBuild is a fully managed build service that compiles your source code, runs unit tests, and produces artifacts that are ready to deploy.
- [AWS CodeCommit](#) – CodeCommit is a version control service hosted by Amazon Web Services that you can use to privately store and manage assets (such as source code and binary files) in the cloud.
- [AWS CloudFormation](#) – AWS CloudFormation is a service that helps you model and set up your Amazon Web Services resources so that you can spend less time managing those resources and more time focusing on your applications that run in AWS.
- [AWS Identity and Access Management](#) – AWS Identity and Access Management (IAM) is a web service that helps you securely control access to AWS resources.
- [Amazon S3](#) – Amazon Simple Storage Service (Amazon S3) is storage for the internet. It is designed to make web-scale computing easier for developers.

### Code

The following sample code is for the `BuildSpec.yaml` file (Build phase).

```
---
artifacts:
  discard-paths: true
files:
  - packaged-first-region.yaml
  - packaged-second-region.yaml
  - packaged-third-region.yaml
```

```

phases:
build:
commands:
- echo "*****BUILD PHASE - CF PACKAGING*****"
- "aws cloudformation package --template-file sam-template.yaml --s3-bucket
  $S3_FIRST_REGION --output-template-file packaged-first-region.yaml --region
  $FIRST_REGION"
- "aws cloudformation package --template-file sam-template.yaml --s3-bucket
  $S3_SECOND_REGION --output-template-file packaged-second-region.yaml --region
  $SECOND_REGION"
- "aws cloudformation package --template-file sam-template-anand.yaml --s3-bucket
  $S3_THIRD_REGION --output-template-file packaged-third-region.yaml --region
  $THIRD_REGION"
install:
commands:
- echo "*****BUILD PHASE - PYTHON SETUP*****"
runtime-versions:
python: 3.8
post_build:
commands:
- echo "*****BUILD PHASE - PACKAGING COMPLETION*****"
pre_build:
commands:
- echo "*****BUILD PHASE - DEPENDENCY SETUP*****"
- "npm install --silent --no-progress"
- echo "*****BUILD PHASE - DEPENDENCY SETUP DONE*****"
version: 0.2

```

## Epics

### Prepare the code and the CodeCommit repository

Task	Description	Skills required
Select the primary AWS Region for the deployment.	Sign in to your AWS account and choose the primary Region for the deployment. The CodeCommit repository will be in the primary Region.	DevOps
Create the CodeCommit repository.	Create the CodeCommit repository, and push the	DevOps

Task	Description	Skills required
	required code into it. The code generally includes the AWS CloudFormation or AWS SAM templates, Lambda code if any, and the CodeBuild <code>buildspec.yaml</code> files as input to the AWS CodePipeline.	
Push the code into the CodeCommit repository.	In the <i>Attachments</i> section, download the code for this example, and then push the required code into it. Generally, the code can include AWS CloudFormation or AWS SAM templates, Lambda code and the CodeBuild <code>buildspec.yaml</code> files as input to the pipeline.	DevOps

### Source phase: Create the pipeline

Task	Description	Skills required
Create the CodePipeline job.	On the CodePipeline console, choose <b>Create pipeline</b> .	DevOps
Name the CodePipeline job and choose the service role setting.	Enter a name for the job, and keep the default service role setting so that CodePipeline creates the role with the necessary policies attached.	DevOps

Task	Description	Skills required
Specify the location for the artifact store.	Under <b>Advanced settings</b> , keep the default option so that CodePipeline creates an S3 bucket to use for code artifact storage. If you use an existing S3 bucket instead, the bucket must be in the primary Region that you specified in the first epic.	DevOps
Specify the encryption key.	Keep the default option, <b>Default AWS Managed Key</b> , or choose to use your own AWS Key Management Service (AWS KMS) customer managed key.	DevOps
Specify the source provider.	Under <b>Source provider</b> , choose <b>AWS CodeCommit</b> .	DevOps
Specify the repository.	Choose the CodeCommit repository that you created in the first epic. If you placed the code in a branch, choose the branch.	DevOps
Specify how code changes are detected.	Keep the default, <b>Amazon CloudWatch Events</b> , as the change trigger for CodeCommit to start the CodePipeline job.	DevOps

## Build phase: Configure the pipeline

Task	Description	Skills required
Specify the build provider.	For the build provider, choose <b>AWS CodeBuild</b> .	DevOps
Specify the AWS Region.	Choose the primary Region, which you specified in the first epic.	DevOps

## Build phase: Create and configure the project

Task	Description	Skills required
Create the project	Choose <b>Create project</b> , and enter a name for the project.	DevOps
Specify the environment image.	For this pattern demonstration, use the default CodeBuild managed image. You also have the option to use a custom Docker image if you have one.	DevOps
Specify the operating system.	Choose either Amazon Linux 2 or Ubuntu.  <b>Note:</b> Amazon Linux 2 is nearing end of support. For more information, see the <a href="#">Amazon Linux 2 FAQs</a> .	DevOps
Specify the service role.	Choose the role you created for CodeBuild before you started to create the	DevOps

Task	Description	Skills required
	CodePipeline job. (See the <i>Prerequisites</i> section.)	
Set additional options.	For <b>Timeout</b> and <b>Queued timeout</b> , keep the default values. For certificate, keep the default setting unless you have a custom certificate that you want to use.	DevOps
Create the environment variables.	For each AWS Region that you want to deploy to, create environment variables by providing the S3 bucket name and the Region name (for example, us-east-1).	DevOps
Provide the buildspec file name, if it is not buildspec.yml.	Keep this field blank if the file name is the default, <code>buildspec.yaml</code> . If you renamed the buildspec file, enter the name here. Make sure it matches the name of the file that is in the CodeCommit repository.	DevOps
Specify logging.	To see logs for Amazon CloudWatch Events, keep the default setting. Or you can define any specific group or logger names.	DevOps



## Skip the Deploy phase

Task	Description	Skills required
Skip the deploy phase and complete the creation of the pipeline.	When you set up the pipeline, CodePipeline allows you to create only one stage in the Deploy phase. To deploy to multiple AWS Regions, skip this phase. After the pipeline is created, you can add multiple Deploy phase stages.	DevOps

## Deploy phase: Configure the pipeline for deployment to the first Region

Task	Description	Skills required
Add a stage to the Deploy phase.	Edit the pipeline and choose <b>Add stage</b> in the Deploy phase. This first stage is for the primary Region.	DevOps
Provide an action name for the stage.	Enter a unique name that reflects the first (primary) stage and Region. For example, enter <b>primary_&lt;region&gt;_deploy</b> .	DevOps
Specify the action provider.	For <b>Action provider</b> , choose AWS CloudFormation.	DevOps
Configure the Region for the first stage.	Choose the first (primary) Region, the same Region where CodePipeline and CodeBuild are set up. This is	DevOps

Task	Description	Skills required
	the primary Region where you want to deploy the stack.	
Specify the input artifact.	Choose <b>BuildArtifact</b> . This is the output of the build phase.	DevOps
Specify the action to take.	For <b>Action mode</b> , choose <b>Create or update a stack</b> .	DevOps
Enter a name for the CloudFormation stack.		DevOps
Specify the template for the first Region.	Select the Region-specific package name that was packaged by CodeBuild and dumped into the S3 bucket for the first (primary) Region.	DevOps
Specify the capabilities.	Capabilities are required if the stack template includes IAM resources or if you create a stack directly from a template that contains macros. For this pattern, use <code>CAPABILITY_IAM</code> , <code>CAPABILITY_NAMED_IAM</code> , <code>CAPABILITY_AUTO_EXPAND</code> .	DevOps

### Deploy phase: Configure the pipeline for deployment to the second Region

Task	Description	Skills required
Add the second stage to the Deploy phase.	To add a stage for the second Region, edit the pipeline and choose <b>Add stage</b> in the Deploy phase. Important: The process of creating the	DevOps

Task	Description	Skills required
	second Region is the same as that of the first Region, except for the following values.	
Provide an action name for the second stage.	Enter a unique name that reflects the second stage and the second Region.	DevOps
Configure the Region for the second stage.	Choose the second Region where you want to deploy the stack.	DevOps
Specify the template for the second Region.	Select the Region-specific package name that was packaged by CodeBuild and dumped into the S3 bucket for the second Region.	DevOps

### Deploy phase: Configure the pipeline for deployment to the third Region

Task	Description	Skills required
Add the third stage to the Deploy phase.	To add a stage for the third Region, edit the pipeline and choose <b>Add stage</b> in the Deploy phase. Important : The process of creating the second Region is the same as that of the previous two Regions, except for the following values.	DevOps

Task	Description	Skills required
Provide an action name for the third stage.	Enter a unique name that reflects the third stage and the third Region.	DevOps
Configure the Region for the third stage.	Choose the third Region where you want to deploy the stack.	DevOps
Specify the template for the third Region.	Select the Region-specific package name that was packaged by CodeBuild and dumped into the S3 bucket for the third Region.	DevOps

## Clean up the deployment

Task	Description	Skills required
Delete the AWS resources.	To clean up the deployment, delete the CloudFormation stacks in each Region. Then delete the CodeCommit, CodeBuild, and CodePipeline resources from the primary Region.	DevOps

## Related resources

- [What is AWS CodePipeline?](#)
- [AWS Serverless Application Model](#)
- [AWS CloudFormation](#)
- [AWS CloudFormation architecture structure reference for AWS CodePipeline](#)

## Attachments

To access additional content that is associated with this document, unzip the following file:

[attachment.zip](#)

# Execute Amazon Redshift SQL queries by using Terraform

Created by Sylvia Qi (AWS) and Aditya Ambati (AWS)

<b>Code repository:</b> <a href="#">terraform-execute-redshift-sql</a>	<b>Environment:</b> PoC or pilot	<b>Technologies:</b> DevOps; Analytics; Big data; Data lakes
<b>Workload:</b> Open-source	<b>AWS services:</b> Amazon Redshift; AWS CLI	

## Summary

Using infrastructure as code (IaC) for the deployment and management of Amazon Redshift is a prevalent practice within DevOps. IaC facilitates the deployment and configuration of various Amazon Redshift resources, such as clusters, snapshots, and parameter groups. However, IaC doesn't extend to the management of database resources like tables, schemas, views, and stored procedures. These database elements are managed through SQL queries and are not directly supported by IaC tools. Although solutions and tools exist for managing these resources, you might prefer not to introduce additional tools into your technology stack.

This pattern outlines a methodology that uses Terraform to deploy Amazon Redshift database resources, including tables, schemas, views, and stored procedures. The pattern distinguishes between two types of SQL queries:

- **Nonrepeatable queries** – These queries are executed once during the initial Amazon Redshift deployment to establish the essential database components.
- **Repeatable queries** – These queries are immutable and can be rerun without impacting the database. The solution uses Terraform to monitor changes in repeatable queries and apply them accordingly.

For more details, see *Solution walkthrough* in [Additional information](#).

## Prerequisites and limitations

### Prerequisites

You must have an active AWS account and install the following on your deployment machine:

- [AWS Command Line Interface](#) (AWS CLI)
- An [AWS CLI profile](#) configured with Amazon Redshift read/write permissions
- [Terraform](#) version 1.6.2 or later
- [Python3](#)
- [Boto3](#)

## Limitations

- This solution supports a single Amazon Redshift database because Terraform only allows for the creation of one database during cluster creation.
- This pattern doesn't include tests to validate changes to the repeatable queries before applying them. We recommend that you incorporate such tests for enhanced reliability.
- To illustrate the solution, this pattern provides a sample `redshift.tf` file that uses a local Terraform state file. However, for production environments, we strongly recommend that you employ a remote state file with a locking mechanism for enhanced stability and collaboration.
- Some AWS services aren't available in all AWS Regions. For Region availability, see [AWS services by Region](#). For specific endpoints, see [Service endpoints and quotas](#), and choose the link for the service.

## Product versions

This solution is developed and tested on [Amazon Redshift patch 179](#).

## Code repository

The code for this pattern is available in the GitHub [amazon-redshift-sql-deploy-terraform](#) repository.

## Architecture

The following diagram illustrates how Terraform manages the Amazon Redshift database resources by handling both nonrepeatable and repeatable SQL queries.

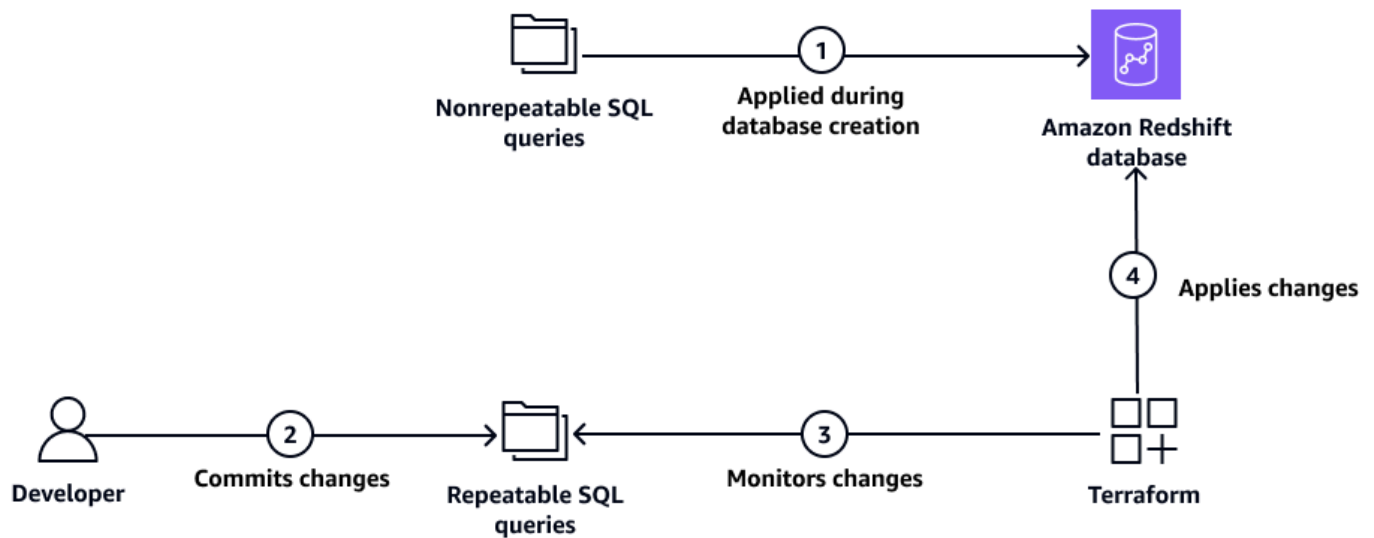

The diagram shows the following steps:

1. Terraform applies nonrepeatable SQL queries during the initial Amazon Redshift cluster deployment.
2. The developer commits changes to the repeatable SQL queries.
3. Terraform monitors changes in the repeatable SQL queries.
4. Terraform applies repeatable SQL queries to the Amazon Redshift database.

The solution provided by this pattern is built based on the [Terraform module for Amazon Redshift](#). The Terraform module provisions an Amazon Redshift cluster and database. To enhance the module, we used `terraform_data` resources, which invokes a custom Python script to execute SQL queries using the Amazon Redshift [ExecuteStatement](#) API operation. As a result, the module can do the following:

- Deploy any number of database resources by using SQL queries after the database is provisioned.
- Monitor continuously for changes in the repeatable SQL queries and apply those changes using Terraform.

For more details, see *Solution walkthrough* in [Additional information](#).

## Tools

### AWS services



- [Amazon Redshift](#) is a fully managed petabyte-scale data warehouse service in the AWS Cloud.

## Other tools

- [Terraform](#) is an infrastructure as code (IaC) tool from HashiCorp that helps you create and manage cloud and on-premises resources.
- [Python](#) is a general-purpose programming language that's used in this pattern to execute SQL queries.

## Best practices

- [Amazon Redshift best practices](#)
- [Using the Amazon Redshift Data API to interact with Amazon Redshift clusters](#)

## Epics

### Deploy the solution using Terraform

Task	Description	Skills required
<b>Clone the repository.</b>	<p>To clone the Git repository containing the Terraform code for provisioning an Amazon Redshift cluster, use the following command.</p> <pre>git clone https://github.com/aws-samples/amazon-redshift-sql-deploy-terraform.git</pre>	DevOps engineer
<b>Update the Terraform variables.</b>	To customize the Amazon Redshift cluster deployment according to your specific requirements, update the	DevOps engineer

Task	Description	Skills required
	<p>following parameters in the terraform.tfvars file.</p> <pre data-bbox="597 331 1026 1856"> region   = "&lt;AWS_REGION&gt;" cluster_identifier   = "&lt;REDSHIFT_CLUSTER_IDENTIFIER&gt;" node_type   = "&lt;REDSHIFT_NODE_TYPE&gt;" number_of_nodes   = "&lt;REDSHIFT_NODE_COUNT&gt;" database_name   = "&lt;REDSHIFT_DB_NAME&gt;" subnet_ids   = "&lt;REDSHIFT_SUBNET_IDS&gt;" vpc_security_group_ids   = "&lt;REDSHIFT_SECURITY_GROUP_IDS&gt;" run_nonrepeatable_queries = true run_repeatable_queries   = true sql_path_bootstrap   = "&lt;BOOTSTRAP_SQLS_PATH&gt;" sql_path_nonrepeatable   = "&lt;NON-REPEATABLE_SQLS_PATH&gt;" sql_path_repeatable   = "&lt;REPEATABLE_SQLS_PATH&gt;" sql_path_finalize   = "&lt;FINALIZE_SQLS_PATH&gt;" </pre>	

Task	Description	Skills required
	<pre>create_random_password   = false master_username   = "&lt;REDSHIFT_MASTER_USERNAME&gt;"</pre>	
Deploy the resources using Terraform.	<ol style="list-style-type: none"><li data-bbox="594 464 1024 688">1. To prepare for the deployment process, use the following command to initialize Terraform within the cloned repository. <pre>terraform init</pre></li><li data-bbox="594 821 1024 1045">2. To preview the changes that Terraform will apply to the infrastructure, use the following command to create an execution plan. <pre>terraform plan -var-file terraform.tfvars</pre></li><li data-bbox="594 1220 1024 1486">3. To provision the Amazon Redshift cluster and associated resources, use the following command to apply the Terraform execution plan. <pre>terraform apply -var-file terraform.tfvars</pre></li></ol>	DevOps engineer

Task	Description	Skills required
(Optional) Execute additional SQL queries.	<p>The sample repository provides several SQL queries for demo purposes. To execute your own SQL queries, add them to the following folders:</p> <pre>/bootstrap</pre> <pre>/nonrepeatable</pre> <pre>/repeatable</pre> <pre>/finalize</pre>	

## Monitor the execution of SQL statements

Task	Description	Skills required
Monitor the deployment of SQL statements.	<p>You can monitor the results of the SQL executions to an Amazon Redshift cluster. For examples of output that show a failed and a successful SQL execution, see <i>Example SQL statements</i> in <a href="#">Additional information</a>.</p>	DBA, DevOps engineer
Clean up resources.	<p>To delete all the resources deployed by Terraform, run the following command.</p> <pre>terraform destroy</pre>	DevOps engineer

## Validate the results

Task	Description	Skills required
Validate the data in the Amazon Redshift cluster.	<ol style="list-style-type: none"><li>1. Sign in to the AWS Management Console, and open the Amazon Redshift console.</li><li>2. On the navigation menu, choose <b>Clusters</b>. Choose the relevant cluster name in the list.</li><li>3. Follow the instructions in <a href="#">Querying a database using the Amazon Redshift query editor v2</a> in the Amazon Redshift documentation.</li></ol>	DBA, AWS DevOps

## Related resources

### AWS documentation

- [Amazon Redshift provisioned clusters](#)
- [Troubleshooting issues for Amazon Redshift Data API](#)

### Other resources

- [Command: apply](#) (Terraform documentation)

## Additional information

### Solution walkthrough

To use the solution, you must organize your Amazon Redshift SQL queries in a specific way. All SQL queries must be stored in files with a `.sql` extension.

In the code example provided with this pattern, the SQL queries are organized in the following folder structure. You can modify the code (`sql-queries.tf` and `sql-queries.py`) to work with any structure that fits your unique use case.

```
/bootstrap
  |- Any # of files
  |- Any # of sub-folders
/nonrepeatable
  |- Any # of files
  |- Any # of sub-folders
/repeatable
  /udf
    |- Any # of files
    |- Any # of sub-folders
  /table
    |- Any # of files
    |- Any # of sub-folders
  /view
    |- Any # of files
    |- Any # of sub-folders
  /stored-procedure
    |- Any # of files
    |- Any # of sub-folders
/finalize
  |- Any # of files
  |- Any # of sub-folders
```

Given the preceding folder structure, during Amazon Redshift cluster deployment, Terraform executes the queries in the following order:

1. `/bootstrap`
2. `/nonrepeatable`
3. `/repeatable`
4. `/finalize`

The `/repeatable` folder contains four subfolders: `/udf`, `/table`, `/view`, and `/stored-procedure`. These subfolders indicate the order in which Terraform executes the SQL queries.

The Python script that executes the SQL queries is `sql-queries.py`. First, the script reads all the files and subfolders of a specific source directory, for example, the `sql_path_bootstrap`

parameter. Then the script executes the queries by calling the Amazon Redshift [ExecuteStatement](#) API operation. You might have one or more SQL queries in a file. The following code snippet shows the Python function that executes SQL statements stored in a file against an Amazon Redshift cluster.

```
def execute_sql_statement(filename, cluster_id, db_name, secret_arn, aws_region):
    """Execute SQL statements in a file"""
    redshift_client = boto3.client(
        'redshift-data', region_name=aws_region)
    contents = get_contents_from_file(filename),
    response = redshift_client.execute_statement(
        Sql=contents[0],
        ClusterIdentifier=cluster_id,
        Database=db_name,
        WithEvent=True,
        StatementName=filename,
        SecretArn=secret_arn
    )
    ...
```

The Terraform script `sql-queries.tf` creates the [terraform\\_data](#) resources that invoke the `sql-queries.py` script. There is a `terraform_data` resource for each of the four folders: `/bootstrap`, `/nonrepeatable`, `/repeatable`, and `/finalize`. The following code snippet shows the `terraform_data` resource that execute the SQL queries in the `/bootstrap` folder.

```
locals {
    program          = "${path.module}/sql-queries.py"
    redshift_cluster_name = try(aws_redshift_cluster.this[0].id, null)
}

resource "terraform_data" "run_bootstrap_queries" {
    count          = var.create && var.run_nonrepeatable_queries && (var.sql_path_bootstrap != "" ) && (var.snapshot_identifier == null) ? 1 : 0
    depends_on    = [aws_redshift_cluster.this[0]]

    provisioner "local-exec" {
        command = "python3 ${local.program} ${var.sql_path_bootstrap}
${local.redshift_cluster_name} ${var.database_name} ${var.redshift_secret_arn}
${local.aws_region}"
    }
}
```

You can control whether to run these queries by using the following variables. If you don't want to run queries in `sql_path_bootstrap`, `sql_path_nonrepeatable`, `sql_path_repeatable`, or `sql_path_finalize`, set their values to `""`.

```
run_nonrepeatable_queries = true
run_repeatable_queries    = true
sql_path_bootstrap        = "src/redshift/bootstrap"
sql_path_nonrepeatable    = "src/redshift/nonrepeatable"
sql_path_repeatable       = "src/redshift/repeatable"
sql_path_finalize         = "src/redshift/finalize"
```

When you run `terraform apply`, Terraform considers the `terraform_data` resource added after the script is completed, regardless of the results of the script. If some SQL queries failed, and you want to rerun them, you can manually remove the resource from the Terraform state, and run `terraform apply` again. For example, the following command removes the `run_bootstrap_queries` resource from the Terraform state.

```
terraform state rm module.redshift.terraform_data.run_bootstrap_queries[0]
```

The following code example shows how the `run_repeatable_queries` resource monitors changes in the `repeatable` folder by using the [sha256 hash](#). If any file within the folder is updated, Terraform marks the entire directory for an update. Then, Terraform runs the queries in the directory again during the next `terraform apply`.

```
resource "terraform_data" "run_repeatable_queries" {
  count          = var.create_redshift && var.run_repeatable_queries &&
    (var.sql_path_repeatable != "") ? 1 : 0
  depends_on    = [terraform_data.run_nonrepeatable_queries]

  # Continuously monitor and apply changes in the repeatable folder
  triggers_replace = {
    dir_sha256 = sha256(join("", [for f in fileset("${var.sql_path_repeatable}",
    "***") : filesha256("${var.sql_path_repeatable}/${f}")]))
  }

  provisioner "local-exec" {
    command = "python3 ${local.sql_queries} ${var.sql_path_repeatable}
    ${local.redshift_cluster_name} ${var.database_name} ${var.redshift_secret_arn}"
  }
}
```



To refine the code, you can implement a mechanism to detect and apply changes only to the files that have been updated within the `repeatable` folder, rather than applying changes to all files indiscriminately.

## Example SQL statements

The following output shows a failed SQL execution, along with an error message.

```
module.redshift.terraform_data.run_nonrepeatable_queries[0] (local-exec): Executing:
  ["/bin/sh" "-c" "python3 modules/redshift/sql-queries.py src/redshift/nonrepeatable
  testcluster-1 db1 arn:aws:secretsmanager:us-east-1:XXXXXXXXXXXX:secret:/redshift/
  master_user/password-8RapGH us-east-1"]
module.redshift.terraform_data.run_nonrepeatable_queries[0] (local-exec):
  -----
module.redshift.terraform_data.run_nonrepeatable_queries[0] (local-exec): src/redshift/
  nonrepeatable/table/admin/admin.application_family.sql
module.redshift.terraform_data.run_nonrepeatable_queries[0] (local-exec):
  -----
module.redshift.terraform_data.run_nonrepeatable_queries[0] (local-exec): Status:
  FAILED
module.redshift.terraform_data.run_nonrepeatable_queries[0] (local-exec): SQL execution
  failed.
module.redshift.terraform_data.run_nonrepeatable_queries[0] (local-exec): Error
  message: ERROR: syntax error at or near ")"
module.redshift.terraform_data.run_nonrepeatable_queries[0] (local-exec): Position:
  244
module.redshift.terraform_data.run_nonrepeatable_queries[0]: Creation complete after 3s
  [id=ee50ba6c-11ae-5b64-7e2f-86fd8caa8b76]
```

The following output shows a successful SQL execution.

```
module.redshift.terraform_data.run_bootstrap_queries[0]: Provisioning with 'local-
  exec' ...
module.redshift.terraform_data.run_bootstrap_queries[0] (local-exec): Executing:
  ["/bin/sh" "-c" "python3 modules/redshift/sql-queries.py src/redshift/bootstrap
  testcluster-1 db1 arn:aws:secretsmanager:us-east-1:XXXXXXXXXXXX:secret:/redshift/
  master_user/password-8RapGH us-east-1"]
module.redshift.terraform_data.run_bootstrap_queries[0] (local-exec):
  -----
module.redshift.terraform_data.run_bootstrap_queries[0] (local-exec): src/redshift/
  bootstrap/db.sql
module.redshift.terraform_data.run_bootstrap_queries[0] (local-exec):
  -----
```

```
module.redshift.terraform_data.run_bootstrap_queries[0] (local-exec): Status: FINISHED
module.redshift.terraform_data.run_bootstrap_queries[0] (local-exec): SQL execution
  successful.
module.redshift.terraform_data.run_bootstrap_queries[0]: Creation complete after 2s
[id=d565ef6d-be86-8afd-8e90-111e5ea4a1be]
```

# Export AWS Backup reports from across an organization in AWS Organizations as a CSV file

Created by Aromal Raj Jayarajan (AWS) and Purushotham G K (AWS)

**Code repository:** [aws-backup-p-report-generator](#)

**Environment:** PoC or pilot

**Technologies:** DevOps; Infrastructure

**AWS services:** AWS Backup; AWS Identity and Access Management; AWS Lambda; Amazon S3; Amazon EventBridge

## Summary

This pattern shows how to export AWS Backup job reports from across an organization in AWS Organizations as a CSV file. The solution uses AWS Lambda and Amazon EventBridge to categorize AWS Backup job reports based on their status, which can help when configuring status-based automations.

AWS Backup helps organizations centrally manage and automate data protection across AWS services, in the cloud, and on premises. However, for AWS Backup jobs configured within AWS Organizations, consolidated reporting is available only in the AWS Management Console of each organization's management account. Bringing this reporting outside of the management account can reduce the effort required for auditing and increase the scope for automations, notifications, and alerting.

## Prerequisites and limitations

### Prerequisites

- An active AWS account
- An active [organization](#) in AWS Organizations that includes at least a management account and a member account

- AWS Backup configured at the organization level in AWS Organizations (for more information, see [Automate centralized backup at scale across AWS services using AWS Backup](#) on the AWS Blog)
- [Git](#), installed and configured on your local machine

## Limitations

The solution provided in this pattern identifies AWS resources that are configured for AWS Backup jobs only. The report can't identify AWS resources that aren't configured for backup through AWS Backup.

## Architecture

### Target technology stack

- AWS Backup
- AWS CloudFormation
- Amazon EventBridge
- AWS Lambda
- AWS Security Token Service (AWS STS)
- Amazon Simple Storage Service (Amazon S3)
- AWS Identity and Access Management (IAM)

### Target architecture

The following diagram shows an example workflow for exporting AWS Backup job reports from across an organization in AWS Organizations as a CSV file.

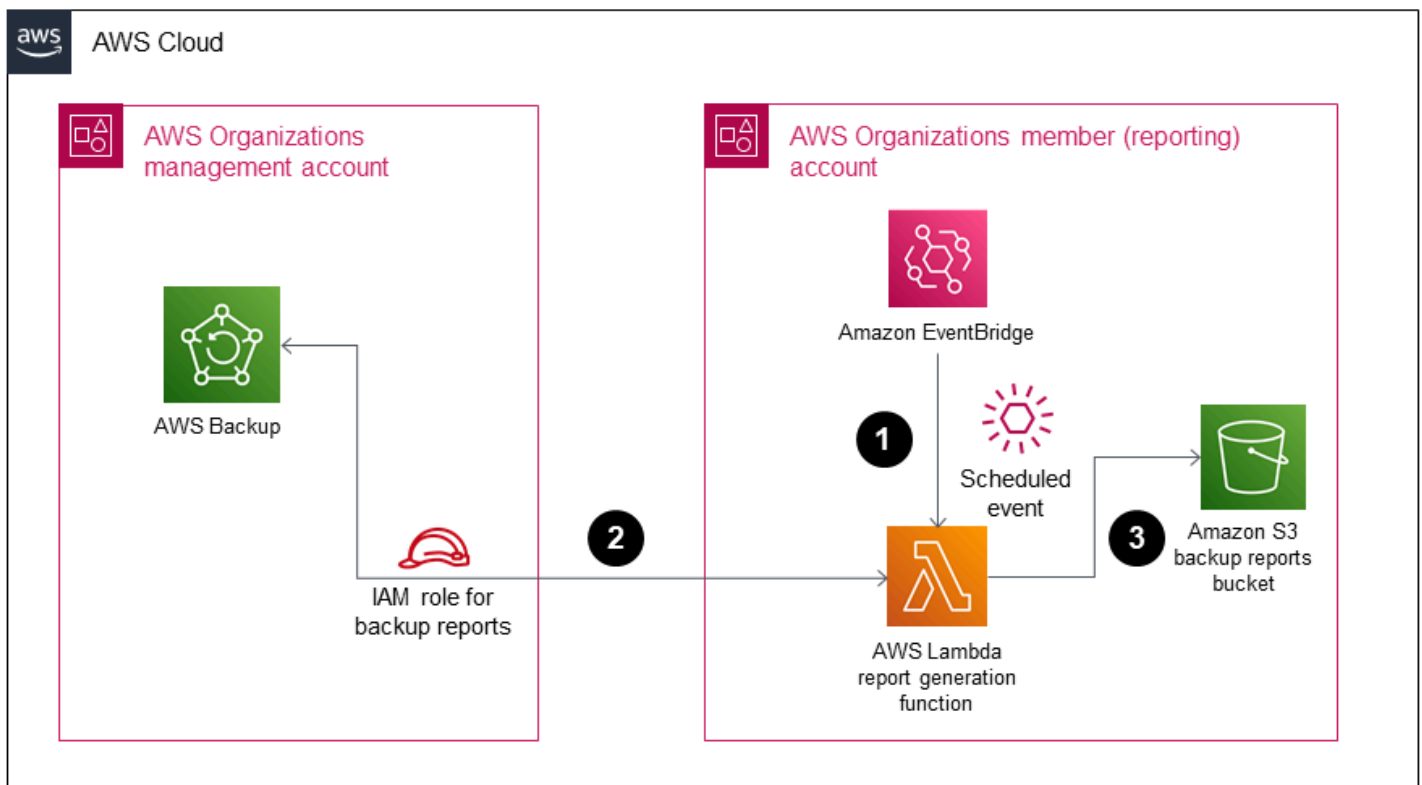

The diagram shows the following workflow:

1. A scheduled EventBridge event rule invokes a Lambda function in the member (reporting) AWS account.
2. The Lambda function then uses AWS STS to assume an IAM role that has the permissions required to connect to the management account.
3. The Lambda function then does the following:
  - Requests the consolidated AWS Backup jobs report from the AWS Backup service
  - Categorizes the results based on AWS Backup job status
  - Converts the response to a CSV file
  - Uploads the results to an Amazon S3 bucket in the reporting account within folders that are labeled based on their creation date

## Tools

### Tools

- [AWS Backup](#) is a fully managed service that helps you centralize and automate data protection across AWS services, in the cloud, and on premises.
- [AWS CloudFormation](#) helps you set up AWS resources, provision them quickly and consistently, and manage them throughout their lifecycle across AWS accounts and Regions.
- [Amazon EventBridge](#) is a serverless event bus service that helps you connect your applications with real-time data from a variety of sources. For example, AWS Lambda functions, HTTP invocation endpoints using API destinations, or event buses in other AWS accounts.
- [AWS Identity and Access Management \(IAM\)](#) helps you securely manage access to your AWS resources by controlling who is authenticated and authorized to use them.
- [AWS Lambda](#) is a compute service that helps you run code without needing to provision or manage servers. It runs your code only when needed and scales automatically, so you pay only for the compute time that you use.
- [Amazon Simple Storage Service \(Amazon S3\)](#) is a cloud-based object storage service that helps you store, protect, and retrieve any amount of data.

## Code

The code for this pattern is available in the GitHub [aws-backup-report-generator](#) repository.

## Best practices

- [Security best practices for Amazon S3](#) (*Amazon S3 User Guide*)
- [Best practices for working with AWS Lambda functions](#) (*AWS Lambda Developer Guide*)
- [Best practices for the management account](#) (*AWS Organizations User Guide*)

## Epics

### Deploy the solution components

Task	Description	Skills required
Clone the GitHub repository.	Clone the GitHub <a href="#">aws-backup-report-generator</a> repository by running the following command in a terminal window:	AWS DevOps, DevOps engineer

Task	Description	Skills required
	<pre data-bbox="594 212 1026 409">git clone https://github.com/aws-samples/aws-backup-report-generator.git</pre> <p data-bbox="594 447 976 575">For more information, see <a href="#">Cloning a repository</a> in the GitHub Docs.</p>	

Task	Description	Skills required
Deploy the solution components in the member (reporting) AWS account.	<ol style="list-style-type: none"><li>1. In the member (reporting) account, sign in to the AWS Management Console and then open the <a href="#">CloudFormation console</a>.</li><li>2. Choose <b>Create stack</b>, and then choose <b>With new resources (standard)</b>.</li><li>3. On the <b>Create stack</b> page, in the <b>Specify template</b> section, choose <b>Upload a template file</b>.</li><li>4. Select <b>Choose file</b>. Then, navigate to the root folder of the cloned GitHub repository on your local workstation and choose <b>template-reporting.yaml</b>.</li><li>5. Choose <b>Open</b>, and then choose <b>Next</b>.</li><li>6. On the <b>Specify stack details</b> page, for <b>Stack name</b>, enter a name for your CloudFormation stack.</li><li>7. For <b>ManagementAccountID</b>, enter the AWS account ID for your organization's management account in AWS Organizations.</li><li>8. Choose <b>Next</b>.</li><li>9. On the <b>Configure Stack Options</b> page, choose <b>Next</b>.</li></ol>	DevOps engineer, AWS DevOps



Task	Description	Skills required
	<p>10 On the <b>Review</b> page, select the check box to acknowledge that you reviewed the configuration.</p> <p>11 Choose <b>Create stack</b>. The stack shows <b>CREATE_COMPLETE</b> status when the solution components are deployed in the member (reporting) account.</p>	

## Test the solution

Task	Description	Skills required
<p>Make sure that the EventBridge rule runs prior to testing.</p>	<p>Make sure that the EventBridge rule runs by waiting at least 24 hours, or by increasing the report frequency in the CloudFormation template's <b>template-reporting.yml</b> file.</p> <p><b>To increase the report frequency</b></p> <ol style="list-style-type: none"> <li>1. Open the <b>template-reporting.yml</b> file in the cloned repository.</li> <li>2. In the event rule with the logical ID '<b>LambdaSchedule</b>', find the '<b>Schedule Expression</b>'.</li> <li>3. Edit the '<b>Schedule Expression</b>' key so</li> </ol>	<p>AWS DevOps, DevOps engineer</p>

Task	Description	Skills required
	<p>that it includes a valid cron expression. For example, the following cron expression schedules the event rule to run every five minutes: “cron (* /5 * * * *)”</p>	
<p>Check the Amazon S3 bucket for the generated report.</p>	<ol style="list-style-type: none"> <li>1. In the member (reporting) account, sign in to the AWS Management Console and then open the <a href="#">CloudFormation console</a>.</li> <li>2. In the <b>Stacks</b> pane, select the name of the stack you created. Then, choose the <b>Resources</b> tab.</li> <li>3. In the <b>Resources</b> pane, in the <b>Logical ID</b> column, find <b>BackupReportS3Bucket</b>. Then, open the associated Amazon S3 bucket in a new tab by selecting the link in the <b>Physical ID</b> column next to that logical ID.</li> <li>4. Make sure that the bucket contains a report that’s generated in the following format: <b>BackupReports/&lt;yyyy&gt;/&lt;mm&gt;/&lt;dd&gt;/BackupReport-&lt;BACKUP JOB STATUS&gt;-&lt;dd&gt;-&lt;Mon&gt;-&lt;yyyy&gt;.csv</b></li> </ol>	<p>AWS DevOps, DevOps engineer</p>

## Clean up your resources

Task	Description	Skills required
Delete the solution components from the member (reporting) account.	<ol style="list-style-type: none"> <li data-bbox="591 327 1026 747">1. In the member (reporting) account, open the solution's Amazon S3 bucket. For instructions, see steps 2-4 in the <b>Check the S3 bucket for the generated report</b> story of the <b>Test the solution</b> section of this pattern.</li> <li data-bbox="591 768 1016 999">2. Delete the contents of the bucket and empty the bucket. For instructions, see <a href="#">Emptying a bucket</a> in the <i>Amazon S3 User Guide</i>.</li> <li data-bbox="591 1020 1026 1251">3. In the member (reporting) account, sign in to the AWS Management Console and then open the <a href="#">CloudFormation console</a>.</li> <li data-bbox="591 1272 1003 1503">4. In the <b>Stacks</b> pane, select the checkbox next to the name of the stack you created. Then, choose <b>Delete</b>.</li> </ol>	AWS DevOps, DevOps engineer
Delete the solution components from the management account.	<ol style="list-style-type: none"> <li data-bbox="591 1539 1026 1770">1. In the management account, sign in to the AWS Management Console and then open the <a href="#">CloudFormation console</a>.</li> <li data-bbox="591 1791 1003 1871">2. In the <b>Stacks</b> pane, select the checkbox next to the</li> </ol>	AWS DevOps, DevOps engineer

Task	Description	Skills required
	name of the stack you created. Then, choose <b>Delete</b> .	

## Related resources

- [Tutorial: Using AWS Lambda with scheduled events](#) (AWS Lambda documentation)
- [Creating scheduled events to run AWS Lambda functions](#) (AWS SDK for JavaScript documentation)
- [IAM tutorial: Delegate access across AWS accounts using IAM roles](#) (IAM documentation)
- [AWS Organizations terminology and concepts](#) (AWS Organizations documentation)
- [Creating report plans using the AWS Backup console](#) (AWS Backup documentation)
- [Create an audit report](#) (AWS Backup documentation)
- [Creating on-demand reports](#) (AWS Backup documentation)
- [What is AWS Backup?](#) (AWS Backup documentation)
- [Automate centralized backup at scale across AWS services using AWS Backup](#) (AWS blog post)

# Export tags for a list of Amazon EC2 instances to a CSV file

Created by Sida Ju (AWS) and Pac Joonhyun (AWS)

**Code repository:** [Search and export EC2 tags](#)

**Environment:** Production

**Technologies:** DevOps

**AWS services:** Amazon EC2

## Summary

This pattern shows how to programmatically export tags for a list of Amazon Elastic Compute Cloud (Amazon EC2) instances to a CSV file.

By using the example Python script provided, you can reduce how long it takes to review and categorize your Amazon EC2 instances by specific tags. For example, you could use the script to quickly identify and categorize a list of instances that your security team has flagged for software updates.

## Prerequisites and limitations

### Prerequisites

- Python 3 installed and configured
- AWS Command Line Interface (AWS CLI) installed and configured

### Limitations

The example Python script provided in this pattern can search Amazon EC2 instances based on the following attributes only:

- Instance IDs
- Private IPv4 addresses
- Public IPv4 addresses

## Tools

- [Python](#) is a general-purpose computer programming language.
- [virtualenv](#) helps you create isolated Python environments.
- [AWS Command Line Interface \(AWS CLI\)](#) is an open-source tool that helps you interact with AWS services through commands in your command-line shell.

## Code repository

The example Python script for this pattern is available in the GitHub [search-ec2-instances-export-tags](#) repository.

## Epics

### Install and configure the prerequisites

Task	Description	Skills required
Clone the GitHub repository.	<p><b>Note:</b> If you receive errors when running AWS CLI commands, <a href="#">make sure that you're using the most recent AWS CLI version</a>.</p> <p>Clone the GitHub <a href="#">search-ec2-instances-export-tags</a> repository by running the following Git command in a terminal window:</p> <pre>git clone https://github.com/aws-samples/search-ec2-instances-export-tags.git</pre>	DevOps engineer

Task	Description	Skills required
Install and activate virtualenv.	<ol style="list-style-type: none"><li data-bbox="594 226 1026 361">1. Install virtualenv by running the following command: <pre data-bbox="634 394 1026 512">python3 -m pip install virtualenv</pre></li><li data-bbox="594 529 1026 663">2. Create a new virtual environment by running the following command: <pre data-bbox="634 697 1026 772">python3 -m venv env</pre></li><li data-bbox="594 789 1026 924">3. Activate the new virtual environment by running the following command: <pre data-bbox="634 957 1026 1075">source env/bin/activate</pre></li></ol> <p data-bbox="594 1150 1026 1234">For more information, see the <a href="#">virtualenv User Guide</a>.</p>	DevOps engineer

Task	Description	Skills required
Install dependencies.	<ol style="list-style-type: none"> <li>1. Open the code directory by running the following command in the terminal: <pre>cd search-ec2-instances-export-tags</pre> </li> <li>2. Install the requirements.txt file by running the following pip command: <pre>pip3 install -r requirements.txt</pre> </li> </ol>	DevOps engineer
Configure an AWS named profile.	<p>If you haven't already, configure an AWS named profile that includes the required credentials to run the script. To create a named profile, run the <a href="#">aws configure</a> command.</p> <p>For more information, see <a href="#">Using named profiles</a> in the AWS CLI documentation.</p>	DevOps engineer

### Configure and run the Python script

Task	Description	Skills required
Create the input file.	Create an input file that contains a list of the Amazon EC2 instances that you want the script to search and	DevOps engineer



Task	Description	Skills required
	<p>export tags for. You can list instance IDs, private IPv4 addresses, or public IPv4 addresses.</p> <p><b>Important:</b> Make sure that each Amazon EC2 instance is listed on its own line in the input file.</p> <p><b>Input file example</b></p> <pre data-bbox="594 726 1029 1205">1 i-0547c351bdfe85b9 f 2 54.157.194.156 3 172.31.85.33 4 54.165.198.144 5 i-0b6223b5914111a4 b 6 172.31.85.44 7 54.165.198.145 8 172.31.80.219 9 172.31.94.199</pre>	

Task	Description	Skills required
Run the Python script.	<p>Run the script by running the following command in the terminal:</p> <pre data-bbox="597 394 1026 632">python search_in stances.py -i   INPUTFILE -o OUTPUTFIL E -r REGION [-p   PROFILE]</pre> <p><b>Note:</b> Replace INPUTFILE with the name of your input file. Replace OUTPUTFILE with the name you want to give the CSV output file. Replace REGION with the AWS Region that your Amazon EC2 resources are in. If you're using an AWS named profile, replace PROFILE with the named profile that you're using.</p> <p>To get a list of supported parameters and their description, run the following command:</p> <pre data-bbox="597 1493 1026 1612">python search_in stances.py -h</pre> <p>For more information and to see an output file example, see the README.md file in the GitHub <a href="#">search-ec</a></p>	DevOps engineer

Task	Description	Skills required
	<a href="#">2-instances-export-tags</a> repository.	

## Related resources

- [Configuring the AWS CLI](#) (*AWS CLI User Guide*)

# Generate an AWS CloudFormation template containing AWS Config managed rules using Troposphere

Created by Lucas Nation (AWS) and Freddie Wilson (AWS)

**Environment:** Production

**Technologies:** DevOps;  
Management & governance;  
Security, identity, compliance

**Workload:** Microsoft; Open-source

**AWS services:** AWS Config;  
AWS CloudFormation

## Summary

Many organizations use [AWS Config managed](#) rules to evaluate the compliance of their Amazon Web Services (AWS) resources against common best practices. However, these rules can be time consuming to maintain and this pattern helps you leverage [Troposphere](#), a Python library, to generate and manage AWS Config managed rules.

The pattern helps you to manage your AWS Config managed rules by using a Python script to convert a Microsoft Excel spreadsheet containing AWS managed rules into an AWS CloudFormation template. Troposphere acts as the infrastructure as code (IaC) and this means that you can update the Excel spreadsheet with managed rules, instead of using a JSON or YAML-formatted file. You then use the template to launch an AWS CloudFormation stack that creates and updates the managed rules in your AWS account.

The AWS CloudFormation template defines each AWS Config managed rule by using the Excel spreadsheet and helps you to avoid manually creating individual rules in the AWS Management Console. The script defaults each managed rule's parameters to an empty dictionary and the scope's `ComplianceResourceTypes` defaults from `THE_RULE_IDENTIFIER.template` file. For more information about the rule identifier, see [Creating AWS Config managed rules with AWS CloudFormation templates](#) in the AWS Config documentation.

## Prerequisites and limitations

### Prerequisites

- An active AWS account.
- Familiarity with using AWS CloudFormation templates to create AWS Config managed rules. For more information about this, see [Creating AWS Config managed rules with AWS CloudFormation templates](#) in the AWS Config documentation.
- Python 3, installed and configured. For more information about this, see the [Python documentation](#).
- An existing integrated development environment (IDE) such as AWS Cloud9. For more information about this, see [What is AWS Cloud9?](#) in the AWS Cloud9 documentation.
- Identify your organizational units (OUs) in a column in the sample `excel_config_rules.xlsx` Excel spreadsheet (attached).

## Epics

### Customize and configure the AWS Config managed rules

Task	Description	Skills required
Update the sample Excel spreadsheet.	<p>Download the sample <code>excel_config_rules.xlsx</code> Excel spreadsheet (attached) and label as Implemented the AWS Config managed rules that you want to use.</p> <p>Rules marked as Implemented will be added to the AWS CloudFormation template.</p>	Developer
(Optional) Update the <code>config_rules_params.json</code> file with AWS Config rule parameters.	Some AWS Config managed rules require parameters and should be passed to the Python script as a JSON file by using the <code>--param-file</code> option. For example, the <code>access-keys-rotate</code>	Developer

Task	Description	Skills required
	<p data-bbox="591 210 967 344">d managed rule uses the following <code>maxAccessKeyAge</code> parameter:</p> <pre data-bbox="591 378 1029 814">{     "access-keys-rotated": {         "InputParameters": {             "maxAccessKeyAge": 90         }     } }</pre> <p data-bbox="591 856 1023 1125">In this sample parameter, the <code>maxAccessKeyAge</code> is set to 90 days. The script reads the parameter file and adds any <code>InputParameters</code> that it finds.</p>	

Task	Description	Skills required
<p>(Optional) Update the <code>config_rules_params.json</code> file with AWS Config ComplianceResourceTypes.</p>	<p>By default, the Python script retrieves the <code>ComplianceResourceTypes</code> from AWS defined templates. If you want to override the scope of a specific AWS Config managed rule, then you need to pass it to the Python script as a JSON file using the <code>--param-file</code> option.</p> <p>For example, the following sample code shows how the <code>ComplianceResourceTypes</code> for <code>ec2-volume-inuse-check</code> is set to the <code>["AWS::EC2::Volume"]</code> list:</p> <pre data-bbox="594 1098 1029 1654">{     "ec2-volume-inuse-check": {         "Scope": {          "ComplianceResourceTypes": [          "AWS::EC2::Volume"         ]         }     } }</pre>	Developer

## Run the Python script

Task	Description	Skills required
Install the pip packages from the requirements.txt file.	<p>Download the requirements.txt file (attached) and run the following command in your IDE to install the Python packages:</p> <pre>pip3 install -r requirements.txt</pre>	Developer
Run the Python script.	<ol style="list-style-type: none"> <li>Download the aws_config_rules.py file (attached) to your local machine.</li> <li>Run the <code>python3 aws_config_rules.py --ou &lt;OU_NAME&gt;</code> command. <b>Note:</b> <code>--ou</code> defines which OU column to choose in the Excel spreadsheet.</li> </ol> <p>You can also add the following optional parameters:</p> <ul style="list-style-type: none"> <li><code>--config-rule-option</code> – Defines the rules to choose from the Excel spreadsheet. The default is the Implemented parameter.</li> <li><code>--excel-file</code> – The path for the Excel</li> </ul>	Developer



Task	Description	Skills required
	<p>spreadsheet. The default is <code>aws_config_rules.xlsx</code>.</p> <ul style="list-style-type: none"> <li>• <code>--param-file</code> – The path of the parameter JSON file. The default is <code>config_rules_params.json</code>.</li> <li>• <code>--max-execution-frequency</code> – Defines how often the AWS Config managed rules are evaluated. The choices are <code>One_Hour</code>, <code>Three_Hours</code>, <code>Six_Hours</code>, <code>Twelve_Hours</code>, or <code>TwentyFour_Hours</code>. The default is <code>TwentyFour_Hours</code>.</li> </ul>	

## Deploy the AWS Config managed rules

Task	Description	Skills required
<p>Launch the AWS CloudFormation stack.</p>	<ol style="list-style-type: none"> <li>1. Sign in to the AWS Management Console, open the AWS CloudFormation console, and then choose <b>Create stack</b>.</li> <li>2. On the <b>Specify template</b> page, choose <b>Upload a template file</b> and</li> </ol>	<p>Developer</p>

Task	Description	Skills required
	then upload your AWS CloudFormation template. 3. Specify a stack name and then choose <b>Next</b> . 4. Specify tags and then choose <b>Next</b> . 5. Choose <b>Create stack</b> .	

## Attachments

To access additional content that is associated with this document, unzip the following file: [attachment.zip](#)

# Give SageMaker notebook instances temporary access to a CodeCommit repository in another AWS account

Created by Helge Aufderheide (AWS)

**Environment:** Production

**Technologies:** DevOps;  
Analytics; Machine learning &  
AI; Management & governanc  
e

**AWS services:** AWS  
CodeCommit; AWS Identity  
and Access Management;  
Amazon SageMaker

## Summary

This pattern shows how to grant Amazon SageMaker notebook instances and users temporary access to an AWS CodeCommit repository that's in another AWS account. This pattern also shows how you can grant granular permissions for specific actions each entity can perform on each repository.

Organizations often store CodeCommit repositories in a different AWS account than the account that hosts their development environment. This multi-account setup helps control access to the repositories and reduces the risk of their accidental deletion. To grant these cross-account permissions, it's a best practice to use AWS Identity and Access Management (IAM) roles. Then, predefined IAM identities in each AWS account can temporarily assume the roles to create a controlled chain of trust across the accounts.

**Note:** You can apply a similar procedure to grant other IAM identities cross-account access to a CodeCommit repository. For more information, see [Configure cross-account access to an AWS CodeCommit repository using roles](#) in the *AWS CodeCommit User Guide*.

## Prerequisites and limitations

### Prerequisites

- An active AWS account with a CodeCommit repository (*account A*)
- A second active AWS account with a SageMaker notebook instance (*account B*)
- An AWS user with sufficient permissions to create and modify IAM roles in account A

- A second AWS user with sufficient permissions to create and modify IAM roles in account B

## Architecture

The following diagram shows an example workflow for granting a SageMaker notebook instance and users in one AWS account cross-account access to a CodeCommit repository:

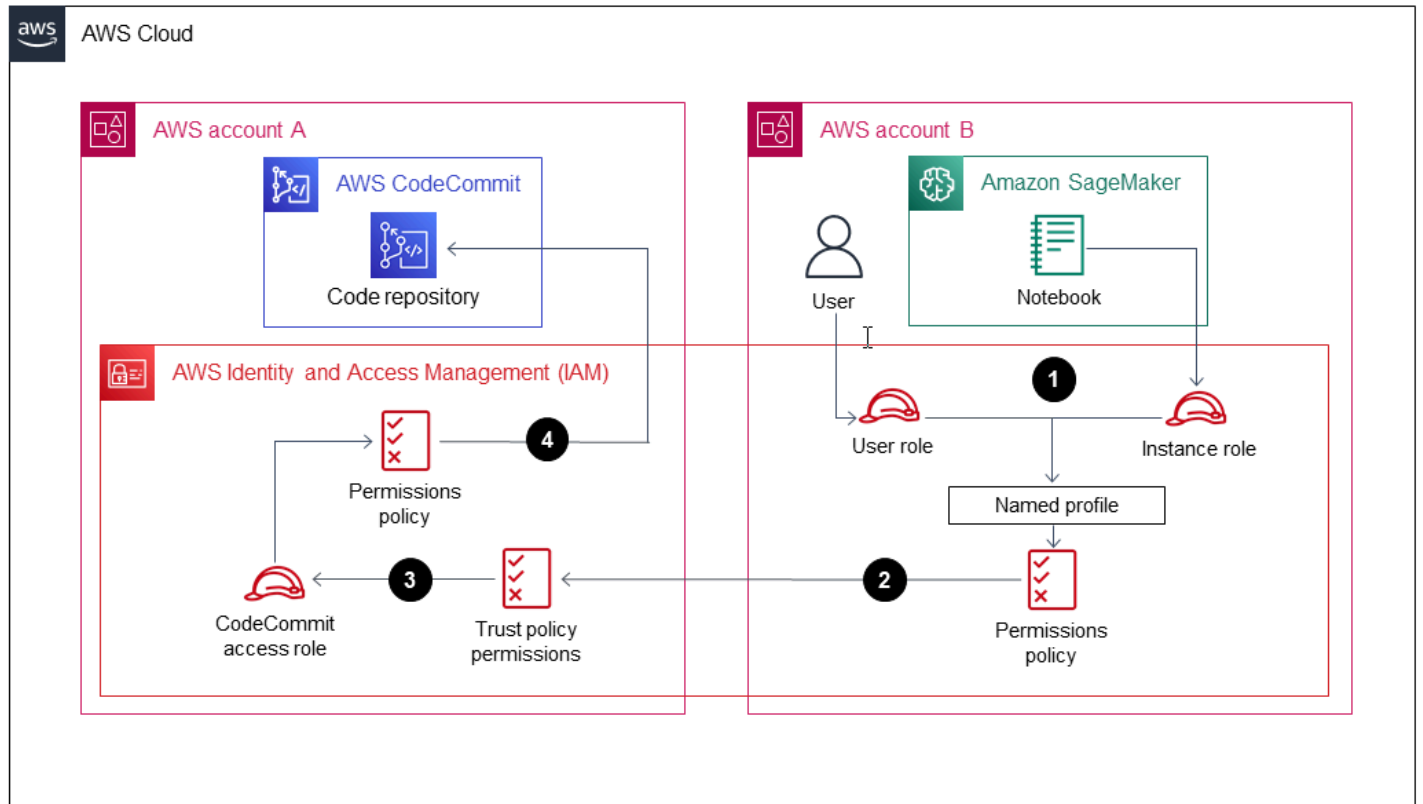

The diagram shows the following workflow:

1. The AWS user role and SageMaker notebook instance role in account B assume a [named profile](#).
2. The named profile's permissions policy specifies a CodeCommit access role in account A that the profile then assumes.
3. The CodeCommit access role's trust policy in account A allows the named profile in account B to assume the CodeCommit access role.
4. The CodeCommit repository's IAM permissions policy in account A allows the CodeCommit access role to access the CodeCommit repository.

## Technology stack

- CodeCommit
- Git
- IAM
- pip
- SageMaker

## Tools

- [AWS CodeCommit](#) is a version control service that helps you privately store and manage Git repositories, without needing to manage your own source control system.
- [AWS Identity and Access Management \(IAM\)](#) helps you securely manage access to your AWS resources by controlling who is authenticated and authorized to use them.
- [Git](#) is a distributed version-control system for tracking changes in source code during software development.
- [git-remote-codecommit](#) is a utility that helps you push and pull code from CodeCommit repositories by extending Git.
- [pip](#) is the package installer for Python. You can use pip to install packages from the Python Package Index and other indexes.

## Best practices

When you set permissions with IAM policies, make sure that you grant only the permissions required to perform a task. For more information, see [Apply least-privilege permissions](#) in the IAM documentation.

When implementing this pattern, make sure that you do the following:

- Confirm that IAM principles have only the permissions required to perform specific, needed actions within each repository. For example, it's recommended to allow approved IAM principles to push and merge changes to specific repository branches, but only request merges to protected branches.
- Confirm that IAM principles are assigned different IAM roles based on their respective roles and responsibilities for each project. For example, a developer will have different access permissions than a release manager or AWS Administrator.

# Epics

## Configure the IAM roles

Task	Description	Skills required
Configure the CodeCommit access role and permissions policy.	<p><b>Note:</b> To automate the manual setup process documented in this epic, you can use an <a href="#">AWS CloudFormation template</a>.</p> <p>In the account that contains the CodeCommit repository (<i>account A</i>), do the following:</p> <ol style="list-style-type: none"><li>1. <a href="#">Create an IAM role</a> that can be assumed by the SageMaker notebook instance role in account B.</li><li>2. <a href="#">Create an IAM policy</a> that grants access to the repository and <a href="#">attach the policy to the role</a>. For testing purposes only, choose the <a href="#">AWSCodeCommitPowerUser</a> AWS managed policy. This policy grants all <a href="#">CodeCommit permissions</a> except the ability to delete resources.</li><li>3. <a href="#">Modify the role's trust policy</a> so that account B is listed as a trusted entity.</li></ol> <p><b>Important:</b> Before moving this setup into your productio</p>	General AWS, AWS DevOps

Task	Description	Skills required
	<p>In an environment, it's a best practice to write your own IAM policy that applies <a href="#">least-privilege permissions</a>. For more information, see the <b>Additional information</b> section of this pattern.</p>	

Task	Description	Skills required
<p>Grant the SageMaker notebook instance's role in account B permissions to assume the CodeCommit access role in account A.</p>	<p>In the account that contains the SageMaker notebook instance's IAM role (<i>account B</i>), do the following:</p> <ol style="list-style-type: none"><li>1. Create an IAM policy that allows an IAM role or user to assume the CodeCommit access role in account A.</li></ol> <p><b>Example IAM permissions policy that allows an IAM role or user to assume a cross-account role</b></p> <pre data-bbox="630 884 1029 1562">{   "Version":     "2012-10-17",   "Statement": [     {       "Sid": "VisualEditor0",       "Effect": "Allow",       "Action":         "sts:AssumeRole",       "Resource":         "arn:aws:iam::accountA_ID:role/accountArole_ID"     }   ] }</pre> <ol style="list-style-type: none"><li>2. Attach the policy to your SageMaker notebook instance's role in account B.</li><li>3. Have the SageMaker notebook instance's role in account B assume the</li></ol>	<p>General AWS, AWS DevOps</p>



Task	Description	Skills required
	<p>CodeCommit access role in account A.</p> <p><b>Note:</b> To view your repository's Amazon Resource Name (ARN), see <a href="#">View CodeCommit repository details</a> in the <i>AWS CodeCommit User Guide</i>.</p>	

### Set up your SageMaker notebook instance in account B

Task	Description	Skills required
<p>Set up a user profile on the AWS SageMaker notebook instance to assume the role in account A.</p>	<p><b>Important:</b> <a href="#">Make sure that you have the latest version of the AWS Command Line Interface (AWS CLI) installed.</a></p> <p>In the account that contains the SageMaker notebook instance (<i>account B</i>), do the following:</p> <ol style="list-style-type: none"> <li>1. Sign in to the AWS Management Console and open the <a href="#">SageMaker console</a>.</li> <li>2. <a href="#">Access your SageMaker notebook instance</a>. The Jupyter interface opens.</li> <li>3. Choose <b>New</b>, and then choose <b>Terminal</b>. <a href="#">A new terminal window opens in your Jupyter environment.</a></li> </ol>	<p>General AWS, AWS DevOps</p>

Task	Description	Skills required
	<p>4. Navigate to the SageMaker notebook instance's <code>~/.aws/config</code> file. Then, add a user profile to the file by entering the following statement:</p> <pre data-bbox="594 558 1027 1152"> ----- .aws/config- ----- [profile remoterep ouser] role_arn = arn:aws:i am::&lt;ID of Account A&gt;:role/&lt;rolename&gt; role_session_name = remoteaccesssession region = eu-west-1 credential_source = Ec2InstanceMetadata ----- ----- </pre>	
Install the <code>git-remote-codecommit</code> utility.	Follow the instructions in <a href="#">Step 2: Install git-remote-codecommit</a> in the <i>AWS CodeCommit User Guide</i> .	Data scientist

## Access the repository

Task	Description	Skills required
Access the CodeCommit repository by using Git commands or SageMaker.	<p><b>To use Git</b></p> <p>IAM principals that assume the SageMaker notebook instance's role in account B</p>	Git, bash console

Task	Description	Skills required
	<p>can now run Git commands to access the CodeCommit repository in account A. For example, users can run commands such as <code>git clone</code>, <code>git pull</code>, and <code>git push</code>.</p> <p>For instructions, see <a href="#">Connect to an AWS CodeCommit repository</a> in the <i>AWS CodeCommit User Guide</i>.</p> <p>For information about how to use Git with CodeCommit, see <a href="#">Getting started with AWS CodeCommit</a> in the <i>AWS CodeCommit User Guide</i>.</p> <p><b>To use SageMaker</b></p> <p>To use Git from the SageMaker console, you must allow Git to retrieve credentials from your CodeCommit repository. For instructions, see <a href="#">Associate a CodeCommit repository in a different AWS account with a notebook instance</a> in the SageMaker documentation.</p>	

## Related resources

- [Configure cross-account access to an AWS CodeCommit repository using roles](#) (AWS CodeCommit documentation)
- [IAM tutorial: Delegate access across AWS accounts using IAM roles](#) (IAM documentation)

## Additional information

### Restricting CodeCommit permissions to specific actions

To restrict the actions that an IAM principal can take in the CodeCommit repository, modify the actions that are allowed in the CodeCommit access policy.

For more information about CodeCommit API operations, see [CodeCommit permissions reference](#) in the *AWS CodeCommit User Guide*.

**Note:** You can also edit the [AWSCodeCommitPowerUser](#) AWS managed policy to fit your use case.

### Restricting CodeCommit permissions to specific repositories

To create a multitenant environment where more than one code repository is accessible to only specific users, do the following:

1. Create multiple CodeCommit access roles in account A. Then, configure each access role's trust policy to allow specific users in account B to assume the role.
2. Restrict what code repositories that each role can assume by adding a **"Resource"** condition to each CodeCommit access role's policy.

### Example "Resource" condition that restricts an IAM principal's access to a specific CodeCommit repository

```
"Resource" : [ <REPOSITORY_ARN>, <REPOSITORY_ARN> ]
```

**Note:** To help identify and differentiate multiple code repositories in the same AWS account, you can assign different prefixes to the repositories' names. For example, you can name code repositories with prefixes that align to different developer groups, such as **myproject-subproject1-repo1** and **myproject-subproject2-repo1**. Then, you can create an IAM role for each developer group based on their assigned prefixes. For example, you could create a role named **myproject-**

**subproject1-repoaccess** and grant it access to all of the code repositories that include the prefix **myproject-subproject1**.

**Example “Resource” condition that refers to a code repository ARN that includes a specific prefix**

```
"Resource" : arn:aws:codecommit:<region>:<account-id>:myproject-subproject1-*
```

# Implement a GitHub Flow branching strategy for multi-account DevOps environments

Created by Mike Stephens (AWS) and Abhilash Vinod (AWS)

**Code repository:** [git-branching-strategies-for-multi-account-devops](#)

**Environment:** Production

**Technologies:** DevOps; DevelopmentAndTesting; Multi account strategy

**AWS services:** AWS CodeArtifact; AWS CodeBuild; AWS CodeCommit; AWS CodeDeploy; AWS CodePipeline

## Summary

When managing a source code repository, different branching strategies affect the software development and release processes that development teams use. Examples of common branching strategies include Trunk, GitHub Flow, and Gitflow. These strategies use different branches, and the activities performed in each environment are different. Organizations that are implementing DevOps processes would benefit from a visual guide to help them understand the differences between these branching strategies. Using this visual in your organization helps development teams align their work and follow organizational standards. This pattern provides this visual and describes the process of implementing a GitHub Flow branching strategy in your organization.

This pattern is part of a documentation series about choosing and implementing DevOps branching strategies for organizations with multiple AWS accounts. This series is designed to help you apply the correct strategy and best practices from the outset, to streamline your experience in the cloud. GitHub Flow is just one possible branching strategy that your organization can use. This documentation series also covers [Trunk](#) and [Gitflow](#) branching models. If you haven't done so already, we recommend that you review [Choosing a Git branching strategy for multi-account DevOps environments](#) prior to implementing the guidance in this pattern. Please use due diligence to choose the right branching strategy for your organization.

This guide provides a diagram that shows how an organization might implement the GitHub Flow strategy. It is recommended that you review the [AWS Well-Architected DevOps Guidance](#) to review best practices. This pattern includes recommended tasks, steps, and restrictions for each step in the DevOps process.

## Prerequisites and limitations

### Prerequisites

- Git, [installed](#). This is used as a source code repository tool.
- Draw.io, [installed](#). This application is used to view and edit the diagram.

## Architecture

### Target architecture

The following diagram can be used like a [Punnett square](#) (Wikipedia). You line up the branches on the vertical axis with the AWS environments on the horizontal axis to determine what actions to perform in each scenario. The numbers indicate the sequence of the actions in the workflow. This example takes you from a feature branch through deployment in production.

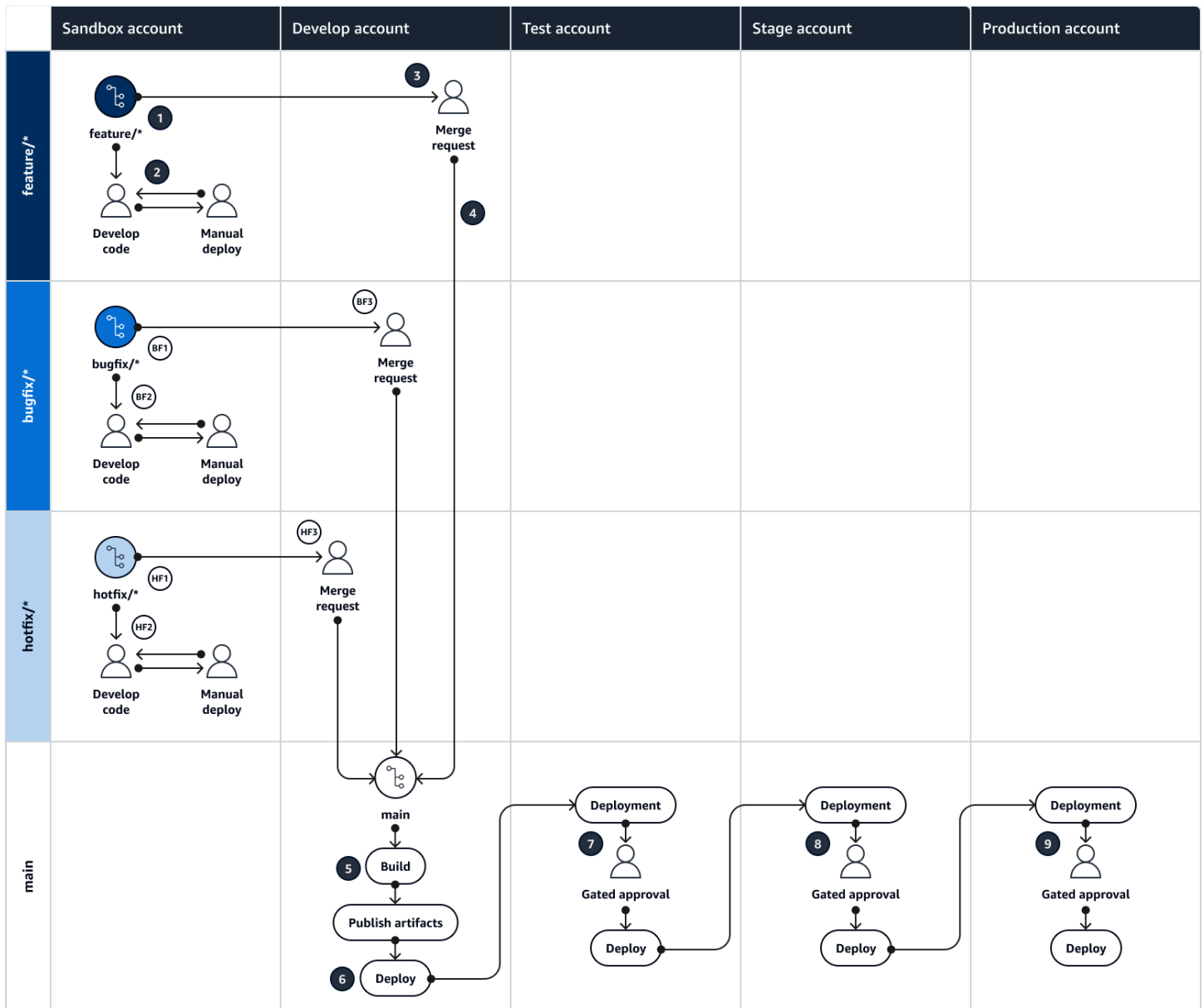

For more information about the AWS accounts, environments, and branches in a GitHub Flow approach, see [Choosing a Git branching strategy for multi-account DevOps environments](#).

### Automation and scale

Continuous integration and continuous delivery (CI/CD) is the process of automating the software release lifecycle. It automates much or all of the manual processes traditionally required to get new code from an initial commit into production. A CI/CD pipeline encompasses the sandbox, development, testing, staging, and production environments. In each environment, the CI/CD pipeline provisions any infrastructure that is needed to deploy or test the code. By using CI/CD, development teams can make changes to code that are then automatically tested and deployed.



CI/CD pipelines also provide governance and guardrails for development teams by enforcing consistency, standards, best practices, and minimal acceptance levels for feature acceptance and deployment. For more information, see [Practicing Continuous Integration and Continuous Delivery on AWS](#).

AWS offers a suite of developer services that are designed to help you build CI/CD pipelines. For example, [AWS CodePipeline](#) is a fully managed continuous delivery service that helps you automate your release pipelines for fast and reliable application and infrastructure updates. [AWS CodeCommit](#) is designed to securely host scalable Git repositories, and [AWS CodeBuild](#) compiles source code, runs tests, and produces ready-to-deploy software packages. For more information, see [Developer Tools on AWS](#).

## Tools

### AWS services and tools

AWS provides a suite of developer services that you can use to implement this pattern:

- [AWS CodeArtifact](#) is a highly scalable, managed artifact repository service that helps you store and share software packages for application development.
- [AWS CodeBuild](#) is a fully managed build service that helps you compile source code, run unit tests, and produce artifacts that are ready to deploy.
- [AWS CodeCommit](#) is a version control service that helps you privately store and manage Git repositories, without needing to manage your own source control system.
- [AWS CodeDeploy](#) automates deployments to Amazon Elastic Compute Cloud (Amazon EC2) or on-premises instances, AWS Lambda functions, or Amazon Elastic Container Service (Amazon ECS) services.
- [AWS CodePipeline](#) helps you quickly model and configure the different stages of a software release and automate the steps required to release software changes continuously.

### Other tools

- [Draw.io Desktop](#) is an application for making flowcharts and diagrams. The code repository contains templates in .drawio format for Draw.io.
- [Figma](#) is an online design tool designed for collaboration. The code repository contains templates in .fig format for Figma.

## Code repository

This source file for the diagram in this pattern is available in the GitHub [Git Branching Strategy for GitHub Flow](#) repository. It includes files in PNG, draw.io, and Figma formats. You can modify these diagrams to support your organization's processes.

## Best practices

Follow the best practices and recommendations in [AWS Well-Architected DevOps Guidance](#) and [Choosing a Git branching strategy for multi-account DevOps environments](#). These help you effectively implement GitHub Flow-based development, foster collaboration, improve code quality, and streamline the development process.

## Epics

### Reviewing the GitHub Flow workflows

Task	Description	Skills required
Review the standard GitHub Flow process.	<ol style="list-style-type: none"><li>1. In the sandbox environment, the developer creates a feature branch from the main branch and uses the naming pattern <code>feature/&lt;ticket&gt;_&lt;initials&gt;_&lt;short description&gt;</code> .</li><li>2. The developer adds one or more commits to the feature branch, each representing a discrete change or improvement.</li><li>3. The developer opens a merge request (MR) to merge the changes into the main branch. This initiates a review process.</li></ol>	DevOps engineer

Task	Description	Skills required
	<ol style="list-style-type: none"><li data-bbox="591 212 1027 579">4. During the review process, developers discuss the code changes and provide feedback. The goal is to ensure that the changes are of high quality and meet the project's standards.</li><li data-bbox="591 600 1027 926">5. After the developer creates the merge request, an automated build process starts and deploys the changes in the feature branch to the development environment.</li><li data-bbox="591 947 1027 1356">6. Automated tests verify the integrity and quality of the changes encapsulated in the merge request. A successful build, successful deployment, and successful testing are required to complete the merge request.</li><li data-bbox="591 1377 1027 1566">7. When the review process is complete, the changes are merged into the main branch.</li><li data-bbox="591 1587 1027 1766">8. An approver manually approves the deployment of the release artifacts to the testing environment.</li><li data-bbox="591 1787 1027 1871">9. An approver manually approves the deployment</li></ol>	

Task	Description	Skills required
	<p>of the release artifacts to the staging environment.</p> <p>10An approver manually approves the deployment of the release artifacts to the production environment.</p>	

Task	Description	Skills required
Review the bugfix GitHub Flow process.	<ol style="list-style-type: none"><li data-bbox="591 226 1015 552">1. The developer creates a bugfix branch from the main branch and uses the naming pattern <code>bugfix/&lt;ticket number&gt;_&lt;developer initials&gt;_&lt;descriptor&gt;</code> .</li><li data-bbox="591 573 1015 709">2. The developer fixes the issue, commits the fix, and builds the bugfix branch.</li><li data-bbox="591 730 1015 951">3. The developer opens a merge request to merge the bugfix branch into the main branch. This initiates a review process.</li><li data-bbox="591 972 1015 1150">4. During the review process, developers discuss the code changes and provide feedback.</li><li data-bbox="591 1171 1015 1455">5. Upon review completion and approval, the developer completes the merge request of the bugfix branch into the main branch.</li><li data-bbox="591 1476 1015 1654">6. An approver manually approves the deployment of the release artifacts to higher environments.</li></ol>	DevOps engineer

Task	Description	Skills required
Review the hotfix GitHub Flow process.	<p>GitHub Flow is designed to enable continuous delivery, where code changes are frequently and reliably deployed to higher environments. The key is that every feature branch is deployable at any time.</p> <p>Hotfix branches, which are akin to feature or bugfix branches, can follow the same process as either of these other branches. However, given their urgency, hotfixes typically have a higher priority. Depending on the team's policies and the immediacy of the situation, certain steps in the process could be expedited. For instance, code reviews for hotfixes might be fast-tracked. Therefore, while the hotfix process parallels the feature or bugfix process, the urgency surrounding hotfixes may warrant modifications in the procedural adherence. It's crucial to establish guidelines about managing hotfixes to make sure that they are handled efficiently and securely.</p>	DevOps engineer

## Troubleshooting

Issue	Solution
Branch conflicts	A common issue that can occur with the GitHub Flow model is where a hotfix needs to occur in production but a corresponding change needs to occur in a feature, bugfix, or hotfix branch where the same resources are being modified. We recommend that you frequently merge changes from main into lower branches to avoid significant conflicts when you merge to main.
Team maturity	GitHub Flow encourages daily deployments to higher environments, embracing true continuous integration and continuous delivery (CI/CD). It is imperative that the team has the engineering maturity to build features and create automation tests for them. The team must perform an exhaustive merge request review before changes are approved. This fosters a robust engineering culture that promotes quality, accountability, and efficiency in the development process.

### Related resources

This guide doesn't include training for Git; however, there are many high-quality resources available on the internet if you need this training. We recommend that you start with the [Git documentation](#) site.

The following resources can help you with your GitHub Flow branching journey in the AWS Cloud.

#### AWS DevOps guidance

- [AWS DevOps Guidance](#)

- [AWS Deployment Pipeline Reference Architecture](#)
- [What is DevOps?](#)
- [DevOps resources](#)

### **GitHub Flow guidance**

- [GitHub Flow Quickstart Tutorial](#) (GitHub)
- [Why GitHub Flow?](#)

### **Other resources**

- [Twelve-factor app methodology](#) (12factor.net)



# Implement a Gitflow branching strategy for multi-account DevOps environments

Created by Mike Stephens (AWS), Stephen DiCato (AWS), Tim Wondergem (AWS), and Abhilash Vinod (AWS)

**Code repository:** [git-branching-strategies-for-multiaccount-devops](#)

**Environment:** Production

**Technologies:** DevOps; DevelopmentAndTesting; Multi account strategy

**AWS services:** AWS CodeArtifact; AWS CodeBuild; AWS CodeCommit; AWS CodeDeploy; AWS CodePipeline

## Summary

When managing a source code repository, different branching strategies affect the software development and release processes that development teams use. Examples of common branching strategies include Trunk, Gitflow, and GitHub Flow. These strategies use different branches, and the activities performed in each environment are different. Organizations that are implementing DevOps processes would benefit from a visual guide to help them understand the differences between these branching strategies. Using this visual in your organization helps development teams align their work and follow organizational standards. This pattern provides this visual and describes the process of implementing a Gitflow branching strategy in your organization.

This pattern is part of a documentation series about choosing and implementing DevOps branching strategies for organizations with multiple AWS accounts. This series is designed to help you apply the correct strategy and best practices from the outset, to streamline your experience in the cloud. Gitflow is just one possible branching strategy that your organization can use. This documentation series also covers [Trunk](#) and [GitHub Flow](#) branching models. If you haven't done so already, we recommend that you review [Choosing a Git branching strategy for multi-account DevOps environments](#) prior to implementing the guidance in this pattern. Please use due diligence to choose the right branching strategy for your organization.

This guide provides a diagram that shows how an organization might implement the Gitflow strategy. It is recommended that you review the [AWS Well-Architected DevOps Guidance](#) to review best practices. This pattern includes recommended tasks, steps, and restrictions for each step in the DevOps process.

## Prerequisites and limitations

### Prerequisites

- Git, [installed](#). This is used as a source code repository tool.
- Draw.io, [installed](#). This application is used to view and edit the diagram.
- (Optional) Gitflow plugin, [installed](#).

## Architecture

### Target architecture

The following diagram can be used like a [Punnett square](#) (Wikipedia). You line up the branches on the vertical axis with the AWS environments on the horizontal axis to determine what actions to perform in each scenario. The numbers indicate the sequence of the actions in the workflow. This example takes you from a feature branch through deployment in production.

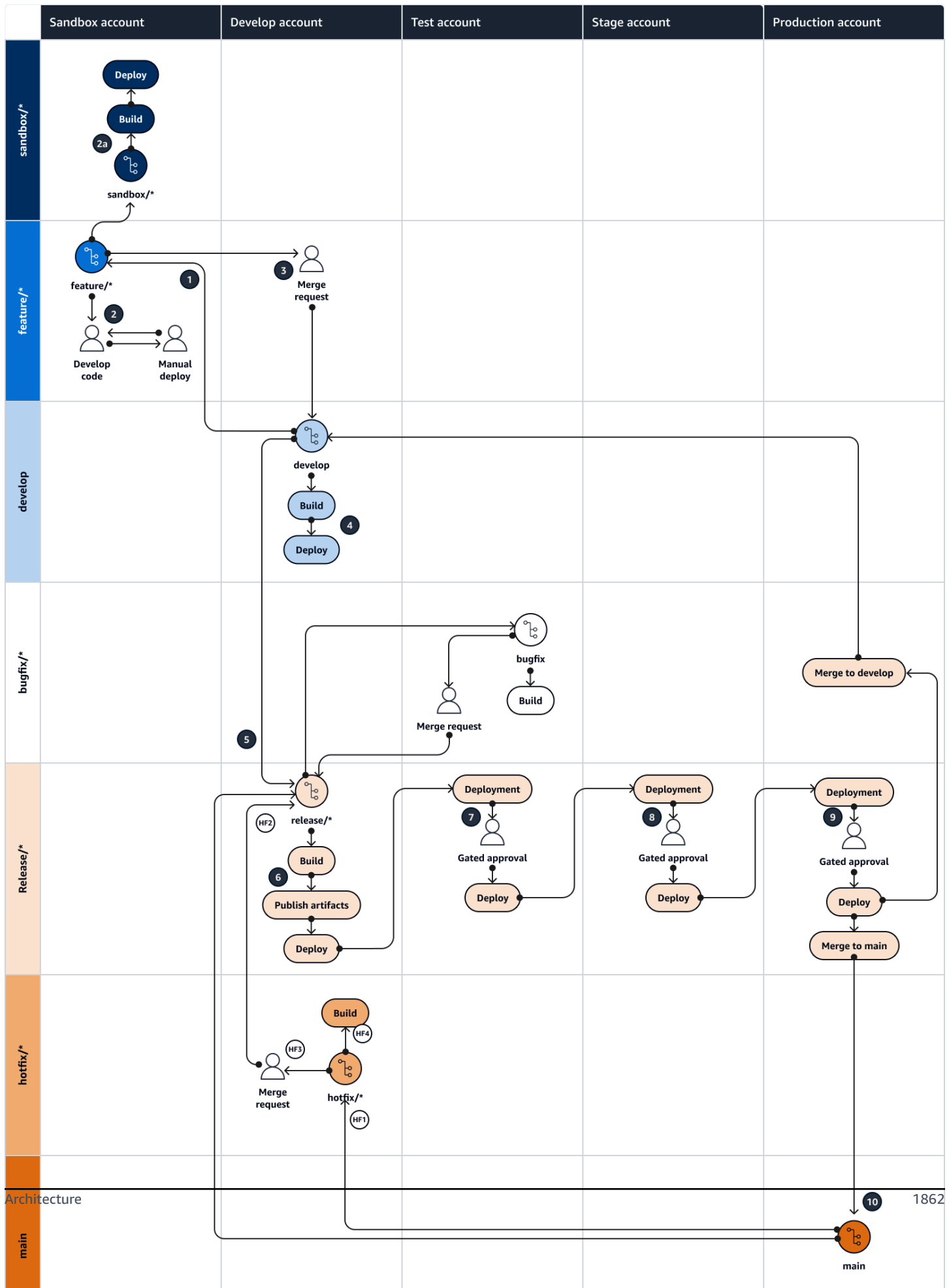

For more information about the AWS accounts, environments, and branches in a Gitflow approach, see [Choosing a Git branching strategy for multi-account DevOps environments](#).

## Automation and scale

Continuous integration and continuous delivery (CI/CD) is the process of automating the software release lifecycle. It automates much or all of the manual processes traditionally required to get new code from an initial commit into production. A CI/CD pipeline encompasses the sandbox, development, testing, staging, and production environments. In each environment, the CI/CD pipeline provisions any infrastructure that is needed to deploy or test the code. By using CI/CD, development teams can make changes to code that are then automatically tested and deployed. CI/CD pipelines also provide governance and guardrails for development teams by enforcing consistency, standards, best practices, and minimal acceptance levels for feature acceptance and deployment. For more information, see [Practicing Continuous Integration and Continuous Delivery on AWS](#).

AWS offers a suite of developer services that are designed to help you build CI/CD pipelines. For example, [AWS CodePipeline](#) is a fully managed continuous delivery service that helps you automate your release pipelines for fast and reliable application and infrastructure updates. [AWS CodeCommit](#) is designed to securely host scalable Git repositories, and [AWS CodeBuild](#) compiles source code, runs tests, and produces ready-to-deploy software packages. For more information, see [Developer Tools on AWS](#).

## Tools

### AWS services and tools

AWS provides a suite of developer services that you can use to implement this pattern:

- [AWS CodeArtifact](#) is a highly scalable, managed artifact repository service that helps you store and share software packages for application development.
- [AWS CodeBuild](#) is a fully managed build service that helps you compile source code, run unit tests, and produce artifacts that are ready to deploy.
- [AWS CodeCommit](#) is a version control service that helps you privately store and manage Git repositories, without needing to manage your own source control system.
- [AWS CodeDeploy](#) automates deployments to Amazon Elastic Compute Cloud (Amazon EC2) or on-premises instances, AWS Lambda functions, or Amazon Elastic Container Service (Amazon ECS) services.

- [AWS CodePipeline](#) helps you quickly model and configure the different stages of a software release and automate the steps required to release software changes continuously.

## Other tools

- [Draw.io Desktop](#) is an application for making flowcharts and diagrams. The code repository contains templates in .drawio format for Draw.io.
- [Figma](#) is an online design tool designed for collaboration. The code repository contains templates in .fig format for Figma.
- (Optional) [Gitflow plugin](#) is a collection of Git extensions that provide high-level repository operations for the Gitflow branching model.

## Code repository

This source file for the diagram in this pattern is available in the GitHub [Git Branching Strategy for GitFlow](#) repository. It includes files in PNG, draw.io, and Figma formats. You can modify these diagrams to support your organization's processes.

## Best practices

Follow the best practices and recommendations in [AWS Well-Architected DevOps Guidance](#) and [Choosing a Git branching strategy for multi-account DevOps environments](#). These help you effectively implement Gitflow-based development, foster collaboration, improve code quality, and streamline the development process.

## Epics

### Reviewing the Gitflow workflows

Task	Description	Skills required
Review the standard Gitflow process.	1. In the sandbox environment, the developer creates a feature branch from the develop branch and uses the naming pattern feature/<ticket>_<	DevOps engineer

Task	Description	Skills required
	<p>initials&gt;_&lt;short description&gt; .</p> <ol style="list-style-type: none"><li data-bbox="592 317 1019 541">2. The developer develops code and deploys the code to the sandbox environment iteratively in order to complete the ticket.</li></ol> <p><b>Note:</b> The developer can optionally create a sandbox branch to run an automated build or deploy pipeline in the sandbox environment.</p> <ol style="list-style-type: none"><li data-bbox="592 884 1024 1108">3. The developer creates a merge request from the feature branch into the develop branch by using a squash merge.</li><li data-bbox="592 1136 1019 1402">4. A continuous integration and continuous delivery (CI/CD) pipeline automatically builds and deploys the develop branch to the development environment.</li><li data-bbox="592 1430 1008 1696">5. (Optional) A developer integrates additional feature branches into the develop branch prior to continuing with release activities.</li><li data-bbox="592 1724 959 1850">6. When you are ready to release the features in the develop branch,</li></ol>	

Task	Description	Skills required
	<p>the developer creates a release branch named <code>release/v&lt;number&gt;</code> from the <code>develop</code> branch.</p> <p>7. The developer builds the release branch, which publishes artifacts for reuse across other environments.</p> <p>8. An approver manually approves the deployment of the release artifacts to the testing environment.</p> <p>9. An approver manually approves the deployment of the release artifacts to the staging environment.</p> <p>10An approver manually approves the deployment of the release artifacts to the production environment.</p> <p>11.The developer merges the <code>release</code> branch into the <code>main</code> branch. Ideally, the developer uses an automated script to perform a fast-forward merge. Do not use a squash merge.</p> <p>12.The developer merges the <code>release</code> branch into the <code>develop</code> branch.</p>	

Task	Description	Skills required
	Ideally, the developer uses an automated script to perform a fast-forward merge. Do not use a squash merge.	



Task	Description	Skills required
Review the hotfix Gitflow process.	<ol style="list-style-type: none"><li data-bbox="592 226 1027 552">1. The developer creates a hotfix branch from the main branch and uses the naming pattern <code>hotfix/&lt;ticket&gt;_&lt;initials&gt;_&lt;short description&gt;</code> .</li><li data-bbox="592 573 1027 751">2. The developer creates a release branch from the main branch and names it <code>release/v&lt;number&gt;</code> .</li><li data-bbox="592 772 1027 909">3. The developer fixes the issue, commits the fix, and builds the hotfix branch.</li><li data-bbox="592 930 1027 1203">4. The developer creates a merge request from the hotfix branch into the <code>release/v&lt;number&gt;</code> branch by using a squash merge.</li><li data-bbox="592 1224 1027 1455">5. The developer builds the release branch, which publishes artifacts for reuse across other environments.</li><li data-bbox="592 1476 1027 1654">6. An approver manually approves the deployment of the release artifacts to the testing environment.</li><li data-bbox="592 1675 1027 1854">7. An approver manually approves the deployment of the release artifacts to the staging environment.</li></ol>	DevOps engineer

Task	Description	Skills required
	<p>8. An approver manually approves the deployment of the release artifacts to the production environment.</p> <p>9. The developer merges the release branch into the main branch. Ideally, the developer uses an automated script to perform a fast-forward merge. Do not use a squash merge.</p> <p>10. The developer merges the release branch into the develop branch. Ideally, the developer uses an automated script to perform a fast-forward merge. Do not use a squash merge.</p> <p>11. If a conflict is detected, developers receive an alert and resolve the conflict with a merge request.</p>	

Task	Description	Skills required
Review the bugfix Gitflow process.	<ol style="list-style-type: none"><li data-bbox="592 226 1027 646">1. The developer creates a bugfix branch from the current <code>release/v&lt;number&gt;</code> branch and uses the naming pattern <code>bugfix/&lt;ticket number&gt;_&lt;developer initials&gt;_&lt;descriptor&gt;</code> .</li><li data-bbox="592 667 1027 804">2. The developer fixes the issue, commits the fix, and builds the bugfix branch.</li><li data-bbox="592 825 1027 1098">3. The developer creates a merge request from the bugfix branch into the <code>release/v&lt;number&gt;</code> branch by using a squash merge.</li><li data-bbox="592 1119 1027 1350">4. The developer builds the <code>release</code> branch, which publishes artifacts for reuse across other environments.</li><li data-bbox="592 1371 1027 1549">5. An approver manually approves the deployment of the release artifacts to the Test environment.</li><li data-bbox="592 1570 1027 1749">6. An approver manually approves the deployment of the release artifacts to the Stage environment.</li><li data-bbox="592 1770 1027 1843">7. An approver manually approves the deployment</li></ol>	DevOps engineer

Task	Description	Skills required
	<p>of the release artifacts to the Production environment.</p> <p>8. The developer merges the release branch into the main branch. Ideally, the developer uses an automated script to perform a fast-forward merge. Do not use a squash merge.</p> <p>9. The developer merges the release branch into the develop branch. Ideally, the developer uses an automated script to perform a fast-forward merge. Do not use a squash merge.</p> <p>10 If a conflict is detected, developers receive an alert and resolve the conflict with a merge request.</p>	

## Troubleshooting

Issue	Solution
Branch conflicts	A common issue that can occur with the Gitflow model is where a hotfix needs to occur in production but a corresponding change needs to occur in a lower environment, where another branch is modifying the

Issue	Solution
	same resources. We recommend that you have only a single release branch active at a time. If you have more than one active at a time, the changes in the environments might collide, and you might be unable to move a branch forward to production.
Merging	Releases should be merged back into main and develop as soon as possible to consolidate work back into the primary branches.
Squash merging	Only use a squash merge when you are merging from a feature branch to a develop branch. Using squash merges in higher branches causes difficulty when merging changes back down to lower branches.

## Related resources

This guide doesn't include training for Git; however, there are many high-quality resources available on the internet if you need this training. We recommend that you start with the [Git documentation](#) site.

The following resources can help you with your Gitflow branching journey in the AWS Cloud.

### AWS DevOps guidance

- [AWS DevOps Guidance](#)
- [AWS Deployment Pipeline Reference Architecture](#)
- [What is DevOps?](#)
- [DevOps resources](#)

### Gitflow guidance

- [The original Gitflow blog](#) (Vincent Driessen blog post)
- [Gitflow workflow](#) (Atlassian)
- [Gitflow on GitHub: How to use Git Flow workflows with GitHub Based Repos](#) (YouTube video)
- [Git Flow Init Example](#) (YouTube video)
- [The Gitflow Release Branch from Start to Finish](#) (YouTube video)

## Other resources

[Twelve-factor app methodology](#) (12factor.net)

# Implement a Trunk branching strategy for multi-account DevOps environments

Created by Mike Stephens (AWS) and Rayjan Wilson (AWS)

**Code repository:** [git-branching-strategies-for-multi-account-devops](#)

**Environment:** Production

**Technologies:** DevOps; DevelopmentAndTesting; Multi account strategy

**AWS services:** AWS CodeArtifact; AWS CodeBuild; AWS CodeCommit; AWS CodeDeploy; AWS CodePipeline

## Summary

When managing a source code repository, different branching strategies affect the software development and release processes that development teams use. Examples of common branching strategies include Trunk, GitHub Flow, and Gitflow. These strategies use different branches, and the activities performed in each environment are different. Organizations that are implementing DevOps processes would benefit from a visual guide to help them understand the differences between these branching strategies. Using this visual in your organization helps development teams align their work and follow organizational standards. This pattern provides this visual and describes the process of implementing a Trunk branching strategy in your organization.

This pattern is part of a documentation series about choosing and implementing DevOps branching strategies for organizations with multiple AWS accounts. This series is designed to help you apply the correct strategy and best practices from the outset, to streamline your experience in the cloud. Trunk is just one possible branching strategy that your organization can use. This documentation series also covers [GitHub Flow](#) and [Gitflow](#) branching models. If you haven't done so already, we recommend that you review [Choosing a Git branching strategy for multi-account DevOps environments](#) prior to implementing the guidance in this pattern. Please use due diligence to choose the right branching strategy for your organization.

This guide provides a diagram that shows how an organization might implement the Trunk strategy. It is recommended that you review the official [AWS Well-Architected DevOps Guidance](#) to review best practices. This pattern includes recommended tasks, steps, and restrictions for each step in the DevOps process.

## Prerequisites and limitations

### Prerequisites

- Git, [installed](#). This is used as a source code repository tool.
- Draw.io, [installed](#). This application is used to view and edit the diagram.

## Architecture

### Target architecture

The following diagram can be used like a [Punnett square](#) (Wikipedia). You line up the branches on the vertical axis with the AWS environments on the horizontal axis to determine what actions to perform in each scenario. The numbers indicate the sequence of the actions in the workflow. This example takes you from a feature branch through deployment in production.



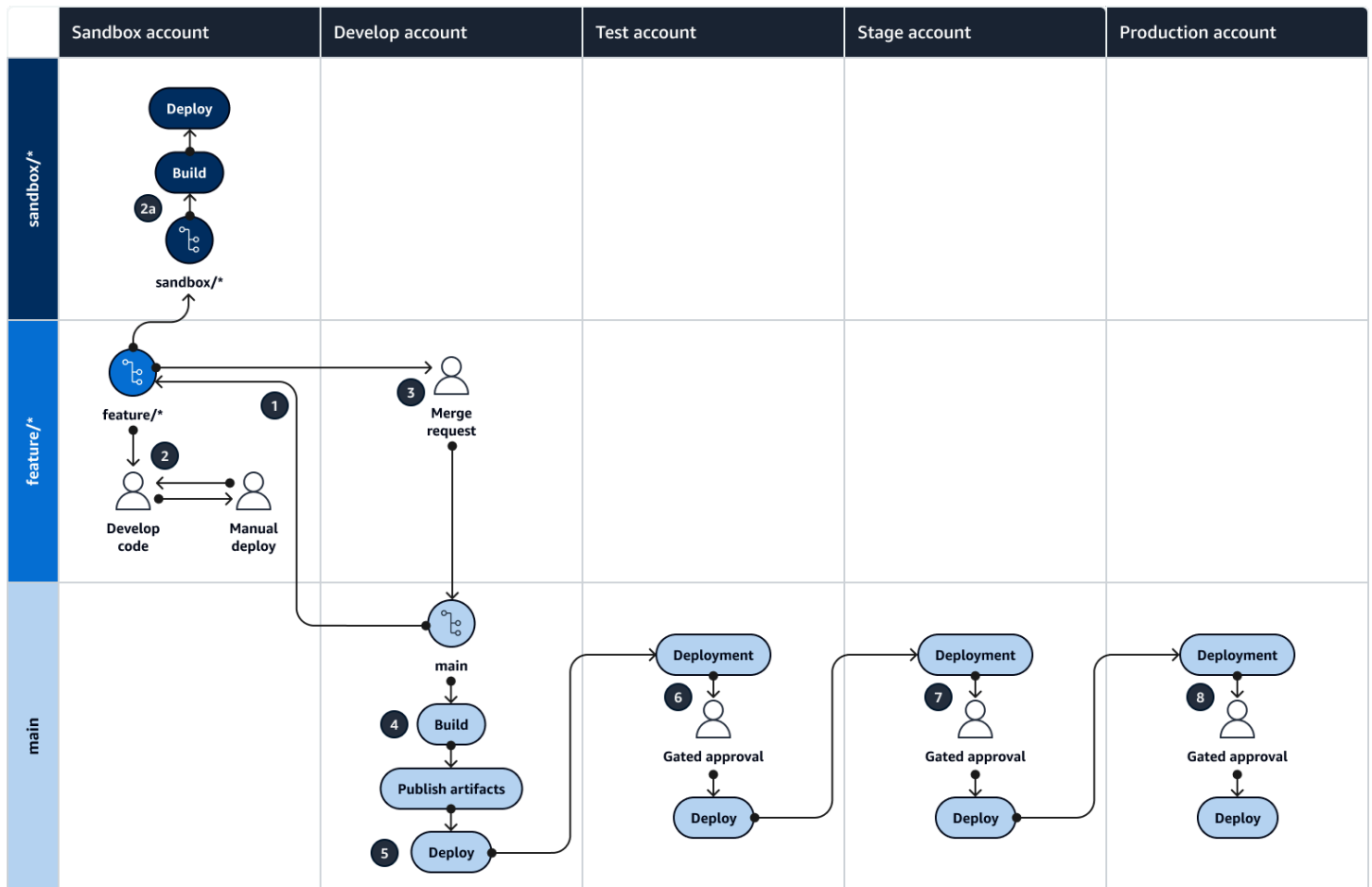

For more information about the AWS accounts, environments, and branches in a Trunk approach, see [Choosing a Git branching strategy for multi-account DevOps environments](#).

### Automation and scale

Continuous integration and continuous delivery (CI/CD) is the process of automating the software release lifecycle. It automates much or all of the manual processes traditionally required to get new code from an initial commit into production. A CI/CD pipeline encompasses the sandbox, development, testing, staging, and production environments. In each environment, the CI/CD pipeline provisions any infrastructure that is needed to deploy or test the code. By using CI/CD, development teams can make changes to code that are then automatically tested and deployed. CI/CD pipelines also provide governance and guardrails for development teams by enforcing consistency, standards, best practices, and minimal acceptance levels for feature acceptance and deployment. For more information, see [Practicing Continuous Integration and Continuous Delivery on AWS](#).

AWS offers a suite of developer services that are designed to help you build CI/CD pipelines. For example, [AWS CodePipeline](#) is a fully managed continuous delivery service that helps you automate your release pipelines for fast and reliable application and infrastructure updates. [AWS CodeCommit](#) is designed to securely host scalable Git repositories, and [AWS CodeBuild](#) compiles source code, runs tests, and produces ready-to-deploy software packages. For more information, see [Developer Tools on AWS](#).

## Tools

### AWS services and tools

AWS provides a suite of developer services that you can use to implement this pattern:

- [AWS CodeArtifact](#) is a highly scalable, managed artifact repository service that helps you store and share software packages for application development.
- [AWS CodeBuild](#) is a fully managed build service that helps you compile source code, run unit tests, and produce artifacts that are ready to deploy.
- [AWS CodeCommit](#) is a version control service that helps you privately store and manage Git repositories, without needing to manage your own source control system.
- [AWS CodeDeploy](#) automates deployments to Amazon Elastic Compute Cloud (Amazon EC2) or on-premises instances, AWS Lambda functions, or Amazon Elastic Container Service (Amazon ECS) services.
- [AWS CodePipeline](#) helps you quickly model and configure the different stages of a software release and automate the steps required to release software changes continuously.

### Other tools

- [Draw.io Desktop](#) – An application for making flowcharts and diagrams.
- [Figma](#) is an online design tool designed for collaboration. The code repository contains templates in .fig format for Figma.

### Code repository

This source file for the diagram in this pattern is available in the GitHub [Git Branching Strategy for Trunk](#) repository. It includes files in PNG, draw.io, and Figma formats. You can modify these diagrams to support your organization's processes.

## Best practices

Follow the best practices and recommendations in [AWS Well-Architected DevOps Guidance](#) and [Choosing a Git branching strategy for multi-account DevOps environments](#). These help you effectively implement Trunk-based development, foster collaboration, improve code quality, and streamline the development process.

## Epics

### Reviewing the Trunk workflow

Task	Description	Skills required
Review the standard Trunk process.	<ol style="list-style-type: none"><li>1. In the sandbox environment, the developer creates a feature branch from the main branch and uses the naming pattern <code>feature/&lt;ticket&gt;_&lt;initials&gt;_&lt;short description&gt;</code> .</li><li>2. The developer develops code and deploys the code to the sandbox environment iteratively in order to complete the ticket.  <b>Note:</b> The developer can optionally create a sandbox branch to run an automated build or deploy pipeline in the sandbox environment.</li><li>3. The developer creates a merge request from the feature branch into the</li></ol>	DevOps engineer

Task	Description	Skills required
	<p>main branch by using a squash merge.</p> <ol style="list-style-type: none"><li data-bbox="592 317 1027 636">4. A continuous integration and continuous delivery (CI/CD) pipeline automatically builds and publishes the artifacts from the main branch to the development environment.</li><li data-bbox="592 663 1027 884">5. An approver manually approves the deployment of the release artifacts to the development environment.</li><li data-bbox="592 911 1027 1087">6. An approver manually approves the deployment of the release artifacts to the testing environment.</li><li data-bbox="592 1115 1027 1291">7. An approver manually approves the deployment of the release artifacts to the staging environment.</li><li data-bbox="592 1318 1027 1528">8. An approver manually approves the deployment of the release artifacts to the production environment.</li></ol>	

# Troubleshooting

Issue	Solution
Branch conflicts	A common issue that can occur with the Trunk model is where a hotfix needs to occur in production but a corresponding change needs to occur in a feature branch, where the same resources are being modified. We recommend that you frequently merge changes from <code>main</code> into lower branches to avoid significant conflicts on merge to <code>main</code> .

## Related resources

This guide doesn't include training for Git; however, there are many high-quality resources available on the internet if you need this training. We recommend that you start with the [Git documentation](#) site.

The following resources can help you with your Trunk branching journey in the AWS Cloud.

### AWS DevOps guidance

- [AWS DevOps Guidance](#)
- [AWS Deployment Pipeline Reference Architecture](#)
- [What is DevOps?](#)
- [DevOps resources](#)

### Trunk guidance

- [Trunk Based Development](#)

### Other resources

- [Twelve-factor app methodology](#) (12factor.net)

# Implement centralized custom Checkov scanning to enforce policy before deploying AWS infrastructure

Created by Benjamin Morris (AWS)

**Code repository:** [Centralized Checkov SAST](#)

**Environment:** Production

**Technologies:** DevOps; Security, identity, compliance

**AWS services:** AWS CloudFormation

## Summary

This pattern provides a GitHub Actions framework for writing custom Checkov policies in one repository that can be reused across a GitHub organization. By following this pattern, an information security team can write, add, and maintain custom policies based on company requirements. The custom policies can be pulled into all pipelines in the GitHub organization automatically. This approach can be used to enforce company standards for resources before the resources are deployed.

## Prerequisites and limitations

### Prerequisites

- An active AWS account
- A GitHub organization using GitHub Actions
- AWS infrastructure deployed with either HashiCorp Terraform or AWS CloudFormation

### Limitations

- This pattern is written for GitHub Actions. However, it can be adapted to similar continuous integration and continuous delivery (CI/CD) frameworks such as GitLab. No specific paid version of GitHub is required.
- Some AWS services aren't available in all AWS Regions. For Region availability, see [Service endpoints and quotas](#) in the AWS documentation, and choose the link for the service.

## Architecture

This pattern is designed to be deployed as a GitHub repository that contains a GitHub reusable workflow and custom Checkov policies. The reusable workflow can scan both Terraform and CloudFormation infrastructure as code (IaC) repositories.

The following diagram shows the **Reusable GitHub workflows repository** and **Custom Checkov policies repository** as separate icons. However, you can implement these repositories either as separate repositories or a single repository. The example code uses a single repository, with files for workflows (`.github/workflows`) and files for custom policies (`custom_policies` folder and the `.checkov.yml` config file) in the same repository.

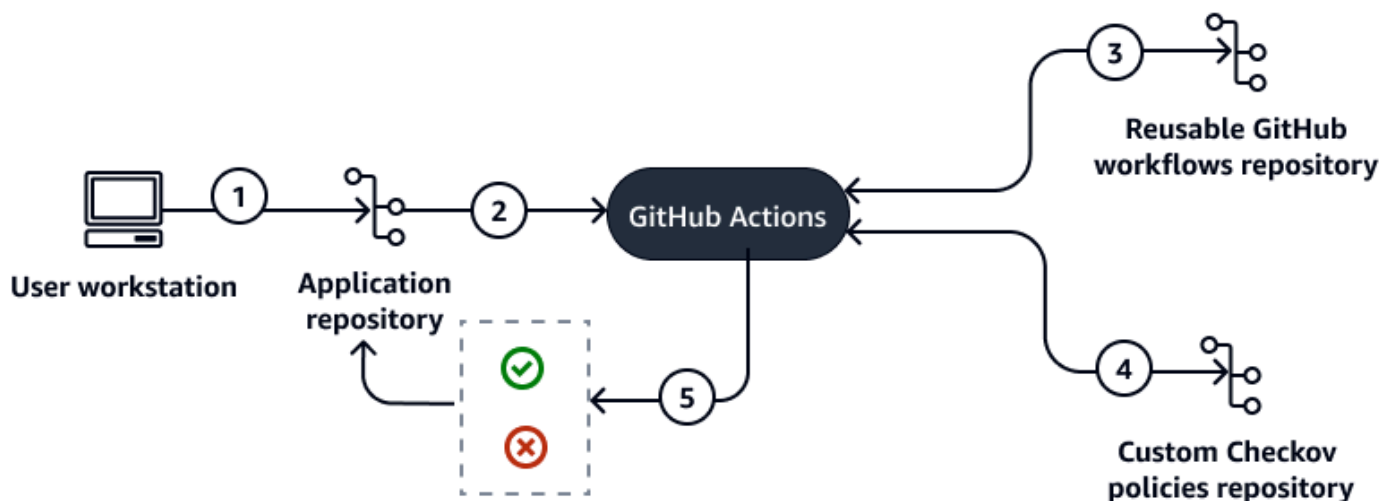

The diagram shows the following workflow:

1. A user creates a pull request in a GitHub repository.
2. Pipeline workflows start in GitHub Actions, including a reference to a Checkov reusable workflow.
3. The pipeline workflow downloads the referenced Checkov reusable workflow from an external repository and runs that Checkov workflow by using GitHub Actions.
4. The Checkov reusable workflow downloads the custom policies from an external repository.
5. The Checkov reusable workflow evaluates the IaC in the GitHub repository against both built-in and custom Checkov policies. The Checkov reusable workflow passes or fails based on whether security issues are found.

### Automation and scale

This pattern allows for central management of Checkov configuration, so that policy updates can be applied in one location. However, this pattern does require that each repository use a workflow that contains a reference to the central reusable workflow. You can add this reference manually or use scripts to push the file to the `.github/workflows` folder for each repository.

## Tools

### AWS services

- [AWS CloudFormation](#) helps you set up AWS resources, provision them quickly and consistently, and manage them throughout their lifecycle across AWS accounts and Regions. Checkov can scan CloudFormation.

### Other tools

- [Checkov](#) is a static code analysis tool that checks IaC for security and compliance misconfigurations.
- [GitHub Actions](#) is integrated into the GitHub platform to help you create, share, and run workflows within your GitHub repositories. You can use GitHub Actions to automate tasks such as building, testing, and deploying your code.
- [Terraform](#) is an IaC tool from HashiCorp that helps you create and manage cloud and on-premises resources. Checkov can scan Terraform.

### Code repository

The code for this pattern is available in the GitHub [centralized-custom-checkov-sast](#) repository.

## Best practices

- To maintain a consistent security posture, align your company's security policies with the Checkov policies.
- In the early phases of implementing Checkov custom policies, you can use the soft-fail option in your Checkov scan to allow IaC with security issues to be merged. As the process matures, switch from the soft-fail option to the hard-fail option.



## Epics

### Create a central Checkov repository for custom policies

Task	Description	Skills required
Create a central Checkov repository.	<p>Create a repository to store custom Checkov policies that will be used within the organization.</p> <p>For a quick start, you can copy the contents of this pattern's GitHub <a href="#">centralized-custom-checkov-sast</a> repository into your central Checkov repository.</p>	DevOps engineer
Create a repository for reusable workflows.	<p>If a repository for reusable workflows already exists, or you plan to include reusable workflow files in the same repository as the custom Checkov policies, you can skip this step.</p> <p>Create a GitHub repository to hold reusable workflows. Other repositories' pipelines will reference this repository.</p>	DevOps engineer

### Create reusable and example Checkov workflows

Task	Description	Skills required
Add a reusable Checkov workflow.	Create a reusable Checkov GitHub Actions workflow	DevOps engineer

Task	Description	Skills required
	<p>(YAML file) in the reusable workflows repository. You can adapt this reusable workflow from the workflow file provided in this pattern.</p> <p>An example of a change that you might want to make is to change the reusable workflow to use the soft-fail option. Setting <code>soft-fail</code> to <code>true</code> allows the job to complete successfully even if there is a failed Checkov scan. For instructions, see <a href="#">Hard and soft fail</a> in the Checkov documentation.</p>	
Add an example workflow.	<p>Add an example Checkov workflow that references the reusable workflow. This will provide a template for how to reuse the reusable workflow. In the example repository, <code>checkov-source.yaml</code> is the reusable workflow and <code>checkov-scan.yaml</code> is the example that consumes <code>checkov-source</code>.</p> <p>For more details about writing an example Checkov workflow, see <a href="#">Additional information</a>.</p>	DevOps engineer

## Associate company policies to Checkov custom policies

Task	Description	Skills required
<p>Determine policies that can be enforced with Checkov.</p>	<ol style="list-style-type: none"> <li>1. Review company policies that are related to infrastructure security and which requirements should be in place.</li> <li>2. Determine which requirements can be implemented by using Checkov custom policies.</li> <li>3. Create a naming convention that maps the policy control to the Checkov custom policy. Typically, Checkov custom policies have an identifier with a Checkov name, the policy source (custom), and a policy number (for example, CKV2_CUSTOM_123 ).</li> </ol> <p>For more details about creating Checkov custom policies, see <a href="#">Custom Policies Overview</a> in the Checkov documentation.</p>	<p>Security and Compliance</p>
<p>Add Checkov custom policies.</p>	<p>Convert the identified company policies to custom Checkov policies in the central repository. You can write</p>	<p>Security</p>

Task	Description	Skills required
	simple Checkov policies in either Python or YAML.	

## Implement centralized Checkov custom policies

Task	Description	Skills required
Add the Checkov reusable workflow to all repositories.	At this point, you should have an example Checkov workflow that references the reusable workflow. Copy the sample Checkov workflow that references the reusable workflow to each repository that requires it.	DevOps engineer
Create a mechanism to ensure that Checkov runs before merges.	To ensure that the Checkov workflow gets run for every pull request, create a <a href="#">status check</a> that requires a successful Checkov workflow before pull requests can be merged. GitHub allows you to require that specific workflows run before pull requests can be merged.	DevOps engineer
Create an organization-wide PAT, and share it as a secret.	If your GitHub organization is publicly visible, you can skip this step.  This pattern requires that the Checkov workflow be able to download custom policies from the custom	DevOps engineer

Task	Description	Skills required
	<p>policy repository in your GitHub organization. You must provide permissions such that the Checkov workflow can access those repositories.</p> <p>To do this, <a href="#">create a personal access token (PAT)</a> with permissions to read organization repositories. Share this PAT with repositories, either as an organization-wide secret (if on a paid plan) or a secret in each repository (free version). In the sample code, the default name for the secret is <code>ORG_PAT</code>.</p>	

Task	Description	Skills required
<p>(Optional) Protect the Checkov workflow files from modification.</p>	<p>To protect the Checkov workflow files from unwanted changes, you can use a <code>CODEOWNERS</code> file. The <code>CODEOWNERS</code> file is typically deployed in the root of the directory.</p> <p>For example, to require approvals from your GitHub organization's <code>secEng</code> group when the <code>checkov-scan.yaml</code> file is modified, append the following to a repository's <code>CODEOWNERS</code> file:</p> <pre>[Checkov] .github/workflows /checkov-scan.yaml @myOrg/secEng</pre> <p>A <code>CODEOWNERS</code> file is specific to the repository it lives in. To protect the Checkov workflow used by the repository, you must add (or update) a <code>CODEOWNERS</code> file in each repository.</p> <p>For more information about protecting Checkov workflow files, see <a href="#">Additional information</a>. For more information about <code>CODEOWNERS</code> files, see the official documentation for</p>	<p>DevOps engineer</p>

Task	Description	Skills required
	your CI/CD provider (such as <a href="#">GitHub</a> ).	

## Related resources

- [Checkov Custom Policies Overview](#)
- [CloudFormation Configuration Scanning](#)
- [GitHub Actions Reusable Workflows](#)

## Additional information

### Writing Checkov workflow files

When writing `checkov-scan.yaml`, consider when you want it to run. The top-level `on` key determines when the workflow runs. In the example repository, the workflow will run when there is a pull request targeting the `main` branch (and any time that pull request's source branch is modified). The workflow can also be run as required because of the `workflow_dispatch` key.

You can change the workflow trigger conditions based on how often you want the workflow to run. For example, you could change the workflow to run every time code is pushed to any branch by replacing `pull_request` with `push` and removing the `branches` key.

You can modify the example workflow file that you created within an individual repository. For example, you could adjust the target branch's name from `main` to `production` if a repository is structured around a `production` branch.

### Protecting Checkov workflow files

Checkov scanning provides useful information about potential security misconfiguration. However, some developers might perceive it to be a barrier to their productivity and attempt to remove or disable the scanning workflow.

There are several ways to address this problem, including better messaging about the long-term value of security scanning and clearer documentation about how to deploy secure infrastructure. These are important "soft" approaches to DevSecOps collaboration that can be seen as the solution

to this problem's root cause. However, you can also use technical controls such as a CODEOWNERS file as guardrails to help keep developers on the right path.

### Testing pattern in a sandbox

To test this pattern in a sandbox environment, follow these steps:

1. Create a new GitHub organization. Create a token with read-only access to all repositories in the organization. Because this token is for a sandbox environment, not a paid environment, you will not be able to store this token in an organization-wide secret.
2. Create a checkov repository to hold the Checkov configuration and a github-workflows repository to hold the reusable workflow configuration. Populate the repositories with the contents of the example repository.
3. Create an application repository, and copy and paste the checkov-scan.yaml workflow to its .github/workflows folder. Add a secret to the repository that contains the PAT you created for organization read-only access. The default secret is ORG\_PAT.
4. Create a pull request that adds some Terraform or CloudFormation code to the application repository. Checkov should scan and return a result.



# Automatically detect changes and initiate different CodePipeline pipelines for a monorepo in CodeCommit

Created by Helton Ribeiro (AWS), Petrus Batalha (AWS), and Ricardo Morais (AWS)

**Code repository:** [AWS CodeCommit monorepo multi-pipeline triggers](#)

**Environment:** PoC or pilot

**Technologies:** DevOps; Infrastructure; Serverless

**AWS services:** AWS CodeCommit; AWS CodePipeline; AWS Lambda

## Summary

This pattern helps you automatically detect changes to the source code of a monorepo-based application in AWS CodeCommit and then initiate a pipeline in AWS CodePipeline that runs the continuous integration and continuous delivery (CI/CD) automation for each microservice. This approach means that each microservice in your monorepo-based application can have a dedicated CI/CD pipeline, which ensures better visibility, easier sharing of code, and improved collaboration, standardization, and discoverability.

The solution described in this pattern doesn't perform any dependency analysis among the microservices inside the monorepo. It only detects changes in the source code and initiates the matching CI/CD pipeline.

The pattern uses AWS Cloud9 as the integrated development environment (IDE) and AWS Cloud Development Kit (AWS CDK) to define an infrastructure by using two AWS CloudFormation stacks: MonoRepoStack and PipelinesStack. The MonoRepoStack stack creates the monorepo in AWS CodeCommit and the AWS Lambda function that initiates the CI/CD pipelines. The PipelinesStack stack defines your pipeline infrastructure.

**Important:** This pattern's workflow is a proof of concept (PoC). We recommend that you use it only in a test environment. If you want to use this pattern's approach in a production environment, see [Security best practices in IAM](#) in the AWS Identity and Access Management (IAM) documentation and make the required changes to your IAM roles and AWS services.

## Prerequisites and limitations

### Prerequisites

- An active AWS account.
- AWS Command Line Interface (AWS CLI), installed and configured. For more information, see [Installing, updating, and uninstalling the AWS CLI](#) in the AWS CLI documentation.
- Python 3 and pip, installed on your local machine. For more information, see the [Python documentation](#).
- AWS CDK, installed and configured. For more information, see [Getting started with the AWS CDK](#) in the AWS CDK documentation.
- An AWS Cloud9 IDE, installed and configured. For more information, see [Setting up AWS Cloud9](#) in the AWS Cloud9 documentation.
- The GitHub [AWS CodeCommit monorepo multi-pipeline triggers](#) repository, cloned on your local machine.
- An existing directory containing application code that you want to build and deploy with CodePipeline.
- Familiarity and experience with DevOps best practices on the AWS Cloud. To increase your familiarity with DevOps, you can use the pattern [Build a loosely coupled architecture with microservices using DevOps practices and AWS Cloud9](#) on the AWS Prescriptive Guidance website.

### Architecture

The following diagram shows how to use the AWS CDK to define an infrastructure with two AWS CloudFormation stacks: MonoRepoStack and PipelinesStack.

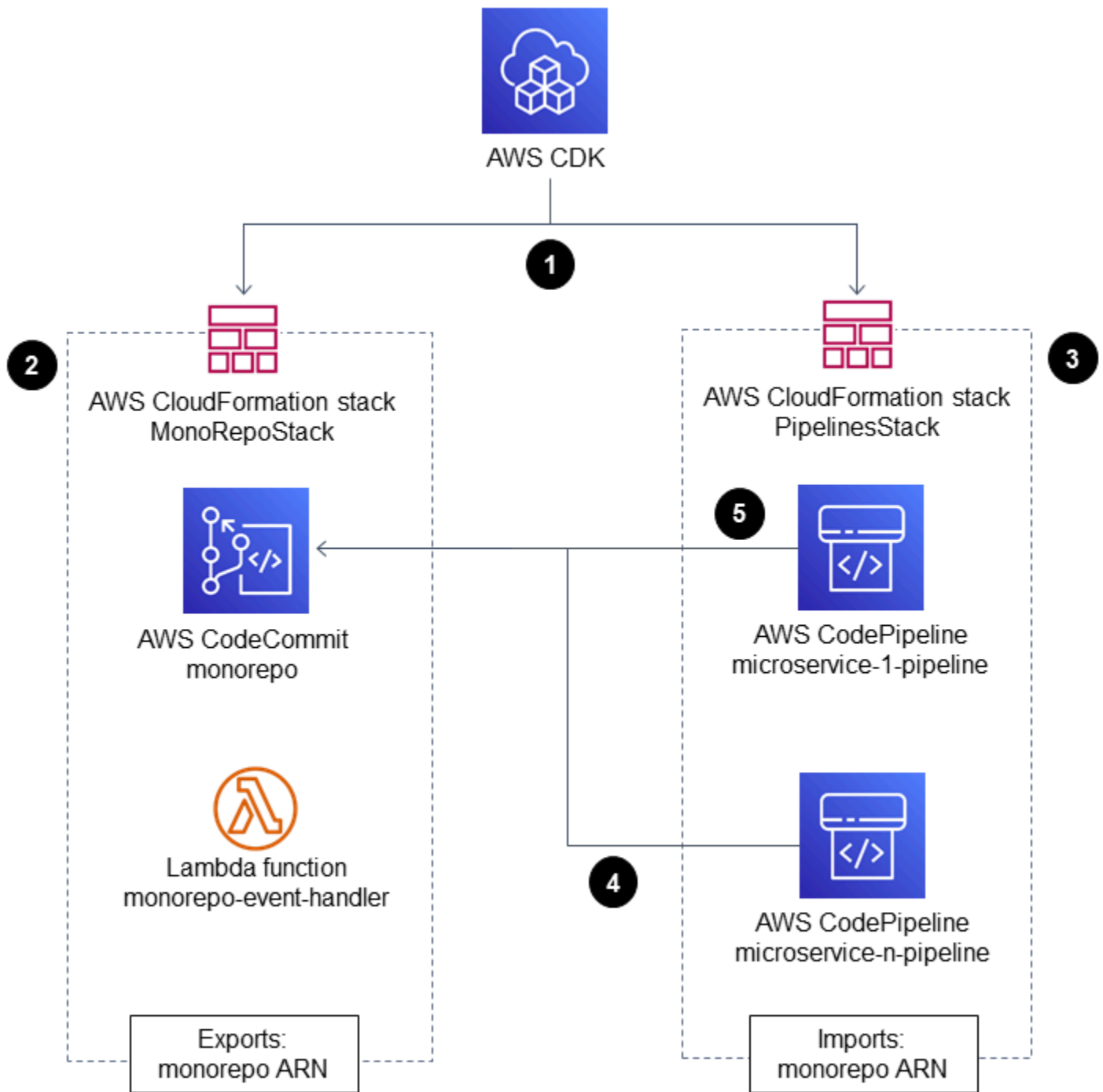

The diagram shows the following workflow:

1. The bootstrap process uses the AWS CDK to create the AWS CloudFormation stacks `MonoRepoStack` and `PipelinesStack`.
2. The `MonoRepoStack` stack creates the CodeCommit repository for your application and the `monorepo-event-handler` Lambda function that is initiated after each commit.

3. The PipelinesStack stack creates the pipelines in CodePipeline that are initiated by the Lambda function. Each microservice must have a defined infrastructure pipeline.
4. The pipeline for `microservice-n` is initiated by the Lambda function and starts its isolated CI/CD stages that are based on the source code in CodeCommit.
5. The pipeline for `microservice-1` is initiated by the Lambda function and starts its isolated CI/CD stages that are based on the source code in CodeCommit.

The following diagram shows the deployment of the AWS CloudFormation stacks MonoRepoStack and PipelinesStack in an account.

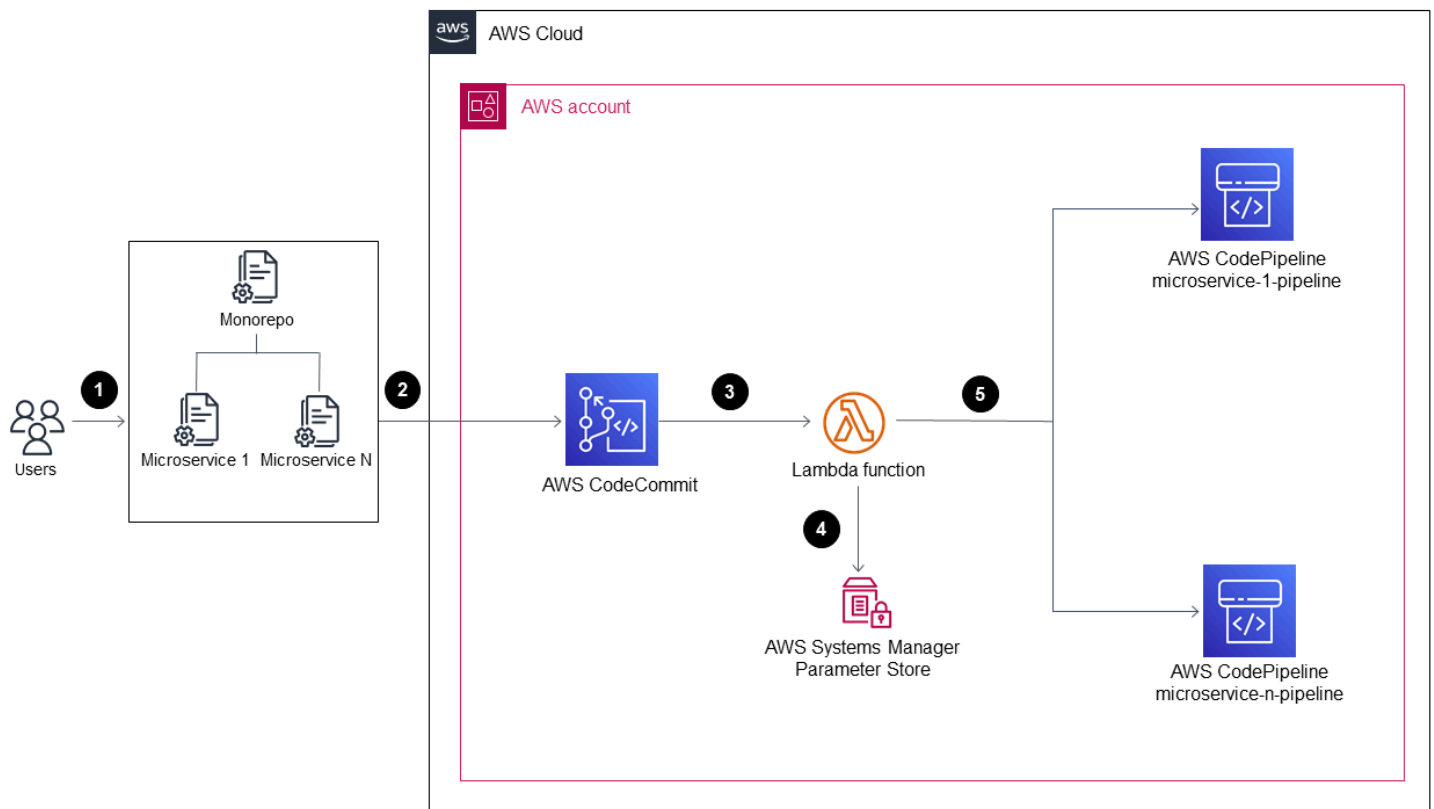

1. A user changes code in one of the application's microservices.
2. The user pushes the changes from a local repository to a CodeCommit repository.
3. The push activity initiates the Lambda function that receives all pushes to the CodeCommit repository.
4. The Lambda function reads a parameter in Parameter Store, a capability of AWS Systems Manager, to retrieve the most recent commit ID. The parameter has the naming format: `/MonoRepoTrigger/{repository}/{branch_name}/LastCommit`. If the parameter isn't

found, the Lambda function reads the last commit ID from the CodeCommit repository and saves the returned value in Parameter Store.

5. After identifying the commit ID and the changed files, the Lambda function identifies the pipelines for each microservice directory and initiates the required CodePipeline pipeline.

## Tools

- [AWS Cloud Development Kit \(AWS CDK\)](#) is a software development framework for defining cloud infrastructure in code and provisioning it through AWS CloudFormation.
- [Python](#) is a programming language that lets you work quickly and integrate systems more effectively.

## Code

The source code and templates for this pattern are available in the GitHub [AWS CodeCommit monorepo multi-pipeline triggers](#) repository.

## Best practices

- This sample architecture doesn't include a monitoring solution for the deployed infrastructure. If you want to deploy this solution in a production environment, we recommend that you enable monitoring. For more information, see [Monitor your serverless applications with CloudWatch Application Insights](#) in the AWS Serverless Application Model (AWS SAM) documentation.
- When you edit the sample code provided by this pattern, follow the [best practices for developing and deploying cloud infrastructure](#) in the AWS CDK documentation.
- When you define your microservice pipelines, review the [security best practices](#) in the AWS CodePipeline documentation.
- You can also check your AWS CDK code for best practices by using the [cdk-nag](#) utility. This tool uses a set of rules, grouped by packs, to evaluate your code. The available packs are:
  - [AWS Solutions Library](#)
  - [Health Insurance Portability and Accountability Act \(HIPAA\) security](#)
  - [National Institute of Standards and Technology \(NIST\) 800-53 rev 4](#)
  - [NIST 800-53 rev 5](#)
  - [Payment Card Industry Data Security Standard \(PCI DSS\) 3.2.1](#)

# Epics

## Set up the environment

Task	Description	Skills required
Create a virtual Python environment.	In your AWS Cloud9 IDE, create a virtual Python environment and install the required dependencies by running the following command:  <code>make install</code>	Developer
Bootstrap the AWS account and AWS Region for the AWS CDK.	Bootstrap the required AWS account and Region by running the following command:  <code>make bootstrap account-id=&lt;your-AWS-account-ID&gt; region=&lt;required-region&gt;</code>	Developer

## Add a new pipeline for a microservice

Task	Description	Skills required
Add your sample code to your application directory.	Add the directory that contains your sample application code to the <code>monorepo-sample</code> directory in the cloned GitHub <a href="#">AWS CodeCommi</a>	Developer

Task	Description	Skills required
	<a href="#">t monorepo multi-pipeline triggers</a> repository.	
Edit the <code>monorepo-main.json</code> file.	Add the directory name of your application's code and the pipeline's name to the <code>monorepo-main.json</code> file in the cloned repository .	Developer
Create the pipeline.	<p>In the <code>Pipelines</code> directory for the repository, add the pipeline class for your application. The directory contains two sample files, <code>pipeline_hotsite.py</code> and <code>pipeline_demo.py</code> . Each file has three stages: source, build, and deploy.</p> <p>You can copy one of the files and makes changes to it according to your application's requirements.</p>	Developer

Task	Description	Skills required
Edit the <code>monorepo_config.py</code> file.	<p>In <code>service_map</code>, add the directory name for your application and the class that you created for the pipeline.</p> <p>For example, the following code shows a pipeline definition in the <code>Pipelines</code> directory that uses a file named <code>pipeline_mysample.py</code> with a <code>MySamplePipeline</code> class:</p> <pre data-bbox="594 810 1026 1858">... # Pipeline definition imports from pipelines .pipeline_demo import DemoPipeline from pipelines.pipeline _hotsite import HotsitePipeline from pipelines .pipeline_mysample import MySampleP ipeline  ### Add your pipeline configuration here service_map: Dict[str, ServicePipeline] = {     # folder-name -&gt; pipeline-class     'demo': DemoPipel ine(),     'hotsite': HotsitePipeline(),     'mysample': MySamplePipeline()</pre>	Developer



Task	Description	Skills required
	}	

## Deploy the MonoRepoStack stack

Task	Description	Skills required
Deploy the AWS CloudFormation stack.	<p>Deploy the AWS CloudFormation MonoRepoStack stack with default parameter values in the root directory of the cloned repository by running the <code>make deploy-core</code> command.</p> <p>You can change the repository's name by running the <code>make deploy-core monorepo-name=&lt;repo_name&gt;</code> command.</p> <p><b>Note:</b> You can simultaneously deploy both pipelines by using the <code>make deploy monorepo-name=&lt;repo_name&gt;</code> command.</p>	Developer
Validate the CodeCommit repository.	<p>Validate that your resources were created by running the <code>aws codecommit get-repository --repository-name &lt;repo_name&gt;</code> command.</p> <p><b>Important:</b> Because the AWS CloudFormation stack creates</p>	Developer

Task	Description	Skills required
	<p>the CodeCommit repository where the monorepo is stored, don't run the <code>cdk destroy MonoRepoStack</code> command if you have started to push modifications into it.</p>	
<p>Validate the AWS CloudFormation stack results.</p>	<p>Validate that the AWS CloudFormation <code>MonoRepoStack</code> stack is correctly created and configured by running the following command:</p> <pre data-bbox="594 890 1029 1209">aws cloudformation   list-stacks --   stack-status-filter   CREATE_COMPLETE --   query 'StackSummaries[?   StackName == 'MonoRepo   Stack']'</pre>	<p>Developer</p>

## Deploy the PipelinesStack stack

Task	Description	Skills required
<p>Deploy the AWS CloudFormation stack.</p>	<p>The AWS CloudFormation <code>PipelinesStack</code> stack must be deployed after you deploy the <code>MonoRepoStack</code> stack. The stack increases in size when new microservices are added to the monorepo's code base and is redeploye</p>	<p>Developer</p>

Task	Description	Skills required
	<p>d when a new microservice is onboarded.</p> <p>Deploy the Pipelines Stack stack by running the <code>make deploy-pipelines</code> command.</p> <p><b>Note:</b> You can also deploy simultaneously deploy both pipelines by running the <code>make deploy monorepo-name=&lt;repo_name&gt;</code> command.</p> <p>The following sample output shows how the Pipelines Stacks deployment prints the URLs for the microservices at the end of the implementation:</p> <div data-bbox="594 1192 1029 1472" style="border: 1px solid #ccc; border-radius: 10px; padding: 10px; margin-top: 10px;"><pre>Outputs: PipelinesStack.dem ourl = .cloudfront.net PipelinesStack.hotsi teurl = .cloudfro nt.net</pre></div>	

Task	Description	Skills required
Validate the AWS CloudFormation stack results.	<p>Validate that the AWS CloudFormation Pipelines Stacks stack is correctly created and configured by running the following command:</p> <pre>aws cloudformation   list-stacks --stack-status-filter CREATE_COMPLETE UPDATE_COMPLETE   --query 'StackSummaries[?StackName == 'PipelinesStack']'</pre>	Developer

## Clean up resources

Task	Description	Skills required
Delete your AWS CloudFormation stacks.	Run the <code>make destroy</code> command.	Developer
Delete the S3 buckets for your pipelines.	<ol style="list-style-type: none"> <li>1. Sign in to the <a href="#">AWS Management Console</a> and open the <a href="#">Amazon Simple Storage Service (Amazon S3) console</a>.</li> <li>2. Delete the S3 buckets that are associated with your pipelines and use the following name: <code>pipelinesstack-cod epipeline*</code></li> </ol>	Developer

# Troubleshooting

Issue	Solution
I encountered AWS CDK issues.	See <a href="#">Troubleshooting common AWS CDK issues</a> in the AWS CDK documentation.
I pushed my microservice code, but the microservice pipeline didn't run.	<p><b>Setup validation</b></p> <p><i>Verify branch configuration:</i></p> <ul style="list-style-type: none"><li>• Make sure that you are pushing your code to the correct branch. This pipeline is configured to run only when changes are made to the main branch. Pushes to other branches don't initiate the pipeline unless they are configured specifically.</li><li>• After you push your code, check if the commit is visible in AWS CodeCommit to make sure that the push was successful and that the connection between your local environment and the repository is intact. Refresh your credentials if there are issues pushing code.</li></ul> <p><i>Validate configuration files:</i></p> <ul style="list-style-type: none"><li>• Confirm that the <code>service_map</code> variable in <code>monorepo_config.py</code> accurately reflects the current directory structure of your microservices. This variable plays a crucial role in mapping your code push to the respective pipeline.</li><li>• Make sure that <code>monorepo-main.json</code> is updated to include the new mapping for your microservice. This file is essential</li></ul>

Issue	Solution
	<p>for the pipeline to recognize and correctly handle changes to your microservice.</p> <p><b>Troubleshooting on the console</b></p> <p><i>AWS CodePipeline checks:</i></p> <ul style="list-style-type: none"><li>• On the <a href="#">AWS Management Console</a>, confirm that you're in the AWS Region where your pipeline is hosted. Open the <a href="#">CodePipeline console</a> and check if the pipeline that corresponds to your microservice has been initiated.</li></ul> <p><b>Error analysis:</b> If the pipeline was initiated but failed, review any error messages or logs provided by CodePipeline to understand what went wrong.</p> <p><i>AWS Lambda troubleshooting:</i></p> <ul style="list-style-type: none"><li>• On the <a href="#">AWS Lambda console</a>, open the <code>monorepo-event-handler</code> Lambda function. Verify that the function was initiated in response to the code push.</li></ul> <p><b>Log analysis:</b> Examine the Lambda function's logs for any issues. The logs can provide detailed insights into what happened when the function ran and help identify whether the function processed the event as expected.</p>

Issue	Solution
I need to redeploy all my microservices.	<p>There are two approaches to force the redeployment of all microservices. Choose the option that fits your requirements.</p> <p><b>Approach 1: Delete a parameter in Parameter Store</b></p> <p>This method involves deleting a specific parameter within Systems Manager Parameter Store that tracks the last commit ID used for deployment. When you remove this parameter, the system is forced to redeploy all microservices upon the next trigger, because it perceives it as a fresh state.</p> <p>Steps:</p> <ol style="list-style-type: none"><li>1. Locate the specific Parameter Store entry that holds the commit ID or a related deployment marker for your monorepo. The parameter name follows the format: <code>"/MonoRepoTrigger/{repository}/{branch_name}/LastCommit"</code></li><li>2. Consider backing up the parameter value if it's critical or if you wish to maintain a record of the deployment state before resetting it.</li><li>3. Use the AWS Management Console, AWS CLI, or SDKs to delete the identified parameter. This action resets the deployment marker.</li><li>4. After deletion, the next push to the repository should cause the system to deploy all microservices, because it looks</li></ol>

Issue	Solution
	<p>for the latest commit to consider for deployment.</p> <p>Pros:</p> <ul style="list-style-type: none"><li>• Simple and quick to implement with minimal steps.</li><li>• Doesn't require making arbitrary code changes to initiate deployments.</li></ul> <p>Cons:</p> <ul style="list-style-type: none"><li>• Less granular control over the deployment process.</li><li>• Potentially risky if the Parameter Store is used for managing other critical configurations.</li></ul> <p><b>Approach 2: Push a commit in each monorepo subfolder</b></p> <p>This method involves making a minor change and pushing it in each microservice subfolder within the monorepo to initiate their individual pipelines.</p> <p>Steps:</p> <ol style="list-style-type: none"><li>1. List all the microservices within the monorepo that need redeployment.</li><li>2. For each microservice, make a minimal, non-impactful change in its subfolder. This might be updating a README file, adding a comment in a configuration file, or any</li></ol>



Issue	Solution
	<p>change that doesn't affect the service's functionality.</p> <ol style="list-style-type: none"><li>3. Commit these changes with a clear message (such as "Initiate redeployment of microservices") and push them to the repository. Make sure that you push the changes to the branch that initiates the deployment.</li><li>4. Monitor the pipelines for each microservice to confirm that they are initiated and complete successfully.</li></ol> <p>Pros:</p> <ul style="list-style-type: none"><li>• Provides granular control over which microservices are redeployed.</li><li>• Safer because it doesn't involve deleting configuration parameters that might be used for other purposes.</li></ul> <p>Cons:</p> <ul style="list-style-type: none"><li>• More time-consuming, especially with a large number of microservices.</li><li>• Requires making unnecessary code changes that could clutter the commit history.</li></ul>

## Related resources

- [Continuous integration and delivery \(CI/CD\) using CDK Pipelines](#) (AWS CDK documentation)
- [aws-cdk/pipelines module](#) (AWS CDK API reference)

# Integrate a Bitbucket repository with AWS Amplify using AWS CloudFormation

Created by Alwin Abraham (AWS)

**Environment:** Production

**Technologies:** DevOps

**AWS services:** AWS Amplify;  
AWS CloudFormation

## Summary

AWS Amplify helps you to quickly deploy and test static websites without having to set up the infrastructure that is typically required. You can deploy this pattern's approach if your organization wants to use Bitbucket for source control, whether to migrate existing application code or build a new application. By using AWS CloudFormation to automatically set up Amplify, you provide visibility into the configurations that you use.

This pattern describes how to create a front-end continuous integration and continuous deployment (CI/CD) pipeline and deployment environment by using AWS CloudFormation to integrate a Bitbucket repository with AWS Amplify. The pattern's approach means that you can build an Amplify front-end pipeline for repeatable deployments.

## Prerequisites and limitations

### Prerequisites

- An active Amazon Web Services (AWS) account
- An active Bitbucket account with administrator access
- Access to a terminal that uses [cURL](#) or the [Postman](#) application
- Familiarity with Amplify
- Familiarity with AWS CloudFormation
- Familiarity with YAML-formatted files

## Architecture

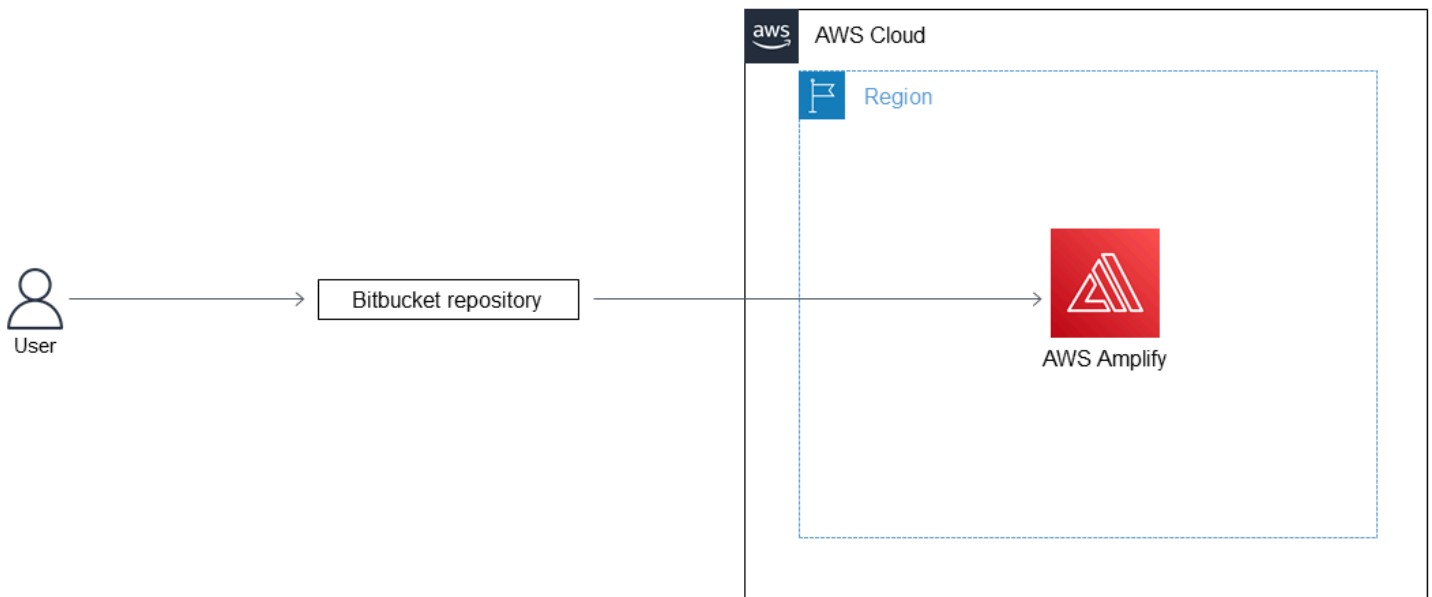

## Technology stack

- Amplify
- AWS CloudFormation
- Bitbucket

## Tools

- [AWS Amplify](#) – Amplify helps developers to develop and deploy cloud-powered mobile and web apps.
- [AWS CloudFormation](#) – AWS CloudFormation is a service that helps you model and set up your AWS resources so that you can spend less time managing those resources and more time focusing on your applications that run in AWS.
- [Bitbucket](#) – Bitbucket is a Git repository management solution designed for professional teams. It gives you a central place to manage Git repositories, collaborate on your source code, and guide you through the development flow.

## Code

The `bitbucket-amplify.yml` file (attached) contains the AWS CloudFormation template for this pattern.

# Epics

## Configure the Bitbucket repository

Task	Description	Skills required
(Optional) Create a Bitbucket repository.	<ol style="list-style-type: none"> <li>1. Sign in to your Bitbucket account and create a new repository. For more information about this, see <a href="#">Create a Git repository</a> in the Bitbucket documentation.</li> <li>2. Record the workspace's name.</li> </ol> <p><b>Note:</b> You can also use an existing Bitbucket repository.</p>	DevOps engineer
Open the workspace settings.	<ol style="list-style-type: none"> <li>1. Open the workspace and choose the <b>Repository</b> tab.</li> <li>2. Choose the repository that you want to integrate with Amplify.</li> <li>3. Choose the name of the workspace that is above the repository's name.</li> <li>4. On the sidebar, choose <b>Settings</b>.</li> </ol>	DevOps engineer
Create an OAuth consumer.	<ol style="list-style-type: none"> <li>1. In the <b>Apps and Features</b> section, choose <b>OAuth consumers</b>, and then choose <b>Add consumer</b>.</li> </ol>	DevOps engineer

Task	Description	Skills required
	<ol style="list-style-type: none"><li>2. Enter a name for your consumer, for example, Amplify Integration .</li><li>3. Enter a callback URL. Although this field is a required input, it's not used to complete the integration so the value could be <code>http://localhost:3000</code></li><li>4. Check the box for <b>This is a private consumer</b>.</li><li>5. Choose the following permissions:<ul style="list-style-type: none"><li>• <b>Project</b> – Read</li><li>• <b>Repositories</b> – Admin</li><li>• <b>Pull requests</b> – Read</li><li>• <b>Webhooks</b> – Read and Write</li></ul></li><li>6. Leave the default choices for all the other fields and choose <b>Submit</b>.</li><li>7. Record the key and secret that are generated.</li></ol>	

Task	Description	Skills required
Obtain OAuth access token.	<p>1. Open a terminal window and run the following command:</p> <pre>curl -X POST -u "KEY:SECRET" https://bitbucket.org/site/oauth2/access_token -d grant_type=client_credentials</pre> <p><b>Important:</b> Replace KEY and SECRET with the key and secret that you recorded earlier.</p> <p>2. Record the access token without using the quotation marks. The token is only valid for a limited time and the default time is two hours. You must run the AWS CloudFormation template in this timeframe.</p>	DevOps engineer

## Create and deploy the AWS CloudFormation stack

Task	Description	Skills required
Download the AWS CloudFormation template.	Download the bitbucket -amplify.yml AWS CloudFormation template (attached). This template creates the CI/CD pipeline in	

Task	Description	Skills required
	Amplify, in addition to the Amplify project and branch.	

Task	Description	Skills required
Create and deploy the AWS CloudFormation stack.	<ol style="list-style-type: none"><li>1. Sign in to the AWS Management Console in the AWS Region that you want to deploy in and open the AWS CloudFormation console.</li><li>2. Choose <b>Create Stack (with new resources)</b> and then choose <b>Upload a Template File</b>.</li><li>3. Upload the <code>bitbucket-amplify.yml</code> file.</li><li>4. Choose <b>Next</b>, enter a stack name, and then enter the following parameters:<ul style="list-style-type: none"><li>• <b>Access token:</b> Paste the OAuth access token that you created earlier.</li><li>• <b>Repository URL:</b> Add the Bitbucket project repository's URL. The URL is typically in the following format: <code>https://bitbucket.org/&lt;WORKSPACE_NAME&gt;/&lt;REPO_NAME&gt;</code></li><li>• <b>Branch name:</b> This must match the name of a branch in your Bitbucket repository. This branch doesn't need to exist when you run the AWS</li></ul></li></ol>	DevOps engineer



Task	Description	Skills required
	<p>CloudFormation stack but it is required for deploying code to the environment.</p> <ul style="list-style-type: none"> <li>• <b>Project name:</b> This is the name to associate with the Amplify project.</li> </ul> <p>5. Choose <b>Next</b> and then choose <b>Create Stack</b>.</p>	

## Test the CI/CD pipeline

Task	Description	Skills required
<p>Deploy the code to the branch in your repository.</p>	<ol style="list-style-type: none"> <li>1. Clone your Bitbucket repository by running the following command:  <pre>git clone https://bitbucket.org/&lt;WORKSPACE_NAME&gt;/&lt;REPO_NAME&gt;</pre> </li> <li>2. Check out the branch name that was used when running the AWS CloudFormation script. To create and check out a new branch, run the <code>git checkout -b &lt;BRANCH_NAME&gt;</code> command. To check out an existing branch, run the <code>git checkout</code></li> </ol>	<p>App developer</p>

Task	Description	Skills required
	<p data-bbox="630 212 878 289">&lt;BRANCH_NAME&gt; command</p> <ol data-bbox="592 317 1008 646" style="list-style-type: none"><li data-bbox="592 317 1008 541">3. Commit the code into the branch and push it to the remote branch by running the <code>git commit</code> and <code>git push</code> commands.</li><li data-bbox="592 562 1008 646">4. Amplify then builds and deploys the application.</li></ol> <p data-bbox="592 724 1008 898">For more information about this, see <a href="#">Basic Git commands</a> in the Bitbucket documentation.</p>	

## Related resources

[Authentication methods](#) (Atlassian documentation)

## Attachments

To access additional content that is associated with this document, unzip the following file:  
[attachment.zip](#)

# Launch a CodeBuild project across AWS accounts using Step Functions and a Lambda proxy function

Created by Richard Milner-Watts (AWS) and Amit Anjarlekar (AWS)

**Code repository:** [Cross-Account CodeBuild Proxy](#)

**Environment:** Production

**Technologies:** DevOps; Management & governance; Operations; Serverless

**AWS services:** AWS CodeBuild; AWS Lambda; AWS Step Functions; AWS X-Ray; AWS CloudFormation

## Summary

This pattern demonstrates how to asynchronously launch an AWS CodeBuild project across multiple AWS accounts by using AWS Step Functions and an AWS Lambda proxy function. You can use the pattern's sample Step Functions state machine to test the success of your CodeBuild project.

CodeBuild helps you launch operational tasks using the AWS Command Line Interface (AWS CLI) from a fully-managed runtime environment. You can change the behavior of your CodeBuild project at runtime by overriding environment variables. Additionally, you can use CodeBuild to manage workflows. For more information, see [Service Catalog Tools](#) on the AWS Workshop website and [Schedule jobs in Amazon RDS for PostgreSQL using AWS CodeBuild and Amazon EventBridge](#) on the AWS Database Blog.

## Prerequisites and limitations

### Prerequisites

- Two active AWS accounts: a source account for invoking a Lambda proxy function with Step Functions and a target account for building a remote CodeBuild sample project

### Limitations

- This pattern cannot be used to copy [artifacts](#) between accounts.

## Architecture

The following diagram shows the architecture that this pattern builds.

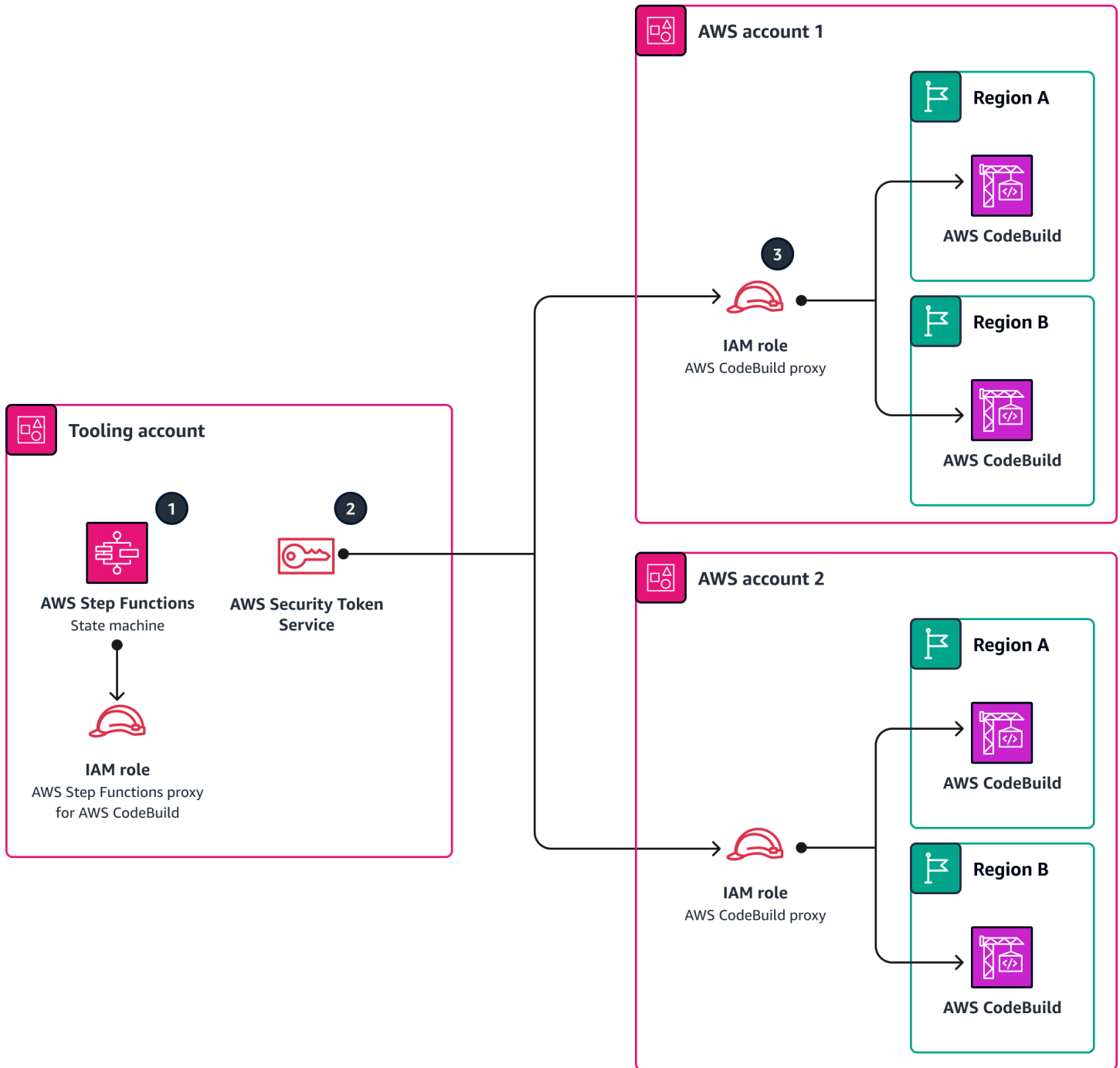

The diagram shows the following workflow:

1. The Step Functions state machine parses the supplied input map and invokes the Lambda proxy function (codebuild-proxy-lambda) for each account, Region, and project you defined.
2. The Lambda proxy function uses AWS Security Token Service (AWS STS) to assume an IAM proxy role (codebuild-proxy-role), which is associated with an IAM policy (codebuild-proxy-policy) in the target account.
3. Using the assumed role, the Lambda function launches the CodeBuild project and returns the CodeBuild job ID. The Step Functions state machine loops and polls the CodeBuild job until receiving a success or failure status.

The state machine logic is shown in the following image.

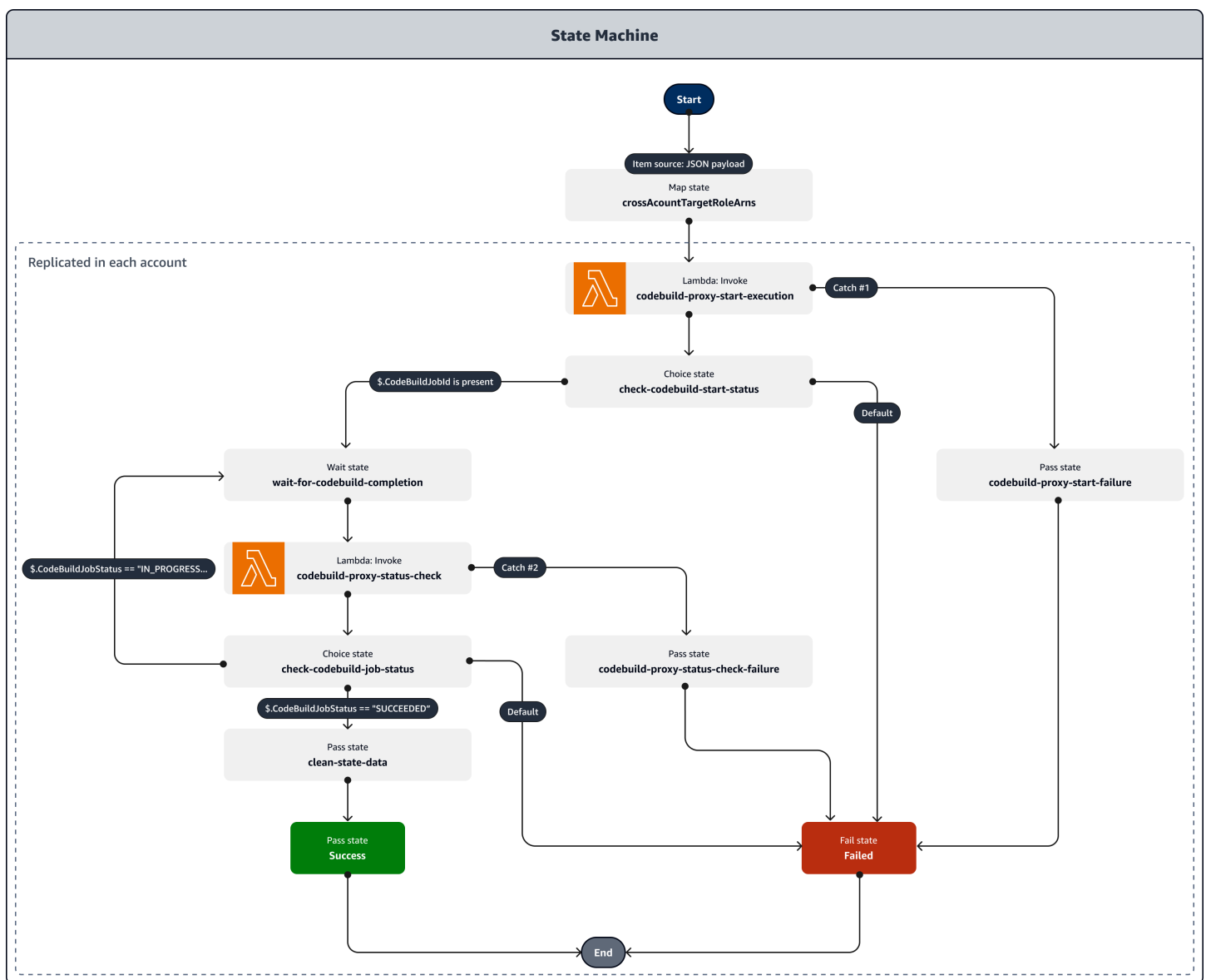

## Technology stack

- AWS CloudFormation
- CodeBuild
- IAM
- Lambda
- Step Functions
- X-Ray

## Tools

- [AWS CloudFormation](#) helps you set up AWS resources, provision them quickly and consistently, and manage them throughout their lifecycle across AWS accounts and Regions.
- [AWS CloudFormation Designer](#) provides an integrated JSON and YAML editor that helps you view and edit CloudFormation templates.
- [AWS CodeBuild](#) is a fully managed build service that helps you compile source code, run unit tests, and produce artifacts that are ready to deploy.
- [AWS Identity and Access Management \(IAM\)](#) helps you securely manage access to your AWS resources by controlling who is authenticated and authorized to use them.
- [AWS Lambda](#) is a compute service that helps you run code without needing to provision or manage servers. It runs your code only when needed and scales automatically, so you pay only for the compute time that you use.
- [AWS Step Functions](#) is a serverless orchestration service that helps you combine AWS Lambda functions and other AWS services to build business-critical applications.
- [AWS X-Ray](#) helps you collect data about the requests that your application serves, and provides tools that you can use to view, filter, and gain insights into that data to identify issues and opportunities for optimization.

## Code

The sample code for this pattern is available in the GitHub [Cross Account CodeBuild Proxy](#) repository. This pattern uses the AWS Lambda Powertools for Python library to provide logging and tracing functionality. For more information on this library and its utilities, see [Powertools for AWS Lambda \(Python\)](#).

## Best practices

1. Adjust the wait time values in the Step Function state machine to minimize polling requests for job status. Use the expected execution time for the CodeBuild project.
2. Adjust the MaxConcurrency property of the map in Step Functions to control how many CodeBuild projects can run in parallel.
3. If required, review the sample code for production readiness. Consider what data might be logged by the solution and whether the default Amazon CloudWatch encryption is sufficient.

## Epics

### Create the Lambda proxy function and associated IAM role in the source account

Task	Description	Skills required
Record the AWS account IDs.	<p>AWS account IDs are required to set up access across accounts.</p> <p>Record the AWS account ID for your source and target accounts. For more information, see <a href="#">Finding your AWS account ID</a> in the IAM documentation.</p>	AWS DevOps
Download the AWS CloudFormation templates.	<ol style="list-style-type: none"> <li>1. Download the sample_target_codebuild_template.yaml AWS CloudFormation template from the <a href="#">GitHub repository</a> for this pattern.</li> <li>2. Download the codebuild_lambda_proxy_template.yaml AWS CloudFormation template</li> </ol>	AWS DevOps

Task	Description	Skills required
	<p>from the <a href="#">GitHub repository</a> for this pattern.</p> <p><b>Note:</b> In the AWS CloudFormation templates, &lt;SourceAccountId&gt; is the AWS account ID for the source account, and &lt;TargetAccountId&gt; is the AWS account ID for the target account.</p>	



Task	Description	Skills required
Create and deploy the AWS CloudFormation stack.	<ol style="list-style-type: none"><li>1. Sign in to the AWS Management Console for your source account, open the <a href="#">AWS CloudFormation console</a>, and then choose <b>Stacks</b>.</li><li>2. Choose <b>Create Stack</b> and then choose <b>With new resources (standard)</b>.</li><li>3. For <b>Template source</b>, choose <b>Upload a template file</b>.</li><li>4. For <b>Upload a template file</b>, choose <b>file</b>, and then choose your downloaded <code>codebuild_lambda_proxy_template.yaml</code> file. Choose <b>Next</b>.</li><li>5. For <b>Stack name</b>, enter a name for the stack (for example, <code>codebuild-lambda-proxy</code> ).</li><li>6. Replace the <code>crossAccountTargetRoleArn</code> parameter with your <code>&lt;TargetAccountId&gt;</code> (for example, <code>&lt;arn:aws:iam::123456789012:role/proxy-lambda-codebuild-role&gt;</code> ). <b>Note:</b> You aren't required to update the default value for the <code>targetCod</code></li></ol>	AWS DevOps

Task	Description	Skills required
	<p>eBuildProject parameter.</p> <ol style="list-style-type: none"><li>7. Choose <b>Next</b>, accept the default stack creation options, and then chose <b>Next</b>.</li><li>8. Choose the <b>I acknowledge that AWS CloudFormation might create IAM resources with custom names</b> check box, and then choose <b>Create stack</b>.</li></ol> <p><b>Note:</b> You must create the AWS CloudFormation stack for the proxy Lambda function before creating any resources in target accounts. When you create a trust policy in a target account, the IAM role is translated from the role name to an internal identifier. This is why the IAM role must already exist.</p>	

Task	Description	Skills required
Confirm the creation of the proxy function and state machine.	<ol style="list-style-type: none"> <li>1. Wait for the AWS CloudFormation stack to reach <b>CREATE_COMPLETE</b> status. This should take less than one minute.</li> <li>2. Open the <a href="#">AWS Lambda console</a>, choose <b>Functions</b>, and then find the <code>lambda-proxy-ProxyLambda-&lt;GUID&gt;</code> function.</li> <li>3. Open the <a href="#">AWS Step Functions console</a>, choose <b>state machines</b>, and then find the <code>sample-crossaccount-codebuild-state-machine</code> state machine.</li> </ol>	AWS DevOps

### Create an IAM role in the target account and launch a sample CodeBuild project

Task	Description	Skills required
Create and deploy the AWS CloudFormation stack.	<ol style="list-style-type: none"> <li>1. Sign in to the AWS Management Console for your target account, open the <a href="#">AWS CloudFormation console</a>, and then choose <b>Stacks</b>.</li> <li>2. Choose <b>Create Stack</b> and then choose <b>With new resources (standard)</b>.</li> </ol>	AWS DevOps

Task	Description	Skills required
	<ol style="list-style-type: none"><li data-bbox="592 212 1027 338">3. For <b>Template source</b>, choose <b>Upload a template file</b>.</li><li data-bbox="592 363 1027 636">4. For <b>Upload a template file</b>, choose <b>Choose file</b>, and then choose the <code>sample_target_code_build_template.yaml</code> file. Choose <b>Next</b>.</li><li data-bbox="592 661 1027 842">5. For <b>Stack name</b>, enter a name for the stack (for example: <code>sample-codebuild-stack</code> ).</li><li data-bbox="592 867 1027 1236">6. Replace the <code>crossAccountSourceRoleArn</code> parameter with your <code>&lt;SourceAccountId&gt;</code> (for example, <code>&lt;arn:aws:iam::123456789012:role/codebuild-proxy-lambda-role&gt;</code> ).</li><li data-bbox="592 1262 1027 1442">7. Choose <b>Next</b>, accept the default stack creation options, and then choose <b>Next</b>.</li><li data-bbox="592 1467 1027 1740">8. Choose the <b>I acknowledge that AWS CloudFormation might create IAM resources with custom names</b> check box, and then choose <b>Create stack</b>.</li></ol>	

Task	Description	Skills required
Verify the creation of the sample CodeBuild project.	<ol style="list-style-type: none"> <li>1. Wait for the AWS CloudFormation stack to reach <b>CREATE_COMPLETE</b> status. This should take less than one minute.</li> <li>2. Open the <a href="#">AWS CodeBuild console</a> and then find the <code>sample-codebuild-project</code> project.</li> </ol>	AWS DevOps

### Test the cross-account Lambda proxy function

Task	Description	Skills required
Launch the state machine.	<ol style="list-style-type: none"> <li>1. Sign in to the AWS Management Console for your source account, open the <a href="#">AWS Step Functions console</a>, and then choose <b>State machines</b>.</li> <li>2. Choose the <code>sample-crossaccount-codebuild-state-machine</code> state machine and then choose <b>Start execution</b>.</li> <li>3. In the <b>Input</b> editor, enter the following JSON, and replace <code>&lt;TargetAccountID&gt;</code> with the AWS account ID of the account that contains the CodeBuild project.</li> </ol>	AWS DevOps

Task	Description	Skills required
	<pre data-bbox="646 226 1003 1066">{   "crossAccountTargetRoleArns": [     {       "arn": "arn:aws:iam::&lt;TargetAccountID&gt;:role/proxy-lambda-codebuild-role",       "region": "eu-west-1",       "codeBuildProject": "sample-codebuild-project",       "SampleValue1": "Value1",       "SampleValue2": "Value2"     }   ] }</pre> <p data-bbox="630 1121 1026 1394"><b>Note:</b> The key-value pairs are passed as environment variables from the function in the source account to the CodeBuild project in the target account.</p> <ol data-bbox="591 1415 1026 1793" style="list-style-type: none"><li>4. Choose <b>Start execution</b>.</li><li>5. On the <b>Details</b> tab of the state machine page, check if <b>Execution Status</b> is set to <b>Succeeded</b>. This confirms that your state machine is running. <b>Note:</b> It can take around 30 seconds for the</li></ol>	

Task	Description	Skills required
	<p>state machine to reach <b>Succeeded</b> status.</p> <p>6. To see the output and input of a step in the state machine, expand that step in the <b>Execution event history</b> section. For example, expand the <b>Lambda - CodeBuild Proxy – Start</b> step. The output includes details on the overridden environment variables, the original payload, and the CodeBuild job ID.</p>	

Task	Description	Skills required
Validate the environment variables.	<ol style="list-style-type: none"><li>1. Sign in to the AWS Management Console for your target account.</li><li>2. Open the <a href="#">AWS CodeBuild console</a>, expand <b>Build</b>, and then choose <b>Build projects</b>.</li><li>3. Choose the sample-codebuild-project project, and then choose <b>View details</b>.</li><li>4. On the <b>Build history</b> tab, choose the most recent build of the project, and then choose <b>View logs</b>.</li><li>5. In the log output, verify that the environment variables printed to STDOUT match the environment variables from the Step Functions sample state machine.</li></ol>	AWS DevOps

## Troubleshooting

Issue	Solution
Step Functions execution is taking longer than expected.	Adjust the <code>MaxConcurrency</code> property of the map in the Step Function state machine to control how many CodeBuild projects can run in parallel.



Issue	Solution
<p>The execution of the CodeBuild jobs is taking longer than expected.</p>	<ol style="list-style-type: none"><li data-bbox="831 226 1490 457">1. Adjust the wait time values in the Step Functions state machine to minimize polling requests for job status. Use the expected execution time for the CodeBuild project.</li><li data-bbox="831 478 1490 890">2. Consider whether CodeBuild is the appropriate tool to be using. For example, the time required to initialize a CodeBuild job can be significantly longer than AWS Lambda. If high throughput and fast completion times are a requirement, consider migrating the business logic to AWS Lambda and using a fan-out architecture.</li></ol>

# Manage blue/green deployments of microservices to multiple accounts and Regions by using AWS code services and AWS KMS multi-Region keys

Created by Balaji Vedagiri (AWS), Ashish Kumar (AWS), Faisal Shahdad (AWS), Anand Krishna Varanasi (AWS), Vanitha Dontireddy (AWS), and Vivek Thangamuthu (AWS)

**Code repository:** [ecs-blue-green-global-deployment-with-multiregion-cmk-codepipeline](#)

**Environment:** PoC or pilot

**Technologies:** DevOps; Containers & microservices

**AWS services:** AWS CloudFormation; AWS CodeBuild; AWS CodeDeploy; AWS CodePipeline; Amazon ECS

## Summary

This pattern describes how to deploy a global microservices application from a central AWS account to multiple workload accounts and Regions in accordance with a blue/green deployment strategy. The pattern supports the following:

- Software is developed in a central account, whereas workloads and applications are spread across multiple accounts and AWS Regions.
- A single AWS Key Management System (AWS KMS) multi-Region key is used for encryption and decryption to cover disaster recovery.
- The KMS key is Region-specific and has to be maintained or created in three different Regions for pipeline artifacts. A KMS multi-Region key helps retain the same key ID across Regions.
- The Git workflow branching model is implemented with two branches (development and main) and code is merged by using pull requests (PRs). The AWS Lambda function that is deployed from this stack creates a PR from the development branch to the main branch. The PR merge

to the main branch initiates an AWS CodePipeline pipeline, which orchestrates the continuous integration and continuous delivery (CI/CD) flow and deploys the stacks across accounts.

This pattern provides a sample infrastructure as code (IaC) setup through AWS CloudFormation stacks to demonstrate this use case. The blue/green deployment of microservices is implemented by using AWS CodeDeploy.

## Prerequisites and limitations

### Prerequisites

- Four active AWS accounts:
  - A tools account to manage the code pipeline and maintain the AWS CodeCommit repository.
  - Three workload (test) accounts for deploying the microservices workload.
- This pattern uses the following Regions. If you want to use other Regions, you must make the appropriate modifications to the AWS CodeDeploy and AWS KMS multi-Region stacks.
  - Tools (AWS CodeCommit) account: `ap-south-1`
  - Workload (test) account 1: `ap-south-1`
  - Workload (test) account 2: `eu-central-1`
  - Workload (test) account 3: `us-east-1`
- Three Amazon Simple Storage Service (Amazon S3) buckets for the deployment Regions in each workload account. (These are called `S3BUCKETNAMETESTACCOUNT1`, `S3BUCKETNAMETESTACCOUNT2` and `S3BUCKETNAMETESTACCOUNT3` later in this pattern.)

For example, you can create these buckets in specific accounts and Regions with unique bucket names as follows (replace `xxxx` with a random number):

```
##In Test Account 1
aws s3 mb s3://ecs-codepipeline-xxxx-ap-south-1 --region ap-south-1
##In Test Account 2
aws s3 mb s3://ecs-codepipeline-xxxx-eu-central-1 --region eu-central-1
##In Test Account 3
aws s3 mb s3://ecs-codepipeline-xxxx-us-east-1 --region us-east-1

#Example
##In Test Account 1
aws s3 mb s3://ecs-codepipeline-18903-ap-south-1 --region ap-south-1
##In Test Account 2
```

```
aws s3 mb s3://ecs-codepipeline-18903-eu-central-1 --region eu-central-1
##In Test Account 3
aws s3 mb s3://ecs-codepipeline-18903-us-east-1 --region us-east-1
```

## Limitations

The pattern uses AWS CodeBuild and other configuration files to deploy a sample microservice. If you have a different workload type (for example, serverless), you must update all relevant configurations.

## Architecture

### Target technology stack

- AWS CloudFormation
- AWS CodeCommit
- AWS CodeBuild
- AWS CodeDeploy
- AWS CodePipeline

### Target architecture

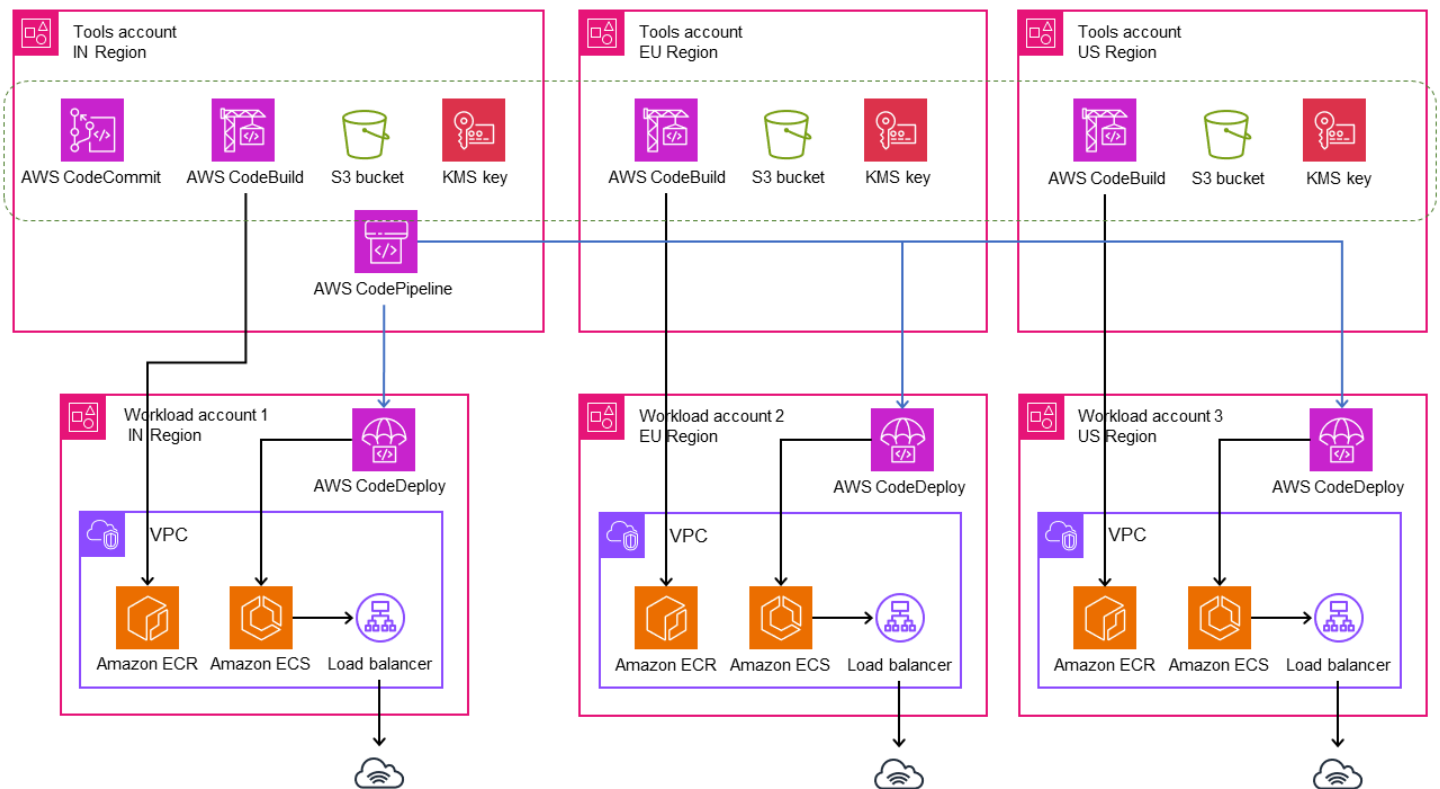

## Automation and scale

The setup is automated by using AWS CloudFormation stack templates (IaC). It can be easily scaled for multiple environments and accounts.

## Tools

### AWS services

- [AWS CloudFormation](#) helps you set up AWS resources, provision them quickly and consistently, and manage them throughout their lifecycle across AWS accounts and Regions.
- [AWS CodeBuild](#) is a fully managed build service that helps you compile source code, run unit tests, and produce artifacts that are ready to deploy.
- [AWS CodeCommit](#) is a version control service that helps you privately store and manage Git repositories, without needing to manage your own source control system.
- [AWS CodeDeploy](#) automates deployments to Amazon Elastic Compute Cloud (Amazon EC2) or on-premises instances, AWS Lambda functions, or Amazon Elastic Container Service (Amazon ECS) services.

- [AWS CodePipeline](#) helps you quickly model and configure the different stages of a software release and automate the steps required to release software changes continuously.
- [Amazon Elastic Container Registry \(Amazon ECR\)](#) is a managed container image registry service that's secure, scalable, and reliable.
- [Amazon Elastic Container Service \(Amazon ECS\)](#) is a fast and scalable container management service that helps you run, stop, and manage containers on a cluster.
- [AWS Key Management Service \(AWS KMS\)](#) helps you create and control cryptographic keys to help protect your data.
- [Amazon Simple Storage Service \(Amazon S3\)](#) is a cloud-based object storage service that helps you store, protect, and retrieve any amount of data.

### Additional tools

- [Git](#) is an open-source, distributed version control system that works with the AWS CodeCommit repository.
- [Docker](#) is a set of platform as a service (PaaS) products that use virtualization at the operating-system level to deliver software in containers. This pattern uses Docker to build and test container images locally.
- [cfn-lint](#) and [cfn-nag](#) are open-source tools that help you review CloudFormation stacks for any errors and security issues.

### Code repository

The code for this pattern is available in the GitHub [Global Blue/Green deployments in multiple regions and accounts](#) repository.

## Epics

### Set up environment variables

Task	Description	Skills required
Export environment variables for CloudFormation stack deployment.	Define environment variables that will be used as input to the CloudFormation stacks later in this pattern.	AWS DevOps

Task	Description	Skills required
	<ol style="list-style-type: none"><li data-bbox="592 212 1029 436">1. Update the bucket names that you created in the three accounts and Regions as explained earlier in the <a href="#">Prerequisites</a> section: <pre data-bbox="646 474 1029 869">export S3BUCKETN AMETESTACCOUNT1=&lt;S 3BUCKETACCOUNT1&gt; export S3BUCKETN AMETESTACCOUNT2=&lt;S 3BUCKETACCOUNT2&gt; export S3BUCKETN AMETESTACCOUNT3=&lt;S 3BUCKETACCOUNT3&gt;</pre></li><li data-bbox="592 890 1029 1066">2. Define a random string to create artifact buckets, because bucket names must be unique globally: <pre data-bbox="646 1104 1029 1297">export BUCKETSTA RTNAME=ecs-codepip eline-artifacts-19 992</pre></li><li data-bbox="592 1318 1029 1398">3. Define and export the account IDs and Regions: <pre data-bbox="646 1436 1029 1806">export TOOLSACCO UNT=&lt;TOOLSACCOUNT&gt; export CODECOMMI TACCOUNT=&lt;CODECOMM ITACCOUNT&gt; export CODECOMMI TREGION=ap-south-1 export CODECOMMI TREPONAME=Poc</pre></li></ol>	

Task	Description	Skills required
	<pre>export TESTACCOUNT1=&lt;TESTACCOUNT1&gt; export TESTACCOUNT2=&lt;TESTACCOUNT2&gt; export TESTACCOUNT3=&lt;TESTACCOUNT3&gt; export TESTACCOUNT1REGION=ap-south-1 export TESTACCOUNT2REGION=eu-central-1 export TESTACCOUNT3REGION=us-east-1 export TOOLSACCOUNTREGION=ap-south-1 export ECRREPOSITORYNAME=web</pre>	

## Package and deploy the CloudFormation stacks for the infrastructure

Task	Description	Skills required
Clone the repository.	<p>Clone the <a href="#">sample repository</a> into a new repository in your work location:</p> <pre>##In work location git clone https://github.com/aws-samples/ecs-blue-green-global-deployment-with-multiregion-cmk-codepipeline.git</pre>	AWS DevOps
Package the Cloudformation resources.	In this step, you package the local artifacts that the	AWS DevOps



Task	Description	Skills required
	<p>CloudFormation templates reference to create the infrastructure resources required for services such as Amazon Virtual Private Cloud (Amazon VPC) and Application Load Balancer.</p> <p>The templates are available in the <code>Infra</code> folder of the code repository.</p> <pre>##In TestAccount1## aws cloudformation package \   --template-file mainInfraStack.yaml \   --s3-bucket \$S3BUCKETNAMETESTA CCOUNT1 \   --s3-prefix infraStack \   --region \$TESTACCO UNT1REGION \   --output-template- file infrastructure_ \${TESTACCOUNT1}.templ ate</pre> <pre>##In TestAccount2## aws cloudformation package \   --template-file mainInfraStack.yaml \   --s3-bucket \$S3BUCKETNAMETESTA CCOUNT2 \   --s3-prefix infraStack \</pre>	

Task	Description	Skills required
	<pre>    --region \$TESTACCO     UNT2REGION \     --output-template-     file infrastructure_     \${TESTACCOUNT2}.templ     ate  ##In TestAccount3## aws cloudformation package \   --template-file   mainInfraStack.yaml \   --s3-bucket   \$S3BUCKETNAMETESTA   CCOUNT3 \   --s3-prefix   infraStack \   --region \$TESTACCO   UNT3REGION \   --output-template-   file infrastructure_   \${TESTACCOUNT3}.templ   ate</pre>	

Task	Description	Skills required
Validate the package templates.	<p>Validate the package templates:</p> <pre>aws cloudformation   validate-template \     --template-body   file://infrastructure_{\$TESTACCOUNT1 }.template  aws cloudformation   validate-template \     --template-body   file://infrastructure_{\$TESTACCOUNT2 }.template  aws cloudformation   validate-template \     --template-body   file://infrastructure_{\$TESTACCOUNT3 }.template</pre>	AWS DevOps

Task	Description	Skills required
Deploy the package files into the workload accounts,	<ol style="list-style-type: none"><li>1. Update the placeholder values and account names in the <code>infraParameters.json</code> script based on your setup.</li><li>2. Deploy the package templates into your three workload accounts.</li></ol> <pre data-bbox="634 646 1029 1770">##In TestAccount1## aws cloudformation   deploy \     --template-file       infrastructure_\${T ESTACCOUNT1}.templ ate \     --stack-name       mainInfrastack \     --parameter- overrides file://in fraParameters.json \     --region \$TESTACCO UNT1REGION \     --capabilities       CAPABILITY_IAM       CAPABILITY_NAMED_I AM  ##In TestAccount2## aws cloudformation   deploy \     --template-file       infrastructure_\${T ESTACCOUNT2}.templ ate \     --stack-name       mainInfrastack \</pre>	AWS DevOps

Task	Description	Skills required
	<pre> --parameter- overrides file://in fraParameters.json \   --region \$TESTACCO UNT2REGION \   --capabilities CAPABILITY_IAM CAPABILITY_NAMED_I AM  ##In TestAccount3## aws cloudformation deploy \   --template-file infrastructure_\${T ESTACCOUNT3}.templ ate \   --stack-name mainInfrastack \   --parameter- overrides file://in fraParameters.json \   --region \$TESTACCO UNT3REGION \   --capabilities CAPABILITY_IAM CAPABILITY_NAMED_I AM </pre>	

## Push a sample image and scale Amazon ECS

Task	Description	Skills required
Push a sample image to the Amazon ECR repository.	Push a sample (NGINX) image to the Amazon Elastic Container Registry (Amazon ECR) repository named web (as set in parameters). You	AWS DevOps

Task	Description	Skills required
	<p>can customize the image as required.</p> <p>To log in and set the credentials for pushing an image to Amazon ECR, follow the instructions in the <a href="#">Amazon ECR documentation</a>.</p> <p>The commands are:</p> <pre data-bbox="594 680 1029 1115">docker pull nginx docker images docker tag &lt;imageid&gt; aws_account_id.dkr .ecr.region.amazon aws.com/&lt;web&gt;:latest docker push &lt;aws_accou nt_id&gt;.dkr.ecr.&lt;r egion&gt;.amazonaws.com/ &lt;web&gt;:tag</pre>	

Task	Description	Skills required
Scale Amazon ECS and verify access.	<ol style="list-style-type: none"> <li>Scale Amazon ECS to create two replicas:           <div style="border: 1px solid #ccc; border-radius: 10px; padding: 10px; margin: 10px 0;"> <pre>aws ecs update-service --cluster QA-Cluster --service Poc-Service --desired-count 2</pre> </div> <p>where Poc-Service refers to your sample application.</p> </li> <li>Verify that the services are accessible from the Application Load Balancer by using a fully qualified domain name (FQDN) or DNS from a browser or by using the <b>curl</b> command.</li> </ol>	AWS DevOps

## Set up code services and resources

Task	Description	Skills required
Create a CodeCommit repository in the tools account.	Create a CodeCommit repository in the tools account by using the <code>codecommit.yaml</code> template, which is in the code folder of the GitHub repository. You must create this repository only in the single Region where you plan to develop the code.	AWS DevOps

Task	Description	Skills required
	<pre>aws cloudformation deploy --stack-name codecommitrepoStack --parameter-overrides CodeCommitReponame= \$CODECOMMITREPONAME \ ToolsAccount=\$TO OLSACCOUNT --templat e-file codecommit.yaml --region \$TOOLSACC OUNTREGION \ --capabilities CAPABILITY_NAMED_IAM</pre>	



Task	Description	Skills required
<p>Create an S3 bucket for managing artifacts generated by CodePipeline.</p>	<p>Create an S3 bucket for managing artifacts generated by CodePipeline by using the <code>pre-reqs-bucket.yaml</code> template, which is in the code folder of the GitHub repository. The stacks must be deployed in all three workload (test) and tools accounts and Regions.</p> <pre data-bbox="597 730 1024 1814"> aws cloudformation   deploy --stack-name     pre-reqs-artifacts   -bucket --parameter-     overrides BucketSta     rtName=\$BUCKETSTAR     TNAME \     TestAccount1=\$TE     STACCOUNT1 TestAccou     nt2=\$TESTACCOUNT2 \     TestAccount3=\$TE     STACCOUNT3 CodeComm     itAccount=\$CODECOMM     ITACCOUNT ToolsAcco     unt=\$TOOLSACCOUNT \     --template-file pre-     reqs_bucket.yaml     --region \$TESTACCO     UNT1REGION --capabil     ities CAPABILIT     Y_NAMED_IAM  aws cloudformation   deploy --stack-name     pre-reqs-artifacts   -bucket --parameter-     overrides BucketSta </pre>	<p>AWS DevOps</p>

Task	Description	Skills required
	<pre> rtName=\$BUCKETSTAR TNAME \ TestAccount1=\$TE STACCOUNT1 TestAccou nt2=\$TESTACCOUNT2 \ TestAccount3=\$TE STACCOUNT3 CodeComm itAccount=\$CODECOMM ITACCOUNT ToolsAcco unt=\$TOOLSACCOUNT \ --template-file pre- reqs_bucket.yaml --region \$TESTACCO UNT2REGION --capabil ities CAPABILIT Y_NAMED_IAM  aws cloudformation   deploy --stack-name   pre-reqs-artifacts   -bucket --parameter-   overrides BucketSta   rtName=\$BUCKETSTAR   TNAME \   TestAccount1=\$TE   STACCOUNT1 TestAccou   nt2=\$TESTACCOUNT2 \   TestAccount3=\$TE   STACCOUNT3 CodeComm   itAccount=\$CODECOMM   ITACCOUNT ToolsAcco   unt=\$TOOLSACCOUNT \   --template-file pre-   reqs_bucket.yaml   --region \$TESTACCO   UNT3REGION --capabil   ities CAPABILIT   Y_NAMED_IAM  aws cloudformation   deploy --stack-name   pre-reqs-artifacts </pre>	

Task	Description	Skills required
	<pre>-bucket --parameter- overrides BucketSta rtName=\$BUCKETSTAR TNAME \ TestAccount1=\$TE STACCOUNT1 TestAccou nt2=\$TESTACCOUNT2 \ TestAccount3=\$TE STACCOUNT3 CodeComm tAccount=\$CODECOMM ITACCOUNT ToolsAcco unt=\$TOOLSACCOUNT \ --template-file pre- reqs_bucket.yaml --region \$TOOLSACC OUNTREGION --capabil ities CAPABILIT Y_NAMED_IAM</pre>	

Task	Description	Skills required
Set up a multi-Region KMS key.	<p>1. Create a multi-Region KMS key with primary and replica keys that CodePipeline will use. In our example, ToolsAccount1region - ap-south-1 will be the primary Region.</p> <pre data-bbox="634 636 1029 1388">aws cloudformation   deploy --stack-name     ecs-codepipeline-p     re-reqs-KMS \   --template-file pre-     reqs_KMS.yaml --     parameter-overrides     \     TestAccount1=\$TE     STACCOUNT1 TestAccou     nt2=\$TESTACCOUNT2 \     TestAccount3=\$TE     STACCOUNT3 CodeComm     itAccount=\$CODECOMM     ITACCOUNT ToolsAcco     unt=\$TOOLSACCOUNT     --region \$TOOLSACC     OUNTREGION</pre> <p>2. Set the CMKARN variables to pass to CodeBuild projects. The values are available in the output of the ecs-codepipeline-pre-reqs-KMS template stack (the key ID will be same in all Regions and starts with <code>mk-</code>). Or, you can get the CMKARN values from the</p>	AWS DevOps

Task	Description	Skills required
	<p>tools account. Export them in all account sessions:</p> <pre>export CMKARN1=arn:aws:kms:ap-south-1:&lt;TOOLSACCOUNTID&gt;:key/mrk-xxx export CMKARN2=arn:aws:kms:eu-central-1:&lt;TOOLSACCOUNTID&gt;:key/mrk-xxx export CMKARN3=arn:aws:kms:us-east-1:&lt;TOOLSACCOUNTID&gt;:key/mrk-xxx export CMARNTOOLS=arn:aws:kms:ap-south-1:&lt;TOOLSACCOUNTID&gt;:key/mrk-xxx</pre>	

Task	Description	Skills required
Set up the CodeBuild project in the tools account.	<p>1. Use the <code>codebuild_IAM.yaml</code> template from the code folder of the GitHub repository to set up AWS Identity and Access Management (IAM) for AWS CodeBuild in a single Region in the tools account:</p> <pre data-bbox="634 684 1027 1157">#In ToolsAccount aws cloudformation   deploy --stack-name     ecs-codebuild-iam \   --template-file     codebuild_IAM.yaml   --region \$TOOLSACC     OUNTREGION \   --capabilities     CAPABILITY_NAMED_I     AM</pre> <p>2. Use the <code>codebuild.yaml</code> template to set up CodeBuild for your build project. Deploy this template in all three Regions as follows:</p> <pre data-bbox="634 1486 1027 1858">aws cloudformation   deploy --stack-name     ecscodebuildstack --   parameter-overrides     ToolsAccount=\$TOOL     SACCOUNT \   CodeCommitRepoName=     \$CODECOMMITREPONAME   ECRRepositoryName=</pre>	AWS DevOps

Task	Description	Skills required
	<pre> \$ECRREPOSITORYNAME   APPACCOUNTID=\$TEST ACCOUNT1 \ TestAccount3=\$TE STACCOUNT3 CodeCommi tRegion=\$CODECOMMI TREGION CMKARN=\$C MKARN1 \ --template-file   codebuild.yaml   --region \$TESTACCO UNT1REGION --capabil ities CAPABILIT Y_NAMED_IAM  aws cloudformation   deploy --stack-name   ecscodebuildstack -- parameter-overrides   ToolsAccount=\$TOOL SACCOUNT \ CodeCommitRepoName= \$CODECOMMITREPONAME   ECRRepositoryName= \$ECRREPOSITORYNAME   APPACCOUNTID=\$TEST ACCOUNT2 \ TestAccount3=\$TE STACCOUNT3 CodeCommi tRegion=\$CODECOMMI TREGION CMKARN=\$C MKARN2 \ --template-file   codebuild.yaml   --region \$TESTACCO UNT2REGION --capabil ities CAPABILIT Y_NAMED_IAM  aws cloudformation   deploy --stack-name   ecscodebuildstack -- </pre>	

Task	Description	Skills required
	<pre>parameter-overrides   ToolsAccount=\$TOOL SACCOUNT \ CodeCommitRepoName= \$CODECOMMITREPONAME   ECRRepositoryName= \$ECRREPOSITORYNAME   APPACCOUNTID=\$TEST ACCOUNT3 \ CodeCommitRegion= \$CODECOMMITREGION   CMKARN=\$CMKARN3 \ --template-file codebuild.yaml   --region \$TESTACCO UNT3REGION --capabil ities CAPABILIT Y_NAMED_IAM</pre>	



Task	Description	Skills required
Set up CodeDeploy in workload accounts.	<p>Use the <code>codedeploy.yaml</code> template in the code folder of the GitHub repository to set up CodeDeploy in all three workload accounts. The output of <code>mainInfraStack</code> includes the Amazon Resource Names (ARNs) of the Amazon ECS cluster and Application Load Balancer listener.</p> <p><b>Note:</b> The values from the infrastructure stacks are exported already, so they are imported by the CodeDeploy stack templates.</p> <pre>##WorkloadAccount1## aws cloudformation   deploy --stack-name     ecscodedeploystack \   --parameter-overrides     ToolsAccount=\$TOOL     SACCOUNT mainInfra     stackname=mainInfr     astack \   --template-file     codedeploy.yaml   --region \$TESTACCO   UNT1REGION --capabil     ities CAPABILIT     Y_NAMED_IAM  ##WorkloadAccount2## aws cloudformation   deploy --stack-name     ecscodedeploystack \</pre>	AWS DevOps

Task	Description	Skills required
	<pre> --parameter-overrides   ToolsAccount=\$TOOL SACCOUNT mainInfra stackname=mainInfr astack \ --template-file   codedeploy.yaml   --region \$TESTACCO UNT2REGION --capabil ities CAPABILIT Y_NAMED_IAM  ##WorkloadAccount3## aws cloudformation   deploy --stack-name   ecscodedeploystack \ --parameter-overrides   ToolsAccount=\$TOOL SACCOUNT mainInfra stackname=mainInfr astack \ --template-file   codedeploy.yaml   --region \$TESTACCO UNT3REGION --capabil ities CAPABILIT Y_NAMED_IAM </pre>	

## Set up CodePipeline in the tools account

Task	Description	Skills required
Create a code pipeline in the tools account.	<p>In the tools account, run the command:</p> <pre> aws cloudformation   deploy --stack-name   ecscodepipelinestack </pre>	AWS DevOps

Task	Description	Skills required
	<pre>--parameter-overrides \ TestAccount1=\$TE STACCOUNT1 TestAccou nt1Region=\$TESTACC OUNT1REGION \ TestAccount2=\$TE STACCOUNT2 TestAccou nt2Region=\$TESTACC OUNT2REGION \ TestAccount3=\$TE STACCOUNT3 TestAccou nt3Region=\$TESTACC OUNT3REGION \ CMKARNTools=\$CMK TROOLSARN CMKARN1= \$CMKARN1 CMKARN2=\$ CMKARN2 CMKARN3=\$ CMKARN3 \ CodeCommitRepoName= \$CODECOMMITREPONAME BucketStartName=\$B UCKETSTARTNAME \ --template-file codepipeline.yaml -- capabilities CAPABILIT Y_NAMED_IAM</pre>	

Task	Description	Skills required
<p>Provide access for CodePipeline and CodeBuild roles in the AWS KMS key policy and S3 bucket policy.</p>	<ol style="list-style-type: none"> <li>1. Provide access for CodePipeline and CodeBuild roles in the AWS KMS key policy:           <pre data-bbox="634 443 1029 1276">aws cloudformation   deploy --stack-name     ecs-codepipeline-p   re-reqs-KMS \   --template-file pre-   reqs_KMS.yaml --   parameter-overrides   \   CodeBuildCondi   on=true TestAccou   nt1=\$TESTACCOUNT1   TestAccount2=\$TEST   ACCOUNT2 \   TestAccount3=\$TE   STACCOUNT3 CodeComm   itAccount=\$CODECOMM   ITACCOUNT ToolsAcco   unt=\$TOOLSACCOUNT   --region \$TOOLSACC   OUNTREGION</pre> </li> <li>2. Update the S3 bucket policy to allow access for CodePipeline and CodeDeploy roles:           <pre data-bbox="634 1507 1029 1877">aws cloudformation   deploy --stack-name     pre-reqs-artifacts   -bucket --parameter-   overrides BucketSta   rtName=\$BUCKETSTAR   TNAME \   PutS3BucketPolic   y=true TestAccou</pre> </li> </ol>	<p>AWS DevOps</p>

Task	Description	Skills required
	<pre> nt1=\$TESTACCOUNT1   TestAccount2=\$TEST ACCOUNT2 \ TestAccount3=\$TE STACCOUNT3 CodeCommi tAccount=\$CODECOMM ITACCOUNT ToolsAcco unt=\$TOOLSACCOUNT \ --template-file pre- reqs_bucket.yaml   --region \$TESTACCO UNT1REGION --capabil ities CAPABILIT Y_NAMED_IAM  aws cloudformation   deploy --stack-name pre-reqs-artifacts -bucket --parameter- overrides BucketSta rtName=\$BUCKETSTAR TNAME \ PutS3BucketPolic y=true TestAccou nt1=\$TESTACCOUNT1   TestAccount2=\$TEST ACCOUNT2 \ TestAccount3=\$TE STACCOUNT3 CodeCommi tAccount=\$CODECOMM ITACCOUNT ToolsAcco unt=\$TOOLSACCOUNT \ --template-file pre- reqs_bucket.yaml   --region \$TESTACCO UNT2REGION --capabil ities CAPABILIT Y_NAMED_IAM  aws cloudformation   deploy --stack-name pre-reqs-artifacts </pre>	

Task	Description	Skills required
	<pre> -bucket --parameter- overrides BucketSta rtName=\$BUCKETSTAR TNAME \ PutS3BucketPolic y=true TestAccou nt1=\$TESTACCOUNT1   TestAccount2=\$TEST ACCOUNT2 \ TestAccount3=\$TE STACCOUNT3 CodeComm tAccount=\$CODECOMM ITACCOUNT ToolsAcco unt=\$TOOLSACCOUNT \ --template-file pre- reqs_bucket.yaml   --region \$TESTACCO UNT3REGION --capabil ities CAPABILIT Y_NAMED_IAM  aws cloudformation   deploy --stack-name   pre-reqs-artifacts -bucket --parameter- overrides BucketSta rtName=\$BUCKETSTAR TNAME \ PutS3BucketPolic y=true TestAccou nt1=\$TESTACCOUNT1   TestAccount2=\$TEST ACCOUNT2 \ TestAccount3=\$TE STACCOUNT3 CodeComm tAccount=\$CODECOMM ITACCOUNT ToolsAcco unt=\$TOOLSACCOUNT \ --template-file pre- reqs_bucket.yaml   --region \$TOOLSACC OUNTREGION --capabil                     </pre>	

Task	Description	Skills required
	ities CAPABILIT Y_NAMED_IAM	

## Call and test the pipeline

Task	Description	Skills required
Push changes to the CodeCommit repository.	<ol style="list-style-type: none"> <li>Clone the CodeCommit repository that was created in the <code>codecommitrepoStack</code> by using the <code>git clone</code> command, as described in the <a href="#">AWS CodeCommit documentation</a>.</li> <li>Update the input artifacts with the required details: <ul style="list-style-type: none"> <li>JSON file: Update <code>AccountID</code> in the file in three places of this file. Rename the three files to include the account IDs.</li> <li>YAML files: Update the task definition ARN and version. Rename the three files to include the account IDs.</li> </ul> </li> <li>Modify the <code>index.html</code> file to make a few minor changes to the home page.</li> <li>Copy the following files to the repository and commit:</li> </ol>	

Task	Description	Skills required
	<pre data-bbox="633 210 990 598">index.html Dockerfile buildspec.yaml appspec_&lt;accountid&gt;.yaml (3 files - one per account ) taskdef&lt;accountid&gt;.json (3 files - one per account)</pre> <ol style="list-style-type: none"> <li data-bbox="592 619 1031 703">5. Start or restart the pipeline and verify the results.</li> <li data-bbox="592 724 1031 997">6. Access the service from the Application Load Balancer using by using an FQDN or DNS, and verify that the updates have been deployed.</li> </ol>	

## Clean up

Task	Description	Skills required
Clean up all the deployed resources.	<ol style="list-style-type: none"> <li data-bbox="592 1323 1031 1407">1. Scale down Amazon ECS to zero instances: <pre data-bbox="633 1438 990 1680">aws ecs update-service --cluster QA-Cluster --service Poc-Service --desired-count 0</pre> </li> <li data-bbox="592 1701 1031 1816">2. Delete the CloudFormation stacks in each account and Region:</li> </ol>	



Task	Description	Skills required
	<pre> ##In Tools Account## aws cloudformation   delete-stack --   stack-name ecscodapi   pelinestack --region   \$TOOLSACCOUNTREGION aws cloudformation   delete-stack --   stack-name ecscodbu   ildstack --region   \$TESTACCOUNT1REGION aws cloudformation   delete-stack --   stack-name ecscodbu   ildstack --region   \$TESTACCOUNT2REGION aws cloudformation   delete-stack --   stack-name ecscodbu   ildstack --region   \$TESTACCOUNT3REGION aws cloudformation   delete-stack --   stack-name ecs-codep   ipeline-pre-reqs-K   MS --region \$TOOLSACC   OUNTREGION aws cloudformation   delete-stack --   stack-name codecommi   trepoStack --region   \$TOOLSACCOUNTREGION aws cloudformation   delete-stack --   stack-name pre-reqs-   artifacts-bucket   --region \$TESTACCO   UNT1REGION aws cloudformation   delete-stack --   stack-name pre-reqs- </pre>	

Task	Description	Skills required
	<pre> artifacts-bucket --region \$TESTACCO UNT2REGION aws cloudformation delete-stack -- stack-name pre-reqs- artifacts-bucket --region \$TESTACCO UNT3REGION aws cloudformation delete-stack -- stack-name pre-reqs- artifacts-bucket --region \$TOOLSACC OUNTREGION aws cloudformation delete-stack -- stack-name ecs-codeb uild-iam --region \$TOOLSACCOUNTREGION  ##NOTE: Artifact buckets will not get deleted if there are artifacts so it has to be emptied manually before deleting.##  ##In Workload / Test Accounts## ##Account:1## aws cloudformation delete-stack -- stack-name ecscodede ploystack --region \$TESTACCOUNT1REGION aws cloudformation delete-stack -- stack-name mainInfra </pre>	

Task	Description	Skills required
	<pre>stack --region \$TESTACCOUNT1REGION ##Account:2## aws cloudformation delete-stack -- stack-name ecscodede ploystack --region \$TESTACCOUNT2REGION aws cloudformation delete-stack -- stack-name mainInfra stack --region \$TESTACCOUNT2REGION ##Account:3## aws cloudformation delete-stack -- stack-name ecscodede ploystack --region \$TESTACCOUNT3REGION aws cloudformation delete-stack -- stack-name mainInfra stack --region \$TESTACCOUNT3REGION ##NOTE: Amazon ECR (web) will not get deleted if the registry still includes images. It can be manually cleaned up if not required.</pre>	

## Troubleshooting

Issue	Solution
Changes that you committed to the repository aren't getting deployed.	<ul style="list-style-type: none"><li>• Check the CodeBuild logs for errors in the Docker build action. For more information, see the <a href="#">CodeBuild documentation</a>.</li><li>• Check the CodeDeploy deployment for any Amazon ECS deployment issues.</li></ul>

### Related resources

- [Pushing a Docker image](#) (Amazon ECR documentation)
- [Connect to an AWS CodeCommit repository](#) (AWS CodeCommit documentation)
- [Troubleshooting AWS CodeBuild](#) (AWS CodeBuild documentation)

# Monitor Amazon ECR repositories for wildcard permissions using AWS CloudFormation and AWS Config

Created by Vikrant Telkar (AWS), Sajid Momin (AWS), and Wassim Benhallam (AWS)

**Environment:** Production

**Technologies:** DevOps;  
Containers & microservices

**AWS services:** AWS  
CloudFormation; AWS Config;  
Amazon ECR; Amazon SNS;  
AWS Lambda

## Summary

On the Amazon Web Services (AWS) Cloud, Amazon Elastic Container Registry (Amazon ECR) is a managed container image registry service that supports private repositories with resource-based permissions using AWS Identity and Access Management (IAM).

IAM supports the "\*" wildcard in both the resource and action attributes, which makes it easier to automatically choose multiple matching items. In your testing environment, you can allow all authenticated AWS users to access an Amazon ECR repository by using the `ecr : *` [wildcard permission](#) in a principal element for your [repository policy statement](#). The `ecr : *` wildcard permission can be useful when developing and testing in development accounts that can't access your production data.

However, you must make sure that the `ecr : *` wildcard permission is not used in your production environments because it can cause serious security vulnerabilities. This pattern's approach helps you to identify Amazon ECR repositories that contain the `ecr : *` wildcard permission in repository policy statements. The pattern provides steps and an AWS CloudFormation template to create a custom rule in AWS Config. An AWS Lambda function then monitors your Amazon ECR repository policy statements for `ecr : *` wildcard permissions. If it finds non-compliant repository policy statements, Lambda notifies AWS Config to send an event to Amazon EventBridge and EventBridge then initiates an Amazon Simple Notification Service (Amazon SNS) topic. The SNS topic notifies you by email about the non-compliant repository policy statements.

## Prerequisites and limitations

### Prerequisites

- An active AWS account.
- AWS Command Line Interface (AWS CLI), installed and configured. For more information about this, see [Installing, updating, and uninstalling the AWS CLI](#) in the AWS CLI documentation.
- An existing Amazon ECR repository with an attached policy statement, installed and configured in your testing environment. For more information about this, see [Creating a private repository](#) and [Setting a repository policy statement](#) in the Amazon ECR documentation.
- AWS Config, configured in your preferred AWS Region. For more information about this, see [Getting started with AWS Config](#) in the AWS Config documentation.
- The `aws-config-cloudformation.template` file (attached), downloaded to your local machine.

## Limitations

- This pattern's solution is Regional and your resources must be created in the same Region.

## Architecture

The following diagram shows how AWS Config evaluates Amazon ECR repository policy statements.

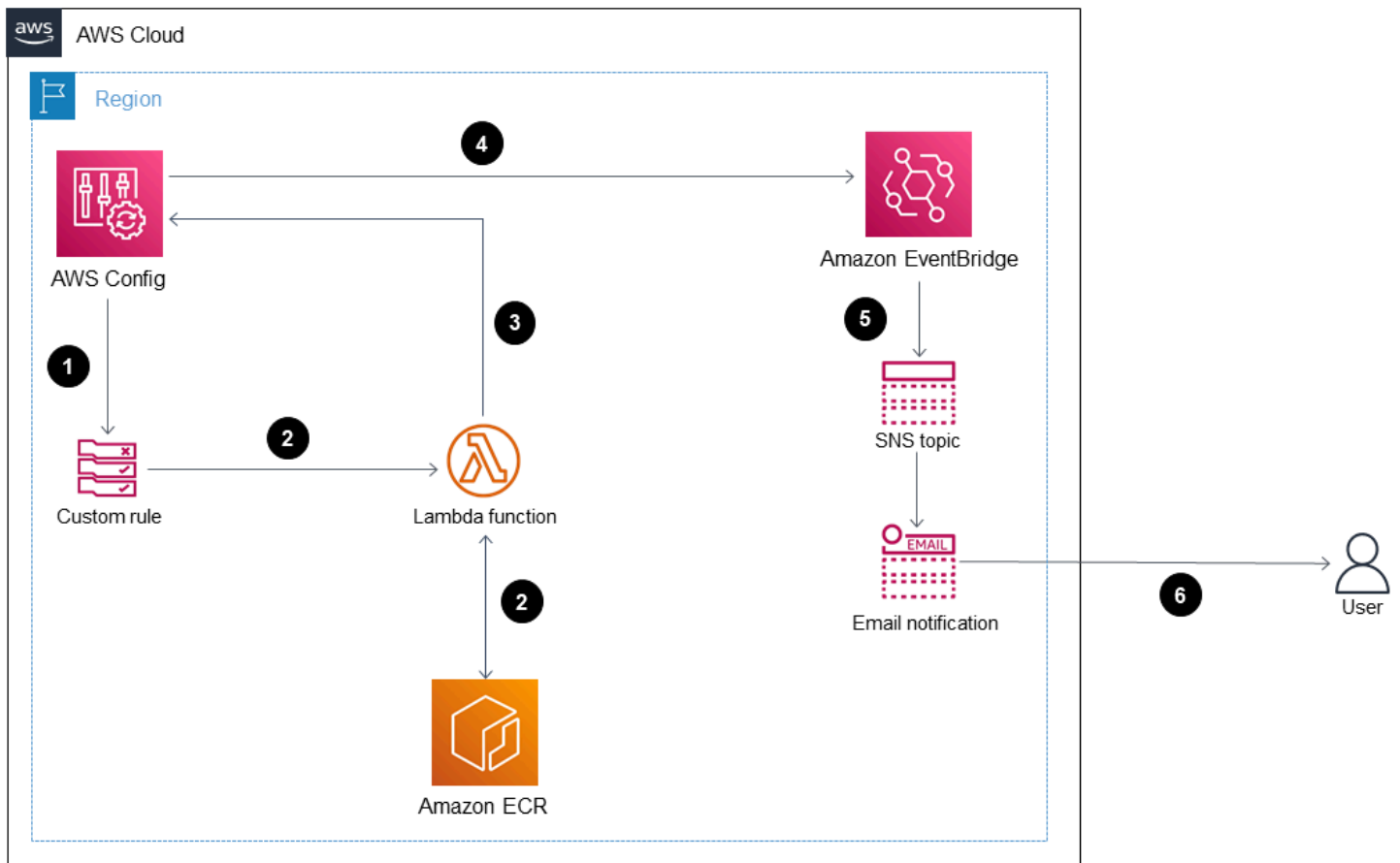

The diagram shows the following workflow:

1. AWS Config initiates a custom rule.
2. The custom rule invokes a Lambda function to evaluate the compliance of the Amazon ECR repository policy statements. The Lambda function then identifies non-compliant repository policy statements.
3. The Lambda function sends the non-compliance status to AWS Config.
4. AWS Config sends an event to EventBridge.
5. EventBridge publishes the non-compliance notifications to an SNS topic.
6. Amazon SNS sends an email alert to you or an authorized user.

### Automation and scale

This pattern's solution can monitor any number of Amazon ECR repository policy statements, but all resources that you want to evaluate must be created in the same Region.

## Tools

- [AWS CloudFormation](#) – AWS CloudFormation helps you model and set up your AWS resources, provision them quickly and consistently, and manage them throughout their lifecycle. You can use a template to describe your resources and their dependencies, and launch and configure them together as a stack, instead of managing resources individually. You can manage and provision stacks across multiple AWS accounts and AWS Regions.
- [AWS Config](#) – AWS Config provides a detailed view of the configuration of AWS resources in your AWS account. This includes how the resources are related to one another and how they were configured in the past so that you can see how the configurations and relationships change over time.
- [Amazon ECR](#) – Amazon Elastic Container Registry (Amazon ECR) is an AWS managed container image registry service that is secure, scalable, and reliable. Amazon ECR supports private repositories with resource-based permissions using IAM.
- [Amazon EventBridge](#) – Amazon EventBridge is a serverless event bus service that you can use to connect your applications with data from a variety of sources. EventBridge delivers a stream of real-time data from your applications, software as a service (SaaS) applications, and AWS services to targets such as AWS Lambda functions, HTTP invocation endpoints using API destinations, or event buses in other accounts.
- [AWS Lambda](#) – AWS Lambda is a compute service that supports running code without provisioning or managing servers. Lambda runs your code only when needed and scales automatically, from a few requests per day to thousands per second. You pay only for the compute time that you consume—there is no charge when your code is not running.
- [Amazon SNS](#) – Amazon Simple Notification Service (Amazon SNS) coordinates and manages the delivery or sending of messages between publishers and clients, including web servers and email addresses. Subscribers receive all messages published to the topics to which they subscribe, and all subscribers to a topic receive the same messages.

## Code

The code for this pattern is available in the `aws-config-cloudformation.template` file (attached).



## Epics

### Create the AWS CloudFormation stack

Task	Description	Skills required
Create the AWS CloudFormation stack.	<p>Create an AWS CloudFormation stack by running the following command in AWS CLI:</p> <pre>\$ aws cloudformation create-stack --stack-n ame=AWSConfigECR \   --template-body   file://aws-config- cloudformation.tem plate \   --parameters   ParameterKey=&lt;emai l&gt;,ParameterValue= &lt;myemail@example.com&gt; \   --capabilities   CAPABILITY_NAMED_IAM</pre>	AWS DevOps

### Test the AWS Config custom rule

Task	Description	Skills required
Test the AWS Config custom rule.	<ol style="list-style-type: none"><li>1. Sign in to the AWS Management Console, open the AWS Config console, and then choose <b>Resources</b>.</li><li>2. On the <b>Resource inventory</b> page, you can filter by resource category, resource</li></ol>	AWS DevOps

Task	Description	Skills required
	<p>type, and compliance status.</p> <p>3. An Amazon ECR repository that contains <code>ecr:*</code> is NON-COMPLIANT? and an Amazon ECR repository that doesn't contain <code>ecr:*</code> is COMPLIANT .</p> <p>4. The email address subscribed to the SNS topic receives notifications if an Amazon ECR repository contains non-compliant policy statements.</p>	

## Attachments

To access additional content that is associated with this document, unzip the following file: [attachment.zip](#)

# Perform custom actions from AWS CodeCommit events

*Created by Abdullahi Olaoye (AWS)*

**Environment:** PoC or pilot

**Technologies:** DevOps;  
Management & governance

**AWS services:** AWS  
CodeCommit; Amazon SNS

## Summary

When you use an AWS CodeCommit repository to store code, you might want to monitor the repository and initiate a workflow of actions when specific events occur. For example, you might want to send an email notification when a user comments on a line of code in a commit, or initiate an AWS Lambda function to perform security scans on repository contents after a commit. This pattern outlines the steps for configuring a CodeCommit repository for custom actions. The pattern uses AWS CodeCommit notification rules to capture the events of interest, and then sends these events to a configured target.

## Prerequisites and limitations

### Prerequisites

- An active AWS account.
- Familiarity with Git commands.
- AWS CodeCommit, set up. For instructions, see [Setting up for AWS CodeCommit](#).
- (Recommended) AWS Command Line Interface (AWS CLI), installed and configured. For instructions, see [Getting started with the AWS CLI](#).

## Architecture

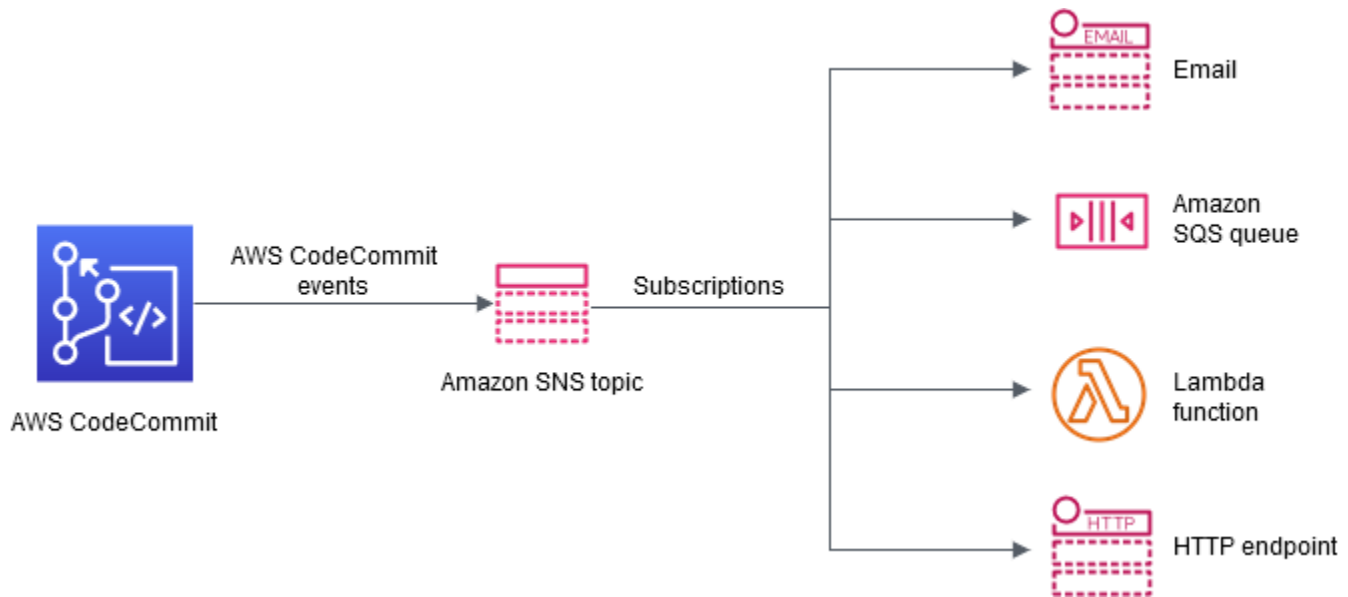

## Tools

### AWS services

- [AWS CodeCommit](#) is a fully-managed source control service that hosts secure Git-based repositories. It makes it easy for teams to collaborate on code in a secure and highly scalable ecosystem. CodeCommit eliminates the need to operate your own source control system or worry about scaling its infrastructure
- [Amazon Simple Notification Service \(Amazon SNS\)](#) is a web service that enables applications, end-users, and devices to instantly send and receive notifications from the cloud. Amazon SNS provides topics (communication channels) for high-throughput, push-based, many-to-many messaging. Using Amazon SNS topics, publishers can distribute messages to a large number of subscribers for parallel processing, including Amazon Simple Queue Service (Amazon SQS) queues, AWS Lambda functions, and HTTP/S webhooks. You can also use Amazon SNS to send notifications to end users using mobile push, SMS, and email.

# Epics

## Set up a CodeCommit repository

Task	Description	Skills required
Create a CodeCommit repository.	Use the CodeCommit console or the AWS CLI to create a CodeCommit repository. For instructions, see <a href="#">Create a CodeCommit repository</a> .	DevOps engineer
Push content to the CodeCommit repository.	After you create a repository, add content to it by using Git commands. You can migrate the contents of an existing Git repository or local, unversioned content from your computer. For instructions, see <a href="#">Add files to your repository</a> or <a href="#">Migrate to AWS CodeCommit</a> .	DevOps engineer

## Set up Amazon SNS

Task	Description	Skills required
Create an SNS topic.	This SNS topic receives the events from CodeCommit. For instructions, see <a href="#">Creating an Amazon SNS topic</a> .	Cloud architect, DevOps engineer
Create a resource for a custom action.	For the custom action to be performed, you must create the corresponding resource. For example, if your custom action is to run Lambda code	Cloud architect, DevOps engineer

Task	Description	Skills required
	and send messages to an SQS queue, you must create the Lambda function and the SQS queue. Actions such as email and SMS notifications do not require resources. For more information, see the <a href="#">AWS documentation</a> for the type of resource you are creating.	
Subscribe the custom action resource to the SNS topic.	Depending on the custom action, you create a subscription for the appropriate protocol. For example, you subscribe an email address for email notification, a Lambda function to run custom code, or an SQS queue to send events to Amazon SQS. For subscription protocols like email and SMS, you need to confirm the subscription from the link that is sent to the email or telephone number, respectively. For instructions, see <a href="#">Subscribing to an Amazon SNS topic</a> .	Cloud architect, DevOps engineer

## Configure notification rules

Task	Description	Skills required
Create the notification rule for the CodeCommit repository.	When you create the notification rule, you select the Git events that should initiate the	DevOps engineer

Task	Description	Skills required
	notification, select the SNS topic as the target type, and then select the SNS topic you created earlier. You can also configure multiple targets for the repository. For instructions, see <a href="#">Create a notification rule</a> .	
Test custom actions.	Perform one of the events that was configured to initiate the notification. For example, create a pull request if you selected that event as a trigger. You should see your custom action being performed. For example, if you subscribed an email address to the SNS topic, you should receive an email notification.	DevOps engineer

## Related resources

- [AWS CodeCommit documentation](#)
- [Amazon SNS documentation](#)
- [Git documentation](#)

# Publish Amazon CloudWatch metrics to a CSV file

Created by Abdullahi Olaoye (AWS)

**Environment:** PoC or pilot

**Technologies:** DevOps

**AWS services:** Amazon  
CloudWatch

## Summary

This pattern uses a Python script to retrieve Amazon CloudWatch metrics and to convert the metrics information into a comma-separated values (CSV) file for improved readability. The script takes the AWS service whose metrics should be retrieved as a required argument. You can specify the AWS Region and AWS credential profile as optional arguments. If you don't specify those arguments, the script uses the default Region and profile that are configured for the workstation where the script is run. After the script runs, it generates and stores a CSV file in the same directory.

See the *Attachments* section for the script and associated files provided with this pattern.

## Prerequisites and limitations

### Prerequisites

- Python 3.x
- AWS Command Line Interface (AWS CLI)

### Limitations

The script currently supports the following AWS services:

- AWS Lambda
- Amazon Elastic Compute Cloud (Amazon EC2)
  - By default, the script doesn't collect Amazon Elastic Block Store (Amazon EBS) volume metrics. To collect Amazon EBS metrics, you must modify the attached `metrics.yaml` file.
- Amazon Relational Database Service (Amazon RDS)
  - However, the script doesn't support Amazon Aurora.



- Application Load Balancer
- Network Load Balancer
- Amazon API Gateway

## Tools

- [Amazon CloudWatch](#) is a monitoring service built for DevOps engineers, developers, site reliability engineers (SREs), and IT managers. CloudWatch provides data and actionable insights to help you monitor your applications, respond to systemwide performance changes, optimize resource utilization, and get a unified view of operational health. CloudWatch collects monitoring and operational data in the form of logs, metrics, and events, and provides a unified view of AWS resources, applications, and services that run on AWS and on-premises servers.

## Epics

### Install and configure the prerequisites

Task	Description	Skills required
Install the prerequisites.	Run the following command: <pre>\$ pip3 install -r requirements.txt</pre>	Developer
Configure the AWS CLI.	Run the following command: <pre>\$ aws configure</pre>	Developer

### Configure the Python script

Task	Description	Skills required
Open the script.	To change the default configuration of the script, open <code>metrics.yaml</code> .	Developer

Task	Description	Skills required
Set the period for the script.	<p>This is the time period to fetch. The default period is 5 minutes (300 seconds). You can change the time period, but note the following limitations:</p> <ul style="list-style-type: none"><li>• If the hours value that you specify is between 3 hours and 15 days ago, use a multiple of 60 seconds (1 minute) for the period.</li><li>• If the hours value that you specify is between 15 hours and 63 days ago, use a multiple of 300 seconds (5 minutes) for the period.</li><li>• If the hours value that you specify is greater than 63 days ago, use a multiple of 3,600 seconds (1 hour) for the period.</li></ul> <p>Otherwise, the API operation won't return any data points.</p>	Developer
Set the hours for the script.	<p>This value specifies how many hours of metrics you want to fetch. The default is 1 hour. To retrieve multiple days of metrics, provide the value in hours. For example, for 2 days, specify 48.</p>	Developer

Task	Description	Skills required
Change statistics values for the script.	(Optional) The global statistic s value is Average, which is used when fetching metrics that do not have a specific statistics value assigned. The script supports the statistics values Maximum, SampleCount , and Sum.	Developer

## Run the Python script

Task	Description	Skills required
Run the script.	<p>Use the following command:</p> <pre>\$ python3 cwreport.py &lt;service&gt;</pre> <p>To see a list of service values and the optional region and profile parameters, run the following command:</p> <pre>\$ python3 cwreport.py -h</pre> <p>For more information about the optional parameters, see the <i>Additional information</i> section.</p>	Developer

## Related resources

- [Configuring the AWS CLI](#)

- [Using Amazon CloudWatch metrics](#)
- [Amazon CloudWatch documentation](#)
- [EC2 CloudWatch Metrics](#)
- [AWS Lambda Metrics](#)
- [Amazon RDS Metrics](#)
- [Application Load Balancer Metrics](#)
- [Network Load Balancer Metrics](#)
- [Amazon API Gateway Metrics](#)

## Additional information

### Script usage

```
$ python3 cwreport.py -h
```

### Example syntax

```
python3 cwreport.py <service> <--region=Optional Region> <--profile=Optional credential profile>
```

### Parameters

- **service (required)** – The service you want to run the script against. The script currently supports these services: AWS Lambda, Amazon EC2, Amazon RDS, Application Load Balancer, Network Load Balancer, and API Gateway.
- **region (optional)** – The AWS Region to fetch metrics from. The default Region is ap-southeast-1.
- **profile (optional)** – The AWS CLI named profile to use. If this parameter isn't specified, the default configured credential profile is used.

### Examples

- To use the default Region ap-southeast-1 and default configured credentials to fetch Amazon EC2 metrics: `$ python3 cwreport.py ec2`

- To specify a Region and fetch API Gateway metrics: `$ python3 cwreport.py apigateway --region us-east-1`
- To specify an AWS profile and fetch Amazon EC2 metrics: `$ python3 cwreport.py ec2 --profile testprofile`
- To specify both Region and profile to fetch Amazon EC2 metrics: `$ python3 cwreport.py ec2 --region us-east-1 --profile testprofile`

## Attachments

To access additional content that is associated with this document, unzip the following file:  
[attachment.zip](#)

# Remove Amazon EC2 entries in the same AWS account from AWS Managed Microsoft AD by using AWS Lambda automation

Created by Dr. Rahul Sharad Gaikwad (AWS) and Tamilselvan P (AWS)

<b>Code repository:</b> <a href="#">terraform-aws-lambda-ad-cleanup</a>	<b>Environment:</b> PoC or pilot	<b>Technologies:</b> DevOps; Infrastructure; Storage & backup; Management & governance
<b>Workload:</b> All other workloads; Microsoft	<b>AWS services:</b> AWS Managed Microsoft AD; AWS Lambda; Amazon EC2; AWS Identity and Access Management; AWS Directory Service; AWS Systems Manager; Amazon EventBridge; AWS Auto Scaling	

## Summary

Active Directory (AD) is a Microsoft scripting tool that manages domain information and user interactions with network services. It's widely used among managed services providers (MSPs) to manage employee credentials and access permissions. Because AD attackers can use inactive accounts to try and hack into an organization, it's important to find inactive accounts and disable them on a routine maintenance schedule. With AWS Directory Service for Microsoft Active Directory, you can run Microsoft Active Directory as a managed service.

This pattern can help you to configure AWS Lambda automation to quickly find and remove inactive accounts. When you use this pattern, you can get the following benefits:

- Improve database and server performance, and fix vulnerabilities in your security from inactive accounts.
- If your AD server is hosted in the cloud, removing inactive accounts can also reduce storage costs while improving performance. Your monthly bills might decrease because bandwidth charges and compute resources can both drop.

- Keep potential attackers at bay with a clean Active Directory.

## Prerequisites and limitations

### Prerequisites

- An active AWS account.
- Git [installed](#) and configured on a local workstation.
- Terraform [installed](#) and configured on a local workstation.
- Windows computer with Active Directory modules (ActiveDirectory).
- A directory in AWS Managed Microsoft AD and credentials stored in a [parameter in AWS Systems Manager Parameter Store](#).
- AWS Identity and Access Management (IAM) role with permissions to the AWS services listed in [Tools](#). For more information about IAM, see [Related resources](#).

### Limitations

- This pattern doesn't support cross-account setup.
- Some AWS services aren't available in all AWS Regions. For Region availability, see [AWS services by Region](#). For specific endpoints, see [Service endpoints and quotas](#), and choose the link for the service.

### Product versions

- [Terraform version 1.1.9 or later](#)
- [Terraform AWS Provider version 3.0 or higher](#)

## Architecture

The following diagram shows the workflow and architecture components for this pattern.

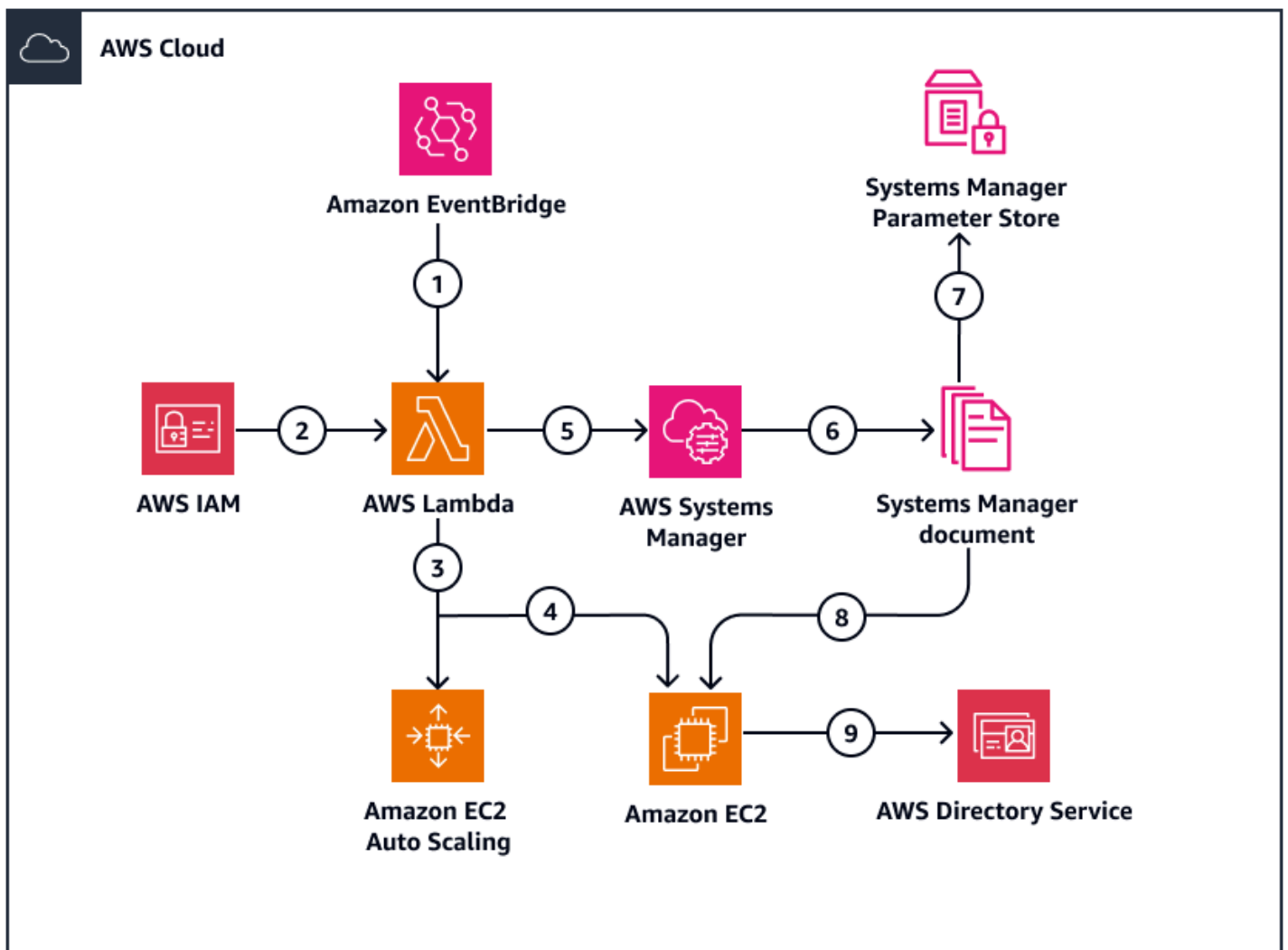

The diagram shows the following workflow:

1. Amazon EventBridge triggers the AWS Lambda function based on a cron expression. (For this pattern, the cron expression schedule is once per day.)
2. The required IAM role and policy are created and attached to AWS Lambda through Terraform.
3. The AWS Lambda function is executed and calls to Amazon Elastic Compute Cloud (Amazon EC2) Auto Scaling Groups by using the Python boto module. The Lambda function gets the random instance id. The instance id is used to execute AWS Systems Manager commands.
4. AWS Lambda makes another call to Amazon EC2 using the boto module and gets the private IP addresses of the running Windows servers and stores the addresses in a temporary variable.
5. AWS Lambda makes another call to Systems Manager to get the computer information that is connected to AWS Directory Service.



6. An AWS Systems Manager document helps to execute the PowerShell script on Amazon EC2 Windows servers to get the private IP addresses of the computers which are connected with AD.
7. The AD domain username and passwords are stored in the AWS Systems Manager Parameter Store. AWS Lambda and Systems Manager make a call to Parameter Store and get the username and password values to use to connect AD.
8. Using the Systems Manager document, the PowerShell script is executed on the Amazon EC2 Windows server using the instance id obtained earlier in step 3.
9. Amazon EC2 connects AWS Directory Service by using PowerShell commands and removes the computers which are not in use or inactive.

## Tools

### AWS services

- AWS Directory Service provides multiple ways to use Microsoft Active Directory (AD) with other AWS services such as Amazon Elastic Compute Cloud (Amazon EC2), Amazon Relational Database Service (Amazon RDS) for SQL Server, and Amazon FSx for Windows File Server.
- AWS Directory Service for Microsoft Active Directory enables your directory-aware workloads and AWS resources to use Microsoft Active Directory in the AWS Cloud.
- Amazon Elastic Compute Cloud (Amazon EC2) provides scalable computing capacity in the AWS Cloud. You can launch as many virtual servers as you need and quickly scale them up or down.
- Amazon EventBridge is a serverless event bus service that that helps you connect your applications with real-time data from a variety of sources. For example, AWS Lambda functions, HTTP invocation endpoints using API destinations, or event buses in other AWS accounts.
- AWS Identity and Access Management (IAM) helps you securely manage access to your AWS resources by controlling who is authenticated and authorized to use them. With IAM, you can specify who or what can access services and resources in AWS, centrally manage fine-grained permissions, and analyze access to refine permissions across AWS.
- AWS Lambda is a compute service that helps you run code without needing to provision or manage servers. It runs your code only when needed and scales automatically, so you pay only for the compute time that you use.
- AWS Systems Manager helps you manage your applications and infrastructure running in the AWS Cloud. It simplifies application and resource management, shortens the time to detect and resolve operational problems, and helps you manage your AWS resources securely at scale.

- AWS Systems Manager documents define the actions that Systems Manager performs on your managed instances. Systems Manager includes more than 100 pre-configured documents that you can use by specifying parameters at runtime.
- AWS Systems Manager Parameter Store is a capability of AWS Systems Manager and provides secure, hierarchical storage for configuration data management and secrets management.

## Other tools

- [HashiCorp Terraform](#) is an open source infrastructure as code (IaC) tool that helps you use code to provision and manage cloud infrastructure and resources.
- [PowerShell](#) is a Microsoft automation and configuration management program that runs on Windows, Linux, and macOS.
- [Python](#) is a general-purpose computer programming language.

## Code repository

The code for this pattern is available in the GitHub [Custom AD Cleanup Automation solution](#) repository.

## Best practices

- **Automatically join domains.** When you launch a Windows instance that's to be part of an AWS Directory Service domain, join the domain during the instance creation process instead of manually adding the instance later. To automatically join a domain, select the correct directory from the **Domain join directory** dropdown list when launching a new instance. For more details, see [Seamlessly join an Amazon EC2 Windows instance to your AWS Managed Microsoft AD Active Directory](#) in the *AWS Directory Service Administration Guide*.
- **Delete unused accounts.** It's common to find accounts in AD that have never been used. Like disabled or inactive accounts that remain in the system, neglected unused accounts can slow down your AD system or make your organization vulnerable to data breaches.
- **Automate Active Directory cleanups.** To help mitigate security risks and prevent obsolete accounts from impacting AD performance, conduct AD cleanups should at regular intervals. You can accomplish most AD management and cleanup tasks by writing scripts. Example tasks include removing disabled and inactive accounts, deleting empty and inactive groups, and locating expired user accounts and passwords.

# Epics

## Set up your environment

Task	Description	Skills required
Create a project folder, and add the files.	<p>To clone the repository and create a project folder, do the following:</p> <ol style="list-style-type: none"><li>1. Open this pattern's <a href="#">GitHub repository</a>.</li><li>2. Choose the <b>Code</b> button to see the options to clone in the <b>Clone</b> dropdown.</li><li>3. On the <b>HTTPS</b> tab, copy the URL provided in <b>Clone using the web URL</b>.</li><li>4. Create a folder on your machine, and name it with your project name.</li><li>5. Open a terminal in your local machine, and navigate to this folder.</li><li>6. To clone the git repository, use the following command.  <pre>git clone &lt;repository-URL&gt;.git</pre></li><li>7. After the repository has been cloned, use the following command to go to the cloned directory.  <pre>cd &lt;directory name&gt;</pre></li></ol>	DevOps engineer

Task	Description	Skills required
	8. In the cloned repository, open this project in an integrated development environment (IDE) of your choice.	

### Provision the target architecture by using the Terraform configuration

Task	Description	Skills required
Initialize the Terraform configuration.	To initialize your working directory that contains the Terraform files, run the following command.  <code>terraform init</code>	DevOps engineer
Preview changes.	You can preview the changes that Terraform will make to the infrastructure before your infrastructure is deployed. To validate that Terraform will make the changes as required, run the following command.  <code>terraform plan</code>	DevOps engineer
Execute the proposed actions.	To verify that the results from the <code>terraform plan</code> command are as expected, do the following:  1. Run the following command.  <code>terraform apply</code>	DevOps engineer

Task	Description	Skills required
	2. Sign in to the AWS Management Console, and verify that the resources are present.	
Clean up the infrastructure.	To clean up the infrastructure that you created, use the following command.  <code>terraform destroy</code>  To confirm the destroy command, type yes.	DevOps engineer

## Verify the deployment

Task	Description	Skills required
Execute and test the Lambda function.	To verify that the deployment occurred successfully, do the following:  1. Sign in to the AWS Management Console and open the console. Open the <b>Functions</b> page, and select the function name that begins with <b>ADcleanup-Lambda-*</b> .  2. On the function overview page, choose <b>Test</b> on the <b>Code</b> tab in the <b>Code source</b> section.  3. To save the test event, provide a name for the	DevOps engineer

Task	Description	Skills required
	<p>event and choose <b>Save</b>. Then to test the event, choose <b>Test</b> again.</p> <p>The execution results show the output of the function.</p>	
View the results of the Lambda function.	<p>In this pattern, an EventBridge rule executes the Lambda function once per day. To view the results of the Lambda function, do the following:</p> <ol style="list-style-type: none"><li>1. Sign in to the AWS Management Console and open the AWS Lambda console. Open the <b>Functions</b> page and select the function name that begins with <b>ADcleanup-Lambda*</b>.</li><li>2. Choose the <b>Monitor</b> tab and choose <b>View CloudWatch logs</b>.</li></ol> <p>In the CloudWatch console, the <b>Log groups</b> page shows the results of the Lambda function.</p>	DevOps engineer

## Clean up infrastructure after use

Task	Description	Skills required
Clean up infrastructure.	<p>To clean up the infrastructure that you created, use the following command.</p> <pre>terraform destroy</pre> <p>To confirm the destroy command, type yes.</p>	DevOps engineer
Verify after cleanup.	Verify that the resources are successfully removed.	DevOps engineer

## Troubleshooting

Issue	Solution
If you try to remove the AD computer, you get an "Access Denied" message. The AD computer can't be removed because, by default, the action tries to remove two private IP addresses which are connected as a part of the AD services.	<p>To avoid this error, use the following Python operation to ignore the first two computers when you list the differences between an AD computer output and the output of your machine running Windows.</p> <pre>Difference = Difference[2:]</pre>
When Lambda executes a PowerShell script on a Windows server, it expects Active Directory modules to be available by default. If the modules are not available, a Lambda function creates an error that states "Get-AdComputer is not installed on instance".	To avoid this error, install the required modules by using the user data of the EC2 instances. Use the <a href="#">EC2WindowsUserdata</a> script that's in this pattern's GitHub repository.

## Related resources

### AWS documentation

- [Amazon EventBridge and AWS Identity and Access Management](#)
- [Configure instance permissions required for Systems Manager](#)
- [Identity and access management for AWS Directory Service](#)
- [Manually join an Amazon EC2 Windows instance to your AWS Managed Microsoft AD Active Directory](#)
- [Working with identity-based IAM policies in AWS Lambda](#)

### Other resources

- [AWS Provider](#) (Terraform documentation)
- [Backend Configuration](#) (Terraform documentation)
- [Install Terraform](#) (Terraform documentation)
- [Python boto module](#) (Python Package Index repository)
- [Terraform binary download](#) (Terraform documentation)



# Run unit tests for Python ETL jobs in AWS Glue using the pytest framework

Created by Praveen Kumar Jeyarajan (AWS) and Vaidy Sankaran (AWS)

**Code repository:** [aws-glue-jobs-unit-testing](#)

**Environment:** Production

**Technologies:** DevOps; Big data; DevelopmentAndTesting

**AWS services:** AWS CloudFormation; AWS CodeBuild; AWS CodeCommit; AWS CodePipeline; AWS Glue

## Summary

You can run unit tests for Python extract, transform, and load (ETL) jobs for AWS Glue in a [local development environment](#), but replicating those tests in a DevOps pipeline can be difficult and time consuming. Unit testing can be especially challenging when you're modernizing mainframe ETL process on AWS technology stacks. This pattern shows you how to simplify unit testing, while keeping existing functionality intact, avoiding disruptions to key application functionality when you release new features, and maintaining high-quality software. You can use the steps and code samples in this pattern to run unit tests for Python ETL jobs in AWS Glue by using the pytest framework in AWS CodePipeline. You can also use this pattern to test and deploy multiple AWS Glue jobs.

## Prerequisites and limitations

### Prerequisites

- An active AWS account
- An Amazon Elastic Container Registry (Amazon ECR) image URI for your AWS Glue library, downloaded from the [Amazon ECR Public Gallery](#)
- Bash terminal (on any operating system) with a profile for the target AWS account and AWS Region

- [Python 3.10](#) or later
- [Pytest](#)
- [Moto](#) Python library for testing AWS services

## Architecture

### Technology stack

- Amazon Elastic Container Registry (Amazon ECR)
- AWS CodeBuild
- AWS CodeCommit
- AWS CodePipeline
- AWS Glue
- Pytest
- Python
- Python ETL library for AWS Glue

### Target architecture

The following diagram describes how to incorporate unit testing for AWS Glue ETL processes that are based on Python into a typical enterprise-scale AWS DevOps pipeline.

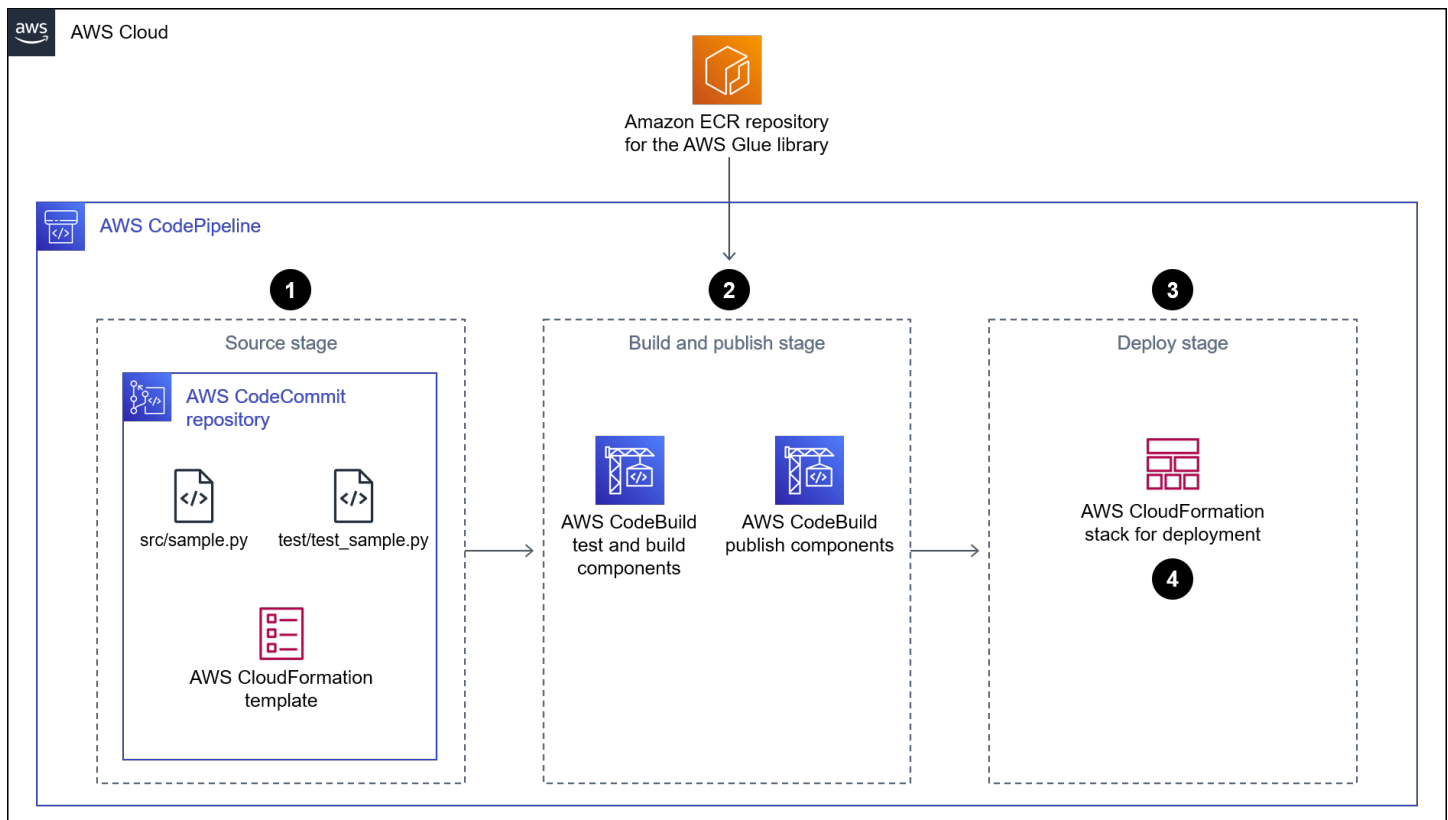

The diagram shows the following workflow:

1. In the source stage, CodePipeline uses a CodeCommit repository for source code, including a sample Python ETL job (`sample.py`), a unit test file (`test_sample.py`), and an AWS CloudFormation template. Then, CodePipeline transfers the most recent code from the main branch to the CodeBuild project for further processing.
2. In the build and publish stage, the most recent code from the previous source stage is unit tested with the help of an AWS Glue public Amazon ECR image. Then, the test report is published to CodeBuild report groups. The container image in the public Amazon ECR repository for AWS Glue libraries includes all the binaries required to run and unit test [PySpark-based](#) ETL tasks in AWS Glue locally. The public container repository has three image tags, one for each version supported by AWS Glue. For demonstration purposes, this pattern uses the `glue_libs_4.0.0_image_01` image tag. To use this container image as a runtime image in CodeBuild, copy the image URI that corresponds to the image tag that you intend to use, and then update the `pipeline.yml` file in the GitHub repository for the TestBuild resource.
3. In the deploy stage, the CodeBuild project is launched and it publishes the code to an Amazon Simple Storage Service (Amazon S3) bucket if all the tests pass.

4. The user deploys the AWS Glue task by using the CloudFormation template in the `deploy` folder.

## Tools

### AWS tools

- [Amazon Elastic Container Registry \(Amazon ECR\)](#) is a managed container image registry service that's secure, scalable, and reliable.
- [AWS CodeBuild](#) is a fully managed build service that helps you compile source code, run unit tests, and produce artifacts that are ready to deploy.
- [AWS CodeCommit](#) is a version control service that helps you privately store and manage Git repositories, without needing to manage your own source control system.
- [AWS CodePipeline](#) helps you quickly model and configure the different stages of a software release and automate the steps required to release software changes continuously.
- [AWS Glue](#) is a fully managed ETL service. It helps you reliably categorize, clean, enrich, and move data between data stores and data streams.

### Other tools

- [Python](#) is a high-level, interpreted general purpose programming language.
- [Moto](#) is a Python library for testing AWS services.
- [Pytest](#) is a framework for writing small unit tests that scale to support complex functional testing for applications and libraries.
- [Python ETL library](#) for AWS Glue is a repository for Python libraries that are used in the local development of PySpark batch jobs for AWS Glue.

### Code

The code for this pattern is available in the GitHub [aws-glue-jobs-unit-testing](#) repository. The repository includes the following resources:

- A sample Python-based AWS Glue job in the `src` folder
- Associated unit test cases (built using the `pytest` framework) in the `tests` folder
- A CloudFormation template (written in YAML) in the `deploy` folder

## Best practices

### Security for CodePipeline resources

It's a best practice to use encryption and authentication for the source repositories that connect to your pipelines in CodePipeline. For more information, see [Security best practices](#) in the CodePipeline documentation.

### Monitoring and logging for CodePipeline resources

It's a best practice to use AWS logging features to determine what actions users take in your account and what resources they use. The log files show the following:

- Time and date of actions
- Source IP address of actions
- Which actions failed due to inadequate permissions

Logging features are available in AWS CloudTrail and Amazon CloudWatch Events. You can use CloudTrail to log AWS API calls and related events made by or on behalf of your AWS account. For more information, see [Logging CodePipeline API calls with AWS CloudTrail](#) in the CodePipeline documentation.

You can use CloudWatch Events to monitor your AWS Cloud resources and applications running on AWS. You can also create alerts in CloudWatch Events. For more information, see [Monitoring CodePipeline events](#) in the CodePipeline documentation.

## Epics

### Deploy the source code

Task	Description	Skills required
Prepare the code archive for deployment.	1. Download code .zip from the GitHub <a href="#">aws-glue-jobs-unit-testing</a> repository, or create the .zip file yourself by using a command-line tool. For example, you	DevOps engineer

Task	Description	Skills required
	<p>can create the .zip file on Linux or Mac by running the following commands in the terminal:</p> <pre data-bbox="633 426 1029 825">git clone https://github.com/aws-samples/aws-glue-jobs-unit-testing.git cd aws-glue-jobs-unit-testing git checkout master zip -r code.zip src/ tests/ deploy/</pre> <ol style="list-style-type: none"><li data-bbox="592 840 1015 1018">2. Sign in to the <a href="#">AWS Management Console</a> and choose the AWS Region of your choice.</li><li data-bbox="592 1039 1031 1270">3. Create an <a href="#">S3 bucket</a>, and then upload the .zip package and code.zip file (downloaded earlier) to the S3 bucket that you created.</li></ol>	

Task	Description	Skills required
Create the CloudFormation stack.	<ol style="list-style-type: none"><li data-bbox="591 226 1027 405">1. Sign in to the AWS Management Console and then open the <a href="#">CloudFormation console</a>.</li><li data-bbox="591 426 1027 604">2. Choose <b>Create stack</b>, and then choose <b>With existing resources (import resources)</b>.</li><li data-bbox="591 625 1027 993">3. In the <b>Specify template</b> section of the <b>Create stack</b> page, choose <b>Upload a template file</b>, and then choose the <b>pipeline.yml</b> template (downloaded from the GitHub repository). Then, choose <b>Next</b>.</li><li data-bbox="591 1014 1027 1192">4. For <b>Stack name</b>, enter <b>glue-unit-testing-pipeline</b>, or choose a stack name of your choice.</li><li data-bbox="591 1213 1027 1539">5. For <b>ApplicationStackName</b>, use the prepopulated <b>glue-codepipeline-app</b> name. This is the name of the CloudFormation stack that's created by the pipeline.</li><li data-bbox="591 1560 1027 1822">6. For <b>BranchName</b>, use the prepopulated <b>master</b> name. This is the name of the branch created in the CodeCommit repository to check in the code from</li></ol>	AWS DevOps, DevOps engineer

Task	Description	Skills required
	<p>the .zip file for the S3 bucket.</p> <p>7. For <b>BucketName</b>, use the prepopulated <b>aws-glue-artifacts-us-east-1</b> bucket name. This is the name of the S3 bucket that contains the .zip file and is used by the pipeline to store code artifacts.</p> <p>8. For <b>CodeZipFile</b>, use the prepopulated <b>code.zip</b> value. This is the key name of the sample code S3 object. The object should be a .zip file.</p> <p>9. For <b>RepositoryName</b>, use the prepopulated <b>aws-glue-unit-testing</b> name. This is the name of the CodeCommit repository that's created by the stack.</p> <p>10 For <b>TestReportGroupName</b>, use the prepopulated <b>glue-unittest-report</b> name. This is the name of the CodeBuild test report group that's created to store the unit test reports.</p> <p>11 Choose <b>Next</b>, and then choose <b>Next</b> again on the <b>Configure stack options</b> page.</p>	



Task	Description	Skills required
	<p>12. On the <b>Review</b> page, under <b>Capabilities</b>, choose the <b>I acknowledge that CloudFormation might create IAM resources with custom names</b> option.</p> <p>13. Choose <b>Submit</b>. After the stack creation is complete, you can see the created resources on the <b>Resources</b> tab. The stack creation takes approximately 5-7 minutes.</p> <p>The stack automatically creates a CodeCommit repository with the initial code that was checked in from the .zip file and uploaded to the S3 bucket. Furthermore, the stack creates a CodePipeline view using the CodeCommit repository as the source. In the steps above, the CodeCommit repository is <b>aws-glue-unit-test</b>, and the pipeline is <b>aws-glue-unit-test-pipeline</b>.</p>	

Task	Description	Skills required
Clean up the resources in your environment.	<p>To avoid additional infrastructure costs, make sure that you delete the stack after experimenting with the examples provided in this pattern.</p> <ol style="list-style-type: none"><li>1. Open the <a href="#">CloudFormation console</a>, and then select the stack that you created.</li><li>2. Choose <b>Delete</b>. This deletes all the resources that your stack created, including CodeCommit repositories, AWS Identity and Access Management (IAM) roles or policies, and CodeBuild projects.</li></ol>	AWS DevOps, DevOps engineer

## Run the unit tests

Task	Description	Skills required
Run the unit tests in the pipeline.	<ol style="list-style-type: none"><li>1. To test the deployed pipeline, sign in to the AWS Management Console, and then open the <a href="#">CodePipeline console</a>.</li><li>2. Select the pipeline created by the CloudFormation stack, and then choose <b>Release change</b>. The pipeline starts running (using the most recent</li></ol>	AWS DevOps, DevOps engineer

Task	Description	Skills required
	<p>code in the CodeCommit repository).</p> <ol style="list-style-type: none"> <li>3. After the <b>Test_and_Build</b> phase is finished, choose the <b>Details</b> tab, and then examine the logs.</li> <li>4. Choose the <b>Reports</b> tab, and then choose the test report from <b>Report history</b> to view the unit test results.</li> <li>5. After the deployment stage is complete, run and monitor the deployed AWS Glue job on the AWS Glue console. For more information, see <a href="#">Monitoring AWS Glue</a> in the AWS Glue documentation.</li> </ol>	

## Troubleshooting

Issue	Solution
<p>A pipeline with an Amazon S3, Amazon ECR, or CodeCommit source no longer starts automatically</p>	<p>If you change any configuration settings for an action that uses event rules in Amazon EventBridge or CloudWatch Events for change detection, the AWS Management Console might not detect a change where source identifiers are similar and have identical initial characters. Because the new event rule is not created by the console, the pipeline no longer starts automatically.</p>

Issue	Solution
	<p>For example, changing a CodeCommit branch name from <code>MyTestBranch-1</code> to <code>MyTestBranch-2</code> is a minor change. Because the change is at the end of the branch name, the event rule for the source action might not update or create a rule for the new source settings.</p> <p>This applies to the following source actions that use events in CloudWatch Events for change detection:</p> <ul style="list-style-type: none"><li>• The S3 bucket name and S3 object key parameters or console identifiers when the source action is in Amazon S3</li><li>• The repository name and image tag parameters or console identifiers when the source action is in Amazon ECR</li><li>• The repository name and branch name parameters or console identifiers when the source action is in CodeCommit</li></ul> <p>To resolve the issue, do one of the following:</p> <ul style="list-style-type: none"><li>• Change the configuration settings in Amazon S3, Amazon ECR, or CodeCommit, so that changes are made to the starting portion of the parameter value. For example, change your branch name from <code>release-branch</code> to <code>2nd-release-branch</code>. Avoid a change at the end of the name, such as <code>release-branch-2</code>.</li><li>• Change the configuration settings in Amazon S3, Amazon ECR, or CodeCommit for each pipeline. For example, change your</li></ul>

Issue	Solution
	<p>branch name from myRepo/myBranch to myDeployRepo/myDeployBranch .</p> <p>Avoid a change at the end of the name, such as myRepo/myBranch2 .</p> <ul style="list-style-type: none"><li>• Instead of using the AWS Management Console, use the AWS Command Line Interface (AWS CLI) or AWS CloudFormation to create and update your change-detection event rules. For instructions on creating event rules for an Amazon S3 source action, see <a href="#">Amazon S3 source actions and CloudWatch Events</a>. For instructions on creating event rules for an Amazon ECR action, see <a href="#">Amazon ECR source actions and CloudWatch Events</a>. For instructions on creating event rules for a CodeCommit action, see <a href="#">CodeCommit source actions and CloudWatch Events</a>. After you edit your action configuration in the console, accept the updated change-detection resources created by the console.</li></ul>

## Related resources

- [AWS Glue](#)
- [Developing and testing AWS Glue jobs locally](#)
- [AWS CloudFormation for AWS Glue](#)

## Additional information

Additionally, you can deploy the AWS CloudFormation templates by using AWS CLI. For more information, see [Quickly deploying templates with transforms](#) in the CloudFormation documentation.

# Set up a Helm v3 chart repository in Amazon S3

Created by Abhishek Sharma (AWS)

**Environment:** PoC or pilot

**Technologies:** DevOps;  
Containers & microservices;  
Modernization

**Workload:** All other  
workloads

**AWS services:** Amazon S3

## Summary

This pattern helps you to manage Helm v3 charts efficiently by integrating the Helm v3 repository into Amazon Simple Storage Service (Amazon S3) on the Amazon Web Services (AWS) Cloud. To use this pattern, you must be familiar with Kubernetes and with Helm, which is a Kubernetes package manager. Using Helm repositories to store charts and control chart versions can improve mean time to restore (MTTR) during outages.

This pattern uses AWS CodeCommit for Helm repository creation, and it uses an S3 bucket as a Helm chart repository, so that the charts can be centrally managed and accessed by developers across the organization.

## Prerequisites and limitations

### Prerequisites

- An active AWS account
- Python version 2.7.12 or later
- pip
- A virtual private cloud (VPC) with subnets and an Amazon Elastic Compute Cloud (Amazon EC2) instance
- Git installed on the EC2 instance
- AWS Identity and Access Management (IAM) access to create the S3 bucket
- IAM (programmable or role) access to Amazon S3 from the client machine

- AWS CodeCommit repository
- AWS Command Line Interface (AWS CLI)

### **Product versions**

- Helm v3
- Python version 2.7.12 or later

## **Architecture**

### **Target technology stack**

- Amazon S3
- AWS CodeCommit
- Helm
- Kubectl
- Python and pip
- Git
- helm-s3 plugin

### **Target architecture**

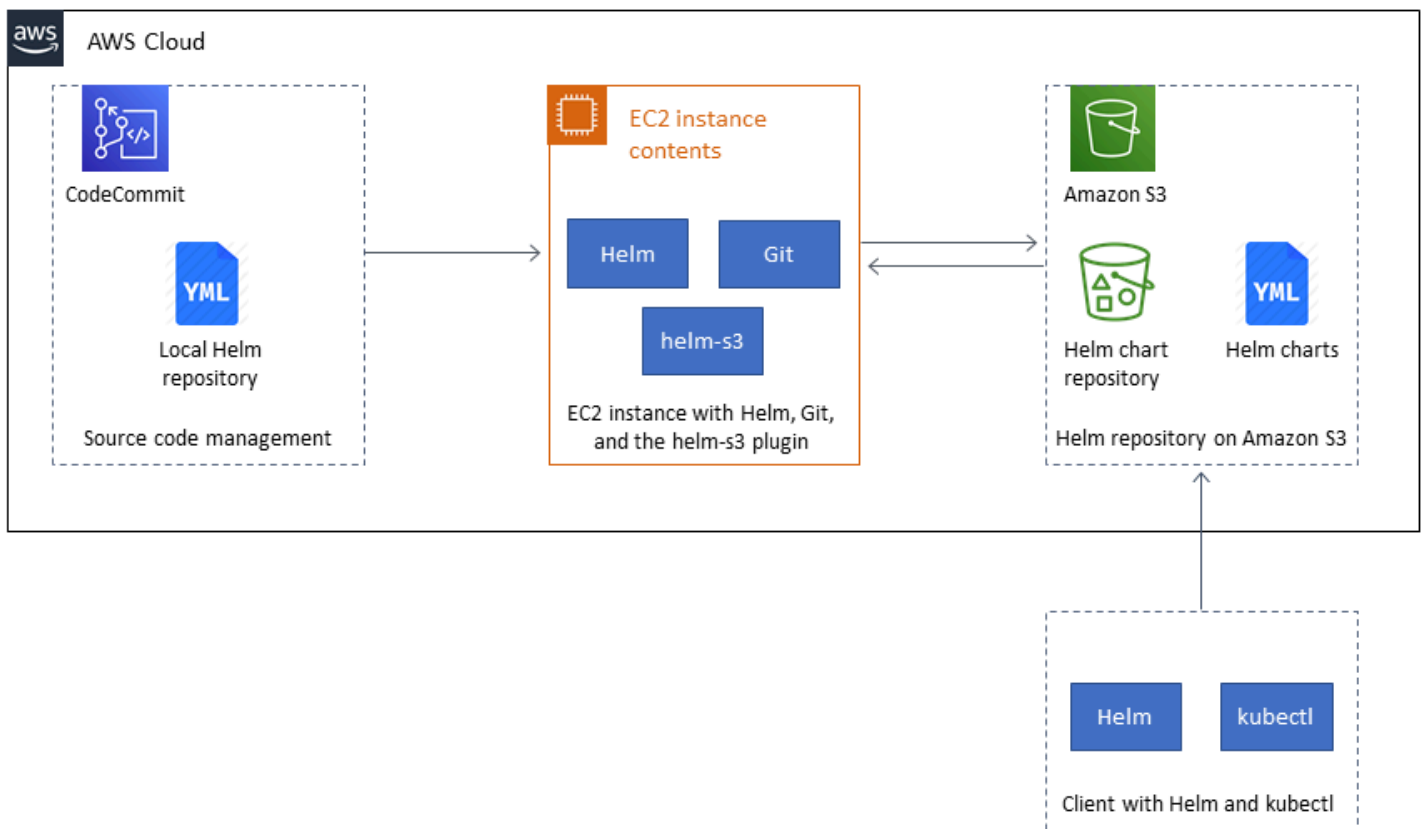

## Automation and scale

- You can incorporate Helm into your existing continuous integration/continuous delivery (CI/CD) automation tool to automate the packaging and version control of Helm charts (out of scope for this pattern).
- GitVersion or Jenkins build numbers can be used to automate version control of the charts.

## Tools

- [Helm](#) – Helm is a package manager for Kubernetes that helps you install and manage applications on your Kubernetes cluster.
- [Amazon S3](#) – Amazon Simple Storage Service (Amazon S3) is storage for the internet. You can use Amazon S3 to store and retrieve any amount of data at any time, from anywhere on the web.
- [helm-s3 plugin](#) – The helm-s3 plugin supports interaction with Amazon S3. It can be used with either Helm v2 or Helm v3.



# Epics

## Install and validate Helm v3

Task	Description	Skills required
Install the Helm v3 client.	To download and install the Helm client on your local system, run the following command: <pre>sudo curl https://raw.githubusercontent.com/helm/helm/main/scripts/get-helm-3   bash</pre>	Cloud Administrator, DevOps Engineer
Validate the Helm installation.	To validate the Helm client, run the following command: <pre>helm version --short</pre>	Cloud Administrator, DevOps Engineer

## Initialize an S3 bucket as a Helm repository

Task	Description	Skills required
Create an S3 bucket for Helm charts.	Create a unique S3 bucket. In the bucket, create a folder called <code>stable/myapp</code> . The example in this pattern uses <code>s3://my-helm-charts/stable/myapp</code> as the target chart repository.	Cloud Administrator, DevOps Engineer
Install the helm-s3 plugin for Amazon S3.	To install the helm-s3 plugin on your client machine, run the following command: <pre>helm plugin install https://github.com</pre>	Cloud Administrator, DevOps Engineer

Task	Description	Skills required
	<code>/hypnoglow/helm-s3.git</code>	
Initialize the Amazon S3 Helm repository.	<p>To initialize the target folder as a Helm repository, use the following command: <code>helm s3 init s3://my-helm-charts/stable/myapp</code></p> <p>The command creates an <code>index.yaml</code> file in the target to track all the chart information that is stored at that location.</p>	Cloud Administrator, DevOps Engineer
Verify the newly created Helm repository.	<p>To verify that the <code>index.yaml</code> file was created, run the following command: <code>aws s3 ls s3://my-helm-charts/stable/myapp/</code></p>	Cloud Administrator, DevOps Engineer
Add the Amazon S3 repository to Helm on the client machine.	<p>To add the target repository alias to the Helm client machine, use the following command: <code>helm repo add stable-myapp s3://my-helm-charts/stable/myapp/</code></p>	Cloud Administrator, DevOps Engineer

## Package and publish charts in the Amazon S3 Helm repository

Task	Description	Skills required
Clone your Helm charts.	If no local Helm charts are present on in your	Cloud Administrator, DevOps Engineer

Task	Description	Skills required
	<p>CodeCommit repository, clone them from your GitHub repo by running the following command: <code>git clone &lt;url_of_your_helm_source_code&gt;.git</code></p>	
Package the local Helm chart.	<p>To package the chart that you created or cloned, use the following command: <code>helm package ./my-app</code></p> <p>As an example, this pattern uses the <code>my-app</code> chart. The command packages all the contents of the <code>my-app</code> chart folder into an archive file, which is named using the version number that is mentioned in the <code>Chart.yaml</code> file.</p>	Cloud Administrator, DevOps Engineer

Task	Description	Skills required
Store the local package in the Amazon S3 Helm repository.	<p>To upload the local package to the Helm repository in Amazon S3, run the following command: <code>helm s3 push ./my-app-0.1.0.tgz stable-myapp</code></p> <p>In the command, <code>my-app</code> is your chart folder name, <code>0.1.0</code> is the chart version mentioned in <code>Chart.yaml</code>, and <code>stable-myapp</code> is the target repository alias.</p>	Cloud Administrator, DevOps Engineer
Search for the Helm chart.	To confirm that the chart appears both locally and in the Amazon S3 Helm repository, run the following command: <code>helm search repo stable-myapp</code>	Cloud Administrator, DevOps Engineer

## Upgrade your Helm repository

Task	Description	Skills required
Modify and package the chart.	In <code>values.yaml</code> , set the <code>replicaCount</code> value to 1, and then package the chart, this time changing the version in <code>Chart.yaml</code> to <code>0.1.1</code> . Version control is ideally achieved through automation by using tools like GitVersion	Cloud Administrator, DevOps Engineer

Task	Description	Skills required
	n or Jenkins build numbers in a CI/CD pipeline. Automating the version number is out of scope for this pattern. To package the chart, run the following command: <code>helm package ./my-app/</code>	
Push the new version to the Helm repository in Amazon S3.	To push the new package, version of 0.1.1, to the <i>my-helm-charts</i> Helm repository in Amazon S3, run the following command: <code>helm s3 push ./my-app-0.1.1.tgz stable-myapp</code>	Cloud Administrator, DevOps Engineer
Verify the updated Helm chart.	To confirm that the updated chart appears both locally and in the Amazon S3 Helm repository, run the following commands.  <code>helm repo update</code>  <code>helm search repo stable-myapp</code>	Cloud Administrator, DevOps Engineer

### Search for and install a chart from the Amazon S3 Helm repository

Task	Description	Skills required
Search for all versions of the my-app chart.	To view all the available versions of a chart, run the following command with the	DevOps Engineer

Task	Description	Skills required
	<pre>--versions flag: helm search repo my-app -- versions</pre> <p>Without the flag, Helm by default displays the latest uploaded version of a chart.</p>	
Install a chart from the Amazon S3 Helm repository.	<p>Automated installation is out of scope for this pattern, but you can manually install. The search results from the previous task show the multiple versions of the my-app chart. To install the new version (0.1.1) from the Amazon S3 Helm repository, use the following command:</p> <pre>helm upgrade --install my-app-re lease stable-myapp/ my-app --version 0.1.1 --namespace dev</pre>	DevOps Engineer

## Roll back to a previous version by using Helm

Task	Description	Skills required
Review the details for a specific revision.	<p>Automated rollback is out of scope for this pattern, but you can roll back to an earlier version manually. Before you switch or roll back to a working version, and for an additional layer</p>	DevOps Engineer

Task	Description	Skills required
	of validation before installing a revision, view which values were passed to each of the revisions by using the following command: <code>helm get values --revision=2 my-app-release</code>	
Roll back to a previous version.	Automated rollback is out of scope for this pattern. To manually roll back to a previous revision, use the following command: <code>helm rollback my-app-release 1</code>  This example is rolling back to revision number 1.	DevOps Engineer

## Related resources

- [HELM documentation](#)
- [helm-s3 plugin \(MIT License\)](#)
- [Amazon S3](#)

# Set up a CI/CD pipeline by using AWS CodePipeline and AWS CDK

Created by Konstantin Zarudaev (AWS), Cizer Pereira (AWS), Lars Kinder (AWS), and Yasha Dabas (AWS)

<b>Code repository:</b> <a href="#">AWS CodePipeline with CI/CD</a>	<b>Environment:</b> PoC or pilot	<b>Technologies:</b> DevOps
<b>Workload:</b> Open-source	<b>AWS services:</b> AWS CodePipeline	

## Home

Automating your software build and release process with continuous integration and continuous delivery (CI/CD) supports repeatable builds and rapid delivery of new features to your users. You can quickly and easily test each code change, and you can catch and fix bugs before releasing your software. By running each change through your staging and release process, you can verify the quality of your application or infrastructure code. CI/CD embodies a culture, a set of operating principles, and a [collection of practices](#) that help application development teams to deliver code changes more frequently and reliably. The implementation is also known as the *CI/CD pipeline*.

This pattern defines a reusable continuous integration and continuous delivery (CI/CD) pipeline on Amazon Web Services (AWS). The AWS CodePipeline pipeline is written using [AWS Cloud Development Kit \(AWS CDK\) v2](#).

Using CodePipeline, you can model the different stages of your software release process through the AWS Management Console interface, the AWS Command Line Interface (AWS CLI), AWS CloudFormation, or the AWS SDKs. This pattern demonstrates the implementation of CodePipeline and its components using AWS CDK. In addition to construct libraries, AWS CDK includes a toolkit (the CLI command `cdk`), which is the primary tool for interacting with your AWS CDK app. Among other functions, the toolkit provides the ability to convert one or more stacks to CloudFormation templates and deploy them to an AWS account.



The pipeline includes tests to validate the security of your third-party libraries, and it helps ensure expedited, automated release in the specified environments. You can increase the overall security of your applications by putting them through a validation process.

The intent of this pattern is to accelerate your use of CI/CD pipelines to deploy your code while ensuring the resources you deploy adhere to DevOps best practices. After you implement the [example code](#), you will have an [AWS CodePipeline](#) with linting, testing, a security check, deployment, and post-deployment processes. This pattern also includes steps for Makefile. Using a Makefile, developers can reproduce CI/CD steps locally and increase the velocity of the development process.

## Prerequisites and limitations

### Prerequisites

- An active AWS account
- A basic understanding in the following:
  - AWS CDK
  - AWS CloudFormation
  - AWS CodePipeline
  - TypeScript

### Limitations

This pattern uses [AWS CDK](#) for TypeScript only. It doesn't cover other languages supported by AWS CDK.

### Product versions

Use the latest versions of the following tools:

- AWS Command Line Interface (AWS CLI)
- cfn\_nag
- git-remote-codecommit
- Node.js

# Architecture

## Target technology stack

- AWS CDK
- AWS CloudFormation
- AWS CodeCommit
- AWS CodePipeline

## Target architecture

The pipeline is triggered by a change in the AWS CodeCommit repository (`SampleRepository`). In the beginning, CodePipeline builds artifacts, updates itself, and starts the deployment process. The resulting pipeline deploys a solution to three independent environments:

- Dev – Three-step code check in the active development environment
- Test – Integration and regression test environment
- Prod – Production environment

The three steps included in the Dev stage are linting, security, and unit tests. These steps run in parallel to speed up the process. To ensure that the pipeline provides only working artifacts, it will stop running whenever a step in the process fails. After a Dev stage deployment, the pipeline runs validation tests to verify the results. In the case of success, the pipeline will then deploy the artifacts to the Test environment, which contains post-deployment validation. The final step is to deploy the artifacts to the Prod environment.

The following diagram shows the workflow from the CodeCommit repository to the build and update processes performed by CodePipeline, the three Dev environment steps, and subsequent deployment and validation in each of the three environments.

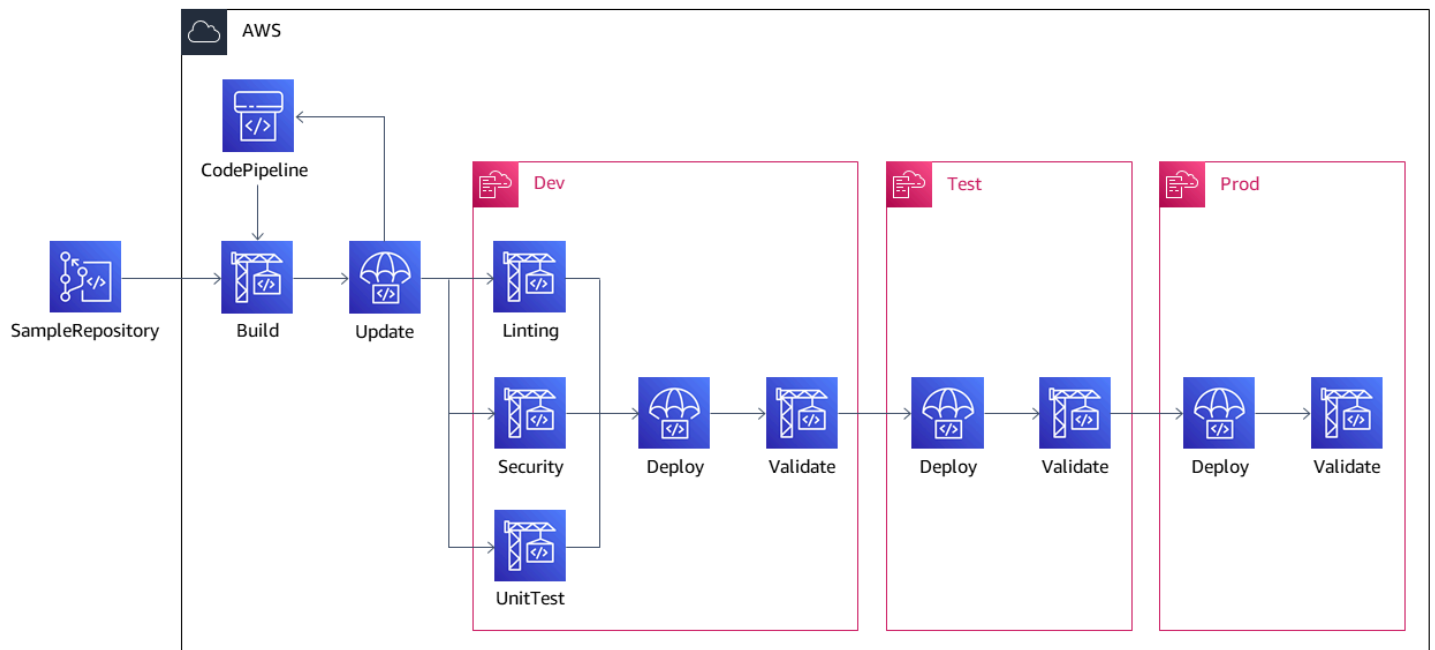

## Tools

### AWS services

- [AWS Cloud Development Kit \(AWS CDK\)](#) is a software development framework that helps you define and provision AWS Cloud infrastructure in code.
- [AWS CloudFormation](#) helps you set up AWS resources, provision them quickly and consistently, and manage them throughout their lifecycle across AWS accounts and Regions. In this pattern CloudFormation templates can be used to create a CodeCommit repository and a CodePipeline CI/CD pipeline.
- [AWS CodeCommit](#) is a version control service that helps you privately store and manage Git repositories, without needing to manage your own source control system.
- [AWS CodePipeline](#) is a CI/CD service that helps you quickly model and configure the different stages of a software release and automate the steps required to release software changes continuously.
- [AWS Command Line Interface \(AWS CLI\)](#) is an open-source tool that helps you interact with AWS services through commands in your command-line shell.

### Other tools

- [cfn\\_nag](#) is an open-source tool that looks for patterns in CloudFormation templates to identify potential security issues.
- [git-remote-codecommit](#) is a utility for pushing and pulling code from CodeCommit repositories by extending Git.
- [Node.js](#) is an event-driven JavaScript runtime environment designed for building scalable network applications.

## Code

The code for this pattern is available in the GitHub [AWS CodePipeline with CI/CD practices](#) repository.

## Best practices

Review resources, such as AWS Identity and Access Management (IAM) policies, to confirm that they align with your organizational best practices.

## Epics

### Install tools

Task	Description	Skills required
Install tools on macOS or Linux.	<p>If you are using MacOS or Linux, you can install the tools by running the following command in your preferred terminal or using <a href="#">Homebrew for Linux</a>.</p> <pre>brew install brew install git-remot e-codecommit brew install ruby brew- gem brew-gem install cfn- nag</pre>	DevOps engineer

Task	Description	Skills required
Install tools using AWS Cloud9.	<p>If you are using <a href="#">AWS Cloud9</a>, install the tools by running the following command.</p> <pre>gem install cfn-nag</pre> <p><b>Note:</b> AWS Cloud9 should have Node.js and npm installed. To check the installation or version, run the following command.</p> <pre>node -v npm -v</pre>	DevOps engineer
Set up AWS CLI.	<p>To set up AWS CLI, use the instructions for your operating system:</p> <ul style="list-style-type: none"><li>• Windows: <a href="#">Setup steps for HTTPS connections to AWS CodeCommit repositories on Windows with the AWS CLI credential helper</a></li><li>• Linux, macOS, Unix: <a href="#">Setup steps for HTTPS connections to AWS CodeCommit repositories on Linux, macOS, or Unix with the AWS CLI credential helper</a></li></ul>	DevOps engineer

## Set up the initial deployment

Task	Description	Skills required
	<p>Download or clone the code.</p> <p>To get the code that is used by this pattern, do one of the following:</p> <ul style="list-style-type: none"><li>• Download the latest source code from <a href="#">releases</a> in the GitHub repo, and unzip the downloaded file into a folder.</li><li>• Clone the project by running the following command.</li></ul> <pre data-bbox="594 957 1027 1157">git clone --depth 1 https://github.com/aws-samples/aws-codepipeline-cicd.git</pre> <p>Remove the <code>.git</code> directory from the cloned repository.</p> <pre data-bbox="594 1314 1027 1476">cd ./aws-codepipeline-cicd rm -rf ./git</pre> <p>Later, you will use a newly created AWS CodeCommit repository as a remote origin.</p>	DevOps engineer
Connect to the AWS account.	You can connect by using a temporary security token or landing zone authentication. To confirm that you are using	DevOps engineer

Task	Description	Skills required
	<p>the correct account and AWS Region, run the following commands.</p> <pre>AWS_REGION="eu-west-1" ACCOUNT_NUMBER=\$(aws   sts get-caller-identit   y --query Account --   output text) echo "\${ACCOUNT   T_NUMBER}"</pre>	
<p>Bootstrap the environment.</p>	<p>To bootstrap an AWS CDK environment, run the following commands.</p> <pre>npm install npm run cdk bootstrap "aws://\${ACCOUNT_N   UMBER}/\${AWS_REGION}"</pre> <p>After you successfully bootstrap the environment, the following output should be displayed.</p> <pre># Bootstrapping   environment aws://{ac   count}/{region}... # Environment aws://   {account}/{region}   bootstrapped</pre> <p>For more information about AWS CDK bootstrapping, see the <a href="#">AWS CDK documentation</a>.</p>	<p>DevOps engineer</p>

Task	Description	Skills required
Synthesize a template.	<p>To synthesize an AWS CDK app, use the <code>cdk synth</code> command.</p> <pre data-bbox="594 394 1027 474">npm run cdk synth</pre> <p>You should see the following output.</p> <pre data-bbox="594 632 1027 1024">Successfully synthesized to &lt;path-to-directory&gt;/aws-codepipeline-cicd/cdk.out Supply a stack id (CodePipeline, DevMainStack) to display its template.</pre>	DevOps engineer



Task	Description	Skills required
Deploy the CodePipeline stack.	<p>Now that you bootstrapped and synthesized the CloudFormation template, you can deploy it. The deployment will create the CodePipeline pipeline and a CodeCommit repository, which will be the source and trigger of the pipeline.</p> <pre data-bbox="594 680 1027 840">npm run cdk -- deploy CodePipeline --require -approval never</pre> <p>After you run the command, you should see a successful deployment of the CodePipeline stack and output information. The <code>CodePipeline.RepositoryName</code> gives you the name of the CodeCommit repository in the AWS account.</p> <pre data-bbox="594 1331 1027 1854">CodePipeline: deploying ... CodePipeline: creating CloudFormation changeset... # CodePipeline Outputs: CodePipeline.R epositoryName = SampleRepository Stack ARN: arn:aws:cloudformation :REGION:ACCOUNT-ID</pre>	DevOps engineer

Task	Description	Skills required
	<code>:stack/CodePipeline/ STACK-ID</code>	

Task	Description	Skills required
Set up the remote CodeCommit repository and branch.	<p>After a successful deployment, CodePipeline will initiate the first run of the pipeline, which you can find in the <a href="#">AWS CodePipeline console</a>. Because AWS CDK and CodeCommit don't initiate a default branch, this initial pipeline run will fail and return the following error message.</p> <pre data-bbox="597 779 1027 1171">The action failed because no branch named main was found in the selected AWS CodeComm it repository SampleRep ository. Make sure you are using the correct branch name, and then try again. Error: null</pre> <p>To fix this error, set up a remote origin as SampleRepository , and create the required main branch.</p> <pre data-bbox="597 1430 1027 1877">RepoName=\$(aws cloudformation describe-stacks -- stack-name CodePipel ine --query "Stacks[0 ].Outputs[?OutputK ey=='RepositoryNam e'].OutputValue" -- output text) echo "\${RepoName}" #</pre>	DevOps engineer

Task	Description	Skills required
	<pre>git init git branch -m master main git remote add origin codecommit://\${RepoName} git add . git commit -m "Initial commit" git push -u origin main</pre>	

### Test the deployed CodePipeline pipeline

Task	Description	Skills required
Commit a change to activate the pipeline.	<p>After a successful initial deployment, you should have a complete CI/CD pipeline with a main branch for <code>SampleRepository</code> as a source branch. As soon as you commit changes to the main branch, the pipeline will initiate and run the following sequence of actions:</p> <ol style="list-style-type: none"> <li>1. Get your code from the CodeCommit repository.</li> <li>2. Build your code.</li> <li>3. Update the pipeline itself (<code>UpdatePipeline</code> ).</li> <li>4. Run three parallel jobs for linting, security and unit test checks.</li> </ol>	DevOps engineer

Task	Description	Skills required
	<ol style="list-style-type: none"> <li>5. In the case of success, the pipeline will deploy the Main stack from <code>./lib/main-stack.ts</code> to the Dev environment.</li> <li>6. Run a post-deployment check for deployed resources. You can follow all CodePipeline steps and results in the CodePipeline console.</li> <li>7. In the case of success, the pipeline will repeat deployment and validation for the Test and Prod environments.</li> </ol>	

### Test locally by using a Makefile

Task	Description	Skills required
Run the development process by using a Makefile.	<p>You can run the whole pipeline locally by using the <code>make</code> command, or you can run an individual step (for example, <code>make linting</code>).</p> <p>To test using <code>make</code>, perform the following actions:</p> <ul style="list-style-type: none"> <li>• Implement the local pipeline: <code>make</code></li> <li>• Run only unit testing: <code>make unittest</code></li> </ul>	App developer, DevOps engineer

Task	Description	Skills required
	<ul style="list-style-type: none"> <li>• Deploy to the current account: <code>make deploy</code></li> <li>• Clean up the environment: <code>make clean</code></li> </ul>	

## Clean up resources

Task	Description	Skills required
Delete AWS CDK app resources.	<p>To clean up your AWS CDK app, run the following command.</p> <pre>cdk destroy --all</pre> <p>Be aware that the Amazon Simple Storage Service (Amazon S3) buckets that are created during bootstrapping aren't automatically deleted. They need a retention policy that allows deletion, or you need to delete them manually in your AWS account.</p>	DevOps engineer

## Troubleshooting

Issue	Solution
The template isn't working as expected.	<p>If something goes wrong and template is not working, make sure that you have the following:</p> <ul style="list-style-type: none"> <li>• The proper versions of the tools.</li> </ul>

Issue	Solution
	<ul style="list-style-type: none"><li>• Access to the target AWS account (network connectivity).</li><li>• Enough permissions to the target AWS account.</li></ul>

## Related resources

- [Get started with common tasks in IAM Identity Center](#)
- [AWS CodePipeline documentation](#)
- [AWS CDK](#)

# Set up end-to-end encryption for applications on Amazon EKS using cert-manager and Let's Encrypt

Created by Mahendra Revanasiddappa (AWS) and Vasanth Jeyaraj (AWS)

**Code repository:** [End-to-end encryption on Amazon EKS](#)

**Environment:** PoC or pilot

**Technologies:** DevOps; Containers & microservices; Security, identity, compliance

**Workload:** All other workloads

**AWS services:** Amazon EKS; Amazon Route 53

## Summary

Implementing end-to-end encryption can be complex and you need to manage certificates for each asset in your microservices architecture. Although you can terminate the Transport Layer Security (TLS) connection at the edge of the Amazon Web Services (AWS) network with a Network Load Balancer or Amazon API Gateway, some organizations require end-to-end encryption.

This pattern uses NGINX Ingress Controller for ingress. This is because when you create a Kubernetes ingress, the ingress resource uses a Network Load Balancer. The Network Load Balancer doesn't permit uploads of client certificates. Therefore, you can't achieve mutual TLS with Kubernetes ingress.

This pattern is intended for organizations that require mutual authentication between all microservices in their applications. Mutual TLS reduces the burden of maintaining user names or passwords and can also use the turnkey security framework. This pattern's approach is compatible if your organization has a large number of connected devices or must comply with strict security guidelines.

This pattern helps increase your organization's security posture by implementing end-to-end encryption for applications running on Amazon Elastic Kubernetes Service (Amazon EKS). This pattern provides a sample application and code in the GitHub [End-to-end encryption on Amazon EKS](#) repository to show how a microservice runs with end-to-end encryption on Amazon EKS. The pattern's approach uses [cert-manager](#), an add-on to Kubernetes, with [Let's Encrypt](#) as the



certificate authority (CA). Let's Encrypt is a cost-effective solution to manage certificates and provides free certificates that are valid for 90 days. Cert-manager automates the on-demand provisioning and rotating of certificates when a new microservice is deployed on Amazon EKS.

## Intended audience

This pattern is recommended for users who have experience with Kubernetes, TLS, Amazon Route 53, and Domain Name System (DNS).

## Prerequisites and limitations

### Prerequisites

- An active AWS account.
- An existing Amazon EKS cluster.
- AWS Command Line Interface (AWS CLI) version 1.7 or later, installed and configured on macOS, Linux, or Windows.
- The `kubectl` command line utility, installed and configured to access the Amazon EKS cluster. For more information about this, see [Installing kubectl](#) in the Amazon EKS documentation.
- An existing DNS name to test the application. For more information about this, see [Registering domain names using Amazon Route 53](#) in the Amazon Route 53 documentation.
- The latest [Helm](#) version, installed on your local machine. For more information about this, see [Using Helm with Amazon EKS](#) in the Amazon EKS documentation and the GitHub [Helm](#) repository.
- The GitHub [End-to-end encryption on Amazon EKS](#) repository, cloned to your local machine.
- Replace the following values in the `policy.json` and `trustpolicy.json` files from the cloned GitHub [End-to-end encryption on Amazon EKS](#) repository:
  - `<account number>` – Replace with the AWS account ID for the account that you want to deploy the solution in.
  - `<zone id>` – Replace with the domain name's Route 53 zone ID.
  - `<node_group_role>` – Replace with the name of the AWS Identity and Access Management (IAM) role associated with the Amazon EKS nodes.
  - `<namespace>` – Replace with the Kubernetes namespace in which you deploy the NGINX Ingress Controller and the sample application.
  - `<application-domain-name>` – Replace with the DNS domain name from Route 53.

## Limitations

- This pattern doesn't describe how to rotate certificates and only demonstrates how to use certificates with microservices on Amazon EKS.

## Architecture

The following diagram shows the workflow and architecture components for this pattern.

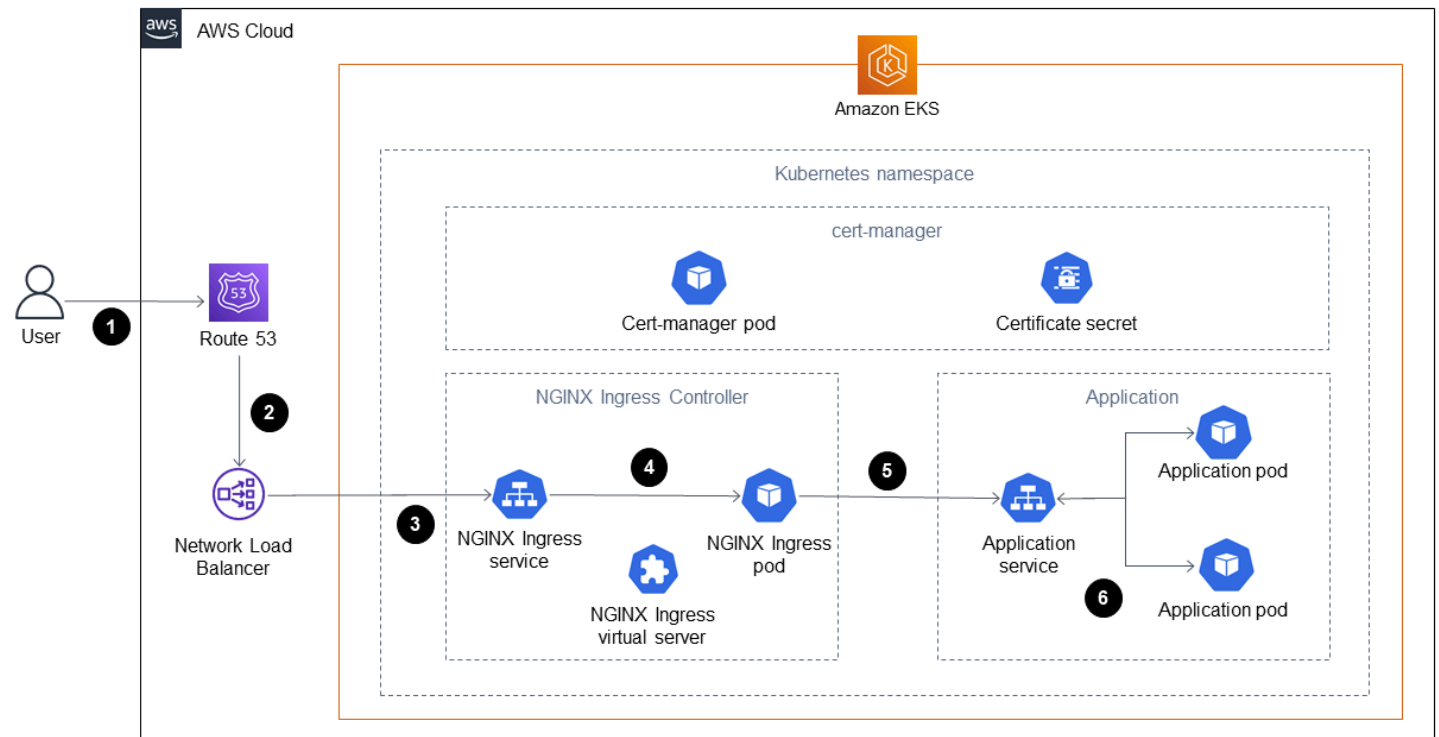

The diagram shows the following workflow:

- A client sends a request to access the application to the DNS name.
- The Route 53 record is a CNAME to the Network Load Balancer.
- The Network Load Balancer forwards the request to the NGINX Ingress Controller that is configured with a TLS listener. Communication between the NGINX Ingress Controller and the Network Load Balancer follows HTTPS protocol.
- The NGINX Ingress Controller carries out path-based routing based on the client's request to the application service.
- The application service forwards the request to the application pod. The application is designed to use the same certificate by calling secrets.

6. Pods run the sample application using the cert-manager certificates. The communication between the NGINX Ingress Controller and the pods uses HTTPS.

**Note:** Cert-manager runs in its own namespace. It uses a Kubernetes cluster role to provision certificates as secrets in specific namespaces. You can attach those namespaces to application pods and NGINX Ingress Controller.

## Tools

### AWS services

- [Amazon Elastic Kubernetes Service \(Amazon EKS\)](#) is a managed service that you can use to run Kubernetes on AWS without needing to install, operate, and maintain your own Kubernetes control plane or nodes.
- [Elastic Load Balancing](#) automatically distributes your incoming traffic across multiple targets, containers, and IP addresses.
- [AWS Identity and Access Management \(IAM\)](#) helps you securely manage access to your AWS resources by controlling who is authenticated and authorized to use them.
- [Amazon Route 53](#) is a highly available and scalable DNS web service.

### Other tools

- [cert-manager](#) is an add-on to Kubernetes that requests certificates, distributes them to Kubernetes containers, and automates certificate renewal.
- [NGINX Ingress Controller](#) is a traffic management solution for cloud-native apps in Kubernetes and containerized environments.

## Epics

### Create and configure a public hosted zone with Route 53

Task	Description	Skills required
Create a public hosted zone in Route 53.	<p>Sign in to the AWS Management Console, open the Amazon Route 53 console, choose <b>Hosted zones</b>, and then choose <b>Create hosted zone</b>. Create a public hosted zone and record the zone ID. For more information about this, see <a href="#">Creating a public hosted zone</a> in the Amazon Route 53 documentation.</p> <p><b>Note:</b> ACME DNS01 uses the DNS provider to post a challenge for cert-manager to issue the certificate. This challenge asks you to prove that you control the DNS for your domain name by putting a specific value in a TXT record under that domain name. After Let's Encrypt gives your ACME client a token, your client creates a TXT record derived from that token and your account key, and it puts that record at <code>_acme-challenge.&lt;YOURDOMAIN&gt;</code>. Then Let's Encrypt queries the DNS</p>	AWS DevOps

Task	Description	Skills required
	for that record. If it finds a match, you can proceed to issue a certificate.	

## Configure an IAM role to allow cert-manager to access the public hosted zone

Task	Description	Skills required
Create the IAM policy for cert-manager.	<p>An IAM policy is required to provide cert-manager with permission to validate that you own the Route 53 domain. The <code>policy.json</code> sample IAM policy is provided in the <code>1-IAMRole</code> directory in the cloned GitHub <a href="#">End-to-end encryption on Amazon EKS</a> repository.</p> <p>Enter the following command in AWS CLI to create the IAM policy.</p> <pre>aws iam create-policy \   --policy-name   PolicyForCertManager   \   --policy-document   file://policy.json</pre>	AWS DevOps
Create the IAM role for cert-manager.	After you create the IAM policy, you must create an IAM role. The <code>trustpolicy.json</code> sample IAM role is	AWS DevOps

Task	Description	Skills required
	<p>provided in the 1-IAMRole directory.</p> <p>Enter the following command in AWS CLI to create the IAM role.</p> <pre data-bbox="602 506 1027 785">aws iam create-role \   --role-name RoleForCertManager \   --assume-role-policy-document file://trustpolicy.json</pre>	
Attach the policy to the role.	<p>Enter the following command in AWS CLI to attach the IAM policy to the IAM role. Replace <code>AWS_ACCOUNT_ID</code> with the ID of your AWS account.</p> <pre data-bbox="602 1136 1027 1491">aws iam attach-role-policy \   --policy-arn arn:aws:iam::AWS_ACCOUNT_ID:policy/PolicyForCertManager \   --role-name RoleForCertManager</pre>	AWS DevOps

## Set up the NGINX Ingress Controller in Amazon EKS

Task	Description	Skills required
Deploy the NGINX Ingress Controller.	Install the most recent version of <code>nginx-ingress</code>	AWS DevOps

Task	Description	Skills required
	<p>using Helm. You can modify the <code>nginx-ingress</code> configuration according to your requirements before deploying it. This pattern uses an annotated, internal-facing Network Load Balancer and that is available in the <code>5-Nginx-Ingress-Controller</code> directory.</p> <p>Install the NGINX Ingress Controller by running the following Helm command from the <code>5-Nginx-Ingress-Controller</code> directory.</p> <pre>helm install test-nginx nginx-stable/nginx-ingress -f 5-Nginx-Ingress-Controller/values_internal_nlb.yaml</pre>	
Verify that the NGINX Ingress Controller is installed.	Enter the <code>helm list</code> command. The output should show that the NGINX Ingress Controller is installed.	AWS DevOps

Task	Description	Skills required
Create a Route 53 A record.	<p>The A record points to the Network Load Balancer created by NGINX Ingress Controller.</p> <ol style="list-style-type: none"><li>1. Get the DNS name of the Network Load Balancer. For instructions, see <a href="#">Getting the DNS name for an ELB load balancer</a>.</li><li>2. On the Amazon Route 53 console, choose <b>Hosted Zones</b>.</li><li>3. Select the public hosted zone that you want to create the record in, and then choose <b>Create record</b>.</li><li>4. Enter a name for the record.</li><li>5. In <b>Record type</b>, choose <b>A - Routes traffic to IPv4 and some AWS resources</b>.</li><li>6. Enable <b>Alias</b>.</li><li>7. In <b>Route traffic to</b>, do the following:<ol style="list-style-type: none"><li>a. Choose <b>Alias to Network Load Balancer</b>.</li><li>b. Choose the AWS Region in which the Network Load Balancer is deployed.</li></ol></li></ol>	AWS DevOps



Task	Description	Skills required
	<p>c. Enter the DNS name of the Network Load Balancer.</p> <p>8. Choose <b>Create records</b>.</p>	

## Set up NGINX VirtualServer on Amazon EKS

Task	Description	Skills required
Deploy NGINX VirtualServer.	<p>The NGINX VirtualServer resource is a load balancing configuration that is an alternative to the ingress resource. The configuration to create the NGINX VirtualServer resource is available in the <code>nginx_virtualserver.yaml</code> file in the <code>6-Nginx-Virtual-Server</code> directory. Enter the following command in <code>kubectl</code> to create the NGINX VirtualServer resource.</p> <pre>kubectl apply -f   nginx_virtualserver.yaml</pre> <p><b>Important:</b> Make sure that you update the application domain name, certificate secret, and application service name in the <code>nginx_virtualserver.yaml</code> file.</p>	AWS DevOps

Task	Description	Skills required
Verify that NGINX VirtualServer is created.	<p>Enter the following command in <code>kubectl</code> to verify that the NGINX VirtualServer resource was successfully created.</p> <pre>kubectl get virtualserver</pre> <p><b>Note:</b> Verify that the Host column matches your application's domain name.</p>	AWS DevOps
Deploy the NGINX web server with TLS enabled.	<p>This pattern uses a NGINX web server with TLS enabled as the application for testing end-to-end encryption. The configuration files required to deploy the test application are available in the <code>demo-webserver</code> directory.</p> <p>Enter the following command in <code>kubectl</code> to deploy the test application.</p> <pre>kubectl apply -f nginx-tls-ap.yaml</pre>	AWS DevOps

Task	Description	Skills required
Verify that the test application resources are created.	<p>Enter the following commands in <code>kubectl</code> to verify that the required resources are created for the test application:</p> <ul style="list-style-type: none"><li>• <code>kubectl get deployments</code></li></ul> <p><b>Note:</b> Validate the Ready column and Available column.</p> <ul style="list-style-type: none"><li>• <code>kubectl get pods   grep -i example-deploy</code></li></ul> <p><b>Note:</b> Pods should be in running state.</p> <ul style="list-style-type: none"><li>• <code>kubectl get configmap</code></li><li>• <code>kubectl get svc</code></li></ul>	AWS DevOps
Validate the application.	<ol style="list-style-type: none"><li>1. Enter the following command by replacing the <code>&lt;application-domain-name&gt;</code> with the Route53 DNS name that you created earlier.</li></ol> <pre>curl --verbose https://&lt;application-domain-name&gt;</pre> <ol style="list-style-type: none"><li>2. Verify that you can access the application.</li></ol>	AWS DevOps

## Related resources

### AWS resources

- [Creating records by using the Amazon Route 53 console](#) (Amazon Route 53 documentation)
- [Using a Network Load Balancer with the NGINX ingress controller on Amazon EKS](#) (AWS blog post)

### Other resources

- [Route 53](#) (cert-manager documentation)
- [Configuring DNS01 Challenge Provider](#) (cert-manager documentation)
- [Let's encrypt DNS challenge](#) (Let's Encrypt documentation)

# Simplify Amazon EKS multi-tenant application deployment by using Flux

Created by Nadeem Rahaman (AWS), Aditya Ambati (AWS), Aniket Dekate (AWS), and Shrikant Patil (AWS)

**Code repository:** [aws-eks-multitenancy-deployment](#)

**Environment:** PoC or pilot

**Technologies:** DevOps; Containers & microservices

**AWS services:** AWS CodeBuild; AWS CodeCommit; AWS CodePipeline; Amazon EKS; Amazon VPC

## Summary

Many companies that offer products and services are data-regulated industries that are required to maintain data barriers between their internal business functions. This pattern describes how you can use the multi-tenancy feature in Amazon Elastic Kubernetes Service (Amazon EKS) to build a data platform that achieves logical and physical isolation between tenants or users that share a single Amazon EKS cluster. The pattern provides isolation through the following approaches:

- Kubernetes namespace isolation
- Role-based access control (RBAC)
- Network policies
- Resource quotas
- AWS Identity and Access Management (IAM) roles for service accounts (IRSA)

In addition, this solution uses Flux to keep the tenant configuration immutable when you deploy applications. You can deploy your tenant applications by specifying the tenant repository that contains the Flux `kustomization.yaml` file in your configuration.

This pattern implements the following:

- An AWS CodeCommit repository, AWS CodeBuild projects, and an AWS CodePipeline pipeline, which are created by manually deploying Terraform scripts.
- Network and compute components required for hosting the tenants. These are created through CodePipeline and CodeBuild by using Terraform.
- Tenant namespaces, network policies, and resource quotas, which are configured through a Helm chart.
- Applications that belong to different tenants, deployed by using Flux.

We recommend that you carefully plan and build your own architecture for multi-tenancy based on your unique requirements and security considerations. This pattern provides a starting point for your implementation.

## Prerequisites and limitations

### Prerequisites

- An active AWS account
- AWS Command Line Interface (AWS CLI) version 2.11.4 or later, [installed](#) and [configured](#)
- [Terraform](#) version 0.12 or later installed on your local machine
- [Terraform AWS Provider](#) version 3.0.0 or later
- [Kubernetes Provider](#) version 2.10 or later
- [Helm Provider](#) version 2.8.0 or later
- [Kubectl Provider](#) version 1.14 or later

### Limitations

- **Dependency on Terraform manual deployments:** The workflow's initial setup, including creating CodeCommit repositories, CodeBuild projects, and CodePipeline pipelines, relies on manual Terraform deployments. This introduces a potential limitation in terms of automation and scalability, because it requires manual intervention for infrastructure changes.
- **CodeCommit repository dependency:** The workflow relies on CodeCommit repositories as the source code management solution and is tightly coupled with AWS services.

# Architecture

## Target architectures

This pattern deploys three modules to build the pipeline, network, and compute infrastructure for a data platform, as illustrated in the following diagrams.

*Pipeline architecture:*

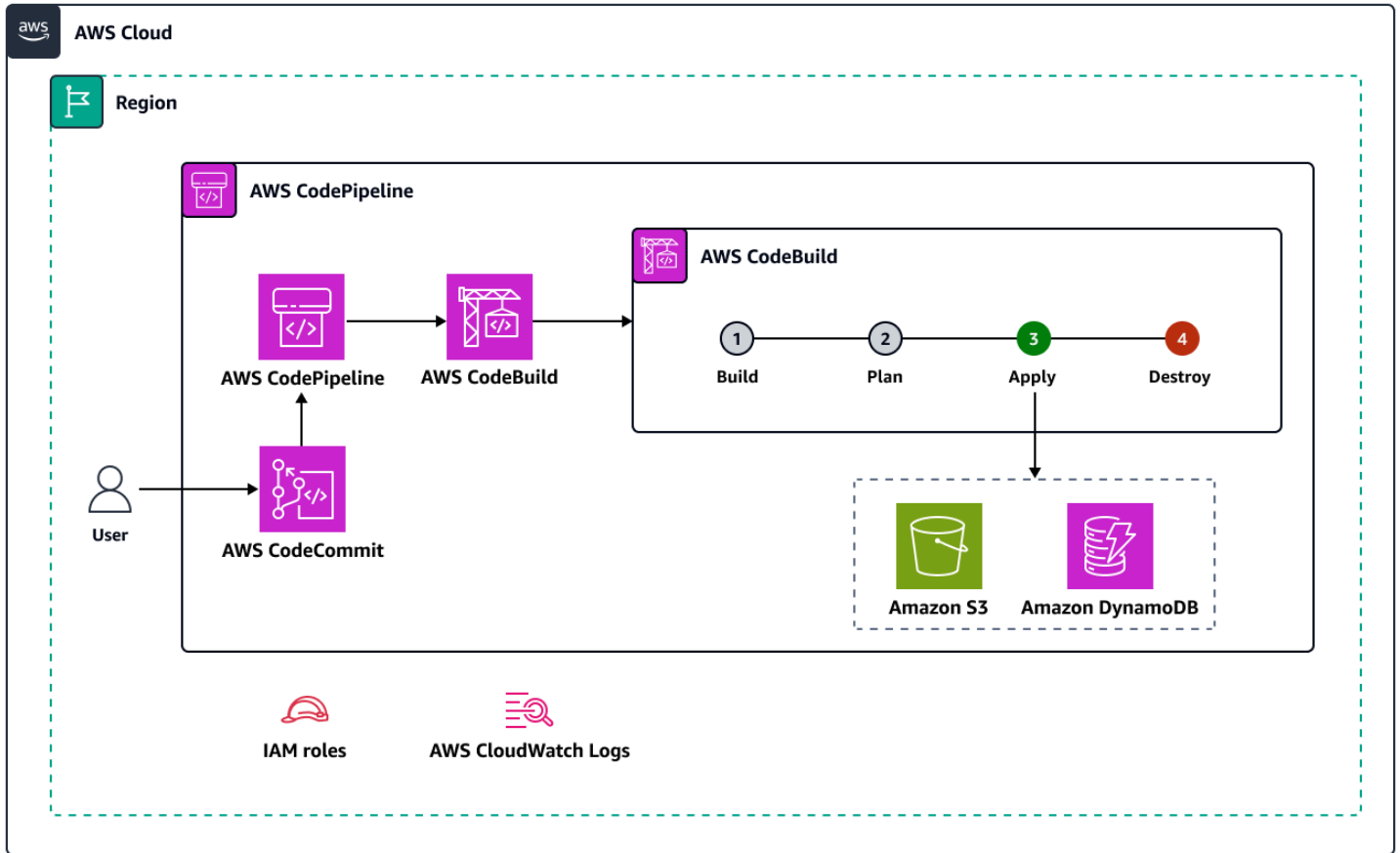

*Network architecture:*

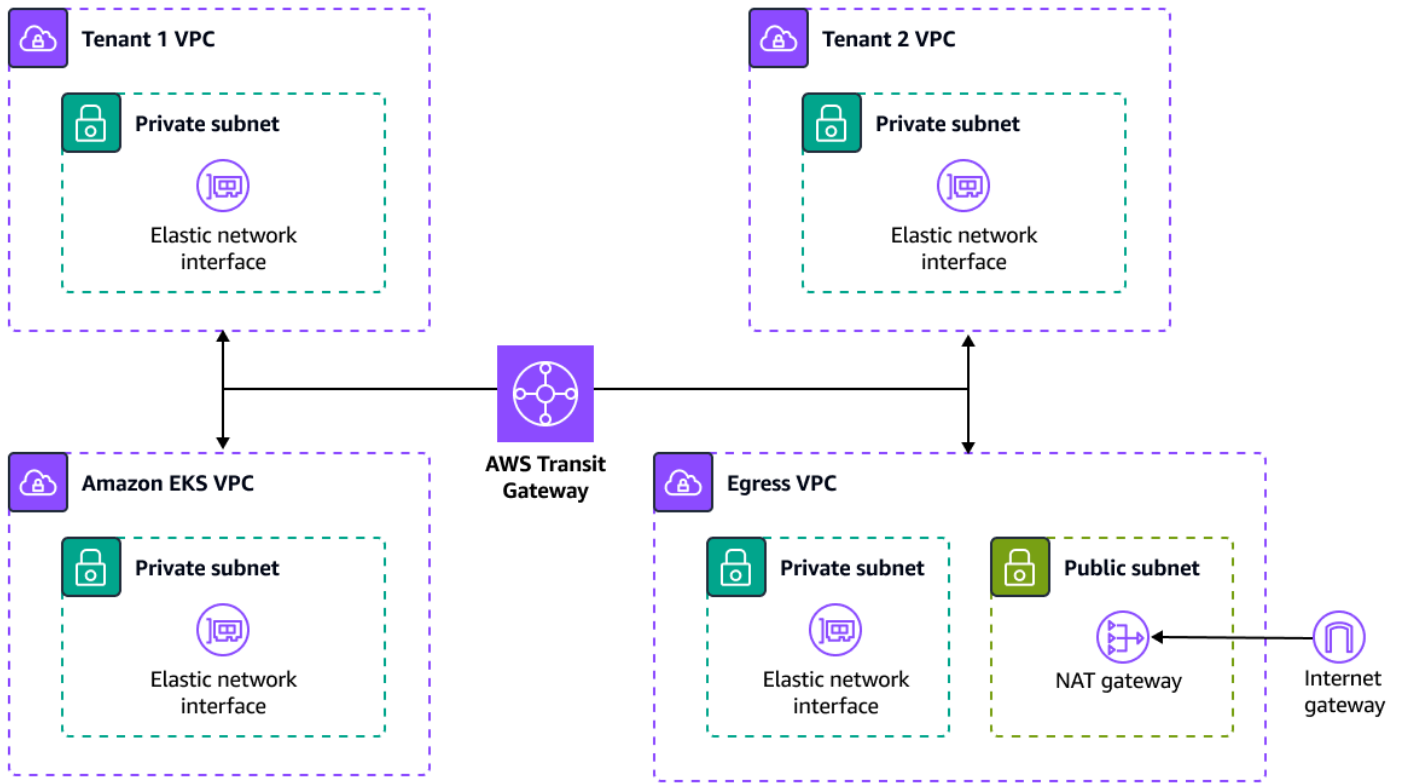

Compute architecture:



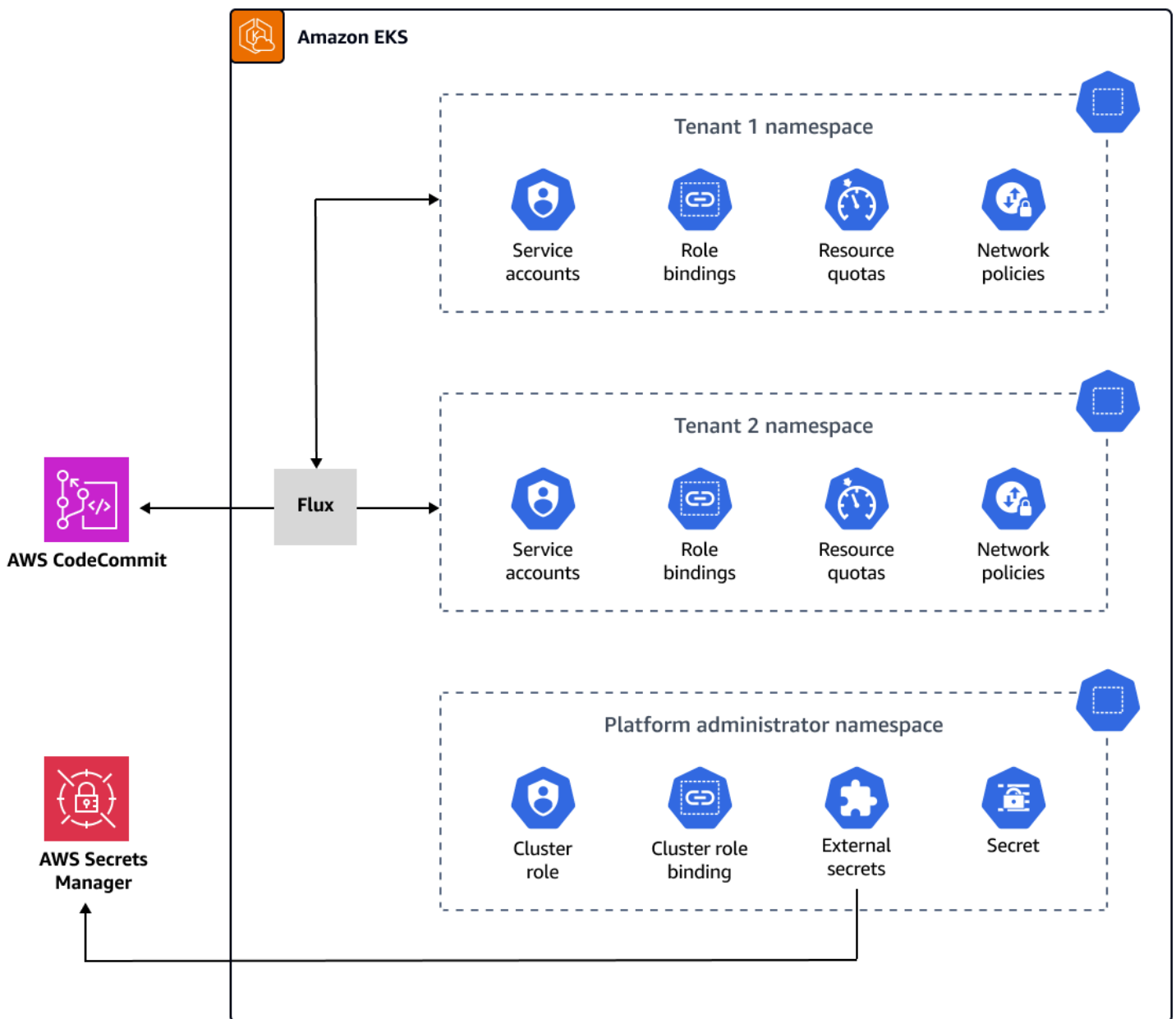

## Tools

### AWS services

- [AWS CodeBuild](#) is a fully managed build service that helps you compile source code, run unit tests, and produce artifacts that are ready to deploy.
- [AWS CodeCommit](#) is a version control service that helps you privately store and manage Git repositories, without needing to manage your own source control system.

- [AWS CodePipeline](#) helps you quickly model and configure the different stages of a software release and automate the steps required to release software changes continuously.
- [Amazon Elastic Kubernetes Service \(Amazon EKS\)](#) helps you run Kubernetes on AWS without needing to install or maintain your own Kubernetes control plane or nodes.
- [AWS Transit Gateway](#) is a central hub that connects virtual private clouds (VPCs) and on-premises networks.
- [Amazon Virtual Private Cloud \(Amazon VPC\)](#) helps you launch AWS resources into a virtual network that you've defined. This virtual network resembles a traditional network that you'd operate in your own data center, with the benefits of using the scalable infrastructure of AWS.

## Other tools

- [Cilium Network Policies](#) support Kubernetes L3 and L4 networking policies. They can be extended with L7 policies to provide API-level security for HTTP, Kafka, and gRPC, and other similar protocols.
- [Flux](#) is a Git-based continuous delivery (CD) tool that automates application deployments on Kubernetes.
- [Helm](#) is an open source package manager for Kubernetes that helps you install and manage applications on your Kubernetes cluster.
- [Terraform](#) is an infrastructure as code (IaC) tool from HashiCorp that helps you create and manage cloud and on-premises resources.

## Code repository

The code for this pattern is available in the GitHub [EKS Multi-Tenancy Terraform Solution](#) repository.

## Best practices

For guidelines and best practices for using this implementation, see the following:

- [Amazon EKS multi-tenancy best practices](#)
- [Flux documentation](#)

# Epics

## Create pipelines for Terraform build, test, and deploy stages

Task	Description	Skills required
Clone the project repository.	<p>Clone the GitHub <a href="#">EKS Multi-Tenancy Terraform Solution</a> repository by running the following command in a terminal window:</p> <pre>git clone https://github.com/aws-samples/aws-eks-multi-tenancy-deployment.git</pre>	AWS DevOps
Bootstrap the Terraform S3 bucket and Amazon DynamoDB.	<ol style="list-style-type: none"><li>1. In the <code>bootstrap</code> folder, open the <code>bootstrap.sh</code> file and update the variable values for the S3 bucket name, DynamoDB table name, and AWS Region:<pre>S3_BUCKET_NAME=" 3_BUCKET_NAME&gt;" DYNAMODB_TABLE_NAME=" ME"&lt;DYNAMODB_NAME &gt;" REGION=" ON&gt;"</pre></li><li>2. Run the <code>bootstrap.sh</code> script. The script requires the AWS CLI, which you installed as part of <a href="#">prerequisites</a>.<pre>cd bootstrap</pre></li></ol>	AWS DevOps

Task	Description	Skills required
	<pre>./bootstrap.sh</pre>	

Task	Description	Skills required
Update the <code>run.sh</code> and <code>locals.tf</code> files.	<ol style="list-style-type: none"><li>1. After the bootstrap process completes successfully, copy the S3 bucket and DynamoDB table name from the <code>variables</code> section of the <code>bootstrap.sh</code> script: <pre data-bbox="630 583 1029 827"># Variables S3_BUCKET_NAME=" S3_BUCKET_NAME&gt;" DYNAMODB_TABLE_NAME =" DYNAMODB_NAME"</pre></li><li>2. Paste those values to the <code>run.sh</code> script, which is in the root directory of the project: <pre data-bbox="630 1058 1029 1331">BACKEND_BUCKET_ID= "&lt;SAME_NAME_AS_S3_ BUCKET_NAME&gt;" DYNAMODB_ID=" &lt;SAME_NAME_AS_DYNA MODB_NAME&gt;"</pre></li><li>3. Upload the project code to a CodeCommit repository. You can automatically create this repository through Terraform by setting the following variable to <code>true</code> in the <code>demo/pipeline/locals.tf</code> file:</li></ol>	AWS DevOps

Task	Description	Skills required
	<pre>create_new_repo = true</pre> <p>4. Update the <code>locals.tf</code> file according to your requirements to create pipeline resources.</p>	
Deploy the pipeline module.	<p>To create pipeline resources, run the following Terraform commands manually. There is no orchestration for running these commands automatically.</p> <pre>./run.sh -m pipeline -e demo -r &lt;AWS_REGION&gt; -t init ./run.sh -m pipeline -e demo -r &lt;AWS_REGION&gt; -t plan ./run.sh -m pipeline -e demo -r &lt;AWS_REGION&gt; -t apply</pre>	AWS DevOps

## Create the network infrastructure

Task	Description	Skills required
Start the pipeline.	<ol style="list-style-type: none"> <li>In the <code>templates</code> folder, make sure that the <code>buildspec</code> files have the following variable set to <code>network</code>:</li> </ol>	AWS DevOps

Task	Description	Skills required
	<pre data-bbox="630 212 1029 327">TF_MODULE_TO_BUILD:   "network"</pre> <p data-bbox="591 344 976 569">2. On the <a href="#">CodePipeline console</a>, on the pipeline details page, start the pipeline by choosing <b>Release change</b>.</p> <p data-bbox="591 646 997 871">After this first run, the pipeline starts automatically whenever you commit a change to the CodeCommit repository main branch.</p> <p data-bbox="591 915 954 999">The pipeline includes the following <a href="#">stages</a>:</p> <ul data-bbox="591 1045 1024 1822" style="list-style-type: none"><li>• <code>validate</code> initializes Terraform, runs Terraform security scans by using the <a href="#">checkov</a> and <a href="#">tfsec</a> tools, and uploads the scan reports to the S3 bucket.</li><li>• <code>plan</code> shows the Terraform plan and uploads the plan to the S3 bucket.</li><li>• <code>apply</code> applies the Terraform plan output from the S3 bucket and creates AWS resources.</li><li>• <code>destroy</code> removes the AWS resources created during the <code>apply</code> stage. To enable</li></ul>	

Task	Description	Skills required
	<p>this optional stage, set the following variable to true in the demo/pipeline/locals.tf file:</p> <pre data-bbox="625 428 1029 548">enable_destroy_stage = true</pre>	



Task	Description	Skills required
Validate the resources created through the network module.	<p>Confirm that the following AWS resources were created after the pipeline deployed successfully:</p> <ul style="list-style-type: none"><li>• An egress VPC with three public and three private subnets, internet gateway, and NAT gateway.</li><li>• An Amazon EKS VPC with three private subnets.</li><li>• Tenant 1 and Tenant 2 VPCs with three private subnets each.</li><li>• A transit gateway with all VPC attachments and routes to each private subnet.</li><li>• A static transit gateway route for the Amazon EKS egress VPC with a destination CIDR block of <code>0.0.0.0/0</code> . This is required to enable all VPCs to have outbound internet access through the Amazon EKS egress VPC.</li></ul>	AWS DevOps

## Create the compute infrastructure

Task	Description	Skills required
<p>Update <code>locals.tf</code> to enable the CodeBuild project's access to the VPC.</p>	<p>To deploy the add-ons for the Amazon EKS private cluster, the CodeBuild project must be attached to the Amazon EKS VPC.</p> <ol style="list-style-type: none"> <li>1. In the <code>demo/pipeline</code> folder, open the <code>locals.tf</code> file, and set the <code>vpc_enabled</code> variable to <code>true</code>.</li> <li>2. Run the <code>run.sh</code> script to apply the changes to the pipeline module:</li> </ol> <pre data-bbox="630 1020 1029 1619">demo/pipeline/locals.tf ./run.sh -m pipeline           -env demo -region           &lt;AWS_REGION&gt; -tfcmd           init ./run.sh -m pipeline           -env demo -region           &lt;AWS_REGION&gt; -tfcmd           plan ./run.sh -m pipeline           -env demo -region           &lt;AWS_REGION&gt; -tfcmd           apply</pre>	<p>AWS DevOps</p>
<p>Update the <code>buildspec</code> files to build the compute module.</p>	<p>In the <code>templates</code> folder, in all <code>buildspec</code> YAML files, set the value of the <code>TF_MODULE_TO_BUILD</code></p>	<p>AWS DevOps</p>

Task	Description	Skills required
	<p>variable from network to compute:</p> <pre data-bbox="597 331 1026 449">TF_MODULE_TO_BUILD: "compute"</pre>	

Task	Description	Skills required
Update the values file for the tenant management Helm chart.	<ol style="list-style-type: none"><li>1. Open the values.yaml file in the following location: <pre>cd cfg-terraform/demo /compute/cfg-tenant-mgmt</pre></li></ol> <p>The file looks like this:</p> <pre>--- global:   clusterRoles:     operator:       platform-tenant       flux: flux-tenant-applier       flux:         tenantClusterBaseUrl: \${TEANT_CLUSTER_BASE_URL}         repoSecret:           \${TENANT_REPO_SECRET}   tenants:     tenant-1:       quotas:         limits:           cpu: 1           memory: 1Gi       flux:         path: overlays/tenant-1     tenant-2:       quotas:         limits:           cpu: 1           memory: 2Gi       flux:</pre>	AWS DevOps

Task	Description	Skills required
	<pre>path: overlays/tenant-2</pre> <p>2. In the <code>global</code> and <code>tenants</code> sections, update the configuration based on your requirements:</p> <ul style="list-style-type: none"><li>• <code>tenantCloneBaseUrl</code> – Path to the repository that hosts the code for all tenants (we use the same Git repository for all tenants)</li><li>• <code>repoSecret</code> – Kubernetes secret that holds the SSH keys and known hosts to authenticate to the global tenant Git repository</li><li>• <code>quotas</code> – Kubernetes resources quotas that you want to apply for each tenant</li><li>• <code>flux path</code> – Path to the tenant application YAML files in the global tenant repository</li></ul>	

Task	Description	Skills required
Validate compute resources.	<p>After you update the files in the previous steps, CodePipeline starts automatically. Confirm that it created the following AWS resources for the compute infrastructure:</p> <ul style="list-style-type: none"> <li>• Amazon EKS cluster with private endpoint</li> <li>• Amazon EKS worker nodes</li> <li>• Amazon EKS add-ons: external secrets, aws-loadbalancer-controller, and metrics-server</li> <li>• GitOps module, Flux Helm chart, Cilium Helm chart, and tenant management Helm chart</li> </ul>	AWS DevOps

## Check tenant management and other resources

Task	Description	Skills required
Validate the tenant management resources in Kubernetes.	<p>Run the following commands to check that tenant management resources were created successfully with the help of Helm.</p> <ol style="list-style-type: none"> <li>1. Tenant namespaces were created, as specified in <code>values.yaml</code> :</li> </ol>	AWS DevOps

Task	Description	Skills required
	<pre>kubectl get ns -A</pre> <p>2. Quotas are assigned to each tenant namespace, as specified in values.yaml :</p> <pre>kubectl get quota --namespace=&lt;tenant_namespace&gt;</pre> <p>3. Details of quotas are correct for each tenant namespace:</p> <pre>kubectl describe quota cpu-memory-resource-quota-limit -n &lt;tenant_namespace&gt;</pre> <p>4. Cilium Network Policies were applied to each tenant namespace:</p> <pre>kubectl get CiliumNetworkPolicy -A</pre>	

Task	Description	Skills required
Verify tenant application deployments.	<p>Run the following commands to verify that the tenant applications were deployed.</p> <ol style="list-style-type: none"><li>1. Flux is able to connect to the CodeCommit repository that's specified in the GitOps module: <pre>kubectl get gitrepositories -A</pre></li><li>2. The Flux kustomization controller has deployed the YAML files in the CodeCommit repository: <pre>kubectl get kustomizations -A</pre></li><li>3. All application resources are deployed in their tenant namespaces: <pre>kubectl get all -n &lt;tenant_namespace&gt;</pre></li><li>4. An ingress has been created for each tenant: <pre>kubectl get ingress -n &lt;tenant_namespace&gt;</pre></li></ol>	



# Troubleshooting

Issue	Solution
<p>You encounter an error message that's similar to the following:</p> <pre>Failed to checkout and determine revision: unable to clone unknown error: You have successfully authenticated over SSH. You can use Git to interact with AWS CodeCommit.</pre>	<p>Follow these steps to troubleshoot the issue:</p> <ol style="list-style-type: none"><li>1. Verify the tenant application repository: An empty or misconfigured repository might be causing the error. Make sure that the tenant application repository contains the required code.</li><li>2. Redeploy the <code>tenant_mgmt</code> module: In the <code>tenant_mgmt</code> module configuration file, locate the <code>app</code> block, and then set the <code>deploy</code> parameter to <code>0</code>:<pre>deploy = 0</pre>After you run the Terraform <code>apply</code> command, change the <code>deploy</code> parameter value back to <code>1</code>:<pre>deploy = 1</pre></li><li>3. Recheck the status: After you run the previous steps, use the following command to check whether the issue persists:<pre>kubectl get gitrepositories -A</pre>If it persists, consider diving deeper into the Flux logs for more details or refer to the <a href="#">Flux general troubleshooting guide</a>.</li></ol>

## Related resources

- [Amazon EKS Blueprints for Terraform](#)
- [Amazon EKS Best Practices Guides, Multi-tenancy section](#)
- [Flux website](#)
- [Helm website](#)

## Additional information

Here's an example repository structure for deploying tenant applications:

```
applications
sample_tenant_app
### README.md
### base
#   ### configmap.yaml
#   ### deployment.yaml
#   ### ingress.yaml
#   ### kustomization.yaml
#   ### service.yaml
### overlays
### tenant-1
#   ### configmap.yaml
#   ### deployment.yaml
#   ### kustomization.yaml
### tenant-2
###   configmap.yaml
###   kustomization.yaml
```

# Subscribe multiple email endpoints to an SNS topic by using a custom resource

Created by Ricardo Morais (AWS)

**Environment:** Production

**Technologies:** DevOps

**AWS services:** Amazon SNS;  
AWS CloudFormation; AWS  
Lambda

## Summary

**Note, August 2022:** AWS CloudFormation now supports the subscription of multiple resources through the **AWS::SNS::Topic** object and its **Subscription** attribute.

This pattern describes how to subscribe multiple email addresses to receive notifications from an Amazon Simple Notification Service (Amazon SNS) topic. It uses an AWS Lambda function as a custom resource in an AWS CloudFormation template. The Lambda function is associated with an input parameter that specifies the email endpoints for the SNS topic.

Currently, you can use the AWS CloudFormation template objects [AWS::SNS::Topic](#) and [AWS::SNS::Subscription](#) to subscribe single endpoints to SNS topics. To subscribe multiple endpoints, you have to invoke the object multiple times. By using the Lambda function as a custom resource, you can subscribe multiple endpoints through an input parameter. You can use this Lambda function as a custom resource in any AWS CloudFormation template.

## Prerequisites and limitations

### Prerequisites

- An active AWS account.
- An AWS profile configured in your local environment with an access key and secret key. You can also run this code from [AWS Cloud9](#).
- Permissions for the following:
  - AWS Identity and Access Management (IAM) role and policy
  - AWS Lambda function
  - Amazon Simple Storage Service (Amazon S3) for uploading the Lambda function

- Amazon SNS topic and policy
- AWS CloudFormation stacks

## Limitations

- The code supports Linux and macOS workstations.

## Product versions

- AWS Command Line Interface (AWS CLI) version 2 or later.

## Architecture

### Target technology stack

- AWS CloudFormation
- Amazon SNS
- AWS Lambda

## Tools

### Tools

- [AWS CLI version 2](#)

### Code

The attachment includes the following files:

- Lambda function: `lambda_function.py`
- AWS CloudFormation template: `template.yaml`
- Two parameter files to handle multiple or single email endpoint subscriptions: `parameters-multiple-values.json` (used as the default) and `parameters-one-value.json`

To deploy the stack, you can use either parameter file. To specify multiple email endpoints:

```
./deploy.sh -p <YOUR_AWS_PROFILE_NAME> -r <YOUR_AWS_PROFILE_REGION>
```

To specify a single email endpoint:

```
./deploy.sh -p <YOUR_AWS_PROFILE_NAME> -r <YOUR_AWS_PROFILE_REGION> -f parameters-one-value.json
```

## Epics

### Option 1 - Deploy an SNS topic with one email subscription

Task	Description	Skills required
Configure the email endpoint for SNS topic subscriptions.	Edit the file <code>parameters-one-value.json</code> (attached), and change the value of the <code>pSNSNotificationsEmail</code> parameter to reflect the email address you want to use, such as <code>someone@example.com</code> .	
Deploy the AWS CloudFormation stack that creates the resources and subscription.	Run the <b>deploy.sh</b> command with your AWS profile name, AWS Region, and the <code>parameters-one-value.json</code> file. <pre>./deploy.sh -p   &lt;YOUR_AWS_PROFILE_NAME&gt; -r &lt;YOUR_AWS_PROFILE_REGION&gt; -f   parameters-one-value.json</pre>	IAM role with proper permissions

## Option 2 - Deploy an SNS topic with two or more email subscriptions

Task	Description	Skills required
Configure the email endpoints for SNS topic subscriptions.	Edit the file parameter <code>s-multiple-values.json</code> (attached), and change the value of the <code>pSNSNotificationsEmail</code> parameter to reflect the email addresses you want to use, separated by commas, as follows: <code>someone1@example.com, someone2@example.com</code> .	
Deploy the AWS CloudFormation stack that creates the resources and subscription.	Run the <b>deploy.sh</b> command with your AWS profile name and AWS Region. You don't have to specify the <code>parameters-multiple-values.json</code> file because it's used by default. <div style="border: 1px solid #ccc; border-radius: 10px; padding: 10px; margin-top: 10px;"> <pre>./deploy.sh -p &lt;YOUR_AWS_PROFILE_ NAME&gt; -r &lt;YOUR_AWS _PROFILE_REGION&gt;</pre> </div>	IAM role with proper permissions

## Option 3 - Deploy an SNS topic through an AWS CloudFormation template

Task	Description	Skills required
Create an SNS topic.	Create an SNS topic through an AWS CloudFormation template, without specifying	IAM role with proper permissions

Task	Description	Skills required
	g subscription endpoints in the <code>AWS::SNS::Topic</code> template object. You can use <code>template.yaml</code> in the attachment as a starting point.	
Create an SNS topic policy.	Create an SNS topic policy in the AWS CloudFormation template.	IAM role with proper permissions
Subscribe the email endpoints list to the SNS topic.	Based on the list of email endpoints (one or more), subscribe the endpoints to the SNS topic you created.	IAM role with proper permissions

## Related resources

### References

- [AWS CloudFormation custom resources](#) (AWS documentation)
- [AWS CloudFormation custom resource creation with Python, AWS Lambda, and crhelper](#) (blog post)

### Required tools

- [AWS CLI version 2](#)

## Attachments

To access additional content that is associated with this document, unzip the following file: [attachment.zip](#)

# Use Serverspec for test-driven development of infrastructure code

*Created by Sushant Jagdale (AWS)*

**Environment:** PoC or pilot

**Technologies:** DevOps;  
Infrastructure; Hybrid cloud

**AWS services:** Amazon  
EC2; AWS CodeBuild; AWS  
CodeDeploy

## Summary

This pattern shows you how to use [Serverspec](#) to use test-driven development (TDD) when writing infrastructure code on the Amazon Web Services (AWS) Cloud. The pattern also covers automation with AWS CodePipeline. TDD will focus attention on what the infrastructure code must do and sets a clear definition of done. You can use Serverspec to test infrastructure created by tools such as AWS CloudFormation, Terraform by HashiCorp, and Ansible.

Serverspec helps with refactoring infrastructure code. With Serverspec, you can write RSpec tests to check installation of various packages and software, run commands, check for running processes and ports, check file permission settings, and so forth. Serverspec checks whether your servers are configured correctly. You install only Ruby on your servers. You don't need to install any agent software.

Test-driven infrastructure provides the following benefits:

- Cross-platform testing
- Validation of expectations
- Confidence in your automation
- Infrastructure consistency and stability
- Fail early

You can use this pattern to run Serverspec unit tests for Apache software and check file permission settings during Amazon Machine Image (AMI) creation. An AMI will be created only if all the test cases pass. Serverspec will perform following tests:



- Apache process is running.
- Apache port is running.
- Apache configuration files and directories exist at certain locations, and so forth.
- File permissions are correctly configured.

## Prerequisites and limitations

### Prerequisites

- An active AWS account
- AWS CodeBuild
- AWS CodeCommit
- AWS CodePipeline
- A virtual private cloud (VPC) with a public subnet
- Installation of AWS Command Line Interface (AWS CLI) and Git

### Product versions

- HashiCorp Packer version: 1.6.6
- Ruby version: 2.5.1 and later
- AWS CLI version: 1.18.185

## Architecture

### Target architecture

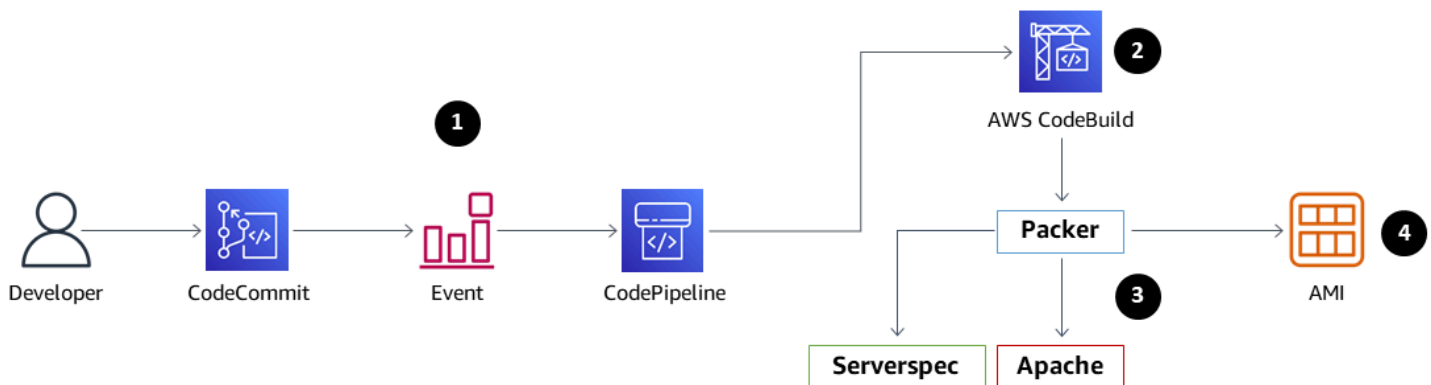

1. When you push the code to the CodeCommit repository, an Amazon CloudWatch Events event engages the CodePipeline. In the first stage of the pipeline, the code is fetched from CodeCommit.
2. The second pipeline stage runs CodeBuild, which validates and builds the Packer template.
3. As a part of the Packer build provisioner, Packer installs Apache and Ruby software. Then the provisioner calls a shell script that uses Serverspec to unit test the Apache process, port, files, and directories. The Packer post-processor writes a JavaScript Object Notation (JSON) file with a list of all the artifacts produced by Packer during a run
4. Finally, an Amazon Elastic Compute Cloud (Amazon EC2) instance is created using the AMI ID produced by Packer.

## Tools

- [AWS CLI](#) – Amazon Command Line Interface (AWS CLI) is an open source tool for interacting with AWS services using commands in your command line shell.
- [Amazon CloudWatch Events](#) – Amazon CloudWatch Events delivers a near-real-time stream of system events that describe changes in Amazon Web Services (AWS) resources.
- [AWS CodeBuild](#) – AWS CodeBuild is a fully managed build service in the cloud. CodeBuild compiles your source code, runs unit tests, and produces artifacts that are ready to deploy.
- [AWS CodeCommit](#) – AWS CodeCommit is a version control service hosted by Amazon Web Services. You can use CodeCommit to privately store and manage assets (such as documents, source code, and binary files) in the cloud.
- [AWS CodePipeline](#) – AWS CodePipeline is a continuous delivery service you can use to model, visualize, and automate the steps required to release your software. You can quickly model and configure the different stages of a software release process.
- [HashiCorp Packer](#) – HashiCorp Packer is a tool for automating the creation of identical machine images from a single source configuration.
- [Serverspec](#) – Serverspec runs RSpec tests to check server configuration. Serverspec uses Ruby, and you don't need to install agent software.

## Code

The code is attached. The code uses the following structure, with three directories and eight files.

```
### amazon-linux_packer-template.json (Packer template)
```

```

### buildspec.yaml (CodeBuild .yaml file)
### pipeline.yaml (AWS CloudFormation template to automate CodePipeline)
### rspec_tests (RSpec required files and spec)
#   ### Gem-file
#   ### Rakefile
#   ### spec
#       ### apache_spec.rb
#       ### spec_helper.rb
### scripts
    ### rspec.sh (Installation of Ruby and initiation of RSpec)

```

## Epics

### Configure AWS credentials

Task	Description	Skills required
Create an IAM user.	Create an AWS Identity and Access Management (IAM) user with programmatic and console access. For more information, see the <a href="#">AWS documentation</a> .	Developer, Systems administrator, DevOps engineer
Configure AWS credentials.	On your local computer or in your environment, configure AWS credentials for the IAM user. For instructions, see the <a href="#">AWS documentation</a> .	Developer, Systems administrator, DevOps engineer
Test your credentials.	To validate the configured credentials, run the following command. <div style="border: 1px solid #ccc; border-radius: 10px; padding: 10px; margin-top: 10px;"> <pre>aws sts get-caller-identity --profile &lt;profile&gt;</pre> </div>	Developer, Systems administrator, DevOps engineer

## AWS CodePipeline

Task	Description	Skills required
Create a CodeCommit repository.	<p>To create a CodeCommit repository, run the following command.</p> <pre>aws codecommit create-repository --repository-name "&lt;provide repository-name&gt;" --repository-description "repository to unit test the infrastructure code"</pre>	Developer, Systems administrator, DevOps engineer
Write RSpec tests.	<p>Create RSpec test cases for your infrastructure. For more information, see the <i>Additional information</i> section.</p>	Developer, DevOps engineer
Push code to the CodeCommit repository.	<p>To push the attached code to the CodeCommit repository, run the following commands.</p> <pre>git clone &lt;repository url&gt; cp -R /tmp/&lt;code folder&gt;/ &lt;repository_folder&gt;/ git add . git commit -m"initial commit" git push</pre>	Developer, Systems administrator, DevOps engineer
Create the pipeline.	<p>To create the pipeline, run the AWS CLI command that is in</p>	Developer, Systems administrator, DevOps engineer

Task	Description	Skills required
	the <i>Additional information</i> section.	
Start the pipeline.	Commit code to the CodeCommit repository. Any commit to the repository will initiate the pipeline.	Developer, Systems administrator, DevOps engineer
Test the Apache URL.	To test the AMI installation, use the following URL.  <pre>http://&lt;your instance public ip&gt;/hello.html</pre> The page will show a "Hello from Apache" message.	Developer, Systems administrator, DevOps engineer

## Related resources

- [HashiCorp](#)
- [HashiCorp Packer](#)
- [Serverspec](#)
- [Introduction to ServerSpec: What is Serverspec and how do we use it at Stelligent?](#) (external blog post)
- [Test-driven development of infrastructure code](#) (external blog post)
- [Image creation and testing with HashiCorp Packer and ServerSpec](#) (external article)

## Additional information

### Write RSpec tests

The RSpec test for this pattern is located at `<repository folder>/rspec_tests/spec/apache_spec.rb`.

```
require 'spec_helper'

describe service('httpd') do
  it { should be_enabled }
  it { should be_running }
end

describe port(80) do
  it { should be_listening }
end

describe file('/etc/httpd/conf/httpd.conf') do
  it { should exist }
  it { should be_owned_by 'root' }
  it { should contain 'ServerName www.example.com' }
end

describe file('/etc/httpd/conf/httpd.conf') do
  its(:content) { should match /ServerName www.example.com/ }
end

describe file('/var/www/html/hello.html') do
  it { should exist }
  it { should be_owned_by 'ec2-user' }
end

describe file('/var/log/httpd') do
  it { should be_directory }
end

describe file('/etc/sudoers') do
  it { should be_mode 440 }
end

describe group('root') do
```

```
it { should have_gid 0 }  
end
```

You can add your own tests to the `/spec` directory.

## Create the pipeline

```
aws cloudformation create-stack --stack-name myteststack --template-body file://  
pipeline.yaml --parameters ParameterKey=RepositoryName,ParameterValue=<provide  
repository-name> ParameterKey=ApplicationName,ParameterValue=<provide  
application-name> ParameterKey=SecurityGroupId,ParameterValue=<provide  
SecurityGroupId> ParameterKey=VpcId,ParameterValue=<provide VpcId>  
ParameterKey=SubnetId,ParameterValue=<provide SubnetId> ParameterKey=Region,ParameterValue=<pr  
AccountId> --capabilities CAPABILITY_NAMED_IAM
```

### *Parameter details*

`repository-name` – The name of the AWS CodeCommit repository

`application-name` – The Amazon Resource Name (ARNs) are linked with `ApplicationName`; provide any name

`SecurityGroupId` – Any security group ID from your AWS account that has port 80 open

`VpcId` – The ID of your VPC

`SubnetId` – The ID of a public subnet in your VPC

`Region` – The AWS Region where you are running this pattern

`Keypair` – The Secure Shell (SSH) key name to log in to the EC2 instance

`AccountId` – Your AWS account ID

You can also create a CodePipeline pipeline by using the AWS Management Console and passing the same parameters that are in the previous command line.

## Attachments

To access additional content that is associated with this document, unzip the following file:

[attachment.zip](#)

# Use third-party Git source repositories in AWS CodePipeline

Created by Kirankumar Chandrashekar (AWS)

**Environment:** PoC or pilot

**Technologies:** DevOps

**Workload:** Open-source

**AWS services:** AWS CodeBuild; AWS CodePipeline; AWS Lambda

## Summary

This pattern describes how to use AWS CodePipeline with third-party Git source repositories.

[AWS CodePipeline](#) is a continuous delivery service that automates tasks for building, testing, and deploying your software. The service currently supports Git repositories managed by GitHub, [AWS CodeCommit](#), and Atlassian Bitbucket. However, some enterprises use third-party Git repositories that are integrated with their single sign-on (SSO) service and Microsoft Active Directory for authentication. You can use these third-party Git repositories as sources for CodePipeline by creating custom actions and webhooks.

A webhook is an HTTP notification that detects events in another tool, such as a GitHub repository, and connects those external events to a pipeline. When you create a webhook in CodePipeline, the service returns a URL that you can use in your Git repository webhook. If you push code to a specific branch of the Git repository, the Git webhook initiates the CodePipeline webhook through this URL, and sets the source stage of the pipeline to **In Progress**. When the pipeline is in this state, a job worker polls CodePipeline for the custom job, runs the job, and sends a success or failure status to CodePipeline. In this case, because the pipeline is in the source stage, the job worker gets the contents of the Git repository, zips the contents, and uploads it to the Amazon Simple Storage Service (Amazon S3) bucket where artifacts for the pipeline are stored, using the object key provided by the polled job. You can also associate a transition for the custom action with an event in Amazon CloudWatch, and initiate the job worker based on the event. This setup enables you to use third-party Git repositories that the service doesn't natively support as sources for CodePipeline.



## Prerequisites and limitations

### Prerequisites

- An active AWS account
- A Git repository that supports webhooks and can connect to a CodePipeline webhook URL through the internet
- AWS Command Line Interface (AWS CLI) [installed](#) and [configured](#) to work with the AWS account

### Architecture

The pattern involves these steps:

1. The user commits code to a Git repository.
2. The Git webhook is called.
3. The CodePipeline webhook is called.
4. The pipeline is set to **In Progress**, and the source stage is set to the **In Progress** state.
5. The source stage action initiates a CloudWatch Events rule, indicating that it was started.
6. The CloudWatch event initiates a Lambda function.
7. The Lambda function gets the details of the custom action job.
8. The Lambda function initiates AWS CodeBuild and passes it all the job-related information.
9. CodeBuild gets the public SSH key or user credentials for HTTPS Git access from Secrets Manager.
10. CodeBuild clones the Git repository for a specific branch.
11. CodeBuild zips the archive and uploads it to the S3 bucket that serves as the CodePipeline artifact store.

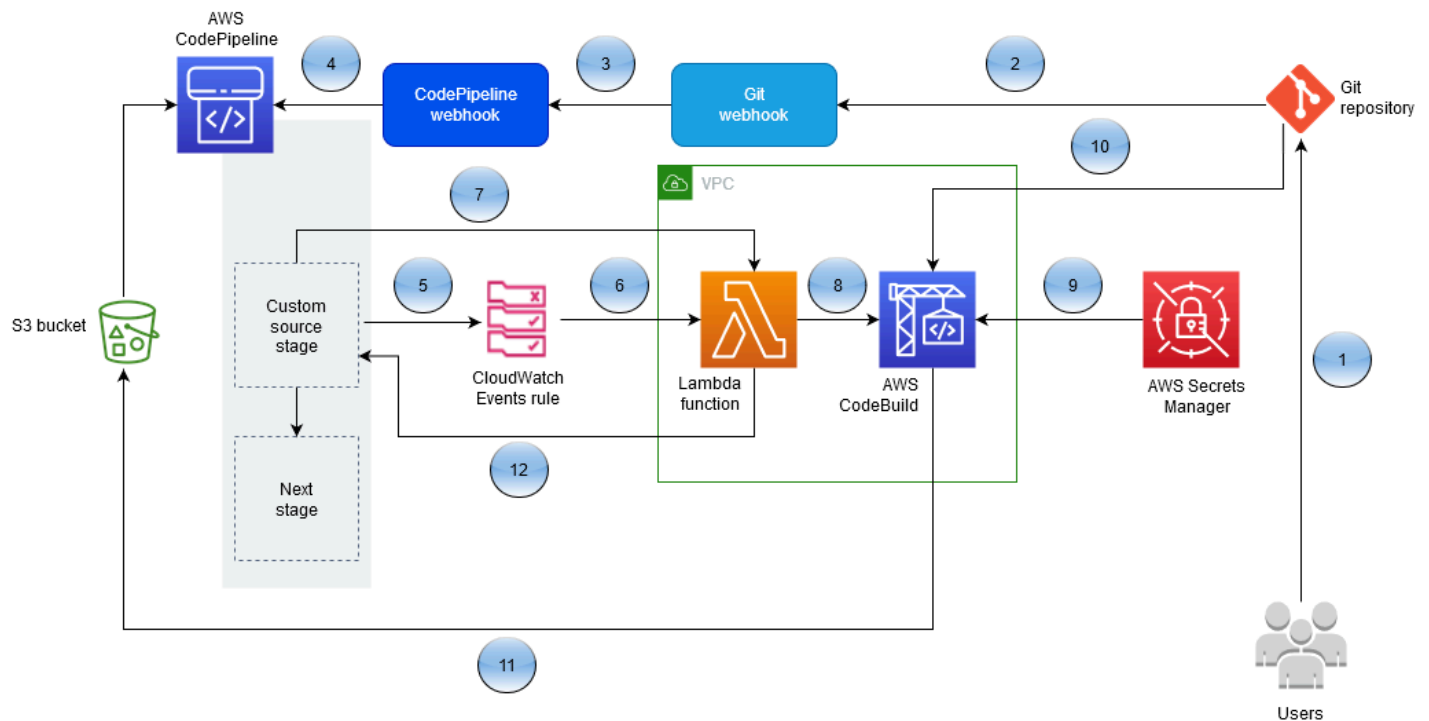

## Tools

- [AWS CodePipeline](#) – AWS CodePipeline is a fully managed [continuous delivery](#) service that helps you automate your release pipelines for fast and reliable application and infrastructure updates. CodePipeline automates the build, test, and deployment phases of your release process for each code change, based on the release model you define. This enables you to rapidly and reliably deliver features and updates. You can integrate AWS CodePipeline with third-party services such as GitHub or with your own custom plugin.
- [AWS Lambda](#) – AWS Lambda lets you run code without provisioning or managing servers. With Lambda, you can run code for virtually any type of application or backend service with no administration necessary. You upload your code and Lambda takes care of everything required to run and scale your code with high availability. You can set up your code to automatically initiate from other AWS services or call it directly from any web or mobile app.
- [AWS CodeBuild](#) – AWS CodeBuild is a fully managed [continuous integration](#) service that compiles source code, runs tests, and produces software packages that are ready to deploy. With CodeBuild, you don't need to provision, manage, and scale your own build servers. CodeBuild scales continuously and processes multiple builds concurrently, so your builds are not left waiting in a queue. You can get started quickly by using prepackaged build environments, or you can create custom build environments that use your own build tools.

- [AWS Secrets Manager](#) – AWS Secrets Manager helps you protect secrets needed to access your applications, services, and IT resources. The service enables you to rotate, manage, and retrieve database credentials, API keys, and other secrets throughout their lifecycle. Users and applications retrieve secrets by calling Secrets Manager APIs, without having to hardcode sensitive information in plain text. Secrets Manager offers secret rotation with built-in integration for Amazon Relational Database Service (Amazon RDS), Amazon Redshift, and Amazon DocumentDB. The service can be extended to support other types of secrets, including API keys and OAuth tokens. In addition, Secrets Manager lets you control access to secrets by using fine-grained permissions, and audit secret rotation centrally for resources in the AWS Cloud, third-party services, and on-premises environments.
- [Amazon CloudWatch](#) – Amazon CloudWatch is a monitoring and observation service built for DevOps engineers, developers, site reliability engineers (SREs), and IT managers. CloudWatch provides you with data and actionable insights to monitor your applications, respond to systemwide performance changes, optimize resource utilization, and get a unified view of operational health. CloudWatch collects monitoring and operational data in the form of logs, metrics, and events, providing you with a unified view of AWS resources, applications, and services that run on AWS and on-premises servers. You can use CloudWatch to detect anomalous behavior in your environments, set alarms, visualize logs and metrics side by side, take automated actions, troubleshoot issues, and discover insights to keep your applications running smoothly.
- [Amazon S3](#) – Amazon Simple Storage Service (Amazon S3) is an object storage service that lets you store and protect any amount of data for a range of use cases, such as websites, mobile applications, backup and restore, archive, enterprise applications, IoT devices, and big data analytics. Amazon S3 provides easy-to-use management features to help you organize your data and configure finely tuned access controls to meet your specific business, organizational, and compliance requirements.

## Epics

### Create a custom action in CodePipeline

Task	Description	Skills required
Create a custom action using AWS CLI or AWS CloudFormation.	This step involves creating a custom source action that can be used in the source	General AWS

Task	Description	Skills required
	<p>stage of a pipeline in your AWS account in a particular region. You must use AWS CLI or AWS CloudFormation (not the console) to create the custom source action. For more information about the commands and steps described in this and other epics, see the "Related resources" section at the end of this pattern. In AWS CLI, use the <code>create-custom-action-type</code> command. Use <code>--configuration-properties</code> to provide all the parameters required for the job worker to process when it polls CodePipeline for a job. Make sure to note the values provided to the <code>--provider</code> and <code>--action-version</code> options, so that you can use the same values when creating the pipeline with this custom source stage. You can also create the custom source action in AWS CloudFormation by using the resource type <code>AWS::CodePipeline::CustomActionType</code>.</p>	

## Set up authentication

Task	Description	Skills required
Create an SSH key pair.	Create a Secure Shell (SSH) key pair. For instructions, see the GitHub documentation.	Systems/DevOps engineer
Create a secret in AWS Secrets Manager.	Copy the contents of the private key from the SSH key pair and create a secret in AWS Secrets Manager. This secret is used for authentication when accessing the Git repository.	General AWS
Add the public key to the Git repository.	Add the public key from the SSH key pair to the Git repository account settings, for authentication against the private key.	Systems/DevOps engineer

## Create a pipeline and webhook

Task	Description	Skills required
Create a pipeline that includes the custom source action.	Create a pipeline in CodePipeline. When you configure the source stage, choose the custom source action that you created previously. You can do this in the AWS CodePipeline console or in AWS CLI. CodePipeline prompts you for the configuration properties that you set on the custom action. This information is	General AWS

Task	Description	Skills required
	<p>required for the job worker to process the job for the custom action. Follow the wizard and create the next stage for the pipeline.</p>	
Create a CodePipeline webhook.	<p>Create a webhook for the pipeline you created with the custom source action. You must use AWS CLI or AWS CloudFormation (not the console) to create the webhook. In AWS CLI, run the <code>put-webhook</code> command and provide the appropriate values for the webhook options. Make a note of the webhook URL that the command returns. If you're using AWS CloudFormation to create the webhook, use the resource type <code>AWS::CodePipeline::Webhook</code>. Make sure to output the webhook URL from the created resource, and make a note of it.</p>	General AWS

Task	Description	Skills required
Create a Lambda function and CodeBuild project.	<p>In this step, you use Lambda and CodeBuild to create a job worker that will poll CodePipeline for job requests for the custom action, run the job, and return the status result to CodePipeline. Create a Lambda function that is initiated by an Amazon CloudWatch Events rule when the custom source action stage of the pipeline transitions to "In Progress." When the Lambda function is initiated, it should get the custom action job details by polling for jobs. You can use the PollForJobs API to return this information. After the polled job information is obtained, the Lambda function should return an acknowledgment, and then process the information with the data it obtains from the configuration properties for the custom action. When the worker is ready to talk to the Git repository, you might initiate a CodeBuild project, because it's convenient to handle Git tasks by using the SSH client.</p>	General AWS, code developer

## Create an event in CloudWatch

Task	Description	Skills required
Create a CloudWatch Events rule.	Create a CloudWatch Events rule that initiates the Lambda function as a target whenever the pipeline's custom action stage transitions to "In Progress."	General AWS

## Related resources

### Creating a custom action in CodePipeline

- [Create and add a custom action in CodePipeline](#)
- [AWS::CodePipeline::CustomActionType resource](#)

### Setting up authentication

- [Creating and Managing Secrets with AWS Secrets Manager](#)

### Creating a pipeline and webhook

- [Create a Pipeline in CodePipeline](#)
- [put-webhook command reference](#)
- [AWS::CodePipeline::Webhook resource](#)
- [PollForJobs API reference](#)
- [Create and Add a Custom Action in CodePipeline](#)
- [Create a build project in AWS CodeBuild](#)

### Creating an event

- [Detect and react to changes in pipeline state with Amazon CloudWatch Events](#)



## Additional references

- [Working with pipelines in CodePipeline](#)
- [AWS Lambda developer guide](#)

# Create a CI/CD pipeline to validate Terraform configurations by using AWS CodePipeline

Created by Aromal Raj Jayarajan (AWS) and Vijesh Vijayakumaran Nair (AWS)

<b>Code repository:</b> <a href="#">aws-codepipeline-terraform-cicd-samples</a>	<b>Environment:</b> PoC or pilot	<b>Technologies:</b> DevOps
<b>Workload:</b> All other workloads	<b>AWS services:</b> AWS CodeBuild; AWS CodeCommit; AWS CodePipeline; Amazon S3; AWS Identity and Access Management	

## Summary

This pattern shows how to test HashiCorp Terraform configurations by using a continuous integration and continuous delivery (CI/CD) pipeline deployed by AWS CodePipeline.

Terraform is a command-line interface application that helps you use code to provision and manage cloud infrastructure and resources. The solution provided in this pattern creates a CI/CD pipeline that helps you validate the integrity of your Terraform configurations by running five [CodePipeline stages](#):

1. “checkout” pulls the Terraform configuration that you’re testing from an AWS CodeCommit repository.
2. “validate” runs infrastructure as code (IaC) validation tools, including [tfsec](#), [TFLint](#), and [checkov](#). The stage also runs the following Terraform IaC validation commands: `terraform validate` and `terraform fmt`.
3. “plan” shows what changes will be applied to the infrastructure if the Terraform configuration is applied.
4. “apply” uses the generated plan to provision the required infrastructure in a test environment.
5. “destroy” removes the test infrastructure that was created during the “apply” stage.

## Prerequisites and limitations

### Prerequisites

- An active AWS account
- AWS Command Line Interface (AWS CLI), [installed](#) and [configured](#)
- [Git](#), installed and configured on your local machine
- [Terraform](#), installed and configured on your local machine

### Limitations

- This pattern's approach deploys AWS CodePipeline into one AWS account and AWS Region only. Configuration changes are required for multi-account and multi-Region deployments.
- The AWS Identity and Access Management (IAM) role that this pattern provisions (**codepipeline\_iam\_role**) follows the principle of least privilege. This IAM role's permissions must be updated based on the specific resources that your pipeline needs to create.

### Product versions

- AWS CLI version 2.9.15 or later
- Terraform version 1.3.7 or later

## Architecture

### Target technology stack

- AWS CodePipeline
- AWS CodeBuild
- AWS CodeCommit
- AWS IAM
- Amazon Simple Storage Service (Amazon S3)
- AWS Key Management Service (AWS KMS)
- Terraform

### Target architecture

The following diagram shows an example CI/CD pipeline workflow for testing Terraform configurations in CodePipeline.

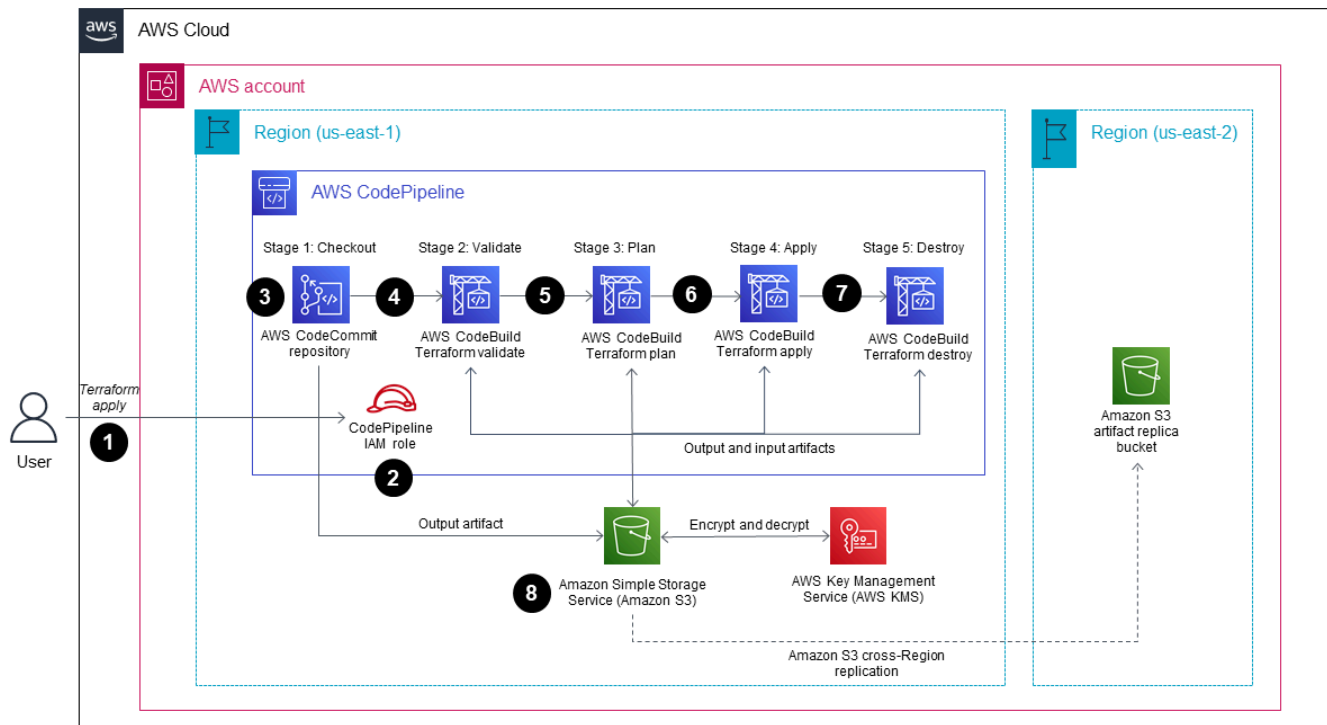

The diagram shows the following workflow:

1. In CodePipeline, an AWS user initiates the actions proposed in a Terraform plan by running the `terraform apply` command in the AWS CLI.
2. AWS CodePipeline assumes an IAM service role that includes the policies required to access CodeCommit, CodeBuild, AWS KMS, and Amazon S3.
3. CodePipeline runs the "checkout" pipeline stage to pull the Terraform configuration from an AWS CodeCommit repository for testing.
4. CodePipeline runs the "validate" stage to test the Terraform configuration by running IaC validation tools and running Terraform IaC validation commands in a CodeBuild project.
5. CodePipeline runs the "plan" stage to create a plan in the CodeBuild project based on the Terraform configuration. The AWS user can review this plan before the changes are applied to the test environment.
6. Code Pipeline runs the "apply" stage to implement the plan by using the CodeBuild project to provision the required infrastructure in the test environment.

7. CodePipeline runs the “destroy” stage, which uses CodeBuild to remove the test infrastructure that was created during the “apply” stage.
8. An Amazon S3 bucket stores pipeline artifacts, which are encrypted and decrypted by using an AWS KMS [customer managed key](#).

## Tools

### Tools

#### *AWS services*

- [AWS CodePipeline](#) helps you quickly model and configure the different stages of a software release and automate the steps required to release software changes continuously.
- [AWS CodeBuild](#) is a fully managed build service that helps you compile source code, run unit tests, and produce artifacts that are ready to deploy.
- [AWS CodeCommit](#) is a version control service that helps you privately store and manage Git repositories, without needing to manage your own source control system.
- [AWS Identity and Access Management \(IAM\)](#) helps you securely manage access to your AWS resources by controlling who is authenticated and authorized to use them.
- [AWS Key Management Service \(AWS KMS\)](#) helps you create and control cryptographic keys to help protect your data.
- [Amazon Simple Storage Service \(Amazon S3\)](#) is a cloud-based object storage service that helps you store, protect, and retrieve any amount of data.

#### *Other services*

- [HashiCorp Terraform](#) is a command-line interface application that helps you use code to provision and manage cloud infrastructure and resources.

### Code

The code for this pattern is available in the GitHub [aws-codepipeline-terraform-cicdsamples](#) repository. The repository contains the Terraform configurations required to create the target architecture outlined in this pattern.

# Epics

## Provision the solution components

Task	Description	Skills required
Clone the GitHub repository.	<p>Clone the GitHub <a href="#">aws-codepipeline-terraform-cicdsamples</a> repository by running the following command in a terminal window:</p> <pre>git clone https://github.com/aws-samples/aws-codepipeline-terraform-cicdsamples.git</pre> <p>For more information, see <a href="#">Cloning a repository</a> in the GitHub documentation.</p>	DevOps engineer
Create a Terraform variable definitions file.	<p>Create a terraform <code>.tfvars</code> file based on your use case requirements. You can update the variables in the <code>examples/terraform.tfvars</code> file that's in the cloned repository.</p> <p>For more information, see <a href="#">Assigning values to root module variables</a> in the Terraform documentation.</p> <p><b>Note:</b> The repository's <code>Readme.md</code> file includes</p>	DevOps engineer

Task	Description	Skills required
	more information on the required variables.	
Configure AWS as the Terraform provider.	<ol style="list-style-type: none"><li data-bbox="591 338 1027 470">1. In a code editor, open the cloned repository's <code>main.tf</code> file.</li><li data-bbox="591 491 1027 667">2. Add the necessary configurations for establishing connectivity to the target AWS account.</li></ol> <p data-bbox="591 743 976 875">For more information, see <a href="#">AWS provider</a> in the Terraform documentation.</p>	DevOps engineer

Task	Description	Skills required
<p>Update the Terraform provider configuration for creating the Amazon S3 replication bucket.</p>	<ol style="list-style-type: none"><li data-bbox="591 226 1027 472">1. Open the repository's S3 directory by running the following command: <pre data-bbox="630 394 1027 472">cd ./modules/s3</pre></li><li data-bbox="591 489 1027 909">2. Update the Terraform provider configuration for creating the Amazon S3 replication bucket by updating the <code>region</code> value in the <code>tf</code> file. Make sure that you enter the Region that you want Amazon S3 to replicate objects to.</li><li data-bbox="591 926 1027 1444">3. <b>(Optional)</b> By default, Terraform uses local state files for state management. If you want to add Amazon S3 as the remote backend, you must update the Terraform configuration. For more information, see <a href="#">Backend configuration</a> in the Terraform documentation.</li></ol> <p data-bbox="591 1518 1027 1696"><b>Note:</b> Replication activates automatic, asynchronous copying of objects across Amazon S3 buckets.</p>	DevOps engineer



Task	Description	Skills required
Initialize the Terraform configuration.	<p>To initialize your working directory that contains the Terraform configuration files, run the following command in the cloned repository's root folder:</p> <pre data-bbox="594 537 1027 617">terraform init</pre>	DevOps engineer
Create the Terraform plan.	<p>To create a Terraform plan, run the following command in the cloned repository's root folder:</p> <pre data-bbox="594 873 1027 1031">terraform plan --var-file=terraform.tfvars -out=tfplan</pre> <p><b>Note:</b> Terraform evaluates the configuration files to determine the target state for the declared resources. It then compares the target state against the current state and creates a plan.</p>	DevOps engineer
Verify the Terraform plan.	Review the Terraform plan and confirm that it configures the required architecture in your target AWS account.	DevOps engineer

Task	Description	Skills required
Deploy the solution.	<ol style="list-style-type: none"> <li>To apply the Terraform plan, run the following command in the cloned repository's root folder: <div style="border: 1px solid #ccc; border-radius: 10px; padding: 5px; margin: 10px 0;"> <pre>terraform apply "tfplan"</pre> </div> </li> <li>Enter <b>yes</b> to confirm that you want to deploy the resources.</li> </ol> <p><b>Note:</b> Terraform creates, updates, or destroys infrastructure to achieve the target state declared in the configuration files.</p>	DevOps engineer

### Validate Terraform configurations by running the pipeline

Task	Description	Skills required
Set up the source code repository.	<ol style="list-style-type: none"> <li>From the Terraform output, get the <b>source repository</b> details for the repository that contains the Terraform configurations that you want to validate.</li> <li>Sign in to the AWS Management Console. Then, open the <a href="#">CodeCommit console</a>.</li> <li>Create a new branch in the source repository named</li> </ol>	DevOps engineer

Task	Description	Skills required
	<p>main. For instructions, see <a href="#">Create a branch in AWS CodeCommit</a> in the CodeCommit documentation.</p> <ol style="list-style-type: none"><li>4. Clone the main branch of the <b>source repository</b> to your local workstation. For instructions, see <a href="#">Setup steps for HTTPS connections to AWS CodeCommit repositories on Windows with the AWS CLI credential helper</a> in the CodeCommit documentation.</li><li>5. Copy the templates folder from the GitHub <a href="#">aws-codepipeline-terraform-cicdsamples</a> repository by running the following command: <pre>cp -r templates \$YOUR_CODECOMMIT_REPO_ROOT</pre></li></ol> <p><b>Note:</b> The templates folder contains the build specification files and the validation script for the root directory of the source repository.</p> <ol style="list-style-type: none"><li>6. Add your required Terraform IaC configura</li></ol>	

Task	Description	Skills required
	<p>tions to the root folder of the <b>source repository</b>.</p> <ol style="list-style-type: none"><li data-bbox="592 310 1019 590">7. Add the details for the remote backend in your project's Terraform configuration. For more information, see <a href="#">S3</a> in the Terraform documentation.</li><li data-bbox="592 611 1019 1125">8. <b>(Optional)</b> Update the variables in the <code>templates</code> folder to either activate or deactivate the preconfigured scans, tool change versions, and to specify your directory in custom script files. For more information, see the <i>Additional information</i> section of this pattern.</li><li data-bbox="592 1146 1019 1276">9. Push the changes to the main branch of the <b>source repository</b>.</li></ol>	

Task	Description	Skills required
Validate the pipeline stages.	<ol style="list-style-type: none"><li>1. Sign in to the AWS Management Console and open the <a href="#">CodePipeline console</a>.</li><li>2. In the output generated from the terraform apply "tfplan" command in the previous Epic section, find the name of the generated <b>CodePipeline</b>.</li><li>3. Open the pipeline in the CodePipeline console and choose <b>Release change</b>.</li><li>4. Review each pipeline stage and confirm it's working as expected.</li></ol> <p>For more information, see <a href="#">View pipeline details and history (console)</a> in the <i>AWS CodePipeline User Guide</i>.</p> <p><b>Important:</b> When a change is committed to the main branch of the source repository, the test pipeline is activated automatically.</p>	DevOps engineer

Task	Description	Skills required
Verify the report output.	<ol style="list-style-type: none"> <li>1. On the <a href="#">CodePipeline console</a>, in the left navigation pane, choose <b>Build</b>. Then, choose <b>Report history</b>.</li> <li>2. Review the tfsec and checkov scan reports that the pipeline generates. These reports can help you identify issues through visualizations and graphical representations.</li> </ol> <p><b>Note:</b> The <code>&lt;project_name&gt;-validate</code> CodeBuild project generates vulnerability reports for your code during the “validate” stage.</p>	DevOps engineer

## Clean up your resources

Task	Description	Skills required
Clean up the pipeline and associated resources.	<p>To delete the test resources from your AWS account, run the following command in the cloned repository's root folder:</p> <pre>terraform destroy --var-file=terraform.tfvars</pre>	DevOps engineer

## Troubleshooting

Issue	Solution
You receive an <b>AccessDenied</b> error during the “apply” stage.	<ol style="list-style-type: none"><li>1. Review the execution logs of the CodeBuild project associated with the “apply” stage to identify any missing IAM permissions. For more information, see <a href="#">View build details in AWS CodeBuild</a> in the <i>AWS CodeBuild User Guide</i>.</li><li>2. In a code editor, open the cloned repository's <code>modules</code> folder. Then, navigate to the <code>iam-role</code> folder and open the <code>main.tf</code> file that's in that folder.</li><li>3. In the <code>codepipeline_policy</code> statement, add the IAM policies that are required for provisioning resources in your AWS account.</li></ol>

## Related resources

- [Module blocks](#) (Terraform documentation)
- [How to use CI/CD to deploy and configure AWS security services with Terraform](#) (AWS blog post)
- [Using service-linked roles](#) (IAM documentation)
- [create-pipeline](#) (AWS CLI documentation)
- [Configure server-side encryption for artifacts stored in Amazon S3 for CodePipeline](#) (AWS CodePipeline documentation)
- [Quotas for AWS CodeBuild](#) (AWS CodeBuild documentation)
- [Data protection in AWS CodePipeline](#) (AWS CodePipeline documentation)

## Additional information

### Custom Terraform modules

The following is a list of custom Terraform modules that are used in this pattern:

- `codebuild_terraform` creates the CodeBuild projects that form each stage of the pipeline.
- `codecommit_infrastructure_source_repo` captures and creates the source CodeCommit repository.
- `codepipeline_iam_role` creates the required IAM roles for the pipeline.
- `codepipeline_kms` creates the required AWS KMS key for Amazon S3 object encryption and decryption.
- `codepipeline_terraform` creates the test pipeline for the source CodeCommit repository.
- `s3_artifacts_bucket` creates an Amazon S3 bucket to manage pipeline artifacts.

### Build specification files

The following is a list of build specification (buildspec) files that this pattern uses to run each pipeline stage:

- `buildspec_validate.yml` runs the “validate” stage.
- `buildspec_plan.yml` runs the “plan” stage.
- `buildspec_apply.yml` runs the “apply” stage.
- `buildspec_destroy.yml` runs the “destroy” stage.

### *Build specification file variables*

Each buildspec file uses the following variables to activate different build-specific settings:

Variable	Default value	Description
<code>CODE_SRC_DIR</code>	<code>"."</code>	Defines the source CodeCommit directory
<code>TF_VERSION</code>	<code>"1.3.7"</code>	Defines the Terraform version for the build environment

The `buildspec_validate.yml` file also supports the following variables to activate different build-specific settings:



---

Variable	Default value	Description
SCRIPT_DIR	"/templates/scripts"	Defines the script directory
ENVIRONMENT	"dev"	Defines the environment name
SKIPVALIDATIONFAILURE	"Y"	Skips validation on failures
ENABLE_TFVALIDATE	"Y"	Activates Terraform validate
ENABLE_TFFORMAT	"Y"	Activates Terraform format
ENABLE_TFCHECKOV	"Y"	Activates checkov scan
ENABLE_TFSEC	"Y"	Activates tfsec scan
TFSEC_VERSION	"v1.28.1"	Defines the tfsec version

## More patterns

- [Access container applications privately on Amazon EKS using AWS PrivateLink and a Network Load Balancer](#)
- [Associate an AWS CodeCommit repository in one AWS account with SageMaker Studio in another account](#)
- [Automate adding or updating Windows registry entries using AWS Systems Manager](#)
- [Automate Amazon Lookout for Vision training and deployment for anomaly detection](#)
- [Automate backups for Amazon RDS for PostgreSQL DB instances by using AWS Batch](#)
- [Automate deployment of nested applications using AWS SAM](#)
- [Automate deployment of Node Termination Handler in Amazon EKS by using a CI/CD pipeline](#)
- [Automate RabbitMQ configuration in Amazon MQ](#)
- [Automate the creation of AppStream 2.0 resources using AWS CloudFormation](#)
- [Automate the replication of Amazon RDS instances across AWS accounts](#)
- [Automatically build and deploy a Java application to Amazon EKS using a CI/CD pipeline](#)
- [Automatically generate a PynamoDB model and CRUD functions for Amazon DynamoDB by using a Python application](#)
- [Automatically validate and deploy IAM policies and roles in an AWS account by using CodePipeline, IAM Access Analyzer, and AWS CloudFormation macros](#)
- [Back up Sun SPARC servers in the Stromasys Charon-SSP emulator on the AWS Cloud](#)
- [Build a data pipeline to ingest, transform, and analyze Google Analytics data using the AWS DataOps Development Kit](#)
- [Build a Micro Focus Enterprise Server PAC with Amazon EC2 Auto Scaling and Systems Manager](#)
- [Build a pipeline for hardened container images using EC2 Image Builder and Terraform](#)
- [Build an MLOps workflow by using Amazon SageMaker and Azure DevOps](#)
- [Centralize DNS resolution by using AWS Managed Microsoft AD and on-premises Microsoft Active Directory](#)
- [Chain AWS services together using a serverless approach](#)
- [Configure logging for .NET applications in Amazon CloudWatch Logs by using NLog](#)
- [Continuously deploy a modern AWS Amplify web application from an AWS CodeCommit repository](#)

- [Create a custom Docker container image for SageMaker and use it for model training in AWS Step Functions](#)
- [Create a pipeline in AWS Regions that don't support AWS CodePipeline](#)
- [Create alarms for custom metrics using Amazon CloudWatch anomaly detection](#)
- [Deploy a pipeline that simultaneously detects security issues in multiple code deliverables](#)
- [Deploy and manage a serverless data lake on the AWS Cloud by using infrastructure as code](#)
- [Deploy Kubernetes resources and packages using Amazon EKS and a Helm chart repository in Amazon S3](#)
- [Deploy multiple-stack applications using AWS CDK with TypeScript](#)
- [Deploy the Security Automations for AWS WAF solution by using Terraform](#)
- [Develop advanced generative AI chat-based assistants by using RAG and ReAct prompting](#)
- [Enable Amazon GuardDuty conditionally by using AWS CloudFormation templates](#)
- [Generate personalized and re-ranked recommendations using Amazon Personalize](#)
- [Get Amazon SNS notifications when the key state of an AWS KMS key changes](#)
- [Identify duplicate container images automatically when migrating to an Amazon ECR repository](#)
- [Improve operational performance by enabling Amazon DevOps Guru across multiple AWS Regions, accounts, and OUs with the AWS CDK](#)
- [Install SSM Agent on Amazon EKS worker nodes by using Kubernetes DaemonSet](#)
- [Integrate Stonebranch Universal Controller with AWS Mainframe Modernization](#)
- [Mainframe modernization: DevOps on AWS with Micro Focus](#)
- [Manage AWS IAM Identity Center permission sets as code by using AWS CodePipeline](#)
- [Manage on-premises container applications by setting up Amazon ECS Anywhere with the AWS CDK](#)
- [Migrate DNS records in bulk to an Amazon Route 53 private hosted zone](#)
- [Migrate ML Build, Train, and Deploy workloads to Amazon SageMaker using AWS Developer Tools](#)
- [Monitor use of a shared Amazon Machine Image across multiple AWS accounts](#)
- [Optimize AWS App2Container generated Docker images](#)
- [Orchestrate an ETL pipeline with validation, transformation, and partitioning using AWS Step Functions](#)
- [Preserve routable IP space in multi-account VPC designs for non-workload subnets](#)

- [Provision a Terraform product in AWS Service Catalog by using a code repository](#)
- [Replicate filtered Amazon ECR container images across accounts or Regions](#)
- [Rotate database credentials without restarting containers](#)
- [Run AWS Systems Manager Automation tasks synchronously from AWS Step Functions](#)
- [Set up a CI/CD pipeline for hybrid workloads on Amazon ECS Anywhere by using AWS CDK and GitLab](#)
- [Set up a CI/CD pipeline for database migration by using Terraform](#)
- [Set up Multi-AZ infrastructure for a SQL Server Always On FCI by using Amazon FSx](#)
- [Set up UiPath RPA bots automatically on Amazon EC2 by using AWS CloudFormation](#)
- [Tenant onboarding in SaaS architecture for the silo model using C# and AWS CDK](#)
- [Use Terraform to automatically enable Amazon GuardDuty for an organization](#)
- [Validate Account Factory for Terraform \(AFT\) code locally](#)
- [Visualize AI/ML model results using Flask and AWS Elastic Beanstalk](#)

# DevelopmentAndTesting

## Topics

- [Automatically generate a PynamoDB model and CRUD functions for Amazon DynamoDB by using a Python application](#)
- [Structure a Python project in hexagonal architecture using AWS Lambda](#)
- [More patterns](#)

# Automatically generate a PynamoDB model and CRUD functions for Amazon DynamoDB by using a Python application

Created by Vijit Vashishtha (AWS), Dheeraj Alimchandani (AWS), and Dhananjay Karanjkar (AWS)

<b>Code repository:</b> <a href="#">amazon-reverse-engineer-dynamodb</a>	<b>Environment:</b> PoC or pilot	<b>Technologies:</b> DevelopmentAndTesting; Databases; DevOps
<b>Workload:</b> Open-source	<b>AWS services:</b> Amazon DynamoDB	

## Summary

It's common to require entities and create, read, update, and delete (CRUD) operations functions to efficiently perform Amazon DynamoDB database operations. PynamoDB is a Python-based interface that supports Python 3. It also provides features such as support for Amazon DynamoDB transactions, automatic attribute value serialization and deserialization, and compatibility with common Python frameworks, such as Flask and Django. This pattern helps developers working with Python and DynamoDB by providing a library that streamlines the automatic creation of PynamoDB models and CRUD operation functions. While it generates essential CRUD functions for database tables, it can also reverse engineer PynamoDB models and CRUD functions from Amazon DynamoDB tables. This pattern is designed to simplify database operations by using a Python-based application.

The following are the key features of this solution:

- **JSON schema to PynamoDB model** – Automatically generate PynamoDB models in Python by importing a JSON schema file.
- **CRUD function generation** – Automatically generate functions to perform CRUD operations on DynamoDB tables.
- **Reverse engineering from DynamoDB** – Use PynamoDB object-relational mapping (ORM) to reverse engineer PynamoDB models and CRUD functions for existing Amazon DynamoDB tables.

## Prerequisites and limitations

### Prerequisites

- An active AWS account
- Python version 3.8 or later, [downloaded](#) and installed
- Jinja2 version 3.1.2 or later, [downloaded](#) and installed
- Amazon DynamoDB tables for which you want to generate ORM
- AWS Command Line Interface (AWS CLI), [installed](#) and [configured](#)
- PynamoDB version 5.4.1 or later, [installed](#)

## Architecture

### Target technology stack

- JSON script
- Python application
- PynamoDB model
- Amazon DynamoDB database instance

### Target architecture

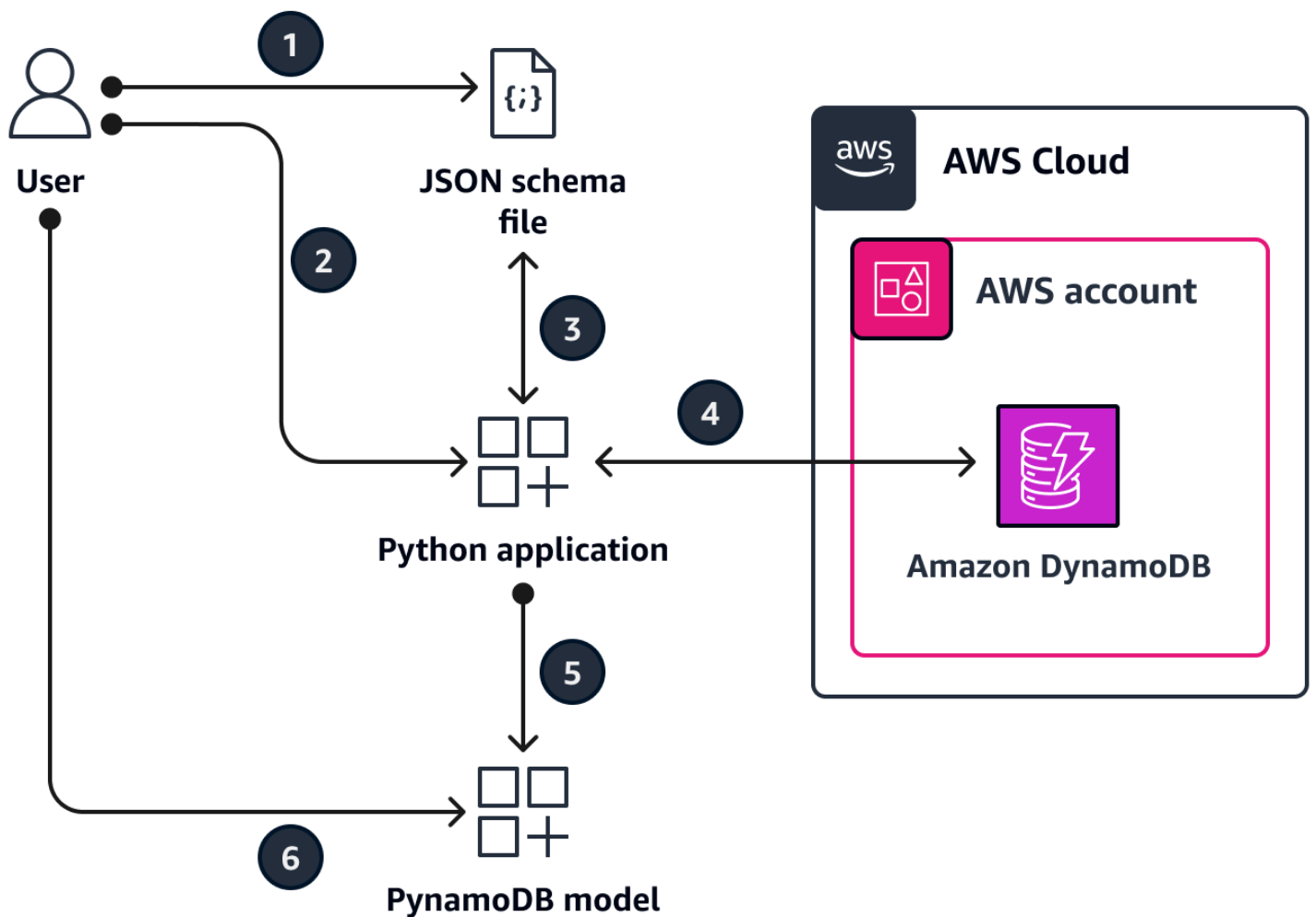

1. You create an input JSON schema file. This JSON schema file represents the attributes of the respective DynamoDB tables that you want to create PynamoDB models from and CRUD functions for. It contains the following three important keys:
  - **name** – The name of the target DynamoDB table.
  - **region** – The AWS region where the table is hosted
  - **attributes** – The attributes that are part of the target table, such as the [partition key](#) (also known as a *hash attribute*), [sort key](#), [local secondary indexes](#), [global secondary indexes](#), and any [non-key attributes](#). This tool expects the input schema to only provide the non-key attributes as the application fetches the key attributes directly from the target table. For an example of how to specify attributes in the JSON schema file, see the [Additional information](#) section of this pattern.
2. Run the Python application and provide the JSON schema file as an input.
3. The Python application reads the JSON schema file.



4. The Python application connects to the DynamoDB tables to derive the schema and data types. The application runs the [describe\\_table](#) operation and fetches the key and index attributes for the table.
5. The Python application combines the attributes from the JSON schema file and DynamoDB table. It uses the Jinja template engine to generate a PynamoDB model and corresponding CRUD functions.
6. You access the PynamoDB model to perform CRUD operations on the DynamoDB table.

## Tools

### AWS services

- [Amazon DynamoDB](#) is a fully managed NoSQL database service that provides fast, predictable, and scalable performance.

### Other tools

- [Jinja](#) is an extensible templating engine that compiles templates into optimized Python code. This pattern uses Jinja to generate dynamic content by embedding placeholders and logic within templates.
- [PynamoDB](#) is a Python-based interface for Amazon DynamoDB.
- [Python](#) is a general-purpose computer programming language.

### Code repository

The code for this pattern is available in the GitHub [Auto-generate PynamoDB models and CRUD functions](#) repository. The repository is divided into two main parts: the controller package and the templates.

#### *Controller package*

The controller Python package contains the main application logic that helps generate the PynamoDB model and the CRUD functions. It contains the following:

- `input_json_validator.py` – This Python script validates the input JSON schema file and creates the Python objects that contain the list of target DynamoDB tables and the required attributes for each.

- `dynamo_connection.py` – This script establishes a connection to the DynamoDB table and uses the `describe_table` operation to extract the attributes that are necessary to create the PynamoDB model.
- `generate_model.py` – This script contains a Python class `GenerateModel` that creates the PynamoDB model based on the input JSON schema file and the `describe_table` operation.
- `generate_crud.py` – For the DynamoDB tables that are defined in the JSON schema file, this script uses the `GenerateCrud` operation to create the Python classes.

## Templates

This Python directory contains the following Jinja templates:

- `model.jinja` – This Jinja template contains the template expression for generating the PynamoDB model script.
- `crud.jinja` – This Jinja template contains the template expression for generating the CRUD functions script.

## Epics

### Set up the environment

Task	Description	Skills required
Clone the repository.	<p>Enter the following command to clone the <a href="#">Auto-generate PynamoDB models and CRUD functions</a> repository.</p> <pre>git clone https://github.com/aws-samples/amazon-reverse-engineer-dynamodb.git</pre>	App developer
Set up the Python environment.	1. Navigate into the top-level directory in the cloned repository.	App developer

Task	Description	Skills required
	<pre data-bbox="634 212 1027 327">cd amazon-reverse-engineer-dynamodb</pre> <p data-bbox="591 342 967 520">2. Enter the following command to install the required libraries and packages.</p> <pre data-bbox="634 558 1027 674">pip install -r requirements.txt</pre>	

### Generate the PynamoDB model and CRUD functions

Task	Description	Skills required
Modify the JSON schema file.	<ol data-bbox="591 993 1023 1125" style="list-style-type: none"> <li>1. Navigate into the top-level directory in the cloned repository.</li> </ol> <pre data-bbox="634 1163 1027 1278">cd amazon-reverse-engineer-dynamodb</pre> <ol data-bbox="591 1293 1023 1856" style="list-style-type: none"> <li>2. Open the <code>test.json</code> file in your preferred editor. You can use this file as a reference to create your own JSON schema file, or you can update the values in this file to match your environment.</li> <li>3. Modify the name, AWS Region, and attributes values for your target DynamoDB tables.</li> </ol>	App developer

Task	Description	Skills required
	<p><b>Note:</b> If you define a table that does not exist in the JSON schema file, this solution does not generate models or CRUD functions for that table.</p> <p>4. Save and close the <code>test.json</code> file. We recommend that you save this file with a new name.</p>	
Run the Python application.	<p>Enter the following command to generate the PynamoDB models and CRUD functions , where <code>&lt;input_schema.json&gt;</code> is the name of your JSON schema file.</p> <pre data-bbox="597 1073 1027 1192">python main.py --file &lt;input_schema.json&gt;</pre>	App developer

## Verify the PynamoDB model and CRUD functions

Task	Description	Skills required
Verify the generated PynamoDB model.	<p>1. In the top-level directory of the cloned repository, enter the following command to navigate into the <code>models</code> repository.</p> <pre data-bbox="630 1745 1027 1822">cd models</pre>	App developer

Task	Description	Skills required
	<p>2. By default, this solution names the PynamoDB model file <code>demo_model_1.py</code>. Validate that this file is present.</p>	
<p>Verify the generated CRUD functions.</p>	<p>1. In the top-level directory of the cloned repository, enter the following command to navigate into the <code>crud</code> repository.</p> <pre>cd crud</pre> <p>2. By default, this solution names the script <code>demo_crud.py</code>. Validate that this file is present.</p> <p>3. Use the Python classes in the <code>demo_crud.py</code> file to perform a CRUD operation on the target DynamoDB table. Confirm that the operation completed successfully.</p>	<p>App developer</p>

## Related resources

- [Core components of Amazon DynamoDB](#) (DynamoDB documentation)
- [Improving data access with secondary indexes](#) (DynamoDB documentation)

## Additional information

### Sample attributes for the JSON schema file

```
[
{
  "name": "test_table",
  "region": "ap-south-1",
  "attributes": [
    {
      "name": "id",
      "type": "UnicodeAttribute"
    },
    {
      "name": "name",
      "type": "UnicodeAttribute"
    },
    {
      "name": "age",
      "type": "NumberAttribute"
    }
  ]
}
]
```

# Structure a Python project in hexagonal architecture using AWS Lambda

Created by Furkan Oruc (AWS), Dominik Goby (AWS), Darius Kuncce (AWS), and Michal Ploski (AWS)

**Environment:** PoC or pilot

**Technologies:** DevelopmentAndTesting; CloudNative; Containers & microservices; Serverless; Modernization

**AWS services:** Amazon DynamoDB; AWS Lambda; Amazon API Gateway

## Summary

This pattern shows how to structure a Python project in hexagonal architecture by using AWS Lambda. The pattern uses the AWS Cloud Development Kit (AWS CDK) as the infrastructure as code (IaC) tool, Amazon API Gateway as the REST API, and Amazon DynamoDB as the persistence layer. Hexagonal architecture follows domain-driven design principles. In hexagonal architecture, software consists of three components: domain, ports, and adapters. For detailed information about hexagonal architectures and their benefits, see the guide [Building hexagonal architectures on AWS](#).

## Prerequisites and limitations

### Prerequisites

- An active AWS account
- Experience in Python
- Familiarity with AWS Lambda, AWS CDK, Amazon API Gateway, and DynamoDB
- A GitHub account (see [instructions for signing up](#))
- Git (see [installation instructions](#))
- A code editor for making changes and pushing your code to GitHub (for example, [AWS Cloud9](#), [Visual Studio Code](#), or [JetBrains PyCharm](#))
- Docker installed, and the Docker daemon up and running

### Product versions

- Git version 2.24.3 or later
- Python version 3.7 or later
- AWS CDK v2
- Poetry version 1.1.13 or later
- AWS Lambda Powertools for Python version 1.25.6 or later
- pytest version 7.1.1 or later
- Moto version 3.1.9 or later
- pydantic version 1.9.0 or later
- Boto3 version 1.22.4 or later
- mypy-boto3-dynamodb version 1.24.0 or later

## Architecture

### Target technology stack

The target technology stack consists of a Python service that uses API Gateway, Lambda, and DynamoDB. The service uses a DynamoDB adapter to persist data. It provides a function that uses Lambda as the entry point. The service uses Amazon API Gateway to expose a REST API. The API uses AWS Identity and Access Management (IAM) for the [authentication of clients](#).

### Target architecture

To illustrate the implementation, this pattern deploys a serverless target architecture. Clients can send requests to an API Gateway endpoint. API Gateway forwards the request to the target Lambda function that implements the hexagonal architecture pattern. The Lambda function performs create, read, update, and delete (CRUD) operations on a DynamoDB table.

**Important:** This pattern was tested in a PoC environment. You must conduct a security review to identify the threat model and create a secure code base before you deploy any architecture to a production environment.



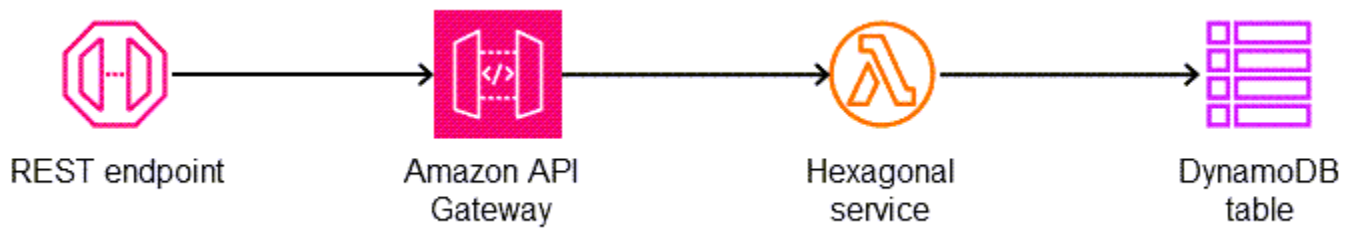

The API supports five operations on a product entity:

- GET `/products` returns all products.
- POST `/products` creates a new product.
- GET `/products/{id}` returns a specific product.
- PUT `/products/{id}` updates a specific product.
- DELETE `/products/{id}` deletes a specific product.

You can use the following folder structure to organize your project to follow the hexagonal architecture pattern:

```

app/ # application code
|--- adapters/ # implementation of the ports defined in the domain
|   |--- tests/ # adapter unit tests
|--- endpoints/ # primary adapters, entry points
|   |--- api/ # api entry point
|       |--- model/ # api model
|       |--- tests/ # end to end api tests
|--- domain/ # domain to implement business logic using hexagonal architecture
|   |--- command_handlers/ # handlers used to execute commands on the domain
|   |--- commands/ # commands on the domain
|   |--- events/ # events triggered via the domain
|   |--- exceptions/ # exceptions defined on the domain
|   |--- model/ # domain model
|   |--- ports/ # abstractions used for external communication
|   |--- tests/ # domain tests
|--- libraries/ # List of 3rd party libraries used by the Lambda function
infra/ # infrastructure code
simple-crud-app.py # AWS CDK v2 app
  
```

## Tools

### AWS services

- [Amazon API Gateway](#) is a fully managed service that makes it easy for developers to create, publish, maintain, monitor, and secure APIs at any scale.
- [Amazon DynamoDB](#) is a fully managed, serverless, key-value NoSQL database that is designed to run high-performance applications at any scale.
- [AWS Lambda](#) is a serverless, event-driven compute service that lets you run code for virtually any type of application or backend service without provisioning or managing servers. You can launch Lambda functions from over 200 AWS services and software as a service (SaaS) applications, and only pay for what you use.

### Tools

- [Git](#) is used as the version control system for code development in this pattern.
- [Python](#) is used as the programming language for this pattern. Python provides high-level data structures and an approach to object-oriented programming. AWS Lambda provides a built-in Python runtime that simplifies the operation of Python services.
- [Visual Studio Code](#) is used as the IDE for development and testing for this pattern. You can use any IDE that supports Python development (for example, [AWS Cloud9](#) or [PyCharm](#)).
- [AWS Cloud Development Kit \(AWS CDK\)](#) is an open-source software development framework that lets you define your cloud application resources by using familiar programming languages. This pattern uses the CDK to write and deploy cloud infrastructure as code.
- [Poetry](#) is used to manage dependencies in the pattern.
- [Docker](#) is used by the AWS CDK to build the Lambda package and layer.

### Code

The code for this pattern is available in the GitHub [Lambda hexagonal architecture sample](#) repository.

## Best practices

To use this pattern in a production environment, follow these best practices:

- Use customer managed keys in AWS Key Management Service (AWS KMS) to encrypt [Amazon CloudWatch log groups](#) and [Amazon DynamoDB tables](#).
- Configure [AWS WAF for Amazon API Gateway](#) to allow access only from your organization's network.
- Consider other options for API Gateway authorization if IAM doesn't meet your needs. For example, you can use [Amazon Cognito user pools](#) or [API Gateway Lambda authorizers](#).
- Use [DynamoDB backups](#).
- Configure Lambda functions with a [virtual private cloud \(VPC\) deployment](#) to keep network traffic inside the cloud.
- Update the allowed origin configuration for [cross-origin resource sharing \(CORS\) preflight](#) to restrict access to the requesting origin domain only.
- Use [cdk-nag](#) to check the AWS CDK code for security best practices.
- Consider using code scanning tools to find common security issues in the code. For example, [Bandit](#) is a tool that's designed to find common security issues in Python code. [Pip-audit](#) scans Python environments for packages that have known vulnerabilities.

This pattern uses [AWS X-Ray](#) to trace requests through the application's entry point, domain, and adapters. AWS X-Ray helps developers identify bottlenecks and determine high latencies to improve application performance.

## Epics

### Initialize the project

Task	Description	Skills required
Create your own repository.	<ol style="list-style-type: none"> <li>1. Log in to GitHub.</li> <li>2. Create a new repository. For instructions, see the <a href="#">GitHub documentation</a>.</li> <li>3. Clone and push the <a href="#">sample repository</a> for this pattern into the new repository in your account.</li> </ol>	App developer

Task	Description	Skills required
Install dependencies.	<ol style="list-style-type: none"><li data-bbox="591 226 1027 264">1. Install Poetry. <pre data-bbox="634 300 1027 373">pip install poetry</pre></li><li data-bbox="591 394 1027 905">2. Install packages from the root directory. The following command installs the application and AWS CDK packages. It also installs development packages that are required for running unit tests. All installed packages are placed in a new virtual environment. <pre data-bbox="634 947 1027 1020">poetry install</pre></li><li data-bbox="591 1041 1027 1220">3. To see a graphical representation of the installed packages, run the following command. <pre data-bbox="634 1262 1027 1335">poetry show --tree</pre></li><li data-bbox="591 1356 1027 1394">4. Update all dependencies. <pre data-bbox="634 1430 1027 1503">poetry update</pre></li><li data-bbox="591 1524 1027 1745">5. Open a new shell within the newly created virtual environment. It contains all installed dependencies. <pre data-bbox="634 1787 1027 1860">poetry shell</pre></li></ol>	App developer

Task	Description	Skills required
Configure your IDE.	<p>We recommend Visual Studio Code, but you can use any IDE of your choice that supports Python. The following steps are for Visual Studio Code.</p> <ol style="list-style-type: none"><li>1. Update the <code>.vscode/settings</code> file.</li></ol> <pre data-bbox="630 617 1029 1493">{   "python.testing.pytestArgs": [     "app/adapters/tests",     "app/entrypoints/api/tests",     "app/domain/tests"   ],   "python.testing.unittestEnabled": false,   "python.testing.pytestEnabled": true,   "python.envFile": "\${workspaceFolder}/.env", }</pre> <ol style="list-style-type: none"><li>2. Create an <code>.env</code> file in the root directory of the project. This ensures that the root directory of the project is included in the <code>PYTHONPATH</code> so that <code>pytest</code> can find it</li></ol>	App developer

Task	Description	Skills required
	<p>and properly discover all packages.</p> <pre>PYTHONPATH=.</pre>	
Run unit tests, option 1: Use Visual Studio Code.	<ol style="list-style-type: none"> <li>1. Choose the Python interpreter of the virtual environment that's managed by Poetry.</li> <li>2. Run tests from Test Explorer.</li> </ol>	App developer
Run unit tests, option 2: Use shell commands.	<ol style="list-style-type: none"> <li>1. Start a new shell within the virtual environment. <pre>poetry shell</pre> </li> <li>2. Run the pytest command from the root directory. <pre>python -m pytest</pre> <p>Alternatively you can run the command directly from Poetry.</p> <pre>poetry run python -m pytest</pre> </li> </ol>	App developer

## Deploy and test the application

Task	Description	Skills required
Request temporary credentials.	To have AWS credentials on the shell when you run cdk	App developer, AWS DevOps

Task	Description	Skills required
	<p>deploy, create temporary credentials by using AWS IAM Identity Center (successor to AWS Single Sign-On). For instructions, see the blog post <a href="#">How to retrieve short-term credentials for CLI use with AWS IAM Identity Center</a>.</p>	
Deploy the application.	<ol style="list-style-type: none"><li>1. Install the AWS CDK v2. <pre>npm install -g aws-cdk</pre><p>For more information, see the <a href="#">AWS CDK documentation</a>.</p></li><li>2. Bootstrap the AWS CDK into your account and Region. <pre>cdk bootstrap aws://12345678900/ us-east-1 --profile aws-profile-name</pre></li><li>3. Deploy the application as an AWS CloudFormation stack by using an AWS profile. <pre>cdk deploy --profile aws-profile-name</pre></li></ol>	App developer, AWS DevOps

Task	Description	Skills required
Test the API, option 1: Use the console.	Use the <a href="#">API Gateway console</a> to test the API. For more information about API operations and request/response messages, see the <a href="#">API usage section of the readme file</a> in the GitHub repository.	App developer, AWS DevOps
Test the API, option 2: Use Postman.	<p>If you want to use a tool such as <a href="#">Postman</a>:</p> <ol style="list-style-type: none"><li>1. <a href="#">Install Postman</a> as a standalone application or browser extension.</li><li>2. Copy the endpoint URL for the API Gateway. It will be in the following format.</li></ol> <div data-bbox="630 1087 1029 1289" style="border: 1px solid #ccc; border-radius: 10px; padding: 10px; background-color: #f9f9f9;"><pre>https://{api-id}.execute-api.{region}.amazonaws.com/{stage}/{path}</pre></div> <ol style="list-style-type: none"><li>3. Configure the AWS signature in the authorization tab. For instructions, see the AWS re:Post article on <a href="#">activating IAM authentication for API Gateway REST APIs</a>.</li><li>4. Use Postman to send requests to your API endpoint.</li></ol>	App developer, AWS DevOps



## Develop the service

Task	Description	Skills required
Write unit tests for the business domain.	<ol style="list-style-type: none"><li>1. Create a Python file in the app/domain/tests folder by using the test_ file name prefix.</li><li>2. Create a new test method to test the new business logic by using the following example.</li></ol> <pre data-bbox="630 743 1029 1818">def test_create_product_should_store_in_repository():     # Arrange     command =         create_product_command.CreateProductCommand(             name="Test Product",             description="Test Description",         )     # Act     create_product_command_handler.handle_create_product_command(         command=command, unit_of_work=mock_unit_of_work     )     # Assert</pre>	App developer

Task	Description	Skills required
	<ol style="list-style-type: none"><li>3. Create a command class in the <code>app/domain/commands</code> folder.</li><li>4. If the functionality is new, create a stub for the command handler in the <code>app/domain/command_handlers</code> folder.</li><li>5. Run the unit test to see it fail, because there is still no business logic.</li></ol> <pre data-bbox="630 779 1029 863">python -m pytest</pre>	

Task	Description	Skills required
Implement commands and command handlers.	<ol style="list-style-type: none"><li>1. Implement business logic in the newly created command handler file.</li><li>2. For every dependency that interacts with external systems, declare an abstract class in the app/domain/ports folder.</li></ol> <pre data-bbox="634 688 1029 1837">class ProductsRepository(ABC):     @abstractmethod     def add(self,             product: product.Product) -&gt; None:         ...  class UnitOfWork(ABC):     products: ProductsRepository      @abstractmethod     def commit(self)     -&gt; None:         ...      @abstractmethod     def __enter__( self) -&gt; typing.Any:         ...      @abstractmethod     def __exit__( self, *args) -&gt; None:         ...</pre>	App developer

Task	Description	Skills required
	<p>3. Update the command handler signature to accept the newly declared dependencies by using the abstract port class as type annotation.</p> <pre data-bbox="634 520 1029 995">def handle_create_product_command(     command: create_product_command.CreateProductCommand,     unit_of_work: unit_of_work.UnitOfWork, ) -&gt; str:     ...</pre> <p>4. Update the unit test to simulate the behavior of all declared dependencies for the command handler.</p> <pre data-bbox="634 1230 1029 1877"># Arrange mock_unit_of_work = unittest.mock.create_autospec(     spec=unit_of_work.UnitOfWork, instance=True ) mock_unit_of_work.products = unittest.mock.create_autospec(     spec=unit_of_work.ProductsRepository, instance=True</pre>	

Task	Description	Skills required
	<p data-bbox="630 205 1029 268">)</p> <p data-bbox="591 281 1013 457">5. Update the assertion logic in the test to check for the expected dependency invocations.</p> <pre data-bbox="630 499 1029 1251"># Assert mock_unit _of_work.commit.assert_called_once() product = mock_unit_of_work.products.add.call_args.args[0]  assertpy.assert_that(product.name).is_equal_to("Test Product") assertpy.assert_that(product.description).is_equal_to("Test Description")</pre> <p data-bbox="591 1268 1013 1352">6. Run the unit test to see it succeed.</p> <pre data-bbox="630 1394 1029 1465">python -m pytest</pre>	

Task	Description	Skills required
Write integration tests for secondary adapters.	<ol style="list-style-type: none"><li>1. Create a test file in the <code>app/adapters/tests</code> folder by using <code>test_</code> as a file name prefix.</li><li>2. Use the Moto library to mock AWS services. <pre data-bbox="634 548 1029 905">@pytest.fixture def mock_dynamodb():     with moto.mock_dynamodb():         yield boto3.resource("dynamodb",                                region_name="eu-central-1")</pre></li><li>3. Create a new test method for an integration test of the adapter. <pre data-bbox="634 1087 1029 1816">def test_add_and_commit_should_store_product(mock_dynamodb):     # Arrange     unit_of_work = dynamodb_unit_of_work.DynamoDBUnitOfWork(         table_name=TEST_TABLE_NAME,         dynamodb_client=mock_dynamodb.meta.client     )     current_time = datetime.datetime.now(datetime.timezone</pre></li></ol>	App developer

Task	Description	Skills required
	<pre> one.utc).isoformat ()          new_product_id =         str(uuid.uuid4())         new_product =         product.Product(             id=new_pr         oduct_id,             name="test-         name",             descripti         on="test-descripti         on",             createDat         e=current_time,             lastUpdat         eDate=current_time,         )          # Act         with unit_of_w         ork:             unit_of_w         ork.products.add(n         ew_product)             unit_of_w         ork.commit()          # Assert </pre> <p>4. Create an adapter class in the app/adapters folder. Use the abstract class from the ports folder as a base class.</p> <p>5. Run the unit test to see it fail, because there is still no logic.</p>	

Task	Description	Skills required
	<pre>python -m pytest</pre>	



Task	Description	Skills required
Implement secondary adapters.	<ol style="list-style-type: none"><li>1. Implement logic in the newly created adapter file.</li><li>2. Update test assertions.</li></ol> <pre data-bbox="634 405 1029 1717"># Assert     with unit_of_work_readonly:         product_from_db = unit_of_work_readonly.products.get(new_product_id)          assertpy.assert_that(product_from_db).is_not_none()         assertpy.assert_that(product_from_db.dict()).is_equal_to(             {                 "id": new_product_id,                 "name": "test-name",                 "description": "test-description",                 "createDate": current_time,                 "lastUpdateDate": current_time,             }         )</pre> <ol style="list-style-type: none"><li>3. Run the unit test to see it succeed.</li></ol>	App developer

Task	Description	Skills required
	<pre>python -m pytest</pre>	

Task	Description	Skills required
Write end-to-end tests.	<ol style="list-style-type: none"><li data-bbox="592 226 1027 457">1. Create a test file in the <code>app/entrypoints/api/tests</code> folder by using <code>test_</code> as a file name prefix.</li><li data-bbox="592 478 1027 604">2. Create a Lambda context fixture that will be used by the test to call Lambda. <pre data-bbox="646 646 1027 1591">@pytest.fixture def lambda_context():     @dataclass     class LambdaContext:         text: str         function_name: str = "test"         memory_limit_in_mb: int = 128         invoked_function_arn: str = "arn:aws:lambda:eu-west-1:809313241:function:test"         aws_request_id: str = "52fdcf07-2182-154f-163f-5f0f9a621d72"      return LambdaContext()  def test_create_product(lambda_context):</pre></li><li data-bbox="592 1612 1027 1696">3. Create a test method for the API invocation. <pre data-bbox="646 1738 1027 1864">def test_create_product(lambda_context):</pre></li></ol>	App developer

Task	Description	Skills required
	<pre> # Arrange name = "TestName" description = "Test description" request = api_model.CreatePr oductRequest(name= name, descripti on=description)  minimal_event = api_gateway_proxy_ event.APIGatewayPr oxyEvent(     {         "path": "/" products",         "httpMeth od": "POST",         "requestC ontext": { # correlation ID          "requestId": "c6af9ac6-7b61-11e 6-9a41-93e8deadbee f"     },     "body": json.dumps(request .dict()),     } )  create_pr oduct_func_mock = unittest.mock.crea te_autospec(     spec=crea te_product_command _handler.handle_cr </pre>	

Task	Description	Skills required
	<pre>    create_product_command     )     handler.c create_product_command_handler.handle _create_product_command = (     create_product_func_mock )  # Act handler.handle_event(minimal_event, lambda_context)</pre> <p>4. Run the unit test to see it fail, because there is still no logic.</p> <pre>python -m pytest</pre>	

Task	Description	Skills required
Implement primary adapters.	<p>1. Create a function for API business logic and declare it as an API resource.</p> <pre data-bbox="634 394 1029 1150"> @tracer.capture_method @app.post("/products") @utils.parse_event(model=api_model.CreateProductRequest, app_context=app) def create_product(     request: api_model.CreateProductRequest, ) -&gt; api_model.CreateProductResponse:     """Creates a product."""     ... </pre> <p><b>Note:</b> All decorators you see are features of the AWS Lambda Powertools for Python library. For details, see the <a href="#">AWS Lambda Powertools for Python website</a>.</p> <p>2. Implement the API logic.</p> <pre data-bbox="634 1604 1029 1854"> id=create_product_command_handler.handle_create_product_command(     command=create_product_comm </pre>	App developer

Task	Description	Skills required
	<pre>and.CreateProductC ommand(     name=request.name,     description=request.description,     unit_of_work=unit_of_work, ) response = api_model.CreatePr oductResponse(id=i d) return response. dict()</pre> <p>3. Run the unit test to see it succeed.</p> <pre>python -m pytest</pre>	

## Related resources

### APG guide

- [Building hexagonal architectures on AWS](#)

### AWS References

- [AWS Lambda documentation](#)
- [AWS CDK documentation](#)
  - [Your first AWS CDK app](#)
- [API Gateway documentation](#)
  - [Control access to an API with IAM permissions](#)

- [Use the API Gateway console to test a REST API method](#)
- [Amazon DynamoDB documentation](#)

## Tools

- [git-scm.com website](#)
- [Installing Git](#)
- [Creating a new GitHub repository](#)
- [Python website](#)
- [AWS Lambda Powertools for Python](#)
- [Postman website](#)
- [Python mock object library](#)
- [Poetry website](#)

## IDEs

- [Visual Studio Code website](#)
- [AWS Cloud9 documentation](#)
- [PyCharm website](#)



## More patterns

- [Automate stack set deployment by using AWS CodePipeline and AWS CodeBuild](#)
- [Automatically attach an AWS managed policy for Systems Manager to EC2 instance profiles using Cloud Custodian and AWS CDK](#)
- [Chain AWS services together using a serverless approach](#)
- [Convert VARCHAR2\(1\) data type for Oracle to Boolean data type for Amazon Aurora PostgreSQL](#)
- [Deploy a clustered application to Amazon ECS by using AWS Copilot](#)
- [Deploy CloudWatch Synthetics canaries by using Terraform](#)
- [Deploy Lambda functions with container images](#)
- [Generate a static outbound IP address using a Lambda function, Amazon VPC, and a serverless architecture](#)
- [Generate test data using an AWS Glue job and Python](#)
- [Implement a Gitflow branching strategy for multi-account DevOps environments](#)
- [Implement a GitHub Flow branching strategy for multi-account DevOps environments](#)
- [Implement a Trunk branching strategy for multi-account DevOps environments](#)
- [Modernize ASP.NET Web Forms applications on AWS](#)
- [Run unit tests for Python ETL jobs in AWS Glue using the pytest framework](#)
- [Transfer large-scale Db2 z/OS data to Amazon S3 in CSV files](#)
- [Validate Account Factory for Terraform \(AFT\) code locally](#)

# End-user computing

## Topics

- [Automate the creation of AppStream 2.0 resources using AWS CloudFormation](#)
- [More patterns](#)

# Automate the creation of AppStream 2.0 resources using AWS CloudFormation

Created by Ram Kandaswamy (AWS)

**Environment:** Production

**Technologies:** End-user computing; CloudNative; Cost management; DevOps; SaaS

**Workload:** Microsoft

**AWS services:** Amazon AppStream 2.0; AWS CloudFormation

## Summary

This pattern provides code samples and steps to automate the creation of Amazon AppStream 2.0 resources in the Amazon Web Services (AWS) Cloud by using an AWS CloudFormation template. The pattern shows you how to use an AWS CloudFormation stack to automate the creation of your AppStream 2.0 application resources, including an image builder, image, fleet instance, and stack. You can stream your AppStream 2.0 application to end users on an HTML5-compliant browser by using either the desktop or application delivery mode.

## Prerequisites and limitations

### Prerequisites

- An active AWS account
- An acceptance of AppStream 2.0 terms and conditions
- Basic knowledge of AppStream resources, such as [stacks](#), [fleets](#), and [image builders](#)

### Limitations

- You can't modify the AWS Identity and Access Management (IAM) role associated with an AppStream 2.0 instance after that instance is created.

- You can't modify properties (such as the subnet or security group) on the AppStream 2.0 image builder instance after that image builder is created.

## Architecture

The following diagram shows you how to automate the creation of AppStream 2.0 resources by using an AWS CloudFormation template.

The diagram shows the following workflow:

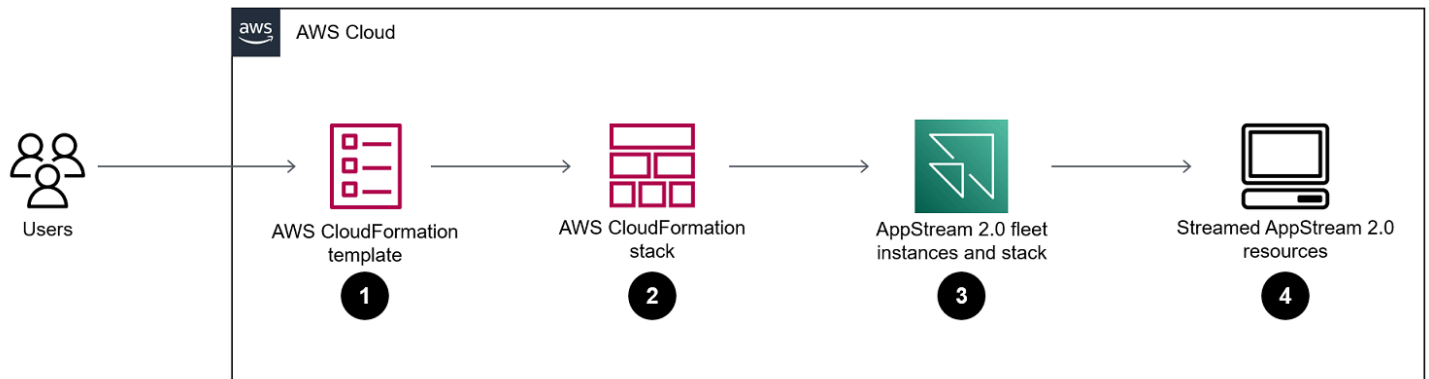

1. You create an AWS CloudFormation template based on the YAML code in the *Additional information* section of this pattern.
2. The AWS CloudFormation template creates an AWS CloudFormation test stack.
  - a. (Optional) You create an image builder instance by using AppStream 2.0.
  - b. (Optional) You create a Windows image by using your custom software.
3. The AWS CloudFormation stack creates an AppStream 2.0 fleet instance and stack.
4. You deploy your AppStream 2.0 resources to end users on an HTML5-compliant browser.

### Technology stack

- Amazon AppStream 2.0
- AWS CloudFormation

## Tools

- [Amazon AppStream 2.0](#) is a fully managed application streaming service that provides you with instant access to your desktop applications from anywhere. AppStream 2.0 manages the AWS

resources required to host and run your applications, scales automatically, and provides access to your users on demand.

- [AWS CloudFormation](#) helps you model and set up your AWS resources, provision them quickly and consistently, and manage them throughout their lifecycle. You can use a template to describe your resources and their dependencies, and launch and configure them together as a stack, instead of managing resources individually. You can manage and provision stacks across multiple AWS accounts and AWS Regions.

## Epics

### (Optional) Create an AppStream 2.0 image

Task	Description	Skills required
Install custom software and create an image.	<ol style="list-style-type: none"> <li>1. Install the AppStream 2.0 application that you plan to deploy to your users.</li> <li>2. Use the Photon create image agent or a PowerShell script to create a new Windows image for your custom software.</li> </ol> <p><b>Note:</b> Consider using the Windows AppLocker feature to further lock down the image.</p>	AWS DevOps, Cloud architect

### Deploy the AWS CloudFormation template

Task	Description	Skills required
Update the AWS CloudFormation template.	<ol style="list-style-type: none"> <li>1. Save the code in the <i>Additional information</i></li> </ol>	AWS systems administrator, Cloud administrator, Cloud

Task	Description	Skills required
	<p>section of this pattern as a YAML file.</p> <ol style="list-style-type: none"><li>2. Update the YAML file with the required values for the parameters in your environment.</li></ol>	architect, General AWS, AWS administrator
Create an AWS CloudFormation stack using the template.	<ol style="list-style-type: none"><li>1. Sign in to the AWS Management Console and open the <a href="#">AWS CloudFormation console</a>.</li><li>2. On the navigation pane, choose <b>Stacks</b>.</li><li>3. Choose <b>Create stack</b> and then choose <b>With new resources (standard)</b>.</li><li>4. In the <b>Prerequisite – Prepare template</b> section, choose <b>Template is ready</b>.</li><li>5. In the <b>Specify template</b> section, choose <b>Upload a template file</b>.</li><li>6. Choose <b>Choose file</b> and then choose your updated AWS CloudFormation template.</li><li>7. Complete the rest of the steps in the wizard to create your stack.</li></ol>	App owner, AWS systems administrator, Windows Engineer

## Related resources

### References

- [Get Started with Amazon AppStream 2.0: Set Up With Sample Applications](#)
- [Create an AppStream 2.0 Fleet and Stack](#)

## Tutorials and videos

- [Amazon AppStream 2.0 User Workflow](#)
- [How to Migrate a Legacy Windows Forms App to Amazon AppStream 2.0](#)
- [AWS re:Invent 2018: Securely Deliver Desktop Applications with Amazon AppStream 2.0 \(BAP201\)](#)

## Additional information

The following code is an example of an AWS CloudFormation template that allows you to automatically create AppStream 2.0 resources.

```
AWSTemplateFormatVersion: 2010-09-09
Parameters:
  SubnetIds:
    Type: 'List<AWS::EC2::Subnet::Id>'
  testSecurityGroup:
    Type: 'AWS::EC2::SecurityGroup::Id'
  ImageName:
    Type: String
Resources:

  AppStreamFleet:
    Type: 'AWS::AppStream::Fleet'
    Properties:
      ComputeCapacity:
        DesiredInstances: 5
      InstanceType: stream.standard.medium
      Name: appstream-test-fleet
      DisconnectTimeoutInSeconds: 1200
      FleetType: ON_DEMAND
      IdleDisconnectTimeoutInSeconds: 1200
      ImageName: !Ref ImageName
      MaxUserDurationInSeconds: 345600
      VpcConfig:
        SecurityGroupIds:
          - !Ref testSecurityGroup
```

```
    SubnetIds: !Ref SubnetIds
AppStreamStack:
  Type: 'AWS::AppStream::Stack'
  Properties:
    Description: AppStream stack for test
    DisplayName: AppStream test Stack
    Name: appstream-test-stack
    StorageConnectors:
      - ConnectorType: HOMEFOLDERS
    UserSettings:
      - Action: CLIPBOARD_COPY_FROM_LOCAL_DEVICE
        Permission: ENABLED
      - Action: CLIPBOARD_COPY_TO_LOCAL_DEVICE
        Permission: ENABLED
      - Action: FILE_DOWNLOAD
        Permission: ENABLED
      - Action: PRINTING_TO_LOCAL_DEVICE
        Permission: ENABLED
AppStreamFleetAssociation:
  Type: 'AWS::AppStream::StackFleetAssociation'
  Properties:
    FleetName: appstream-test-fleet
    StackName: appstream-test-stack
  DependsOn:
    - AppStreamFleet
    - AppStreamStack
```



## More patterns

- [Connect to an Amazon EC2 instance by using Session Manager](#)
- [Improve call quality on agent workstations in Amazon Connect contact centers](#)
- [Run AWS Systems Manager Automation tasks synchronously from AWS Step Functions](#)

# High-performance computing

## Topics

- [Deploy a Lustre file system for high-performance data processing by using Terraform and DRA](#)
- [Set up a Grafana monitoring dashboard for AWS ParallelCluster](#)
- [Set up an auto scaling virtual desktop infrastructure \(VDI\) by using NICE EnginFrame and NICE DCV Session Manager](#)

# Deploy a Lustre file system for high-performance data processing by using Terraform and DRA

Created by Arun Bagal (AWS)

**Code repository:** [provision-fsx-lustre-with-terraform](#)

**Environment:** Production

**Technologies:** High-performance computing; Storage & backup; Infrastructure

**AWS services:** Amazon CloudWatch Logs; Amazon EC2; Amazon FSx for Lustre; Amazon S3

## Summary

This pattern automatically deploys a Lustre file system on AWS and integrates it with Amazon Elastic Compute Cloud (Amazon EC2) and Amazon Simple Storage Service (Amazon S3).

This solution helps you quickly set up a high performance computing (HPC) environment with integrated storage, compute resources, and Amazon S3 data access. It combines Lustre's storage capabilities with the flexible compute options provided by Amazon EC2 and the scalable object storage in Amazon S3, so you can tackle data-intensive workloads in machine learning, HPC, and big data analytics.

The pattern uses a HashiCorp Terraform module and Amazon FSx for Lustre to streamline the following process:

- Provisioning a Lustre file system
- Establishing a data repository association (DRA) between FSx for Lustre and an S3 bucket to link the Lustre file system with Amazon S3 objects
- Creating an EC2 instance
- Mounting the Lustre file system with the Amazon S3-linked DRA on the EC2 instance

The benefits of this solution include:

- **Modular design.** You can easily maintain and update the individual components of this solution.
- **Scalability.** You can quickly deploy consistent environments across AWS accounts or Regions.
- **Flexibility.** You can customize the deployment to fit your specific needs.
- **Best practices.** This pattern uses preconfigured modules that follow AWS best practices.

For more information about Lustre file systems, see the [Lustre website](#).

## Prerequisites and limitations

### Prerequisites

- An active AWS account
- A least privilege AWS Identity and Access Management (IAM) policy (see [instructions](#))

### Limitations

FSx for Lustre limits the Lustre file system to a single Availability Zone, which could be a concern if you have high availability requirements. If the Availability Zone that contains the file system fails, access to the file system is lost until recovery. To achieve high availability, you can use DRA to link the Lustre file system with Amazon S3, and transfer data between Availability Zones.

### Product versions

- [Terraform version 1.9.3 or later](#)
- [HashiCorp AWS Provider version 4.0.0 or later](#)

## Architecture

The following diagram shows the architecture for FSx for Lustre and complementary AWS services in the AWS Cloud.

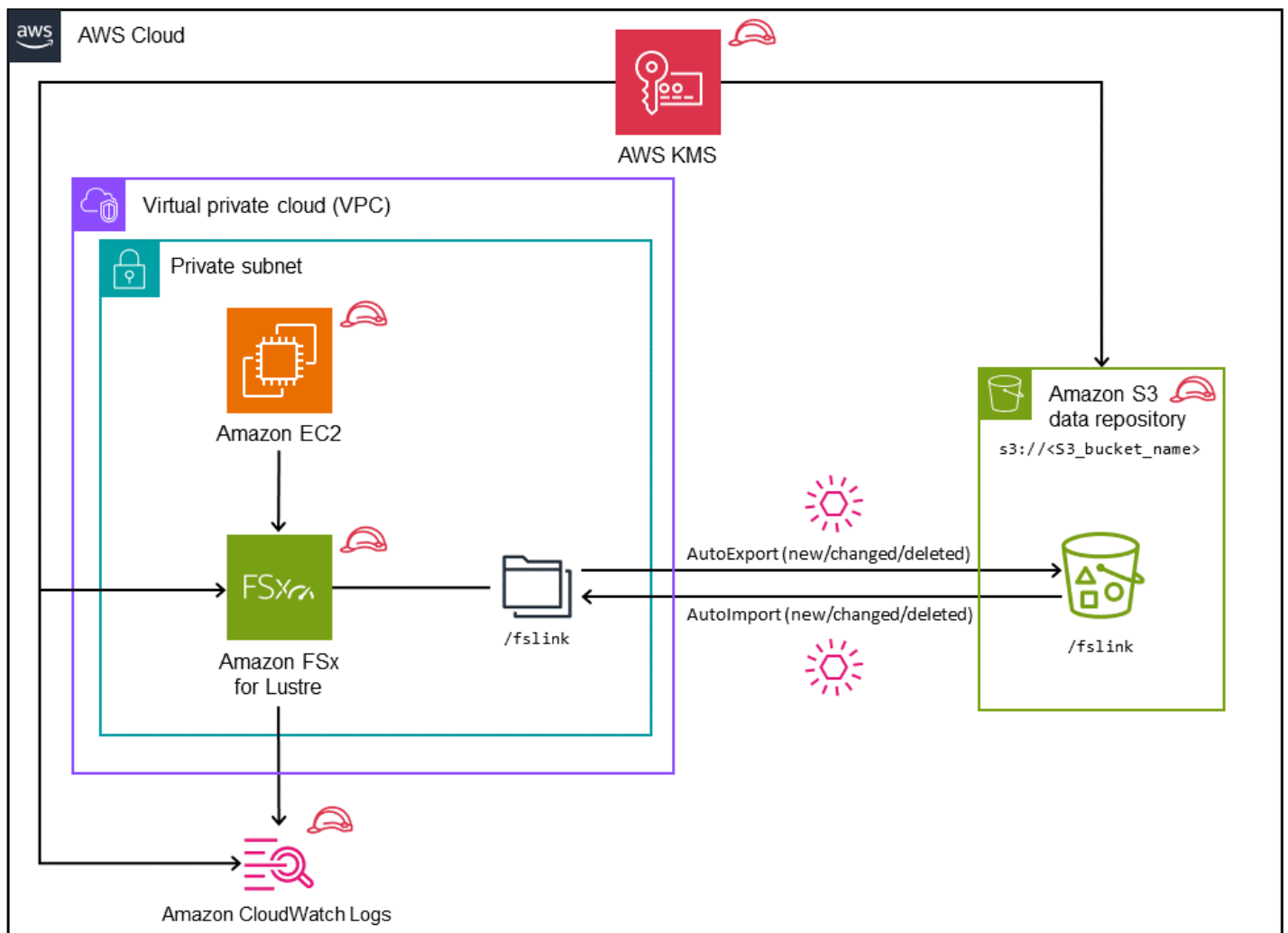

The architecture includes the following:

- An S3 bucket is used as a durable, scalable, and cost-effective storage location for data. The integration between FSx for Lustre and Amazon S3 provides a high-performance file system that is seamlessly linked with Amazon S3.
- FSx for Lustre runs and manages the Lustre file system.
- Amazon CloudWatch Logs collects and monitors log data from the file system. These logs provide insights into the performance, health, and activity of your Lustre file system.
- Amazon EC2 is used to access Lustre file systems by using the open source Lustre client. EC2 instances can access file systems from other Availability Zones within the same virtual private cloud (VPC). The networking configuration allows for access across subnets within the VPC. After the Lustre file system is mounted on the instance, you can work with its files and directories just as you would use a local file system.

- [AWS Key Management Service \(AWS KMS\)](#) enhances the security of the file system by providing encryption for data at rest.

## Automation and scale

Terraform makes it easier to deploy, manage, and scale your Lustre file systems across multiple environments. In FSx for Lustre, a single file system has size limitations, so you might need to horizontally scale by creating multiple file systems. You can use Terraform to provision multiple Lustre file systems based on your workload needs.

## Tools

### AWS services

- [Amazon CloudWatch Logs](#) helps you centralize the logs from all your systems, applications, and AWS services so you can monitor them and archive them securely.
- [Amazon Elastic Compute Cloud \(Amazon EC2\)](#) provides scalable computing capacity in the AWS Cloud. You can launch as many virtual servers as you need and quickly scale them up or down.
- [Amazon FSx for Lustre](#) makes it easy and cost-effective to launch, run, and scale a high-performance Lustre file system.
- [AWS Key Management Service \(AWS KMS\)](#) helps you create and control cryptographic keys to help protect your data.
- [Amazon Simple Storage Service \(Amazon S3\)](#) is a cloud-based object storage service that helps you store, protect, and retrieve any amount of data.

### Code repository

The code for this pattern is available in the GitHub [Provision FSx for Lustre Filesystem using Terraform](#) repository.

## Best practices

- The following variables define the Lustre file system. Make sure to configure these correctly based on your environment, as instructed in the [Epics](#) section.
  - `storage_capacity` – The storage capacity of the Lustre file system, in GiBs. The minimum and default setting is 1200 GiB.

- `deployment_type` – The deployment type for the Lustre file system. For an explanation of the two options, `PERSISTENT_1` and `PERSISTENT_2` (default), see the [FSx for Lustre documentation](#).
- `per_unit_storage_throughput` – The read and write throughput, in MBs per second per TiB.
- `subnet_id` – The ID of the private subnet where you want to deploy FSx for Lustre.
- `vpc_id` – The ID of your virtual private cloud on AWS where you want to deploy FSx for Lustre.
- `data_repository_path` – The path to the S3 bucket that will be linked to the Lustre file system.
- `iam_instance_profile` – The IAM instance profile to use to launch the EC2 instance.
- `kms_key_id` – The Amazon Resource Name (ARN) of the AWS KMS key that will be used for data encryption.
- Ensure proper network access and placement within the VPC by using the `security_group` and `vpc_id` variables.
- Run the `terraform plan` command as described in the [Epics](#) section to preview and verify changes before applying them. This helps catch potential issues and ensures that you are aware of what will be deployed.
- Use the `terraform validate` command as described in the [Epics](#) section to check for syntax errors and to confirm that your configuration is correct.

## Epics

### Set up your environment

Task	Description	Skills required
Install Terraform.	To install Terraform on your local machine, follow the instructions in the <a href="#">Terraform documentation</a> .	AWS DevOps, DevOps engineer
Set up AWS credentials.	To set up the AWS Command Line Interface (AWS CLI) profile for the account, follow	AWS DevOps, DevOps engineer

Task	Description	Skills required
	the instructions in the <a href="#">AWS documentation</a> .	
Clone the GitHub repository.	<p>To clone the GitHub repository, run the command:</p> <pre>git clone https://github.com/aws-samples/provision-fsx-lustre-with-terraform.git</pre>	AWS DevOps, DevOps engineer

## Configure and deploy FSx for Lustre

Task	Description	Skills required
Update the deployment configuration.	<ol style="list-style-type: none"> <li>In the cloned repository on your local machine, navigate to the <code>fsx_deployment</code> directory: <pre>cd fsx_deployment</pre> </li> <li>Open the terraform <code>.tfvars</code> file, and update the values of the following variables: <ul style="list-style-type: none"> <li><code>vpc_id</code></li> <li><code>subnet_id</code></li> <li><code>data_repository_path</code></li> <li><code>iam_instance_profile</code></li> </ul> </li> </ol>	AWS DevOps, DevOps engineer



Task	Description	Skills required
	<ul style="list-style-type: none"> <li>• kms_key_id</li> </ul> <p>For descriptions of these variables, see the <a href="#">Best practices</a> section.</p> <p>3. In the same directory, open the <code>locals.tf</code> file and update the CIDR ranges for the <code>fsx_inress</code> and <code>fsx_egress</code> security group variables.</p> <p>4. If needed, open the <code>variables.tf</code> file and update the default values of these variables:</p> <ul style="list-style-type: none"> <li>• storage_capacity</li> <li>• deployment_type</li> <li>• per_unit_storage_t hroughput</li> </ul> <p>For descriptions of these variables, see the <a href="#">Best practices</a> section.</p>	
Initialize the Terraform environment.	<p>To initialize your environment to run the Terraform <code>fsx_deployment</code> module, run:</p> <pre>terraform init</pre>	AWS DevOps, DevOps engineer

Task	Description	Skills required
Validate the Terraform syntax.	To check for syntax errors and to confirm that your configuration is correct, run: <pre>terraform validate</pre>	AWS DevOps, DevOps engineer
Validate the Terraform configuration.	To create a Terraform execution plan and preview the deployment, run: <pre>terraform plan -var-file terraform.tfvars</pre>	AWS DevOps, DevOps engineer
Deploy the Terraform module.	To deploy the FSx for Lustre resources, run: <pre>terraform apply -var-file terraform.tfvars</pre>	AWS DevOps, DevOps engineer

## Clean up AWS resources

Task	Description	Skills required
Remove AWS resources.	After you finish using your FSx for Lustre environment, you can remove the AWS resources deployed by Terraform to avoid incurring unnecessary charges. The Terraform module provided in the code repository automates this cleanup.	AWS DevOps, DevOps engineer

Task	Description	Skills required
	<p>1. In your local repository, navigate to the <code>fsx_deployment</code> directory:</p> <pre>cd fsx_deployment</pre> <p>2. Run the command:</p> <pre>terraform destroy - var-file terraform .tfvars</pre>	

## Troubleshooting

Issue	Solution
FSx for Lustre returns errors.	For help with FSx for Lustre issues, see <a href="#">Troubleshooting Amazon FSx for Lustre</a> in the FSx for Lustre documentation.

## Related resources

- [Building Amazon FSx for Lustre by using Terraform](#) (AWS Provider reference in the Terraform documentation)
- [Getting started with Amazon FSx for Lustre](#) (FSx for Lustre documentation)

# Set up a Grafana monitoring dashboard for AWS ParallelCluster

Created by Dario La Porta (AWS) and William Lu (AWS)

<b>Code repository:</b> <a href="#">parallecluster-monitoring-dashboard</a>	<b>Environment:</b> PoC or pilot	<b>Technologies:</b> High-performance computing; Analytics ; Management & governance
<b>Workload:</b> Open-source	<b>AWS services:</b> AWS ParallelCluster	

## Summary

AWS ParallelCluster helps you deploy and manage high performance computing (HPC) clusters. It supports AWS Batch and Slurm open source job schedulers. Although AWS ParallelCluster is integrated with Amazon CloudWatch for logging and metrics, it doesn't provide a monitoring dashboard for the workload.

The [Grafana dashboard for AWS ParallelCluster](#) (GitHub) is a monitoring dashboard for AWS ParallelCluster. It provides job scheduler insights and detailed monitoring metrics at the operating system (OS) level. For more information about the dashboards included in this solution, see [Example Dashboards](#) in the GitHub repository. These metrics help you better understand the HPC workload and its performance. However, the dashboard code is not updated for the latest versions of AWS ParallelCluster or the open source packages that are used in solution. This pattern enhances the solution to provide the following benefits:

- Supports AWS ParallelCluster v3
- Uses the latest version of open source packages, including Prometheus, Grafana, Prometheus Slurm Exporter, and NVIDIA DCGM-Exporter
- Increases the number of CPU cores and GPUs that the Slurm jobs use
- Adds a job monitoring dashboard
- Enhances the GPU node monitoring dashboard for nodes with 4 or 8 graphics processing units (GPUs)

This version of the enhanced solution has been implemented and verified in an AWS customer's HPC production environment.

## Prerequisites and limitations

### Prerequisites

- [AWS ParallelCluster CLI](#), installed and configured.
- A supported [network configuration](#) for AWS ParallelCluster. This pattern uses the [AWS ParallelCluster using two subnets](#) configuration, which requires a public subnet, private subnet, internet gateway, and NAT gateway.
- All AWS ParallelCluster cluster nodes must have internet access. This is required so that the installation scripts can download the open source software and Docker images.
- A [key pair](#) in Amazon Elastic Compute Cloud (Amazon EC2). Resources that have this key pair have Secure Shell (SSH) access to the head node.

### Limitations

- This pattern is designed to support Ubuntu 20.04 LTS. If you're using a different version of Ubuntu or if you use Amazon Linux or CentOS, then you need to modify the scripts provided with this solution. These modifications are not included in this pattern.

### Product versions

- Ubuntu 20.04 LTS
- ParallelCluster 3.X

### Billing and cost considerations

- The solution deployed in this pattern is not covered by the free tier. Charges apply for Amazon EC2, Amazon FSx for Lustre, the NAT gateway in Amazon VPC, and Amazon Route 53.

## Architecture

### Target architecture

The following diagram shows how a user can access the monitoring dashboard for AWS ParallelCluster on the head node. The head node runs NICE DCV, Prometheus, Grafana, Prometheus Slurm Exporter, Prometheus Node Exporter, and NGINX Open Source. The compute nodes run Prometheus Node Exporter, and they also run NVIDIA DCGM-Exporter if the node contains GPUs. The head node retrieves information from the compute nodes and displays that data in the Grafana dashboard.

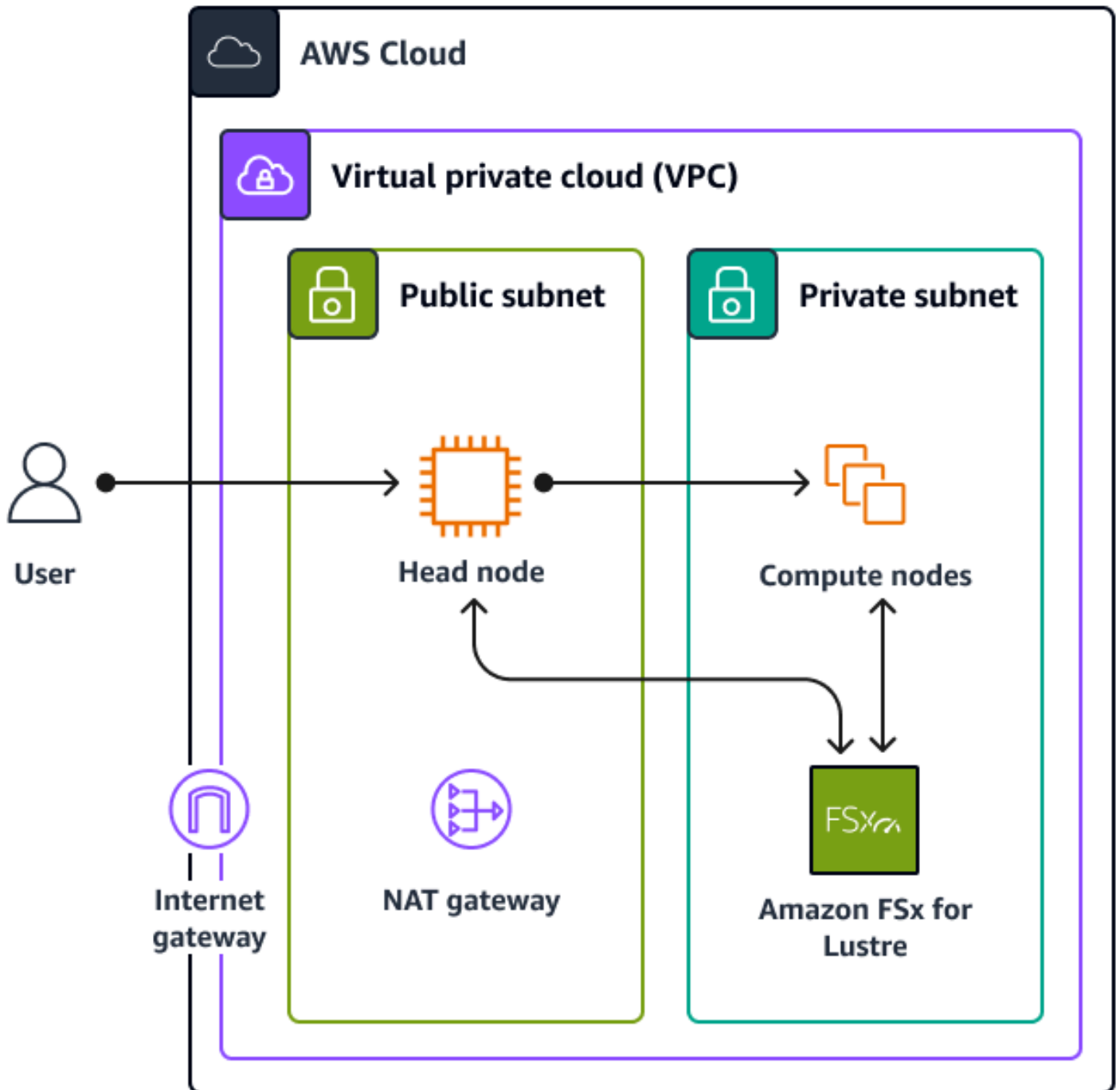

In most cases, the head node is not heavily loaded because the job scheduler doesn't require a significant amount of CPU or memory. Users access the dashboard on the head node by using SSL on port 443.

All authorized viewers can anonymously view the monitoring dashboards. Only the Grafana administrator can modify dashboards. You configure a password for the Grafana administrator in the `aws-parallelcluster-monitoring/docker-compose/docker-compose.head.yml` file.

## Tools

### AWS services

- [NICE DCV](#) is a high-performance remote display protocol that helps you deliver remote desktops and application streaming from any cloud or data center to any device, over varying network conditions.
- [AWS ParallelCluster](#) helps you deploy and manage high performance computing (HPC) clusters. It supports AWS Batch and Slurm open source job schedulers.
- [Amazon Simple Storage Service \(Amazon S3\)](#) is a cloud-based object storage service that helps you store, protect, and retrieve any amount of data.
- [Amazon Virtual Private Cloud \(Amazon VPC\)](#) helps you launch AWS resources into a virtual network that you've defined.

### Other tools

- [Docker](#) is a set of platform as a service (PaaS) products that use virtualization at the operating-system level to deliver software in containers.
- [Grafana](#) is an open source software that helps you query, visualize, alert on, and explore metrics, logs, and traces.
- [NGINX Open Source](#) is an open source web server and reverse proxy.
- [NVIDIA Data Center GPU Manager \(DCGM\)](#) is a suite of tools for managing and monitoring NVIDIA data center graphics processing units (GPUs) in cluster environments. In this pattern, you use [DCGM-Exporter](#), which helps you export GPU metrics from Prometheus.
- [Prometheus](#) is an open source system-monitoring toolkit that collects and stores its metrics as time-series data with associated key-value pairs, which are called *labels*. In this pattern, you also

use [Prometheus Slurm Exporter](#) to collect and export metrics, and you use [Prometheus Node Exporter](#) to export metrics from the compute nodes.

- [Ubuntu](#) is an open source, Linux-based operating system that is designed for enterprise servers, desktops, cloud environments, and IoT.

## Code repository

The code for this pattern is available in the GitHub [pcluster-monitoring-dashboard](#) repository.

## Epics

### Create the required resources

Task	Description	Skills required
Create an S3 bucket.	Create an Amazon S3 bucket. You use this bucket to store the configuration scripts. For instructions, see <a href="#">Creating a bucket</a> in the Amazon S3 documentation.	General AWS
Clone the repository.	Clone the GitHub <a href="#">pcluster-monitoring-dashboard</a> repo by running the following command. <div style="border: 1px solid #ccc; border-radius: 10px; padding: 10px; margin-top: 10px;"> <pre>git clone https://github.com/aws-samples/parallelcluster-monitoring-dashboard.git</pre> </div>	DevOps engineer
Create an admin password.	1. Choose the <code>aws-parallelcluster-monitoring</code> folder, choose the <code>docker-compose</code> folder,	Linux Shell scripting



Task	Description	Skills required
	<p>and then open the <b>docker-compose.head.yml</b> file.</p> <ol style="list-style-type: none"><li data-bbox="594 310 1026 730">2. In the GF_SECURITY_ADMIN_PASSWORD variable, replace Grafana4PC! with a password of your choice. This is the administrative password that you use to manage the Grafana account.</li><li data-bbox="594 751 1026 835">3. Save and close the <b>docker-compose.head.yml</b> file.</li></ol>	
Copy the required files into the S3 bucket.	Copy the <a href="#">post_install.sh</a> script and the <a href="#">aws-parallelcluster-monitoring</a> folder into the S3 bucket you created. For instructions, see <a href="#">Uploading objects</a> in the Amazon S3 documentation.	General AWS

Task	Description	Skills required
Configure an additional security group for the head node.	<ol style="list-style-type: none"><li>1. Create a security group for the head node. This security group will allow inbound traffic to the monitoring dashboards on the head node. For instructions, see <a href="#">Create a security group</a> in the Amazon VPC documentation.</li><li>2. Add an inbound rule to the security group. For instructions, see <a href="#">Add rules to a security group</a> in the Amazon VPC documentation. Use the following parameters for the rule:<ul style="list-style-type: none"><li>• <b>Type</b> – HTTPS</li><li>• <b>Protocol</b> – TCP</li><li>• <b>Port range</b> – 443</li><li>• <b>Source</b> – Enter your IP address</li><li>• <b>Description</b> – Allow users to access the monitoring dashboard</li></ul></li></ol>	AWS administrator

Task	Description	Skills required
Configure an IAM policy for the head node.	Create an identity-based policy for the head node. This policy allows the node to retrieve metric data from Amazon CloudWatch. The GitHub repo contains an example <a href="#">policy</a> . For instructions, see <a href="#">Creating IAM policies</a> in the AWS Identity and Access Management (IAM) documentation.	AWS administrator
Configure an IAM policy for the compute nodes.	Create an identity-based policy for the compute nodes. This policy allows the node to create the tags that contain the job ID and job owner. The GitHub repo contains an example <a href="#">policy</a> . For instructions, see <a href="#">Creating IAM policies</a> in the IAM documentation.  If you use the provided example file, replace the following values: <ul style="list-style-type: none"><li>• <b>&lt;REGION&gt;</b> – The AWS Region where the cluster is hosted</li><li>• <b>&lt;ACCOUNT_ID&gt;</b> – The AWS account ID</li></ul>	AWS administrator

## Create the cluster

Task	Description	Skills required
Modify the provided cluster template file.	<p>Create the AWS ParallelCluster cluster. Use the provided <a href="#">cluster.yaml</a> AWS CloudFormation template file as a starting point to create the cluster. Replace the following values in the provided template:</p> <ul style="list-style-type: none"><li>• <b>&lt;REGION&gt;</b> – The AWS Region where the cluster is hosted.</li><li>• <b>&lt;HEADNODE_SUBNET&gt;</b> – The public subnet of the VPC.</li><li>• <b>&lt;ADDITIONAL_HEAD_NODE_SG&gt;</b> – The name of the security group that you created for the head node.</li><li>• <b>&lt;KEY_NAME&gt;</b> – Enter the name of an existing Amazon EC2 key pair. Resources that have this key pair have Secure Shell (SSH) access to the head node.</li><li>• <b>&lt;ALLOWED_IPS&gt;</b> --Enter the CIDR-formatted IP address range that is allowed to make SSH connections to the head node.</li></ul>	AWS administrator

Task	Description	Skills required
	<ul style="list-style-type: none"><li>• <b>&lt;ADDITIONAL_HEAD_NODE_POLICY&gt;</b> – Enter the name of the IAM policy that you created for the head node.</li><li>• <b>&lt;BUCKET_NAME&gt;</b> – Enter the name of the S3 bucket you created.</li><li>• <b>&lt;COMPUTE_SUBNET&gt;</b> – Enter the name of the private subnet in the VPC.</li><li>• <b>&lt;ADDITIONAL_COMPUTE_NODE_POLICY&gt;</b> – Enter the name of the IAM policy that you created for the compute node.</li></ul>	
Create the cluster.	<p>In the AWS ParallelCluster CLI, enter the following command. This deploys the CloudFormation template and creates the cluster. For more information about this command, see <a href="#">pcluster create-cluster</a> in the AWS ParallelCluster documentation.</p> <pre>pcluster create-cluster -n &lt;cluster_name&gt; -c cluster.yaml</pre>	AWS administrator

Task	Description	Skills required
Monitor the cluster creation.	<p>Enter the following command to monitor the cluster creation. For more information about this command, see <a href="#">pcluster describe-cluster</a> in the AWS ParallelCluster documentation.</p> <pre data-bbox="594 583 1027 743">pcluster describe-cluster -n &lt;cluster_name&gt;</pre>	AWS administrator

## Using the Grafana dashboards

Task	Description	Skills required
Access to the Grafana portal.	<ol style="list-style-type: none"> <li data-bbox="594 1031 1027 1209">1. Enter the following command to retrieve the public IP address of the head node. <pre data-bbox="630 1247 1027 1486">pcluster describe-cluster -n &lt;cluster_name&gt; --query headNode.publicIpAddress</pre> </li> <li data-bbox="594 1503 1027 1682">2. In a web browser, navigate to the following URL in order to access the Grafana dashboard. <p data-bbox="630 1724 1027 1801"><b>https://&lt;head_node_public_ip_address&gt;</b></p> </li> </ol>	AWS administrator

Task	Description	Skills required
	<p>3. On the Grafana front page, choose the 4-square <b>Dashboard</b> icon on the left menu, and then choose <b>General</b>. This shows a list of configured dashboards. The following dashboards are available in Grafana:</p> <ul style="list-style-type: none"><li>• <b>Cluster Cost</b> – Contains information about the cost of the cluster</li><li>• <b>Cluster Logs</b> – Contains information about the logs of the cluster</li><li>• <b>Compute Node Details</b> – Contains information about usage statistics of the compute nodes</li><li>• <b>Compute Node List</b> – Contains the list of the compute nodes of the cluster</li><li>• <b>GPU Nodes</b> – Contains information about usage statistics of the GPU nodes</li><li>• <b>Jobs Details</b> – Contains information about the jobs resources utilization</li><li>• <b>Head Node Details</b> – Contains information about usage statistics of the head node</li></ul>	

Task	Description	Skills required
	<ul style="list-style-type: none"> <li>• <b>ParallelCluster Summary</b> – Contains information about cluster usage</li> </ul>	

## Clean up the solution to stop incurring associated costs

Task	Description	Skills required
Delete the cluster.	<p>Enter the following command to delete the cluster. For more information about this command, see <a href="#">pcluster delete-cluster</a> in the AWS ParallelCluster documentation.</p> <pre>pcluster delete-cluster -n &lt;cluster_name&gt;</pre>	AWS administrator
Delete the IAM policies.	<p>Delete the policies that you created for the head node and compute node. For more information about deleting policies, see <a href="#">Deleting IAM policies</a> in the IAM documentation.</p>	AWS administrator
Delete the security group and rule.	<p>Delete the security group that you created for the head node. For more information, see <a href="#">Delete security group rules</a> and <a href="#">Delete a security</a></p>	AWS administrator



Task	Description	Skills required
	<a href="#">group</a> in the Amazon VPC documentation.	
Delete the S3 bucket.	Delete the S3 bucket that you created to store the configuration scripts. For more information, see <a href="#">Deleting a bucket</a> in the Amazon S3 documentation.	General AWS

## Troubleshooting

Issue	Solution
The head node is not accessible in the browser.	Check the security group and confirm that the inbound port 443 is open.
Grafana doesn't open.	On the head node, check the container log for <code>docker logs Grafana</code> .
Some metrics have no data.	On the head node, check the container logs of all containers.

## Related resources

### AWS documentation

- [IAM policies for Amazon EC2](#)

### Other AWS resources

- [AWS ParallelCluster](#)
- [Monitoring dashboard for AWS ParallelCluster](#) (AWS blog post)

**Other resources**

- [Prometheus monitoring system](#)
- [Grafana](#)

# Set up an auto scaling virtual desktop infrastructure (VDI) by using NICE EnginFrame and NICE DCV Session Manager

Created by Dario La Porta and Salvatore Maccarone (AWS)

**Code repository:** [elastic-vdi-infrastructure](#)

**Environment:** PoC or pilot

**Technologies:** High-performance computing; Infrastructure

**AWS services:** AWS CDK; AWS CloudFormation; Amazon EC2 Auto Scaling; Elastic Load Balancing (ELB)

## Summary

*NICE DCV* is a high-performance remote display protocol that helps you stream remote desktops and applications from any cloud or data center to any device, over varying network conditions. With *NICE DCV* and Amazon Elastic Compute Cloud (Amazon EC2), you can run graphics-intensive applications remotely on EC2 instances and stream their user interfaces to simpler, remote client machines. This eliminates the need for expensive dedicated workstations and the need to transfer large amounts of data between the cloud and client machines.

This pattern sets up a fully functional, auto scaling Linux and Windows virtual desktop infrastructure (VDI) that is accessible through a web-based user interface. The VDI solution provides research and development (R&D) users with an accessible and performant user interface for submitting graphics-intensive analysis requests and reviewing results remotely.

## Prerequisites and limitations

### Prerequisites

- An active AWS account.
- Administrator permissions and a set of access keys.
- AWS Cloud Development Kit (AWS CDK) Toolkit, installed and configured. For more information, see [Install the AWS CDK](#).

- AWS Command Line Interface (AWS CLI), installed and configured for your AWS account. For more information, see [Installing or updating the latest version of the AWS CLI](#).
- Python, installed and configured. For more information, see [Source releases](#) (Python website).
- One or more virtual private clouds (VPCs) available.
- Two or more Elastic IP address available. For more information about the default limit, see [Elastic IP address limit](#).
- For the Linux EC2 instances, set up a Secure Shell (SSH) key pair. For more information, see [Key pairs and Linux instances](#).

### Product versions

- AWS CDK version 2.26.0 or later
- Python version 3.8 or later

## Architecture

### Target architecture

The following figure shows the different components of this VDI solution. The user interacts with NICE EnginFrame to launch Amazon EC2 instances according to the Amazon EC2 Auto Scaling groups for Windows and Linux NICE DCV instances.

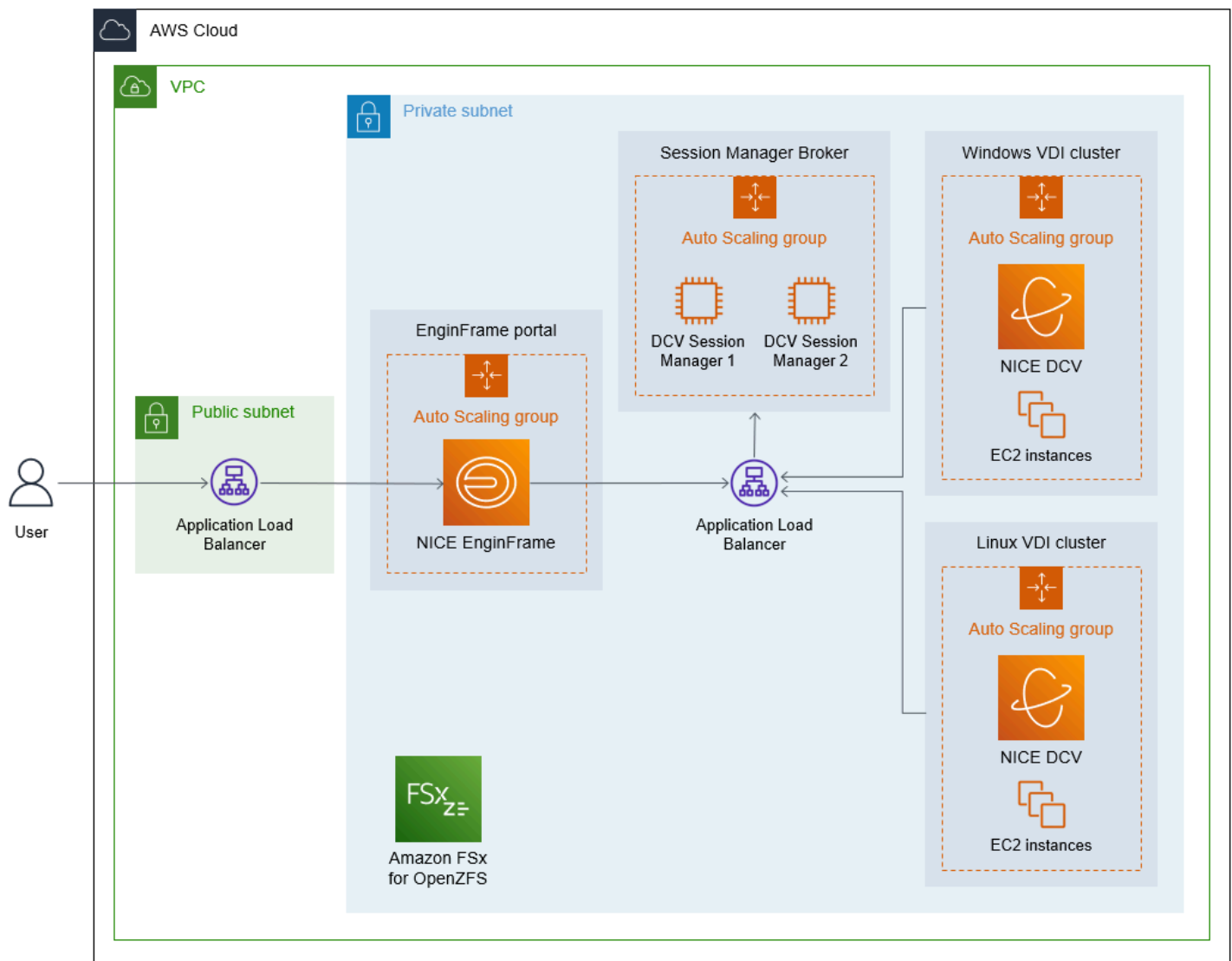

## Automation and scale

The code included with this pattern creates a custom VPC, public and private subnets, an internet gateway, NAT gateway, Application Load Balancer, security groups, and IAM policies. AWS CloudFormation is also used to create the fleet of Linux And Windows NICE DCV servers.

## Tools

### AWS services

- [AWS Cloud Development Kit \(AWS CDK\)](#) is a software development framework that helps you define and provision AWS Cloud infrastructure in code.

- [AWS CloudFormation](#) helps you set up AWS resources, provision them quickly and consistently, and manage them throughout their lifecycle across AWS accounts and Regions.
- [NICE DCV](#) is a high-performance remote display protocol that helps you deliver remote desktops and application streaming from any cloud or data center to any device, over varying network conditions. In this pattern, it provides a bandwidth-efficient experience that streams high performance computing (HPC) 3D graphics remotely.
- [NICE DCV Session Manager](#) helps you create and manage the lifecycle of NICE DCV sessions across a fleet of NICE DCV servers.
- [NICE EnginFrame](#) is an advanced frontend web interface for accessing technical and scientific applications in the cloud.

## Code repository

The code for this pattern is available in the [Auto scaling VDI solution with NICE EnginFrame and NICE DCV Session Manager](#) repository.

## Epics

### Deploy the virtual desktop infrastructure

Task	Description	Skills required
Clone the repository.	Clone the repository containing the code. <pre>git clone https://github.com/aws-samples/elastic-vdi-infrastructure.git</pre>	Cloud architect
Install the required AWS CDK libraries.	Install the AWS CDK libraries. <pre>cd elastic-vdi-infrastructure python3 -m venv .venv source .venv/bin/activate</pre>	Cloud architect

Task	Description	Skills required
	<pre data-bbox="594 205 1026 306">pip3 install -r requirements.txt</pre>	

Task	Description	Skills required
Update the parameters.	<ol style="list-style-type: none"><li>1. Open the <b>app.py</b> file in your text editor of choice.</li><li>2. Replace the CHANGE_ME value for the following required parameters:<ul style="list-style-type: none"><li>• <code>region</code> – The target AWS Region. For a complete list, see <a href="#">AWS Regions</a>.</li><li>• <code>account</code> – The ID of the target AWS account. For more information, see <a href="#">Finding your AWS account ID</a>.</li><li>• <code>key_name</code> – The key pair used to access the Linux EC2 instances.</li></ul></li><li>3. (Optional) Modify the values for the following parameters to customize the solution for your environment:<ul style="list-style-type: none"><li>• <code>ec2_type_enginframe</code> – The EnginFrame instance type</li><li>• <code>ec2_type_broker</code> – The Session Manager Broker instance type</li><li>• <code>ebs_enginframe_size</code> – The size of the Amazon Elastic Block Store (Amazon</li></ul></li></ol>	Cloud architect



Task	Description	Skills required
	<p>EBS) volume for the EnginFrame instance</p> <ul style="list-style-type: none"><li>• <code>ebs_broker_size</code> – The size of the EBS volume for the Session Manager Broker instance</li><li>• <code>TagName</code> and <code>TagValue</code> – The billing tag for the resources</li><li>• <code>efadmin_uid</code> – The unique identifier of the EnginFrame administrator (<b>efadmin</b>) user</li><li>• <code>linux_shared_storage_size</code> – OpenZFS size in gibibytes (GiB)</li><li>• <code>Shared_Storage_Linux</code> – The mount point of the shared storage</li><li>• <code>Enginframe_installer</code> – The download link for EnginFrame</li><li>• <code>Session_Manager_Broker_Installer</code> – The download link for the Session Manager Broker</li></ul> <p>4. Save and close the <b>app.py</b> file.</p>	

Task	Description	Skills required
Deploy the solution.	<p>Run the following commands in sequence.</p> <pre>cdk bootstrap cdk deploy Assets-Stack Parameters-Stack cdk deploy Elastic-Vdi-Infrastructure</pre> <p>When the deployment is complete, the following two outputs are returned:</p> <ul style="list-style-type: none"><li>• Elastic-Vdi-Infrastructure.EnginFrameURL – The HTTPS address of the EnginFrame portal</li><li>• Elastic-Vdi-Infrastructure.SecretEFadminPassword – The Amazon Resource Name (ARN) of the secret that contains the password for the <b>efadmin</b> user</li></ul> <p>Make note of these values. You use them later in this pattern.</p>	Cloud architect

Task	Description	Skills required
Deploy the fleet of Linux servers.	<ol style="list-style-type: none"><li>1. Sign in to the AWS Management Console, and open the <a href="#">CloudFormation console</a>.</li><li>2. Choose <b>Create stack</b>, and then choose <b>With new resources</b>.</li><li>3. In the <b>cloudformation_files</b> folder, select the <b>dcv-linux-fleet.yaml</b> file.</li><li>4. On the <b>Specify stack details</b> page, define the following parameters:<ul style="list-style-type: none"><li>• <b>Stack name</b> – The name of the stack.</li><li>• <b>DcvFleet</b> – The name of the NICE DCV fleet. Don't leave this value blank or use spaces.</li><li>• <b>InstanceType</b> – The instance type of the fleet.</li><li>• <b>RootVolumeSize</b> – The root volume size of the Linux EC2 instance.</li><li>• <b>MinSize</b> – The minimum number of nodes that should be available and not running any DCV session. For instance, if you enter 2, the solution starts with 2 nodes. When a user creates</li></ul></li></ol>	Cloud architect

Task	Description	Skills required
	<p>a session, the number of available nodes decreases to 1, and the solution creates another node to maintain the minimum.</p> <ul style="list-style-type: none"><li>• <b>MaxSize</b> – The maximum number of nodes in the fleet. Users cannot start new sessions if the maximum has been reached.</li><li>• <b>BillingTagName</b> – The tag name used for billing. This tag name must be different from the one used for the Windows stack.</li><li>• <b>BillingTagValue</b> – The tag value used for billing.</li></ul> <p>5. Complete the stack creation wizard, and then choose <b>Submit</b> to start creating the stack.</p>	

Task	Description	Skills required
Deploy the fleet of Windows servers.	<ol style="list-style-type: none"><li>1. Sign in to the AWS Management Console, and open the <a href="#">CloudFormation console</a>.</li><li>2. Choose <b>Create stack</b>, and then choose <b>With new resources</b>.</li><li>3. In the <b>cloudformation_files</b> folder, select the <b>dcv-windows-fleet.yaml</b> file.</li><li>4. On the <b>Specify stack details</b> page, define the following parameters:<ul style="list-style-type: none"><li>• <b>Stack name</b> – The name of the stack.</li><li>• <b>DcvFleet</b> – The name of the NICE DCV fleet. Don't leave this value blank or use spaces.</li><li>• <b>InstanceType</b> – The instance type of the fleet.</li><li>• <b>RootVolumeSize</b> – The root volume size of the Windows EC2 instance.</li><li>• <b>MinSize</b> – The minimum number of nodes that should be available and not running any DCV session.</li><li>• <b>MaxSize</b> – The maximum number of nodes in the fleet.</li></ul></li></ol>	Cloud architect

Task	Description	Skills required
	<ul style="list-style-type: none"> <li>• <b>BillingTagName</b> – The tag name used for billing. This tag name must be different from the one used for the Linux stack.</li> <li>• <b>BillingTagValue</b> – The tag value used for billing.</li> </ul> <p>5. Complete the stack creation wizard, and then choose <b>Submit</b> to start creating the stack.</p>	

## Access the deployed environment

Task	Description	Skills required
Retrieve the EnginFrame administrator password.	<p>The EnginFrame administration account is named <b>efadmin</b>, and the password is stored in AWS Secrets Manager as a secret. The ARN of the secret is generated dynamically and is visible in the output of the AWS CDK deployment.</p> <p>1. In the previous epic, in the <i>Deploy the solution story</i>, under the Elastic-VDI-Infrastructure. SecretEFAdminPassword output, find the ARN of the generated secret.</p>	Cloud architect

Task	Description	Skills required
	<p>2. Do one of the following to retrieve the secret:</p> <ul style="list-style-type: none"><li>• Use the <a href="#">Secrets Manager console</a>. For more information, see <a href="#">Retrieve secrets</a>.</li><li>• Enter the <a href="#">get-secret-value</a> command.</li></ul> <pre>aws secretsmanager get-secret-value \   --secret-id   &lt;secret_arn&gt; \   --query SecretStr ing \   --output text</pre>	
Access the EnginFrame portal.	<ol style="list-style-type: none"><li>1. In the previous epic, in the <i>Deploy the solution story</i>, under the Elastic-VDI-Infrastructure. EnginFrameURL output, find the HTTPS address of the EnginFrame portal.</li><li>2. In a web browser, enter the HTTPS address of the portal.</li><li>3. Enter the credentials for the <b>efadmin</b> user.</li></ol>	Cloud architect

Task	Description	Skills required
Start a Windows session.	<ol style="list-style-type: none"> <li>1. In the EnginFrame portal, in the menu, choose <b>Windows Desktop</b>.</li> <li>2. When you are prompted to sign in as a Windows administrator, enter the same password used for the <b>efadmin</b> user.</li> <li>3. Confirm that the Windows session successfully starts.</li> </ol>	Cloud architect
Start a Linux session.	<ol style="list-style-type: none"> <li>1. In the EnginFrame portal, in the menu, choose <b>Linux Desktop</b>.</li> <li>2. When you are prompted to sign in, enter the credentials for the <b>efadmin</b> user.</li> <li>3. Confirm that the Linux session successfully starts.</li> </ol>	Cloud architect

## Clean up

Task	Description	Skills required
Delete the stacks.	In the AWS CloudFormation console, delete the stacks for the Windows and Linux server fleets. For more information, see <a href="#">Deleting a stack</a> .	Cloud architect
Delete the infrastructure.	Delete the deployed infrastructure by using the following AWS CDK command.	Cloud architect



Task	Description	Skills required
	<pre>cdk destroy --all</pre>	

## Troubleshooting

Issue	Solution
The deployment didn't complete because it was interrupted.	Follow the instructions in the <i>Clean up</i> epic and then repeat this pattern to deploy the environment again.

## Related resources

- [NICE DCV](#)
- [NICE EnginFrame](#)

# Hybrid cloud

## Topics

- [Configure a data center extension to VMware Cloud on AWS using Hybrid Linked Mode](#)
- [Configure VMware vRealize Automation to provision VMs on VMware Cloud on AWS](#)
- [Deploy a VMware SDDC on AWS by using VMware Cloud on AWS](#)
- [Integrate VMware vRealize Network Insight with VMware Cloud on AWS](#)
- [Migrate VMs to VMware Cloud on AWS by using HCX OS Assisted Migration](#)
- [Send logs from VMware Cloud on AWS to Splunk by using VMware Aria Operations for Logs](#)
- [Set up a CI/CD pipeline for hybrid workloads on Amazon ECS Anywhere by using AWS CDK and GitLab](#)
- [More patterns](#)

# Configure a data center extension to VMware Cloud on AWS using Hybrid Linked Mode

Created by Deepak Kumar (AWS)

<b>Environment:</b> Production	<b>Technologies:</b> Hybrid cloud; Infrastructure; Migration	<b>Workload:</b> All other workloads
<b>AWS services:</b> AWS Direct Connect		

## Summary

**Notice:** As of April 30, 2024, VMware Cloud on AWS is no longer resold by AWS or its channel partners. The service will continue to be available through Broadcom. We encourage you to reach out to your AWS representative for details.

This pattern describes how you can use [Hybrid Linked Mode](#) to view and manage inventories in an on-premises data center and a VMware Cloud on AWS software-defined data center (SDDC) by using a single VMware vSphere Client interface.

By configuring Hybrid Linked Mode, you can migrate your on-premises virtual machines (VMs) and applications to the cloud SDDC. Your IT teams can then manage your cloud-based resources with familiar VMware tools and without requiring any new tools. You can also ensure consistent operations and simplified administration by using the [VMware Cloud Gateway Appliance](#).

This pattern provides two options for configuring Hybrid Linked Mode, but you can only use one option at a time. The first option installs the Cloud Gateway Appliance and uses it to link from the on-premises vCenter Server to the cloud SDDC. The second option configures Hybrid Linked Mode from the cloud SDDC.

## Prerequisites and limitations

### Prerequisites (both options)

- An existing on-premises data center and a cloud SDDC.
- An existing connection between the on-premises data center and the cloud SDDC, using AWS Direct Connect, a VPN, or both.
- The on-premises data center and cloud SDDC are synchronized with network time protocol (NTP) or another authoritative time source.
- The maximum latency of a round-trip time between the on-premises data center and the cloud SDDC doesn't exceed 100ms.
- Cloud administrators with access to your on-premises environment.
- The vCenter Server's fully qualified domain name (FQDN) must resolve to a private IP address.

### Prerequisites for Option 1

- The on-premises environment should run on vSphere 6.5.0d or later.
- The Cloud Gateway Appliance and vCenter Server can communicate over AWS Direct Connect, a VPN, or both.
- The Cloud Gateway Appliance meets hardware requirements.
- Firewall ports are open.

### Prerequisites for Option 2

- The on-premises vCenter Server runs on vSphere 6.0 Update 3 or later, or on vSphere 6.5.0d or later .
- Login credentials are available for the on-premises vSphere single sign-on (SSO) domain.
- Users in the on-premises environment have read-only access to the base distinguished name (Base DN).
- The on-premises Domain Name System (DNS) server is configured for VMware Management Gateway.
- Implement network connectivity tests using the VMware Connectivity Validator.
- Firewall ports are open.

### Limitations

- Hybrid Linked Mode can only connect one on-premises [vCenter Sever Enhanced Linked Mode](#) domain.

- Hybrid Linked Mode only supports on-premises vCenter Server running version 6.7 or later.

## Architecture

The following diagram shows both options for configuring Hybrid Linked Mode.

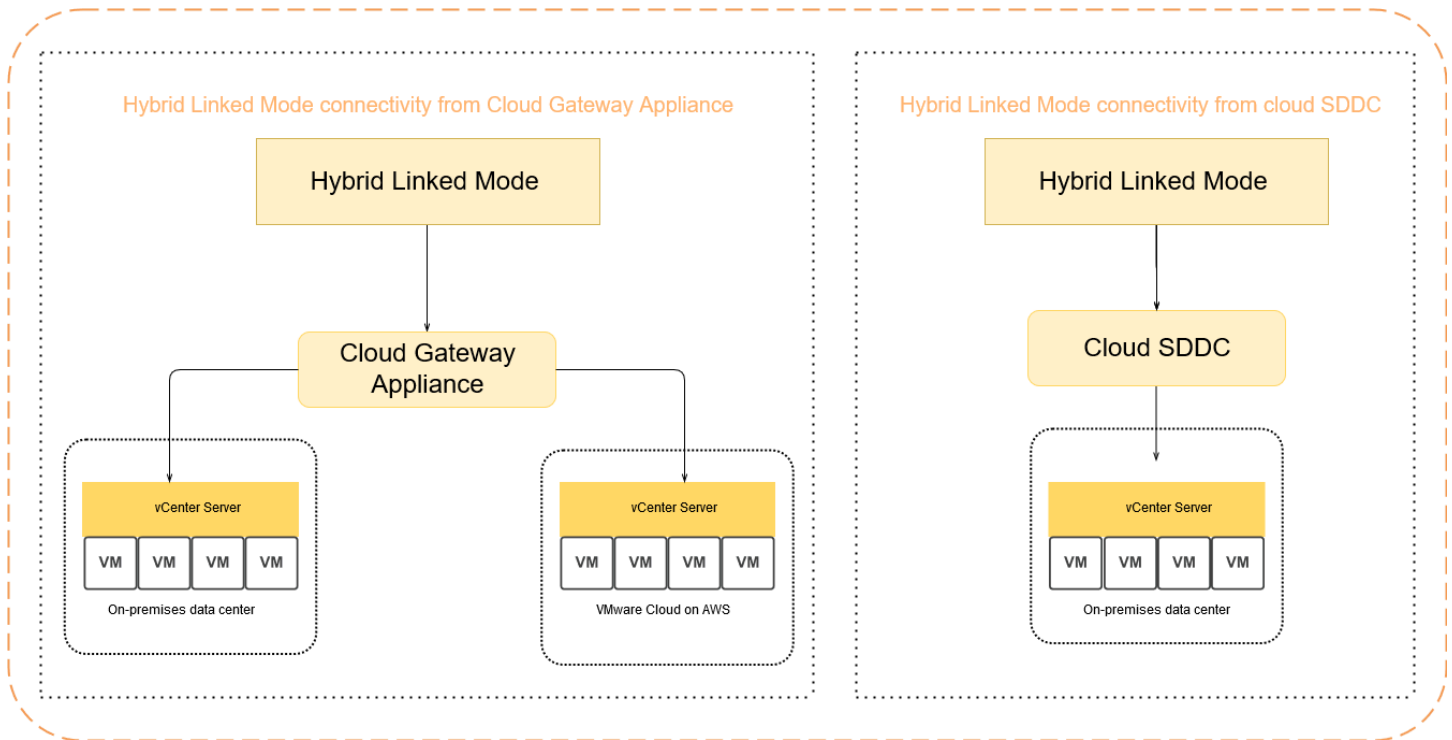

### Migrating different workload types using Hybrid Linked Mode

Hybrid Linked Mode supports migrating workloads between an on-premises data center and a cloud SDDC by using either a [cold migration](#) or a live migration with [VMware vSphere vMotion](#). Factors that must be considered when choosing the migration method include the virtual switch type and version, the connection type to the cloud SDDC, and the virtual hardware version.

A cold migration is appropriate for VMs that experience downtime. You can shut down the VMs, migrate them, and then turn them back on. The migration time is faster because there is no need to copy active memory. We recommend using a cold migration for applications that accept downtime (for example, tier 3 applications or development and testing workloads). If your VMs cannot experience downtime, you should consider a live migration using vMotion for your mission-critical applications.

The following diagram provides an overview of the different workload migration types using Hybrid Linked Mode.

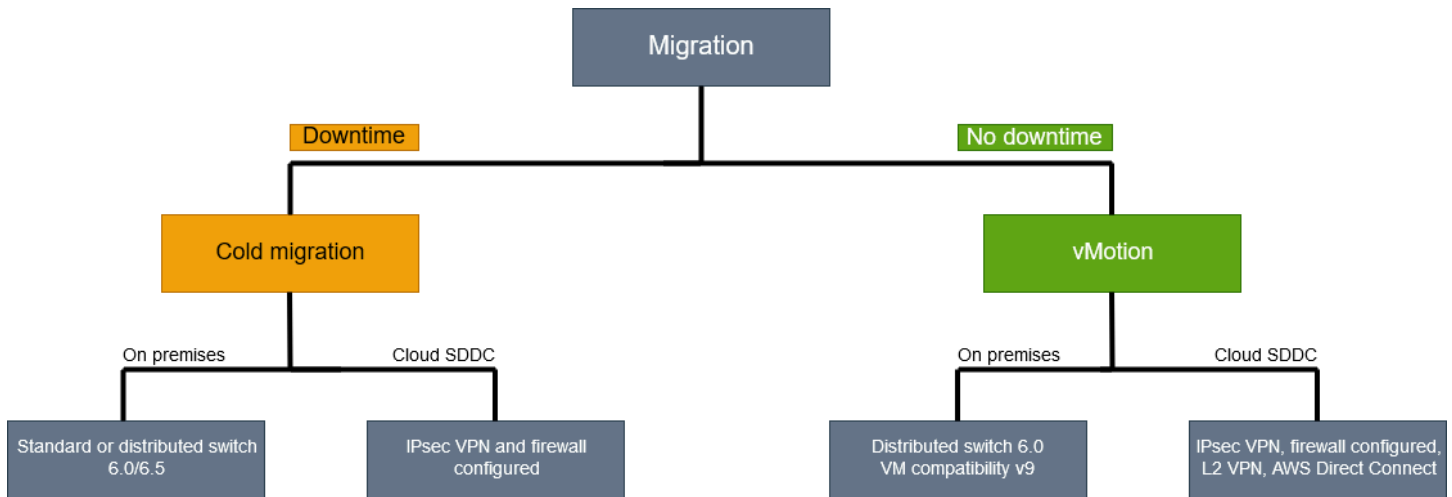

## Tools

- [VMware Cloud on AWS](#) is an integrated cloud offering jointly developed by AWS and VMware.
- [VMware Cloud Gateway Appliance](#) enables a number of hybrid cloud use cases where on-premises resources are connected to cloud resources.
- [VMware vSphere](#) is VMware's virtualization platform, which transforms data centers into aggregated computing infrastructures that include CPU, storage, and networking resources.

## Epics

### Option 1 - Use Hybrid Linked Mode with the Cloud Gateway Appliance

Task	Description	Skills required
Configure the Cloud Gateway Appliance.	<ol style="list-style-type: none"> <li>1. Log in to the VMware Cloud on AWS console and download the Cloud Gateway Appliance.</li> <li>2. Install the Cloud Gateway Appliance in your on-premises environment with the following two steps: <ul style="list-style-type: none"> <li>• Choose <b>Start to configure</b> and then</li> </ul> </li> </ol>	Cloud administrator

Task	Description	Skills required
	<p>deploy the Cloud Gateway Appliance.</p> <ul style="list-style-type: none"> <li>• Configure Hybrid Linked Mode.</li> </ul> <p>For more information and detailed steps, see <a href="#">Configuring Hybrid Linked Mode using the vCenter Cloud Gateway Appliance</a> in the VMware documentation.</p>	

## Option 2 - Use Hybrid Linked Mode from the cloud SDDC

Task	Description	Skills required
Configure Hybrid Linked Mode from the cloud SDDC.	<ol style="list-style-type: none"> <li>1. Log in to the VMware Cloud on AWS console and use the Connectivity Validator to check all required network connectivity. For more information about this, see <a href="#">Validate network connectivity for Hybrid Linked Mode</a> in the VMware documentation.</li> <li>2. Log in to the vSphere Client of the cloud SDDC, choose <b>Menu</b>, choose <b>Administration</b>, and then choose <b>Domains</b>.</li> <li>3. In the <b>Hybrid Cloud</b> section, choose <b>Linked</b></li> </ol>	Cloud administrator

Task	Description	Skills required
	<p><b>Domains</b> and then connect to your on-premises vCenter Server.</p> <p>4. Add an identity source to the cloud SDDC Lightweight Directory Access Protocol (LDAP) domain. For more information about this, see <a href="#">Add an Identity Source to the SDDC LDAP Domain</a> in the VMware documentation.</p>	

## Related resources

- [Configuring Hybrid Linked Mode](#)
- [Configuring Hybrid Linked Mode for VMware Cloud on AWS](#)



# Configure VMware vRealize Automation to provision VMs on VMware Cloud on AWS

Created by Deepak Kumar (AWS)

<b>Environment:</b> Production	<b>Technologies:</b> Hybrid cloud; Infrastructure	<b>Workload:</b> All other workloads
<b>AWS services:</b> AWS Direct Connect; AWS Site-to-Site VPN		

## Summary

**Notice:** As of April 30, 2024, VMware Cloud on AWS is no longer resold by AWS or its channel partners. The service will continue to be available through Broadcom. We encourage you to reach out to your AWS representative for details.

[VMware vRealize Automation](#) is automation software that you can use to request and manage IT resources. By choosing to configure vRealize Automation with VMware Cloud on AWS, you can automate the delivery of virtual machines (VMs), applications, and IT services across multiple data centers and cloud environments.

Your IT teams can then create catalog items to configure service provisioning and operational capabilities that your users can request and use with their existing vRealize Automation tools. You can also improve your IT agility and efficiency by integrating VMware Cloud on AWS with [vRealize Automation Cloud Assembly](#).

This pattern describes how to configure VMware vRealize Automation to automatically build VMs or application capabilities on VMware Cloud on AWS.

## Prerequisites and limitations

### Prerequisites

- An existing on-premises data center and a VMware Cloud on AWS software-defined data center (SDDC). For more information about the cloud SDCC, see [About Software-Defined Data Centers](#) in the VMware documentation.
- An existing connection between the on-premises data center and the cloud SDDC, using AWS Direct Connect, a VPN (route or policy-based), or both.
- The on-premises data center and cloud SDDC are synchronized with network time protocol (NTP) or another authoritative time source.
- The maximum latency of a round-trip time between the on-premises data center and the cloud SDDC doesn't exceed 100ms.
- The vCenter Server's fully qualified domain name (FQDN) must resolve to a private IP address.
- Cloud SDDC users with access to your on-premises environment.
- Organization owner access in the vRealize Automation Cloud Assembly service role.
- End users with permission in vRealize Automation Service Broker to consume service.
- The on-premises data center's Classless Inter-Domain Routing (CIDR) range must be open for the generating of API tokens from the VMware Cloud on AWS console. The following list provides the minimum roles required to generate API tokens:
  - Organization member
  - Organization owner
  - Service Roles - VMware Cloud on AWS
  - Administrator
  - NSX Cloud Administrator
  - NSX Cloud Auditor

For more information about this, see [Connectivity Options for VMware Cloud on AWS SDDCs](#) from the AWS Partner Network Blog.

## Limitations

- You can only configure 20 VMware Cloud accounts with public endpoints in one vRealize Automation. For more information about this, see [Scalability and concurrency maximums](#) in the VMware documentation.

## Product versions

- vRealize Automation version 8.x or later
- VMware vRealize Identity Manager version 3.x or later
- VMware vRealize Suite Lifecycle Manager version 8.x or later

## Architecture

The following diagram shows the vRealize Automation services that can use infrastructure from both on-premises and VMware Cloud on AWS environments.

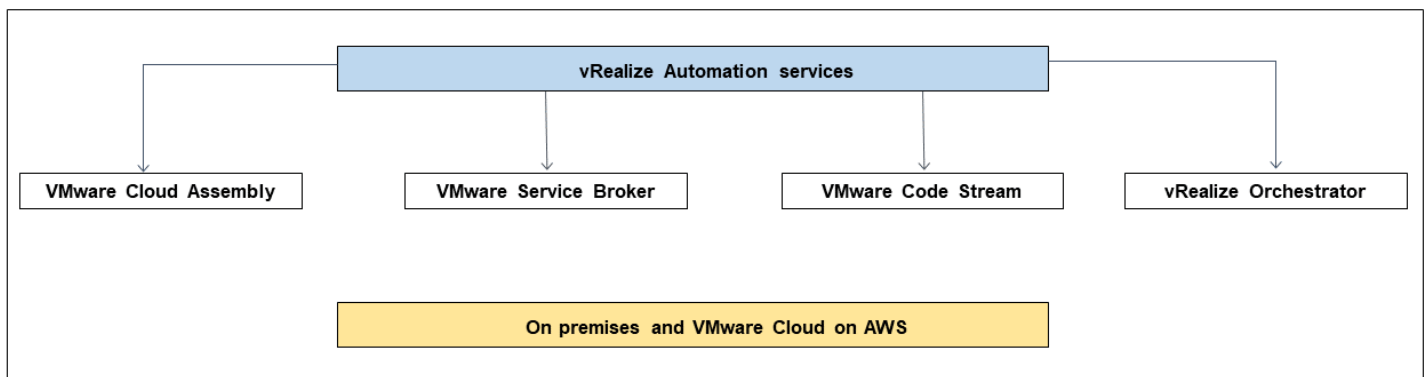

### VMware Cloud Assembly components

VMware Cloud Assembly is a core component of vRealize Automation and you can use it to deploy and provision VMs and compute resources. The following table describes VMware Cloud Assembly components that must be configured for provisioning VMs on VMware Cloud on AWS.

#### Components

##### Cloud Account

#### Definition

The Cloud Account provides connection details (for example, server name, user name and password, access key, and API token). VMware Cloud Assembly uses the Cloud Account to collect an inventory of your resources.

##### Cloud zones

Cloud zones identify resource boundaries in the Cloud Account (for example, AWS Regions and the cloud SDDC). Cloud zones associate compute resources with the Cloud Assembly project.

**Projects**

A project is a logical entity that consists of users and resources such as cloud zones. It also consists of resource quotas and VM naming policies that are used when building the VM.

**Flavor mappings**

Flavor mapping provides information about the VM's capacity (for example, number of CPUs and amount of memory) that are used in the Cloud Template.

**Image mappings**

Image mapping maps the VMware vSphere VM template and Amazon Web Services (AWS) image that are used in the Cloud Template. For more information about this, see [Learn more about image mappings in vRealize Automation](#) in the VMware documentation.

**Network profile**

Network profile controls the placement decision to choose a network during VM provisioning.

**Storage profile**

Storage profile controls the placement decision to choose storage during VM provisioning.

**Cloud Templates**

VMware Cloud Templates are an important component of vRealize Automation because they define cloud infrastructure provisioning and orchestration. The Cloud Templates are specifications for the resources and include the resource type, resource properties, and input to be collected from users.

**Tools**

- [VMware vRealize Automation](#) – vRealize Automation is an infrastructure automation platform with event-driven state management and compliance. It is designed to help organizations

control and secure self-service clouds, multi-cloud automation with governance, and DevOps-based infrastructure delivery.

- [VMware Cloud on AWS](#) – VMware Cloud on AWS is an integrated cloud offering jointly developed by AWS and VMware.

## Epics

### Generate the API tokens

Task	Description	Skills required
Generate the API tokens from your VMware Cloud on AWS account.	<ol style="list-style-type: none"><li>1. Sign in to the VMware Cloud Console.</li><li>2. On the VMware Cloud Services toolbar, choose <b>My Account</b> and then choose <b>API Token</b>.</li><li>3. Enter a name for your API token, provide the required lifespan, and define the scopes for the token.</li><li>4. Choose the <b>Open ID</b> check box and then choose <b>Generate</b>.</li><li>5. Record the API token's credentials.</li></ol> <p>For more information about this, see <a href="#">How do I generate API tokens</a> in the VMware documentation.</p>	Cloud administrator

## Install vRealize Automation in your on-premises data center

Task	Description	Skills required
Download the required software.	Download the VMware vRealize Suite ISO file from the My VMware Portal. This package contains vRealize Suite Lifecycle Manager, VMware Identity Manager, and vRealize Automation.	Cloud administrator
Install the software.	<p>Install the software and connect to your cloud SDCC by following the instructions from <a href="#">Installing vRealize Suite Lifecycle Manager with Easy Installer for vRealize Automation and VMware Identity Manager</a> in the VMware documentation.</p> <p><b>Important:</b> Make sure that the following are available for your installation:</p> <ul style="list-style-type: none"><li>• The on-premises VMware vCenter Server setup and login credentials</li><li>• The network details for the vRealize Automation IP and subnet</li><li>• The vRealize Automation license key</li></ul>	Cloud administrator, Cloud architect

## Connect VMware Cloud on AWS with VMware Cloud Assembly

Task	Description	Skills required
Configure your Cloud Accounts.	<ol style="list-style-type: none"><li>1. On the VMware Cloud Console, open the <b>Infrastructure</b> tab, choose <b>Manage – Cloud Accounts</b>, and then choose <b>Add Cloud Accounts</b>.</li><li>2. Choose <b>VMware Cloud on AWS</b> as the type.</li><li>3. Paste the API token information that you recorded earlier. This populates all available cloud SDDCs in your VMware Cloud on AWS organization.</li><li>4. Choose the required cloud SDDC and then provide the vCenter user name and password for the SDDC.</li><li>5. After you are successfully authenticated, you can view the integrated VMware Cloud on AWS account with an <b>OK</b> status.</li></ol> <p>For more information about this, see <a href="#">Create a VMware Cloud on AWS cloud account in vRealize Automation</a> in the VMware documentation.</p>	Cloud architect, Cloud administrator

Task	Description	Skills required
Configure the project.	<ol style="list-style-type: none"><li>1. On the VMware Cloud Console, open the <b>Projects</b> tab and then choose <b>New project</b>.</li><li>2. Enter the name of your project.</li><li>3. Open the <b>Cloud Zones</b> tab and choose <b>default VMware Cloud on AWS Cloud Account</b>.</li></ol>	Cloud administrator
Configure cloud zone.	<ol style="list-style-type: none"><li>1. On the VMware Cloud Console, open <b>Cloud Zones</b> and choose the cloud zone for your SDDC data center.</li><li>2. By default, <code>cloudadmin@vmc.local</code> (this is the default local user ID for the cloud SDDC's vCenter) only has access to provision in the <code>Compute-ResourcePool</code> .</li><li>3. Open the <b>Compute</b> tab under <b>Cloud Zones</b> and then choose <b>Compute-ResourcePool</b>.</li></ol>	Cloud administrator



Task	Description	Skills required
Configure flavor mapping.	<ol style="list-style-type: none"><li>1. Open the <b>Flavor Mappings</b> tab and create a new flavor mapping.</li><li>2. Enter the flavor name, choose the VMware Cloud on AWS account, and then provide the number of vCPUs and amount of memory.</li></ol>	Cloud administrator
Configure image mapping.	<ol style="list-style-type: none"><li>1. Open <b>Image Mappings</b> and create a new image mapping.</li><li>2. Enter the image name.</li><li>3. Choose the VMware Cloud on AWS account and provide the Cloud Account templates that are required.</li></ol>	Cloud administrator
Configure network profile.	<ol style="list-style-type: none"><li>1. Open <b>Network Profile</b> and create a new network profile.</li><li>2. Enter the network profile name.</li><li>3. Open the <b>Network</b> tab and choose the existing network that you want to use for provisioning.</li></ol>	Cloud administrator

Task	Description	Skills required
Configure storage profile.	<ol style="list-style-type: none"><li>1. Open <b>Storage Profile</b> and choose <b>New Storage Profile</b>.</li><li>2. Enter the storage profile's name.</li><li>3. In the <b>Policies</b> section, create a new policy.</li><li>4. Choose <b>Workload Datastore</b>. By default <code>cloudadmin@vmc.local</code> only has access to provision in the workload's datastore.</li></ol>	Cloud administrator

Task	Description	Skills required
Create the Cloud Template.	<ol style="list-style-type: none"><li>1. Open the <b>Design</b> tab, choose <b>Cloud Templates</b> , and then choose <b>New From</b> and <b>Blank Canvas</b>.</li><li>2. Provide the name and description of the Cloud Template.</li><li>3. Choose the project that you created earlier.</li><li>4. From the Cloud Template resources design page, drag components into the blank canvas according to your requirements.</li><li>5. Choose <b>Test</b> to test the template and fix any issues.</li><li>6. Choose <b>Deployment</b> and provide the deployment name to deploy the VMs.</li></ol> <p>For more information about this, see <a href="#">Create a basic cloud template</a> in the VMware documentation.</p>	Cloud administrator

## Related resources

- [Connect vRealize Automation version 8.x to your SDDC:](#)
- [Deploy an SDDC from the VMware Cloud on AWS Console](#)
- [AWS Direct Connect Integration with VMware Cloud on AWS](#)

# Deploy a VMware SDDC on AWS by using VMware Cloud on AWS

Created by Deepak Kumar (AWS) and Derek Cox (AWS)

**Environment:** Production

**Technologies:** Hybrid cloud;  
Infrastructure

**Workload:** All other  
workloads

**AWS services:** Amazon VPC

## Summary

**Notice:** As of April 30, 2024, VMware Cloud on AWS is no longer resold by AWS or its channel partners. The service will continue to be available through Broadcom. We encourage you to reach out to your AWS representative for details.

This pattern describes how to create a VMware-based Software-Defined Data Center (SDDC) that's hosted in the Amazon Web Services (AWS) Cloud. You can deploy an SDDC to migrate your VMware vSphere-based workloads to the AWS Cloud and take advantage of AWS services while you use your existing VMware tools and skills. You can use this SDDC to run your production applications across VMware vSphere-based private, public, and hybrid cloud environments, with optimized access to AWS services. For example, you can use the SDDC as a secondary site for disaster recovery or to extend your data center to different geographical locations.

VMware Cloud on AWS is a pay-as-you-go (on-demand) service that enables enterprises of all sizes to run workloads across VMware vSphere-based cloud environments by using a wide range of AWS services. You can start with a minimum of 2 hosts per SDDC cluster and scale up to 16 hosts per cluster in your production environment. For more information, see the [VMware Cloud on AWS](#) website. To learn more about SDDCs, see [About Software-Defined Data Centers](#) in the VMware documentation.

## Prerequisites and limitations

### Prerequisites

- Sign up for a [MyVMware account](#) and fill out all fields.
- Sign up for an [AWS account](#). For instructions, see the [AWS Knowledge Center](#).
- Sign up for an **MyVMware Cloud on AWS account**. An activation link is sent to the email address you specify when you sign up.

## Limitations

- See [VMware Cloud on AWS configuration limits](#) pages on the VMware website.

## Product versions

- See [VMware Cloud on AWS Release Notes](#) in the VMware documentation.

## Architecture

### Target technology stack

The following diagram shows the VMware software stack, including vSphere, vCenter, vSAN, and NSX-T, running on AWS bare-metal dedicated infrastructure. You can manage your VMware-based resources and tools on AWS with seamless integration with other AWS services such as Amazon Elastic Compute Cloud (Amazon EC2), Amazon Simple Storage Service (Amazon S3), Amazon Redshift, AWS Direct Connect, Amazon Relational Database Service (Amazon RDS), and Amazon DynamoDB.

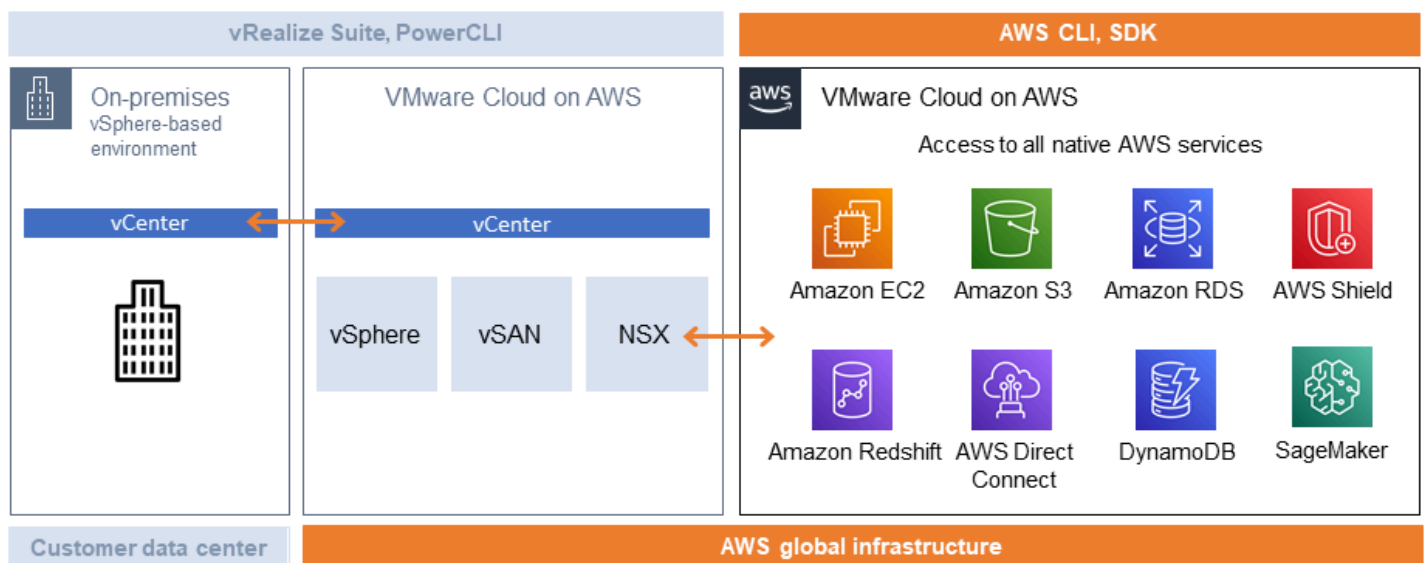

The basic entity of VMware Cloud on AWS is an SDDC, which includes the following components:

- **Compute:** The compute component is the lowest layer of the VMware Cloud on AWS SDDC. VMware Cloud on AWS runs on Amazon EC2 bare metal instance types. These include `i3.metal`, `i3en.metal`, and `i4i.metal`, and provide direct access to physical resources such as processors and memory.  
  
**Important:** The `i3.metal` instance type for VMware Cloud on AWS, including on-demand and subscription options of one-year and three-year terms, is set to reach its end of life and end of support on December 31, 2026. Additionally, new customers are currently not able to request `i3.metal` instances. For more information, see the [announcement on the VMware Cloud Blog](#).
- **Storage:** SDDC clusters support VMware vSAN with an all-flash configuration for storage using non-volatile memory express (NVMe) flash storage, which provides fast and high-performance storage. Starting with SDDC version 1.20, VMware Cloud on AWS offers support for two types of external storage: Amazon FSx for NetApp ONTAP and VMware Cloud Flex Storage.
- **Networking:** Networking capabilities and policies are managed by using VMware NSX-T in the SDDC cluster. Multi-tier virtual networks are created in the SDDC cluster to separate network resources from physical equipment. This enables VMware Cloud on AWS users to create logical, software-defined networks.

## Tools

- [VMware Cloud on AWS](#) is an integrated cloud offering jointly developed by AWS and VMware.

## Epics

### Create a VPC and subnet in your AWS account

Task	Description	Skills required
Sign in to your AWS account.	Sign in to your <a href="#">AWS account</a> with credentials that have administrator permissions.	Cloud administrator
Create a new VPC.	In this step, you define a virtual private cloud (VPC) that links to the SDDC. If you	Cloud administrator

Task	Description	Skills required
	<p>already have a VPC you want to use for the SDDC, skip this step.</p> <ol style="list-style-type: none"><li>1. Choose the AWS Region to deploy your VMware Cloud on AWS SDDC.</li><li>2. Open the Amazon VPC console at <a href="https://console.aws.amazon.com/vpc/">https://console.aws.amazon.com/vpc/</a>.</li><li>3. In the navigation pane, choose <b>Your VPCs</b>.</li><li>4. Choose <b>Create VPC</b>.</li><li>5. Specify VPC settings such as the VPC <b>name tag</b>, <b>IPv4 CIDR</b> block, <b>Tenancy</b> (keep as <b>Default</b>), and then choose <b>Create VPC</b>.</li><li>6. When the VPC has been created, choose <b>Close</b>.</li></ol> <p>For more information, see <a href="#">Create and configure your VPC</a> in the AWS documentation.</p>	

Task	Description	Skills required
Create a private subnet.	<p>You will now create a private subnet for the elastic network interface (ENI) for each Availability Zone. We recommend that you use a subnet without an internet gateway attached.</p> <ol style="list-style-type: none"><li>1. Open the Amazon VPC console at <a href="https://console.aws.amazon.com/vpc/">https://console.aws.amazon.com/vpc/</a>.</li><li>2. In the navigation pane, choose <b>Subnets</b>.</li><li>3. Choose <b>Create Subnet</b>.</li><li>4. On the <b>Create Subnet</b> page, choose the VPC that you created earlier.</li><li>5. Complete the settings for the subnet, including a <b>subnet name</b>, <b>Availability Zone</b>, and <b>IPv4 CIDR block</b>.</li><li>6. Choose <b>Create Subnet</b>.</li></ol> <p>Repeat these steps to create subnets for each Availability Zone in the Region.</p>	Cloud administrator



## Activate VMware Cloud on AWS

Task	Description	Skills required
Activate the service.	<p>When you sign up for a MyVMware account, VMware sends you a welcome email and activation link to the email address you specified.</p> <ol style="list-style-type: none"><li>1. Open the <b>Activate Service</b> link from the welcome email in your browser.</li><li>2. Log in with MyVMware credentials.</li><li>3. Review and accept the terms and conditions for the use of services.</li><li>4. Complete the account activation process. You will be redirected to the VMware Cloud on AWS console. (Note: VMware Cloud on AWS accounts are based on an organization, which represents a group or line of business subscribed to the account. This organization has no relationship to AWS Organizations.)</li><li>5. On the <b>Select or Create Organization</b> page, create an organization that is linked to the MyVMware account.</li></ol>	Cloud administrator

Task	Description	Skills required
	<p>6. Enter the <b>Organization Name</b> and <b>Address</b> for logical distinction.</p> <p>7. Select <b>Create Organization</b> to complete the process.</p> <p>For more information about this process, see <a href="#">SDDC Deployment and Best Practices Guide on AWS</a> in the AWS documentation.</p>	
Assign IAM roles.	<p>When the organization has been created, assign privileged access to specific users to access the Cloud Services and SDDC console, SDDC, and NSX components. For instructions, see <a href="#">Assign a VMC Service Role to an Organization Member</a> in the VMware documentation.</p> <p>There are two types of organization roles:</p> <ul style="list-style-type: none"><li>• Organization owners can add, remove, and modify users and access all cloud resources.</li><li>• Organization members can access cloud resources only.</li></ul>	Cloud administrator

## Deploy an SDDC

Task	Description	Skills required
Deploy an SDDC in your VMware Cloud on AWS account.	<p><b>Important:</b> After an AWS account has been associated with a VMware Organization as the seller of record, the AWS account number cannot be updated. There can be only one AWS seller of record per VMware Organization.</p> <p>To deploy an SDDC:</p> <ol style="list-style-type: none"><li>1. Log in to the VMC console at <a href="https://vmc.vmware.com">https://vmc.vmware.com</a>.</li><li>2. Choose <b>VMware Cloud on AWS Service</b> from the available services.</li><li>3. Choose <b>Create SDDC</b>.</li><li>4. Enter SDDC properties such as <b>AWS Region, Deployment (Single Host, Multi-Host, or Stretched Cluster), Host Type, SDDC Name, Number of Hosts, Host Capacity, and Total Capacity</b>, and then choose <b>Next</b>.</li><li>5. Connect to your AWS account, and then choose <b>Next</b>.</li><li>6. Select your previously configured VPC and</li></ol>	Cloud administrator, Cloud architect

Task	Description	Skills required
	<p>subnet, and then choose <b>Next</b>.</p> <p>7. Enter the management subnet CIDR block for the SDDC, and then choose <b>NEXT</b>. For more information, see <a href="#">Selecting IP Subnets and Connectivity for your SDDC</a> on the VMware Cloud Blog.</p> <p>8. Select the two check boxes to acknowledge that you take responsibility for the costs for deploying an SDDC, and then choose <b>Deploy SDDC</b>.</p> <p>You'll be charged when you choose <b>Deploy SDDC</b>. You won't be able to pause or cancel the deployment process, which takes some time to complete.</p> <p>For more information about creating an SDDC, see <a href="#">Deploy an SDDC from the VMC Console</a> in the VMware documentation.</p>	

## Related resources

- [Deploying and Managing a Software-Defined Data Center](#) (VMware documentation)

- [VMware Cloud on AWS features](#) (AWS website)
- [Accelerate Cloud Migration and Modernization with VMware Cloud on AWS](#) (video)

# Integrate VMware vRealize Network Insight with VMware Cloud on AWS

Created by Deepak Kumar (AWS), Piotr Pitera (AWS), and Sachin Trivedi (AWS)

<b>Environment:</b> PoC or pilot	<b>Source:</b> VMware vRealize Network Insight	<b>Target:</b> VMware Cloud on AWS
<b>R Type:</b> Relocate	<b>Workload:</b> All other workloads	<b>Technologies:</b> Hybrid cloud; Infrastructure; Migration
<b>AWS services:</b> VMware Cloud on AWS		

## Summary

**Notice:** As of April 30, 2024, VMware Cloud on AWS is no longer resold by AWS or its channel partners. The service will continue to be available through Broadcom. We encourage you to reach out to your AWS representative for details.

This pattern describes how to integrate VMware vRealize Network Insight with VMware Cloud on AWS and inspect traffic flow from your virtual machines. This integration also helps you plan application migrations to VMware Cloud on AWS.

vRealize Network Insight offers visibility into your network infrastructure. It provides network monitoring and analytics features to improve security, mitigate migration risks, and optimize performance. You can use this tool to monitor traffic flows from your virtual machines and view recommended security rules based on the observed traffic. For more information about vRealize Network Insight, see the [VMware documentation](#).

VMware Cloud on AWS is a pay-as-you-go (on-demand) service that enables enterprises of all sizes to run workloads across VMware vSphere-based cloud environments by using a wide range of AWS services. You can start with a minimum of 2 hosts per SDDC cluster and scale up to 16 hosts per cluster in your production environment. For more information, see the [VMware Cloud on AWS](#)

website. To learn more about SDDCs, see [About Software-Defined Data Centers](#) in the VMware documentation.

## Prerequisites and limitations

### Prerequisites

- VMware Cloud on AWS SDDC, deployed

### Limitations

- For known limitations, see the [VMware documentation](#).

### Product versions

- vRealize Network Insight version 5.0.0
- VMware Cloud on AWS SDDC version 1.24

## Architecture

### Source technology stack

- vRealize Network Insight

### Target technology stack

- VMware Cloud on AWS

### Target architecture

The following diagram shows the connectivity between VMware Cloud on AWS and vRealize Network Insight on premises.

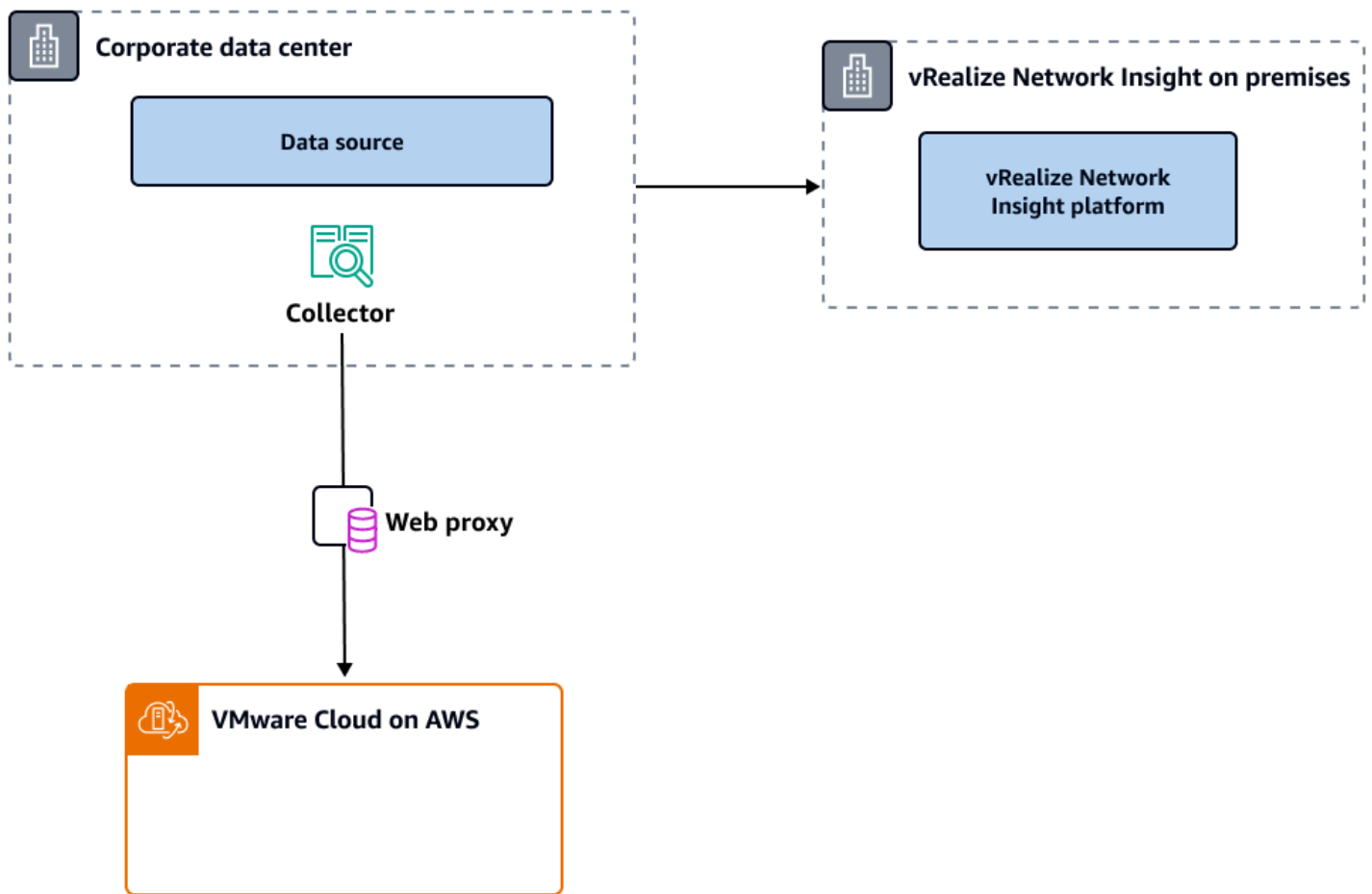

## Tools

- [VMware Cloud on AWS](#) is an integrated cloud offering jointly developed by AWS and VMware.
- [VMware vRealize Network Insight](#) is a monitoring and analytics tool that provides visibility into the network infrastructure for security planning and troubleshooting.

## Epics

### Set up your environment for vRealize Network Insight

Task	Description	Skills required
Create a VMware user account.	Create a VMware user account or log in to your existing VMware account.	Cloud administrator



Task	Description	Skills required
	<p>To open a new account:</p> <ol style="list-style-type: none"> <li>1. Sign up for a <a href="#">VMware Customer Connect account</a> by completing the registration form.</li> </ol> <p>New users will receive an email to activate their accounts.</p> <ol style="list-style-type: none"> <li>2. Enter the authentication code from the email.</li> <li>3. Log in to <a href="#">Customer Connect</a>.</li> </ol>	
Download the OVA files for vRealize Network Insight.	<p>Download the OVA files for vRealize Network Insight:.</p> <ol style="list-style-type: none"> <li>1. Navigate to the VMware product download page at <a href="https://my.vmware.com/group/vmware/home">https://my.vmware.com/group/vmware/home</a>.</li> <li>2. Search for vRealize Network Insight.</li> <li>3. Download the latest vRealize Network Insight version 5.0.0 platform and collector OVA files.</li> </ol>	Cloud administrator
Deploy vRealize Network Insight.	<p>For deployment instructions, see the <a href="#">VMware documentation</a>.</p>	Cloud administrator

## Add a data source and collector

Task	Description	Skills required
Add a data source.	<ol style="list-style-type: none"> <li>1. Log in to vRealize Network Insight.</li> <li>2. Choose <b>Settings, Accounts and Data Sources, Add Source</b>.</li> <li>3. For <b>Type</b>, choose <b>On-premise vCenter server</b>.</li> </ol> <p>For more information, see the <a href="#">VMware documentation</a>.</p>	Cloud administrator
Set up a collector for the data source.	For instructions, see the <a href="#">VMware documentation</a> .	Cloud administrator

## Analyze application dependencies

Task	Description	Skills required
Create an application.	If you don't have an existing application in vRealize Network Insight, follow the steps in the <a href="#">VMware documentation</a> to create one.	Cloud administrator
Discover and analyze your application.	<ol style="list-style-type: none"> <li>1. Use vRealize Network Insight to discover your application. For instructions, see the <a href="#">VMware documentation</a>.</li> </ol>	Cloud administrator

Task	Description	Skills required
	2. Analyze your application. For instructions, see the <a href="#">VMware documentation</a> .	

## Related resources

- [Deploy a VMware SDDC on AWS by using VMware Cloud on AWS](#) (AWS Prescriptive Guidance)
- [Configure a data center extension to VMware Cloud on AWS using Hybrid Linked Mode](#) (AWS Prescriptive Guidance)
- [Migrate VMware SDDC to VMware Cloud on AWS using VMware HCX](#) (AWS Prescriptive Guidance)
- [VMware vRealize Network Insight documentation](#) (VMware website)

# Migrate VMs to VMware Cloud on AWS by using HCX OS Assisted Migration

Created by Deepak Kumar (AWS) and Himanshu Gupta (AWS)

<b>Environment:</b> PoC or pilot	<b>Source:</b> Non-vSphere environment	<b>Target:</b> VMware Cloud on AWS SDDC
<b>R Type:</b> Relocate	<b>Workload:</b> All other workloads	<b>Technologies:</b> Hybrid cloud; Migration

## Summary

**Notice:** As of April 30, 2024, VMware Cloud on AWS is no longer resold by AWS or its channel partners. The service will continue to be available through Broadcom. We encourage you to reach out to your AWS representative for details.

This pattern describes how to migrate a virtual machine (VM) from a non-vSphere environment to VMware Cloud on Amazon Web Services (AWS) by using OS Assisted Migration (OSAM).

OSAM is part of VMware Hybrid Cloud Extension (HCX), which is included with VMware Cloud on AWS. You can use OSAM to migrate a non-vSphere environment such as VMware KVM or Hyper-V to VMware Cloud on AWS. OSAM uses Sentinel software, which you install on a Windows or Linux guest VM to assist in replicating the VM from your on-premises environment to a Software-Defined Data Center (SDDC) on VMware Cloud on AWS.

This pattern explains how to enable OSAM, install Sentinel software on a Windows VM, connect and register with an HCX Sentinel Gateway (SGW) appliance at the source site, and establish a forwarding connection with an HCX Sentinel Data Receiver (SDR) appliance at the destination site to initiate migration.

For more information about OSAM, see the [VMware documentation](#).

## Prerequisites and limitations

### Prerequisites

- Install HCX in your source and target environments. For HCX prerequisites, see [Migrate VMware SDDC to VMware Cloud on AWS using VMware HCX](#) in the AWS Prescriptive Guidance documentation.
- For OSAM prerequisites, see the [installation checklist](#) in the VMware documentation.
- For OSAM port information, see [VMware HCX port requirements](#) on the VMware Ports and Protocols website.

## Limitations

- [VMware HCX 4.2.0 Configuration Limits](#)
- [Considerations for OSAM Deployment](#)
- [Supported Guest Operating Systems](#)
- [Guest Operating System Considerations](#)

## Product versions

- VMware HCX 4.2.0
- VMware SDDC 1.12

## Architecture

The following diagram shows how HCX OSAM works with the Sentinel software to replicate non-vSphere VMs from your on-premises environment to VMware Cloud on AWS.

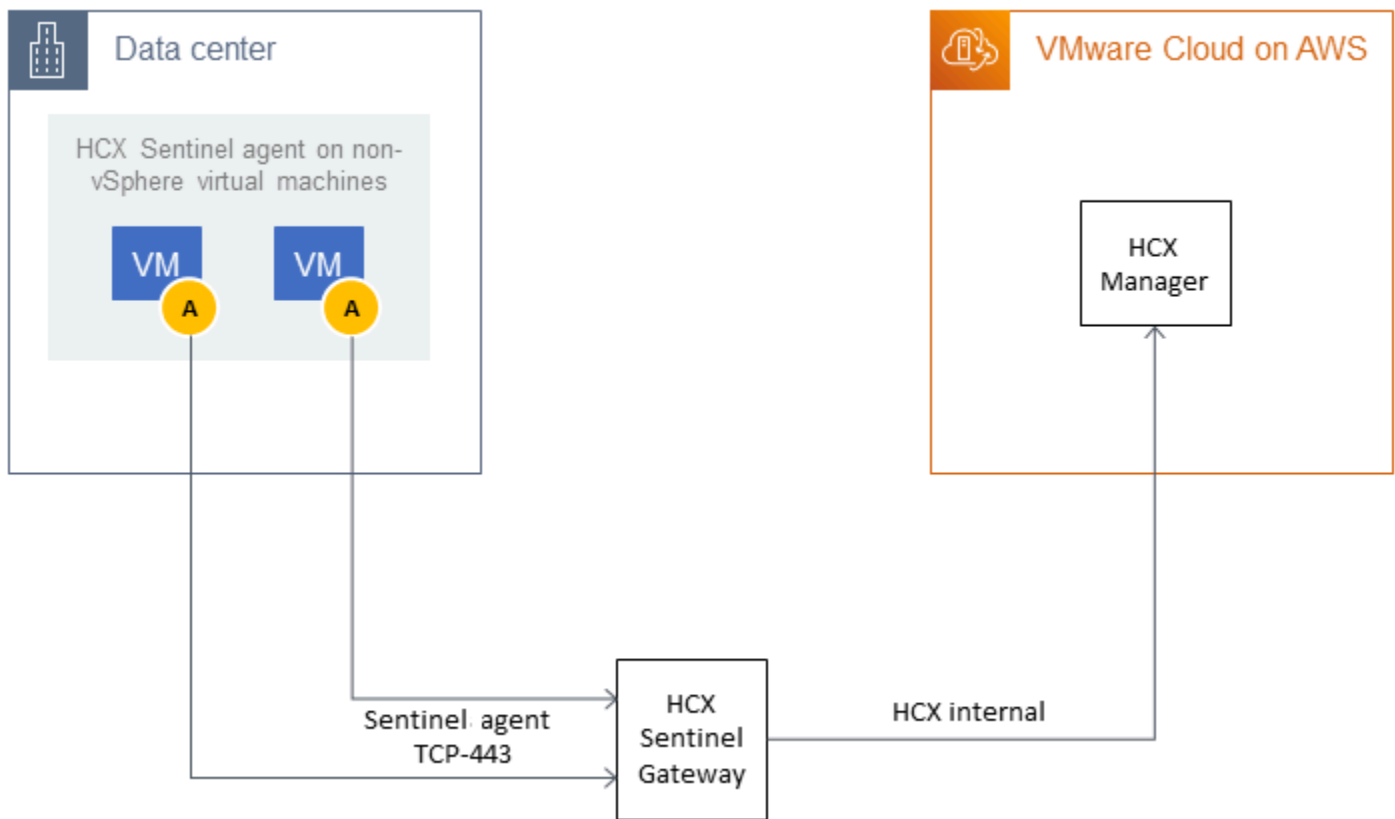

OSAM consists of three components:

- The Sentinel Gateway (SGW) appliance, which is used to connect and forward workloads and applications in the source VMware-based environment
- The Sentinel Data Receiver (SDR), which is used in the destination VMware Cloud on AWS environment to receive migrated workloads from the source
- Sentinel software, which must be installed on each guest VM that you want to migrate

OSAM uses the Sentinel software that is installed on Windows or Linux guest VMs to assist in replicating a VM from on premises to a VMware SDDC. The Sentinel software that you install on guest VMs collects the system configurations from the guest VM and assists with the data replication. This information is also used to create the inventory of guest VMs for migration and helps prepare the disks on the replica VM for replication and migration purposes.

## Tools

- VMware HCX 4.2.0
- VMware Cloud on AWS SDDC

## Epics

### Configure HCX

Task	Description	Skills required
Deploy HCX Cloud and HCX Connector.	Follow the instructions in <a href="#">HCX Connector and HCX Cloud Installations</a> in the VMware documentation.	Cloud administrator, Systems administrator

### Configure OSAM and migrate VMs

Task	Description	Skills required
Install HCX Sentinel.	<p>To install Sentinel on Linux:</p> <ol style="list-style-type: none"> <li>1. In the vCenter Server for the HCX Connector, choose <b>Interconnect, Multi-Site Service Mesh, Sentinel Management</b>.</li> <li>2. Choose <b>Download Linux Bundle</b>.</li> <li>3. Install the Sentinel agent on a Linux machine.</li> </ol> <p>For more information, see <a href="#">Downloading and Installing HCX Sentinel Agent software</a> in the VMware documentation.</p>	Cloud administrator
Migrate VMs.	To migrate your VMs in groups (called <i>mobility groups</i> ), follow these steps:	Cloud administrator

Task	Description	Skills required
	<ol style="list-style-type: none"><li>1. In the vSphere Client, from the HCX plug-in, choose <b>Services, Migration</b>.</li><li>2. Choose <b>Migrate</b>.</li><li>3. Choose <b>Non vSphere Inventory, Remote connections</b>. This will show the list VMs that you installed HCX Sentinel on.</li><li>4. For <b>Group name</b>, enter the name of the mobility group you want to create for the VMs.</li><li>5. Choose the VMs you want to migrate, and then choose <b>Add</b> to add them to the mobility group.</li><li>6. For each VM:<ol style="list-style-type: none"><li>a. Select the destination compute container.</li><li>b. Select the destination storage.</li><li>c. Select the migration profile.</li><li>d. Select the destination folder.</li></ol></li><li>7. To start the migration process, choose <b>Go</b>.</li></ol> <p>HCX validates your VM selections before migration starts.</p>	



Task	Description	Skills required
	For more information, see <a href="#">Migrating Virtual Machines with Mobility Groups</a> and <a href="#">Monitoring and Estimating Migration with Mobility Groups</a> in the VMware documentation.	

## Related resources

VMware documentation:

- [VMware HCX User Guide](#)
- [Install Checklist B - HCX with a VMC SDDC Destination Environment](#)
- [VMware HCX in the VMware Cloud on AWS](#)
- [HCX OS Assisted Migration for VMware Cloud on AWS](#)
- [VMware HCX 4.2.1 Release Notes](#)

# Send logs from VMware Cloud on AWS to Splunk by using VMware Aria Operations for Logs

Created by Deepak Kumar (AWS) and Piotr Pitera (AWS)

<b>Environment:</b> Production	<b>Source:</b> VMware Cloud on AWS logs and events	<b>Target:</b> Splunk on-premises endpoint
<b>R Type:</b> Relocate	<b>Workload:</b> All other workloads	<b>Technologies:</b> Hybrid cloud; Infrastructure; Migration
<b>AWS services:</b> VMware Cloud on AWS		

## Summary

**Notice:** As of April 30, 2024, VMware Cloud on AWS is no longer resold by AWS or its channel partners. The service will continue to be available through Broadcom. We encourage you to reach out to your AWS representative for details.

This pattern describes how to forward VMware Cloud on AWS events or logs to a syslog or an HTTP endpoint such as Splunk by using VMware Aria Operations for Logs.

VMware Aria Operations for Logs is a log analysis tool that offers enhanced visibility and accelerated troubleshooting in the VMware Cloud on AWS environment. You can configure this tool to send either all or a portion of logs or events in VMware Cloud on AWS to a syslog or HTTP endpoint. The endpoint can be either a software as a service (SaaS) endpoint or an on-premises endpoint such as Splunk. (This pattern provides the instructions for Splunk.) To learn more about VMware Aria Operations for Logs, see the [VMware documentation](#).

VMware Cloud on AWS is a pay-as-you-go (on-demand) service that enables enterprises of all sizes to run workloads across VMware vSphere-based cloud environments by using a wide range of AWS services. You can start with a minimum of 2 hosts per Software-Defined Data Center (SDDC) cluster and scale up to 16 hosts per cluster in your production environment. For more information, see

the [VMware Cloud on AWS](#) website. To learn more about SDDCs, see [About Software-Defined Data Centers](#) in the VMware documentation.

## Prerequisites and limitations

### Prerequisites

- Splunk, configured on premises

### Limitations

You can sign up for a free trial subscription to VMware Aria Operations for Logs. This subscription is valid for 30 days and has the following limitations:

- Maximum size of logs you can forward: 50 GB logs per day
- Maximum number of log forwarding configurations you can create: 10
- Maximum number of log forwarding configurations you can activate: 5

To access all service features, you must upgrade to a premium subscription.

For more information about trial and premium subscriptions, see [VMware Aria Operations for Logs \(SaaS\) Subscriptions and Billing](#) in the VMware documentation. For more information about usage limits, see [Usage Limitations for Features](#) in the VMware documentation.

### Product versions

- VMware Cloud on AWS SDDC version 1.24
- VMware Aria Operations for Logs version 8.10
- On-premises Splunk version 9.x

## Architecture

### Source technology stack

- VMware Cloud on AWS
- VMware Aria Operations for Logs

### Target technology stack

- On-premises Splunk

## Target architecture

The following diagram shows the connectivity between a corporate data center and VMware Aria Operations for Logs in VMware Cloud on AWS.

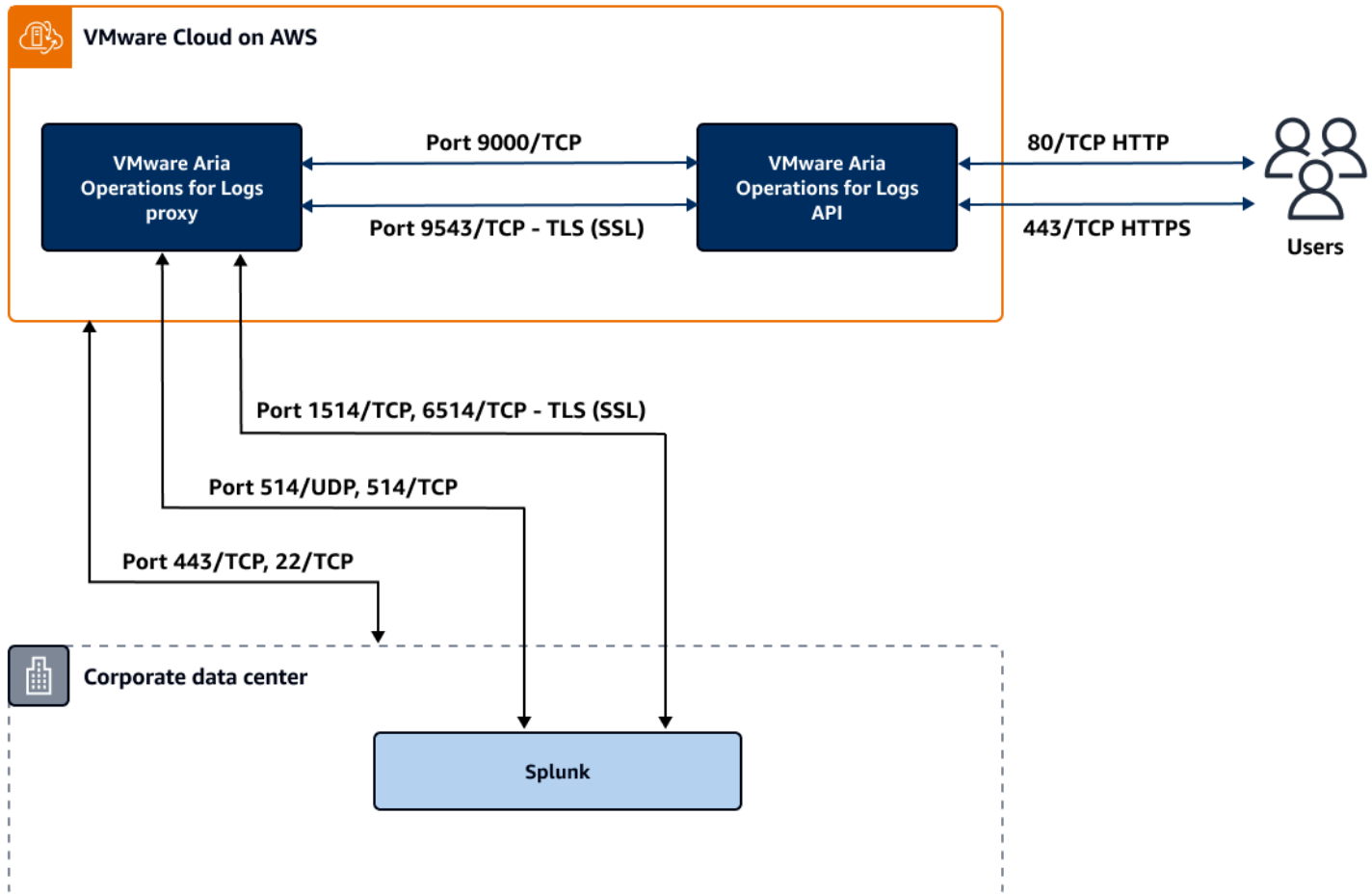

## Tools

- [VMware Cloud on AWS](#) is an integrated cloud offering jointly developed by AWS and VMware.
- [VMware Aria Operations for Logs](#) is a log analysis and troubleshooting tool for VMware Cloud on AWS.

## Epics

### Deploy an SDDC and enable VMware Aria Operation for Logs

Task	Description	Skills required
Deploy a VMware Cloud on AWS SDDC.	Follow the instructions in <a href="#">Deploy a VMware SDDC on AWS by using VMware Cloud on AWS</a> in AWS Prescriptive Guidance.	Cloud architect, Cloud administrator
Sign up for VMware Aria Operations for Logs.	For instructions, see the <a href="#">VMware documentation</a> .	Cloud architect

### Deploy a cloud proxy

Task	Description	Skills required
Deploy a cloud proxy.	<p>To forward logs to an on-premises instance of Splunk, you must add a cloud proxy for VMware Aria Operations for Logs. This proxy receives information from the on-premises data center and sends it to VMware Aria Operations for Logs for analysis.</p> <p>To download and install the cloud proxy:</p> <ol style="list-style-type: none"> <li>1. Make sure that ports 443, 22, and 514 are open between your on-premises environment and</li> </ol>	Cloud administrator, Cloud architect

Task	Description	Skills required
	<p>VMware Cloud on AWS. For additional ports, you can use 1514/TCP or 6514/TCP. For more information about ports, see <a href="#">VMware Aria Operations for Logs Firewall Recommendations</a> in the VMware documentation.</p> <ol style="list-style-type: none"><li data-bbox="592 646 1027 730">2. Log in to VMware Aria Operations for Logs.</li><li data-bbox="592 751 1027 888">3. On the home page, choose <b>Add Collector</b> in the widget.</li><li data-bbox="592 909 1027 1182">4. On the <b>Cloud Proxy Virtual Appliance</b> screen, copy the token key. You must use this key within 24 hours to finish the following steps.</li><li data-bbox="592 1203 1027 1287">5. Choose the download link for the OVA file.</li><li data-bbox="592 1308 1027 1539">6. Navigate to VMware vSphere web client, choose your cluster, and then select <b>Deploy OVF template</b>.</li><li data-bbox="592 1560 1027 1728">7. When you're prompted for the key, paste the token key that you copied in step 4.</li><li data-bbox="592 1749 1027 1833">8. Choose <b>Finish</b> to install the cloud proxy.</li></ol>	

## Forward logs to an on-premises Splunk endpoint

Task	Description	Skills required
Configure log forwarding.	<p>To forward logs to the Splunk endpoint:</p> <ol style="list-style-type: none"><li>1. Log in to VMware Aria Operations for Logs.</li><li>2. Navigate to <b>Log Management</b>.</li><li>3. Choose <b>Log Forwarding</b>.</li><li>4. Choose <b>New Configuration</b>, and complete the following settings:<ul style="list-style-type: none"><li>• Provide a name for the log forwarding configuration.</li><li>• For <b>Destination</b>, choose <b>On Premises</b>.</li><li>• For <b>Cloud Proxy</b>, select the cloud proxy that you installed earlier.</li><li>• For <b>Endpoint Type</b>, choose <b>TCP</b>.</li><li>• For <b>Endpoint URL</b>, provide your on-premises Splunk URL in the format: <pre>tcp://x.x.x.x (your Splunk IP address): 514</pre></li><li>• (Optional) For <b>Tags</b>, you can specify tag names</li></ul></li></ol>	

Task	Description	Skills required
	<p>and values to facilitate querying.</p> <ul style="list-style-type: none"><li>• Choose <b>Apply to all logs</b> or <b>Apply to specific logs</b>. If you want to send all VMware Cloud on AWS logs to Splunk, choose <b>Apply to all logs</b>.</li></ul> <p>5. Choose <b>Verify</b>.</p> <p>6. Choose <b>Save</b>.</p> <p>For more information, see <a href="#">Forward Logs from VMware Aria Operations for Logs</a> in the VMware documentation.</p>	

## Related resources

- [VMware Cloud on AWS website](#)
- [About Software-Defined Data Centers](#) (VMware documentation)
- [Deploy a VMware SDDC on AWS by using VMware Cloud on AWS](#) (AWS Prescriptive Guidance)
- [Migrate workloads to the VMware Cloud on AWS by using VMware HCX](#) (AWS Prescriptive Guidance)
- [Configure a data center extension to VMware Cloud on AWS using Hybrid Linked Mode](#) (AWS Prescriptive Guidance)



# Set up a CI/CD pipeline for hybrid workloads on Amazon ECS Anywhere by using AWS CDK and GitLab

Created by Dr. Rahul Sharad Gaikwad (AWS)

<b>Code repository:</b> <a href="#">amazon-ec-s-anywhere-cicd-pipeline-cdk-sample</a>	<b>Environment:</b> PoC or pilot	<b>Technologies:</b> Hybrid cloud; Containers & microservices; Infrastructure; DevOps
<b>Workload:</b> Open-source	<b>AWS services:</b> AWS CDK; AWS CodePipeline; Amazon ECS; AWS Systems Manager; AWS CodeCommit	

## Summary

Amazon ECS Anywhere is an extension of the Amazon Elastic Container Service (Amazon ECS). It provides support for registering an *external instance*, such as an on-premises server or virtual machine (VM), to your Amazon ECS cluster. This feature helps reduce costs and mitigate complex local container orchestration and operations. You can use ECS Anywhere to deploy and run container applications in both on-premises and cloud environments. It removes the need for your team to learn multiple domains and skill sets, or to manage complex software on their own.

This pattern describes a step-by-step approach to provision an Amazon ECS cluster with Amazon ECS Anywhere instances by using Amazon Web Services (AWS) Cloud Development Kit (AWS CDK) stacks. You then use AWS CodePipeline to set up a continuous integration and continuous deployment (CI/CD) pipeline. Then, you replicate your GitLab code repository to AWS CodeCommit and deploy your containerized application on the Amazon ECS cluster.

This pattern is designed to help those who use on-premises infrastructure to run container applications and use GitLab to manage the application code base. You can manage those workloads by using AWS Cloud services, without disturbing your existing, on-premises infrastructure.

## Prerequisites and limitations

### Prerequisites

- An active AWS account.
- A container application running on on-premises infrastructure.
- A GitLab repository where you manage your application code base. For more information, see [Repository](#) (GitLab).
- AWS Command Line Interface (AWS CLI), installed and configured. For more information, see [Installing or updating the latest version of the AWS CLI](#) (AWS CLI documentation).
- AWS CDK Toolkit, installed and configured globally. For more information, see [Install the AWS CDK](#) (AWS CDK documentation).
- npm, installed and configured for the AWS CDK in TypeScript. For more information, see [Downloading and installing Node.js and npm](#) (npm documentation).

## Limitations

- For limitations and considerations, see [External instances \(Amazon ECS Anywhere\)](#) in the Amazon ECS documentation.

## Product versions

- AWS CDK Toolkit version 2.27.0 or later
- npm version 7.20.3 or later
- Node.js version 16.6.1 or later

## Architecture

### Target technology stack

- AWS CDK
- AWS CloudFormation
- AWS CodeBuild
- AWS CodeCommit
- AWS CodePipeline
- Amazon ECS Anywhere
- Amazon Elastic Container Registry (Amazon ECR)
- AWS Identity and Access Management (IAM)

- AWS System Manager
- GitLab repository

**Target architecture**

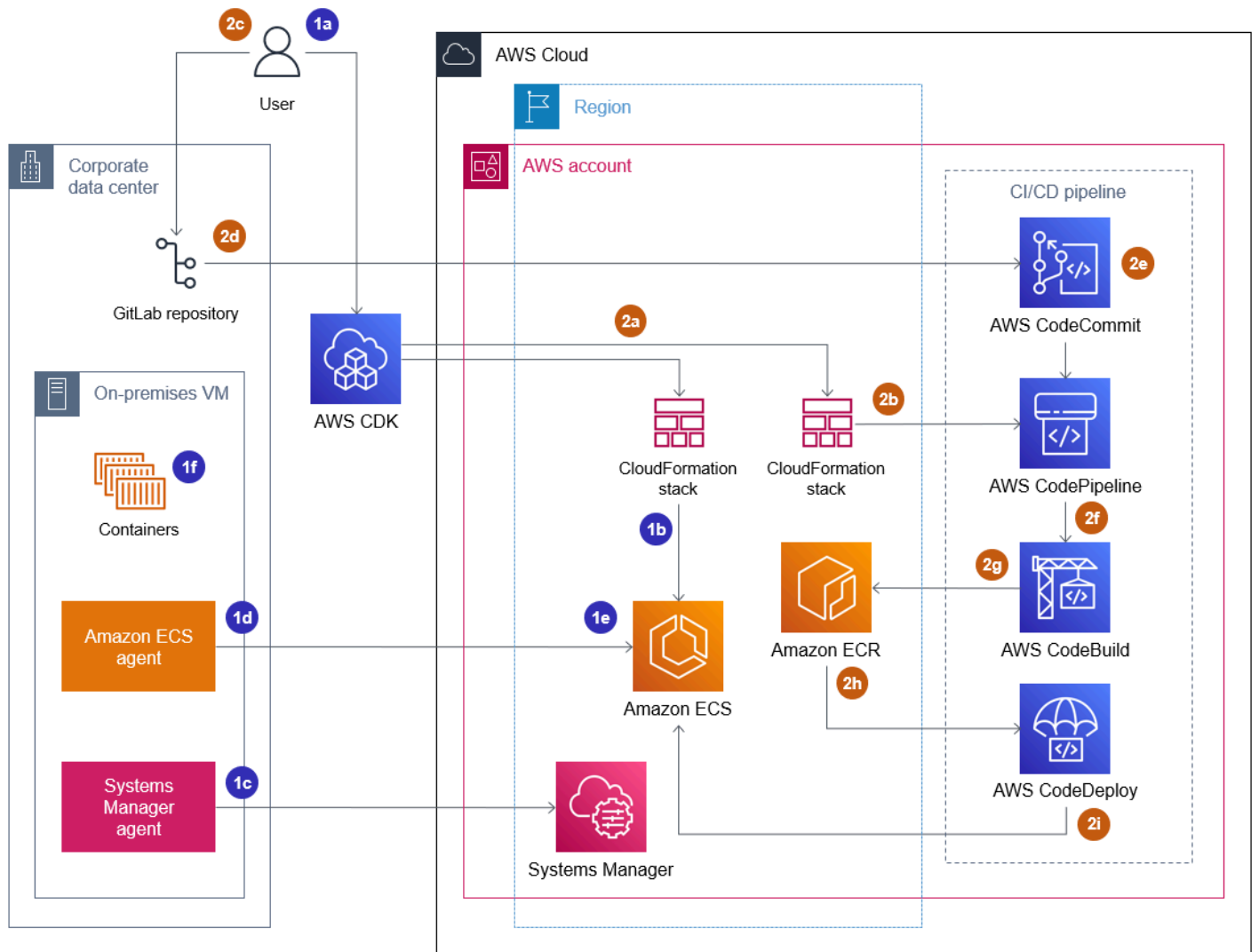

This diagram represents two primary workflows described in this pattern, provisioning the Amazon ECS cluster and setting up the CI/CD pipeline that sets up and deploys the CI/CD pipeline, as follows:

**1. Provisioning the Amazon ECS cluster**

- When you deploy the first AWS CDK stack, it creates a CloudFormation stack on AWS.
- This CloudFormation stack provisions an Amazon ECS cluster and related AWS resources.

- c. To register an external instance with an Amazon ECS cluster, you must install AWS Systems Manager Agent (SSM Agent) on your VM and register the VM as an AWS Systems Manager managed instance.
- d. You must also install the Amazon ECS container agent and Docker on your VM to register it as an external instance with the Amazon ECS cluster.
- e. When the external instance is registered and configured with the Amazon ECS cluster, it can run multiple containers on your VM, which is registered as an external instance.
- f. The Amazon ECS cluster is active and can run the application workloads through containers. The Amazon ECS Anywhere container instance runs in on-premises environment but is associated with the Amazon ECS cluster in the cloud.

## 2. Setting up and deploying the CI/CD pipeline

- a. When you deploy the second AWS CDK stack, it creates another CloudFormation stack on AWS.
- b. This CloudFormation stack provisions a pipeline in CodePipeline and related AWS resources.
- c. You push and merge application code changes to an on-premises GitLab repository.
- d. The GitLab repository is automatically replicated to the CodeCommit repository.
- e. The updates to the CodeCommit repo automatically starts CodePipeline.
- f. CodePipeline copies code from CodeCommit and creates the deployable application build in CodeBuild.
- g. CodePipeline creates a Docker image of the CodeBuild build environment and pushes it to the Amazon ECR repo.
- h. CodePipeline initiates CodeDeploy actions that pull the container image from the Amazon ECR repo.
- i. CodePipeline deploys the container image on the Amazon ECS cluster.

### Automation and scale

This pattern uses the AWS CDK as an infrastructure as code (IaC) tool to configure and deploy this architecture. AWS CDK helps you orchestrate the AWS resources and set up Amazon ECS Anywhere and the CI/CD pipeline.

## Tools

### **AWS services**

- [AWS Cloud Development Kit \(AWS CDK\)](#) is a software development framework that helps you define and provision AWS Cloud infrastructure in code.
- [AWS CodeCommit](#) is a version control service that helps you privately store and manage Git repositories, without needing to manage your own source control system.
- [AWS CodePipeline](#) helps you quickly model and configure the different stages of a software release and automate the steps required to release software changes continuously.
- [AWS Command Line Interface \(AWS CLI\)](#) is an open-source tool that helps you interact with AWS services through commands in your command-line shell.
- [Amazon Elastic Container Registry \(Amazon ECR\)](#) is a managed container image registry service that's secure, scalable, and reliable.
- [Amazon Elastic Container Service \(Amazon ECS\)](#) is a fast and scalable container management service that helps you run, stop, and manage containers on a cluster. This pattern also uses [Amazon ECS Anywhere](#), which provides support for registering an on-premises server or VM to your Amazon ECS cluster.

## Other tools

- [Node.js](#) is an event-driven JavaScript runtime environment designed for building scalable network applications.
- [npm](#) is a software registry that runs in a Node.js environment and is used to share or borrow packages and manage deployment of private packages.
- [Vagrant](#) is an open-source utility for building and maintaining portable virtual software development environments. For demonstration purposes, this pattern uses Vagrant to create an on-premises VM.

## Code repository

The code for this pattern is available in the GitHub [CI/CD pipeline for Amazon ECS Anywhere using AWS CDK](#) repository.

## Best practices

Consider the following best practices when deploying this pattern:

- [Best practices for developing and deploying cloud infrastructure with the AWS CDK](#)
- [Best practices for developing cloud applications with AWS CDK](#) (AWS blog post)

# Epics

## Verify the AWS CDK configuration

Task	Description	Skills required
Verify the AWS CDK version.	<p>Verify the version of the AWS CDK Toolkit by entering the following command.</p> <pre>cdk --version</pre> <p>This pattern requires version 2.27.0 or later. If you have an earlier version, follow the instructions in the <a href="#">AWS CDK documentation</a> to update it.</p>	DevOps engineer
Verify the npm version.	<p>Verify the version of npm by entering the following command.</p> <pre>npm --version</pre> <p>This pattern requires version 7.20.3 or later. If you have an earlier version, follow the instructions in the <a href="#">npm documentation</a> to update it.</p>	DevOps engineer
Set up AWS credentials.	<p>Set up AWS credentials by entering the <code>aws configure</code> command and following the prompts.</p> <pre>\$aws configure</pre>	DevOps engineer

Task	Description	Skills required
	<p>AWS Access Key ID [None]: &lt;your-access-key-ID&gt;</p> <p>AWS Secret Access Key [None]: &lt;your-secret-access-key&gt;</p> <p>Default region name [None]: &lt;your-Region-name&gt;</p> <p>Default output format [None]:</p>	

## Bootstrap the AWS CDK environment

Task	Description	Skills required
<p>Clone the AWS CDK code repository.</p>	<ol style="list-style-type: none"> <li>Clone the <a href="#">CI/CD pipeline for Amazon ECS Anywhere using AWS CDK</a> repository for this pattern by entering the following command.           <pre data-bbox="630 1213 1029 1455">git clone https://github.com/aws-samples/amazon-ecs-anywhere-cicd-pipeline-cdk-sample.git</pre> </li> <li>Navigate into the cloned directory by entering the following command.           <pre data-bbox="630 1633 1029 1793">cd amazon-ecs-anywhere-cicd-pipeline-cdk-sample</pre> </li> </ol>	<p>DevOps engineer</p>

Task	Description	Skills required
Bootstrap the environment.	<p>Deploy the CloudFormation template to the account and AWS Region that you want to use by entering the following command.</p> <pre>cdk bootstrap &lt;account-number&gt;/&lt;Region&gt;</pre> <p>For more information, see <a href="#">Bootstrapping</a> in the AWS CDK documentation.</p>	DevOps engineer

## Build and deploy the infrastructure for Amazon ECS Anywhere

Task	Description	Skills required
Install the package dependencies and compile the TypeScript files.	<p>Install the package dependencies and compile the TypeScript files by entering the following commands.</p> <pre>\$cd EcsAnywhereCdk \$npm install \$npm fund</pre> <p>These commands install all the packages from the sample repository. For more information, see <a href="#">npm ci</a> and <a href="#">npm install</a> in the npm documentation. If you get any errors about missing packages when</p>	DevOps engineer



Task	Description	Skills required
	you enter these commands, see the <a href="#">Troubleshooting</a> section of this pattern.	
Build the project.	<p>To build the project code, enter the following command.</p> <pre>npm run build</pre> <p>For more information about building and deploying the project, see <a href="#">Your first AWS CDK app</a> in the AWS CDK documentation.</p>	DevOps engineer
Deploy the Amazon ECS Anywhere infrastructure stack.	<ol style="list-style-type: none"><li>1. List the stacks by entering the following command.<pre>\$cdk list</pre></li><li>2. Confirm that the output returns the <code>EcsAnywhereInfraStack</code> and <code>ECSAnywherePipelineStack</code> stacks.</li><li>3. Deploy the <code>EcsAnywhereInfraStack</code> stack by entering the following command.<pre>\$cdk deploy EcsAnywhereInfraStack</pre></li></ol>	DevOps engineer

Task	Description	Skills required
Verify stack creation and output.	<ol style="list-style-type: none"> <li>1. Sign in to the AWS Management Console and open the CloudFormation console at <a href="https://console.aws.amazon.com/cloudformation/">https://console.aws.amazon.com/cloudformation/</a>.</li> <li>2. On the <b>Stacks</b> page, select the <code>EcsAnywhereInfraStack</code> stack.</li> <li>3. Confirm that the stack status is either <code>CREATE_IN_PROGRESS</code> or <code>CREATE_COMPLETE</code>.</li> </ol> <p>Setting up the Amazon ECS cluster can take some time. Do not proceed until the stack creation is complete.</p>	DevOps engineer

## Set up an on-premises VM

Task	Description	Skills required
Set up your VM.	Create a Vagrant VM by entering the <code>vagrant up</code> command from the root directory where <code>Vagrantfile</code> is located. For more information, see the <a href="#">Vagrant documentation</a> .	DevOps engineer
Register your VM as an external instance.	1. Log in to the Vagrant VM by using the <code>vagrant ssh</code> command. For more	DevOps engineer

Task	Description	Skills required
	<p>information, see the <a href="#">Vagrant documentation</a>.</p> <ol style="list-style-type: none"><li>2. Install AWS CLI on the VM by following <a href="#">AWS CLI installation instructions</a> and entering the following commands.</li></ol> <pre data-bbox="634 579 1029 1451">\$ curl "https://awscli.amazonaws.com/awscli-exe-linux-x86_64.zip" \ &gt; -o "awscliv2.zip" \$sudo apt install unzip \$unzip awscliv2.zip \$sudo ./aws/install \$aws configure AWS Access Key ID [None]: &lt;your-access-key-ID&gt; AWS Secret Access Key [None]: &lt;your-secret-access-key&gt; Default region name [None]: &lt;your-Region-name&gt; Default output format [None]:</pre> <ol style="list-style-type: none"><li>1. Create an activation code and ID that you can use to register your VM with AWS Systems Manager and to activate your external instance. The output from this command includes the</li></ol>	

Task	Description	Skills required
	<p>activation ID and activation code values.</p> <pre>aws ssm create-activation \ &gt; --iam-role EcsAnywhereInstanceRole \ &gt;   tee ssm-activation.json</pre> <p>If you receive an error when you run this command, see the <a href="#">Troubleshooting</a> section.</p> <p>2. Export the activation ID and code values.</p> <pre>export ACTIVATION_ID=&lt;activation-ID&gt; export ACTIVATION_CODE=&lt;activation-code&gt;</pre> <p>3. Download the installation script to your VM.</p> <pre>curl --proto "https" -o "ecs-anywhere-install.sh" \ &gt; "https://amazon-ecs-agent.s3.amazonaws.com/ecs-anywhere-install-latest.sh"</pre> <p>4. Run the installation script on your VM.</p>	

Task	Description	Skills required
	<pre data-bbox="634 226 1027 646">sudo bash ecs-anywhere-install.sh \ --cluster EcsAnywhereCluster \ --activation-id \$ACTIVATION_ID \ --activation-code \$ACTIVATION_CODE \ --region &lt;region-name&gt;</pre> <p data-bbox="589 716 1027 1230">This sets up your VM as an Amazon ECS Anywhere external instance and registers the instance in the Amazon ECS cluster. For more information, see <a href="#">Registering an external instance to a cluster</a> in the Amazon ECS documentation. If you experience any issues, see the <a href="#">Troubleshooting</a> section.</p>	
Verify the status of Amazon ECS Anywhere and the external VM.	<p data-bbox="589 1297 1027 1476">To verify whether your VM is connected to the Amazon ECS control plane and running, use the following commands.</p> <pre data-bbox="597 1518 1027 1749">\$aws ssm describe-instance-information \$aws ecs list-container-instances --cluster \$CLUSTER_NAME</pre>	DevOps engineer

## Deploy the CI/CD pipeline

Task	Description	Skills required
Create a branch in the CodeCommit repo.	<p>Create a branch named main in the CodeCommit repo by creating the first commit for the repository. You can follow AWS documentation to <a href="#">Create a commit in CodeCommit</a>. The following command is an example.</p> <pre data-bbox="594 730 1027 1329">aws codecommit put-file \   --repository-name EcsAnywhereRepo \   --branch-name main \   --file-path README.md \   --file-content "Test" \   --name "Dev Ops" \   --email "devops@example.com" \   --commit-message "Adding README."</pre>	DevOps engineer
Set up repo mirroring.	<p>You can mirror a GitLab repository to and from external sources. You can select which repository serves as the source. Branches, tags, and commits are synced automatically. Set up a push mirror between the GitLab repository that hosts your application and the CodeCommit repository.</p>	DevOps engineer

Task	Description	Skills required
	<p>For instructions, see <a href="#">Set up a push mirror from GitLab to CodeCommit</a> (GitLab documentation).</p> <p><b>Note:</b> By default, mirroring automatically syncs the repository. If you want to manually update the repositories, see <a href="#">Update a mirror</a> (GitLab documentation).</p>	
Deploy the CI/CD pipeline stack.	<p>Deploy the EcsAnywherePipelineStack stack by entering the following command.</p> <pre data-bbox="597 1016 1029 1136">\$cdk deploy EcsAnywherePipelineStack</pre>	DevOps engineer

Task	Description	Skills required
Test the CI/CD pipeline.	<ol style="list-style-type: none"><li data-bbox="591 226 1027 737">1. Make application code changes and push it to the source, on-premises GitLab repo. For more information, see <a href="#">Push Options</a> (GitLab documentation). For example, edit the <code>../application/index.html</code> file to update the application version value.</li><li data-bbox="591 764 1027 1682">2. When the code is replicated to the CodeCommit repo, this starts the CI/CD pipeline. Do one of the following:<ul style="list-style-type: none"><li data-bbox="630 1016 1027 1325">• If you are using automatic mirroring to synchronize the GitLab repo with the CodeCommit repo, continue to the next step.</li><li data-bbox="630 1352 1027 1682">• If you are using manual mirroring, push the application code changes to the CodeCommit repo by following the instructions in <a href="#">Update a mirror</a> (GitLab documentation).</li></ul></li><li data-bbox="591 1709 1027 1877">3. On your local machine, in a web browser, enter <a href="http://localhost:80">http://localhost:80</a>. This opens the NGINX web</li></ol>	DevOps engineer



Task	Description	Skills required
	<p>page because port 80 is forwarded to localhost in Vagrantfile. Confirm that you can view the updated application version value. This validates the pipeline and image deployment.</p> <p>4. (Optional) If you want to verify the deployment in the AWS Management Console, do the following:</p> <ol style="list-style-type: none"> <li>a. Open the Amazon ECS console at <a href="https://console.aws.amazon.com/ecs/">https://console.aws.amazon.com/ecs/</a>.</li> <li>b. From the navigation bar, select the Region to use.</li> <li>c. In the navigation pane, choose <b>Clusters</b>.</li> <li>d. On the <b>Clusters</b> page, select the <b>EcsAnywhereCluster</b> cluster.</li> <li>e. Choose <b>Task Definitions</b>.</li> <li>f. Confirm the container is running.</li> </ol>	

## Clean up

Task	Description	Skills required
Clean up and delete the resources.	After you walk through this pattern, you should	DevOps engineer

Task	Description	Skills required
	<p>remove the proof-of-concept resources you created. To clean up, enter the following commands.</p> <pre>\$cdk destroy EcsAnywherePipelineStack \$cdk destroy EcsAnywhereInfraStack</pre>	

## Troubleshooting

Issue	Solution
Errors about missing packages when installing package dependencies.	<p>Enter one of the following commands to resolve missing packages.</p> <pre>\$npm ci</pre> <p>or</p> <pre>\$npm install -g @aws-cdk/&lt;package_name&gt;</pre>
<p>When you run the <code>aws ssm create-activation</code> command on the VM, you receive the following error.</p> <pre>An error occurred (ValidationException) when calling the CreateActivation operation: Nonexistent role or missing ssm service principal in trust policy:</pre>	<p>The <code>EcsAnywhereInfraStack</code> stack isn't fully deployed, and the IAM role necessary to run this command hasn't been created yet. Check the stack status in the CloudFormation console. Retry the command after the status changes to <code>CREATE_COMPLETE</code>.</p>

Issue	Solution
<p data-bbox="115 212 708 296">arn:aws:iam::000000000000:role/EcsAnywhereInstanceRole</p> <p data-bbox="115 342 776 516">An Amazon ECS health check returns <code>UNHEALTHY</code> , and you see the following error in the <b>Services</b> section of the cluster in the Amazon ECS console.</p> <p data-bbox="115 562 748 842">service EcsAnywhereService was unable to place a task because no container instance met all of its requirements. Reason: No Container Instances were found in your cluster.</p>	<p data-bbox="829 342 1393 468">Restart the Amazon ECS agent on your Vagrant VM by entering the following commands.</p> <pre data-bbox="829 506 1507 667">\$vagrant ssh \$sudo systemctl restart ecs \$sudo systemctl status ecs</pre>

## Related resources

- [Amazon ECS Anywhere marketing page](#)
- [Amazon ECS Anywhere documentation](#)
- [Amazon ECS Anywhere demo](#) (video)
- [Amazon ECS Anywhere workshop samples](#) (GitHub)
- [Repository mirroring](#) (GitLab documentation)

## More patterns

- [Automate the setup of inter-Region peering with AWS Transit Gateway](#)
- [Manage on-premises container applications by setting up Amazon ECS Anywhere with the AWS CDK](#)
- [Migrate Hadoop data to Amazon S3 by using WANdisco LiveData Migrator](#)
- [Migrate VMware VMs with HCX Automation by using PowerCLI](#)
- [Migrate workloads to the VMware Cloud on AWS by using VMware HCX](#)
- [Modify HTTP headers when you migrate from F5 to an Application Load Balancer on AWS](#)
- [Rehost on-premises workloads in the AWS Cloud: migration checklist](#)
- [Use BMC Discovery queries to extract migration data for migration planning](#)
- [Use Serverspec for test-driven development of infrastructure code](#)

# Infrastructure

## Topics

- [Access a bastion host by using Session Manager and Amazon EC2 Instance Connect](#)
- [Centralize DNS resolution by using AWS Managed Microsoft AD and on-premises Microsoft Active Directory](#)
- [Centralize monitoring by using Amazon CloudWatch Observability Access Manager](#)
- [Check EC2 instances for mandatory tags at launch](#)
- [Connect to an Amazon EC2 instance by using Session Manager](#)
- [Create a pipeline in AWS Regions that don't support AWS CodePipeline](#)
- [Deploy a Cassandra cluster on Amazon EC2 with private static IPs to avoid rebalancing](#)
- [Extend VRFs to AWS by using AWS Transit Gateway Connect](#)
- [Get Amazon SNS notifications when the key state of an AWS KMS key changes](#)
- [Mainframe modernization: DevOps on AWS with Micro Focus](#)
- [Preserve routable IP space in multi-account VPC designs for non-workload subnets](#)
- [Provision a Terraform product in AWS Service Catalog by using a code repository](#)
- [Register multiple AWS accounts with a single email address by using Amazon SES](#)
- [Set up DNS resolution for hybrid networks in a multi-account AWS environment](#)
- [Set up DNS resolution for hybrid networks in a single-account AWS environment](#)
- [Set up UiPath RPA bots automatically on Amazon EC2 by using AWS CloudFormation](#)
- [Set up disaster recovery for Oracle JD Edwards EnterpriseOne with AWS Elastic Disaster Recovery](#)
- [Synchronize data between Amazon EFS file systems in different AWS Regions by using AWS DataSync](#)
- [Upgrade SAP Pacemaker clusters from ENSA1 to ENSA2](#)
- [Use consistent Availability Zones in VPCs across different AWS accounts](#)
- [Validate Account Factory for Terraform \(AFT\) code locally](#)
- [More patterns](#)

# Access a bastion host by using Session Manager and Amazon EC2 Instance Connect

Created by Piotr Chotkowski (AWS) and Witold Kowalik (AWS)

**Code repository:** [Access a bastion host by using Session Manager and Amazon EC2 Instance Connect](#)

**Environment:** PoC or pilot

**Technologies:** Infrastructure; Security, identity, compliance; Networking

**AWS services:** Amazon EC2; AWS Systems Manager; Amazon VPC

## Summary

A *bastion host*, sometimes called a *jump box*, is a server that provides a single point of access from an external network to the resources located in a private network. A server exposed to an external public network, such as the internet, poses a potential security risk for unauthorized access. It's important to secure and control access to these servers.

This pattern describes how you can use [Session Manager](#) and [Amazon EC2 Instance Connect](#) to securely connect to an Amazon Elastic Compute Cloud (Amazon EC2) bastion host deployed in your AWS account. Session Manager is a capability of AWS Systems Manager. The benefits of this pattern include:

- The deployed bastion host doesn't have any open, inbound ports exposed to the public internet. This reduces the potential attack surface.
- You don't need to store and maintain long-term Secure Shell (SSH) keys in your AWS account. Instead, each user generates a new SSH key pair each time they connect to the bastion host. AWS Identity and Access Management (IAM) policies that are attached to the user's AWS credentials control access to the bastion host.

## Intended audience

This pattern is intended for readers who have experience with basic understanding of Amazon EC2, Amazon Virtual Private Cloud (VPC), and Hashicorp Terraform.

## Prerequisites and limitations

### Prerequisites

- An active AWS account
- AWS Command Line Interface (AWS CLI) version 2, [installed](#) and [configured](#)
- Session Manager plugin for the AWS CLI, [installed](#)
- Terraform CLI, [installed](#)
- Storage for the Terraform [state](#), such as an Amazon Simple Storage Service (Amazon S3) bucket and an Amazon DynamoDB table that serve as a remote backend to store the Terraform state. For more information on using remote backends for the Terraform state, see [S3 Backends](#) (Terraform documentation). For a code sample that sets up remote state management with an S3 backend, see [remote-state-s3-backend](#) (Terraform Registry). Note the following requirements:
  - The S3 bucket and DynamoDB table must be in the same AWS Region.
  - When creating the DynamoDB table, the partition key must be LockID (case-sensitive), and the partition key type must be String. All other table settings must be at their default values. For more information, see [About primary keys](#) and [Create a table](#) in the DynamoDB documentation.
- An SSH client, installed

### Limitations

- This pattern is intended as a proof of concept (PoC) or as a basis for further development. It should not be used in its current form in production environments. Before deployment, adjust the sample code in the repository to meet your requirements and use case.
- This pattern assumes that the target bastion host uses Amazon Linux 2 as its operating system. While it is possible to use other Amazon Machine Images (AMIs), other operating systems are out of scope for this pattern.

**Note:** Amazon Linux 2 is nearing end of support. For more information, see the [Amazon Linux 2 FAQs](#).

- In this pattern, the bastion host is located in a private subnet without an NAT gateway and internet gateway. This design isolates the EC2 instance from the public internet. You can add

a specific network configuration that allows it to communicate with the internet. For more information, see [Connect your virtual private cloud \(VPC\) to other networks](#) in the Amazon VPC documentation. Similarly, following the [principle of least privilege](#), the bastion host doesn't have access to any other resources in your AWS account unless you explicitly grant permissions. For more information, see [Resource-based policies](#) in the IAM documentation.

## Product versions

- AWS CLI version 2
- Terraform version 1.3.9

## Architecture

### Target technology stack

- A VPC with a single private subnet
- The following [interface VPC endpoints](#):
  - `amazonaws.<region>.ssm` – The endpoint for the Systems Manager service.
  - `amazonaws.<region>.ec2messages` – Systems Manager uses this endpoint to make calls from SSM Agent to the Systems Manager service.
  - `amazonaws.<region>.ssmmessages` – Session Manager uses this endpoint to connect to your EC2 instance through a secure data channel.
- A `t3.nano` EC2 instance running Amazon Linux 2
- IAM role and instance profile
- Amazon VPC security groups and security group rules for the endpoints and EC2 instance

### Target architecture



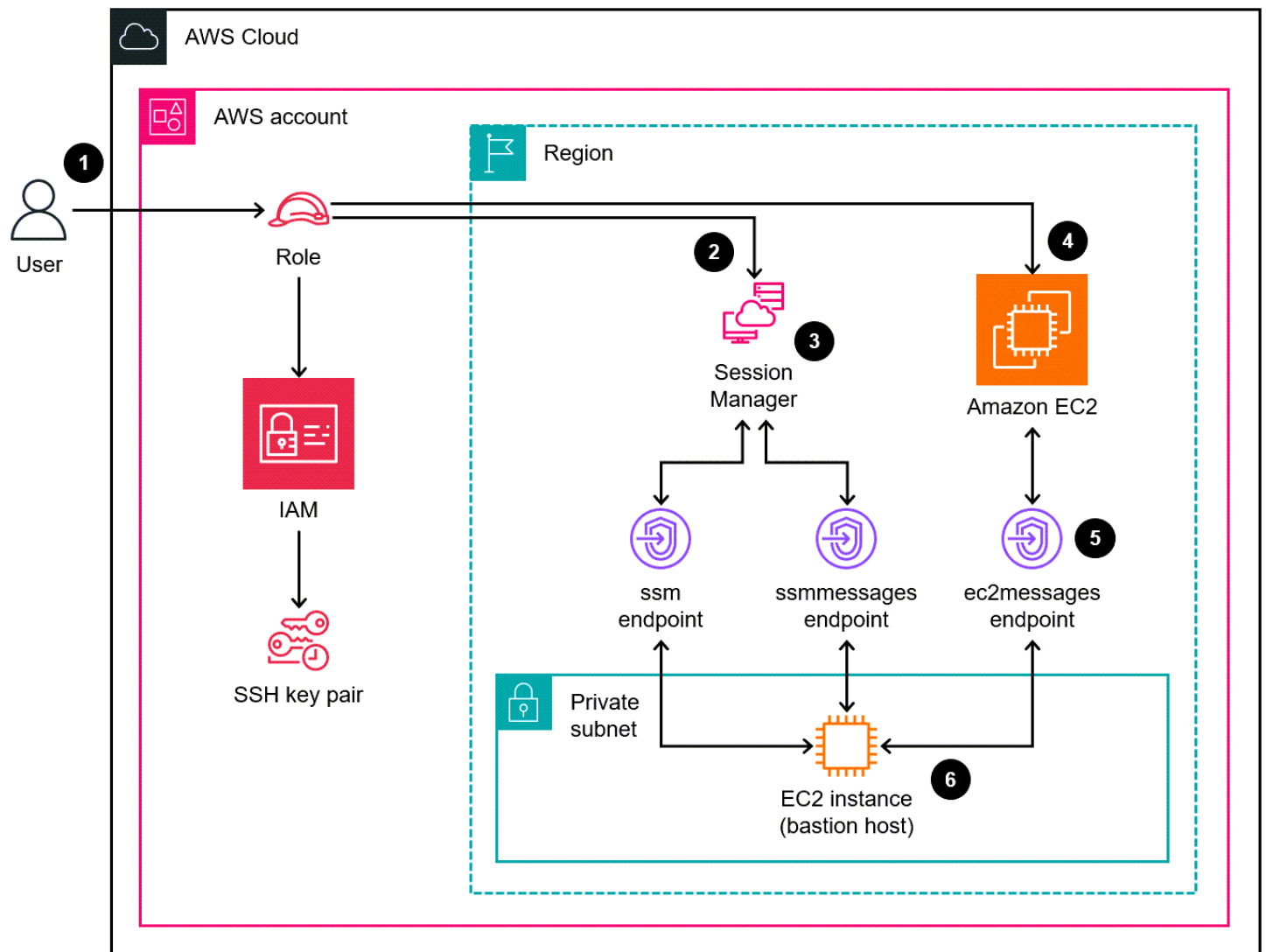

The diagram shows the following process:

1. The user assumes an IAM role that has permissions to do the following:
  - Authenticate, authorize, and connect to the EC2 instance
  - Start a session with Session Manager
2. The user initiates an SSH session through Session Manager.
3. Session Manager authenticates the user, verifies the permissions in the associated IAM policies, checks the configuration settings, and sends a message to SSM Agent to open a two-way connection.
4. The user pushes the SSH public key to the bastion host through Amazon EC2 metadata. This must be done before each connection. The SSH public key remains available for 60 seconds.

5. The bastion host communicates with the interface VPC endpoints for Systems Manager and Amazon EC2.
6. The user accesses the bastion host through Session Manager by using a TLS 1.2 encrypted bidirectional communication channel.

## Automation and scale

The following options are available to automate deployment or to scale this architecture:

- You can deploy the architecture through a continuous integration and continuous delivery (CI/CD) pipeline.
- You can modify the code to change the instance type of the bastion host.
- You can modify the code to deploy multiple bastion hosts. In the `bastion-host/main.tf` file, in the `aws_instance` resource block, add the `count` meta-argument. For more information, see the [Terraform documentation](#).

## Tools

### AWS services

- [AWS Command Line Interface \(AWS CLI\)](#) is an open-source tool that helps you interact with AWS services through commands in your command-line shell.
- [Amazon Elastic Compute Cloud \(Amazon EC2\)](#) provides scalable computing capacity in the AWS Cloud. You can launch as many virtual servers as you need and quickly scale them up or down.
- [AWS Identity and Access Management \(IAM\)](#) helps you securely manage access to your AWS resources by controlling who is authenticated and authorized to use them.
- [AWS Systems Manager](#) helps you manage your applications and infrastructure running in the AWS Cloud. It simplifies application and resource management, shortens the time to detect and resolve operational problems, and helps you manage your AWS resources securely at scale. This pattern uses [Session Manager](#), a capability of Systems Manager.
- [Amazon Virtual Private Cloud \(Amazon VPC\)](#) helps you launch AWS resources into a virtual network that you've defined. This virtual network resembles a traditional network that you'd operate in your own data center, with the benefits of using the scalable infrastructure of AWS.

### Other tools

- [HashiCorp Terraform](#) is an open-source infrastructure as code (IaC) tool that helps you use code to provision and manage cloud infrastructure and resources. This pattern uses [Terraform CLI](#).

## Code repository

The code for this pattern is available in the GitHub [Access a bastion host by using Session Manager and Amazon EC2 Instance Connect](#) repository.

## Best practices

- We recommend using automated code-scanning tools to improve the security and quality of the code. This pattern was scanned by using [Checkov](#), a static code-analysis tool for IaC. At a minimum, we recommend that you perform basic validation and formatting checks by using the `terraform validate` and `terraform fmt -check -recursive` Terraform commands.
- It's a good practice to add automated tests for IaC. For more information about the different approaches for testing Terraform code, see [Testing HashiCorp Terraform](#) (Terraform blog post).
- During deployment, Terraform replaces the EC2 instance each time a new version of the [Amazon Linux 2 AMI](#) is detected. This deploys the new version of the operating system, including patches and upgrades. If the deployment schedule is infrequent, this can pose a security risk because the instance doesn't have the latest patches. It is important to frequently update and apply security patches to deployed EC2 instances. For more information, see [Update management in Amazon EC2](#).
- Because this pattern is a proof of concept, it uses AWS managed policies, such as `AmazonSSMManagedInstanceCore`. AWS managed policies cover common use cases but don't grant least-privilege permissions. As needed for your use case, we recommend that you create custom policies that grant least-privilege permissions for the resources deployed in this architecture. For more information, see [Get started with AWS managed policies and move toward least-privilege permissions](#).
- Use a password to protect access to SSH keys and store keys in a secure location.
- Set up logging and monitoring for the bastion host. Logging and monitoring are important parts of maintaining systems, from both an operational and security perspective. There are multiple ways to monitor connections and activity in your bastion host. For more information, see the following topics in the Systems Manager documentation:
  - [Monitoring AWS Systems Manager](#)
  - [Logging and monitoring in AWS Systems Manager](#)

- [Auditing session activity](#)
- [Logging session activity](#)

## Epics

### Deploy the resources

Task	Description	Skills required
Clone the code repository.	<ol style="list-style-type: none"> <li>1. In a command-line interface, change your working directory to the location where you want to store the sample files.</li> <li>2. Enter the following command.</li> </ol> <pre>git clone https://github.com/aws-samples/secured-bastion-host-terraform.git</pre>	DevOps engineer, Developer
Initialize the Terraform working directory.	<p>This step is necessary for only the first deployment. If you are redeploying the pattern, skip to the next step.</p> <p>In the root directory of the cloned repository, enter the following command, where:</p> <ul style="list-style-type: none"> <li>• <code>\$S3_STATE_BUCKET</code> is the name of S3 bucket that contains the Terraform state</li> </ul>	DevOps engineer, Developer, Terraform

Task	Description	Skills required
	<ul style="list-style-type: none"><li>• <code>\$PATH_TO_STATE_FILE</code> is the key to the Terraform state file, such as <code>infra/bastion-host/tetfstate</code></li><li>• <code>\$AWS_REGION</code> is the Region where the S3 bucket is deployed</li></ul> <pre data-bbox="597 667 1026 1066">terraform init \     -backend-config="bucket=\$S3_STATE_BUCKET" \     -backend-config="key=\$PATH_TO_STATE_FILE" \     -backend-config="region=\$AWS_REGION</pre> <p data-bbox="591 1100 997 1327"><b>Note:</b> Alternatively, you can open the <code>config.tf</code> file and, in the <code>terraform</code> section, manually provide these values.</p>	

Task	Description	Skills required
Deploy the resources.	<ol style="list-style-type: none"> <li>1. In the root directory of the cloned repository, enter the following command. <div style="border: 1px solid #ccc; border-radius: 10px; padding: 10px; margin: 10px 0;"> <pre>terraform apply -var-file="dev.tfvars"</pre> </div> </li> <li>2. Review the list of all changes that will be applied to your AWS account, and then confirm the deployment.</li> <li>3. Wait until all resources are deployed.</li> </ol>	DevOps engineer, Developer, Terraform

## Set up the local environment

Task	Description	Skills required
Configure the SSH connection.	Update the SSH configuration file to allow SSH connections through Session Manager. For instructions, see <a href="#">Allowing SSH connections for Session Manager</a> . This allows authorized users to enter a proxy command that starts a Session Manager session and transfers all data through a two-way connection.	DevOps engineer
Generate the SSH keys.	Enter the following command to generate a local private and public SSH key pair. You	DevOps engineer, Developer

Task	Description	Skills required
	<p>use this key pair to connect to the bastion host.</p> <pre>ssh-keygen -t rsa -f my_key</pre>	

## Connect to the bastion host by using Session Manager

Task	Description	Skills required
Get the instance ID.	<ol style="list-style-type: none"><li>1. In order to connect to the deployed bastion host, you need the ID of the EC2 instance. Do one of the following to locate the ID:<ul style="list-style-type: none"><li>• Open the Amazon EC2 console at <a href="https://console.aws.amazon.com/ec2/">https://console.aws.amazon.com/ec2/</a>. In the navigation pane, choose <b>Instances</b>. Locate the bastion host instance.</li><li>• In the AWS CLI, enter the following command.<pre>aws ec2 describe-instances</pre></li></ul></li></ol> <p>To filter the results, enter the following command, where <code>\$BASTION_HOST_TAG</code> is the tag you assigned to the bastion host. The default</p>	General AWS

Task	Description	Skills required
	<p>value for this tag is sandbox-dev-bastio n-host .</p> <pre data-bbox="662 380 1029 894">aws ec2 describe- instances \   --filters   "Name=tag:Name,Val ues=\$BASTION_HOST_ TAG" \   --output text \   --query   'Reservations[*].I nstances[*].Instan ceId' \   --output text</pre>	

2. Copy the ID of the EC2 instance. You use this ID later.



Task	Description	Skills required
Send the SSH public key.	<p><b>Note:</b> In this section, you upload the public key to the <a href="#">instance metadata</a> of the bastion host. After the key is uploaded, you have 60 seconds to start a connection with the bastion host. After 60 seconds, the public key is removed. For more information, see the <a href="#">Troubleshooting</a> section of this pattern. Complete the next steps quickly to prevent the key from being removed before you connect to the bastion host.</p> <ol style="list-style-type: none"><li>1. Send the SSH key to the bastion host by using EC2 Instance Connect. Enter the following command, where:<ul style="list-style-type: none"><li>• <code>\$INSTANCE_ID</code> is the ID of the EC2 instance</li><li>• <code>\$PUBLIC_KEY_FILE</code> is the path to your public key file, such as <code>my_key.pub</code></li></ul></li></ol> <p><b>Important:</b> Be sure to use the public key and not the private key.</p>	General AWS

Task	Description	Skills required
	<pre>aws ec2-instance- connect send-ssh- public-key \   --instance-id   \$INSTANCE_ID \   --instance-os- user ec2-user \   --ssh-public-key   file://\$PUBLIC_KEY   _FILE</pre> <p>2. Wait until you receive a message indicating that the key has been successfully uploaded. Continue to the next step immediately.</p>	

Task	Description	Skills required
Connect to the bastion host.	<ol style="list-style-type: none"><li data-bbox="592 226 1027 714">1. Enter the following command to connect to the bastion host through Session Manager, where:<ul style="list-style-type: none"><li data-bbox="630 428 990 609">• <code>\$PRIVATE_KEY_FILE</code> is the path to your private key, such as <code>my_key</code></li><li data-bbox="630 630 990 714">• <code>\$INSTANCE_ID</code> is the ID of the EC2 instance</li></ul></li></ol> <pre data-bbox="630 745 1027 909">ssh -i \$PRIVATE_KEY_FILE ec2-user@\$INSTANCE_ID</pre> <ol style="list-style-type: none"><li data-bbox="592 924 1027 1104">2. Confirm the connection by entering <code>yes</code>. This opens an SSH connection by using Session Manager.</li></ol> <p data-bbox="592 1176 1027 1596"><b>Note:</b> There are other options for opening an SSH connection with the bastion host. For more information, see <i>Alternative approaches to establish an SSH connection with the bastion host</i> in the <a href="#">Additional information</a> section of this pattern.</p>	General AWS

**(Optional) Clean up**

Task	Description	Skills required
Remove the deployed resources.	<ol style="list-style-type: none"> <li>In order to remove all deployed resources, run the following command from the root directory of the cloned repository. <div style="border: 1px solid #ccc; border-radius: 10px; padding: 10px; margin: 10px 0;"> <pre>terraform destroy - var-file="dev.tfvars"</pre> </div> </li> <li>Confirm the removal of the resources.</li> </ol>	DevOps engineer, Developer, Terraform

**Troubleshooting**

Issue	Solution
TargetNotConnected error when trying to connect to the bastion host	<ol style="list-style-type: none"> <li>Reboot the bastion host according to the instructions in <a href="#">Reboot your instance</a> in the Amazon EC2 documentation.</li> <li>After the instance has successfully rebooted, resend the public key to the bastion host and reattempt the connection.</li> </ol>
Permission denied error when trying to connect to the bastion host	After the public key is uploaded to the bastion host, you have only 60 seconds to start the connection. After 60 seconds, the key is automatically removed, and you can't use it to connect to the instance. If this occurs, you can repeat the step to resend the key to the instance.

## Related resources

### AWS documentation

- [AWS Systems Manager Session Manager](#) (Systems Manager documentation)
- [Install the Session Manager plugin for the AWS CLI](#) (Systems Manager documentation)
- [Allowing SSH connections for Session Manager](#) (Systems Manager documentation)
- [About using EC2 Instance Connect](#) (Amazon EC2 documentation)
- [Connect using EC2 Instance Connect](#) (Amazon EC2 documentation)
- [Identity and access management for Amazon EC2](#) (Amazon EC2 documentation)
- [Using an IAM role to grant permissions to applications running on Amazon EC2 instances](#) (IAM documentation)
- [Security best practices in IAM](#) (IAM documentation)
- [Control traffic to resources using security groups](#) (Amazon VPC documentation)

### Other resources

- [Terraform Developer webpage](#)
- [Command: validate](#) (Terraform documentation)
- [Command: fmt](#) (Terraform documentation)
- [Testing HashiCorp Terraform](#) (HashiCorp blog post)
- [Checkov webpage](#)

## Additional information

### Alternative approaches to establish an SSH connection with the bastion host

#### *Port forwarding*

You can use the `-D 8888` option to open an SSH connection with dynamic port forwarding. For more information, see [these instructions](#) at explainshell.com. The following is an example of a command to open an SSH connection by using port forwarding.

```
ssh -i $PRIVATE_KEY_FILE -D 8888 ec2-user@$INSTANCE_ID
```

This kind of connection opens a SOCKS proxy that can forward traffic from your local browser through the bastion host. If you are using Linux or MacOS, to see all options, enter `man ssh`. This displays the SSH reference manual.

### *Using the provided script*

Instead of manually running the steps described in *Connect to the bastion host by using Session Manager* in the [Epics](#) section, you can use the **connect.sh** script included in the code repository. This script generates the SSH key pair, pushes the public key to the EC2 instance, and initiates a connection with the bastion host. When you run the script, you pass the tag and key name as arguments. The following is an example of the command to run the script.

```
./connect.sh sandbox-dev-bastion-host my_key
```

# Centralize DNS resolution by using AWS Managed Microsoft AD and on-premises Microsoft Active Directory

*Created by Brian Westmoreland (AWS)*

**Environment:** Production

**Technologies:** Infrastructure; Networking; DevOps; Security, identity, compliance; Operating systems

**Workload:** Microsoft

**AWS services:** AWS Managed Microsoft AD; Amazon Route 53; AWS RAM; AWS Directory Service; AWS Organizations; AWS Direct Connect; AWS CLI

## Summary

This pattern provides guidance for centralizing Domain Name System (DNS) resolution within an AWS multi-account environment by using AWS Directory Service for Microsoft Active Directory (AWS Managed Microsoft AD). In this pattern the AWS DNS namespace is a subdomain of the on-premises DNS namespace. This pattern also provides guidance on how to configure the on-premises DNS servers to forward queries to AWS when the on-premises DNS solution uses Microsoft Active Directory.

## Prerequisites and limitations

### Prerequisites

- An AWS multi-account environment set up by using AWS Organizations.
- Network connectivity established between AWS accounts.
- Network connectivity established between AWS and the on-premises environment (by using AWS Direct Connect or any type of VPN connection).
- AWS Command Line Interface (AWS CLI) configured on a local workstation.

- AWS Resource Access Manager (AWS RAM) used to share Amazon Route 53 rules between accounts. Therefore, sharing must be enabled within the AWS Organizations environment, as described in the *Epics* section.

### Limitations

- AWS Managed Microsoft AD Standard Edition has a limit of 5 shares.
- AWS Managed Microsoft AD Enterprise Edition has a limit of 125 shares.
- This solution in this pattern is limited to AWS Regions that support sharing through AWS RAM.

### Product versions

- Microsoft Active Directory running on Windows Server 2008, 2012, 2012 R2, or 2016

## Architecture

### Target architecture

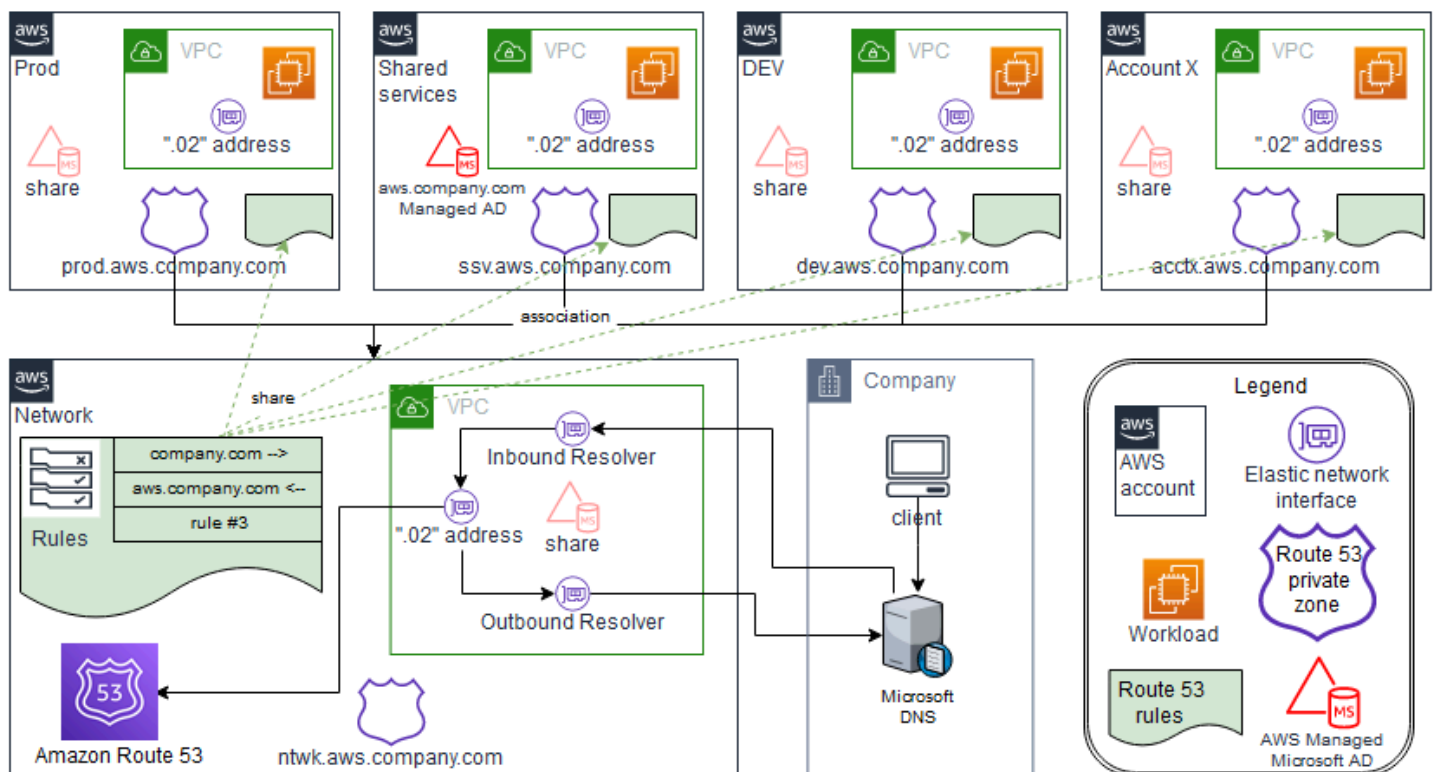



In this design, AWS Managed Microsoft AD is installed in the shared services AWS account. Although this is not a requirement, this pattern assumes this configuration. If you configure AWS Managed Microsoft AD in a different AWS account, you might have to modify the steps in the *Epics* section accordingly.

This design uses Route 53 Resolvers to support name resolution through the use of Route 53 rules. If the on-premises DNS solution uses Microsoft DNS, creating a conditional forwarding rule for the AWS namespace (`aws.company.com`), which is a subdomain of the company DNS namespace (`company.com`), is not straightforward. If you try to create a traditional conditional forwarder, it will result in an error. This is because Microsoft Active Directory is already considered authoritative for any subdomain of `company.com`. To get around this error, you must first create a delegation for `aws.company.com` to delegate authority of that namespace. You can then create the conditional forwarder.

The virtual private cloud (VPC) for each spoke account can have its own unique DNS namespace based on the root AWS namespace. In this design, each spoke account appends an abbreviation of the account name to the base AWS namespace. After the private hosted zones in the spoke account have been created, the zones are associated with the VPC in the spoke account as well as with the VPC in the central AWS network account. This enables the central AWS network account to answer DNS queries related to the spoke accounts.

## Automation and scale

This design makes use of Route 53 Resolver endpoints to scale DNS queries between AWS and your on-premises environment. Each Route 53 Resolver endpoint comprises multiple elastic network interfaces (spread across multiple Availability Zones), and each network interface can handle up to 10,000 queries per second. Route 53 Resolver supports up to 6 IP addresses per endpoint, so altogether this design supports up to 60,000 DNS queries per second spread across multiple Availability Zones for high availability.

Additionally, this pattern automatically accounts for future growth within AWS. The DNS forwarding rules configured on premises do not have to be modified to support new VPCs and their associated private hosted zones that are added to AWS.

## Tools

### AWS services

- [AWS Directory Service for Microsoft Active Directory](#) enables your directory-aware workloads and AWS resources to use Microsoft Active Directory in the AWS Cloud.

- [AWS Organizations](#) is an account management service that helps you consolidate multiple AWS accounts into an organization that you create and centrally manage.
- [AWS Resource Access Manager \(AWS RAM\)](#) helps you securely share your resources across AWS accounts to reduce operational overhead and provide visibility and auditability.
- [Amazon Route 53](#) is a highly available and scalable DNS web service.

## Tools

- [AWS Command Line Interface \(AWS CLI\)](#) is an open-source tool that helps you interact with AWS services through commands in your command-line shell. In this pattern, the AWS CLI is used to configure Route 53 authorizations.

## Epics

### Create and share an AWS Managed Microsoft AD directory

Task	Description	Skills required
Deploy AWS Managed Microsoft AD.	<ol style="list-style-type: none"> <li>1. Create and configure a new directory. For detailed steps, see <a href="#">Create your AWS Managed Microsoft AD directory</a> in the <i>AWS Directory Service Administration Guide</i>.</li> <li>2. Record the IP addresses of the AWS Managed Microsoft AD domain controllers. These will be referenced in a later step.</li> </ol>	AWS administrator
Share the directory.	After the directory has been built, share it with other AWS accounts in the AWS organization. For instructions, see <a href="#">Share your directory</a>	AWS administrator

Task	Description	Skills required
	<p>in the <i>AWS Directory Service Administration Guide</i>.</p> <p><b>Note:</b> AWS Managed Microsoft AD Standard Edition has a limit of 5 shares. Enterprise Edition has a limit of 125 shares.</p>	

## Configure Route 53

Task	Description	Skills required
Create Route 53 Resolvers.	<p>Route 53 Resolvers facilitate DNS query resolution between AWS and the on-premises data center.</p> <ol style="list-style-type: none"> <li>1. Install Route 53 Resolvers by following the <a href="#">instructions</a> in the <i>Route 53 Developer Guide</i>.</li> <li>2. Configure Route 53 Resolvers in private subnets in at least two Availability Zones within the central AWS network account VPC for high availability.</li> </ol> <p><b>Note:</b> Although using the central AWS network account VPC isn't a requirement, the</p>	AWS administrator

Task	Description	Skills required
	remaining steps assume this configuration.	

Task	Description	Skills required
Create Route 53 rules.	<p>Your specific use case might require a large number of Route 53 rules, but you will need to configure the following rules as a baseline:</p> <ul style="list-style-type: none"><li>• An outgoing rule for the on-premises namespace (company . com ) by using the outbound Route 53 Resolvers.<ul style="list-style-type: none"><li>• Share this rule with spoke AWS accounts.</li><li>• Associate this rule with spoke account VPCs.</li></ul></li><li>• An outgoing rule for the AWS namespace (aws . company . com ) that points to the central network account Route 53 inbound Resolvers.<ul style="list-style-type: none"><li>• Share this rule with spoke AWS accounts.</li><li>• Associate the rule with spoke account VPCs.</li><li>• <b>Do not</b> associate this rule with the central AWS network account VPC (which houses the Route 53 Resolvers).</li></ul></li><li>• A second outgoing rule for the AWS namespace (aws . company . com )</li></ul>	AWS administrator

Task	Description	Skills required
	<p>that points to the AWS Managed Microsoft AD domain controllers (use the IPs from the previous epic).</p> <ul style="list-style-type: none"> <li>• Associate this rule with the central AWS network account VPC (which houses the Route 53 Resolvers).</li> <li>• <b>Do not</b> share or associate this rule with other AWS accounts.</li> </ul> <p>For more information, see <a href="#">Managing forwarding rules</a> in the <i>Route 53 Developer Guide</i>.</p>	

## Configure on-premises Active Directory DNS

Task	Description	Skills required
Create the delegation.	<p>Use the Microsoft DNS snap-in (dnsmgmt.msc ) to create a new delegation for the company.com namespace within Active Directory. The name of the delegated domain should be aws. This makes the fully qualified domain name (FQDN) of the delegation aws.compa ny.com . For the name servers, use the IP addresses</p>	Active Directory

Task	Description	Skills required
	of the AWS inbound Route 53 Resolvers in the central DNS AWS account for the IP values, and use <code>server.aws.company.com</code> for the name.	
Create the conditional forwarder.	Use the Microsoft DNS snap-in ( <code>dnsmgmt.msc</code> ) to create a new conditional forwarder for <code>aws.company.com</code> . Use the IP addresses of the AWS Managed Microsoft AD domain controllers for the target of the conditional forwarder.	Active Directory

### Create Route 53 private hosted zones for spoke AWS accounts

Task	Description	Skills required
Create the Route 53 private hosted zones.	Create a Route 53 private hosted zone in each spoke account. Associate this private hosted zone with the spoke account VPC. For detailed steps, see <a href="#">Creating a private hosted zone</a> in the <i>Route 53 Developer Guide</i> .	AWS administrator
Create authorizations.	Use the AWS CLI to create an authorization for the central AWS network account VPC. Run this command from the	AWS administrator

Task	Description	Skills required
	<p>context of each spoke AWS account:</p> <pre data-bbox="597 331 1026 688">aws route53 create-vc-association-authorization --hosted-zone-id &lt;hosted-zone-id&gt; \   --vpc VPCRegion=&lt;region&gt;,VPCId=&lt;vpc-id&gt;</pre> <p>where:</p> <ul data-bbox="597 814 1026 1138" style="list-style-type: none"><li>• &lt;hosted-zone-id&gt; is the Route 53 private hosted zone in the spoke account.</li><li>• &lt;region&gt; and &lt;vpc-id&gt; are the AWS Region and VPC ID of the central AWS network account VPC.</li></ul>	



Task	Description	Skills required
Create associations.	<p>Create the Route 53 private hosted zone association for the central AWS network account VPC by using the AWS CLI. Run this command from the context of the central AWS network account:</p> <pre data-bbox="594 583 1026 903">aws route53 associate -vpc-with-hosted-z one --hosted-zone-id &lt;hosted-zone-id&gt; \   --vpc VPCRegion =&lt;region&gt;,VPCId=&lt;vpc- id&gt;</pre> <p>where:</p> <ul data-bbox="594 1024 1026 1348" style="list-style-type: none"><li>• &lt;hosted-zone-id&gt; is the Route 53 private hosted zone in the spoke account.</li><li>• &lt;region&gt; and &lt;vpc-id&gt; are the AWS Region and VPC ID of the central AWS network account.</li></ul>	AWS administrator

## Related resources

- [Simplify DNS management in a multi-account environment with Route 53 Resolver](#) (AWS blog post by Mahmoud Matouk)
- [Creating a directory with AWS Managed Microsoft AD](#) (AWS Directory Service documentation)
- [Sharing an AWS Managed Microsoft AD directory](#) (AWS Directory Service documentation)
- [Installing a Route 53 Resolver](#) (Amazon Route 53 documentation)
- [Creating a Route 53 private hosted zone](#) (Amazon Route 53 documentation)



# Centralize monitoring by using Amazon CloudWatch Observability Access Manager

Created by Anand Krishna Varanasi (AWS), Jimmy Morgan (AWS), Ashish Kumar (AWS), Balaji Vedagiri (AWS), JAGDISH KOMAKULA (AWS), Sarat Chandra Pothula (AWS), and Vivek Thangamuthu (AWS)

**Code repository:** [cloudwatch-observability-access-manager-terraform](#)

**Environment:** Production

**Technologies:** Infrastructure; Management & governance; Multi account strategy

**AWS services:** Amazon CloudWatch; Amazon CloudWatch Logs

## Summary

Observability is crucial to monitoring, understanding, and troubleshooting applications. Applications that span multiple accounts, as with AWS Control Tower or landing zone implementations, generate a large number of logs and trace data. To quickly troubleshoot problems or understand user analytics or business analytics, you need a common observability platform across all accounts. The Amazon CloudWatch Observability Access Manager gives you access to, and control over, multiple account logs from a central location.

You can use the Observability Access Manager to view and manage observability data logs generated by source accounts. Source accounts are individual AWS accounts that generate observability data for their resources. Observability data is shared between source accounts and monitoring accounts. The shared observability data can include metrics in Amazon CloudWatch, logs in Amazon CloudWatch Logs, and traces in AWS X-Ray. For more information, see the [Observability Access Manager documentation](#).

This pattern is for users who have applications or infrastructure that run in multiple AWS accounts and need a common place to view logs. It explains how you can set up Observability Access Manager by using Terraform, to monitor the status and health of these applications or infrastructure. You can install this solution in multiple ways:

- As a standalone Terraform module that you set up manually

- By using a continuous integration and continuous delivery (CI/CD) pipeline
- By integrating with other solutions such as [AWS Control Tower Account Factory for Terraform \(AFT\)](#)

The instructions in the [Epics](#) section cover the manual implementation. For AFT installation steps, see the README file for the GitHub [Observability Access Manager](#) repository.

## Prerequisites and limitations

### Prerequisites

- [Terraform](#) installed or referenced in your system or in automated pipelines. (We recommend that you use the [latest version](#).)
- An account that you can use as a central monitoring account. Other accounts create links to the central monitoring account in order to view logs.
- (Optional) A source code repository such as GitHub, AWS CodeCommit, Atlassian Bitbucket, or similar system. A source code repository isn't necessary if you're using automated CI/CD pipelines.
- (Optional) Permissions to create pull requests (PRs) for code review and code collaboration in GitHub.

### Limitations

Observability Access Manager has the following service quotas, which cannot be changed. Consider these quotas before you deploy this feature. For more information, see [CloudWatch service quotas](#) in the CloudWatch documentation.

- **Source account links:** You can link each source account to a maximum of five monitoring accounts.
- **Sinks:** You can build multiple sinks for an account, but only one sink per AWS Region is allowed.

In addition:

- Sinks and links must be created in the same AWS Region; they cannot be cross-Region.

### Cross-Region and cross-account monitoring

For cross-Region, cross-account monitoring, you can choose one of these options:

- Create [cross-account and cross-Region CloudWatch dashboards](#) for alarms and metrics. This option doesn't support logs and traces.
- Implement [centralized logging](#) by using Amazon OpenSearch Service.
- Create one sink per Region from all tenant accounts, push metrics to a centralized monitoring account (as described in this pattern), and then use [CloudWatch metric streams](#) to send the data to a common external destination or to third-party monitoring products such as Datadog, Dynatrace, Sumo Logic, Splunk, or New Relic.

## Architecture

### Components

CloudWatch Observability Access Manager consists of two major components that enable cross-account observability:

- A *sink* provides the ability for source accounts to send observability data to the central monitoring account. A sink basically provides a gateway junction for source accounts to connect to. There can be only one sink gateway or connection, and multiple accounts can connect to it.
- Each source account has a *link* to the sink gateway junction, and observability data is sent through this link. You must create a sink before you create links from each source account.

### Architecture

The following diagram illustrates Observability Access Manager and its components.

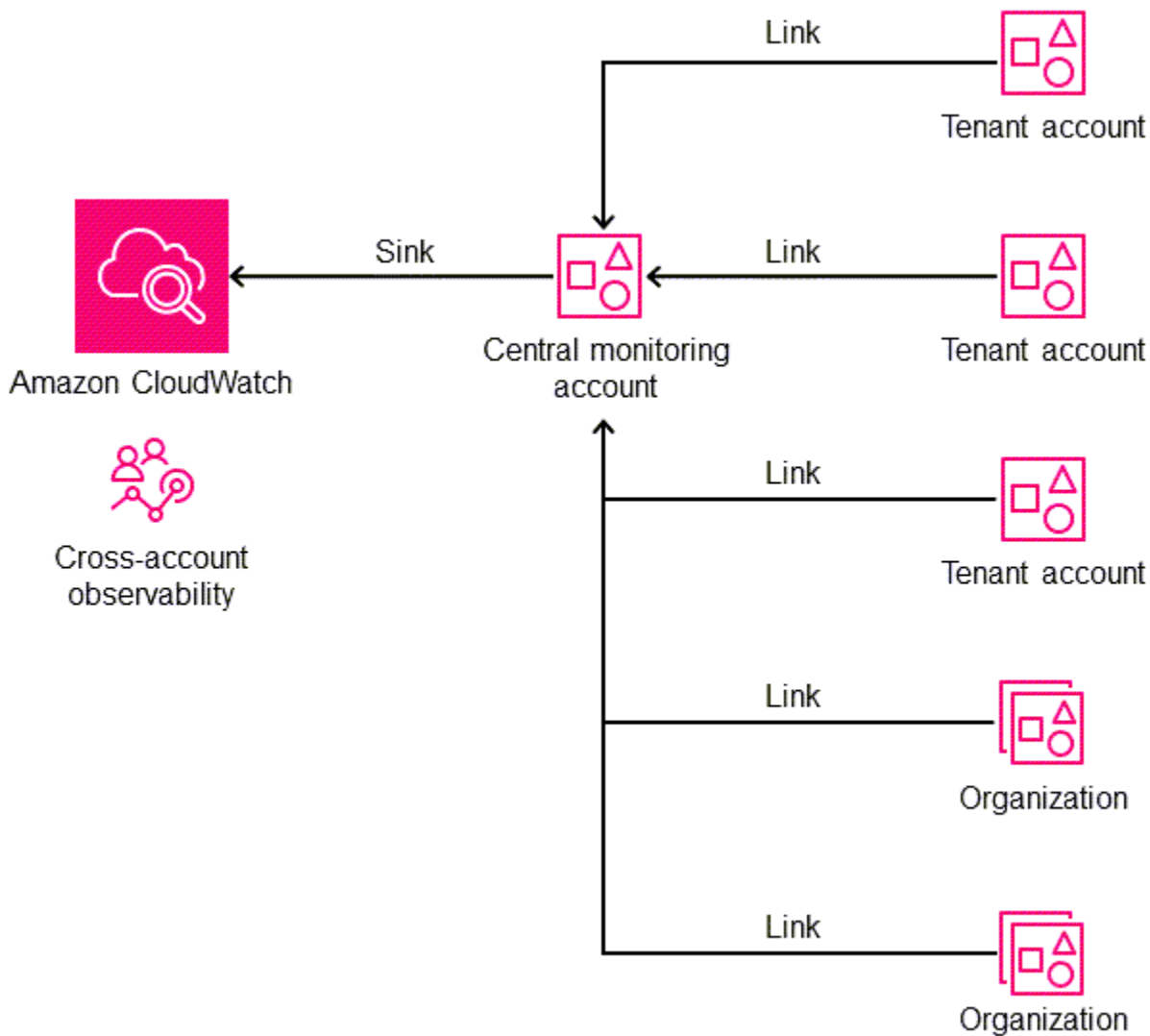

## Tools

### AWS services

- [Amazon CloudWatch](#) helps you monitor the metrics of your AWS resources and the applications you run on AWS in real time.
- [AWS Organizations](#) is an account management service that helps you consolidate multiple AWS accounts into an organization that you create and centrally manage.
- [AWS Identity and Access Management \(IAM\)](#) helps you securely manage access to your AWS resources by controlling who is authenticated and authorized to use them.

## Tools

- [Terraform](#) is an infrastructure as code (IaC) tool from HashiCorp that helps you create and manage cloud and on-premises resources.
- [AWS Control Tower Account Factory for Terraform \(AFT\)](#) sets up a Terraform pipeline to help you provision and customize accounts in AWS Control Tower. You can optionally use AFT to set up Observability Access Manager at scale across multiple accounts.

## Code repository

The code for this pattern is available in the GitHub [Observability Access Manager](#) repository.

## Best practices

- In AWS Control Tower environments, mark the logging account as the central monitoring account (sink).
- If you have multiple organizations with multiple accounts in AWS Organizations, we recommend that you include the organizations instead of individual accounts in the configuration policy. If you have a small number of accounts or if the accounts aren't part of an organization in the sink configuration policy, you might decide to include individual accounts instead.

## Epics

### Set up the sink module

Task	Description	Skills required
Clone the repository.	Clone the GitHub Observability Access Manager repository:  <pre>git clone https://github.com/aws-samples/cloudwatch-observability-access-manager-terraform</pre>	AWS DevOps, Cloud administrator, AWS administrator
Specify property values for the sink module.	In the <code>main.tf</code> file (in the <code>deployments/aft-ac</code>	AWS DevOps, Cloud administrator, AWS administrator

Task	Description	Skills required
	<p>count-customizations/LOGGING/terraform/ folder of the repository), specify values for the following properties:</p> <ul style="list-style-type: none"><li>• <code>sink_name</code> : The name of the CloudWatch sink.</li><li>• <code>allowed_oam_resource_types</code> : Observability Access Manager currently supports CloudWatch metrics, log groups, and AWS X-Ray traces.</li><li>• <code>allowed_source_accounts</code> : The source accounts that are allowed to send logs to the central CloudWatch sink account.</li><li>• <code>allowed_source_organizations</code> : The source AWS Control Tower organizations that are allowed to send logs to the central CloudWatch sink account.</li></ul> <p>For more information, see <a href="#">AWS::Oam::Sink</a> in the AWS CloudFormation documentation.</p>	



Task	Description	Skills required
Install the sink module.	<p>Export the credentials of the AWS account that you have selected as the monitoring account, and install the Observability Access Manager sink module:</p> <pre>Terraform Init Terraform Plan Terraform Apply</pre>	AWS DevOps, Cloud administrator, AWS administrator

## Set up the link module

Task	Description	Skills required
Specify property values for the link module.	<p>In the <code>main.tf</code> file (in the <code>deployments/aft-account-customizations/LOGGING/terraform/</code> folder of the repository), specify values for the following properties:</p> <ul style="list-style-type: none"> <li><code>account_label</code> : Use one of the following values: <ul style="list-style-type: none"> <li><code>\$AccountName</code> : The name of the account.</li> <li><code>\$AccountEmail</code> : A globally unique email address, which includes the email domain (for example, <code>hello@example.com</code> )</li> </ul> </li> </ul>	AWS DevOps, Cloud administrator, Cloud architect

Task	Description	Skills required
	<ul style="list-style-type: none"> <li>• <code>\$AccountEmailNoDomain</code> : An email address without the domain name.</li> <li>• <code>allowed_oam_resource_types</code> : Observability Access Manager currently supports CloudWatch metrics, log groups, and AWS X-Ray traces.</li> </ul> <p>For more information, see <a href="#">AWS::Oam::Link</a> in the AWS CloudFormation documentation.</p>	
<p>Install the link module for individual accounts.</p>	<p>Export the credentials of individual accounts and install the Observability Access Manager link module:</p> <div data-bbox="594 1213 1029 1331" style="border: 1px solid #ccc; border-radius: 10px; padding: 10px; margin: 10px 0;"> <pre>Terraform Plan Terraform Apply</pre> </div> <p>You can set up the link module individually for each account, or use <a href="#">AFT</a> to automatically install this module across a large number of accounts.</p>	<p>AWS DevOps, Cloud administrator, Cloud architect</p>

## Approve sink-to-link connections

Task	Description	Skills required
<p>Check the status message.</p>	<ol style="list-style-type: none"> <li>1. Sign in to the monitoring account.</li> <li>2. Open the <a href="#">CloudWatch console</a>.</li> <li>3. In the left navigation pane, choose <b>Settings</b>.</li> </ol> <p>On the right, you should see the status message <b>Monitoring account enabled</b> with a green checkmark. This means that the monitoring account has an Observability Access Manager sink that the links of other accounts will connect to.</p>	
<p>Approve the link-to-sink connections.</p>	<ol style="list-style-type: none"> <li>1. Choose the <b>Resources to link accounts</b> option below the status message. The information confirms that this is the monitoring account, lists the data that is shared from the tenant source accounts (<b>Logs, Metrics, Traces</b>), and shows the account label as <b>\$AccountName</b>.</li> </ol> <p>This screen provides two options for linking tenant accounts to the monitoring account: organization-</p>	<p>AWS DevOps, Cloud administrator, Cloud architect</p>

Task	Description	Skills required
	<p>level approval or account-level approval. For each option, you can choose to download an AWS CloudFormation template for the approval or approve each account individually.</p> <ol style="list-style-type: none"><li>2. For simplicity, choose <b>Any Account</b> to approve at each account level. This option provides an approval link for the account.</li><li>3. Choose <b>Copy URL</b> to copy the link.</li><li>4. Sign in to each source account.</li><li>5. In a browser window, paste the link, and choose <b>Approve link connect to sink</b>.</li><li>6. Repeat for additional source accounts.</li></ol> <p>For more information, see <a href="#">Link monitoring accounts with source accounts</a> in the CloudWatch documentation.</p>	

## Verify cross-account observability data

Task	Description	Skills required
View cross-account data.	<ol style="list-style-type: none"> <li>1. Sign in to the central monitoring account.</li> <li>2. Open the <a href="#">CloudWatch console</a>.</li> <li>3. In the left navigation pane, choose options to view cross-account logs, metrics, and traces.</li> </ol>	AWS DevOps, Cloud administrator, Cloud architect

## (Optional) Enable source accounts to trust monitoring account

Task	Description	Skills required
View metrics, dashboards, logs, widgets, and alarms from other accounts.	<p>As an additional feature, you can share the CloudWatch metrics, dashboards, logs, widgets, and alarms with other accounts. Each account uses an IAM role called <b>CloudWatch-CrossAccountSharingRole</b> to gain access to this data.</p> <p>Source accounts that have a trust relationship with the central monitoring account can assume this role and view data from the monitoring account.</p> <p>CloudWatch provides a sample CloudFormation script</p>	AWS DevOps, Cloud administrator, Cloud architect

Task	Description	Skills required
	<p>to create the role. Choose <b>Manage role in IAM</b> and run this script in the accounts where you want to view data.</p> <pre data-bbox="594 426 1029 1619">{   "Version":   "2012-10-17",   "Statement": [     {       "Effect":       "Allow",       "Principal": {         "AWS": [           "arn:aws:iam::XXXX           XXXX:root",           "arn:aws:iam::XXXX           XXXX:root",           "arn:aws:iam::XXXX           XXXX:root",           "arn:aws:iam::XXXX           XXXX:root"         ]       },       "Action":       "sts:AssumeRole"     }   ] }</pre> <p>For more information, see <a href="#">Enabling cross-account functionality in CloudWatc</a></p>	

Task	Description	Skills required
	<a href="#">h</a> in the CloudWatch documentation.	

### (Optional) View cross-account cross-Region from the monitoring account

Task	Description	Skills required
Set up cross-account, cross-Region access.	<p>In the central monitoring account, you can optionally add an account selector to easily switch between accounts and view their data without having to authenticate.</p> <ol style="list-style-type: none"> <li>1. Sign in to the central monitoring account.</li> <li>2. Open the <a href="#">CloudWatch console</a>.</li> <li>3. In the left navigation pane, choose <b>Settings</b>.</li> <li>4. In the <b>View cross-account cross-region</b> section, choose <b>Configure</b>.</li> <li>5. Choose <b>Enable</b>, and then select the <b>Show selector in the console</b> check box.</li> <li>6. Choose one of these options: <ul style="list-style-type: none"> <li>• <b>Account Id Input:</b> This option prompts you to manually input the account ID whenever you</li> </ul> </li> </ol>	AWS DevOps, Cloud administrator, Cloud architect

Task	Description	Skills required
	<p>want to change accounts to view cross-account data.</p> <ul style="list-style-type: none"> <li>• <b>AWS Organization account selector:</b> If you have <a href="#">integrated CloudWatch with AWS Organizations</a>, this option provides a dropdown selector with a complete list of accounts in the organization.</li> <li>• <b>Custom account selector:</b> This option lets you manually input a list of account IDs to populate the selector.</li> </ul> <p>7. Choose <b>Save changes</b>.</p> <p>For more information, see <a href="#">Cross-account cross-Region CloudWatch console</a> in the CloudWatch documentation.</p>	

## Related resources

- [CloudWatch cross-account observability](#) (Amazon CloudWatch documentation)
- [Amazon CloudWatch Observability Access Manager API Reference](#) (Amazon CloudWatch documentation)
- [Resource: aws\\_oam\\_sink](#) (Terraform documentation)
- [Data Source: aws\\_oam\\_link](#) (Terraform documentation)



- [CloudWatchObservabilityAccessManager](#) (AWS Boto3 documentation)

# Check EC2 instances for mandatory tags at launch

Created by Susanne Kangnoh (AWS) and Archit Mathur (AWS)

**Environment:** Production

**Technologies:** Infrastructure;  
Management & governance;  
Security, identity, compliance;  
CloudNative

**AWS services:** Amazon EC2;  
AWS CloudTrail; Amazon  
CloudWatch; Amazon SNS

## Summary

Amazon Elastic Compute Cloud (Amazon EC2) provides scalable computing capacity in the Amazon Web Services (AWS) Cloud. Using Amazon EC2 eliminates your need to invest in hardware up front, so you can develop and deploy applications faster.

You can use tagging to categorize your AWS resources in different ways. EC2 instance tagging is useful when you have many resources in your account and you want to quickly identify a specific resource based on the tags. You can assign custom metadata to your EC2 instances by using tags. A tag consists of a user-defined key and value. We recommend that you create a consistent set of tags to meet your organization's requirements.

This pattern provides an AWS CloudFormation template to help you monitor EC2 instances for specific tags. The template creates an Amazon CloudWatch Events event that watches for the AWS CloudTrail **TagResource** or **UntagResource** events, to detect new EC2 instance tagging or tag removal. If a predefined tag is missing, it calls an AWS Lambda function, which sends out a violation message to an email address that you provide, by using Amazon Simple Notification Service (Amazon SNS).

## Prerequisites and limitations

### Prerequisites

- An active AWS account.
- An Amazon Simple Storage Service (Amazon S3) bucket to upload the provided Lambda code.
- An email address where you would like to receive violation notifications.

## Limitations

- This solution supports CloudTrail **TagResource** or **UntagResource** events. It does not create notifications for any other events.
- This solution checks only for tag keys. It does not monitor key values.

## Architecture

### Workflow architecture

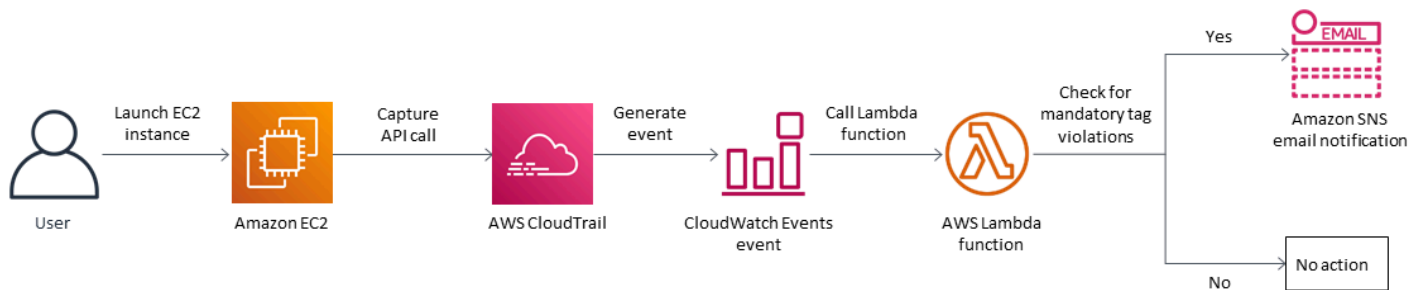

### Automation and scale

- You can use the AWS CloudFormation template multiple times for different AWS Regions and accounts. You need to run the template only once in each Region or account.

## Tools

### AWS services

- [Amazon EC2](#) – Amazon Elastic Compute Cloud (Amazon EC2) is a web service that provides secure, resizable compute capacity in the cloud. It is designed to make web-scale cloud computing easier for developers.
- [AWS CloudTrail](#) – CloudTrail is an AWS service that helps you with governance, compliance, and operational and risk auditing of your AWS account. Actions taken by a user, role, or AWS service are recorded as events in CloudTrail.
- [Amazon CloudWatch Events](#) – Amazon CloudWatch Events delivers a near real-time stream of system events that describe changes in AWS resources. CloudWatch Events becomes aware of operational changes as they occur and takes corrective action as necessary, by sending messages

to respond to the environment, activating functions, making changes, and capturing state information.

- [AWS Lambda](#) – Lambda is a compute service that supports running code without needing to provision or manage servers. Lambda runs your code only when needed and scales automatically, from a few requests per day to thousands per second.
- [Amazon S3](#) – Amazon Simple Storage Service (Amazon S3) is a highly scalable object storage service that can be used for a wide range of storage solutions, including websites, mobile applications, backups, and data lakes.
- [Amazon SNS](#) – Amazon Simple Notification Service (Amazon SNS) is a web service that enables applications, end-users, and devices to instantly send and receive notifications from the cloud.

## Code

This pattern includes an attachment with two files:

- `index.zip` is a compressed file that includes the Lambda code for this pattern.
- `ec2-require-tags.yaml` is a CloudFormation template that deploys the Lambda code.

See the *Epics* section for information about how to use these files.

## Epics

### Deploy the Lambda code

Task	Description	Skills required
Upload the code to an S3 bucket.	Create a new S3 bucket or use an existing S3 bucket to upload the attached <code>index.zip</code> file (Lambda code). This bucket must be in the same AWS Region as the resources (EC2 instances) that you want to monitor.	Cloud architect
Deploy the CloudFormation template.	Open the CloudFormation console in the same AWS	Cloud architect

Task	Description	Skills required
	Region as the S3 bucket, and deploy the <code>ec2-require-tags.yaml</code> file that's provided in the attachment. In the next epic, provide values for the template parameters.	

### Complete the parameters in the CloudFormation template

Task	Description	Skills required
Provide the S3 bucket name.	Enter the name of the S3 bucket that you created or selected in the first epic. This S3 bucket contains the .zip file for the Lambda code and must be in the same AWS Region as the CloudFormation template and the EC2 instances that you want to monitor.	Cloud architect
Provide the S3 key.	Provide the location of the Lambda code .zip file in your S3 bucket, without leading slashes (for example, <code>index.zip</code> or <code>controls/index.zip</code> ).	Cloud architect
Provide an email address.	Provide an active email address where you want to receive violation notifications.	Cloud architect

Task	Description	Skills required
Define a logging level.	Specify the logging level and verbosity. <code>Info</code> designates detailed informational messages on the application's progress and should be used only for debugging. <code>Error</code> designates error events that could still allow the application to continue running. <code>Warning</code> designates potentially harmful situations.	Cloud architect
Enter the required tag keys.	Enter the tag keys that you want to check for. If you want to specify multiple keys, separate them with commas, without spaces. (For example, <code>ApplicationId,CreatedBy,Environment,Organization</code> searches for four keys.) The CloudWatch Events event searches for these tag keys and sends a notification if they are not found.	Cloud architect

## Confirm the subscription

Task	Description	Skills required
Confirm the email subscription.	When the CloudFormation template deploys successfully, it sends a subscription	Cloud architect

Task	Description	Skills required
	email message to the email address you provided. To receive notifications, you must confirm this email subscription.	

## Related resources

- [Creating a bucket](#) (Amazon S3 documentation)
- [Uploading objects](#) (Amazon S3 documentation)
- [Tag your Amazon EC2 resources](#) (Amazon EC2 documentation)
- [Creating a CloudWatch Events rule that triggers on an AWS API call using AWS CloudTrail](#) (Amazon CloudWatch documentation)

## Attachments

To access additional content that is associated with this document, unzip the following file: [attachment.zip](#)

# Connect to an Amazon EC2 instance by using Session Manager

Created by Jason Cornick (AWS), Abhishek Bastikoppa (AWS), and Yaniv Ron (AWS)

**Environment:** Production

**Technologies:** Infrastru  
cture; CloudNative; End-user  
computing; Operations

**AWS services:** Amazon  
CloudWatch Logs; AWS  
Systems Manager; Amazon  
EC2

## Summary

This pattern describes how to connect to an Amazon Elastic Compute Cloud (Amazon EC2) instance by using the Session Manager, a capability of AWS Systems Manager. Using this pattern, you can run bash commands on an EC2 instance through a web browser. Session Manager doesn't require that you open inbound ports and doesn't require public IP addresses for EC2 instances. Additionally, it removes the need to maintain bastion hosts with different Secure Shell (SSH) keys. You can govern access to Session Manager with AWS Identity and Access Management (IAM) policies and configure logging, which records important information, such as instance access and actions.

In this pattern, you configure an IAM role and associate it to a Linux EC2 instance that you provision by using an Amazon Machine Image (AMI). You then configure logging in Amazon CloudWatch Logs and use Session Manager to start a session with the instance.

Although this pattern connects to a Linux EC2 instance in the Amazon Web Services (AWS) Cloud, you could use this approach to use Session Manager for connections with other servers, such as on-premises servers or other virtual machines.

## Prerequisites and limitations

### Prerequisites

- An active AWS account.
- Permissions to access the managed node. For instructions, see [Control user session access to managed nodes](#).



- VPC endpoints for ssm, ec2, ec2messages, ssmessages, and s3. For instructions, see [Create VPC endpoints](#) in the Systems Manager documentation.

## Architecture

### Target technology stack

- Session Manager
- Amazon EC2
- CloudWatch Logs

### Target architecture

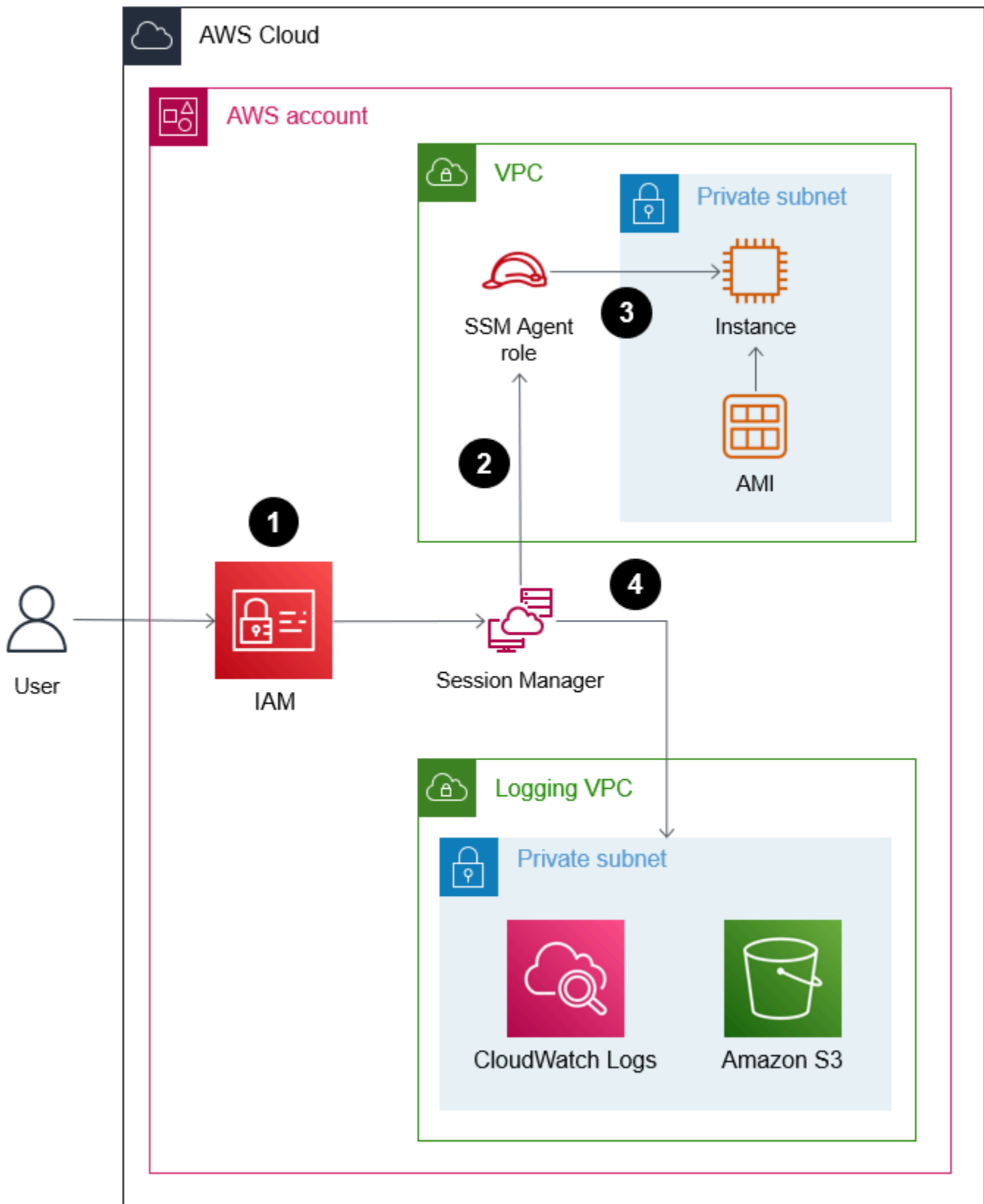

1. The user authenticates their identity and credentials through IAM.
2. The user initiates an SSH session through Session Manager and sends API calls to the EC2 instance.
3. The AWS Systems Manager SSM Agent, which is installed on the EC2 instance, connects to Session Manager and runs the commands.
4. For auditing and monitoring purposes, Session Manager sends the logging data to CloudWatch Logs. Alternatively, you can send log data to an Amazon Simple Storage Service (Amazon S3) bucket. For more information, see [Logging session data using Amazon S3](#) (Systems Manager documentation).

## Tools

### AWS services

- [Amazon CloudWatch Logs](#) helps you centralize the logs from all your systems, applications, and AWS services so you can monitor them and archive them securely.
- [Amazon Elastic Compute Cloud \(Amazon EC2\)](#) provides scalable computing capacity in the AWS Cloud. You can launch as many virtual servers as you need and quickly scale them up or down. This pattern uses an Amazon Machine Image (AMI) to provision a Linux EC2 instance.
- [AWS Identity and Access Management \(IAM\)](#) helps you securely manage access to your AWS resources by controlling who is authenticated and authorized to use them.
- [AWS Systems Manager](#) helps you manage your applications and infrastructure running in the AWS Cloud. It simplifies application and resource management, shortens the time to detect and resolve operational problems, and helps you manage your AWS resources securely at scale. This pattern uses [Session Manager](#), a capability of Systems Manager.

## Best practices

We recommend that you read more about the [security pillar](#) of the AWS Well-Architected Framework and explore encryption options and apply the security recommendations in [Setting up Session Manager](#) (Systems Manager documentation).

# Epics

## Set up the infrastructure

Task	Description	Skills required
Create the IAM role.	<p>Create the IAM role for the SSM Agent. Follow the instructions in <a href="#">Creating a role for an AWS service</a> (IAM documentation) and note the following:</p> <ol style="list-style-type: none"><li>1. For the AWS service, choose <b>EC2</b>.</li><li>2. For <b>Permissions Policies</b>, choose AmazonSSMManagedInstanceCore .</li><li>3. In <b>Role Name</b>, enter EC2_SSM_Role .</li></ol>	AWS systems administrator
Create the EC2 instance.	<ol style="list-style-type: none"><li>1. Create the EC2 instance. Follow the instructions in <a href="#">Launch an instance</a> (Amazon EC2 documentation) and note the following:<ol style="list-style-type: none"><li>a. In the <b>Name and tags</b> section, choose <b>Add additional tags</b>. In <b>Key</b>, enter Name, and in <b>Value</b>, enter Production_Server_One .</li><li>b. Choose an Amazon Linux AMI that has the SSM Agent preinstalled.</li></ol></li></ol>	AWS systems administrator

Task	Description	Skills required
	<p>For a complete list, see <a href="#">AMIs with SSM Agent preinstalled</a> (Systems Manager documentation).</p> <ol style="list-style-type: none"><li data-bbox="630 457 1019 636">c. In the <b>Advanced details</b> section, in <b>IAM instance profile</b>, choose <b>EC2_SSM_Role</b>.</li><li data-bbox="594 657 1029 840">2. Open the Systems Manager console at <a href="https://console.aws.amazon.com/systems-manager/">https://console.aws.amazon.com/systems-manager/</a>.</li><li data-bbox="594 861 964 940">3. In the navigation pane, choose <b>Fleet Manager</b>.</li><li data-bbox="594 961 971 1092">4. Verify that the instance appears in the list of managed nodes.</li></ol>	

Task	Description	Skills required
Set up logging.	<ol style="list-style-type: none"> <li>1. Create a log group in CloudWatch Logs. Follow the instructions in <a href="#">Create a log group</a> (CloudWatch Logs documentation). Name the new log group <code>SessionManager</code>.</li> <li>2. Configure logging for Session Manager. Follow the instructions in <a href="#">Logging session data using Amazon CloudWatch Logs</a> (Systems Manager documentation) and note the following:               <ol style="list-style-type: none"> <li>a. Don't select <b>Allow only encrypted CloudWatch log groups</b>.</li> <li>b. In <b>Choose a log group from the list</b>, choose <b>SessionManager</b>.</li> </ol> </li> </ol>	AWS systems administrator

## Connect to the instance

Task	Description	Skills required
Connect to the EC2 instance.	<ol style="list-style-type: none"> <li>1. Start a session in the Systems Manager console. For instructions, see <a href="#">Start a session</a> (Systems Manager documentation). For <b>Target instances</b>, choose the option button to the</li> </ol>	AWS systems administrator

Task	Description	Skills required
	<p>left of the <b>Production_Server_One</b> instance.</p> <ol style="list-style-type: none"> <li>After the connection is made, run several bash commands.</li> <li>In the Systems Manager console, end the session. For instructions, see <a href="#">End a session</a> (Systems Manager documentation).</li> </ol>	
Validate logging.	<ol style="list-style-type: none"> <li>In CloudWatch Logs, open the log stream for the log group. For instructions, see <a href="#">View log data</a> (CloudWatch Logs documentation).</li> <li>In the log data, confirm that the commands you ran in the previous story are listed.</li> </ol>	AWS systems administrator

## Troubleshooting

Issue	Solution
IAM issues	For support, see <a href="#">Troubleshooting</a> (IAM documentation).

## Related resources

- [Complete Session Manager prerequisites](#) (Systems Manager documentation)
- [Designing and implementing logging and monitoring with Amazon CloudWatch](#) (AWS Prescriptive Guidance)





# Create a pipeline in AWS Regions that don't support AWS CodePipeline

Created by Anand Krishna Varanasi (AWS)

**Code repository:** [invisible-codepipeline-unsupported-regions](#)

**Environment:** PoC or pilot

**Technologies:** Infrastructure; DevOps

**AWS services:** AWS CodeBuild; AWS CodeCommit; AWS CodeDeploy; AWS CodePipeline

## Summary

AWS CodePipeline is a continuous delivery (CD) orchestration service that's part of a set of DevOps tools from Amazon Web Services (AWS). It integrates with a large variety of sources (such as version control systems and storage solutions), continuous integration (CI) products and services from AWS and AWS Partners, and open-source products to provide an end-to-end workflow service for fast application and infrastructure deployments.

However, CodePipeline isn't supported in all AWS Regions, and it's useful to have an invisible orchestrator that connects AWS CI/CD services. This pattern describes how to implement an end-to-end workflow pipeline in AWS Regions where CodePipeline isn't yet supported by using AWS CI/CD services such as AWS CodeCommit, AWS CodeBuild, and AWS CodeDeploy.

## Prerequisites and limitations

### Prerequisites

- An active AWS account
- AWS Cloud Development Kit (AWS CDK) CLI version 2.28 or later

# Architecture

## Target technology stack

The following diagram shows a pipeline that was created in a Region that doesn't support CodePipeline, such as the Africa (Cape Town) Region. A developer pushes the CodeDeploy configuration files (also called *deployment lifecycle hook scripts*) to the Git repository that's hosted by CodeCommit. (See the [GitHub repository](#) provided with this pattern.) An Amazon EventBridge rule automatically initiates CodeBuild. (See the [GitHub repository](#) provided with this pattern.)

The CodeDeploy configuration files are fetched from CodeCommit as part of the source stage of the pipeline and transferred to CodeBuild.

In the next phase, CodeBuild performs these tasks:

1. Downloads the application source code TAR file. You can configure the name of this file by using Parameter Store, a capability of AWS Systems Manager.
2. Downloads the CodeDeploy configuration files.
3. Creates a combined archive of application source code and CodeDeploy configuration files that are specific to the application type.
4. Initiates CodeDeploy deployment to an Amazon Elastic Compute Cloud (Amazon EC2) instance by using the combined archive.

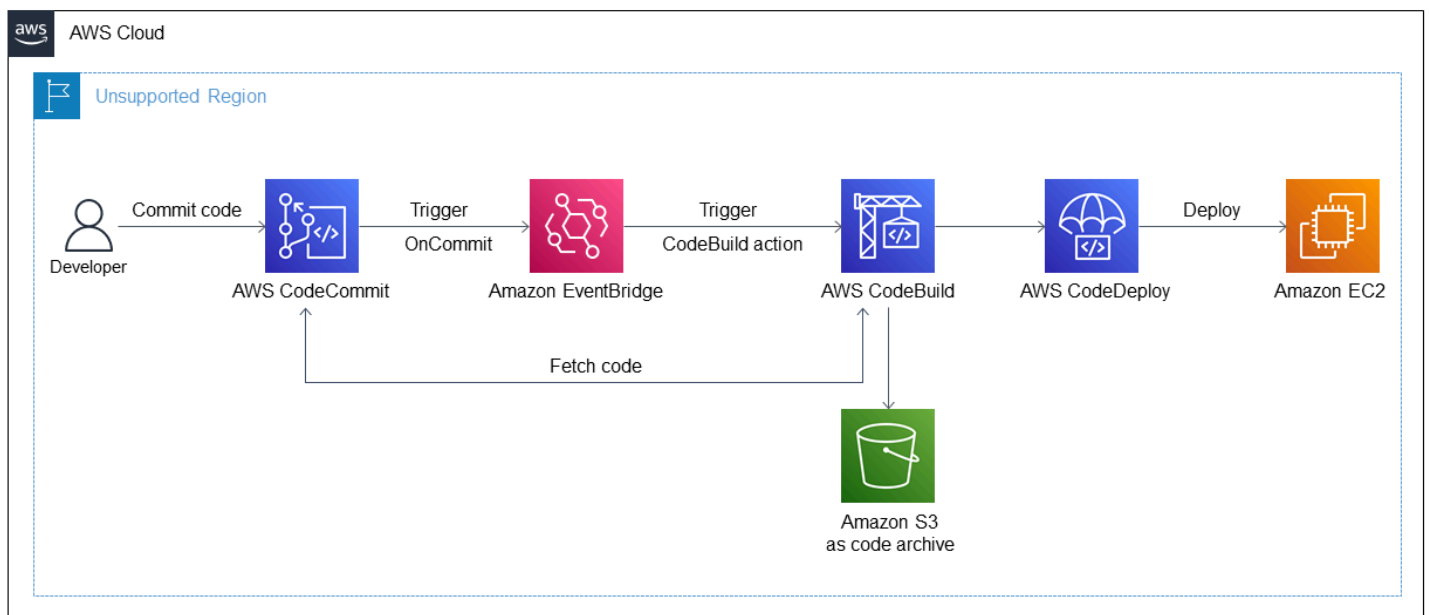

## Tools

### AWS services

- [AWS CodeBuild](#) is a fully managed build service that helps you compile source code, run unit tests, and produce artifacts that are ready to deploy.
- [AWS CodeCommit](#) is a version control service that helps you privately store and manage Git repositories, without needing to manage your own source control system.
- [AWS CodeDeploy](#) automates deployments to Amazon EC2 or on-premises instances, AWS Lambda functions, or Amazon Elastic Container Service (Amazon ECS) services.
- [AWS CodePipeline](#) helps you quickly model and configure the different stages of a software release and automate the steps required to release software changes continuously.
- [AWS Cloud Development Kit \(AWS CDK\)](#) is a software development framework that helps you define and provision AWS Cloud infrastructure in code.

### Code

The code for this pattern is available in the GitHub [CodePipeline Unsupported Regions](#) repository.

## Epics

### Set up your developer workstation

Task	Description	Skills required
Install the AWS CDK CLI.	For instructions, see the <a href="#">AWS CDK documentation</a> .	AWS DevOps
Install a Git client.	To create commits, you can use a Git client installed on your local computer, and then push your commits to the CodeCommit repository. To set up CodeCommit with your Git client, see the <a href="#">CodeCommit documentation</a> .	AWS DevOps

Task	Description	Skills required
Install npm.	Install the <b>npm</b> package manager. For more information, see the <a href="#">npm documentation</a> .	AWS DevOps

## Set up the pipeline

Task	Description	Skills required
Clone the code repository.	Clone the GitHub <a href="#">CodePipeline Unsupported Regions</a> repository to your local machine by running the following command. <pre>git clone https://github.com/aws-samples/invisible-code-pipeline-unsupported-regions</pre>	DevOps engineer
Set parameters in cdk.json.	Open the <code>cdk.json</code> file and provide values for the following parameters: <pre>"pipeline_account" : "XXXXXXXXXXXX", "pipeline_region": "us-west-2", "repo_name": "app-dev-repo", "ec2_tag_key": "test-vm", "configName" : "cbdeployconfig", "deploymentGroupName": "cbdeploygroup",</pre>	AWS DevOps

Task	Description	Skills required
	<pre data-bbox="594 205 1026 424">"applicationName" :   "cbdeployapplicati on", "projectName" :   "CodeBuildProject"</pre> <p data-bbox="594 464 691 495">where:</p> <ul data-bbox="594 541 1026 1793" style="list-style-type: none"><li data-bbox="594 541 1026 674">• <code>pipeline_account</code> is the AWS account where the pipeline will be built.</li><li data-bbox="594 695 1026 827">• <code>pipeline_region</code> is the AWS Region where the pipeline will be built.</li><li data-bbox="594 848 1026 980">• <code>repo_name</code> is the name of the CodeCommit repository.</li><li data-bbox="594 1001 1026 1182">• <code>ec2_tag_key</code> is the tag attached to the EC2 instance that you want to deploy the code to.</li><li data-bbox="594 1203 1026 1335">• <code>configName</code> is the name of the CodeDeploy configuration file.</li><li data-bbox="594 1356 1026 1537">• <code>deploymentGroupName</code> is the name of the CodeDeploy deployment group.</li><li data-bbox="594 1558 1026 1690">• <code>applicationName</code> is the CodeDeploy application name.</li><li data-bbox="594 1711 1026 1793">• <code>projectName</code> is the CodeBuild project name.</li></ul>	

Task	Description	Skills required
Set up the AWS CDK construct library.	<p>In the cloned GitHub repository, use the following commands to install the AWS CDK construct library, build your application, and synthesize to generate the AWS CloudFormation template for the application.</p> <pre>npm i aws-cdk-lib npm run build cdk synth</pre>	AWS DevOps
Deploy the sample AWS CDK application.	<p>Deploy the code by running the following command in an unsupported Region (such as <code>af-south-1</code> ).</p> <pre>cdk deploy</pre>	AWS DevOps

### Set up the CodeCommit repository for CodeDeploy

Task	Description	Skills required
Set up CI/CD for the application.	<p>Clone the CodeCommit repository that you specified in the <code>cdk.json</code> file (this is called <code>app-dev-repo</code> by default) to set up the CI/CD pipeline for the application.</p> <pre>git clone https://git-codecommit.us-w</pre>	AWS DevOps

Task	Description	Skills required
	<pre>est-2.amazonaws.com/ v1/repos/app-dev-repo</pre> <p>where the repository name and Region depend on the values you provided in the <code>cdk.json</code> file.</p>	

## Test the pipeline

Task	Description	Skills required
<p>Test the pipeline with deployment instructions.</p>	<p>The <code>CodeDeploy_Files</code> folder of the GitHub <a href="#">CodePipeline Unsupported Regions</a> repository includes sample files that instruct CodeDeploy to deploy the application. The <code>appspec.yml</code> file is a CodeDeploy configuration file that contains hooks to control the flow of application deployment. You can use the sample files <code>index.html</code>, <code>start_server.sh</code>, <code>stop_server.sh</code>, and <code>install_dependencies.sh</code> to update a website that's hosted on Apache. These are examples—you can use the code in the GitHub repository to deploy any type of application. When</p>	<p>AWS DevOps</p>

Task	Description	Skills required
	the files are pushed to the CodeCommit repository, the invisible pipeline is initiated automatically. For deployment results, check the results of individual phases in the CodeBuild and CodeDeploy consoles.	

## Related resources

- [Getting started](#) (AWS CDK documentation)
- [Introduction to the Cloud Development Kit \(CDK\)](#) (AWS Workshop Studio)
- [AWS CDK Workshop](#)



# Deploy a Cassandra cluster on Amazon EC2 with private static IPs to avoid rebalancing

Created by Dipin Jain (AWS)

<b>Environment:</b> PoC or pilot	<b>Source:</b> On-premises VM	<b>Target:</b> Amazon EC2
<b>R Type:</b> Rehost	<b>Workload:</b> Open-source	<b>Technologies:</b> Infrastructure; Databases; Migration
<b>AWS services:</b> Amazon EC2		

## Summary

The private IP of an Amazon Elastic Compute Cloud (Amazon EC2) instance is retained throughout its lifecycle. However, the private IP might change during a planned or unplanned system crash; for example, during an Amazon Machine Image (AMI) upgrade. In some scenarios, retaining a private static IP can enhance the performance and recovery time of workloads. For example, using a static IP for an Apache Cassandra seed node prevents the cluster from incurring a rebalancing overhead.

This pattern describes how to attach a secondary elastic network interface to EC2 instances to keep the IP static during rehosting. The pattern focuses on Cassandra clusters, but you can use this implementation for any architecture that benefits from private static IPs.

## Prerequisites and limitations

### Prerequisites

- An active Amazon Web Service (AWS) account

### Product versions

- DataStax version 5.11.1
- Operating system: Ubuntu 16.04.6 LTS

# Architecture

## Source architecture

The source could be a Cassandra cluster on an on-premises virtual machine (VM) or on EC2 instances in the AWS Cloud. The following diagram illustrates the second scenario. This example includes four cluster nodes: three seed nodes and one management node. In the source architecture, each node has a single network interface attached.

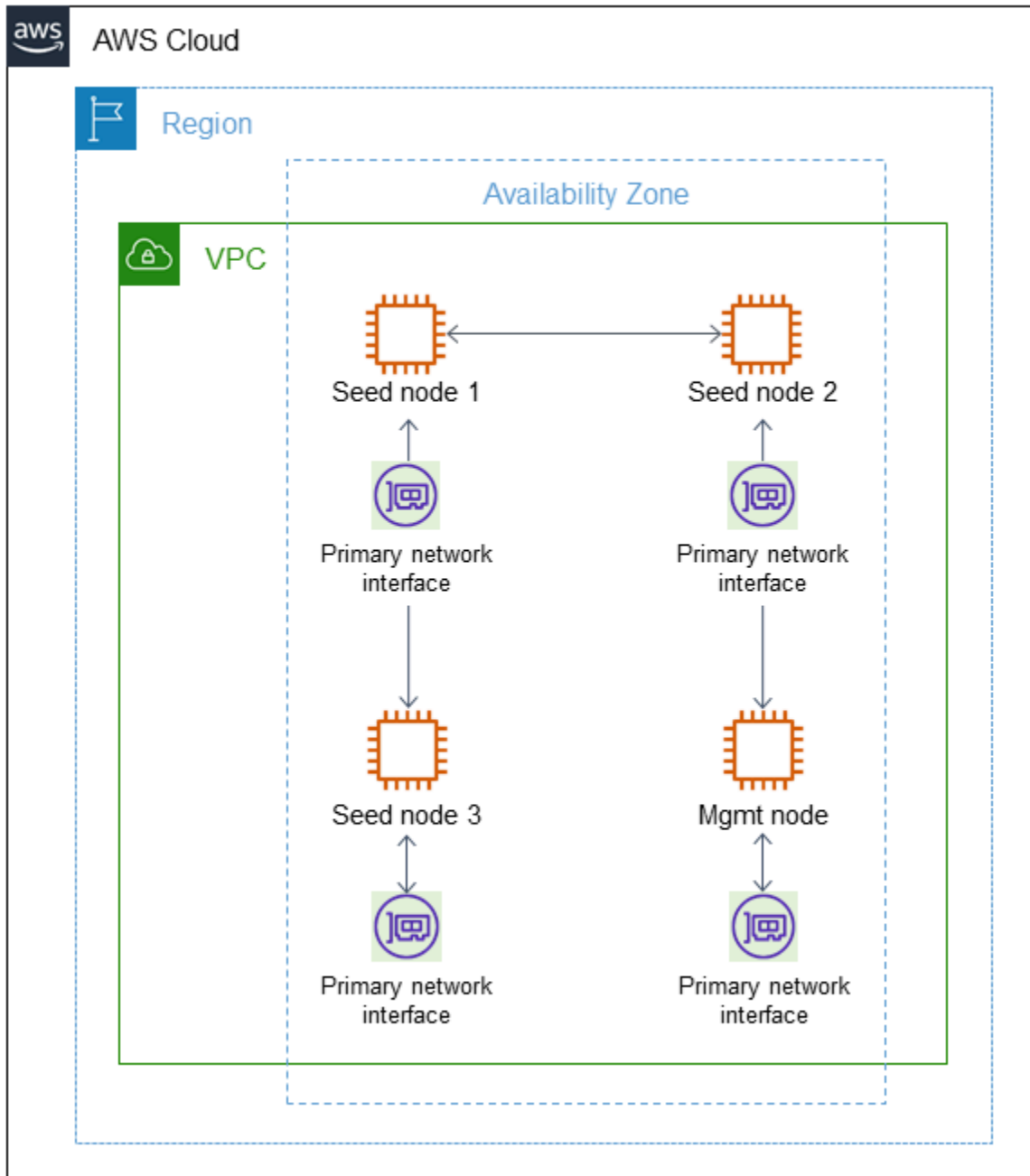

## Target architecture

The destination cluster is hosted on EC2 instances with a secondary elastic network interface attached to each node, as illustrated in the following diagram.

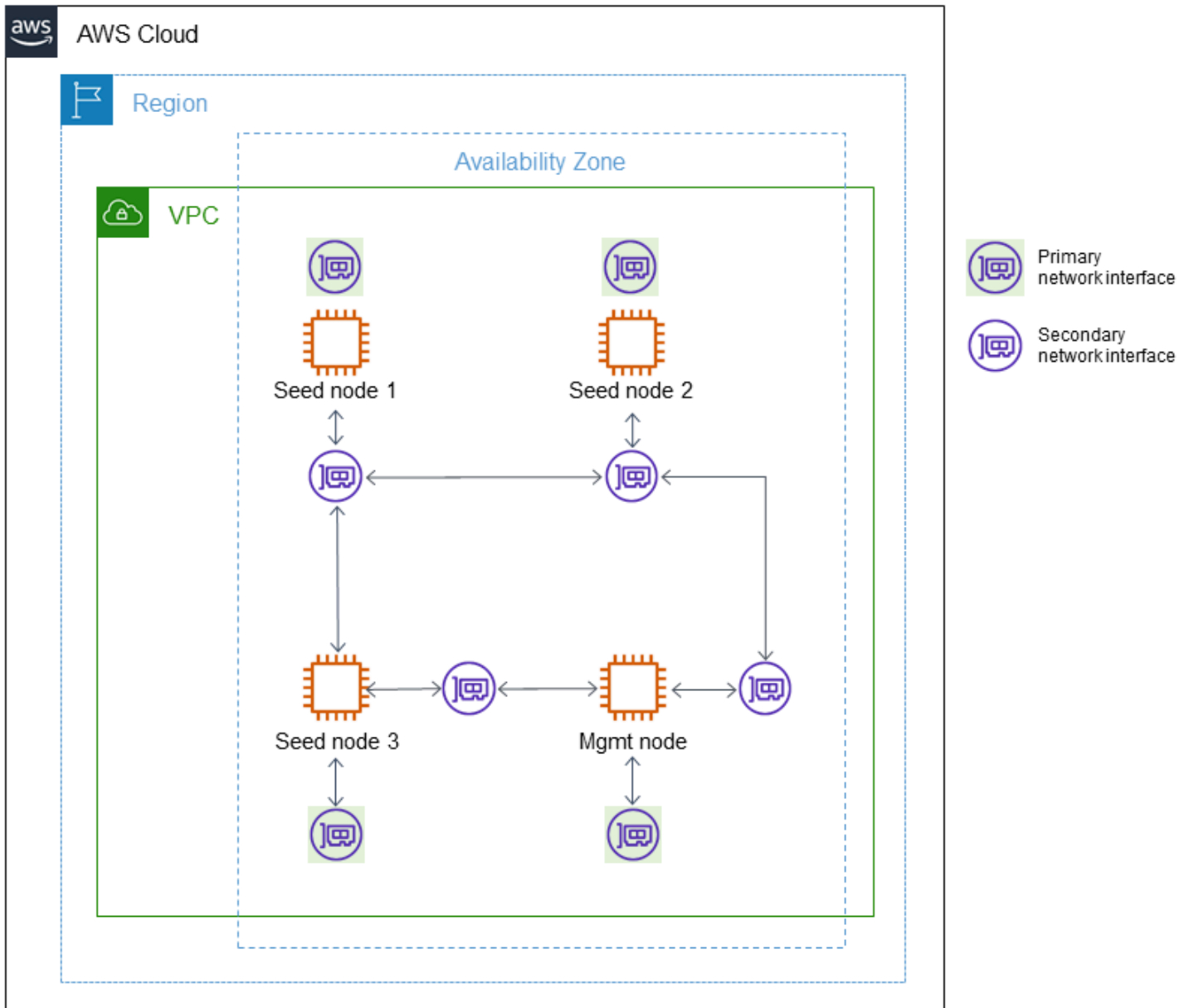

## Automation and scale

You can also automate attaching a second elastic network interface to an EC2 Auto Scaling group, as described in an [AWS Knowledge Center video](#).

## Epics

### Configure a Cassandra cluster on Amazon EC2

Task	Description	Skills required
Launch EC2 nodes to host a Cassandra cluster.	On the <a href="#">Amazon EC2 console</a> , launch four EC2 instances for your Ubuntu nodes in your AWS account. Three (seed) nodes are used for the Cassandra cluster, and the fourth node acts as a cluster management node where you will install DataStax Enterprise (DSE) OpsCenter. For instructions, see the <a href="#">Amazon EC2 documentation</a> .	Cloud engineer
Confirm node communications.	Make sure that the four nodes can communicate with one another over the database and cluster management ports.	Network engineer
Install DSE OpsCenter on the management node.	Install DSE OpsCenter 6.1 from the Debian package on the management node. For instructions, see the <a href="#">DataStax documentation</a> .	DBA
Create a secondary network interface.	Cassandra generates a universal unique identifier (UUID) for each node based on the IP address of the EC2 instance for that node. This UUID is used for distributing virtual nodes	Cloud Engineer

Task	Description	Skills required
	<p>(vnodes) on the ring. When Cassandra is deployed on EC2 instances, IP addresses are assigned automatically to the instances as they are created. In the event of a planned or unplanned outage, the IP address for the new EC2 instance changes, the data distribution changes, and the entire ring has to be rebalanced. This is not desirable. To preserve the assigned IP address, use a <a href="#">secondary elastic network interface</a> with a fixed IP address.</p> <ol style="list-style-type: none"><li>1. On the <a href="#">Amazon EC2 console</a>, choose <b>Network Interfaces, Create network interface</b>.</li><li>2. For <b>Subnet</b>, select the subnet that you created the EC2 instance in.</li><li>3. For <b>Private IPv4 address</b>, choose <b>Auto-assign</b>.</li><li>4. For <b>Security groups</b>, select a security group, and then choose <b>Create network interface</b>.</li></ol> <p>For more information about creating a network interface</p>	

Task	Description	Skills required
	, see the <a href="#">Amazon EC2 documentation</a> .	
Attach the secondary network interface to cluster nodes.	<ol style="list-style-type: none"><li>1. On the <a href="#">Amazon EC2 console</a>, choose <b>Instances</b>.</li><li>2. Select the checkbox for the EC2 instance you created earlier.</li><li>3. Choose <b>Actions, Networking, Attach network interface</b>.</li><li>4. Select the network interface you created in the previous step, and then choose <b>Attach</b>.</li></ol> <p>For more information about attaching a network interface, see the <a href="#">Amazon EC2 documentation</a>.</p>	Cloud engineer

Task	Description	Skills required
Add routes in Amazon EC2 to address asymmetric routing.	<p>When you attach the second network interface, the network will very likely perform asymmetric routing. To avoid this, you can add routes for the new network interfaces.</p> <p>For an in-depth explanation and remediation of asymmetric routing, see the <a href="#">AWS Knowledge Center video</a> or <a href="#">Overcoming Asymmetric Routing on Multi-Homed Servers</a> (article in <i>Linux Journal</i> by Patrick McManus, April 5, 2004).</p>	Network engineer
Update DNS entries to point to the secondary network interface IP.	Point the fully qualified domain name (FQDN) of the node to the IP of the secondary network interface.	Network engineer
Install and configure the Cassandra cluster by using DSE OpsCenter.	When the cluster nodes are ready with the secondary network interfaces, you can install and configure the Cassandra cluster.	DBA

## Recover cluster from node failure

Task	Description	Skills required
Create an AMI for the cluster seed node.	Make a backup of the nodes so you can restore them with	Backup administrator

Task	Description	Skills required
	database binaries in case of node failure. For instructions, see <a href="#">Create an AMI</a> in the Amazon EC2 documentation.	
Recover from node failure.	Replace the failed node with a new EC2 instance launched from the AMI, and attach the secondary network interface of the failed node.	Backup administrator
Verify that the Cassandra cluster is healthy.	When the replacement node is up, verify cluster health in DSE OpsCenter.	DBA

## Related resources

- [Installing DSE OpsCenter 6.1 from the Debian package](#) (DataStax documentation)
- [How to make a secondary network interface work in an Ubuntu EC2 instance](#) (AWS Knowledge Center video)
- [Best Practices for Running Apache Cassandra on Amazon EC2](#) (AWS blog post)



# Extend VRFs to AWS by using AWS Transit Gateway Connect

Created by Adam Till (AWS), Yashar Araghi (AWS), Vikas Dewangan (AWS), and Mohideen HajaMohideen (AWS)

**Environment:** PoC or pilot

**Technologies:** Infrastructure;  
Networking

**AWS services:** AWS Direct  
Connect; AWS Transit  
Gateway

## Summary

Virtual routing and forwarding (VRF) is a feature of traditional networks. It uses isolated logical routing domains, in the form of route tables, to separate network traffic within the same physical infrastructure. You can configure AWS Transit Gateway to support VRF isolation when you connect your on-premises network to AWS. This pattern uses a sample architecture to connect on-premises VRFs to different transit gateway route tables.

This pattern uses transit virtual interfaces (VIFs) in AWS Direct Connect and transit gateway Connect attachments to extend the VRFs. A [transit VIF](#) is used to access one or more Amazon VPC transit gateways that are associated with Direct Connect gateways. A [transit gateway Connect attachment](#) connects a transit gateway with a third-party virtual appliance that is running in a VPC. A transit gateway Connect attachment supports the Generic Routing Encapsulation (GRE) tunnel protocol for high performance, and it supports Border Gateway Protocol (BGP) for dynamic routing.

The approach described in this pattern has the following benefits:

- Using Transit Gateway Connect, you can advertise up to 1,000 routes to the Transit Gateway Connect peer and receive up to 5,000 routes from it. Using the Direct Connect transit VIF feature without Transit Gateway Connect is limited to 20 prefixes per transit gateway.
- You can maintain the traffic isolation and use Transit Gateway Connect to provide hosted services on AWS, regardless of the IP address schemas your customers are using.
- The VRF traffic doesn't need to traverse a public virtual interface. This makes it easier to adhere to compliance and security requirements in many organizations.
- Each GRE tunnel supports up to 5 Gbps, and you can have up to four GRE tunnels per transit gateway Connect attachment. This is faster than many other connection types, such as AWS Site-to-Site VPN connections that support up to 1.25 Gbps.

## Prerequisites and limitations

### Prerequisites

- The required AWS accounts have been created (see the architecture for details)
- Permissions to assume an AWS Identity and Access Management (IAM) role in each account.
- The IAM roles in each account must have permissions to provision AWS Transit Gateway and AWS Direct Connect resources. For more information, see [Authentication and access control for your transit gateways](#) and see [Identity and access management for Direct Connect](#).
- The Direct Connect connections have successfully been created. For more information, see [Create a connection using the Connection wizard](#).

### Limitations

- There are limits for transit gateway attachments to the VPCs in the production, QA, and development accounts. For more information, see [Transit gateway attachments to a VPC](#).
- There are limits for creating and using Direct Connect gateways. For more information, see [AWS Direct Connect quotas](#).

## Architecture

### Target architecture

The following sample architecture provides a reusable solution to deploy transit VIFs with transit gateway Connect attachments. This architecture provides resilience by using multiple Direct Connect locations. For more information, see [Maximum resiliency](#) in the Direct Connect documentation. The on-premises network has production, QA, and development VRFs that are extended to AWS and isolated by using dedicated route tables.

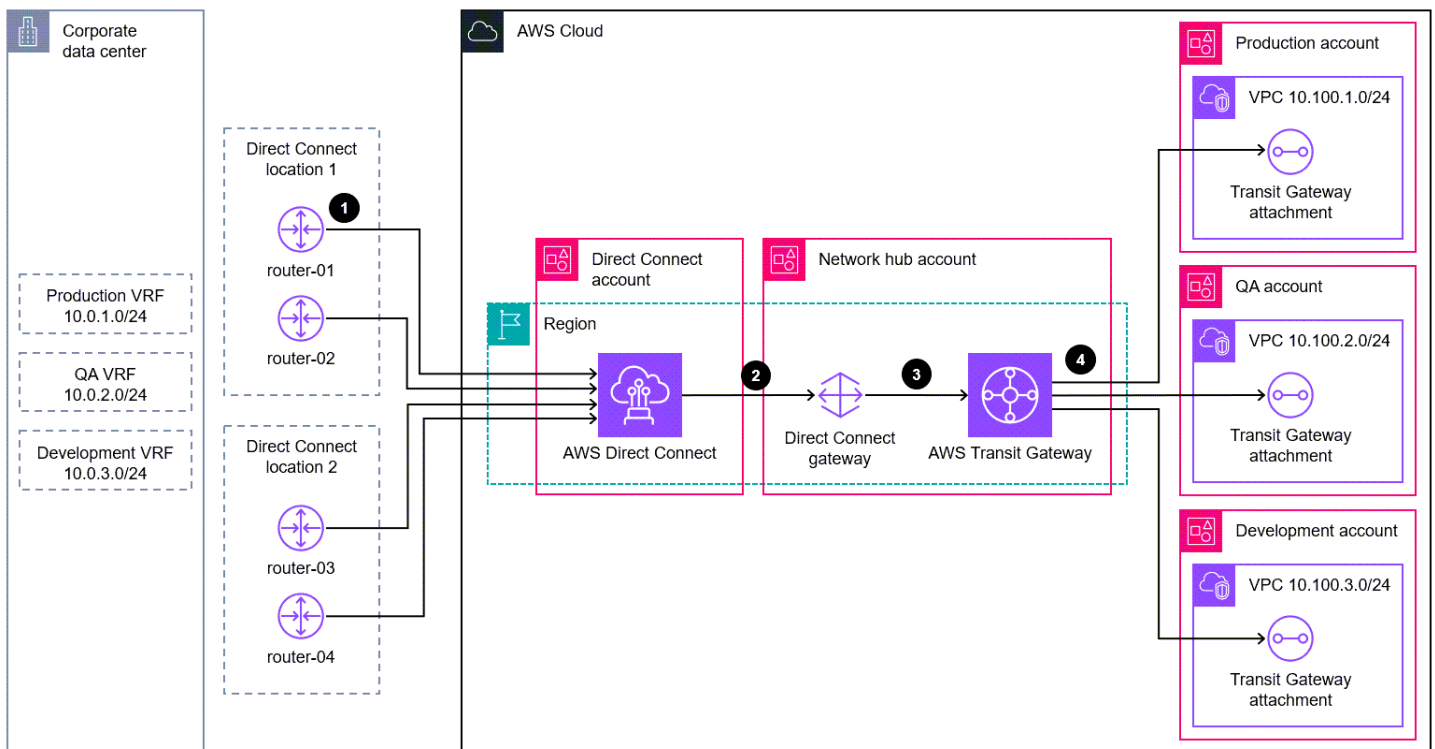

In the AWS environment, two accounts are dedicated to extending the VRFs: a *Direct Connect account* and a *network hub account*. The Direct Connect account contains the connection and the transit VIFs for each router. You create the transit VIFs from the Direct Connect account but deploy them to the network hub account so that you can associate them with the Direct Connect gateway in the network hub account. The network hub account contains the Direct Connect gateway and transit gateway. The AWS resources are connected as follows:

1. Transit VIFs connect the routers in the Direct Connect locations with AWS Direct Connect in the Direct Connect account.
2. A transit VIF connects Direct Connect with the Direct Connect gateway in the network hub account.
3. A [transit gateway association](#) connects the Direct Connect gateway with the transit gateway in the network hub account.
4. [Transit gateway Connect attachments](#) connect the transit gateway with the VPCs in the production, QA, and development accounts.

### *Transit VIF architecture*

The following diagram shows the configuration details for the transit VIFs. This sample architecture uses a VLAN for the tunnel source, but you could also use a loopback.

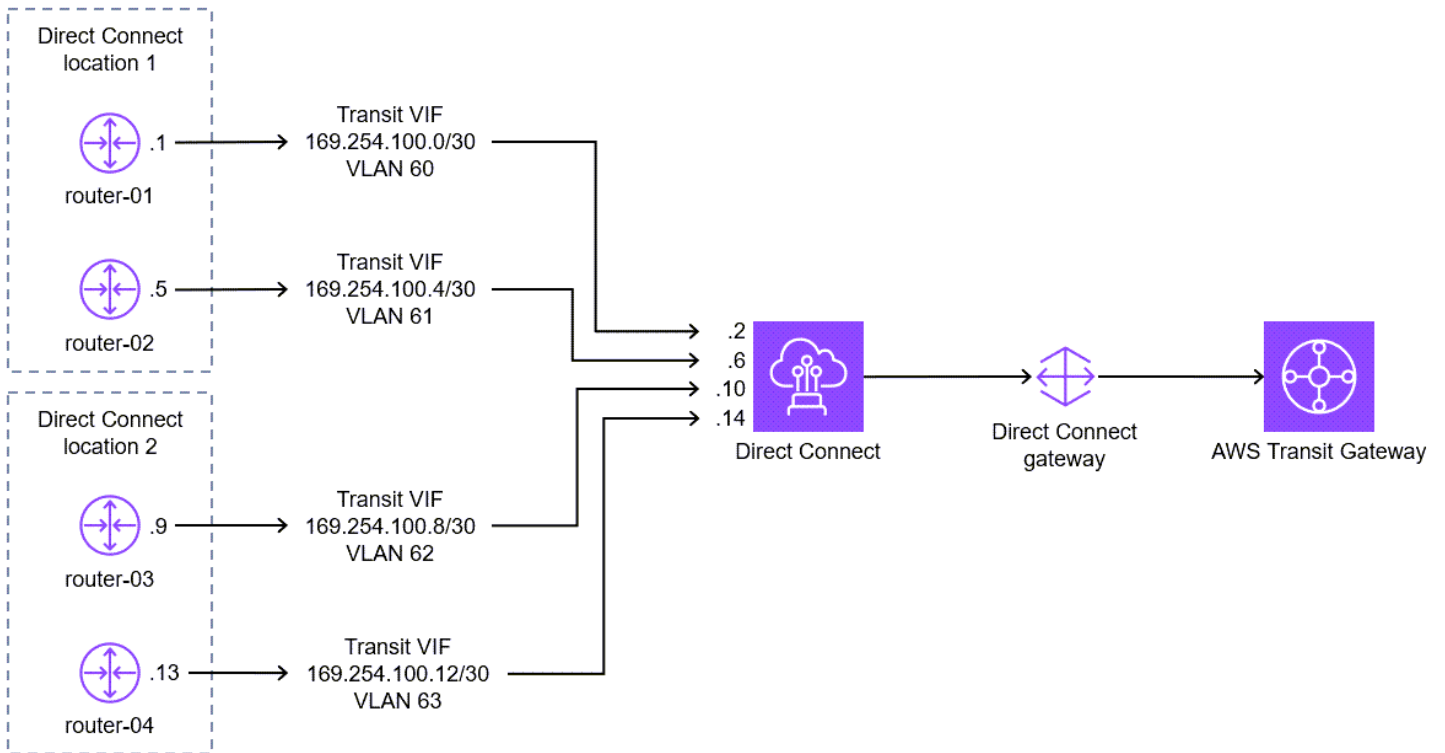

The following are the configuration details, such as autonomous system numbers (ASNs), for the transit VIFs.

Resource	Item	Detail
router-01	ASN	65534
router-02	ASN	65534
router-03	ASN	65534
router-04	ASN	65534
Direct Connect gateway	ASN	64601
Transit gateway	ASN	64600
	CIDR block	10.100.254.0/24

### Transit gateway Connect architecture

The following diagram and tables describe how to configure a single VRF through a transit gateway Connect attachment. For additional VRFs, assign unique tunnel IDs, transit gateway GRE IP addresses, and BGP inside CIDR blocks. The peer GRE IP address matches the router peer IP address from the transit VIF.

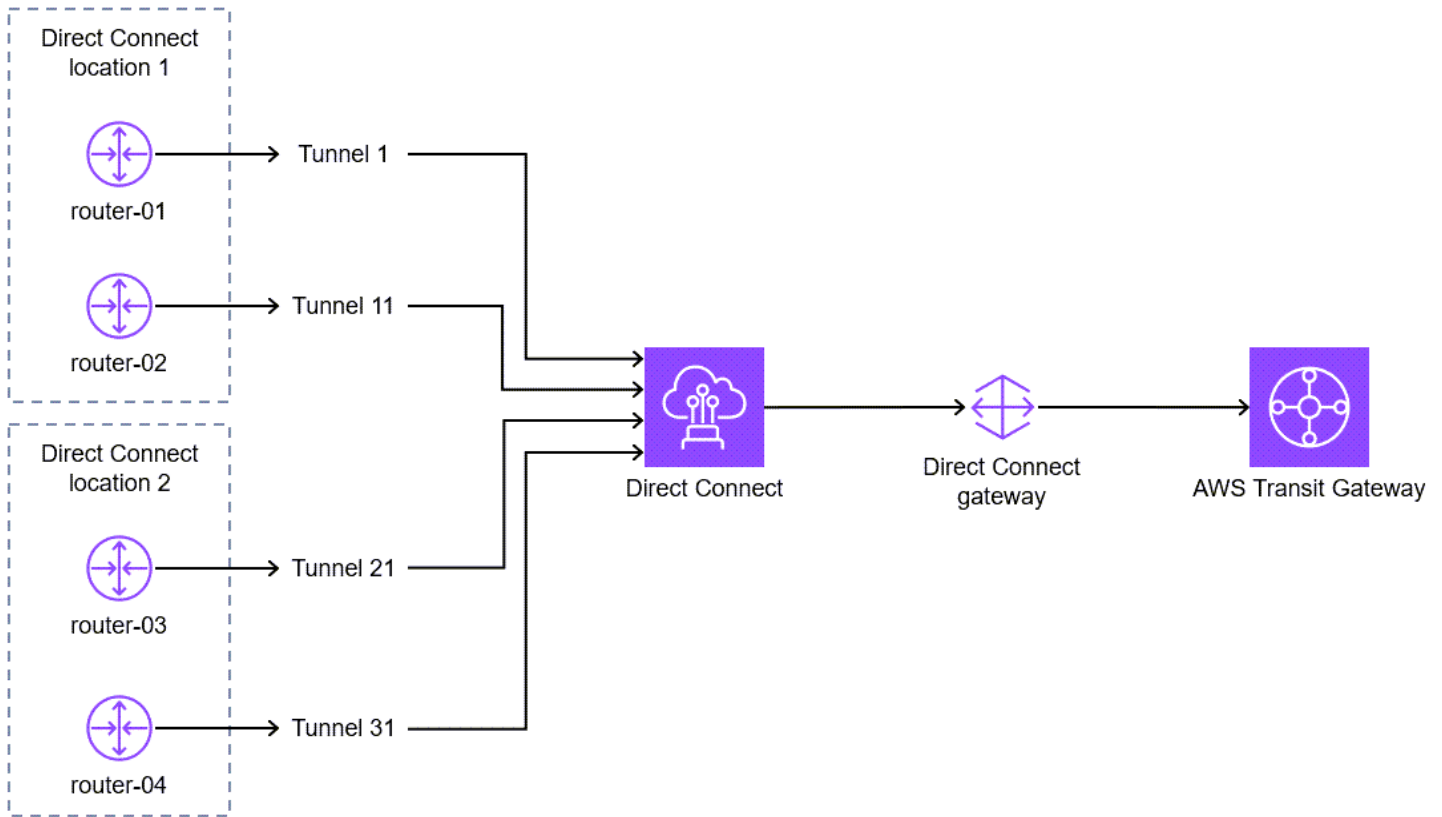

The following table contains router configuration details.

Router	Tunnel	IP address	Source	Destination
router-01	Tunnel 1	169.254.101.17	VLAN 60 169.254.100.1	10.100.254.1
router-02	Tunnel 11	169.254.101.81	VLAN 61 169.254.100.5	10.100.254.11
router-03	Tunnel 21	169.254.101.145	VLAN 62	10.100.254.21

			169.254.100.9	
router-04	Tunnel 31	169.254.1 01.209	VLAN 63	10.100.254.31
			169.254.100.13	

The following table contains transit gateway configuration details.

Tunnel	Transit gateway GRE IP address	Peer GRE IP address	BGP inside CIDR blocks
Tunnel 1	10.100.254.1	VLAN 60 169.254.100.1	169.254.101.16/29
Tunnel 11	10.100.254.11	VLAN 61 169.254.100.5	169.254.101.80/29
Tunnel 21	10.100.254.21	VLAN 62 169.254.100.9	169.254.101.144/29
Tunnel 31	10.100.254.31	VLAN 63 169.254.100.13	169.254.101.208/29

## Deployment

The [Epics](#) section describes how to deploy a sample configuration for a single VRF across multiple customer routers. After steps 1–5 are complete, you can create new transit gateway Connect attachments by using steps 6–7 for every new VRF that you’re extending into AWS:

1. Create the transit gateway.
2. Create a Transit Gateway route table for each VRF.
3. Create the transit virtual interfaces.
4. Create the Direct Connect gateway.

5. Create the Direct Connect gateway virtual interface and gateway associations with allowed prefixes.
6. Create the transit gateway Connect attachment.
7. Create the Transit Gateway Connect peers.
8. Associate the transit gateway Connect attachment with the route table.
9. Advertise routes to the routers.

## Tools

### AWS services

- [AWS Direct Connect](#) links your internal network to a Direct Connect location over a standard Ethernet fiber-optic cable. With this connection, you can create virtual interfaces directly to public AWS services while bypassing internet service providers in your network path.
- [AWS Transit Gateway](#) is a central hub that connects virtual private clouds (VPCs) and on-premises networks.
- [Amazon Virtual Private Cloud \(Amazon VPC\)](#) helps you launch AWS resources into a virtual network that you've defined. This virtual network resembles a traditional network that you'd operate in your own data center, with the benefits of using the scalable infrastructure of AWS.

## Epics

### Plan the architecture

Task	Description	Skills required
Create custom architecture diagrams.	<ol style="list-style-type: none"><li>1. In the <a href="#">Attachments</a> section, download the diagram template.</li><li>2. Open the attached diagram in Microsoft Office PowerPoint.</li><li>3. On the <b>Architecture overview</b> slide, customize</li></ol>	Cloud architect, Network administrator

Task	Description	Skills required
	<p>the architecture diagram for your environment. Identify the on-premises VRFs that need to be extended into your AWS environment.</p> <p>4. On the <b>Transit VIF</b> slide, customize the architecture diagram. Identify the AS numbers of the routers, the Direct Connect gateway, and the transit gateway. Identify the IP addresses at each end of the transit VIF.</p> <p>5. On the <b>Transit Gateway Connect</b> slide, customize an architecture diagram for each VRF. Identify all required IP addresses necessary to configure the routers and the Transit Gateway Connect peers.</p>	

## Create the Transit Gateway resources

Task	Description	Skills required
Create the transit gateway.	<ol style="list-style-type: none"> <li>1. Sign in to the network hub account.</li> <li>2. Follow the instructions in <a href="#">Create a transit gateway</a>. Note the following for this pattern:</li> </ol>	Network administrator, Cloud architect



Task	Description	Skills required
	<ul style="list-style-type: none"><li>• For <b>Amazon side Autonomous System Number (ASN)</b>, enter a unique ASN. For the purposes of this example, the ASN is 64600.</li><li>• Select <b>DNS support</b>.</li><li>• For this sample architecture, <b>VPN ECMP support, Default route table association, Default route table proration, and Multicast support</b> are not required.</li><li>• For <b>Transit gateway CIDR blocks</b>, enter the IPv4 CIDR blocks for your transit gateway. For the purposes of this example, the CIDR block is 10.100.254.0/24 .</li></ul>	

Task	Description	Skills required
Create the transit gateway route table.	<p>Follow the instructions in <a href="#">Create a transit gateway route table</a>. Note the following for this pattern:</p> <ul style="list-style-type: none"><li>• For <b>Name tag</b>, provide a name for the transit gateway route table. We recommend using a name that corresponds to the VRF, such as <code>routetable-dev-vrf</code>.</li><li>• For <b>Transit gateway ID</b>, choose the transit gateway that you created previously.</li></ul>	Cloud architect, Network administrator

## Create the transit virtual interfaces

Task	Description	Skills required
Create the transit virtual interfaces.	<ol style="list-style-type: none"><li>1. Sign in to the Direct Connect account.</li><li>2. Follow the instructions in <a href="#">Create a transit virtual interface to the Direct Connect gateway</a>. Note the following for this pattern:<ul style="list-style-type: none"><li>• For <b>Virtual interface name</b>, enter a name for the transit VIF. We recommend using a name that corresponds to the router, such as</li></ul></li></ol>	Cloud architect, Network administrator

Task	Description	Skills required
	<p>transit-vif-router-01 .</p> <ul style="list-style-type: none"><li>• For <b>Connection</b>, select the router, such as router-01 .</li><li>• For <b>Virtual interface owner</b>, enter the account ID of the network hub account. For instructions, see <a href="#">View your AWS account ID</a>.</li><li>• For <b>Direct Connect gateway</b>, do not make any selection. You attach the Direct Connect gateway in a subsequent step.</li><li>• For <b>VLAN</b>, enter the VLAN of the router, such as 60.</li><li>• For <b>BGP ASN</b>, enter the ASN of the router, such as 65534.</li><li>• Under <b>Additional Settings</b>, do the following:<ul style="list-style-type: none"><li>• Choose <b>IPv4</b>.</li><li>• For <b>Your router peer ip</b>, enter the router peer IP address, such as 169.254.100.1 .</li><li>• For <b>Amazon router peer ip</b>, enter the</li></ul></li></ul>	

Task	Description	Skills required
	<p>Amazon router peer IP, such as 169.254.100.2 .</p> <ul style="list-style-type: none"> <li>For <b>BGP authentication key</b>, a password is required. If this is left blank, AWS creates a key that is only accessible in this account.</li> </ul> <p>3. Repeat these instructions to create all transit VIFs for the VRF.</p>	

### Create the Direct Connect resources

Task	Description	Skills required
Create a Direct Connect gateway.	<ol style="list-style-type: none"> <li>Sign in to the network hub account.</li> <li>Follow the instructions in <a href="#">Creating a Direct Connect gateway</a>. Note the following for this pattern: <ul style="list-style-type: none"> <li>For <b>Amazon side ASN</b>, enter the ASN of the Direct Connect gateway, such as 64601.</li> <li>Do not choose a virtual private gateway.</li> </ul> </li> </ol>	Cloud architect, Network administrator
Attach the Direct Connect gateway to the transit VIFs.	<ol style="list-style-type: none"> <li>In the network hub account, open the AWS Direct Connect console</li> </ol>	Cloud architect, Network administrator

Task	Description	Skills required
	<p>at <a href="https://console.aws.amazon.com/directconnect/v2/">https://console.aws.amazon.com/directconnect/v2/</a>.</p> <ol style="list-style-type: none"> <li>2. In the navigation pane, choose <b>Virtual Interfaces</b>.</li> <li>3. Select a new transit VIF, and then choose <b>Accept</b>.</li> <li>4. Choose the Direct Connect gateway you created.</li> <li>5. Repeat these instructions for each transit VIF.</li> </ol>	
<p>Create the Direct Connect gateway associations with allowed prefixes.</p>	<p>In the network hub account, follow the instructions in <a href="#">To associate a transit gateway</a>. Note the following for this pattern:</p> <ul style="list-style-type: none"> <li>• For <b>Gateways</b>, choose the transit gateway you created previously.</li> <li>• For <b>Allowed prefixes</b>, enter the CIDR block assigned to the transit gateway, such as <code>10.100.254.0/24</code> .</li> </ul> <p>Creating this association automatically creates a Transit Gateway attachment that has a Direct Connect Gateway resource type. This attachment does not need to be associated with a transit gateway route table.</p>	<p>Cloud architect, Network administrator</p>

Task	Description	Skills required
Create the transit gateway Connect attachment.	<ol style="list-style-type: none"><li>1. In the network hub account, open the Amazon VPC console at <a href="https://console.aws.amazon.com/vpc/">https://console.aws.amazon.com/vpc/</a>.</li><li>2. In the navigation pane, choose <b>Transit gateway attachments</b>.</li><li>3. Choose <b>Create transit gateway attachment</b>.</li><li>4. For <b>Name tag</b>, enter a name for the attachment. We recommend using a name that corresponds to the VRF, such as PROD-VRF.</li><li>5. For <b>Transit gateway ID</b>, choose the transit gateway you created previously.</li><li>6. For <b>Attachment type</b>, choose <b>Connect</b>.</li><li>7. For <b>Transport attachment ID</b>, choose the Direct Connect gateway you created previously.</li><li>8. Choose <b>Create transit gateway attachment</b>.</li><li>9. Repeat this step for each VRF that you are extending.</li></ol>	Cloud architect, Network administrator

Task	Description	Skills required
Create the Transit Gateway Connect peers.	<p>1. In the network hub account, follow the instructions in <a href="#">Create a Transit Gateway Connect peer (GRE tunnel)</a>. Note the following for this pattern:</p> <ul style="list-style-type: none"><li>• For <b>Name tag</b>, enter a name for the Transit Gateway Connect peer. We recommending using a name that corresponds with the router, such as <code>connectpeer-router01</code> .</li><li>• For <b>Transit gateway GRE address</b>, enter the assigned IP address from the transit gateway CIDR block, such as <code>10.100.254.1</code> .</li><li>• For <b>Peer GRE address</b>, enter the IP address assigned to the VLAN created on the router for the transit VIF, such as <code>169.254.100.1</code> . Provided that AWS can reach the IP address, you can use any interface, such as VLAN or Loopback, for the peer GRE address.</li><li>• For <b>BGP Inside CIDR Blocks (IPv4)</b>, enter</li></ul>	

Task	Description	Skills required
	<p>the BGP inside CIDR block IP address, such as 169.254.101.16/29 .</p> <ul style="list-style-type: none"> <li>• For <b>Peer ASN</b>, enter the ASN of the router, such as 65534.</li> </ul> <p>2. Repeat these instructions to create a GRE tunnel for each router.</p>	

### Advertise routes to the routers

Task	Description	Skills required
Advertise the routes.	<p>Associate the new transit gateway Connect attachment with the route table you created previously for this VRF. For example, associate the production transit gateway Connect attachment with the Production-VRF route table.</p> <p>Create a static route for the prefix that is advertised to the routers.</p> <ol style="list-style-type: none"> <li>1. Sign in to the network hub account.</li> <li>2. Open the Amazon VPC console at <a href="https://console.aws.amazon.com/vpc/">https://console.aws.amazon.com/vpc/</a>.</li> </ol>	Network administrator, Cloud architect



Task	Description	Skills required
	<ol style="list-style-type: none"><li>3. In the navigation pane, under <b>Transit Gateways</b>, choose <b>Transit gateway route tables</b>.</li><li>4. Select the Production-VRF route table.</li><li>5. On the <b>Actions</b> menu, choose <b>Create static route</b>.</li><li>6. For <b>CIDR</b>, enter the CIDR block for the advertised route to the transit gateway attachment in the target VPC, such as <code>10.100.1.0/24</code>.</li><li>7. For <b>Choose Attachment</b>, choose the relevant transit gateway Connect attachment.</li><li>8. Choose <b>Create static route</b>.</li></ol>	

## Related resources

### AWS documentation

- Direct Connect documentation
  - [Working with Direct Connect gateways](#)
  - [Transit gateway associations](#)
  - [AWS Direct Connect virtual interfaces](#)
- Transit Gateway documentation
  - [Working with transit gateways](#)
  - [Transit gateway attachments to a Direct Connect gateway](#)
  - [Transit gateway Connect attachments and Transit Gateway Connect peers](#)

- [Create a transit gateway Connect attachment](#)

## AWS blog posts

- [Segmenting hybrid networks with AWS Transit Gateway connect](#)
- [Using AWS Transit Gateway connect to extend VRFs and increase IP prefix advertisement](#)

## Attachments

To access additional content that is associated with this document, unzip the following file:  
[attachment.zip](#)

# Get Amazon SNS notifications when the key state of an AWS KMS key changes

Created by Shubham Harsora (AWS), Aromal Raj Jayarajan (AWS), and Navdeep Pareek (AWS)

<b>Code repository:</b> <a href="#">aws-kms-deletion-notification</a>	<b>Environment:</b> PoC or pilot	<b>Technologies:</b> Infrastructure; CloudNative; DevOps; Security, identity, compliance
<b>Workload:</b> All other workloads	<b>AWS services:</b> Amazon EventBridge; AWS KMS; Amazon SNS	

## Summary

The data and metadata associated with an AWS Key Management Service (AWS KMS) key is lost when that key is deleted. The deletion is irreversible and you can't recover lost data (including encrypted data). You can prevent data loss by setting up a notification system to alert you of status changes to [key states](#) of your AWS KMS keys.

This pattern shows you how to monitor status changes to AWS KMS keys by using Amazon EventBridge and Amazon Simple Notification Service (Amazon SNS) to issue automated notifications whenever the key state of an AWS KMS key changes to `Disabled` or `PendingDeletion`. For example, if a user tries to disable or delete an AWS KMS key, you will receive an email notification with details about the attempted status change. You can also use this pattern to schedule the deletion of AWS KMS keys.

## Prerequisites and limitations

### Prerequisites

- An active AWS account with an AWS Identity and Access Management (IAM) user
- An [AWS KMS key](#)

# Architecture

## Technology stack

- Amazon EventBridge
- AWS Key Management Service (AWS KMS)
- Amazon Simple Notification Service (Amazon SNS)

## Target architecture

The following diagram shows an architecture for building an automated monitoring and notification process for detecting any changes to the state of an AWS KMS key.

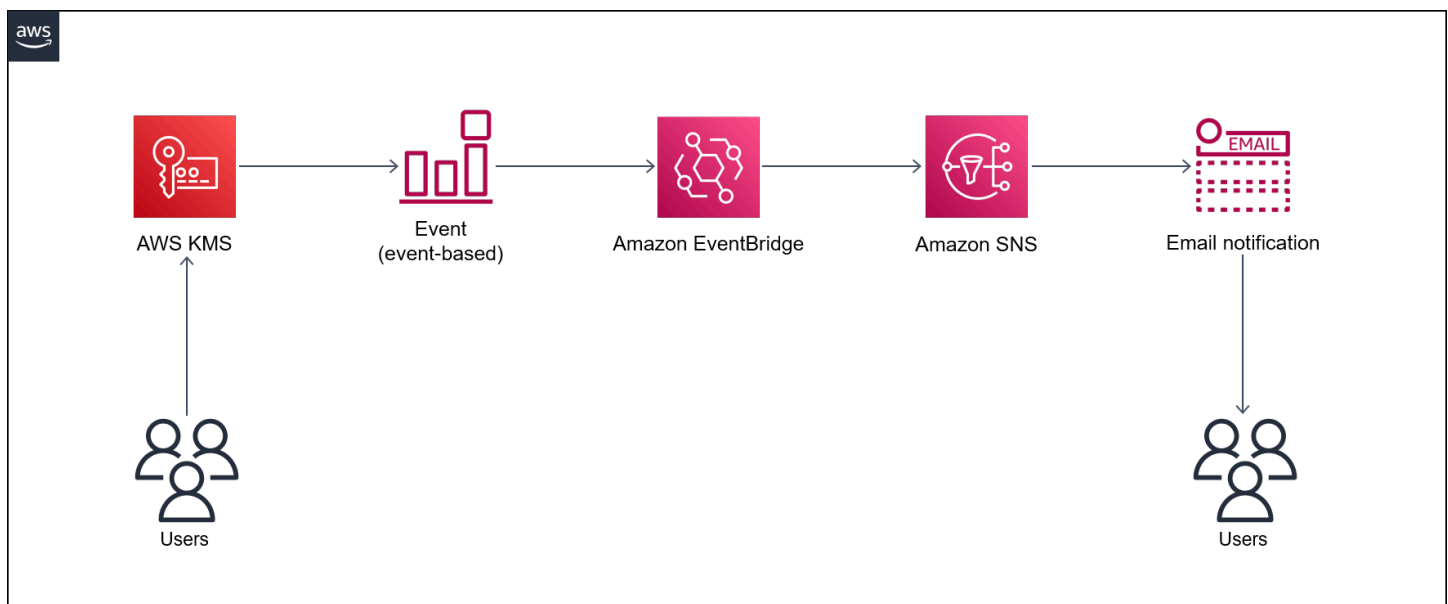

The diagram shows the following workflow:

1. A user disables or schedules the deletion of an AWS KMS key.
2. An EventBridge rule evaluates the scheduled `Disabled` or `PendingDeletion` event.
3. The EventBridge rule invokes the Amazon SNS topic.
4. Amazon SNS sends an email notification message to the users.

**Note:** You can customize the email message to meet your organization's needs. We recommend including information about the entities where the AWS KMS key is used. This can help users

understand the impact of deleting the AWS KMS key. You can also schedule a reminder email notification that's sent one or two days before the AWS KMS key is deleted.

## Automation and scale

The AWS CloudFormation stack deploys all the necessary resources and services for this pattern to work. You can implement the pattern independently in a single account, or by using [AWS CloudFormation StackSets](#) for multiple independent accounts or [organizational units](#) in AWS Organizations.

## Tools

- [AWS CloudFormation](#) helps you set up AWS resources, provision them quickly and consistently, and manage them throughout their lifecycle across AWS accounts and AWS Regions. The CloudFormation template for this pattern describes all the AWS resources that you want, and CloudFormation provisions and configures those resources for you.
- [Amazon EventBridge](#) is a serverless event bus service that helps you connect your applications with real-time data from a variety of sources. EventBridge delivers a stream of real-time data from your own applications and AWS services, and it routes that data to targets such as AWS Lambda. EventBridge simplifies the process of building event-driven architectures.
- [AWS Key Management Service \(AWS KMS\)](#) helps you create and control cryptographic keys to help protect your data.
- [Amazon Simple Notification Service \(Amazon SNS\)](#) helps you coordinate and manage the exchange of messages between publishers and clients, including web servers and email addresses.

## Code

The code for this pattern is available in the GitHub [Monitor AWS KMS keys disable and scheduled deletion](#) repository.

# Epics

## Deploy the CloudFormation template

Task	Description	Skills required
Clone the repository.	<p>Clone the GitHub <a href="#">Monitor AWS KMS keys disable and scheduled deletion</a> repository to your local machine by running the following command:</p> <pre>git clone https://github.com/aws-samples/aws-kms-deletion-notification</pre>	AWS administrator, Cloud architect
Update the template's parameters.	<p>In a code editor, open the <code>Alerting-KMS-Events.yaml</code> CloudFormation template that you cloned from the repository, and then update the following parameters:</p> <ul style="list-style-type: none"><li>• For <code>DestinationEmailAddress</code>, enter an active email address that you plan to use for receiving the SNS notification.</li><li>• For <code>SNSTopicName</code>, enter a name for your SNS topic.</li></ul>	AWS administrator, Cloud architect
Deploy the CloudFormation template.	<ol style="list-style-type: none"><li>1. Sign in to the AWS Management Console and</li></ol>	AWS administrator, Cloud architect

Task	Description	Skills required
	<p>open the <a href="#">CloudFormation console</a>.</p> <ol style="list-style-type: none"> <li>In the navigation pane, choose <b>Create stack</b>, and then choose <b>With new resources (standard)</b>.</li> <li>On the <b>Identify resources</b> page, choose <b>Next</b>.</li> <li>On the <b>Specify template</b> page, for <b>Template source</b>, select <b>Upload a template file</b>.</li> <li>Choose <b>Choose file</b>, select the <code>Alerting-KMS-Events.yaml</code> file from your cloned GitHub repository, and then choose <b>Next</b>.</li> <li>For <b>Stack name</b>, enter your stack name.</li> <li>Choose <b>Submit</b>.</li> </ol>	

## Confirm the subscription

Task	Description	Skills required
Confirm the subscription email.	After the CloudFormation template successfully deploys, Amazon SNS sends a subscription confirmation message to the email address that you provided in the CloudFormation template.	AWS administrator, Cloud architect

Task	Description	Skills required
	<p>To receive notifications, you must confirm this email subscription. For more information, see <a href="#">Confirm the subscription</a> in the Amazon SNS Developer Guide.</p>	

## Test the subscription notification

Task	Description	Skills required
<p>Disable AWS KMS keys.</p>	<ol style="list-style-type: none"> <li>1. Sign in to the AWS Management Console and open the <a href="#">AWS KMS console</a>.</li> <li>2. To change the Region, choose the name of the currently displayed Region, and then choose the Region to which you want to switch.</li> <li>3. In the navigation pane, choose <b>Customer managed keys</b>.</li> <li>4. Select the check box for the AWS KMS key that you want to enable or disable.</li> <li>5. To disable the AWS KMS key, choose <b>Key actions</b>, and then choose <b>Disable</b>.</li> </ol>	<p>AWS administrator</p>



Task	Description	Skills required
Validate the subscription.	Confirm that you received the Amazon SNS notification email.	AWS administrator

## Clean up resources

Task	Description	Skills required
Delete the CloudFormation stack.	<ol style="list-style-type: none"><li>1. Sign in to the AWS Management Console and open the <a href="#">CloudFormation console</a>.</li><li>2. In the navigation pane, choose <b>Stacks</b>.</li><li>3. Select that stack that you created previously, and then choose <b>Delete</b>.</li></ol>	AWS administrator

## Related resources

- [AWS CloudFormation](#) (AWS documentation)
- [Creating a stack on the AWS CloudFormation console](#) (AWS CloudFormation documentation)
- [Building event-driven architectures on AWS](#) (AWS Workshop Studio documentation)
- [AWS Key Management Service Best Practices](#) (AWS Whitepaper)
- [Security best practices for AWS Key Management Service](#) (AWS KMS Developer Guide)

## Additional information

Amazon SNS provides in-transit encryption by default. To align with security best practices, you can also enable server-side encryption for Amazon SNS by using an AWS KMS customer managed key.

# Mainframe modernization: DevOps on AWS with Micro Focus

Created by Kevin Yung (AWS)

<b>Source:</b> IBM z/OS Mainframe	<b>Target:</b> AWS	<b>R Type:</b> N/A
<b>Environment:</b> PoC or pilot	<b>Technologies:</b> DevOps; Infrastructure	<b>AWS services:</b> Amazon EC2; AWS CloudFormation; AWS CodeBuild; AWS CodeCommit; AWS CodeDeploy; AWS Systems Manager; AWS CodePipeline

## Summary

### Customer challenges

Organizations that run core applications on mainframe hardware usually encounter a few challenges when the hardware needs to scale up to meet the demands of digital innovations. These challenges include the following constraints.

- Mainframe development and test environments are unable to scale due to the inflexibility of mainframe hardware components and the high cost of changing.
- Mainframe development is facing skill shortages, because new developers are not familiar and not interested in the traditional mainframe development tools. Modern technology such as containers, continuous integration/continuous delivery (CI/CD) pipelines, and modern test frameworks are not available in mainframe development.

### Pattern outcomes

To address these challenges, Amazon Web Services (AWS) and Micro Focus, an AWS Partner Network (APN) Partner, have collaborated to create this pattern. The solution is designed to help you achieve the following outcomes.

- Improved developer productivity. Developers can be given new mainframe development instances within minutes.

- Use of the AWS Cloud to create new mainframe test environments with virtually unlimited capacity.
- Rapid provisioning of new mainframe CI/CD infrastructure. Provisioning on AWS can be completed within an hour by using AWS CloudFormation and AWS Systems Manager.
- Native use of AWS DevOps tools for mainframe development, including AWS CodeBuild, AWS CodeCommit, AWS CodePipeline, AWS CodeDeploy, and Amazon Elastic Container Registry (Amazon ECR).
- Transform traditional waterfall development to agile development in mainframe projects.

## Technologies summary

In this pattern, the target stack contains the following components.

Logical components	Implementation solutions	Description
Source code repositories	Micro Focus AccuRev Server, CodeCommit, Amazon ECR	<p>Source code management – The solution uses two types of source code.</p> <ul style="list-style-type: none"> <li>• Mainframe source code, for example COBOL, JCL, etc.</li> <li>• AWS infrastructure templates and automation scripts</li> </ul> <p>Both types of source code need version control, but they are managed in different SCMs. Source code deployed into mainframe or Micro Focus Enterprise Servers is managed in Micro Focus AccuRev Server. AWS templates and automation scripts are managed in CodeCommit. Amazon ECR</p>

Enterprise developer instances	Amazon Elastic Compute Cloud (Amazon EC2), Micro Focus Enterprise Developer for Eclipse	is used for the Docker image repositories.  Mainframe developers can develop code in Amazon EC2 by using Micro Focus Enterprise Developer for Eclipse. This eliminates the need to rely on mainframe hardware to write and test code.
Micro Focus license management	Micro Focus License Manager	For centralized Micro Focus license management and governance, the solution uses Micro Focus License Manager to host the required license.
CI/CD pipelines	CodePipeline, CodeBuild, CodeDeploy, Micro Focus Enterprise Developer in a container, Micro Focus Enterprise Test Server in a container, Micro Focus Enterprise Server	Mainframe development teams need CI/CD pipelines to perform code compilation, integration tests, and regression tests. In AWS, CodePipeline and CodeBuild can work with Micro Focus Enterprise Developer and Enterprise Test Server in a container natively.

## Prerequisites and limitations

### Prerequisites

Name	Description
py3270	py3270 is a Python interface to x3270, an IBM 3270 terminal emulator. It provides an API to a x3270 or s3270 subprocess.

x3270	x3270 is an IBM 3270 terminal emulator for the X Window System and Windows. This can be used by developer for unit testing locally.
Robot-Framework-Mainframe-3270-Library	Mainframe3270 is a library for Robot Framework based on py3270 project.
Micro Focus Verastream	Micro Focus Verastream is an integration platform that enables testing mainframe assets the way that mobile apps, web applications, and SOA web services are tested.
Micro Focus Unified Functional Testing (UFT) installer and license	Micro Focus Unified Functional Testing is software that provides functional and regression test automation for software applications and environments.
Micro Focus Enterprise Server installer and license	Enterprise Server provides the runtime environment for mainframe applications.
Micro Focus Enterprise Test Server installer and license	Micro Focus Enterprise Test Server is an IBM mainframe application test environment
Micro Focus AccuRev installer and license for Server, and Micro Focus AccuRev installer and license for Windows and Linux operating systems	AccuRev provides source code management (SCM). The AccuRev system is designed for use by a team of people who are developing a set of files.
Micro Focus Enterprise Developer for Eclipse installer, patch and license	Enterprise Developer provide mainframe developer a platform to develop and maintain the core mainframe online and batch applications.

## Limitations

- Building a Windows Docker image is not supported in CodeBuild. This [reported issue](#) needs support from Windows Kernel/HCS and Docker teams. The work-around is to create a Docker image build runbook by using Systems Manager. This pattern uses the work-around to build

Micro Focus Enterprise Developer for Eclipse and Micro Focus Enterprise Test Server Container images.

- Virtual private cloud (VPC) connectivity from CodeBuild is not supported in Windows yet, so the pattern does not use Micro Focus License Manager to manage licenses in Micro Focus Enterprise Developer and Micro Focus Enterprise Test Server containers.

## Product versions

- Micro Focus Enterprise Developer 5.5 or later
- Micro Focus Enterprise Test Server 5.5 or later
- Micro Focus Enterprise Server 5.5 or later
- Micro Focus AccuRev 7.x or later
- Windows Docker base image for Micro Focus Enterprise Developer and Enterprise Test Server: **microsoft/dotnet-framework-4.7.2-runtime**
- Linux Docker base image for AccuRev client: **amazonlinux:2**

## Architecture

### Mainframe environment

In conventional mainframe development, the developers need to use mainframe hardware to develop and test programs. They face capacity limitations, for example restricted million instructions per second (MIPS) for the dev/test environment, and they must rely on the tools that are available on the mainframe computers.

In many organizations, mainframe development follows the waterfall development methodology, with teams relying on long cycles to release changes. These release cycles are usually longer than digital product development.

The following diagram shows multiple mainframe projects sharing mainframe hardware for their development. In mainframe hardware, it is expensive to scale out a development and test environment for more projects.

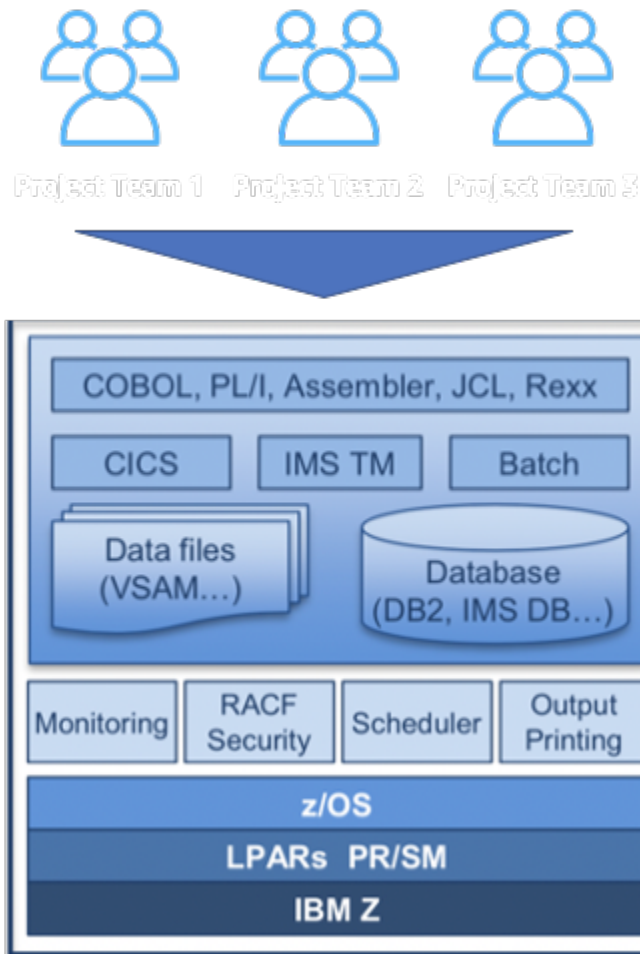

## AWS architecture

This pattern extends mainframe development to the AWS Cloud. First, it uses Micro Focus AccuRev SCM to host the mainframe source code on AWS. Then it makes Micro Focus Enterprise Developer and Micro Focus Enterprise Test Server available for building and testing the mainframe code on AWS.

The following sections describe the pattern's three major components.

### 1. SCM

In AWS, the pattern uses Micro Focus AccuRev to create a set of SCM workspaces and version control for the mainframe source code. Its stream-based architecture enables parallel mainframe

development for multiple teams. To merge a change, AccuRev uses the promote concept. To add that change to other workspaces, AccuRev uses the update concept.

At the project level, each team can create one or more streams in AccuRev to track project level changes. These are called project streams. These project streams are inherited from the same parent stream. The parent stream is used to merge the changes from different project streams.

Each project stream can promote code to AccuRev, and a promote post trigger is set up to initiate the AWS CI/CD pipeline. The successful build for a project stream change can be promoted to its parent stream for more regression tests.

Usually, the parent stream is called the system integration stream. When there is a promotion from a project stream to a system integration stream, a post promotion trigger initiates another CI/CD pipeline to run regression tests.

In addition to mainframe code, this pattern includes AWS CloudFormation templates, Systems Manager Automation documents, and scripts. Following infrastructure-as-code best practices, they are version-controlled in AWS CodeCommit.

If you need to synchronize mainframe code back to a mainframe environment for deployment, Micro Focus provides the Enterprise Sync solution, which synchronizes code from the AccuRev SCM back to the mainframe SCM.

## 2. Developer and test environments

In a large organization, scaling more than a hundred or even more than a thousand mainframe developers is challenging. To address this constraint, the pattern uses Amazon EC2 Windows instances for development. On the instances, Micro Focus Enterprise Developer for Eclipse tools are installed. The developer can perform all mainframe code test and debugging locally on the instance.

AWS Systems Manager State Manager and Automation documents are used to automate the developer instance provisioning. The average time to create a developer instance is within 15 minutes. The following software and configurations are prepared.

- AccuRev Windows client for checking out and committing source code into AccuRev
- Micro Focus Enterprise Developers for Eclipse tool, for writing, testing, and debugging mainframe code locally
- Open source testing frameworks Python behavior-driven development (BDD) test framework Behave, py3270, and the x3270 emulator for creating scripts to test applications



- A Docker developer tool for building the Enterprise Test Server Docker image and testing the application in the Enterprise Test Server Docker container

In the development cycle, developers use the EC2 instance to develop and test mainframe code locally. When the local changes are tested successfully, developers promote the change into the AccuRev server.

### 3. CI/CD pipelines

In the pattern, CI/CD pipelines are used for integration tests and regression tests before deployment to the production environment.

As explained in the SCM section, AccuRev uses two types of streams: a project stream and an integration stream. Each stream is hooked up with CI/CD pipelines. To perform the integration between the AccuRev server and AWS CodePipeline, the pattern uses AccuRev post promotion script to create an event to initiate CI/CD.

For example, when a developer promotes a change to a project stream in AccuRev, it initiates a post promotion script to run in AccuRev Server. Then the script uploads the metadata of the change into an Amazon Simple Storage Service (Amazon S3) bucket to create an Amazon S3 event. This event will initiate a CodePipeline configured pipeline to run.

The same event-initiating mechanism is used for the integration stream and its associated pipelines.

In the CI/CD pipeline, CodePipeline uses CodeBuild with the Micro Focus AccuRev Linux client container to check out the latest code from the AccuRev streams. Then the pipeline starts CodeBuild to use the Micro Focus Enterprise Developer Windows container to compile the source code, and to use the Micro Focus Enterprise Test Server Windows container in CodeBuild to test mainframe applications.

The CI/CD pipelines are built using AWS CloudFormation templates, and the blueprint will be used for new projects. By using the templates, it takes less than an hour for a project to create a new CI/CD pipeline in AWS.

To scale your mainframe test capability on AWS, the pattern builds out the Micro Focus DevOps test suite, Micro Focus Verastream and Micro Focus UFT server. By using the modern DevOps tools, you can run as many tests on AWS as you need.

An example mainframe development environment with Micro Focus on AWS is shown in the following diagram.

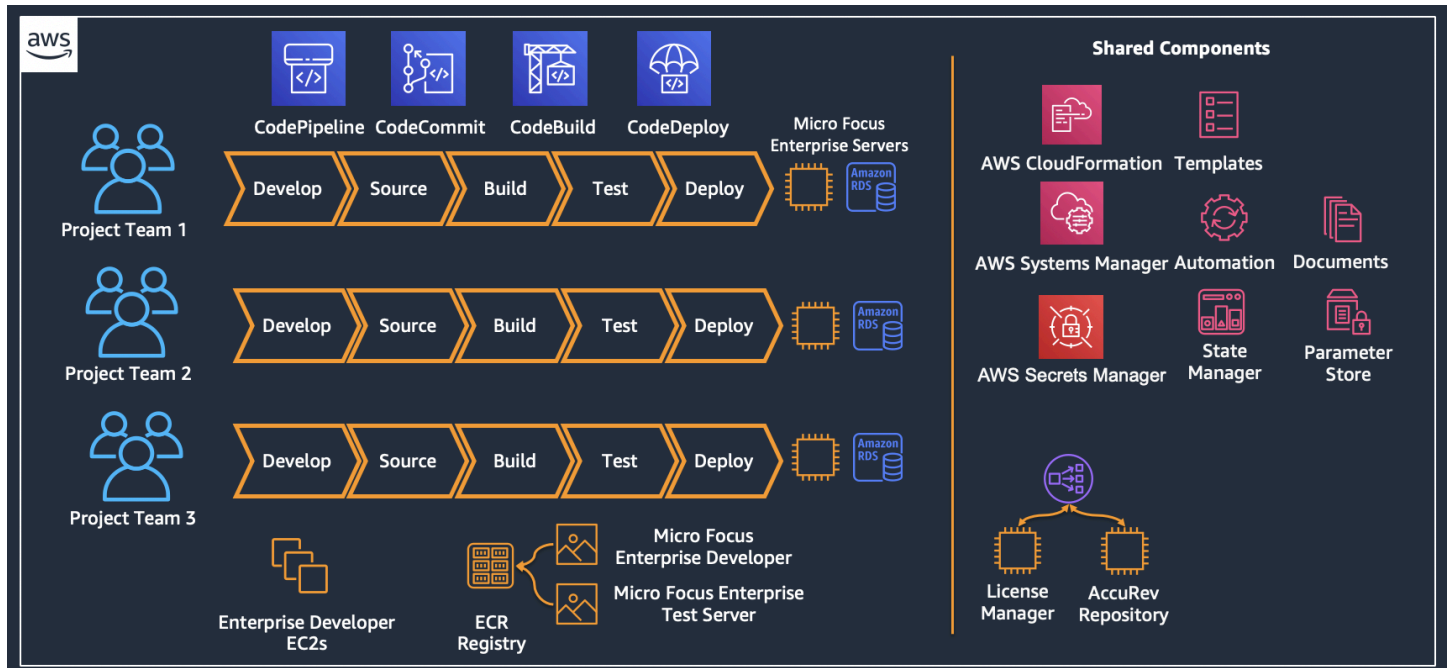

### Target technology stack

This section provides a closer look at the architecture of each component in the pattern.

#### 1. Source code repository – AccuRev SCM

Micro Focus AccuRev SCM is set up to manage mainframe source code versions. For high availability, AccuRev supports primary and replica modes. Operators can fail over to the replica when performing maintenance on the primary node.

To speed up the response of the CI/CD pipeline, the pattern uses Amazon CloudWatch Events to detect source code changes and initiate the start of the pipeline.

1. The CodePipeline is set up to use an Amazon S3 source.
2. A CloudWatch Events rule is set up to capture S3 events from a source S3 bucket.
3. The CloudWatch Events rule sets a target to the pipeline.
4. AccuRev SCM is configured to run a post promotion script locally after promotion is complete.
5. AccuRev SCM generates an XML file that contains the metadata of the promotion, and the script uploads the XML file to the source S3 bucket.

- After the upload, the source S3 bucket sends events to match the CloudWatch Events rule, and the CloudWatch Events rule initiates the CodePipeline to run.

When the pipeline runs, it kicks off a CodeBuild project to use an AccuRev Linux client container to check out the latest mainframe code from an associated AccuRev stream.

The following diagram shows an AccuRev Server setup.

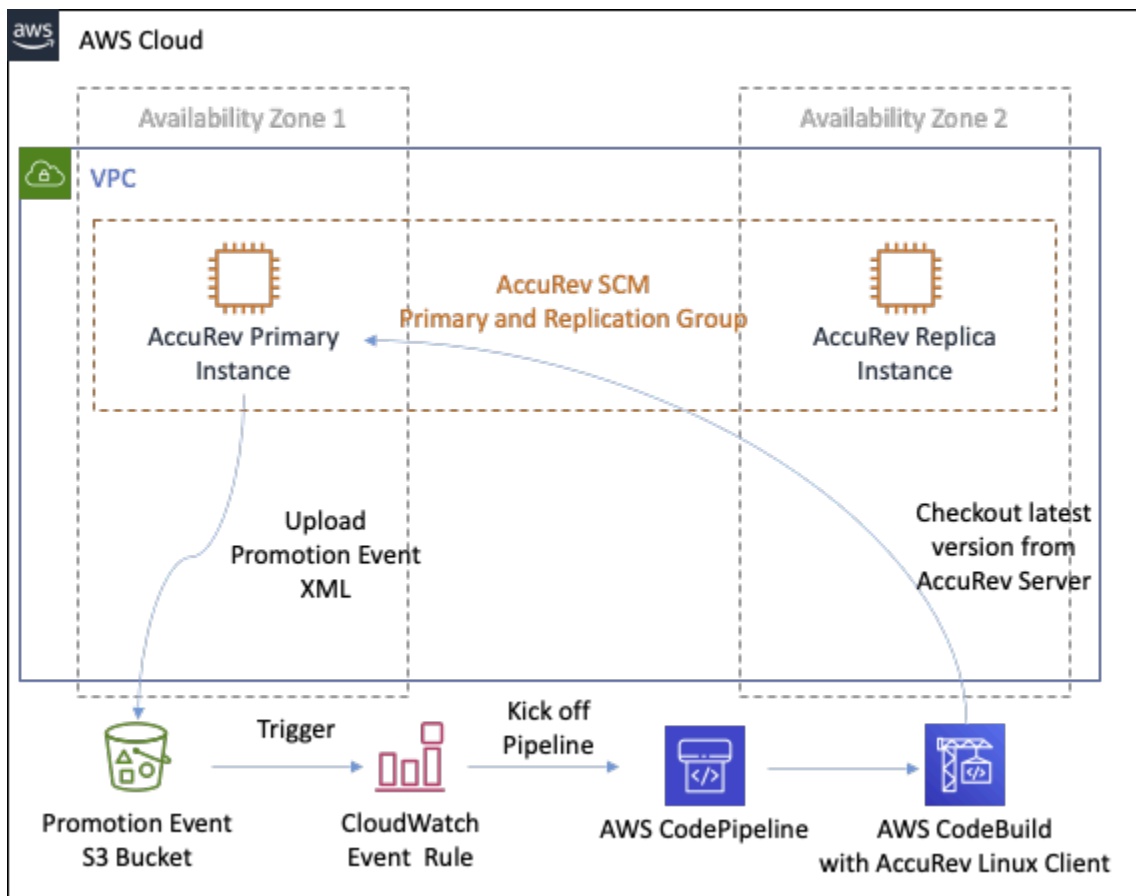

## 2. Enterprise Developer template

The pattern uses Amazon EC2 templates to simplify creation of the developer instance. By using State Manager, it can apply software and license settings to EC2 instances consistently.

The Amazon EC2 template builds in its VPC context settings and default instance settings, and it follows enterprise tagging requirements. By using a template, a team can create their own new development instances.

When a developer instance starts, by associating with tags, Systems Manager uses State Manager to apply automation. The automation includes the following general steps.

1. Install Micro Focus Enterprise Developer software and install patches.
2. Install the Micro Focus AccuRev client for Windows.
3. Install the pre-configured script for developers to join the AccuRev stream. Initialize Eclipse workspaces.
4. Install development tools, including x3270, py3270, and Docker.
5. Configure license settings to point to a Micro Focus License Manager load balancer.

The following diagram shows an Enterprise developer instance created by the Amazon EC2 template, with software and configuration applied to the instance by State Manager. Enterprise developer instances connect to Micro Focus License Manager to activate their license.

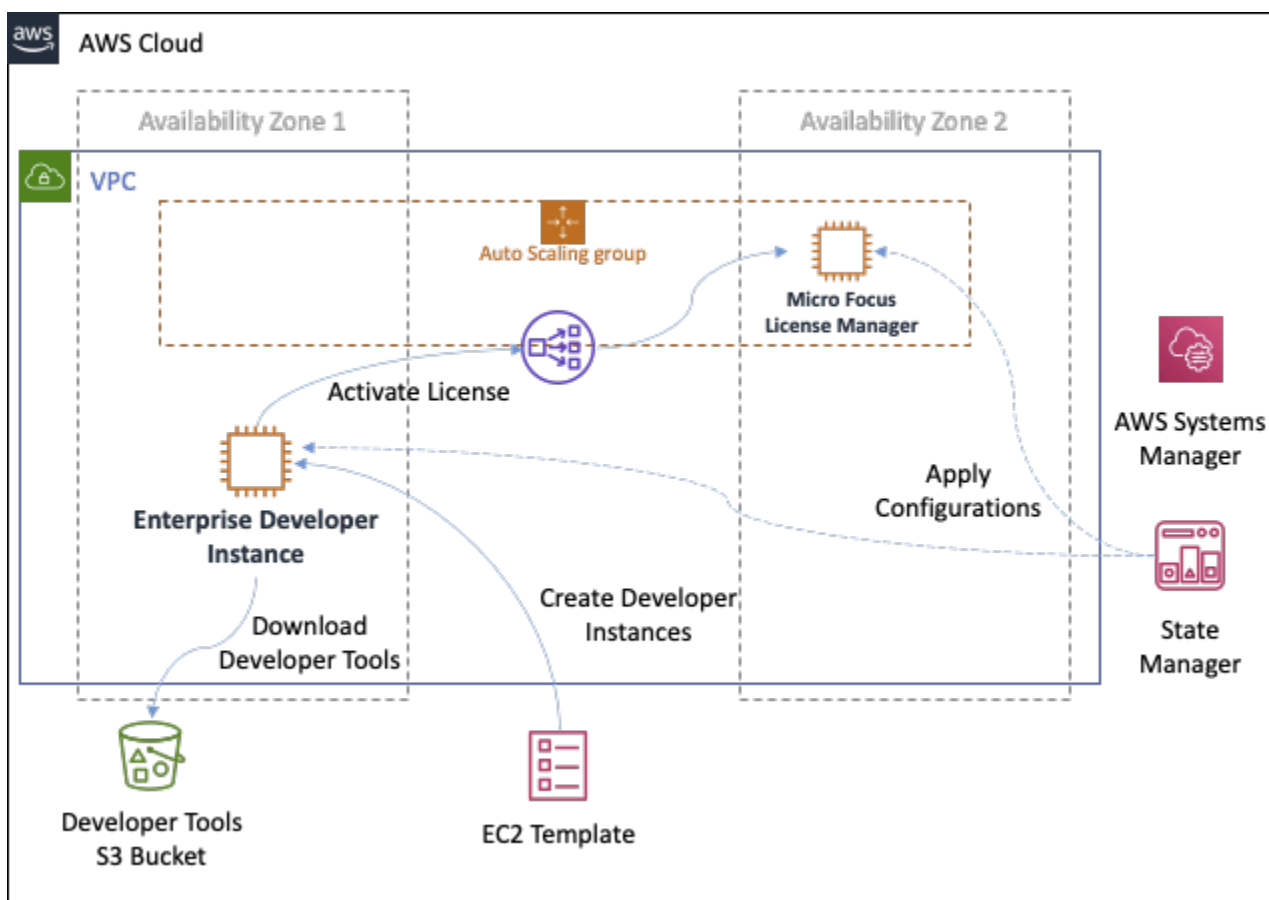

### 3. CI/CD pipelines

As explained in AWS architecture section, in the pattern, there are project-level CI/CD pipelines and system integration pipelines. Each mainframe project team creates a pipeline or multiple CI/

CD pipelines for building the programs that they are developing in a project. These project CI/CD pipelines check out source code from an associated AccuRev stream.

In a project team, developers promote their code in the associated AccuRev stream. Then the promotion initiates the project pipeline to build the code and run and integration tests.

Each project CI/CD pipeline uses CodeBuild projects with the Micro Focus Enterprise Developer tool Amazon ECR image and Micro Focus Enterprise Test Server tool Amazon ECR image.

CodePipeline and CodeBuild are used to create the CI/CDs pipelines. Because CodeBuild and CodePipeline have no upfront fees or commitments, you pay only for what you use. Compared to mainframe hardware, the AWS solution greatly reduces hardware provisioning lead time and lowers the cost of your testing environment.

In modern development, multiple test methodologies are used. For example, test-driven development (TDD), BDD, and Robot Framework. With this pattern, developers can use these modern tools for mainframe testing. For example, by using x3270, py3270 and the Behave python test tool, you can define an online application's behavior. You can also use build mainframe 3270 robot framework in these CI/CD pipelines.

The following diagram shows the team stream CI/CD pipeline.

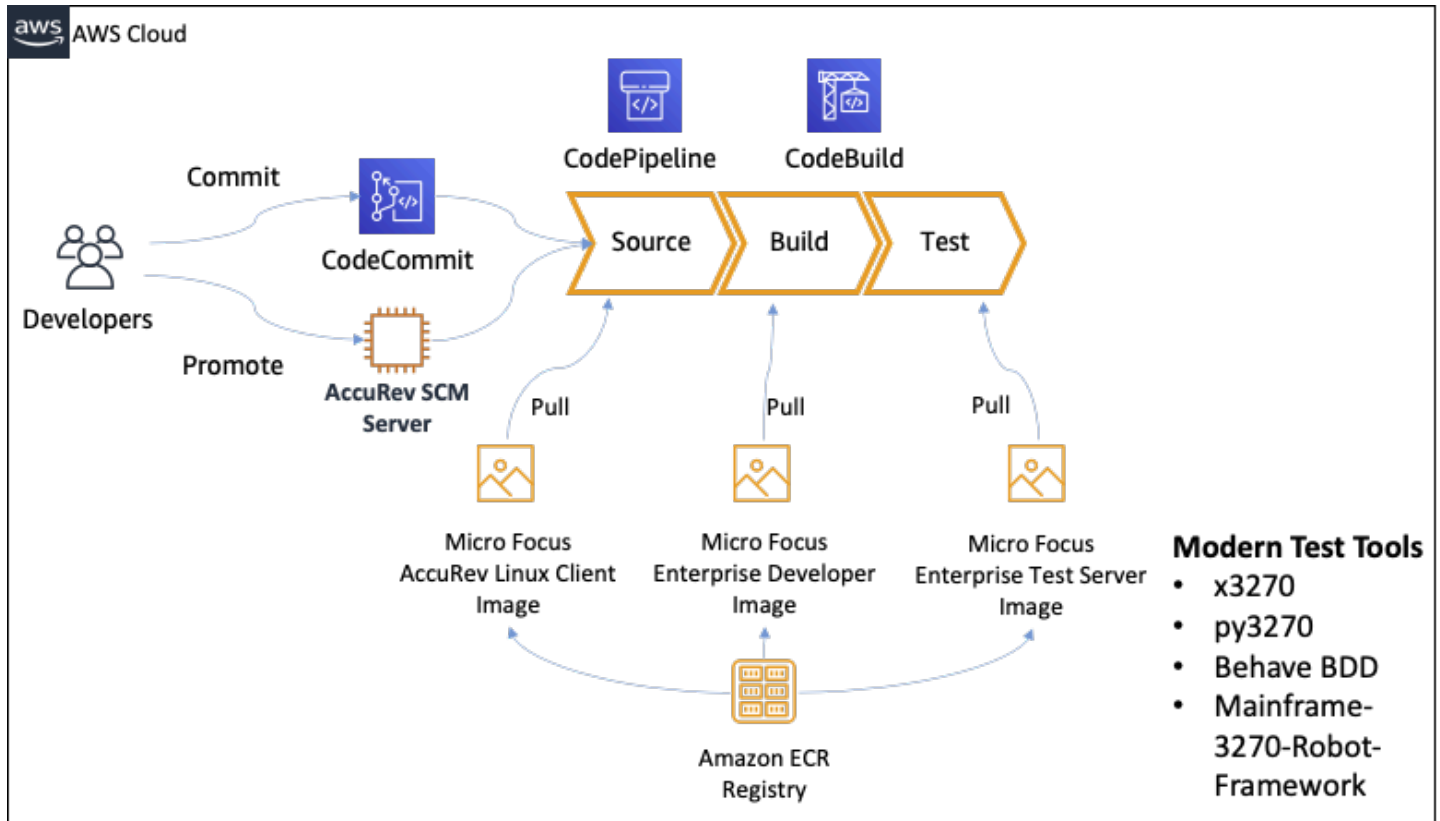

The following diagram shows the project CI/CD test report produced by CodePipeline in Mainframe3270 Robot Framework.

## MicroFocus-Cicd-Master-PipelineRpaTestBankDemo-bankdemo-rpa-test-report:d7248206-40f2-4098-9712-c33f158f7382

View report group
View build run
View artifacts [↗](#)
Delete

### Summary

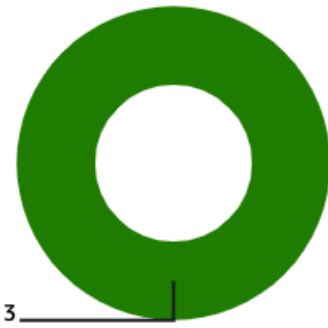

Pass rate  
**100%**

---

Report duration  
**2.662 seconds**

---

Created  
**16 days ago**

■ Passed: 3

[▶ Details](#)

### Test cases

Any status ▼
View details

< 1 >
⚙️

	Test case	Status
<input type="radio"/>	User login to demo	✔️ Succeeded
<input type="radio"/>	User Calculate home loan	✔️ Succeeded
<input type="radio"/>	User Disconnect Session	✔️ Succeeded

The following diagram shows the project CI/CD test report produced by CodePipeline in Py3270 and Behave BDD.

# MicroFocus-Cicd-Master-PipelineBddTestBankDemo-bankdemo-bdd-test-report:4ef0a273-20d4-489f-9e3c-27bb8526a2d9

[View report group](#)[View build run](#)[View artifacts](#) [Delete](#)

## Summary

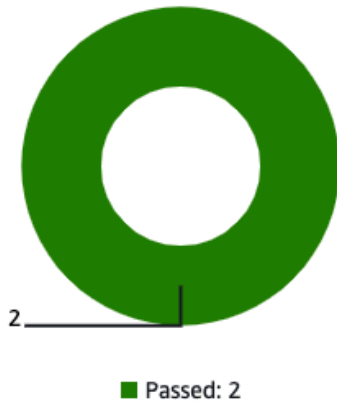

Pass rate

100%

Report duration

0.7432 seconds

Created



16 days ago

[▶ Details](#)

## Test cases

Any status ▾

[View details](#)< 1 > 

Test case	Status	Prefix
<input type="radio"/> <a href="#">As a customer I want to calculate my montly home loan repayment via a transaction -- @1.1 Homeloan</a>	 Succeeded	home_loan_c...
<input type="radio"/> <a href="#">As a customer I want to login to bank demo -- @1.1 User</a>	 Succeeded	demo_login.l...

After project level tests are passed successfully, the tested code is manually promoted to the integration stream in AccuRev SCM. You can automate this step after the teams have a confidence on the tests coverage of their project pipeline.

When code is promoted, the system integration CI/CD pipeline checks out the merged code and performs regression tests. The merged code is promoted from all parallel project streams.

Depending on how fine grain the test environment are required, customers can have more system integration CI/CD pipelines in different environment, for example UAT, Pre-Production.

In the pattern, the tools used in the system integration pipeline are Micro Focus Enterprise Test Server, Micro Focus UFT Server, and Micro Focus Verastream. All these tools can be deployed into the Docker container and used with CodeBuild.

After successfully testing of the mainframe programs, the artifact is stored, with version control, in an S3 bucket.

The following diagram shows a system integration CI/CD pipeline.

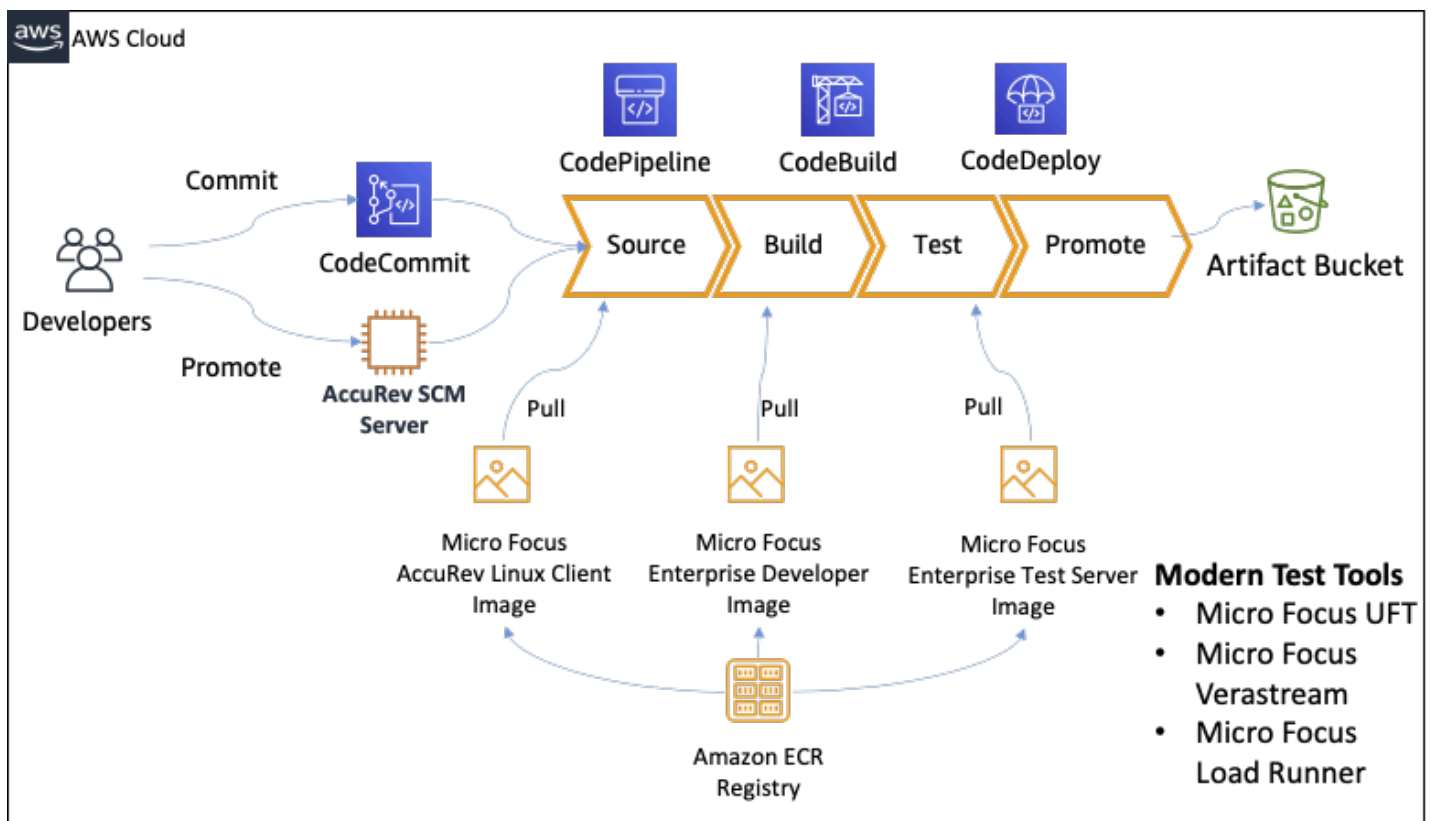

After the artifact has been successfully tested in the system integration CI/CD pipelines, it can be promoted for production deployment.

If you need to deploy source code back to the mainframe, Micro Focus offers the Enterprise Sync solution to synchronize source code from AccuRev back to Mainframe Endeavour.



The following diagram shows a production CI/CD pipeline deploying the artifact into Micro Focus Enterprise Servers. In this example, CodeDeploy orchestrates the deployment of the tested mainframe artifact into Micro Focus Enterprise Server.

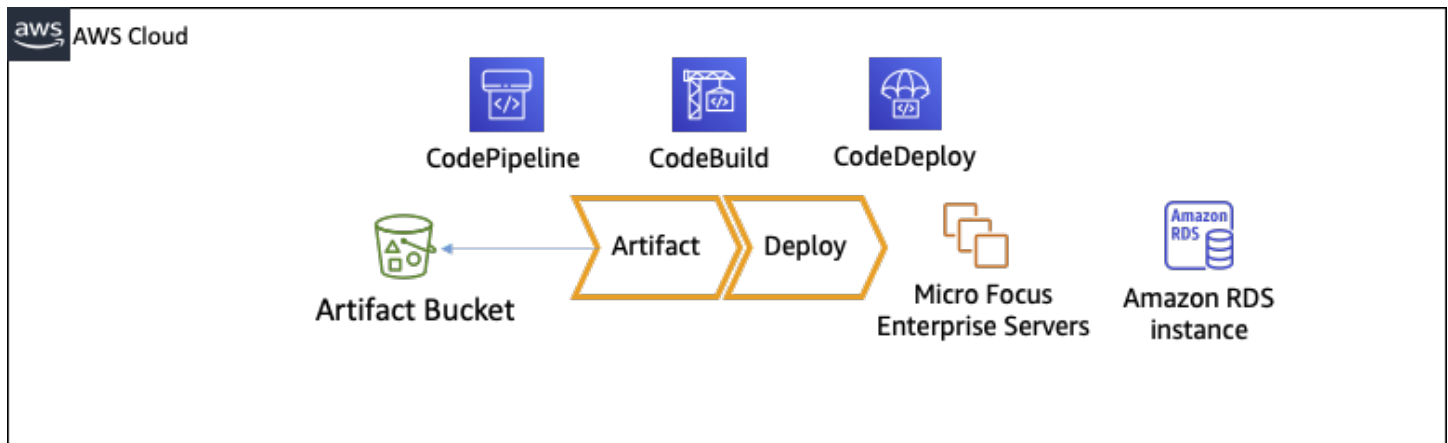

In addition to the architecture walkthrough of the CI/CD pipeline, you can also read the AWS DevOps blog post [Automate thousands of mainframe tests on AWS with the Micro Focus Enterprise Suite](#) for more information on testing mainframe applications in CodeBuild and CodePipeline. Refer to the blog post for the best practices and details of doing mainframe tests on AWS.

## Tools

### Tools

#### AWS automation tools

- [AWS CloudFormation](#)
- [Amazon CloudWatch Events](#)
- [AWS CodeBuild](#)
- [AWS CodeDeploy](#)
- [AWS CodePipeline](#)
- [Amazon ECR](#)
- [Amazon S3](#)
- [AWS Secrets Manager](#)
- [AWS Systems Manager](#)

#### Micro Focus tools

- [Micro Focus Enterprise Developer for Eclipse](#)
- [Micro Focus Enterprise Test Server](#)
- [Micro Focus Enterprise Server](#) (production deployment)
- [Micro Focus AccuRev](#)
- [Micro Focus License Manager](#)
- [Micro Focus Verastream Host Integrator](#)
- [Micro Focus UFT One](#)

## Other tools

- x3270
- [py3270](#)
- [Robot-Framework-Mainframe-3270-Library](#)

## Epics

### Create the AccuRev SCM infrastructure

Task	Description	Skills required
Deploy a primary AccuRev SCM server by using AWS CloudFormation.		AWS CloudFormation
Create the AccuRev Administrator user.	Log in to AccuRev SCM Server, and run the CLI command to create an Administrator user.	AccuRev SCM Server Administrator
Create AccuRev streams.	Create AccuRev streams that inherit from upper streams in sequence: Production, System Integration, Team streams.	AccuRev SCM Administrator
Create the developer AccuRev login accounts.	Use AccuRev SCM CLI commands to create AccuRev	AccuRev SCM Administrator

Task	Description	Skills required
	users login accounts for mainframe developers.	

### Create the Enterprise Developer Amazon EC2 launch template

Task	Description	Skills required
Deploy the Amazon EC2 launch template by using AWS CloudFormation.	Use AWS CloudFormation to deploy an Amazon EC2 launch template for Micro Focus Enterprise Developer instances. The template includes a Systems Manager Automation document for the Micro Focus Enterprise Developer instance.	AWS CloudFormation
Create the Enterprise Developer instance from the Amazon EC2 template.		AWS Console Login and Mainframe Developer Skills

### Create the Micro Focus Enterprise Developer tool Docker image

Task	Description	Skills required
Create the Micro Focus Enterprise Developer tool Docker image.	Use the Docker command and the Micro Focus Enterprise Developer tool Dockerfile to create the Docker image.	Docker
Create the Docker repository in Amazon ECR.	On the Amazon ECR console, create the repository for the Micro Focus Enterprise Developer Docker image.	Amazon ECR

Task	Description	Skills required
Push the Micro Focus Enterprise Developer tool Docker image to Amazon ECR.	Run the Docker push command to push the Enterprise Developer tool Docker image to save it in the Docker repository in Amazon ECR.	Docker

### Create the Micro Focus Enterprise Test Server Docker image

Task	Description	Skills required
Create the Micro Focus Enterprise Test Server Docker image.	Use the Docker command and the Micro Focus Enterprise Test Server Dockerfile to create the Docker image.	Docker
Create the Docker repository in Amazon ECR.	On the Amazon ECR console, create the Amazon ECR repository for the Micro Focus Enterprise Test Server Docker image.	Amazon ECR
Push the Micro Focus Enterprise Test Server Docker image to Amazon ECR.	Run the Docker push command to push and save the Enterprise Test Server Docker image in Amazon ECR.	Docker

### Create the team stream CI/CD pipeline

Task	Description	Skills required
Create the AWS CodeCommit repository.	On the CodeCommit console, create a Git-based repository	AWS CodeCommit

Task	Description	Skills required
	y for infrastructure and AWS CloudFormation code.	
Upload the AWS CloudFormation template and the automation code into the CodeCommit repository.	Run the Git push command to upload AWS CloudFormation template and automation code into the repository.	Git
Deploy the team stream CI/CD pipeline via CloudFormation.	Use the prepared AWS CloudFormation template to deploy a team stream CI/CD pipeline.	AWS CloudFormation

### Create the system integration CI/CD pipeline

Task	Description	Skills required
Create the Micro Focus UFT Docker image.	Use the Docker command and the Micro Focus UFT Dockerfile to create the Micro Focus Docker image.	Docker
Create the Docker repository in Amazon ECR for the Micro Focus UFT image.	On the Amazon ECR console, create the Docker repository for the Micro Focus UFT image.	Amazon ECR
Push the Micro Focus UFT Docker image to Amazon ECR.	Run the Docker push command to push and save the Enterprise Test Server Docker image in Amazon ECR.	Docker
Create the Micro Focus Verastream Docker image.	Use the Docker command and the Micro Focus Verastrea	Docker

Task	Description	Skills required
	Use the Dockerfile to create the Docker image.	
Create the Docker repository in Amazon ECR for the Micro Focus Verastream image.	On the Amazon ECR console, create the Docker repository for the Micro Focus Verastream image.	Amazon ECR
Deploy the system integration CI/CD pipeline via CloudFormation.	Use the prepared AWS CloudFormation template to deploy a system integration CI/CD pipeline.	AWS CloudFormation

## Create production deployment CI/CD pipeline

Task	Description	Skills required
Deploy Micro Focus Enterprise Server by using the AWS Quick Start.	To deploy Micro Focus Enterprise Server by using AWS CloudFormation, launch the Micro Focus Enterprise Server on AWS Quick Start.	AWS CloudFormation
Deploy a production deployment CI/CD pipeline.	On the AWS CloudFormation console, use the AWS CloudFormation template to deploy a production deployment CI/CD pipeline.	AWS CloudFormation

## Related resources

### References

- [AWS DevOps Blog - Automate thousands of mainframe tests on AWS with the Micro Focus Enterprise Suite](#)

- [py3270/py3270 GitHub repository](#)
- [Altran-PT-GDC/Robot-Framework-Mainframe-3270-Library GitHub repository](#)
- [Welcome to behave!](#)
- [APN Partner Blog - Tag: Micro Focus](#)
- [Launching an instance from a launch template](#)

### *AWS Marketplace*

- [Micro Focus UFT One](#)

### *AWS Quick Start*

- [Micro Focus Enterprise Server on AWS](#)

# Preserve routable IP space in multi-account VPC designs for non-workload subnets

Created by Adam Spicer (AWS)

**Code repository:** [Non routable secondary CIDRs pattern](#)

**Environment:** Production

**Technologies:** Infrastructure; DevOps; Management & governance; Networking

**AWS services:** AWS Transit Gateway; Amazon VPC; Elastic Load Balancing (ELB)

## Summary

Amazon Web Services (AWS) has published best practices that recommend using dedicated subnets in a virtual private cloud (VPC) for both [transit gateway attachments](#) and [Gateway Load Balancer endpoints](#) (to support [AWS Network Firewall](#) or third-party appliances). These subnets are used to contain elastic network interfaces for these services. If you use both AWS Transit Gateway and a Gateway Load Balancer, two subnets are created in each Availability Zone for the VPC. Because of the way VPCs are designed, these extra subnets [can't be smaller than a /28 mask](#) and can consume precious routable IP space that could otherwise be used for routable workloads. This pattern demonstrates how you can use a secondary, non-routable Classless Inter-Domain Routing (CIDR) range for these dedicated subnets to help preserve routable IP space.

## Prerequisites and limitations

### Prerequisites

- [Multi-VPC strategy](#) for routable IP space
- A non-routable CIDR range for the services you're using ([transit gateway attachments](#) and [Gateway Load Balancer](#) or [Network Firewall endpoints](#))

## Architecture

### Target architecture



This pattern includes two reference architectures: one architecture has subnets for transit gateway (TGW) attachments and a Gateway Load Balancer endpoint (GWLBe), and the second architecture has subnets for TGW attachments only.

### Architecture 1 – TGW-attached VPC with ingress routing to an appliance

The following diagram represents a reference architecture for a VPC that spans two Availability Zones. On ingress, the VPC uses an [ingress routing pattern](#) to direct traffic destined for the public subnet to a [bump-in-the-wire appliance](#) for firewall inspection. A TGW attachment supports egress from the private subnets to a separate VPC.

This pattern uses a non-routable CIDR range for the TGW attachment subnet and the GWLBe subnet. In the TGW routing table, this non-routable CIDR is configured with a blackhole (static) route by using a set of more specific routes. If the routes were to get propagated to the TGW routing table, these more specific blackhole routes would apply.

In this example, the /23 routable CIDR is divided up and fully allocated to routable subnets.

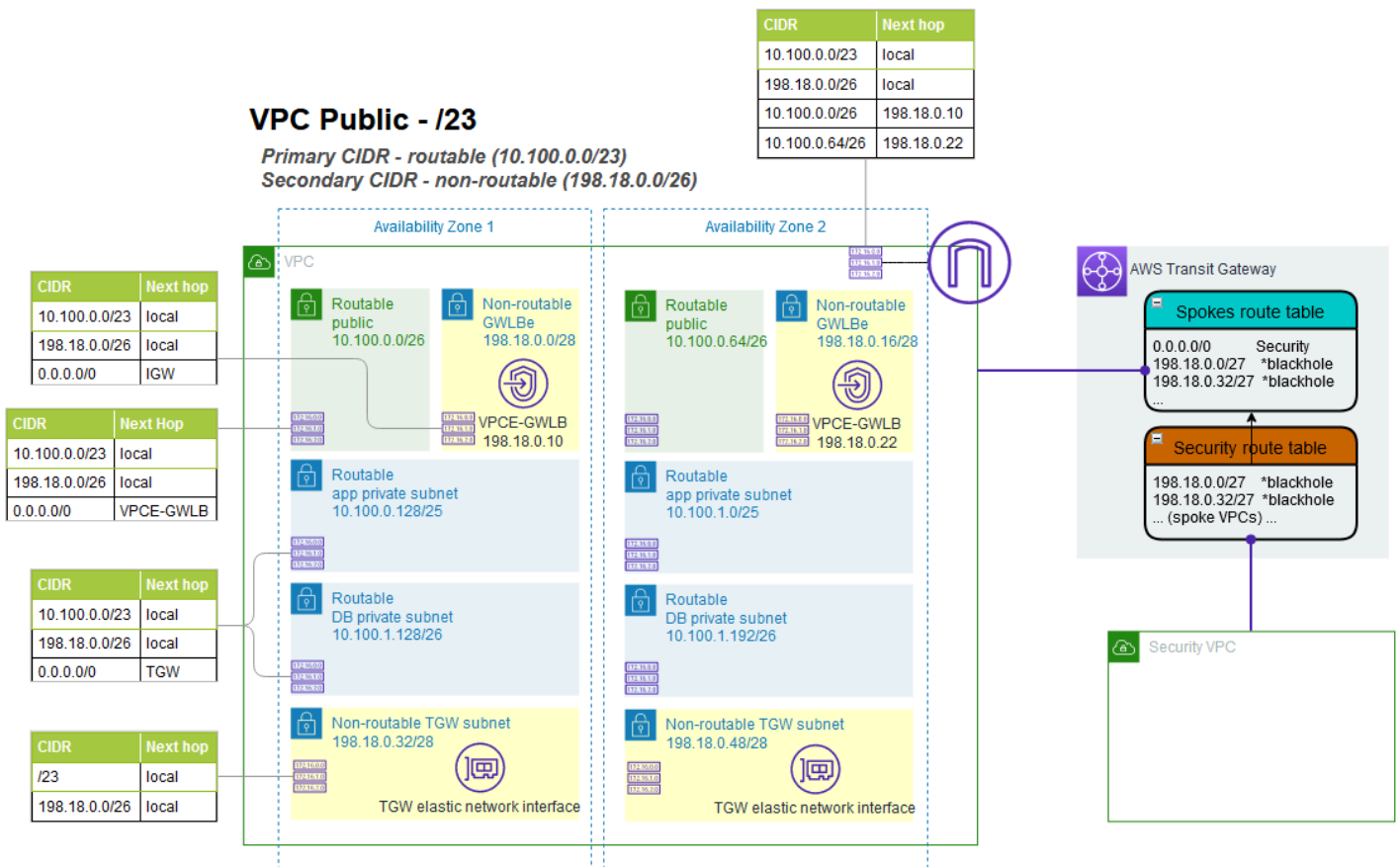

### Architecture 2 – TGW-attached VPC

The following diagram represents another reference architecture for a VPC that spans two Availability Zones. A TGW attachment supports outbound traffic (egress) from the private subnets to a separate VPC. It uses a non-routable CIDR range only for the TGW attachments subnet. In the TGW routing table, this non-routable CIDR is configured with a blackhole route by using a set of more specific routes. If the routes were to get propagated to the TGW routing table, these more specific blackhole routes would apply.

In this example, the /23 routable CIDR is divided up and fully allocated to routable subnets.

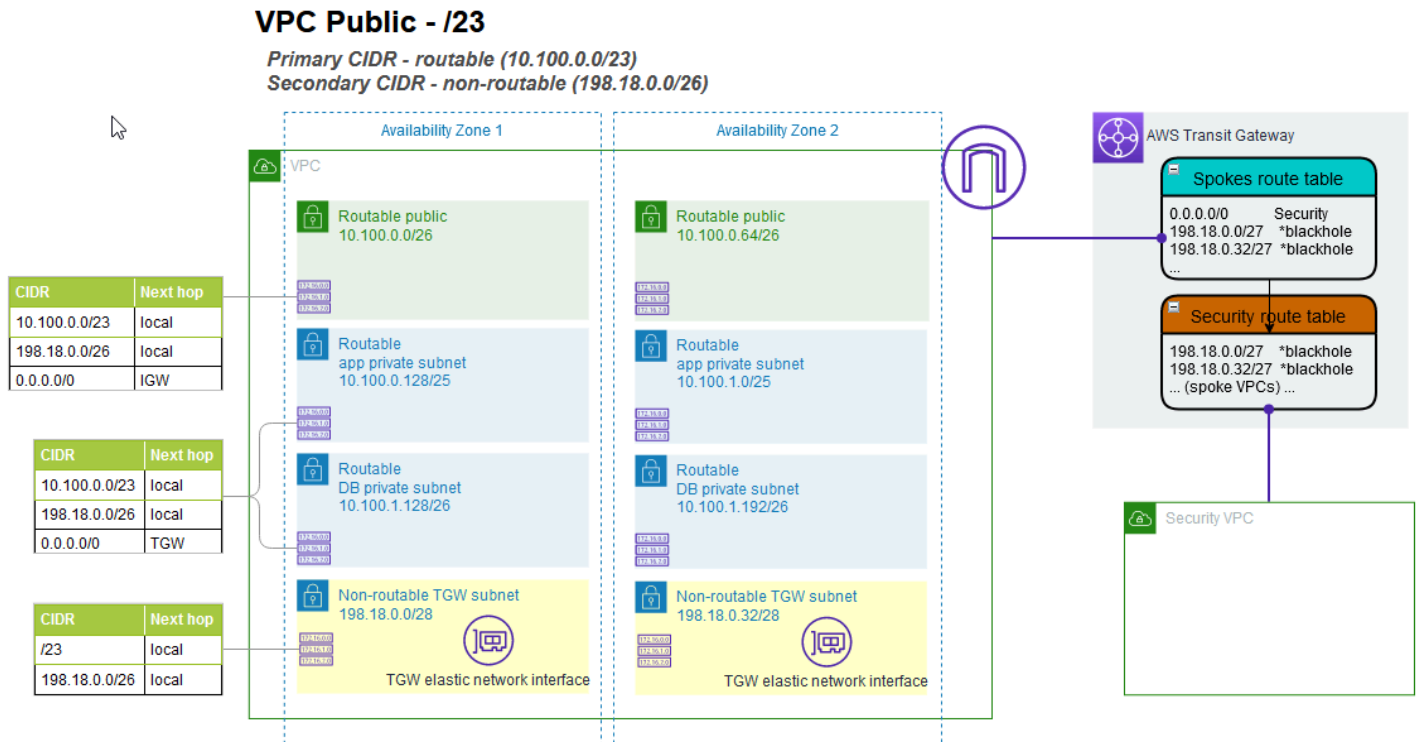

## Tools

### AWS services and resources

- [Amazon Virtual Private Cloud \(Amazon VPC\)](#) helps you launch AWS resources into a virtual network that you've defined. This virtual network resembles a traditional network that you'd operate in your own data center, with the benefits of using the scalable infrastructure of AWS. In this pattern, VPC secondary CIDRs are used to preserve routable IP space in workload CIDRs.
- [Internet gateway ingress routing](#) (edge associations) can be used along with Gateway Load Balancer endpoints for dedicated non-routable subnets.

- [AWS Transit Gateway](#) is a central hub that connects VPCs and on-premises networks. In this pattern, VPCs are centrally attached to a transit gateway, and the transit gateway attachments are in a dedicated non-routable subnet.
- [Gateway Load Balancers](#) help you deploy, scale, and manage virtual appliances, such as firewalls, intrusion detection and prevention systems, and deep packet inspection systems. The gateway serves as a single entry and exit point for all traffic. In this pattern, endpoints for a Gateway Load Balancer can be used in a dedicated non-routable subnet.
- [AWS Network Firewall](#) is a stateful, managed, network firewall and intrusion detection and prevention service for VPCs in the AWS Cloud. In this pattern, endpoints for an firewall can be used in a dedicated non-routable subnet.

## Code repository

A runbook and AWS CloudFormation templates for this pattern are available in the GitHub [Non-Routable Secondary CIDR Patterns](#) repository. You can use the sample files to set up a working lab in your environment.

## Best practices

### AWS Transit Gateway

- Use a separate subnet for each transit gateway VPC attachment.
- Allocate a /28 subnet from the secondary non-routable CIDR range for the transit gateway attachment subnets.
- In each transit gateway routing table, add a static, more specific route for the non-routable CIDR range as a blackhole.

### Gateway Load Balancer and ingress routing

- Use ingress routing to direct traffic from the internet to the Gateway Load Balancer endpoints.
- Use a separate subnet for each Gateway Load Balancer endpoint.
- Allocate a /28 subnet from the secondary non-routable CIDR range for the Gateway Load Balancer endpoint subnets.

# Epics

## Create VPCs

Task	Description	Skills required
Determine non-routable CIDR range.	Determine a non-routable CIDR range that will be used for the transit gateway attachment subnet and (optionally) for any Gateway Load Balancer or Network Firewall endpoint subnets. This CIDR range will be used as the secondary CIDR for the VPC. It must <b>not be routable</b> from the VPC's primary CIDR range or the larger network.	Cloud architect
Determine routable CIDR ranges for VPCs.	Determine a set of routable CIDR ranges that will be used for your VPCs. This CIDR range will be used as the primary CIDR for your VPCs.	Cloud architect
Create VPCs.	Create your VPCs and attach them to the transit gateway. Each VPC should have a primary CIDR range that is routable and a secondary CIDR range that is non-routable, based on the ranges you determined in the previous two steps.	Cloud architect

## Configure Transit Gateway blackhole routes

Task	Description	Skills required
Create more specific non-routable CIDRs as blackholes.	Each transit gateway routing table needs to have a set of blackhole routes created for the non-routable CIDRs. These are configured to ensure that any traffic from the secondary VPC CIDR remains non-routable and doesn't leak into the larger network. These routes should be more specific than the non-routable CIDR that is set as the secondary CIDR on the VPC. For example, if the secondary non-routable CIDR is 100.64.0.0/26, the blackhole routes in the transit gateway routing table should be 100.64.0.0/27 and 100.64.0.32/27.	Cloud architect

## Related resources

- [Best practices for deploying Gateway Load Balancer](#)
- [Distributed Inspection Architectures with Gateway Load Balancer](#)
- [Networking Immersion Day – Internet to VPC Firewall Lab](#)
- [Transit gateway design best practices](#)

## Additional information

The non-routable secondary CIDR range can also be useful when working with larger scaled container deployments that require a large set of IP addresses. You can use this pattern with a private NAT Gateway to use a non-routable subnet to host your container deployments. For more information, see the blog post [How to solve Private IP exhaustion with Private NAT Solution](#).

# Provision a Terraform product in AWS Service Catalog by using a code repository

Created by Dr. Rahul Sharad Gaikwad (AWS) and Tamilselvan P (AWS)

<b>Environment:</b> PoC or pilot	<b>Technologies:</b> Infrastructure; DevOps	<b>Workload:</b> All other workloads
<b>AWS services:</b> AWS Service Catalog; Amazon EC2		

## Summary

AWS Service Catalog supports self-service provisioning with governance for your [HashiCorp Terraform](#) configurations. If you use Terraform, you can use Service Catalog as the single tool to organize, govern, and distribute your Terraform configurations within AWS at scale. You can access Service Catalog key features, including cataloging of standardized and pre-approved infrastructure as code (IaC) templates, access control, cloud resources provisioning with least privilege access, versioning, sharing to thousands of AWS accounts, and tagging. End users, such as engineers, database administrators, and data scientists, see a list of products and versions they have access to, and they can deploy them through a single action.

This pattern helps you deploy AWS resources by using Terraform code. The Terraform code in the GitHub repository is accessed through Service Catalog. Using this approach, you integrate the products with your existing Terraform workflows. Administrators can create Service Catalog portfolios and add AWS Launch Wizard products to them by using Terraform.

The following are the benefits of this solution:

- Because of the rollback feature in Service Catalog, if any issues occur during deployment, you can revert the product to a previous version.
- You can easily identify the differences between product versions. This helps you resolve issues during deployment.
- You can configure a repository connection in Service Catalogue, such as to GitHub, GitLab, or AWS CodeCommit. You can make product changes directly through the repository.

For information about the overall benefits of AWS Service Catalog, see [What is Service Catalog](#).

## Prerequisites and limitations

### Prerequisites

- An active AWS account.
- A GitHub, BitBucket, or other repository that contains Terraform configuration files in ZIP format.
- AWS Serverless Application Model Command Line Interface (AWS SAM CLI), [installed](#).
- AWS Command Line Interface (AWS CLI), [installed](#) and [configured](#).
- Go, [installed](#).
- Python version 3.9 , [installed](#). AWS SAM CLI requires this version of Python.
- Permissions to write and run AWS Lambda functions and permissions to access and manage Service Catalog products and portfolios.

## Architecture

### Target technology stack

- AWS Service Catalog
- AWS Lambda

### Target architecture



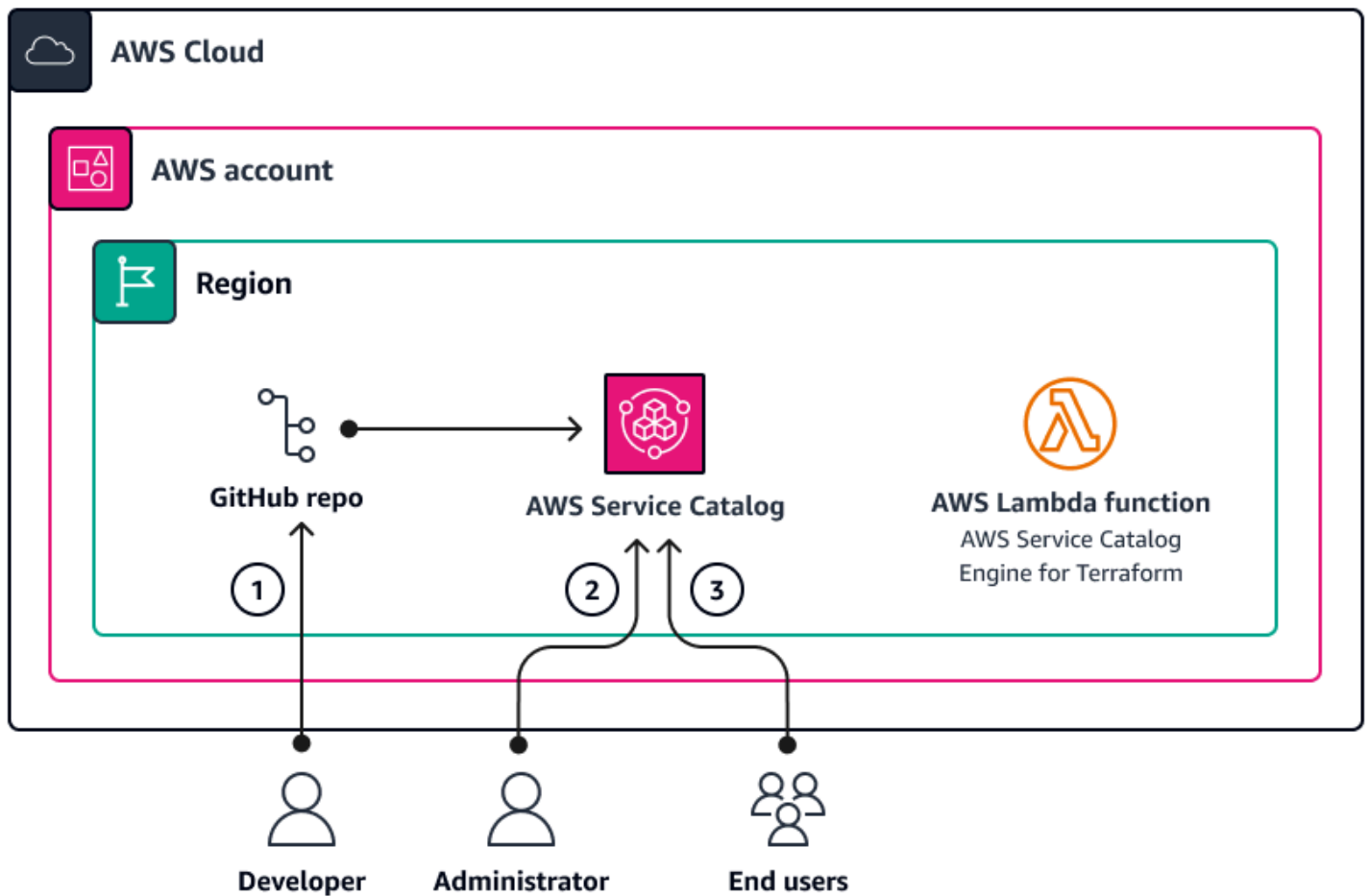

The diagram shows the following workflow:

1. When a Terraform configuration is ready, a developer creates a .zip file that contains all of the terraform code. The developer uploads the .zip file into the code repository that is connected to Service Catalog.
2. An administrator associates the Terraform product to a portfolio in Service Catalog. The administrator also creates a launch constraint that allows end users to provision the product.
3. In Service Catalog, end users launch AWS resources by using the Terraform configuration. They can choose which product version to deploy.

## Tools

### AWS services and tools

- [AWS Lambda](#) is a compute service that helps you run code without needing to provision or manage servers. It runs your code only when needed and scales automatically, so you pay only for the compute time that you use.
- [AWS Service Catalog](#) helps you centrally manage catalogs of IT services that are approved for AWS. End users can quickly deploy only the approved IT services they need, following the constraints set by your organization.

## Other services

- [Go](#) is an open source programming language that Google supports.
- [Python](#) is a general-purpose computer programming language.

## Code repository

If you require sample Terraform configurations that you can deploy through Service Catalog, you can use the configurations in the GitHub [Amazon Macie Organization Setup Using Terraform](#) repository. Use of the code samples in this repository is not required.

## Best practices

- Instead of providing the values for variables in the Terraform configuration file (`terraform.tfvars`), configure variable values when launching product through Service Catalog.
- Grant access to the portfolio only to specific users or administrators.
- Follow the principle of least privilege and grant the minimum permissions required to perform a task. For more information, see [Grant least privilege](#) and [Security best practices](#) in the IAM documentation.

## Epics

### Set up your local workstation

Task	Description	Skills required
(Optional) Install Docker.	If you want to run the AWS Lambda functions in your	DevOps engineer

Task	Description	Skills required
	<p>development environment, install Docker. For instructions, see <a href="#">Install Docker Engine</a> in the Docker documentation.</p>	
Install the AWS Service Catalog Engine for Terraform.	<ol style="list-style-type: none"><li>1. Enter the following command to clone the <a href="#">AWS Service Catalog Engine for Terraform</a> repository. <pre>git clone https://github.com/aws-samples/service-catalog-engine-for-terraform-os.git</pre></li><li>2. Navigate to the the root directory of the cloned repository.</li><li>3. Enter the following command. This installs the engine. <pre>run ./bin/bash/deploy-tre.sh -r</pre></li></ol> <p>The AWS Region set in your default profile is not used during the automated installation. Instead, you provide the Region when you run this command.</p>	DevOps engineer, AWS administrator

## Connect the GitHub repository

Task	Description	Skills required
Create a connection to the GitHub repository.	<ol style="list-style-type: none"><li data-bbox="592 331 1027 793">1. Sign in to the AWS Management Console, and then open the <b>Developer Tools</b> console. You can access the Developer Tools console by choosing a service such as AWS CodePipeline, AWS CodeCommit, or AWS CodeDeploy.</li><li data-bbox="592 821 1027 947">2. In the left navigation pane, choose <b>Settings</b>, and then choose <b>Connections</b>.</li><li data-bbox="592 974 1027 1010">3. Choose <b>Create connection</b>.</li><li data-bbox="592 1037 1027 1304">4. Select the repository where you maintain the Terraform source code. For example, you can choose <b>Bitbucket</b>, <b>GitHub</b>, or <b>GitHub Enterprise Server</b>.</li><li data-bbox="592 1331 1027 1457">5. Enter a name for the connection, and then choose <b>Connect</b>.</li><li data-bbox="592 1484 1027 1610">6. When you are prompted, authenticate the repository.</li></ol> <p data-bbox="630 1654 998 1829">After authentication is complete, the connection is created and the status changes to <b>active</b>.</p>	AWS administrator

## Create a Terraform product in Service Catalog

Task	Description	Skills required
Create the Service Catalog product.	<ol style="list-style-type: none"><li>1. Open the <a href="#">AWS Service Catalog console</a>.</li><li>2. Navigate to the <b>Administration</b> section, and then choose <b>Product list</b>.</li><li>3. Choose <b>Create product</b>.</li><li>4. On the <b>Create product</b> page in the <b>Product details</b> section, choose the <b>External</b> product type. Service Catalog uses this product type to support Terraform Community Edition products.</li><li>5. Enter a name and owner for the Service Catalog product.</li><li>6. Select <b>Specify your code repository using a CodeStar provider</b>.</li><li>7. Enter the following information for your repository:<ul style="list-style-type: none"><li>• <b>Connect to your provider using AWS CodeConnections</b> – Select the connection you created previously.</li><li>• <b>Repository</b> – Select the repository.</li></ul></li></ol>	AWS administrator

Task	Description	Skills required
	<ul style="list-style-type: none"> <li>• <b>Branch</b> – Select the branch.</li> <li>• <b>Template file path</b> – Choose the path where the code template file is stored. The file name should end with <code>tar.gz</code>.</li> </ul> <p>8. Under <b>Version name and description</b>, provide information about the product version.</p> <p>9. Choose <b>Create product</b>.</p>	
Create a portfolio.	<ol style="list-style-type: none"> <li>1. Open the <a href="#">AWS Service Catalog console</a>.</li> <li>2. Navigate to the <b>Administration</b> section, and then choose, choose <b>Portfolios</b>.</li> <li>3. Choose <b>Create portfolio</b></li> <li>4. Enter the following values: <ul style="list-style-type: none"> <li>• <b>Portfolio name</b> – Sample terraform</li> <li>• <b>Portfolio description</b> – Sample portfolio for Terraform configurations</li> <li>• <b>Owner</b> – Your contact information, such as email</li> </ul> </li> <li>5. Choose <b>Create</b>.</li> </ol>	AWS administrator

Task	Description	Skills required
Add the Terraform product to the portfolio.	<ol style="list-style-type: none"><li>1. Open the <a href="#">AWS Service Catalog console</a>.</li><li>2. Navigate to the <b>Administration</b> section, and then choose <b>Product list</b>.</li><li>3. Select the Terraform product that you created previously.</li><li>4. Choose <b>Actions</b>, and then choose <b>Add product to portfolio</b>.</li><li>5. Choose the Sample terraform portfolio.</li><li>6. Choose <b>Add product to portfolio</b>.</li></ol>	AWS administrator

Task	Description	Skills required
Create the access policy.	<ol style="list-style-type: none"><li>1. Open the <a href="#">AWS Identity and Access Management (IAM) console</a>.</li><li>2. In the navigation pane, choose <b>Policies</b>.</li><li>3. In the content pane, choose <b>Create policy</b>.</li><li>4. Choose the <b>JSON</b> option.</li><li>5. Enter the sample JSON policy in <i>Access policy</i> in the <a href="#">Additional information</a> section of this pattern.</li><li>6. Choose <b>Next</b>.</li><li>7. On the <b>Review and create</b> page, in the <b>Policy name</b> box, enter Terraform ResourceCreationAndArtifactAccessPolicy .</li><li>8. Choose <b>Create policy</b>.</li></ol>	AWS administrator



Task	Description	Skills required
Create a custom trust policy.	<ol style="list-style-type: none"><li>1. Open the <a href="#">AWS Identity and Access Management (IAM) console</a>.</li><li>2. In the navigation pane, choose <b>Roles</b>.</li><li>3. Choose <b>Create role</b>.</li><li>4. Under <b>Trusted entity type</b>, choose <b>Custom trust policy</b>.</li><li>5. In the JSON policy editor, enter the sample JSON policy in <i>Trust policy</i> in the <a href="#">Additional information</a> section of this pattern.</li><li>6. Choose <b>Next</b>.</li><li>7. Under <b>Permissions policies</b>, choose the <code>TerraformResourceCreationAndArtifactAccessPolicy</code> that you previously created.</li><li>8. Choose <b>Next</b>.</li><li>9. Under <b>Role details</b>, in the <b>Role name</b> box, enter <code>SCLaunch-product</code> .  <b>Important:</b> The role name must begin with <code>SCLaunch</code>.</li><li>10. Choose <b>Create role</b>.</li></ol>	AWS administrator

Task	Description	Skills required
Add a launch constraint to the Service Catalog product.	<ol style="list-style-type: none"><li>1. Sign in to the AWS Management Console as a user with administrative permissions.</li><li>2. Open the <a href="#">AWS Service Catalog console</a>.</li><li>3. In the navigation pane, choose <b>Portfolios</b>.</li><li>4. Choose the portfolio that you created previously.</li><li>5. On the <b>Portfolio details</b> page, choose the <b>Constraints</b> tab, and then choose <b>Create constraint</b>.</li><li>6. For <b>Product</b>, select the Terraform product you created previously.</li><li>7. Under <b>Launch constraint</b>, for <b>Method</b>, choose <b>Enter role name</b>.</li><li>8. In the <b>Role name</b> box, enter SCLaunch-product .</li><li>9. Choose <b>Create</b>.</li></ol>	AWS administrator

Task	Description	Skills required
Grant access to the product.	<ol style="list-style-type: none"><li>1. Open the <a href="#">AWS Service Catalog console</a>.</li><li>2. In the navigation pane, choose <b>Portfolios</b>.</li><li>3. Choose the portfolio that you created previously.</li><li>4. Choose the <b>Access</b> tab, and then choose <b>Grant access</b>.</li><li>5. Choose the <b>Roles</b> tab, and then select the role that should have access to deploy this product.</li><li>6. Choose <b>Grant Access</b>.</li></ol>	AWS administrator
Launch the product.	<ol style="list-style-type: none"><li>1. Sign in to the AWS Management Console as a user with permissions to deploy the Service Catalog product.</li><li>2. Open the <a href="#">AWS Service Catalog console</a>.</li><li>3. In the navigation pane, choose <b>Products</b>.</li><li>4. Choose the produce you created previously, and then choose <b>Launch product</b>.</li><li>5. Enter a product name and define any required parameters.</li><li>6. Choose <b>Launch product</b>.</li></ol>	DevOps engineer

## Verify the deployment

Task	Description	Skills required
Validate the deployment.	<p>There are two AWS Step Functions state machines for the Service Catalog provisioning workflow:</p> <ul style="list-style-type: none"><li>• <code>ManageProvisionedProductStateMachine</code><ul style="list-style-type: none"><li>–Service Catalog invokes this state machine when provisioning a new Terraform product and when updating an existing Terraform provisioned product.</li></ul></li><li>• <code>TerminateProvisionedProductStateMachine</code><ul style="list-style-type: none"><li>–Service Catalog invokes this state machine when terminating an existing Terraform provisioned product.</li></ul></li></ul> <p>You check the logs for the <code>ManageProvisionedProductStateMachine</code> state machine to confirm that the product was provisioned.</p> <ol style="list-style-type: none"><li>1. Sign in to the AWS Management Console, and then open the <a href="#">AWS Step Functions console</a>.</li></ol>	DevOps engineer

Task	Description	Skills required
	<ol style="list-style-type: none"> <li>2. In the left navigation pane, choose <b>State machines</b>.</li> <li>3. Choose Manage ProvisionedProductStateMachine .</li> <li>4. In the <b>Executions</b> list, enter the provisioned product ID to locate the execution.  <b>Note:</b> The state file backend bucket names start with <code>sc-terraform-engine-state-</code> .</li> <li>5. Validate that all the required resources have been created in the account.</li> </ol>	

## Clean up infrastructure

Task	Description	Skills required
Delete provisioned products.	<ol style="list-style-type: none"> <li>1. Sign in to the AWS Management Console as a user with permissions to deploy the Service Catalog product.</li> <li>2. Open the <a href="#">AWS Service Catalog console</a>.</li> <li>3. In the left navigation, choose <b>Provisioned products</b>.</li> </ol>	DevOps engineer

Task	Description	Skills required
	<ol style="list-style-type: none"><li>4. Select the product you created.</li><li>5. In the <b>Actions</b> list, choose <b>Terminate</b>.</li><li>6. In the confirmation text box, enter <code>terminate</code> , and then choose <b>Terminate provisioned product</b>.</li><li>7. Repeat these steps to terminate all provisioned products.</li></ol>	

Task	Description	Skills required
Remove the AWS Service Catalog Engine for Terraform.	<ol style="list-style-type: none"><li>1. Sign in to the AWS Management Console as a user with administrative permissions.</li><li>2. Open the <a href="#">Amazon S3 console</a>.</li><li>3. In the navigation pane, choose <b>Buckets</b>.</li><li>4. Select the <code>sc-terraform-engine-logging-XXXX</code> bucket.</li><li>5. Choose <b>Empty</b>.</li><li>6. Repeat steps 4–5 for the following buckets:<ul style="list-style-type: none"><li>• <code>sc-terraform-engine-state-XXXX</code></li><li>• <code>terraform-engine-bootstrap-XXXX</code></li></ul></li><li>7. Open the <a href="#">AWS CloudFormation console</a>, and then validate you're in the correct AWS Region.</li><li>8. In the left navigation, choose <b>Stacks</b>.</li><li>9. Select SAM-TRE, and then choose <b>Delete</b>. Wait until the stack has been deleted.</li><li>10. Select Bootstrap-TRE, and then choose <b>Delete</b>. Wait until the stack has been deleted.</li></ol>	AWS administrator

## Related resources

### AWS documentation

- [Getting started with a Terraform product](#)

### Terraform documentation

- [Terraform installation](#)
- [Terraform backend](#) configuration
- [Terraform AWS Provider documentation](#)

## Additional information

### Access policy

```
{
  "Version": "2012-10-17",
  "Statement": [
    {
      "Sid": "VisualEditor0",
      "Effect": "Allow",
      "Action": "s3:GetObject",
      "Resource": "*",
      "Condition": {
        "StringEquals": {
          "s3:ExistingObjectTag/servicecatalog:provisioning": "true"
        }
      }
    },
    {
      "Action": [
        "s3:CreateBucket*",
        "s3>DeleteBucket*",
        "s3:Get*",
        "s3:List*",
        "s3:PutBucketTagging"
      ],
      "Resource": "arn:aws:s3:::*",
      "Effect": "Allow"
    }
  ],
}
```



```

    {
      "Action": [
        "resource-groups:CreateGroup",
        "resource-groups:ListGroupResources",
        "resource-groups>DeleteGroup",
        "resource-groups:Tag"
      ],
      "Resource": "*",
      "Effect": "Allow"
    },
    {
      "Action": [
        "tag:GetResources",
        "tag:GetTagKeys",
        "tag:GetTagValues",
        "tag:TagResources",
        "tag:UntagResources"
      ],
      "Resource": "*",
      "Effect": "Allow"
    }
  ]
}

```

## Trust policy

```

{
  "Version": "2012-10-17",
  "Statement": [
    {
      "Sid": "GivePermissionsToServiceCatalog",
      "Effect": "Allow",
      "Principal": {
        "Service": "servicecatalog.amazonaws.com"
      },
      "Action": "sts:AssumeRole"
    },
    {
      "Effect": "Allow",
      "Principal": {
        "AWS": "arn:aws:iam::account_id:root"
      },
      "Action": "sts:AssumeRole",
    }
  ]
}

```

```
    "Condition": {
      "StringLike": {
        "aws:PrincipalArn": [
          "arn:aws:iam::accounti_id:role/TerraformEngine/
TerraformExecutionRole*",
          "arn:aws:iam::accounti_id:role/TerraformEngine/
ServiceCatalogExternalParameterParserRole*",
          "arn:aws:iam::accounti_id:role/TerraformEngine/
ServiceCatalogTerraformOSParameterParserRole*"
        ]
      }
    }
  ]
}
```

# Register multiple AWS accounts with a single email address by using Amazon SES

Created by Joe Wozniak (AWS) and Shubhangi Vishwakarma (AWS)

**Code repository:** [GitHub aws-account-factory-email](#)

**Environment:** PoC or pilot

**Technologies:** Infrastructure; Management & governance; Messaging & communications

**AWS services:** AWS Lambda; Amazon SES; Amazon DynamoDB

## Summary

This pattern describes how you can decouple real email addresses from the email address that's associated with an AWS account. AWS accounts require a unique email address to be provided at the time of account creation. In some organizations, the team that manages AWS accounts must take on the burden of managing many unique email addresses with their messaging team. This can be difficult for large organizations that manage many AWS accounts.

This pattern provides a unique email address vending solution that enables AWS account owners to associate one email address with multiple AWS accounts. The real email addresses of AWS account owners are then associated with these generated email addresses in a table. The solution handles all incoming email for the unique email accounts, looks up the owner of each account, and then forwards any received messages to the owner.

## Prerequisites and limitations

### Prerequisites

- Administrative access to an AWS account.
- Access to a development environment. We recommend that you use AWS Cloud9 to avoid having to set up the needed tools and access keys yourself.
- (Optional) Familiarity with AWS Cloud Development Kit (AWS CDK) workflows and the Python programming language will help you troubleshoot any issues or make modifications.

## Limitations

- Overall vended email address length of 64 characters. For details, see [CreateAccount](#) in the *AWS Organizations API reference*.

## Product versions

- Node.js version 12.7.0 or later
- Python 3.9 or later
- Python packages **pip** and **virtualenv**
- AWS CDK version 2.23.0 or later
- Docker 20.10.x or later

## Architecture

### Target technology stack

- AWS CloudFormation stack
- AWS Lambda functions
- Amazon Simple Email Address (Amazon SES) rule and rule set
- AWS Identity and Access Management (IAM) roles and policies
- Amazon Simple Storage Service (Amazon S3) bucket and bucket policy
- AWS Key Management Service (AWS KMS) key and key policy
- Amazon Simple Notification Service (Amazon SNS) topic and topic policy
- Amazon DynamoDB table

### Target architecture

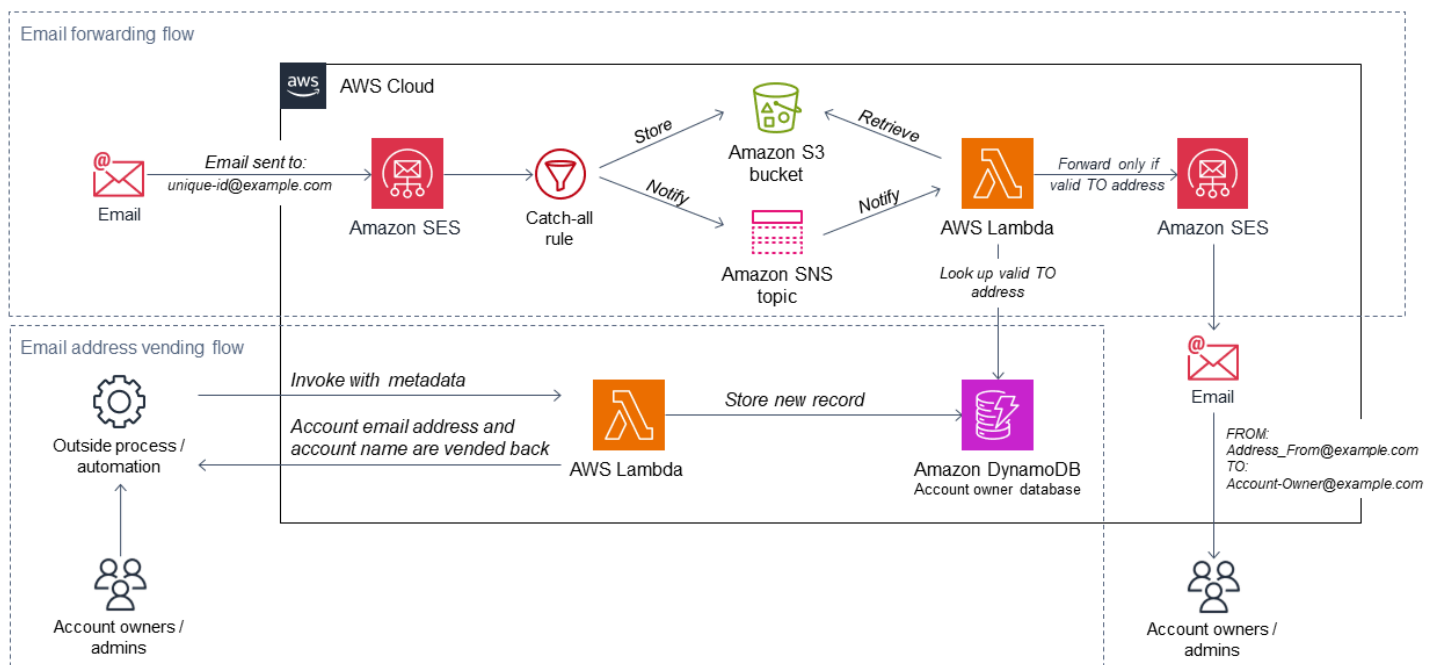

This diagram shows two flows:

- Email address vending flow:** In the diagram, the email address vending flow (lower section) begins typically with an account vending solution or outside automation, or is invoked manually. In the request, a Lambda function is called with a payload that contains the needed metadata. The function uses this information to generate a unique account name and email address, stores it in a DynamoDB database, and returns the values to the caller. These values can then be used to create a new AWS account (typically by using AWS Organizations).
- Email forwarding flow:** This flow is illustrated in the upper section of the previous diagram. When an AWS account is created by using the account email generated from the email address vending flow, AWS sends various emails, such as account registration confirmation and periodic notifications, to that email address. By following the steps in this pattern, you configure your AWS account with Amazon SES to receive emails for the entire domain. This solution configures forwarding rules that allow Lambda to process all incoming emails, check to see if the TO address is in the DynamoDB table, and forward the message to the account owner's email address instead. Using this process gives account owners the ability to associate multiple accounts with one email address.

## Automation and scale

This pattern uses the AWS CDK to fully automate the deployment. The solution uses AWS managed services that will (or can be configured to) scale automatically to meet your needs. The Lambda functions might require additional configuration to meet your scaling needs. For more information, see [Lambda function scaling](#) in the Lambda documentation.

## Tools

### AWS services

- [AWS Cloud9](#) is an integrated development environment (IDE) that helps you code, build, run, test, and debug software. It also helps you release software to the AWS Cloud.
- [AWS CloudFormation](#) helps you set up AWS resources, provision them quickly and consistently, and manage them throughout their lifecycle across AWS accounts and Regions.
- [AWS Command Line Interface \(AWS CLI\)](#) is an open-source tool that helps you interact with AWS services through commands in your command-line shell.
- [Amazon DynamoDB](#) is a fully managed NoSQL database service that provides fast, predictable, and scalable performance.
- [AWS Identity and Access Management \(IAM\)](#) helps you securely manage access to your AWS resources by controlling who is authenticated and authorized to use them.
- [AWS Key Management Service \(AWS KMS\)](#) helps you create and control cryptographic keys to help protect your data.
- [AWS Lambda](#) is a compute service that helps you run code without needing to provision or manage servers. It runs your code only when needed and scales automatically, so you pay only for the compute time that you use.
- [Amazon Simple Email Service \(Amazon SES\)](#) helps you send and receive emails by using your own email addresses and domains.
- [Amazon Simple Notification Service \(Amazon SNS\)](#) helps you coordinate and manage the exchange of messages between publishers and clients, including web servers and email addresses.
- [Amazon Simple Storage Service \(Amazon S3\)](#) is a cloud-based object storage service that helps you store, protect, and retrieve any amount of data.

### Tools needed for deployment

- Development environment with the AWS CLI and IAM access to your AWS account. For details, see the links in the [Related resources](#) section. We recommend that you use AWS Cloud9 to simplify the setup process.
- If you use AWS Cloud9, the following will be configured for you. If you choose not to use AWS Cloud9, you will need to install the following:
  - The AWS CLI to configure access credentials for the AWS CDK. For more information, see the [AWS CLI documentation](#).
  - Python version 3.9 or later
  - Python packages **pip** and **virtualenv**
  - Node.js version 12.7.0 or later
  - AWS CDK version 2.23.0 or later
  - Docker version 20.10.x or later

## Code

The code for this pattern is available in the GitHub [AWS account factory email](#) repository.

## Epics

### Allocate a target deployment environment

Task	Description	Skills required
Identify or create an AWS account.	Identify an existing or new AWS account to which you have full administrative access, to deploy the email solution.	AWS administrator, Cloud administrator
Set up a deployment environment.	Configure an easy to use deployment environment and set up dependencies by following these steps: <ol style="list-style-type: none"> <li>1. Deploy an instance of AWS Cloud9 as a dedicated</li> </ol>	AWS DevOps, App developer

Task	Description	Skills required
	<p>deployment environment. For instructions, see <a href="#">Getting started with AWS Cloud9</a>.</p> <p>2. Clone the GitHub <a href="#">AWS account factory email</a> repository code base to the AWS Cloud9 instance by using the command:</p> <pre data-bbox="634 674 1027 871">git clone https://github.com/aws-samples/aws-account-factory-email</pre> <p>3. In the <code>requirements.txt</code> file (in the root of the repository), update the line that starts with <code>aws-cdk-lib==</code> to match the version of the AWS CDK that's running in your environment. To identify the version, use the <code>cdk --version</code> command.</p>	

## Set up a verified domain

Task	Description	Skills required
Identify and allocate a domain.	The email forwarding functionality requires a dedicated domain. Identify and allocate a domain or	Cloud administrator, Network administrator, DNS administrator



Task	Description	Skills required
	<p>subdomain that you can be verify with Amazon SES. This domain should be available to receive incoming email within the AWS account where the email forwarding solution is deployed.</p> <p>Domain requirements:</p> <ul style="list-style-type: none"><li>• The domain should be a standard domain or subdomain.</li><li>• The domain should be externally DNS resolvable because it will be used to receive emails from outside the organization.</li></ul>	
Verify the domain.	<p>Verify that the identified domain can be used to accept incoming email.</p> <p>Complete the instructions in <a href="#">Verifying your domain for Amazon SES email receiving</a> in the Amazon SES documentation. This will require coordination with the person or team who is responsible for the domain's DNS records.</p>	App developer, AWS DevOps

Task	Description	Skills required
Set up MX records.	Set up your domain with MX records that point to the Amazon SES endpoints in your AWS account and Region. For more information, see <a href="#">Publishing an MX record for Amazon SES email receiving</a> in the Amazon SES documentation.	Cloud administrator, Network administrator, DNS administrator

## Deploy the email vending and forwarding solution

Task	Description	Skills required
Modify the default values in cdk.json.	<p>Edit some of the default values in the <code>cdk.json</code> file (in the root of the repository) so that the solution will operate correctly after it is deployed.</p> <ol style="list-style-type: none"><li>1. Modify the <code>SES_DOMAIN_NAME</code> value to match the domain name you verified previously.</li><li>2. Modify the <code>ADDRESS_FROM</code> value to include the same domain that is in <code>SES_DOMAIN_NAME</code>. The local part of the address should be determined by your cloud team. This address becomes the <code>FROM</code> address for every email</li></ol>	App developer, AWS DevOps

Task	Description	Skills required
	<p>that's forwarded through the solution.</p> <p>3. Modify the ADDRESS_ADMIN value to match the email address that any non-matching incoming messages will be forwarded to. This value must be a valid and operating email address.</p>	

Task	Description	Skills required
Deploy the email vending and forwarding solution.	<ol style="list-style-type: none"><li data-bbox="592 226 1027 430">1. Create a Python virtual environment: <pre data-bbox="634 348 1027 430">python -m venv .venv</pre></li><li data-bbox="592 443 1027 682">2. Activate the Python virtual environment: <pre data-bbox="634 562 1027 682">source .venv/bin/activate</pre><p data-bbox="630 720 919 802">Or, on the Windows platform, use:</p><pre data-bbox="634 842 1027 961">% .venv\Scripts\activate.bat</pre></li><li data-bbox="592 974 1027 1255">3. Install all Python requirements with no errors: <pre data-bbox="634 1142 1027 1255">pip install -r requirements.txt</pre></li><li data-bbox="592 1268 1027 1472">4. Synthesize the CloudFormation template: <pre data-bbox="634 1398 1027 1472">cdk synth</pre><p data-bbox="630 1514 1008 1738">Confirm that there are no errors and that the full CloudFormation template contains the expected output.</p></li><li data-bbox="592 1751 1027 1845">5. (Optional) If you are deploying the AWS CDK</li></ol>	App developer, AWS DevOps

Task	Description	Skills required
	<p>code into the current AWS account or Region for the first time, bootstrap the environment. For more information, see <a href="#">Bootstrap ping</a> in the AWS CDK documentation.</p> <pre>cdk bootstrap aws:// AWS-ACCOUNT-NUMBER/ REGION</pre> <p>Replace <code>AWS-ACCOUNT-NUMBER</code> and <code>REGION</code> with actual values.</p> <p>6. Deploy the solution:</p> <pre>cdk bootstrap cdk deploy</pre> <p>The commands should complete without errors.</p>	

Task	Description	Skills required
Verify that the solution has been deployed.	<p>Verify that the solution deployed successfully before you begin testing:</p> <ol style="list-style-type: none"> <li>1. Open the <a href="#">AWS CloudFormation console</a> and look for a CloudFormation stack that contains the name <code>AwsMailFwdStack</code> .</li> <li>2. Confirm that this <code>AwsMailFwdStack</code> stack has the following resources : <ul style="list-style-type: none"> <li>• Lambda functions</li> <li>• Amazon SES rule and rule set</li> <li>• IAM roles and policies</li> <li>• Amazon S3 bucket and bucket policy</li> <li>• AWS KMS key and key policy</li> <li>• Amazon SNS topic and topic policy</li> <li>• DynamoDB table</li> </ul> </li> </ol>	App developer, AWS DevOps

### Verify that email vending and forwarding operate as expected

Task	Description	Skills required
Verify that the API is working.	In this step, you submit test data to the solution's API and confirm that the solution produces the expected output	App developer, AWS DevOps

Task	Description	Skills required
	<p>and that backend operations have been performed as expected.</p> <p>Manually run the <b>Vend Email</b> Lambda function by using test input. (For an example, see the <a href="#">sample_vend_request.json file</a>.) For <code>OwnerAddress</code>, use a valid email address. The API should return an account name and account email with values as expected.</p>	

Task	Description	Skills required
Verify that email is being forwarded.	<p>In this step, you send a test email through the system and verify that the email is forwarded to the expected recipient.</p> <ol style="list-style-type: none"><li>1. Obtain the account email from the last step.</li><li>2. Send an email to this address with a test subject and body text.</li><li>3. Confirm that you received the email at the account owner's email address.</li><li>4. Confirm that the email you received has a FROM address that matches the ADDRESS_FROM setting in <code>cdk.json</code>.</li><li>5. Confirm that the received email's subject and body are the same as the original sent message.</li></ol>	App developer, AWS DevOps

## Troubleshooting

Issue	Solution
The system doesn't forward email as expected.	<p>Verify that your setup is correct:</p> <ol style="list-style-type: none"><li>1. You should have completed the Amazon SES <a href="#">verification process</a> for your domain.</li></ol>



Issue	Solution
	<ol style="list-style-type: none"><li data-bbox="831 214 1503 483">2. Your domain should be set up properly with MX records pointing to the Amazon SES endpoints in your AWS account and Region. For more information, see <a href="#">Publishing an MX record for Amazon SES email receiving</a> in the Amazon SES documentation.</li></ol> <p data-bbox="831 562 1445 642">After you verify your domain setup, follow these steps:</p> <ol style="list-style-type: none"><li data-bbox="831 688 1490 865">1. Open the <a href="#">AWS CloudWatch console</a> for the account and Region where you deployed the solution, and navigate to CloudWatch log groups in the navigation pane.</li><li data-bbox="831 890 1507 970">2. Search the list of log groups for <code>SesMailForwardLogGroup</code> .</li><li data-bbox="831 995 1471 1125">3. Investigate the logs in this group to see if any errors are generated during the email vending and forwarding process.</li></ol>

Issue	Solution
<p>When you try to deploy the AWS CDK stack, you receive an error similar to:</p> <p>“Template format error: Unrecognized resource types”</p>	<p>In most instances, this error message means that the Region you’re targeting doesn’t have all the available AWS services. If you’re using AWS Cloud9 to deploy the solution, you might be targeting a Region that is different from the Region where the AWS Cloud9 instance is running.</p> <p><b>Note:</b> By default, the AWS CDK deploys to the Region and account that you configured in the AWS CLI.</p> <p>Possible solutions:</p> <ol style="list-style-type: none"><li>1. Investigate if all the services needed for this solution (see the <a href="#">Target technology stack</a> section earlier in this pattern) are in the AWS Region you are targeting by reviewing <a href="#">AWS Services by Region</a>.</li><li>2. If you are using AWS Cloud9 and targeting a Region that’s different from the Region where your AWS Cloud9 instance is running, make sure to set the <code>AWS_DEFAULT_REGION</code> environment variable, or set a Region with the AWS CLI before you deploy the solution. For more information, see the <a href="#">Environment variables to configure the AWS CLI</a> in the AWS CLI documentation. Alternatively, you can modify the <code>app.py</code> file in the root of the repository to include a hard-coded account ID and Region by following the instructions in the <a href="#">AWS CDK documentation for environments</a>.</li></ol>

Issue	Solution
<p>When you deploy the solution, you receive the error message:</p> <p>“Deployment failed: Error: AwsMailFwdStack: SSM parameter /cdk-bootstrap/hnb659fds/version not found. Has the environment been bootstrapped? Please run 'cdk bootstrap'”</p>	<p>If you have never deployed any AWS CDK resources to the AWS account and Region you’re targeting, you will have to first run the <code>cdk bootstrap</code> command as the error indicates. If you continue to receive this error after you run the bootstrapping command, you might be trying to deploy the solution to a Region that’s different from the Region where your AWS Cloud9 instance is running.</p> <p>To solve this problem, set the <code>AWS_DEFAULT_REGION</code> environment variable or set a Region with the AWS CLI before you deploy the solution. Alternatively, you can modify the <code>app.py</code> file in the root of the repository to include a hard-coded account ID and Region by following the instructions in the <a href="#">AWS CDK documentation for environments</a>.</p>

## Related resources

- For help installing the AWS CLI, see [Install or update the latest version of the AWS CLI](#).
- For help setting up the AWS CLI with IAM access credentials, see [Configure the AWS CLI](#).
- For help with the AWS CDK, see [Getting started with the AWS CDK](#).

## Additional information

### Costs

When you deploy this solution, the AWS account holder might incur costs that are associated with the use of the following services. It is important for you to understand how these services are billed so you are aware of any potential charges. For pricing information, see the following pages:

- [Amazon SES pricing](#)

- [Amazon S3 pricing](#)
- [AWS Cloud9 pricing](#)
- [AWS KMS pricing](#)
- [AWS Lambda pricing](#)
- [Amazon DynamoDB pricing](#)

# Set up DNS resolution for hybrid networks in a multi-account AWS environment

Created by Amir Durrani

**Environment:** Production

**Technologies:** Infrastructure;  
Networking

**AWS services:** AWS RAM;  
Amazon Route 53; AWS  
Control Tower

## Summary

This pattern describes how you can use on-premises Domain Name System (DNS) services with Amazon Route 53 Resolver rules and outbound Resolver endpoints for name resolution.

DNS is fundamental to establishing and maintaining communications across network environments. If you have a hybrid network connectivity environment, you can share critical network services such as DNS and Active Directory without the operational burden of managing a distributed environment across accounts and virtual private clouds (VPCs). This approach helps you build and support applications that span a large number of accounts. For example, if you have hundreds or thousands of multi-Region accounts with hybrid connectivity requirements, you can share DNS services securely and efficiently across all connected environments within your AWS organization.

DNS is critical to IP networking among all tiers (web, application, and database) of an application. It is best practice to give only the team of DNS experts full access to configure, operate, and support this resource. In a hybrid connectivity environment, you can continue to use your on-premises DNS for name resolution requests originating from resources that reside in different accounts, by using conditional forwarding.

This pattern covers hybrid DNS resolution in an AWS multi-account environment. For single accounts, see the pattern [Set up DNS resolution for hybrid networks in a single-account AWS environment](#).

## Prerequisites and limitations

### Prerequisites

- An AWS multi-account environment that is based on best practices and built by using [AWS Control Tower](#). The diagram in the next section shows the typical architecture of such an environment.
- Scalable routing infrastructure between the accounts and VPCs by using [AWS Transit Gateway](#).
- Outbound Resolver endpoints and Resolver rules by using [Amazon Route 53](#).
- Resource shares for outbound Resolver rules by using [AWS Resource Access Manager](#) (AWS RAM).

## Architecture

### AWS multi-account architecture

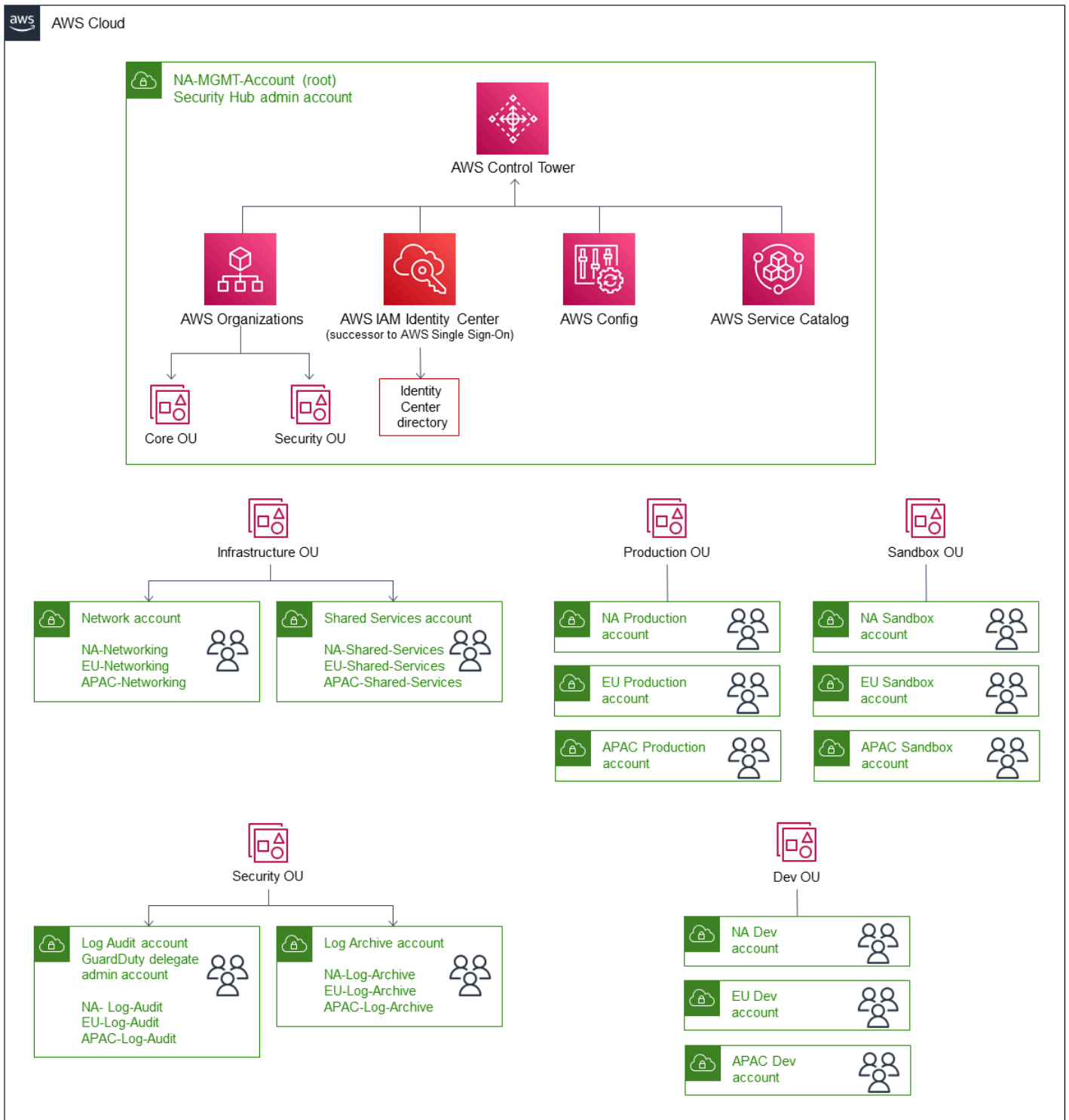

### Target technology stack

- An existing on-premises DNS infrastructure for outbound name resolution across a large number of AWS principals

- Route 53 Resolver rule and outbound Resolver endpoints
- AWS RAM for sharing Route 53 Resolver rules with other AWS principals within and outside the AWS organization

## Target architecture

The following diagram depicts the steps for configuring the end-to-end hybrid DNS resolution. AWS RAM is used to share the Route 53 Resolver rules and Resolver endpoints, which are configured and managed from the central Shared Services account. Route 53 Resolver endpoints are configured for each Availability Zone to receive the outbound name resolution requests for the resources that reside in the on-premises data center, and to then forward these requests to the on-premises DNS resolvers. The on-premises DNS resolvers send the name resolution responses to the outbound endpoints, which then forward the responses to the VPC resolver. These steps establish end-to-end communication by using hostnames instead of IP addresses.

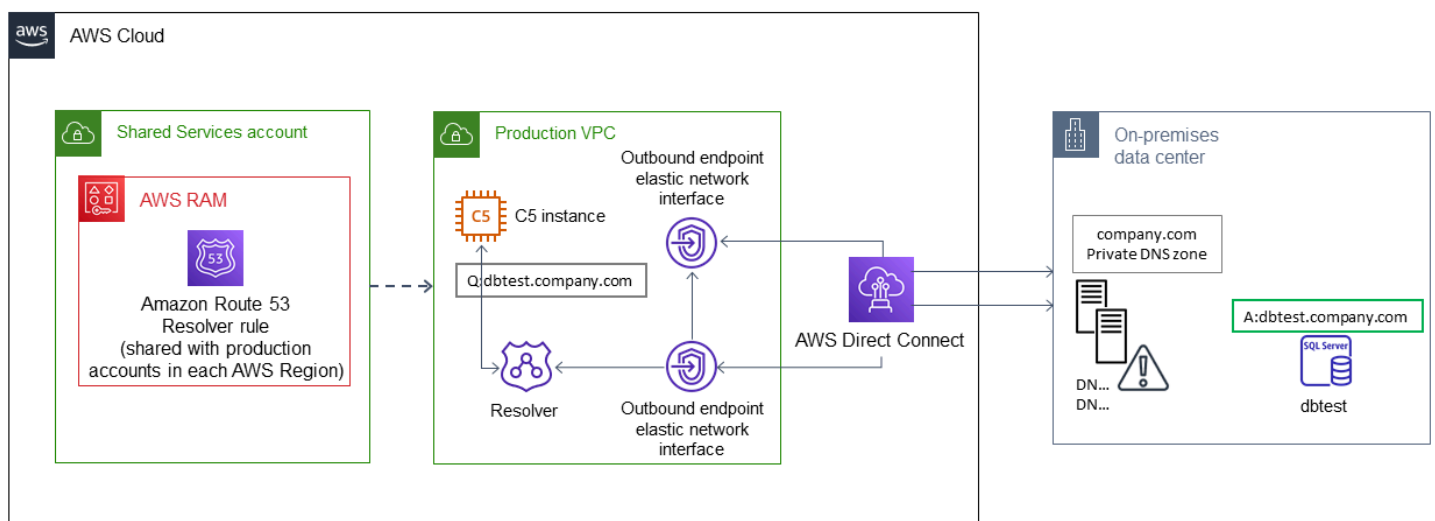

The following diagram shows the architecture in more detail.



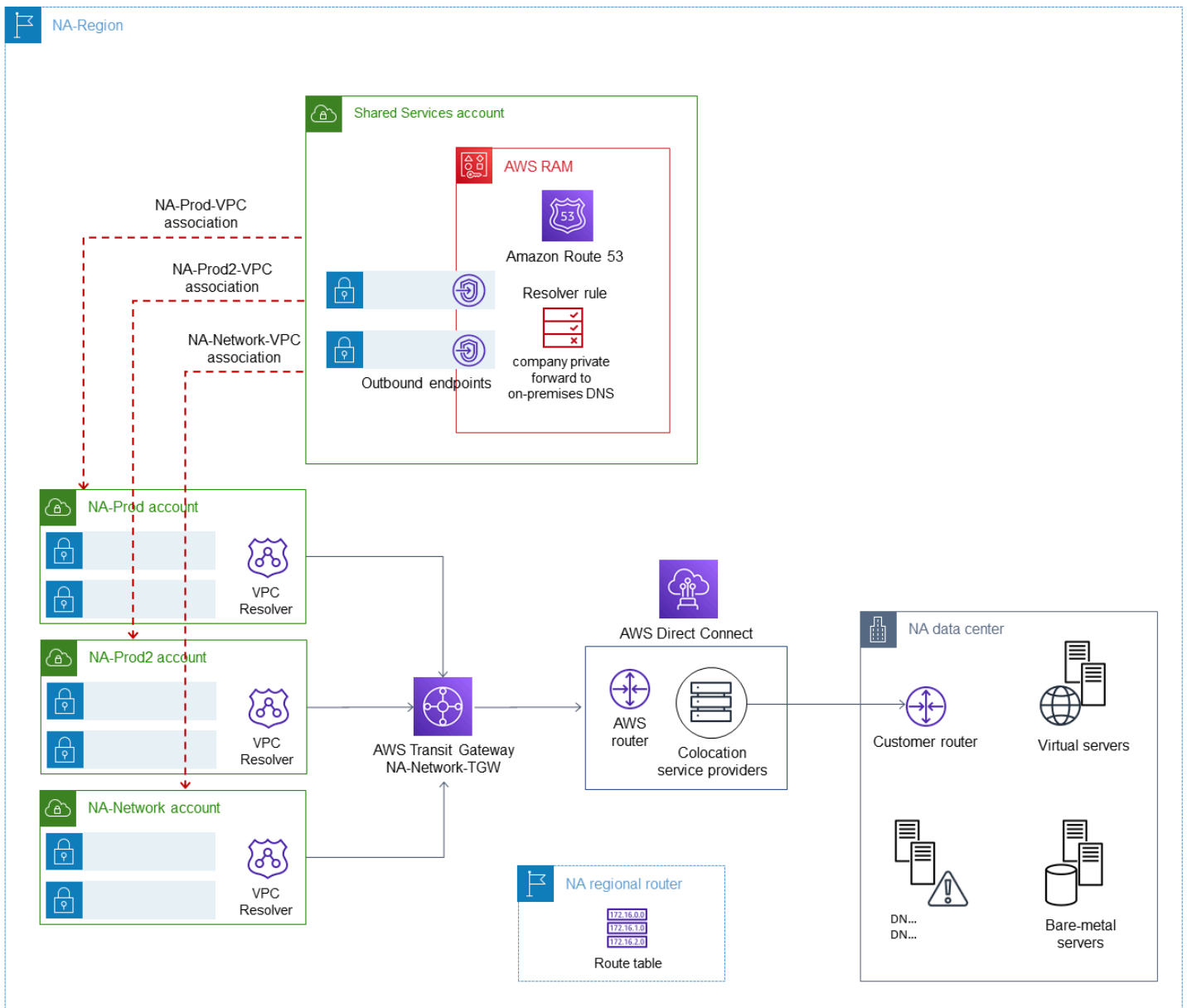

## Automation and scale

You can configure and share Route 53 Resolver rules through AWS RAM by using AWS CloudFormation templates.

## Tools

### AWS services

- [AWS Control Tower](#) helps you set up and govern an AWS multi-account environment, following prescriptive best practices.

- [AWS Resource Access Manager \(AWS RAM\)](#) helps you securely share your resources across AWS accounts to reduce operational overhead and provide visibility and auditability.
- [Amazon Route 53](#) is a highly available and scalable DNS web service.

## Additional tools

- **nslookup** and **dig** are utilities for querying DNS records.

## Epics

### Configure the Resolver endpoints and rules

Task	Description	Skills required
Configure Route 53 outbound Resolver endpoints and rules.	<ol style="list-style-type: none"><li>1. Sign in to the AWS Management Console for the AWS account that you want to configure and share the Route 53 outbound Resolver rule from.</li><li>2. Open the Route 53 console at <a href="https://console.aws.amazon.com/route53/">https://console.aws.amazon.com/route53/</a>.</li><li>3. On the navigation bar, choose the Region where you want to configure the Resolver endpoint.</li><li>4. In the navigation pane, choose <b>Outbound endpoints</b>, and then choose <b>Configure endpoints</b>.</li><li>5. Provide general settings, IP addresses, and optional</li></ol>	General AWS

Task	Description	Skills required
	<p>tag information, and then choose <b>Next</b>.</p> <p>6. Create one or more rules to specify the domain names of the DNS queries that you want to forward to your network, and then choose <b>Save</b>.</p> <p>For more information, see <a href="#">Forwarding outbound DNS queries to your network</a> in the Route 53 documentation.</p>	

Task	Description	Skills required
Create and share Route 53 outbound Resolver rules with AWS principals.	<ol style="list-style-type: none"><li>1. Open the AWS RAM console at <a href="https://console.aws.amazon.com/ram/">https://console.aws.amazon.com/ram/</a>.</li><li>2. In the navigation pane, choose <b>Resource shares</b>, and then choose <b>Create resource share</b>.</li><li>3. Provide a share name.</li><li>4. For resource type, choose <b>Resolver Rules</b>.</li><li>5. Choose the Resolver rule that you want to share, provide optional tag key and value information, and then choose <b>Next</b>.</li><li>6. Choose the principals that you want to share the Resolver rule resource with. Principals can be internal or external to your AWS organization. For example, you can choose your AWS organization, a specific organizational unit (OU) within the organization, or a specific account.</li><li>7. Review and create the resource share.</li></ol> <p>After the resource is created and shared, it appears in the <b>Shared with me</b> section of the navigatio</p>	General AWS

Task	Description	Skills required
	<p>n pane for the principals it is shared with.</p> <p>8. Associate the VPCs in the (principal) account with the Resolver rule that has been shared by the shared services or networking account.</p> <p>For more information, see <a href="#">Sharing your AWS resources</a> in the AWS RAM documentation.</p>	
<p>Test the outbound DNS name resolution.</p>	<p>Test the name resolution by using the <b>nslookup</b> or <b>dig</b> utility on instances in a VPC in an account that you have shared the Resolver rule with.</p> <p>The query should resolve to the IP address of a resource that resides within your on-premises data center.</p>	<p>General AWS</p>

## Related resources

- [Resolving on-prem DNS in hybrid environments](#) (video)
- [Forwarding outbound DNS queries to your network](#) (Route 53 documentation)
- [Sharing your AWS resources](#) (AWS RAM documentation)

# Set up DNS resolution for hybrid networks in a single-account AWS environment

*Created by Abdullahi Olaoye (AWS)*

**Environment:** Production

**Technologies:** Infrastructure

**AWS services:** Amazon Route 53; Amazon VPC

## Summary

This pattern describes how to set up a fully hybrid Domain Name System (DNS) architecture that enables end-to-end DNS resolution of on-premise resources, AWS resources, and internet DNS queries, without administrative overhead. The pattern describes how to set up Amazon Route 53 Resolver forwarding rules that determine where a DNS query that originates from AWS should be sent, based on the domain name. DNS queries for on-premises resources are forwarded to on-premises DNS resolvers. DNS queries for AWS resources and internet DNS queries are resolved by Route 53 Resolver.

This pattern covers hybrid DNS resolution in an AWS single-account environment. For information about setting up outbound DNS queries in an AWS multi-account environment, see the pattern [Set up DNS resolution for hybrid networks in a multi-account AWS environment](#).

## Prerequisites and limitations

### Prerequisites

- An AWS account
- A virtual private cloud (VPC) in your AWS account
- A network connection between the on-premises environment and your VPC, through AWS Virtual Private Network (AWS VPN) or AWS Direct Connect
- IP addresses of your on-premises DNS resolvers (reachable from your VPC)
- Domain/subdomain name to forward to on-premises resolvers (for example, onprem.mydc.com)
- Domain/subdomain name for the AWS private hosted zone (for example, myvpc.cloud.com)

# Architecture

## Target technology stack

- Amazon Route 53 private hosted zone
- Amazon Route 53 Resolver
- Amazon VPC
- AWS VPN or Direct Connect

## Target architecture

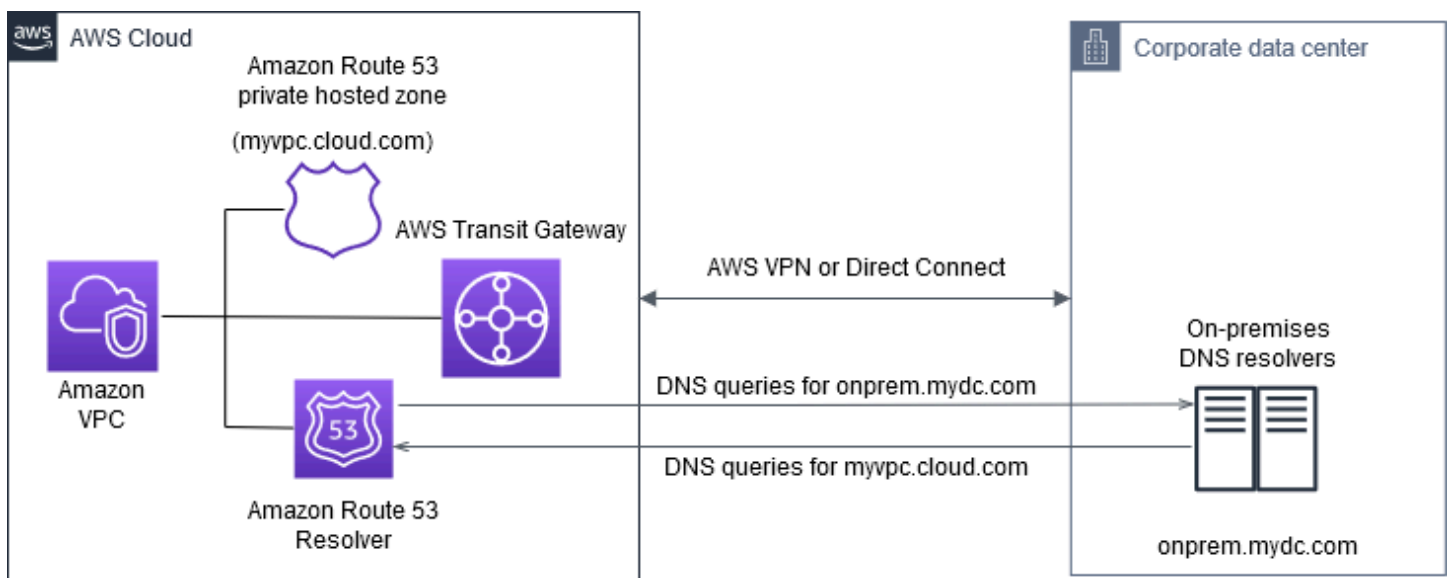

## Tools

- [Amazon Route 53 Resolver](#) makes hybrid cloud easier for enterprise customers by enabling seamless DNS query resolution across your entire hybrid cloud. You can create DNS endpoints and conditional forwarding rules to resolve DNS namespaces between your on-premises data center and your VPCs.
- [Amazon Route 53 private hosted zone](#) is a container that holds information about how you want Route 53 to respond to DNS queries for a domain and its subdomains within one or more VPCs that you create with the Amazon VPC service.

## Epics

### Configure a private hosted zone

Task	Description	Skills required
Create a Route 53 private hosted zone for an AWS reserved domain name such as myvpc.cloud.com.	This zone holds the DNS records for AWS resources that should be resolved from the on-premises environment. For instructions, see <a href="#">Creating a private hosted zone</a> in the Route 53 documentation.	Network admin, System admin
Associate the private hosted zone with your VPC.	To enable resources in your VPC to resolve DNS records in this private hosted zone, you must associate your VPC with the hosted zone. For instructions, see <a href="#">Creating a private hosted zone</a> in the Route 53 documentation.	Network admin, System admin

### Set up Route 53 Resolver endpoints

Task	Description	Skills required
Create an inbound endpoint.	Route 53 Resolver uses the inbound endpoint to receive DNS queries from on-premises DNS resolvers. For instructions, see <a href="#">Forwarding inbound DNS queries to your VPCs</a> in the Route 53 documentation. Make a note of the inbound endpoint IP address.	Network admin, System admin



Task	Description	Skills required
Create an outbound endpoint.	Route 53 Resolver uses the outbound endpoint to send DNS queries to on-premises DNS resolvers. For instructions, see <a href="#">Forwarding outbound DNS queries to your network</a> in the Route 53 documentation. Make a note of the output endpoint ID.	Network admin, System admin

### Set up a forwarding rule and associate it with your VPC

Task	Description	Skills required
Create a forwarding rule for the on-premises domain.	This rule will instruct Route 53 Resolver to forward any DNS queries for on-premises domains (such as onprem.mydc.com) to on-premises DNS resolvers. To create this rule, you will need the IP addresses of the on-premises DNS resolvers and the outbound endpoint ID for Route 53 Resolver. For instructions, see <a href="#">Managing forwarding rules</a> in the Route 53 documentation.	Network admin, System admin
Associate the forwarding rule with your VPC.	For the forwarding rule to take effect, you must associate the rule with your VPC. Route 53 Resolver then takes the rule into consideration when resolving	Network admin, System admin

Task	Description	Skills required
	a domain. For instructions, see <a href="#">Managing forwarding rules</a> in the Route 53 documentation.	

## Configure on-premises DNS resolvers

Task	Description	Skills required
Configure conditional forwarding in the on-premise DNS resolvers.	For DNS queries to be sent to the Route 53 private hosted zone from the on-premises environment, you must configure conditional forwarding in the on-premises DNS resolvers. This instructs the DNS resolvers to forward all DNS queries for the AWS domain (for example, for myvpc.cloud.com) to the inbound endpoint IP address for Route 53 Resolver.	Network admin, System admin

## Test end-to-end DNS resolution

Task	Description	Skills required
Test DNS resolution from AWS to the on-premises environment.	From a server in the VPC, perform a DNS query for an on-premises domain (such as server1.onprem.mydc.com).	Network admin, System admin

Task	Description	Skills required
Test DNS resolution from the on-premises environment to AWS.	From an on-premises server, perform DNS resolution for an AWS domain (such as server1.myvpc.cloud.com).	Network admin, System admin

## Related resources

- [Centralized DNS management of hybrid cloud with Amazon Route 53 and AWS Transit Gateway](#) (AWS Networking & Content Delivery blog)
- [Simplify DNS management in a multi-account environment with Route 53 Resolver](#) (AWS Security blog)
- [Working with private hosted zones](#) (Route 53 documentation)
- [Getting started with Route 53 Resolver](#) (Route 53 documentation)

# Set up UiPath RPA bots automatically on Amazon EC2 by using AWS CloudFormation

Created by Dr. Rahul Sharad Gaikwad (AWS) and Tamilselvan P (AWS)

**Environment:** PoC or pilot

**Technologies:** Infrastructure;  
DevOps

**Workload:** All other  
workloads

**AWS services:** Amazon  
CloudWatch; EC2 Image  
Builder; AWS Systems  
Manager; AWS CloudForm  
ation

## Summary

This pattern explains how you can deploy robotic process automation (RPA) bots on Amazon Elastic Compute Cloud (Amazon EC2) instances. It uses an [EC2 Image Builder](#) pipeline to create a custom Amazon Machine Image (AMI). An AMI is a preconfigured virtual machine (VM) image that contains the operating system (OS) and preinstalled software to deploy EC2 instances. This pattern uses AWS CloudFormation templates to install [UiPath Studio Community edition](#) on the custom AMI. UiPath is an RPA tool that helps you set up robots to automate your tasks.

As part of this solution, EC2 Windows instances are launched by using the base AMI, and the UiPath Studio application is installed on the instances. The pattern uses the Microsoft System Preparation (Sysprep) tool to duplicate the customized Windows installation. After that, it removes the host information and creates a final AMI from the instance. You can then launch the instances on demand by using the final AMI with your own naming conventions and monitoring setup.

**Note:** This pattern doesn't provide any information about using RPA bots. For that information, see the [UiPath documentation](#). You can also use this pattern to set up other RPA bot applications by customizing the installation steps based on your requirements.

This pattern provides the following automations and benefits:

- **Application deployment and sharing:** You can build Amazon EC2 AMIs for application deployment and share them across multiple accounts through an EC2 Image Builder pipeline, which uses AWS CloudFormation templates as infrastructure as code (IaC) scripts.
- **Amazon EC2 provisioning and scaling:** CloudFormation IaC templates provide custom computer name sequences and Active Directory join automation.
- **Observability and monitoring:** The pattern sets up Amazon CloudWatch dashboards to help you monitor Amazon EC2 metrics (such as CPU and disk usage).
- **RPA benefits for your business:** RPA improves accuracy because robots can perform assigned tasks automatically and consistently. RPA also increases speed and productivity because it removes operations that don't add value and handles repetitious activities.

## Prerequisites and limitations

### Prerequisites

- An active [AWS account](#)
- [AWS Identity and Access Management \(IAM\) permissions](#) for deploying CloudFormation templates
- [IAM policies](#) to set up cross-account AMI distribution with EC2 Image Builder

## Architecture

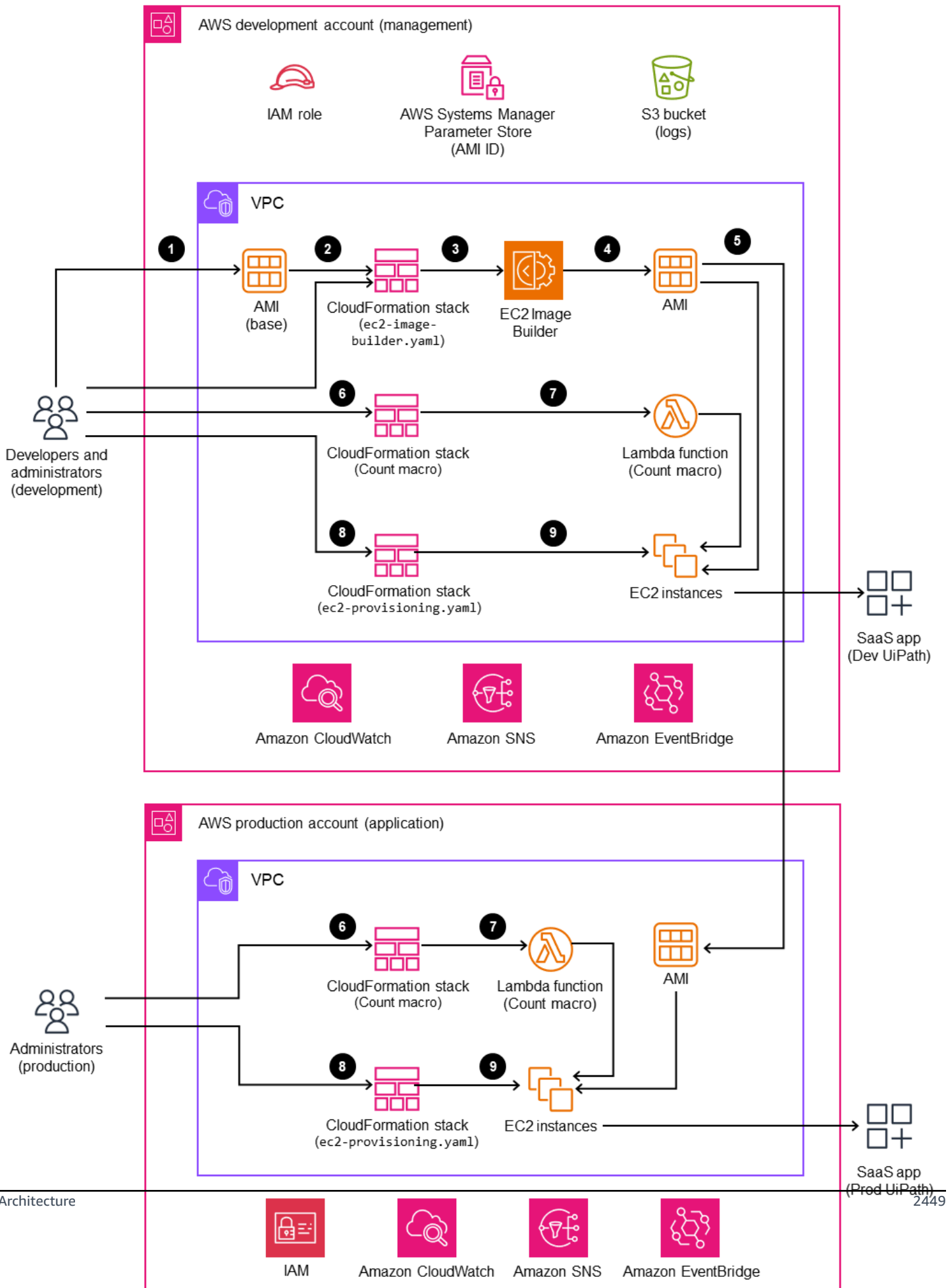

1. The administrator provides the base Windows AMI in the `ec2-image-builder.yaml` file and deploys the stack in the CloudFormation console.
2. The CloudFormation stack deploys the EC2 Image Builder pipeline, which includes the following resources:
  - `Ec2ImageInfrastructureConfiguration`
  - `Ec2ImageComponent`
  - `Ec2ImageRecipe`
  - `Ec2AMI`
3. The EC2 Image Builder pipeline launches a temporary Windows EC2 instance by using the base AMI and installs the required components (in this case, UiPath Studio).
4. The EC2 Image Builder removes all the host information and creates an AMI from Windows Server.
5. You update the `ec2-provisioning.yaml` file with the custom AMI and launch a number of EC2 instances based on your requirements.
6. You deploy the Count macro by using a CloudFormation template. This macro provides a **Count** property for CloudFormation resources so you can specify multiple resources of the same type easily.
7. You update the name of the macro in the CloudFormation `ec2-provisioning.yaml` file and deploy the stack.
8. The administrator updates the `ec2-provisioning.yaml` file based on requirements and launches the stack.
9. The template deploys EC2 instances with the UiPath Studio application.

## Tools

### AWS services

- [AWS CloudFormation](#) helps you model and manage infrastructure resources in an automated and secure manner.
- [Amazon CloudWatch](#) helps you observe and monitor resources and applications on AWS, on premises, and on other clouds.
- [Amazon Elastic Compute Cloud \(Amazon EC2\)](#) provides secure and resizable compute capacity in the AWS Cloud. You can launch as many virtual servers as you need and quickly scale them up or down.

- [EC2 Image Builder](#) simplifies the building, testing, and deployment of virtual machines and container images for use on AWS or on premises.
- [Amazon EventBridge](#) helps you build event-driven applications at scale across AWS, existing systems, or software as a service (SaaS) applications.
- [AWS Identity and Access Management \(IAM\)](#) helps you securely control access to AWS resources. With IAM, you can centrally manage permissions that control which AWS resources users can access. You use IAM to control who is authenticated (signed in) and authorized (has permissions) to use resources.
- [AWS Lambda](#) is a serverless, event-driven compute service that lets you run code for virtually any type of application or backend service without provisioning or managing servers. You can call Lambda functions from over 200 AWS services and SaaS applications, and pay only for what you use.
- [Amazon Simple Storage Service \(Amazon S3\)](#) is a cloud-based object storage service that helps you store, protect, and retrieve any amount of data..
- [AWS Systems Manager Agent \(SSM Agent\)](#) helps Systems Manager update, manage, and configure EC2 instances, edge devices, on-premises servers, and virtual machines (VMs).

## Code repositories

The code for this pattern is available in the GitHub [UiPath RPA bot setup using CloudFormation](#) repository. The pattern also uses a macro that's available from the [AWS CloudFormation Macros repository](#).

## Best practices

- AWS releases new [Windows AMIs](#) each month. These contain the latest OS patches, drivers, and launch agents. We recommend that you use the latest AMI when you launch new instances or when you build your own custom images.
- Apply all available Windows or Linux security patches during image builds.



# Epics

## Deploy an image pipeline for the base image

Task	Description	Skills required
Set up an EC2 Image Builder pipeline.	<ol style="list-style-type: none"><li>1. Clone the <a href="#">UiPath RPA bot setup using CloudFormation</a> repository, or download the <code>ec2-image-builder.yaml</code> template from the repository.</li><li>2. Sign in to the AWS Management Console, and open the <a href="#">AWS CloudFormation console</a>.</li><li>3. Choose <b>Create stack</b>.</li><li>4. In the <b>Specify template</b> section, choose <b>Upload a template file</b>.</li><li>5. Locate and upload the <code>ec2-image-builder.yaml</code> template from your computer, and then choose <b>Next</b>.</li><li>6. Provide input parameters for your stack or accept the default values. Choose <b>Next</b>.</li></ol> <p><b>Note:</b> The number and values of parameters might vary depending on your input values.</p>	AWS DevOps

Task	Description	Skills required
	<p>7. Optionally, configure stack options, and then choose <b>Next</b>.</p> <p>8. Review your stack details.</p> <p>9. At the end of the screen, select the check box to acknowledge capabilities, and then choose <b>Submit</b>.</p> <p>10 Monitor the stack's progress. When the status is <code>CREATE_COMPLETE</code> , the deployment is ready.</p>	
View EC2 Image Builder settings.	<p>The EC2 Image Builder settings include infrastructure configuration, distribution settings, and security scanning settings. To view the settings:</p> <ol style="list-style-type: none"> <li>1. Open the <a href="#">EC2 Image Builder console</a>.</li> <li>2. From the navigation pane, navigate to various Image Builder settings.</li> </ol> <p><b>Note:</b> As a best practice, you should make any updates to EC2 Image Builder through the CloudFormation template only.</p>	AWS DevOps

Task	Description	Skills required
View the image pipeline.	<p>To view the deployed image pipeline:</p> <ol style="list-style-type: none"><li>1. On the EC2 Image Builder console, choose <b>Image pipelines</b> from the navigation pane.</li><li>2. Select the image pipeline you created.</li><li>3. View the configuration details of the output images, image recipe, infrastructure configuration, distribution settings, Amazon EventBridge rules, and tags.</li></ol>	AWS DevOps

Task	Description	Skills required
View Image Builder logs.	<p>EC2 Image Builder logs are aggregated in CloudWatch log groups. To view the logs in CloudWatch:</p> <ol style="list-style-type: none"><li>1. Open the <a href="#">CloudWatch console</a>.</li><li>2. In the navigation pane, choose <b>Logs, Log groups</b>.</li><li>3. Choose the log group name. EC2 Image Builder logs are aggregated in the log group <code>/aws/imagebuilder/XXX</code> .</li><li>4. Check the latest logs in the respective log stream for any errors encountered when running the image pipeline.</li></ol> <p>EC2 Image Builder logs are also stored in an S3 bucket. To view the logs in the bucket:</p> <ol style="list-style-type: none"><li>1. Open the <a href="#">Amazon S3 console</a>.</li><li>2. In the <b>Buckets</b> list, choose the bucket name. The logs are aggregated in the S3 bucket <code>&lt;stack-name&gt;-XXXXXX</code> .</li></ol>	AWS DevOps

Task	Description	Skills required
Upload the UiPath file to an S3 bucket.	<ol style="list-style-type: none"> <li>1. Download the .msi file for UiPath Studio from the location <a href="https://download.uipath.com/UiPathStudioCommunity.msi">https://download.uipath.com/UiPathStudioCommunity.msi</a>.</li> <li>2. Upload the file to an S3 bucket.</li> <li>3. Update the bucket name and file key in the ec2-image-builder.yaml template, in the user data section, <a href="#">line number 310</a>.</li> </ol>	AWS DevOps

## Deploy and test the Count macro

Task	Description	Skills required
Deploy the Count macro.	<ol style="list-style-type: none"> <li>1. Clone or download the <a href="#">Count CloudFormation macro</a>.</li> <li>2. Navigate to the Count folder.</li> <li>3. You will need an S3 bucket to store the CloudFormation artifacts. If you don't have an S3 bucket already, create one with the name <code>aws_s3_mb_s3://&lt;bucket name&gt;</code>.</li> <li>4. Package the Count macro template. The template uses the <a href="#">AWS Serverless Application Model (SAM)</a>,</li> </ol>	DevOps engineer

Task	Description	Skills required
	<p>so it must be transformed before you can deploy it.</p> <pre>aws cloudformation package \   --template-file template.yaml \   --s3-bucket &lt;your bucket name here&gt; \   --output- template-file packaged.yaml</pre> <p>For example:</p> <pre>aws cloudformation package \   --template-file template.yaml \   --s3-bucket count-macro-ec2 \   --output- template-file packaged.yaml</pre> <p>5. Deploy the packaged template to create a CloudFormation stack.</p> <pre>aws cloudformation deploy \   --stack-name Count-macro \   --template-file packaged.yaml \   --capabilities CAPABILITY_IAM</pre>	

Task	Description	Skills required
	<p>If you want to use the console, follow the instructions in the previous epic or in the <a href="#">CloudFormation documentation</a>.</p>	
<p>Test the Count macro.</p>	<p>To test the macro's capabilities, try launching the example template that's provided with the macro.</p> <pre data-bbox="597 695 1027 1056">aws cloudformation   deploy \     --stack-name Count-   test \     --template-file   test.yaml \     --capabilities   CAPABILITY_IAM</pre>	<p>DevOps engineer</p>

## Deploy the CloudFormation stack to provision instances with the custom image

Task	Description	Skills required
<p>Deploy the Amazon EC2 provisioning template.</p>	<p>To deploy EC2 Image Pipeline by using CloudFormation:</p> <ol style="list-style-type: none"> <li>1. Download the <code>ec2-provisioning.yaml</code> template from the <a href="#">GitHub repository</a>, or locate it on your computer if you cloned the repository.</li> <li>2. Open the <a href="#">CloudFormation console</a>.</li> </ol>	<p>AWS DevOps</p>

Task	Description	Skills required
	<ol style="list-style-type: none"><li>3. Repeat the steps from the first epic (or follow the instructions in the <a href="#">CloudFormation documentation</a>) to deploy <code>ec2-provisioning.yaml</code>.</li></ol>	
View Amazon EC2 settings.	<p>Amazon EC2 settings include security, networking, storage, status checks, monitoring, and tags configurations. To view these configurations:</p> <ol style="list-style-type: none"><li>1. Open the <a href="#">Amazon EC2 console</a>.</li><li>2. In the navigation pane, choose <b>Instances</b>, and then select the EC2 instance that was created by the Amazon EC2 provisioning template.</li><li>3. In the instance summary, select the tabs to view the corresponding Amazon EC2 settings.</li></ol>	AWS DevOps



Task	Description	Skills required
View the CloudWatch dashboard.	<ol style="list-style-type: none"><li>1. Open the <a href="#">CloudWatch console</a>.</li><li>2. In the navigation pane, choose <b>Dashboards</b>.</li><li>3. Choose the dashboard that has your stack name.</li></ol> <p><b>Note:</b> After you provision the stack, it takes time to populate the dashboard with metrics.</p> <p>The dashboard provides these metrics: CPUUtilization , DiskUtilization , MemoryUtilization , NetworkIn , NetworkOut , StatusCheckFailed .</p>	AWS DevOps
View custom metrics for memory and disk usage.	<ol style="list-style-type: none"><li>1. On the <a href="#">CloudWatch console</a>, choose <b>Dashboard s</b>.</li><li>2. In the navigation pane, choose <b>Metrics, All metrics</b>.</li><li>3. Choose <b>Custom namespaces, CWAgent</b>.</li></ol>	AWS DevOps
View alarms for memory and disk usage.	<ol style="list-style-type: none"><li>1. On the <a href="#">CloudWatch console</a>, in the navigation pane, choose <b>Dashboards</b>.</li><li>2. Choose <b>All alarms</b>.</li></ol>	AWS DevOps

Task	Description	Skills required
Verify the snapshot lifecycle rule.	<ol style="list-style-type: none"><li>1. Open the <a href="#">Amazon EC2 console</a>.</li><li>2. In the navigation pane, choose <b>Lifecycle Manager</b>.</li><li>3. Verify the settings for the AMI lifecycle.</li></ol>	AWS DevOps

### Delete the environment (optional)

Task	Description	Skills required
Delete the stacks.	<p>When your PoC or pilot project is complete, we recommend that you delete the stacks you created to make sure that you aren't charged for these resources.</p> <ol style="list-style-type: none"><li>1. Open the <a href="#">AWS CloudFormation console</a>.</li><li>2. In the navigation pane, choose <b>Stacks</b>, and then select one or both stacks you created earlier that you want to delete. The stack must be currently running.</li><li>3. In the stack details pane, choose <b>Delete</b>.</li><li>4. When prompted, choose <b>Delete stack</b>.</li></ol> <p><b>Important:</b> The stack deletion operation can't be stopped</p>	AWS DevOps

Task	Description	Skills required
	<p>after it begins. The stack proceeds to the <code>DELETE_IN_PROGRESS</code> state.</p> <p>If the deletion fails, the stack will be in the <code>DELETE_FAILED</code> state. For solutions, see <a href="#">Delete stack fails</a> in the AWS CloudFormation troubleshooting documentation.</p> <p>For information about protecting stacks from being accidentally deleted, see <a href="#">Protecting a stack from being deleted</a> in the AWS CloudFormation documentation.</p>	

## Troubleshooting

Issue	Solution
<p>When you deploy the Amazon EC2 provisioning template, you get the error: <i>Received malformed response from transform 123xxxx:: Count.</i></p>	<p>This is a known issue. (See the custom solution and PR in the <a href="#">AWS CloudFormation macros repository</a>.)</p> <p>To fix this issue, open the AWS Lambda console and update <code>index.py</code> with the content from the <a href="#">GitHub repository</a>.</p>

## Related resources

### GitHub repositories

- [UiPath RPA bot setup using CloudFormation](#)
- [Count CloudFormation Macro](#)

### AWS references

- [Creating a stack on the AWS CloudFormation console](#) (CloudFormation documentation)
- [Troubleshooting CloudFormation](#) (CloudFormation documentation)
- [Monitor memory and disk metrics for Amazon EC2 instances](#) (Amazon EC2 documentation)
- [How can I use the CloudWatch agent to view metrics for Performance Monitor on a Windows server?](#) (AWS re:Post article)

### Additional references

- [UiPath documentation](#)
- [Setting the Hostname in a SysPreped AMI](#) (blog post by Brian Beach)
- [How do I make Cloudformation reprocess a template using a macro when parameters change?](#) (Stack Overflow)

# Set up disaster recovery for Oracle JD Edwards EnterpriseOne with AWS Elastic Disaster Recovery

Created by Thanigaivel Thirumalai (AWS)

**Environment:** Production

**Technologies:** Infrastructure;  
Migration; Networking

**Workload:** Oracle

**AWS services:** AWS Elastic  
Disaster Recovery; Amazon  
EC2

## Summary

Disasters that are triggered by natural catastrophes, application failures, or disruption of services harm revenue and cause downtime for corporate applications. To reduce the repercussions of such events, planning for disaster recovery (DR) is critical for firms that adopt JD Edwards EnterpriseOne enterprise resource planning (ERP) systems and other mission-critical and business-critical software.

This pattern explains how businesses can use AWS Elastic Disaster Recovery as a DR option for their JD Edwards EnterpriseOne applications. It also outlines the steps for using Elastic Disaster Recovery failover and failback to construct a cross-Region DR strategy for databases hosted on an Amazon Elastic Compute Cloud (Amazon EC2) instance in the AWS Cloud.

**Note:** This pattern requires the primary and secondary Regions for the cross-Region DR implementation to be hosted on AWS.

[Oracle JD Edwards EnterpriseOne](#) is an integrated ERP software solution for midsize to large companies in a wide range of industries.

AWS Elastic Disaster Recovery minimizes downtime and data loss with fast, reliable recovery of on-premises and cloud-based applications by using affordable storage, minimal compute, and point-in-time recovery.

AWS provides [four core DR architecture patterns](#). This document focuses on setup, configuration, and optimization by using the [pilot light strategy](#). This strategy helps you create a lower-cost DR

environment where you initially provision a replication server for replicating data from the source database, and you provision the actual database server only when you start a DR drill and recovery. This strategy removes the expense of maintaining a database server in the DR Region. Instead, you pay for a smaller EC2 instance that serves as a replication server.

## Prerequisites and limitations

### Prerequisites

- An active AWS account.
- A JD Edwards EnterpriseOne application running on Oracle Database or Microsoft SQL Server with a supported database in a running state on a managed EC2 instance. This application should include all JD Edwards EnterpriseOne base components (Enterprise Server, HTML Server, and Database Server) installed in one AWS Region.
- An AWS Identity and Access Management (IAM) role to set up the Elastic Disaster Recovery service.
- The network for running Elastic Disaster Recovery configured according to the required [connectivity settings](#).

### Limitations

- You can use this pattern to replicate all tiers, unless the database is hosted on Amazon Relational Database Service (Amazon RDS), in which case we recommend that you use the [cross-Region copy functionality](#) of Amazon RDS.
- Elastic Disaster Recovery isn't compatible with CloudEndure Disaster Recovery, but you can upgrade from CloudEndure Disaster Recovery. For more information, see the [FAQ](#) in the Elastic Disaster Recovery documentation.
- Amazon Elastic Block Store (Amazon EBS) limits the rate at which you can take snapshots. You can replicate a maximum number of 300 servers in a single AWS account by using Elastic Disaster Recovery. To replicate more servers, you can use multiple AWS accounts or multiple target AWS Regions. (You will have to set up Elastic Disaster Recovery separately for each account and Region.) For more information, see [Best practices](#) in the Elastic Disaster Recovery documentation.
- The source workloads (the JD Edwards EnterpriseOne application and database) must be hosted on EC2 instances. This pattern doesn't support workloads that are on premises or in other cloud environments.

- This pattern focuses on the JD Edwards EnterpriseOne components. A full DR and business continuity plan (BCP) should include other core services, including:
  - Networking (virtual private cloud, subnets, and security groups)
  - Active Directory
  - Amazon WorkSpaces
  - Elastic Load Balancing
  - A managed database service such as Amazon Relational Database Service (Amazon RDS)

For additional information about prerequisites, configurations, and limitations, see the [Elastic Disaster Recovery documentation](#).

### Product versions

- Oracle JD Edwards EnterpriseOne (Oracle and SQL Server supported versions based on Oracle Minimum Technical Requirements)

## Architecture

### Target technology stack

- A single Region and single virtual private cloud (VPC) for production and non-production, and a second Region for DR
- Single Availability Zones to ensure low latency between servers
- An Application Load Balancer that distributes network traffic to improve the scalability and availability of your applications across multiple Availability Zones
- Amazon Route 53 to provide Domain Name System (DNS) configuration
- Amazon WorkSpaces to provide users with a desktop experience in the cloud
- Amazon Simple Storage Service (Amazon S3) for storing backups, files, and objects
- Amazon CloudWatch for application logging, monitoring, and alarms
- Amazon Elastic Disaster Recovery for disaster recovery

### Target architecture

The following diagram shows the cross-Region disaster recovery architecture for JD Edwards EnterpriseOne using Elastic Disaster Recovery.

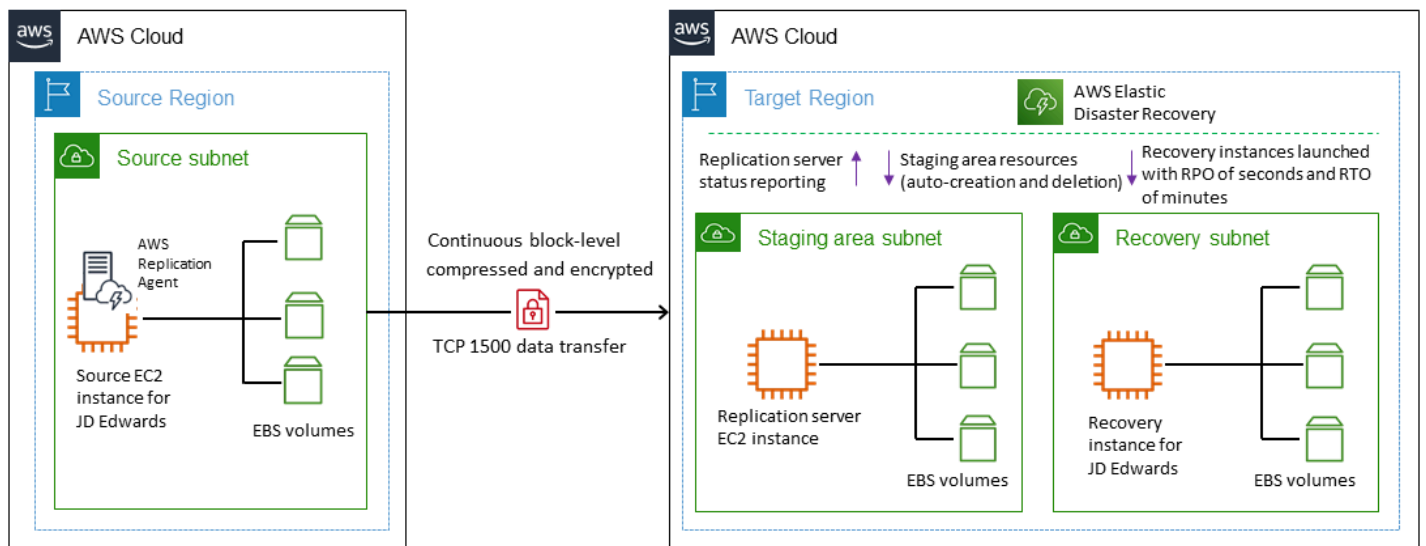

## Procedure

Here is a high-level review of the process. For details, see the *Epics* section.

- Elastic Disaster Recovery replication begins with an initial sync. During the initial sync, the AWS Replication Agent replicates all the data from the source disks to the appropriate resource in the staging area subnet.
- Continuous replication continues indefinitely after the initial sync is complete.
- You review the launch parameters, which include service-specific configurations and an Amazon EC2 launch template, after the agent has been installed and replication has started. When the source server is indicated as being ready for recovery, you can start instances.
- When Elastic Disaster Recovery issues a series of API calls to begin the launch operation, the recovery instance is immediately launched on AWS according to your launch settings. The service automatically spins up a conversion server during startup.
- The new instance is spun up on AWS after the conversion is complete and is ready for use. The source server state at the time of launch is represented by the volumes associated with the launched instance. The conversion process involves changes to the drivers, network, and operating system license to ensure that the instance boots natively on AWS.
- After the launch, the newly created volumes are no longer kept in sync with the source servers. The AWS Replication Agent continues to routinely replicate changes made to your source servers to the staging area volumes, but the launched instances do not reflect those changes.
- When you start a new drill or recovery instance, the data is always reflected in the most recent state that has been replicated from the source server to the staging area subnet.



- When the source server is marked as being prepared for recovery, you can start instances.

**Note:** The process works both ways: for failover from a primary AWS Region to a DR Region, and to fail back to the primary site, when it has been recovered. You can prepare for failback by reversing the direction of data replication from the target machine back to the source machine in a fully orchestrated way.

The benefits of this process described in this pattern include:

- **Flexibility:** Replication servers scale out and scale in based on dataset and replication time, so you can perform DR tests without disrupting source workloads or replication.
- **Reliability:** The replication is robust, non-disruptive, and continuous.
- **Automation:** This solution provides a unified, automated process for test, recovery, and failback.
- **Cost optimization:** You can replicate only the needed volumes and pay for them, and pay for compute resources at the DR site only when those resources are activated. You can use a cost-optimized replication instance (we recommend that you use a compute-optimized instance type) for multiple sources or a single source with a large EBS volume.

## Automation and scale

When you perform disaster recovery at scale, the JD Edwards EnterpriseOne servers will have dependencies on other servers in the environment. For example:

- JD Edwards EnterpriseOne application servers that connect to a JD Edwards EnterpriseOne supported database on boot have dependencies on that database.
- JD Edwards EnterpriseOne servers that require authentication and need to connect to a domain controller on boot to start services have dependencies on the domain controller.

For this reason, we recommend that you automate failover tasks. For example, you can use AWS Lambda or AWS Step Functions to automate the JD Edwards EnterpriseOne startup scripts and load balancer changes to automate the end-to-end failover process. For more information, see the blog post [Creating a scalable disaster recovery plan with AWS Elastic Disaster Recovery](#).

## Tools

### AWS services

- [Amazon Elastic Block Store \(Amazon EBS\)](#) provides block-level storage volumes for use with EC2 instances.
- [Amazon Elastic Compute Cloud \(Amazon EC2\)](#) provides scalable computing capacity in the AWS Cloud. You can launch as many virtual servers as you need and quickly scale them up or down.
- [AWS Elastic Disaster Recovery](#) minimizes downtime and data loss with fast, reliable recovery of on-premises and cloud-based applications using affordable storage, minimal compute, and point-in-time recovery.
- [Amazon Virtual Private Cloud \(Amazon VPC\)](#) gives you full control over your virtual networking environment, including resource placement, connectivity, and security.

## Best practices

### General best practices

- Have a written plan of what to do in the event of a real recovery event.
- After you set up Elastic Disaster Recovery correctly, create an AWS CloudFormation template that can create the configuration on demand, should the need arise. Determine the order in which servers and applications should be launched, and record this in the recovery plan.
- Perform a regular drill (standard Amazon EC2 rates apply).
- Monitor the health of the ongoing replication by using the Elastic Disaster Recovery console or programmatically.
- Protect the point-in-time snapshots and confirm before terminating the instances.
- Create a IAM role for AWS Replication Agent installation.
- Enable termination protection for recovery instances in a real DR scenario.
- Do not use the **Disconnect from AWS** action in the Elastic Disaster Recovery console for servers that you launched recovery instances for, even in the case of a real recovery event. Performing a disconnect terminates all replication resources related to these source servers, including your point-in-time (PIT) recovery points.
- Change the PIT policy to change the number of days for snapshot retention.
- Edit the launch template in Elastic Disaster Recovery launch settings to set the correct subnet, security group, and instance type for your target server.
- Automate the end-to-end failover process by using Lambda or Step Functions to automate JD Edwards EnterpriseOne startup scripts and load balancer changes.

## JD Edwards EnterpriseOne optimization and considerations

- Move **PrintQueue** into the database.
- Move **MediaObjects** into the database.
- Exclude the logs and temp folder from batch and logic servers.
- Exclude the temp folder from Oracle WebLogic.
- Create scripts for startup after the failover.
- Exclude the tempdb for SQL Server.
- Exclude the temp file for Oracle.

## Epics

### Perform initial tasks and configuration

Task	Description	Skills required
Set up the replication network.	Implement your JD Edwards EnterpriseOne system in the primary AWS Region and identify the AWS Region for DR. Follow the steps in the <a href="#">Replication network requirements</a> section of the Elastic Disaster Recovery documentation to plan and set up your replication and DR network.	AWS administrator
Determine RPO and RTO.	Identify the recovery time objective (RTO) and recovery point objective (RPO) for your application servers and database.	Cloud architect, DR architect
Enable replication for Amazon EFS.	If applicable, enable replication from the AWS primary	Cloud administrator

Task	Description	Skills required
	to DR Region for shared file systems such as Amazon Elastic File System (Amazon EFS) by using AWS DataSync, <b>rsync</b> , or another appropriate tool.	
Manage DNS in case of DR.	Identify the process to update the Domain Name System (DNS) during the DR drill or actual DR.	Cloud administrator
Create an IAM role for setup.	Follow the instructions in the <a href="#">Elastic Disaster Recovery initialization and permissions</a> section of the Elastic Disaster Recovery documentation to create an IAM role to initialize and manage the AWS service.	Cloud administrator
Set up VPC peering.	Make sure that the source and target VPCs are peered and accessible to each other. For configuration instructions, see the <a href="#">Amazon VPC documentation</a> .	AWS administrator

## Configure Elastic Disaster Recovery replication settings

Task	Description	Skills required
Initialize Elastic Disaster Recovery.	Open the <a href="#">Elastic Disaster Recovery console</a> , choose the target AWS Region (where you will replicate data and	AWS administrator

Task	Description	Skills required
	launch recovery instances), and then choose <b>Set default replication settings</b> .	
Set up replication servers.	<ol style="list-style-type: none"><li>1. In the <b>Set up replication servers</b> pane, enter the staging area subnet and replication server instance type. The <code>t3.small</code> instance type is selected by default. Configure this setting based on your requirements, and remember to consider instance pricing. For more information, see <a href="#">Amazon EC2 pricing</a>.</li><li>2. In the <b>Service access</b> section, choose <b>View details</b> to review the service linked role and additional policies created during service initialization.</li><li>3. Choose <b>Next</b>.</li></ol>	AWS administrator

Task	Description	Skills required
Configure volumes and security groups.	<ol style="list-style-type: none"><li data-bbox="594 226 1026 499">1. In the <b>Volumes and security groups</b> pane, select the EBS volume type for the replication server and set Amazon EBS encryption to <b>Default</b>.</li><li data-bbox="594 520 1003 844">2. Select <b>Always use AWS Elastic Disaster Recovery security group</b> so that Elastic Disaster Recovery automatically attaches and monitors the default security group.</li><li data-bbox="594 865 824 898">3. Choose <b>Next</b>.</li></ol>	AWS administrator

Task	Description	Skills required
Configure additional settings.	<ol style="list-style-type: none"><li>In the <b>Additional settings</b> pane, configure data routing and throttling, PIT policy, and tags.<ul style="list-style-type: none"><li>Data routing and throttling control how data flows from the external server to the replication servers. Choose <b>Use private IP for data replication</b>. Otherwise, replication servers will be automatically assigned a public IP, and data will flow over the public internet.</li><li>In the <b>Point in time (PIT) policy</b> section, configure a retention policy that determines the duration after which snapshots are not required. The default retention period is seven days.</li><li>In the <b>Tags</b> section, add custom tags to resources created by Elastic Disaster Recovery in your AWS account.</li></ul></li><li>Choose <b>Next</b>, review the settings in the next pane, and then choose <b>Create</b></li></ol>	AWS administrator

Task	Description	Skills required
	<b>default</b> to create the default template.	

## Install the AWS Replication Agent

Task	Description	Skills required
Create an IAM role.	Create an IAM role that contains the <code>AWSElasticDisasterRecoveryAgentInstallationPolicy</code> policy. In the <b>Select AWS access type</b> section, enable programmatic access. Note the access key ID and secret access key. You will need this information during the installation of the AWS Replication Agent.	AWS administrator
Check requirements.	Check and complete the <a href="#">prerequisites</a> in the Elastic Disaster Recovery documentation for installing the AWS Replication Agent.	AWS administrator
Install the AWS Replication Agent.	Follow the <a href="#">installation instructions</a> for your operating system and install the AWS Replication Agent. <ul style="list-style-type: none"> <li>For Microsoft Windows: Download the setup files and run the .exe file as an administrator. Respond to</li> </ul>	AWS administrator



Task	Description	Skills required
	<p>the prompts to complete the installation.</p> <ul style="list-style-type: none"><li>• For Linux: Copy the following commands (in the order presented) and paste them into your Secure Shell (SSH) session. The first command downloads the installer and the second command runs it.</li></ul> <pre data-bbox="626 720 1029 1119">wget -O ./aws-replication-installer-init.py https://aws-elastic-disaster-recovery-us-west-2.s3.amazonaws.com/latest/linux/aws-replication-installer-init.py</pre> <p><b>Note:</b> Change the URL to reflect your Region.</p> <pre data-bbox="626 1276 1029 1436">sudo python3 aws-replication-installer-init.py</pre> <p>Respond to the prompts to complete the installation.</p> <p>Repeat these steps for the remaining server.</p>	

Task	Description	Skills required
Monitor the replication.	<p>Return to the Elastic Disaster Recovery <b>Source servers</b> pane to monitor the replication status. The initial sync will take some time depending on the size of the data transfer.</p> <p>When the source server is fully synced, the server status will be updated to <b>Ready</b>. This means that a replication server has been created in the staging area, and the EBS volumes have been replicated from the source server to the staging area.</p>	AWS administrator

## Configure launch settings

Task	Description	Skills required
Edit launch settings.	<p>To update the launch settings for the drill and recovery instances, on the <a href="#">Elastic Disaster Recovery console</a>, select the source server, and then choose <b>Actions, Edit launch settings</b>. Or you can choose your replicating source machines from the <b>Source servers</b> page, and then choose the <b>Launch Settings</b> tab. This tab has two sections: <b>General launch</b></p>	AWS administrator

Task	Description	Skills required
	<b>settings and EC2 launch template.</b>	
Configure general launch settings.	<p>Revise the general launch settings according to your requirements.</p> <ul style="list-style-type: none"><li>• <b>Instance type right sizing:</b> If you choose <b>Basic</b>, Elastic Disaster Recovery bypasses the instance type you selected in the Amazon EC2 launch template and automatically chooses the instance type based on the operating system, CPU, and RAM of the source server.</li><li>• <b>Copy private IP:</b> Choose whether you want Elastic Disaster Recovery to ensure that the private IP used by the drill or recovery instance matches the private IP used by the source server. If you chose <b>Yes</b>, make sure that the IP range of the subnet you set in the Amazon EC2 launch template includes the private IP address.</li></ul> <p>For more information, see <a href="#">General launch settings</a> in the Elastic Disaster Recovery documentation.</p>	AWS administrator

Task	Description	Skills required
<p>Configure the Amazon EC2 launch template.</p>	<p>Elastic Disaster Recovery uses Amazon EC2 launch templates to launch drill and recovery instances for each source server. The launch template is created automatically for each source server that you add to Elastic Disaster Recovery after you install the AWS Replication Agent.</p> <p>You must set the Amazon EC2 launch template as the default launch template if you want to use it with Elastic Disaster Recovery.</p> <p>For more information, see <a href="#">EC2 Launch Template</a> in the Elastic Disaster Recovery documentation.</p>	<p>AWS administrator</p>

## Initiate DR drill and failover

Task	Description	Skills required
<p>Initiate Drill</p>	<ol style="list-style-type: none"> <li>1. On the <a href="#">Elastic Disaster Recovery console</a>, open the <b>Source servers</b> page and verify that the status of the source server is <b>Ready</b>.</li> </ol>	<p>AWS administrator</p>

Task	Description	Skills required
	<ol style="list-style-type: none"><li data-bbox="592 212 1027 342">2. Select all the source servers that you want to perform the DR drill for.</li><li data-bbox="592 363 1027 827">3. From the <b>Initiate recovery job</b> menu, choose <b>Initiate drill</b> and select the appropriate point-in-time snapshot. This starts a recovery job for the selected source servers. You can monitor the status of the job on the <b>Recovery job history</b> tab.  <b>Note:</b> Further changes to the source server will be synced to the replication server, not to the drill instance.  The launched drill instance also appears on the <b>Recovery instances</b> page.</li><li data-bbox="592 1291 1027 1373">4. Test and verify the DR drill instance.</li><li data-bbox="592 1394 1027 1810">5. On the <b>Recovery instances</b> page, select the drill instance, and then choose <b>Actions, Disconnect from AWS</b>. This deletes the AWS Replication Agent from the recovery instance and removes all resources associated with</li></ol>	

Task	Description	Skills required
	<p>the recovery instance from Elastic Disaster Recovery.</p> <p>6. Choose <b>Delete recovery instances</b>. This deletes the representation of the instance from the Elastic Disaster Recovery console and completely disassociates the instance from the Elastic Disaster Recovery service. It does not delete the underlying EC2 instance.</p> <p>7. Terminate the DR drill instance from the Amazon EC2 console.</p> <p>For more information, see <a href="#">Preparing for failover</a> in the Elastic Disaster Recovery documentation.</p>	

Task	Description	Skills required
Validate the drill.	<p>In the previous step, you launched new target instances in the DR Region. The target instances are replicas of the source servers based on the snapshot taken when you initiated the launch.</p> <p>In this procedure, you connect to your Amazon EC2 target machines to confirm that they're running as expected.</p> <ol style="list-style-type: none"><li>1. Open the <a href="#">Amazon EC2 console</a>.</li><li>2. Choose <b>Instances (running)</b>.</li><li>3. Select the target instance and note its private IPv4 address.</li><li>4. Make sure that you can connect to the EC2 instance and that the JD Edwards EnterpriseOne and related components are replicated as expected.</li></ol>	

Task	Description	Skills required
Initiate a failover.	<p>A failover is the redirection of traffic from a primary system to a secondary system. Elastic Disaster Recovery helps you perform a failover by launching recovery instances on AWS. When the recovery instances have been launched, you redirect the traffic from your primary systems to these instances.</p> <ol style="list-style-type: none"><li>1. On the <a href="#">Elastic Disaster Recovery console</a>, open the <b>Source servers</b> page and verify that the <b>Ready for recovery</b> column for the source server shows <b>Ready</b>, and the <b>Data replication status</b> column shows <b>Healthy</b>.</li><li>2. Select the source server. From the <b>Initiate recovery job</b> menu, choose <b>Initiate recovery</b>.</li><li>3. Select the point-in-time snapshot from which to launch the recovery instance, and then choose <b>Initiate recovery</b>.</li></ol> <p>This starts a recovery job. You can monitor the status of the job on the <b>Recovery instances</b> page.</p>	AWS administrator



Task	Description	Skills required
	<ol style="list-style-type: none"><li data-bbox="591 210 1013 533">4. Test and verify the recovery instance. If required, adjust the DNS configuration and connect your JD Edwards EnterpriseOne application to the database.</li><li data-bbox="591 554 993 877">5. You can now disconnect and decommission the source JD Edwards EnterpriseOne server, because all changes have been written to the new recovery instance.</li><li data-bbox="591 898 1026 1171">6. Register the recovery instance as the source server in the DR Region by following the process described in the <i>Install the AWS Replication Agent</i> epic.</li></ol> <p data-bbox="591 1247 993 1423">For more information, see <a href="#">Performing a failover</a> in the Elastic Disaster Recovery documentation.</p>	

Task	Description	Skills required
Initiate a failback.	<p>The process for initiating a failback is similar to the process for initiating failover.</p> <ol style="list-style-type: none"><li>1. Open the <a href="#">Elastic Disaster Recovery console</a> in the primary Region. Navigate to the <b>Recovery instances</b> page, select the drill instance, and then choose <b>Actions, Disconnect from AWS, Delete recovery instances</b>.</li><li>2. Open the Elastic Disaster Recovery console in the DR Region. Register your new JD Edwards EnterpriseOne server as the source server in the DR Region by installing the AWS Replication Agent. The data will be synced with a new replication server provisioned in the new staging subnet.</li></ol> <p><b>Note:</b> When the new JD Edwards EnterpriseOne server is registered as a source server, you might see two source servers in the Elastic Disaster Recovery console: one server that was created from the primary EC2 instance, and the new</p>	AWS administrator

Task	Description	Skills required
	<p>server that was created from the recovery instance. We recommend that you tag the servers correctly to avoid confusion, and preferably add the new server to the launch template.</p> <p>3. To restart DR replication from the primary Region, disassociate the launched recovery instance from the Elastic Disaster Recovery console in the DR Region, and register the host as a source server in the primary Region.</p> <p>For more information, see <a href="#">Performing a failback</a> in the Elastic Disaster Recovery documentation.</p>	

Task	Description	Skills required
Start JD Edwards EnterpriseOne components.	<ol style="list-style-type: none"><li>1. Start the JD Edwards EnterpriseOne database by logging in to the database server.</li><li>2. When the database is running, start the JD Edwards EnterpriseOne logic and batch servers.</li><li>3. Start WebLogic on the web servers, and start a JAS instance on the JAS servers.</li><li>4. Start WebLogic on the provision server and on the server for the SM console.</li><li>5. Start SM Agent on the servers.</li><li>6. Confirm that the login to JD Edwards EnterpriseOne works correctly.</li></ol> <p>You will need to make incorporate the changes in Route 53 and Application Load Balancer for the JD Edwards EnterpriseOne link to work.</p> <p>You can automate these steps by using Lambda, Step Functions, and Systems Manager (Run Command).</p>	JD Edwards EnterpriseOne CNC

Task	Description	Skills required
	<p><b>Note:</b> Elastic Disaster Recovery performs block-level replication of the source EC2 instance EBS volumes that host the operating system and file systems. Shared file systems that were created by using Amazon EFS aren't part of this replication. You can replicate shared file systems to the DR Region by using AWS DataSync, as noted in the first epic, and then mount these replicated file systems in the DR system.</p>	

## Troubleshooting

Issue	Solution
<p>Source server data replication status is <b>Stalled</b> and replication lags. If you check details, the data replication status displays <b>Agent not seen</b>.</p>	<p>Check to confirm that the stalled source server is running.</p> <p><b>Note:</b> If the source server goes down, the replication server is automatically terminated.</p> <p>For more information about lag issues, see <a href="#">Replication lag issues</a> in the Elastic Disaster Recovery documentation.</p>
<p>Installation of AWS Replication Agent in source EC2 instance fails in RHEL 8.2 after scanning the disks. <code>aws_replication_agent_installer.log</code> reveals that kernel headers are missing.</p>	<p>Before you install the AWS Replication Agent on RHEL 8, CentOS 8, or Oracle Linux 8, run:</p> <pre>sudo yum install elfutils-libelf-devel</pre>

Issue	Solution
<p>On the Elastic Disaster Recovery console, you see the source server as <b>Ready</b> with a lag and data replication status as <b>Stalled</b>.</p> <p>Depending on how long the AWS Replication Agent has been unavailable, the status might indicate high lag, but the issue remains the same.</p>	<p>For more information, see <a href="#">Linux installation requirements</a> in the Elastic Disaster Recovery documentation.</p> <p>Use an operating system command to confirm that the AWS Replication Agent is running in the source EC2 instance, or confirm that the instance is running.</p> <p>After you correct any issues, Elastic Disaster Recovery will restart scanning. Wait until all data has been synced and the replication status is <b>Healthy</b> before you start a DR drill.</p>
<p>Initial replication with high lag. On the Elastic Disaster Recovery console, you can see that the initial sync status is extremely slow for a source server.</p>	<p>Check for the replication lag issues documented in the <a href="#">Replication lag issues</a> section of the Elastic Disaster Recovery documentation.</p> <p>The replication server might be unable to handle the load because of intrinsic compute operations. In that case, try upgrading the instance type after consulting with the <a href="#">AWS Technical Support team</a>.</p>

## Related resources

- [AWS Elastic Disaster Recovery User Guide](#)
- [Creating a scalable disaster recovery plan with AWS Elastic Disaster Recovery](#) (AWS blog post)
- [AWS Elastic Disaster Recovery - A Technical Introduction](#) (AWS Skill Builder course; requires login)
- [AWS Elastic Disaster Recovery quick start guide](#)

# Synchronize data between Amazon EFS file systems in different AWS Regions by using AWS DataSync

Created by Sarat Chandra Pothula (AWS) and Aditya Ambati (AWS)

**Code repository:** [aws-efs-c](#)  
[rossregion-datasync](#)

**Environment:** PoC or pilot

**Technologies:** Infrastructure;  
Storage & backup

**AWS services:** AWS CDK;  
AWS DataSync; Amazon EFS

## Summary

This solution provides a robust framework for efficient and secure data synchronization between Amazon Elastic File System (Amazon EFS) instances in different AWS Regions. This approach is scalable and provides controlled, cross-Region data replication. This solution can enhance your disaster recovery and data redundancy strategies.

By using the AWS Cloud Development Kit (AWS CDK), this pattern uses as an infrastructure as code (IaC) approach to deploy the solution resources. The AWS CDK application deploys the essential AWS DataSync, Amazon EFS, Amazon Virtual Private Cloud (Amazon VPC), and Amazon Elastic Compute Cloud (Amazon EC2) resources. This IaC provides a repeatable and version-controlled deployment process that is fully aligned with AWS best practices.

## Prerequisites and limitations

### Prerequisites

- An active AWS account
- AWS Command Line Interface (AWS CLI) version 2.9.11 or later, [installed](#) and [configured](#)
- AWS CDK version 2.114.1 or later, [installed](#) and [bootstrapped](#)
- NodeJS version 20.8.0 or later, [installed](#)

### Limitations

- The solution inherits limitations from DataSync and Amazon EFS, such as data transfer rates, size limitations, and regional availability. For more information, see [AWS DataSync quotas](#) and [Amazon EFS quotas](#).
- This solution supports Amazon EFS only. DataSync supports [other AWS services](#), such as Amazon Simple Storage Service (Amazon S3) and Amazon FSx for Lustre. However, this solution requires modification to synchronize data with these other services.

## Architecture

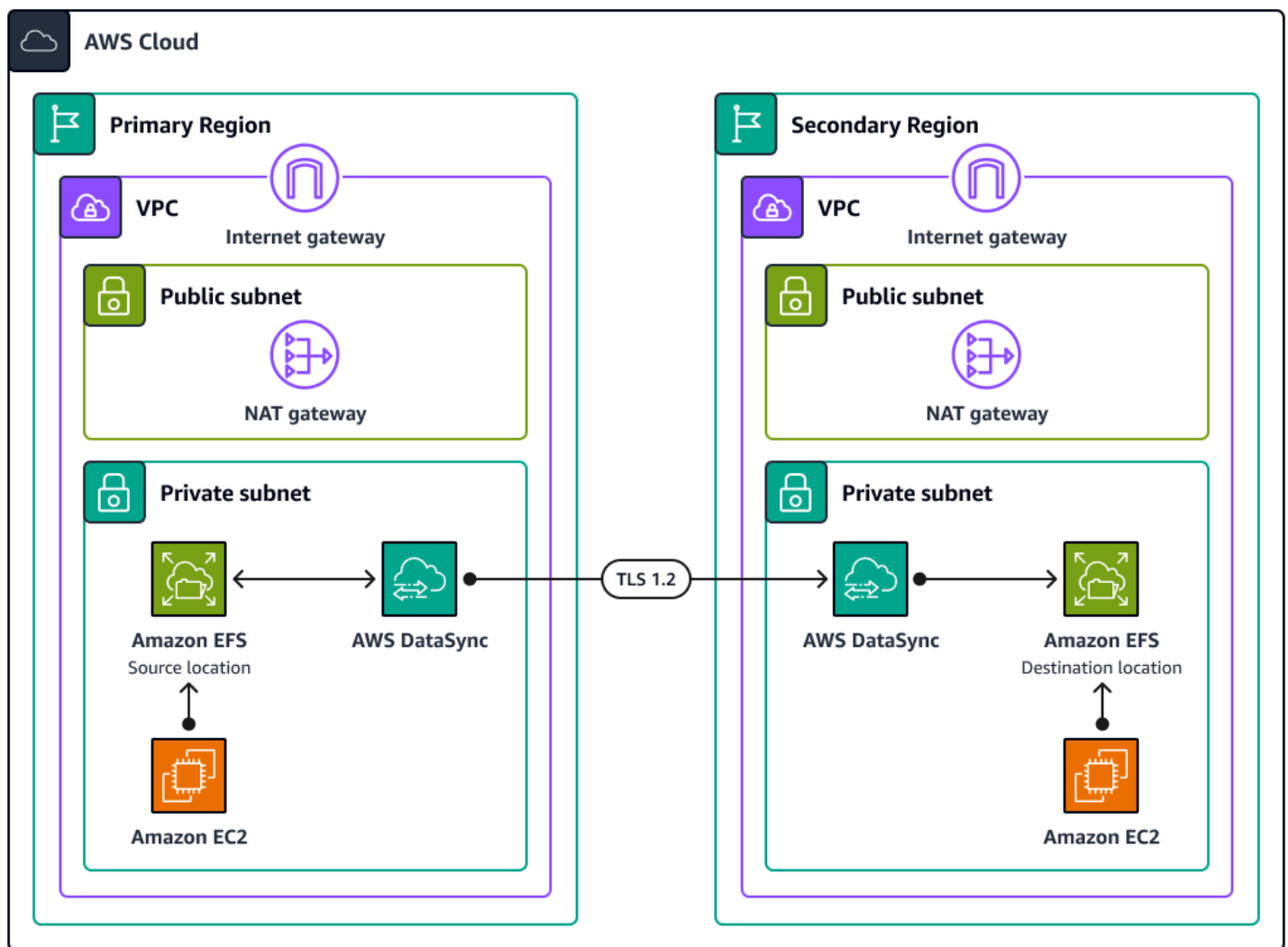

This solution deploys the following AWS CDK stacks:

- **Amazon VPC stack** – This stack sets up virtual private cloud (VPC) resources, including subnets, an internet gateway, and a NAT gateway in both the primary and secondary AWS Regions.



- **Amazon EFS stack** – This stack deploys Amazon EFS file systems into the primary and secondary Regions and connects them to their respective VPCs.
- **Amazon EC2 stack** – This stack launches EC2 instances in the primary and secondary Regions. These instances are configured to mount the Amazon EFS file system, which allows them to access the shared storage.
- **DataSync location stack** – This stack uses a custom construct called `DataSyncLocationConstruct` to create DataSync location resources in the primary and secondary Regions. These resources define endpoints for data synchronization.
- **DataSync task stack** – This stack uses a custom construct called `DataSyncTaskConstruct` to create a DataSync task in the primary Region. This task is configured to synchronize data between the primary and secondary Regions by using the DataSync source and destination locations.

## Tools

### AWS services

- [AWS Cloud Development Kit \(AWS CDK\)](#) is a software development framework that helps you define and provision AWS Cloud infrastructure in code.
- [AWS DataSync](#) is an online data transfer and discovery service that helps you move files or object data to, from, and between AWS storage services.
- [Amazon Elastic Compute Cloud \(Amazon EC2\)](#) provides scalable computing capacity in the AWS Cloud. You can launch as many virtual servers as you need and quickly scale them up or down.
- [Amazon Elastic File System \(Amazon EFS\)](#) helps you create and configure shared file systems in the AWS Cloud.
- [Amazon Virtual Private Cloud \(Amazon VPC\)](#) helps you launch AWS resources into a virtual network that you've defined. This virtual network resembles a traditional network that you'd operate in your own data center, with the benefits of using the scalable infrastructure of AWS.

### Code repository

The code for this pattern is available in the GitHub [Amazon EFS Cross-Region DataSync Project](#) repository.

## Best practices

Follow the best practices described in [Best practices for using the AWS CDK in TypeScript to create IaC projects](#).

## Epics

### Deploy the AWS CDK app

Task	Description	Skills required
Clone the project repository.	<p>Enter the following command to clone the <a href="#">Amazon EFS Cross-Region DataSync Project</a> repository.</p> <pre>git clone https://github.com/aws-samples/aws-efs-crossregion-datasync.git</pre>	AWS DevOps
Install the npm dependencies.	<p>Enter the following command.</p> <pre>npm ci</pre>	AWS DevOps
Choose the primary and secondary Regions.	<p>In the cloned repository, navigate to the <code>src/infra</code> directory. In the <code>Launcher.ts</code> file, update the <code>PRIMARY_AWS_REGION</code> and <code>SECONDARY_AWS_REGION</code> values. Use the corresponding <a href="#">Region codes</a>.</p> <pre>const primaryRegion = { account: account,</pre>	AWS DevOps

Task	Description	Skills required
	<pre>region: '&lt;PRIMARY _AWS_REGION&gt;' }; const secondaryRegion = { account: account, region: '&lt;SECONDA RY_AWS_REGION&gt;' };</pre>	
Bootstrap the environment.	<p>Enter the following command to bootstrap the AWS account and AWS Region that you want to use.</p> <pre>cdk bootstrap &lt;aws_accou nt&gt;/&lt;aws_region&gt;</pre> <p>For more information, see <a href="#">Bootstrapping</a> in the AWS CDK documentation.</p>	AWS DevOps
List the AWS CDK stacks.	<p>Enter the following command to view a list of the AWS CDK stacks in the app.</p> <pre>cdk ls</pre>	AWS DevOps
Synthesize the AWS CDK stacks.	<p>Enter the following command to produce an AWS CloudFormation template for each stack defined in the AWS CDK app.</p> <pre>cdk synth</pre>	AWS DevOps

Task	Description	Skills required
Deploy the AWS CDK app.	<p>Enter the following command to deploy all of the stacks to your AWS account, without requiring manual approval for any changes.</p> <pre>cdk deploy --all --require-approval never</pre>	AWS DevOps

## Validate the deployment

Task	Description	Skills required
Log in to the EC2 instance in the primary Region.	<ol style="list-style-type: none"><li>Using Session Manager, a capability of AWS Systems Manager, log in to the EC2 instance in the primary Region. For instructions, see <a href="#">Connect to your Linux instance with AWS Systems Manager Session Manager</a>.</li><li>Change directories to the Amazon EFS mount path.</li></ol> <pre>cd /mnt/efs</pre>	AWS DevOps
Create a temporary file.	<p>Enter the following command to create a temporary file in the Amazon EFS mount path.</p> <pre>sudo dd if=/dev/zero \ of=tmpst.dat \ bs=1G \ seek=5 \</pre>	AWS DevOps

Task	Description	Skills required
	<pre>count=0  ls -lrt tmpst.dat</pre>	
Start the DataSync task.	<p>Enter the following command to replicate the temporary file from the primary Region to the secondary Region, where &lt;ARN-task&gt; is the Amazon Resource Name (ARN) of your DataSync task.</p> <pre>aws datasync start-task-execution \     --task-arn &lt;ARN-task&gt;</pre> <p>The command returns the ARN of the task execution in the following format.</p> <pre>arn:aws:datasync:&lt;region&gt;:&lt;account-ID&gt;:task/task-execution/&lt;exec-ID&gt;</pre>	AWS DevOps

Task	Description	Skills required
<p>Check the status of the data transfer.</p>	<p>Enter the following command to describe the DataSync execution task, where <code>&lt;ARN-task-execution&gt;</code> is the ARN of the task execution.</p> <pre>aws datasync describe-task-execution \   --task-execution-arn &lt;ARN-task-execution&gt;</pre> <p>The DataSync task is complete when <code>PrepareStatus</code>, <code>TransferStatus</code>, and <code>VerifyStatus</code> all have the value <code>SUCCESS</code>.</p>	<p>AWS DevOps</p>
<p>Log in to the EC2 instance in the secondary Region.</p>	<ol style="list-style-type: none"><li>1. Using Session Manager, a capability of AWS Systems Manager, log in to the EC2 instance in the secondary Region. For instructions, see <a href="#">Connect to your Linux instance with AWS Systems Manager Session Manager</a>.</li><li>2. Change directories to the Amazon EFS mount path.</li></ol> <pre>cd /mnt/efs</pre>	<p>AWS DevOps</p>

Task	Description	Skills required
Validate the replication.	<p>Enter the following command to verify that the temporary file exists in the Amazon EFS file system.</p> <pre>ls -lrt tmpst.dat</pre>	AWS DevOps

## Related resources

### AWS documentation

- [AWS CDK API Reference](#)
- [Configuring AWS DataSync transfers with Amazon EFS](#)
- [Troubleshooting issues with AWS DataSync transfers](#)

### Other AWS resources

- [AWS DataSync FAQs](#)

# Upgrade SAP Pacemaker clusters from ENSA1 to ENSA2

Created by Gergely Cserdi (AWS) and Balazs Sandor Skublics (AWS)

<b>Environment:</b> Production	<b>Source:</b> ENSA1-based Pacemaker cluster	<b>Target:</b> ENSA2-based Pacemaker cluster
<b>R Type:</b> Re-architect	<b>Workload:</b> SAP	<b>Technologies:</b> Infrastructure; Modernization
<b>AWS services:</b> Amazon EC2		

## Summary

This pattern explains the steps and considerations for upgrading an SAP Pacemaker cluster that is based on Standalone Enqueue Server (ENSA1) to ENSA2. The information in this pattern applies to both SUSE Linux Enterprise Server (SLES) and Red Hat Enterprise Linux (RHEL) operating systems.

Pacemaker clusters on SAP NetWeaver 7.52 or S/4HANA 1709 and earlier versions run on an ENSA1 architecture and are configured specifically for ENSA1. If you run your SAP workloads on Amazon Web Services (AWS) and you're interested in moving to ENSA2, you might find that the SAP, SUSE, and RHEL documentation doesn't provide comprehensive information. This pattern describes the technical steps required to reconfigure SAP parameters and Pacemaker clusters to upgrade from ENSA1 to ENSA2. It provides examples of SUSE systems, but the concept is the same for RHEL clusters.

**Notes:** ENSA1 and ENSA2 are concepts that pertain to SAP applications only, so the information in this pattern doesn't apply to SAP HANA or other types of clusters.

Technically, ENSA2 can be used with or without Enqueue Replicator 2. However, high availability (HA) and failover automation (through a cluster solution) require Enqueue Replicator 2. This pattern uses the term *ENSA2 clusters* to refer to clusters with Standalone Enqueue Server 2 and Enqueue Replicator 2.



# Prerequisites and limitations

## Prerequisites

- A working ENSA1-based cluster that uses Pacemaker and Corosync on SLES or RHEL.
- At least two Amazon Elastic Compute Cloud (Amazon EC2) instances where the (ABAP) SAP Central Services (ASCS/SCS) and Enqueue Replication Server (ERS) instances are running.
- Knowledge of managing SAP applications and clusters.
- Access to the Linux environment as root user.

## Limitations

- ENSA1-based clusters support a two-node architecture only.
- ENSA2-based clusters cannot be deployed to SAP NetWeaver versions before 7.52.
- EC2 instances in clusters should be in different AWS Availability Zones.

## Product versions

- SAP NetWeaver version 7.52 or later
- Starting with S/4HANA 2020, only ENSA2 clusters are supported
- Kernel 7.53 or later, which supports ENSA2 and Enqueue Replicator 2
- SLES for SAP Applications version 12 or later
- RHEL for SAP with High Availability (HA) version 7.9 or later

# Architecture

## Source technology stack

- SAP NetWeaver 7.52 with SAP Kernel 7.53 or later
- SLES or RHEL operating system

## Target technology stack

- SAP NetWeaver 7.52 with SAP Kernel 7.53 or later, including S/4HANA 2020 with ABAP platform
- SLES or RHEL operating system

## Target architecture

The following diagram shows an HA configuration of ASCS/SCS and ERS instances based on an ENSA2 cluster.

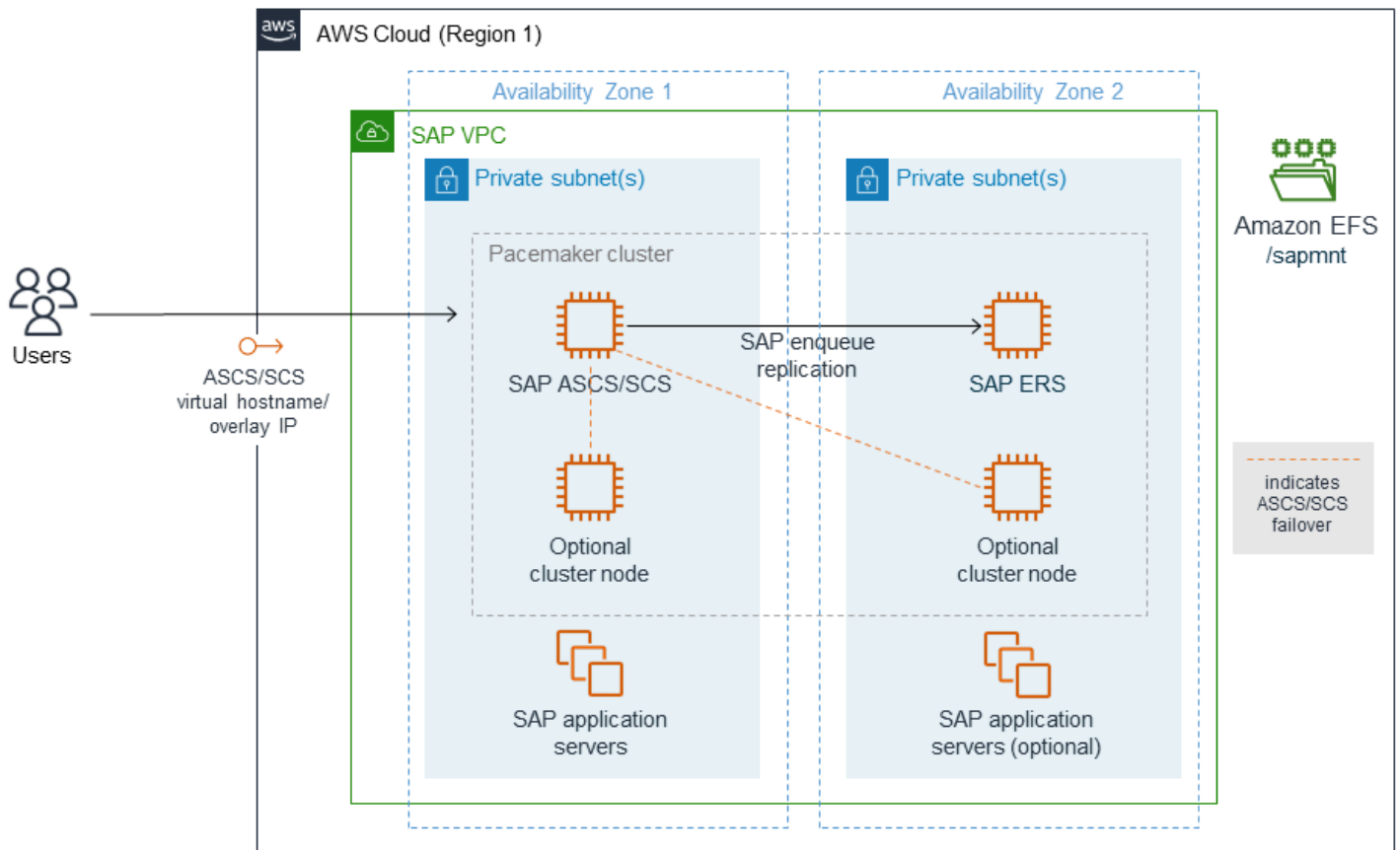

## Comparison of ENSA1 and ENSA2 clusters

SAP introduced ENSA2 as the successor to ENSA1. An ENSA1-based cluster supports a two-node architecture where the ASCS/SCS instance fails over to ERS when an error occurs. This limitation stems from how the ASCS/SCS instance regains the lock table information from the shared memory of the ERS node after failover. ENSA2-based clusters with Enqueue Replicator 2 eliminate this limitation, because the ASCS/SCS instance can collect the lock information from the ERS instance over the network. ENSA2-based clusters can have more than two nodes, because the ASCS/SCS instance is no longer required to fail over to the ERS node. (However, in a two-node ENSA2 cluster environment, the ASCS/SCS instance will still fail over to the ERS node because there are no other nodes in the cluster to fail over to.) ENSA2 is supported starting with SAP Kernel 7.50 with some limitations. For HA setup that supports Enqueue Replicator 2, the minimum requirement is NetWeaver 7.52 (see [SAP OSS Note 2630416](#)). S/4HANA 1809 comes with ENSA2

architecture recommended by default, whereas S/4HANA supports only ENSA2 starting with version 2020.

## Automation and scale

The HA cluster in the target architecture makes ASCS fail over to other nodes automatically.

## Scenarios for moving to ENSA2-based clusters

There are two main scenarios for upgrading to ENSA2-based clusters:

- Scenario 1: You choose to upgrade to ENSA2 without an accompanying SAP upgrade or S/4HANA conversion, assuming that your SAP release and Kernel version support ENSA2.
- Scenario 2: You move to ENSA2 as part of an upgrade or conversion (for example, to S/4HANA 1809 or later) by using SUM.

The [Epics](#) section covers the steps for these two scenarios. The first scenario requires you to manually set up SAP-related parameters before you change the cluster configuration for ENSA2. In the second scenario, the binaries and SAP-related parameters are deployed by SUM, and your only remaining task is to update the cluster configuration for HA. We still recommend that you validate SAP parameters after you use SUM. In most cases, S/4HANA conversion is the main reason for a cluster upgrade.

## Tools

- For OS package managers, we recommend the Zypper (for SLES) or YUM (for RHEL) tools.
- For cluster management, we recommend **crm** (for SLES) or **pcs** (for RHEL) shells.
- SAP instance management tools such as SAPControl.
- (Optional) SUM tool for S/4HANA conversion upgrade.

## Best practices

- For best practices for using SAP workloads on AWS, see the [SAP Lens](#) for the AWS Well-Architected Framework.
- Consider the number of cluster nodes (odd or even) in your ENSA2 multi-node architecture.
- Set up the ENSA2 cluster for SLES 15 in alignment with the SAP S/4-HA-CLU 1.0 certification standard.

- Always save or back up your existing cluster and application state before upgrading to ENSA2.

## Epics

### Configure SAP parameters manually for ENSA2 (scenario 1 only)

Task	Description	Skills required
<p>Configure the parameters in the default profile.</p>	<p>If you want to upgrade to ENSA2 while staying on the same SAP release or if your target release defaults to ENSA1, set the parameters in the default profile (DEFAULT.PFL file) to the following values.</p> <pre data-bbox="594 951 1029 1549"> enq/enable=TRUE enq/serverhost=sapas csvirt enq/serverinst=10 (instance number of ASCS/SCS instance) enque/process_ location=REMOTESA enq/replicatorhost=sap persvirt enq/replicatorinst=11 (instance number of ERS instance) </pre> <p>where <code>sapascsvirt</code> is the virtual hostname for the ASCS instances, and <code>sapersvirt</code> is the virtual hostname for the ERS instances. You can change</p>	<p>SAP</p>

Task	Description	Skills required
	<p>these to fit your target environment.</p> <p><b>Note:</b> To use this upgrade option, your SAP release and Kernel version must support ENSA2 and Enqueue Replicator 2.</p>	

Task	Description	Skills required
Configure the ASCS/SCS instance profile.	<p>If you want to upgrade to ENSA2 while staying on the same SAP release or if your target release defaults to ENSA1, set the following parameters in the ASCS/SCS instance profile.</p> <p>The section of the profile where ENSA1 is defined looks something like the following.</p> <pre data-bbox="597 758 1027 1633"> #----- ----- ----- ----- Start SAP enqueue server #----- ----- ----- ----- _EN = en.sap\$(S APSYSTEMNAME)\$(INS TANCE_NAME) Execute_04 = local rm - f \$_EN Execute_05 = local ln - s -f \$(DIR_EXECUTABLE)/ enserver\$(FT_EXE) \$_EN Start_Program_01 = local \$_EN pf=\$_PF </pre> <p>To reconfigure this section for ENSA2:</p>	SAP

Task	Description	Skills required
	<ol style="list-style-type: none"> <li>1. Change the <code>_EN</code> program prefix to <code>_ENQ</code> based on the latest information from SAP (OSS Note 2501860; requires an <a href="#">SAP ONE Support Launchpad user account</a>).</li> <li>2. Change the binary for enqueue server from <code>enserver</code> to <code>enq_server</code>.</li> <li>3. Set the new parameter <code>enq/server/replication/enable</code> to <code>TRUE</code>.</li> <li>4. Make sure that <code>Autostart = 0</code>.</li> </ol> <p>This profile section would look something like the following after your changes.</p> <pre data-bbox="597 1241 1024 1808"> #----- ----- ----- ----- Start SAP enqueue server #----- ----- ----- ----- _ENQ = enq.sap\$( SAPSYSTEMNAME)\$(IN STANCE_NAME) Execute_04 = local rm - f \$_ENQ </pre>	

Task	Description	Skills required
	<pre>Execute_05 = local ln - s -f \$(DIR_EXECUTABLE)/ enq_server\$(FT_EXE) \$_ENQ) Start_Program_01 = local \$_ENQ pf= \$_PF) ... enq/server/replic ation/enable = TRUE Autostart = 0</pre> <p><b>Important:</b> <code>_ENQ</code> must not have the restart option enabled. If <code>RestartProgram_01</code> is set for <code>_ENQ</code>, change it to <code>StartProgram_01</code>. This prevents SAP from restarting the service or interfering with cluster-managed resources.</p>	



Task	Description	Skills required
Configure the ERS profile.	<p>If you want to upgrade to ENSA2 while staying on the same SAP release or if your target release defaults to ENSA1, set the following parameters in the ERS instance profile.</p> <p>Find the section where the enqueue replicator is defined. It will be similar to the following.</p> <pre data-bbox="594 806 1029 1682"> #----- ----- ----- Start enqueue replicati on server #----- ----- ----- _ER = er.sap\$(S APSYSTEMNAME)\$(INS TANCE_NAME) Execute_03 = local rm - f \$_ER Execute_04 = local ln - s -f \$(DIR_EXECUTABLE)/ enrepserver\$(FT_EXE) \$_ER Start_Program_00 = local \$_ER pf=\$_PF NR=\$(SCSID) </pre> <p>To reconfigure this section for Enqueue Replicator 2:</p>	SAP

Task	Description	Skills required
	<ol style="list-style-type: none"> <li>1. Change the _ER program prefix to _ENQR based on the latest notes from SAP (OSS Note 2501860; requires an <a href="#">SAP ONE Support Launchpad user account</a>).</li> <li>2. Change the binary for the enqueue replicator to enq_replicator instead of enrepserver .</li> <li>3. Make sure that Autostart = 0.</li> </ol> <p>This profile section should look something like the following after your changes.</p> <pre data-bbox="592 1087 1031 1772"> #----- ----- ----- Start enqueue replicati on server #----- ----- ----- _ENQR = enqr.sap\$ (SAPSYSTEMNAME)\$(I NSTANCE_NAME) Execute_01 = local rm - f \$_ENQR Execute_02 = local ln - s -f \$(DIR_EXECUTABLE)/ enq_replicator\$(FT _EXE) \$_ENQR </pre>	

Task	Description	Skills required
	<pre>Start_Program_00 =   local \$_ENQR pf=   \$_PF) NR=\$(SCSID) ... Autostart = 0</pre> <p><b>Important:</b> <code>_ENQR</code> must not have the restart option enabled. If <code>RestartProgram_01</code> is set for <code>_ENQR</code>, change it to <code>StartProgram_01</code>. This prevents SAP from restarting the service or interfering with cluster-managed services.</p>	
Restart SAP Start Services.	<p>After you change the profiles described previously in this epic, restart SAP Start Services for both ASCS/SCS and ERS.</p> <pre>sapcontrol -nr 10 - function RestartSe vice SCT</pre> <pre>sapcontrol -nr 11 - function RestartSe vice SCT</pre> <p>where SCT refers to the SAP system ID, and assuming that 10 and 11 are the instance numbers for ASCS/SCS and ERS instances, respectively.</p>	SAP

## Reconfigure the cluster for ENSA2 (required for both scenarios)

Task	Description	Skills required
Verify version numbers in SAP resource agents.	<p>When you use SUM to upgrade SAP to S/4HANA 1809 or later, SUM handles the parameter changes in the SAP profiles. Only the cluster requires manual adjustment. However, we recommend that you verify the parameter settings before you make any changes to the cluster.</p> <p><b>Note:</b> The examples in this epic assume that you're using the SUSE operating system. If you're using RHEL, you will need to use tools such as YUM and the <b>pcs</b> shell instead of Zypper and <b>crm</b>.</p> <p>Check both nodes in the architecture to confirm that the <code>resource-agents</code> package matches the minimum version recommended by SAP. For SLES, check SAP OSS Note 2641019. For RHEL, check SAP OSS Note 2641322. (SAP Notes require an <a href="#">SAP ONE Support Launchpad user account</a>.)</p> <pre>sapers:sctadm 23&gt; zypper search -s -i resource-agents</pre>	AWS systems administrator

Task	Description	Skills required
	<pre> Loading repository data... Reading installed packages... S   Name   Type     Version   Arch     Repository --+----- ----+-----+--- ----- -----+--- -----+----- ----- i   resource-agents     package   4.8.0+git 30.d0077df0-150300 .8.28.1   x86_64     SLE-Product-HA15-SP3-   Updates </pre> <p>Update the resource-agents version if necessary.</p>	
Back up cluster configuration.	<p>Back up the CRM cluster configuration as follows.</p> <pre> crm configure show &gt; / tmp/cluster_conf ig_backup.txt </pre>	AWS systems administrator
Set maintenance mode.	<p>Set the cluster to maintenance mode.</p> <pre> crm configure property maintenance-mode=" true" </pre>	AWS systems administrator

Task	Description	Skills required
Check cluster configuration.	<p>Check the current cluster configuration.</p> <pre>crm configure show</pre> <p>Here is an excerpt from the full output:</p> <pre>node 1: sapascs node 2: sapers ... primitive rsc_sap_S CT_ASCS10 SAPInstance \ operations \$id=rsc_s ap_SCT_ASCS10-oper ations \ op monitor interval=120 timeout=60 on-fail=r estart \ params InstanceN ame=SCT_ASCS10_sap ascsvirt START_PRO FILE="/sapmnt/SCT/ profile/SCT_ASCS10 _sapascsvirt" \ AUTOMATIC_RECOVER= false \ meta resource-stickines s=5000 failure-t imeout=60 migration- threshold=1 priority= 10 primitive rsc_sap_S CT_ERS11 SAPInstance \ operations \$id=rsc_s ap_SCT_ERS11-opera tions \ op monitor interval=120 timeout=60 on-fail=r estart \</pre>	AWS systems administrator

Task	Description	Skills required
	<pre> params InstanceName=SCT_ERS11_sapersvirt START_PROFILE="/sapmnt/SCT/profile/SCT_ERS11_sapersvirt" \     AUTOMATIC_RECOVER=false IS_ERS=true \ meta priority=1000 ... colocation col_sap_SCT_no_both -5000:     grp_SCT_ERS11     grp_SCT_ASCS10 location loc_sap_SCT_failover_to_ers     rsc_sap_SCT_ASCS10 \ rule 2000: runs_ers_SCT     eq 1 order ord_sap_SCT_first_start_asc Optional: rsc_sap_SCT_ASCS10:start     rsc_sap_SCT_ERS11: stop symmetrical=false ... </pre> <p>where <code>sapascsvirt</code> refers to the virtual hostname for the ASCS instances, <code>sapersvirt</code> refers to the virtual hostname for the ERS instances, and <code>SCT</code> refers to the SAP system ID.</p>	

Task	Description	Skills required
Remove failover colocation constraint.	<p>In the previous example, the location constraint <code>loc_sap_SCT_failover_to_ers</code> specifies that the ENSA1 feature of ASCS should always follow the ERS instance upon failover. With ENSA2, ASCS should be able to fail over freely to any participating nodes, so you can remove this constraint.</p> <pre>crm configure delete loc_sap_SCT_failover_to_ers</pre>	AWS systems administrator



Task	Description	Skills required
Adjust primitives.	<p>You will also need to make minor changes to the ASCS and ERS SAPInstance primitives.</p> <p>Here is an example of an ASCS SAPInstance primitive that is configured for ENSA1.</p> <pre data-bbox="597 617 1026 1528">primitive rsc_sap_S CT_ASCS10 SAPInstance \ operations \$id=rsc_s ap_SCT_ASCS10-oper ations \ op monitor interval=120 timeout=60 on-fail=r estart \ params InstanceN ame=SCT_ASCS10_sap ascsvirt START_PRO FILE="/sapmnt/SCT/ profile/SCT_ASCS10 _sapascsvirt" \ AUTOMATIC_RECOVER= false \ meta resource-stickines s=5000 failure-t imeout=60 migration- threshold=1 priority= 10</pre> <p>To upgrade to ENSA2, change this configuration to the following.</p> <pre data-bbox="597 1738 1026 1875">primitive rsc_sap_S CT_ASCS10 SAPInstance \</pre>	AWS systems administrator

Task	Description	Skills required
	<pre> operations \$id=rsc_s ap_SCT_ASCS10-oper ations \ op monitor interval=120   timeout=60 on-fail=r estart \ params InstanceN ame=SCT_ASCS10_sap ascsvirt START_PRO FILE="/sapmnt/SCT/ profile/SCT_ASCS10 _sapascsvirt" \   AUTOMATIC_RECOVER= false \ meta resource-stickines s=3000 </pre> <p>This is an example of an ERS SAPInstance primitive that is configured for ENSA1.</p> <pre> primitive rsc_sap_S CT_ERS11 SAPInstance \ operations \$id=rsc_s ap_SCT_ERS11-opera tions \ op monitor interval=120   timeout=60 on-fail=r estart \ params InstanceN ame=SCT_ERS11_sape rsvirt START_PRO FILE="/sapmnt/SCT/ profile/SCT_ERS11_ sapersvirt" \   AUTOMATIC_RECOVER= false IS_ERS=true \ meta priority=1000 </pre>	

Task	Description	Skills required
	<p>To upgrade to ENSA2, change this configuration to the following.</p> <pre>primitive rsc_sap_SCT_ERS11 SAPInstance \ operations \$id=rsc_sap_SCT_ERS11-operations \ op monitor interval=120   timeout=60 on-fail=r   restart \   params InstanceName=SCT_ERS11_sapersvirt   START_PROFILE="/sapmnt/SCT/profile/SCT_ERS11_sapersvirt" \   AUTOMATIC_RECOVER=false IS_ERS=true</pre> <p>You can change primitives in various ways. For example, you can revise them in an editor such as vi, as in the following example.</p> <pre>crm configure edit rsc_sap_SCT_ERS11</pre>	

Task	Description	Skills required
Disable maintenance mode.	<p>Disable maintenance mode on the cluster.</p> <pre>crm configure property maintenance-mode="false"</pre> <p>When the cluster is out of maintenance mode, it attempts to bring the ASCS and ERS instances online with the new ENSA2 settings.</p>	AWS systems administrator

### (Optional) Add cluster nodes

Task	Description	Skills required
Review best practices.	Before you add more nodes, make sure to understand best practices such as whether to use an odd or even number of nodes.	AWS systems administrator
Add nodes.	Adding more nodes involves a series of tasks, such as updating the operating system, installing software packages that match the existing nodes, and making mounts available. You can use the <b>Prepare Additional Host</b> option in SAP Software Provisioning Manager (SWPM) to create an SAP-specific baseline of the host. For	AWS systems administrator

Task	Description	Skills required
	more information, see the SAP guides listed in the next section.	

## Related resources

### SAP and SUSE references

To access SAP Notes, you must have an SAP ONE Support Launchpad user account. For more information, see the [SAP Support website](#).

- [SAP Note 2501860 – Documentation for SAP NetWeaver Application Server for ABAP 7.52](#)
- [SAP Note 2641019 – Installation of ENSA2 and update from ENSA1 to ENSA2 in SUSE HA environment](#)
- [SAP Note 2641322 – Installation of ENSA2 and update from ENSA1 to ENSA2 when using the Red Hat HA solutions for SAP](#)
- [SAP Note 2711036 – Usage of the Standalone Enqueue Server 2 in an HA Environment](#)
- [Standalone Enqueue Server 2 \(SAP documentation\)](#)
- [SAP S/4 HANA – Enqueue Replication 2 High Availability Cluster - Setup Guide \(SUSE documentation\)](#)

### AWS references

- [SAP HANA on AWS: High Availability Configuration Guide for SLES and RHEL](#)
- [SAP Lens - AWS Well-Architected Framework](#)

# Use consistent Availability Zones in VPCs across different AWS accounts

Created by Adam Spicer (AWS)

**Code repository:** [Multi-account Availability Zone mapping](#)

**Environment:** Production

**Technologies:** Infrastructure

**AWS services:** AWS CloudFormation; Amazon VPC; AWS Lambda

## Summary

On the Amazon Web Services (AWS) Cloud, an Availability Zone has a name that can vary between your AWS accounts and an [Availability Zone ID \(AZ ID\)](#) that identifies its location. If you use AWS CloudFormation to create virtual private clouds (VPCs), you must specify the Availability Zone's name or ID when creating the subnets. If you create VPCs in multiple accounts, the Availability Zone name is randomized, which means that subnets use different Availability Zones in each account.

To use the same Availability Zone across your accounts, you must map the Availability Zone name in each account to the same AZ ID. For example, the following diagram shows that the use1-az6 AZ ID is named us-east-1a in AWS account A and us-east-1c in AWS account Z.

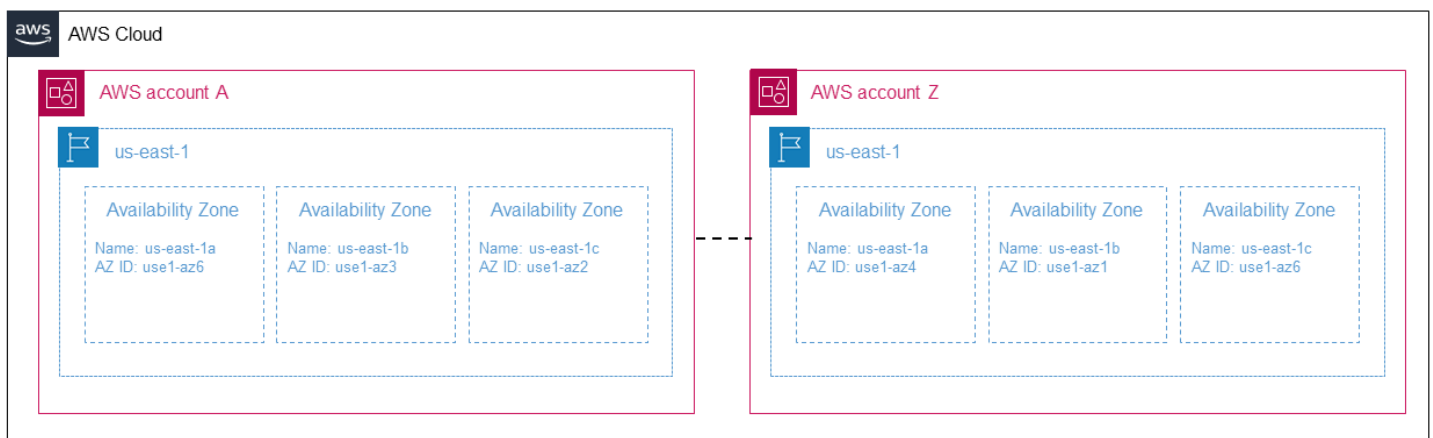

This pattern helps ensure zonal consistency by providing a cross-account, scalable solution for using the same Availability Zones in your subnets. Zonal consistency ensures that your cross-account network traffic avoids cross-Availability Zone network paths, which helps reduce data transfer costs and lower network latency between your workloads.

This pattern is an alternative approach to the AWS CloudFormation [AvailabilityZoneId property](#).

## Prerequisites and limitations

### Prerequisites

- At least two active AWS accounts in the same AWS Region.
- Evaluate how many Availability Zones are needed to support your VPC requirements in the Region.
- Identify and record the AZ ID for each Availability Zone that you need to support. For more information about this, see [Availability Zone IDs for your AWS resources](#) in the AWS Resource Access Manager documentation.
- An ordered, comma-separated list of your AZ IDs. For example, the first Availability Zone on your list is mapped as az1, the second Availability Zone is mapped as az2, and this mapping structure continues until your comma-separated list is fully mapped. There is no maximum number of AZ IDs that can be mapped.
- The az-mapping.yaml file from the GitHub [Multi-account Availability Zone mapping](#) repository, copied to your local machine

## Architecture

The following diagram shows the architecture that is deployed in an account and that creates AWS Systems Manager Parameter Store values. These Parameter Store values are consumed when you create a VPC in the account.

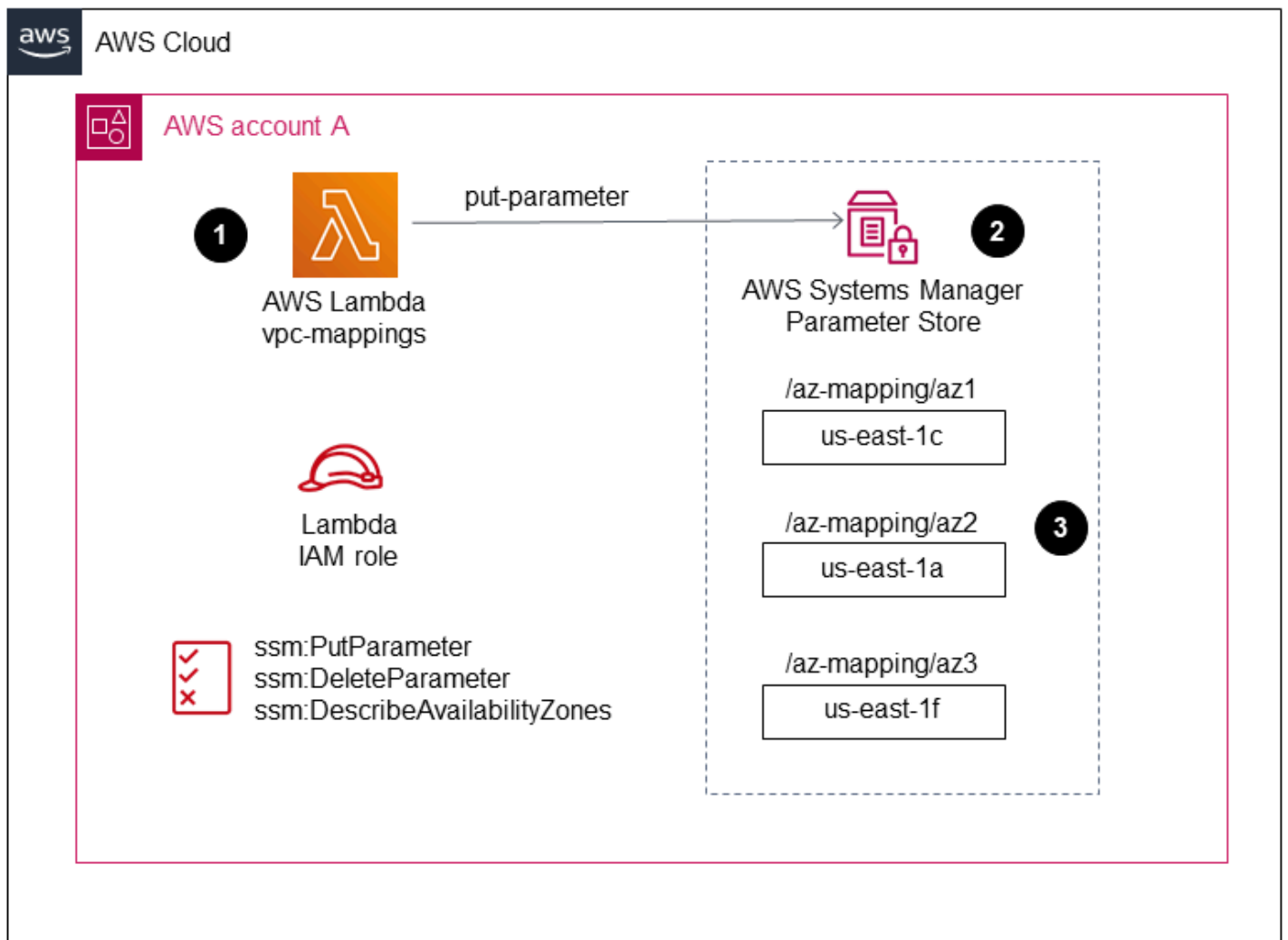

The diagram shows the following workflow:

1. This pattern's solution is deployed to all accounts that require zonal consistency for a VPC.
2. The solution creates Parameter Store values for each AZ ID and stores the new Availability Zone name.
3. The AWS CloudFormation template uses the Availability Zone name stored in each Parameter Store value and this ensures zonal consistency.

The following diagram shows the workflow for creating a VPC with this pattern's solution.



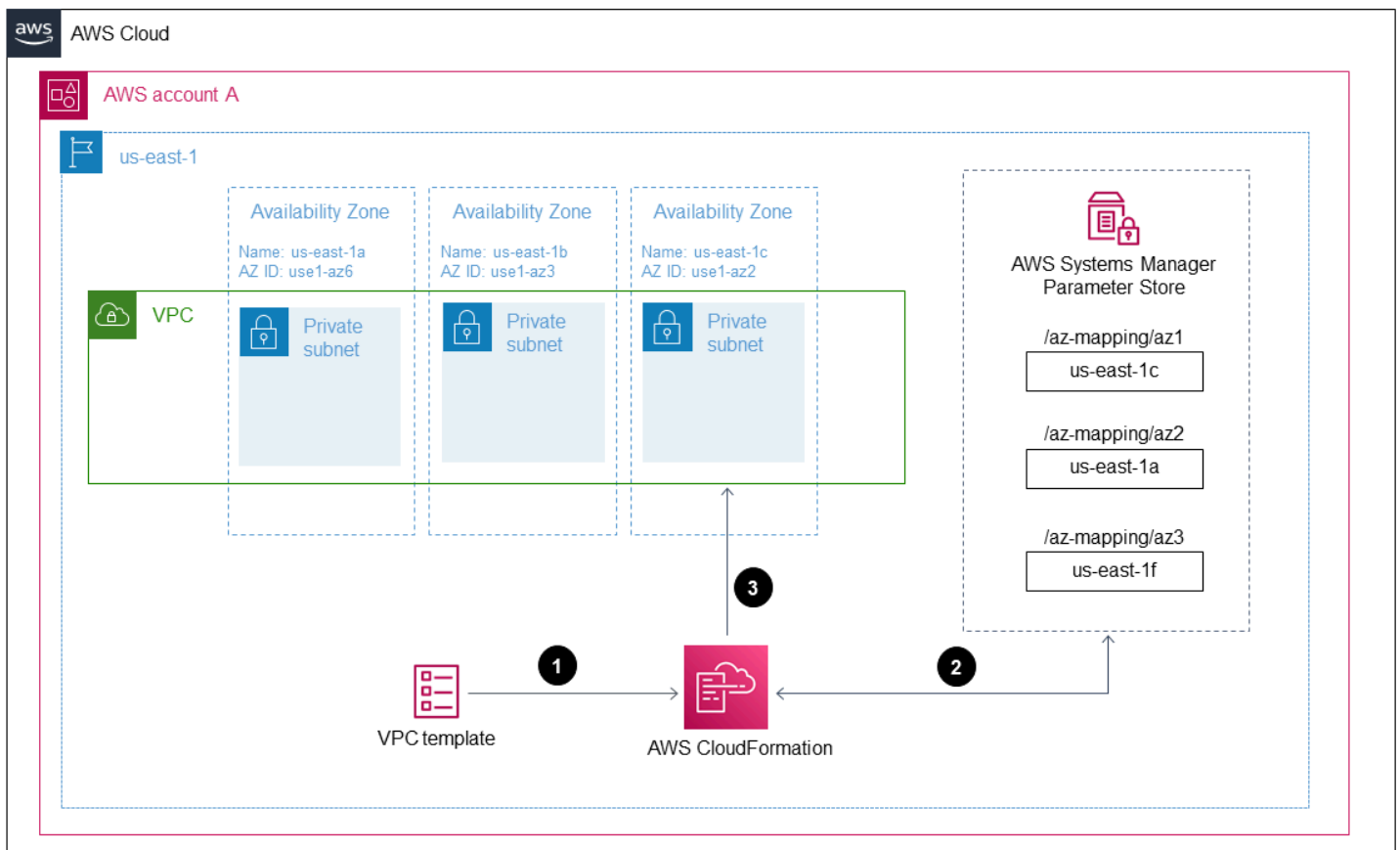

The diagram shows the following workflow:

1. Submit a template for creating a VPC to AWS CloudFormation.
2. AWS CloudFormation resolves the Parameter Store values for each Availability Zone and returns the Availability Zone name for each AZ ID.
3. A VPC is created with the correct AZ IDs required for zonal consistency.

After you deploy this pattern's solution, you can create subnets that reference the Parameter Store values. If you use AWS CloudFormation, you can reference the Availability Zone mapping parameter values from the following YAML-formatted sample code:

```
Resources:
  PrivateSubnet1AZ1:
    Type: AWS::EC2::Subnet
    Properties:
      VpcId: !Ref VPC
      CidrBlock: !Ref PrivateSubnetAZ1CIDR
      AvailabilityZone:
```

```
!Join
- ''
- - '{{resolve:ssm:/az-mapping/az1:1}}'
```

This sample code is contained in the `vpc-example.yaml` file from the GitHub [Multi-account Availability Zone mapping](#) repository. It shows you how to create a VPC and subnets that align to the Parameter Store values for zonal consistency.

## Technology stack

- AWS CloudFormation
- AWS Lambda
- AWS Systems Manager Parameter Store

## Automation and scale

You can deploy this pattern to all your AWS accounts by using AWS CloudFormation StackSets or the Customizations for AWS Control Tower solution. For more information, see [Working with AWS CloudFormation StackSets](#) in the AWS CloudFormation documentation and [Customizations for AWS Control Tower](#) in the AWS Solutions Library.

After you deploy the AWS CloudFormation template, you can update it to use the Parameter Store values and deploy your VPCs in pipelines or according to your requirements.

## Tools

### AWS services

- [AWS CloudFormation](#) helps you model and set up your AWS resources, provision them quickly and consistently, and manage them throughout their lifecycle. You can use a template to describe your resources and their dependencies, and launch and configure them together as a stack, instead of managing resources individually. You can manage and provision stacks across multiple AWS accounts and AWS Regions.
- [AWS Lambda](#) is a compute service that supports running code without provisioning or managing servers. Lambda runs your code only when needed and scales automatically, from a few requests per day to thousands per second. You pay only for the compute time that you consume—there is no charge when your code is not running.

- [AWS Systems Manager Parameter Store](#) is a capability of AWS Systems Manager. It provides secure, hierarchical storage for configuration data management and secrets management.

## Code

The code for this pattern is provided in the GitHub [Multi-account Availability Zone mapping](#) repository.

## Epics

### Deploy the az-mapping.yaml file

Task	Description	Skills required
Determine the required Availability Zones for the Region.	<ol style="list-style-type: none"><li>1. Determine the AZ IDs that must be consistently used in your Region.</li><li>2. Record these AZ IDs in a comma-separated list and in the order that you want them applied in. For example, the first Availability Zone on your list is mapped as az1 and the second is mapped as az2. There is no maximum number of AZ IDs that can be mapped.</li></ol>	Cloud architect
Deploy the az-mapping.yaml file.	Use the az-mapping.yaml file to create an AWS CloudFormation stack in all required AWS accounts. In the AZIDs parameter, use the comma-separated list that you created earlier.	Cloud architect

Task	Description	Skills required
	We recommend that you use <a href="#">AWS CloudFormation StackSets</a> or the <a href="#">Customizations for AWS Control Tower Solution</a> .	

## Deploy the VPCs in your accounts

Task	Description	Skills required
Customize the AWS CloudFormation templates.	<p>When you create the subnets using AWS CloudFormation, customize the templates to use the Parameter Store values that you created earlier.</p> <p>For a sample template, see the <code>vpc-example.yaml</code> file in the GitHub <a href="#">Multi-account Availability Zone mapping</a> repository.</p>	Cloud architect
Deploy the VPCs.	Deploy the customized AWS CloudFormation templates into your accounts. Each VPC in the Region then has zonal consistency in the Availability Zones used for the subnets	Cloud architect

## Related resources

- [Availability Zone IDs for your AWS resources](#) (AWS Resource Access Manager documentation)
- [AWS::EC2::Subnet](#) (AWS CloudFormation documentation)



# Validate Account Factory for Terraform (AFT) code locally

Created by Alexandru Pop (AWS) and Michal Gorniak (AWS)

**Environment:** Production

**Technologies:** Infrastructure; DevOps; Modernization; DevelopmentAndTesting

**Workload:** Open-source

**AWS services:** AWS Control Tower

## Summary

This pattern shows how to locally test HashiCorp Terraform code that's managed by AWS Control Tower Account Factory for Terraform (AFT). Terraform is an open-source infrastructure as code (IaC) tool that helps you use code to provision and manage cloud infrastructure and resources. AFT sets up a Terraform pipeline that helps you provision and customize multiple AWS accounts in AWS Control Tower.

During code development, it can be helpful to test your Terraform infrastructure as code (IaC) locally, outside of the AFT pipeline. This pattern shows how to do the following:

- Retrieve a local copy of the Terraform code that's stored in the AWS CodeCommit repositories in your AFT management account.
- Simulate the AFT pipeline locally by using the retrieved code.

This procedure can also be used to run Terraform commands that aren't part of the normal AFT pipeline. For example, you can use this method to run commands such as `terraform validate`, `terraform plan`, `terraform destroy`, and `terraform import`.

## Prerequisites and limitations

### Prerequisites

- An active AWS multi-account environment that uses [AWS Control Tower](#)
- A fully deployed of [AFT environment](#)

- AWS Command Line Interface (AWS CLI), [installed](#) and [configured](#)
- [AWS CLI credential helper for Code Commit](#), installed and configured
- Python 3.x
- [Git](#), installed and configured on your local machine
- git-remote-commit utility, [installed and configured](#)
- [Terraform](#), installed and configured (the local Terraform package version must match the version that's used in the AFT deployment)

## Limitations

- This pattern doesn't cover the deployment steps required for AWS Control Tower, AFT, or any specific Terraform modules.
- The output that's generated locally during this procedure isn't saved in the AFT pipeline runtime logs.

## Architecture

### Target technology stack

- AFT infrastructure deployed within an AWS Control Tower deployment
- Terraform
- Git
- AWS CLI version 2

### Automation and scale

This pattern shows how to locally invoke Terraform code for AFT global account customizations in a single AFT-managed AWS account. After your Terraform code is validated, you can apply it to the remaining accounts in your multi-account environment. For more information, see [Re-invoke customizations](#) in the AWS Control Tower documentation.

You can also use a similar process to run AFT account customizations in a local terminal. To locally invoke Terraform code from AFT account customizations, clone the **aft-account-customizations repository** instead of **aft-global-account-customizations** repository from CodeCommit in your AFT management account.

## Tools

### AWS services

- [AWS Control Tower](#) helps you set up and govern an AWS multi-account environment, following prescriptive best practices.
- [AWS Command Line Interface \(AWS CLI\)](#) is an open-source tool that helps you interact with AWS services through commands in your command-line shell.

### Other services

- [HashiCorp Terraform](#) is an open-source infrastructure as code (IaC) tool that helps you use code to provision and manage cloud infrastructure and resources.
- [Git](#) is an open-source, distributed version control system.

### Code

The following is an example bash script that can be used to locally run Terraform code that's managed by AFT. To use the script, follow the instructions in the *Epics* section of this pattern.

```
#!/bin/bash
# Version: 1.1 2022-06-24 Unsetting AWS_PROFILE since, when set, it interferes with
# script operation
#           1.0 2022-02-02 Initial Version
#
# Purpose: For use with AFT: This script runs the local copy of TF code as if it were
# running within AFT pipeline.
#           * Facilitates testing of what the AFT pipeline will do
#           * Provides the ability to run terraform with custom arguments (like 'plan'
# or 'move') which are currently not supported within the pipeline.
#
# © 2021 Amazon Web Services, Inc. or its affiliates. All Rights Reserved.
# This AWS Content is provided subject to the terms of the AWS Customer Agreement
# available at http://aws.amazon.com/agreement or other written agreement between
# Customer and either Amazon Web Services, Inc. or Amazon Web Services EMEA SARL or
# both.
#
# Note: Arguments to this script are passed directly to 'terraform' without parsing nor
# validation by this script.
#
```



```

# Prerequisites:
# 1. local copy of ct GIT repositories
# 2. local backend.tf and aft-providers.tf filled with data for the target account
#    on which terraform is to be run
#    Hint: The contents of above files can be obtain from the logs of a previous
#    execution of the AFT pipeline for the target account.
# 3. 'terraform' binary is available in local PATH
# 4. Recommended: .gitignore file containing 'backend.tf', 'aft_providers.tf' so the
#    local copy of these files are not pushed back to git

readonly credentials=$(aws sts assume-role \
  --role-arn arn:aws:iam::$(aws sts get-caller-identity --query "Account" --output
  text ):role/AWSAFTAdmin \
  --role-session-name AWSAFT-Session \
  --query Credentials )

unset AWS_PROFILE
export AWS_ACCESS_KEY_ID=$(echo $credentials | jq -r '.AccessKeyId')
export AWS_SECRET_ACCESS_KEY=$(echo $credentials | jq -r '.SecretAccessKey')
export AWS_SESSION_TOKEN=$(echo $credentials | jq -r '.SessionToken')
terraform "$@"

```

## Epics

### Save the example code as a local file

Task	Description	Skills required
Save the example code as a local file.	<ol style="list-style-type: none"> <li>Copy the example bash script that's in the <i>Code</i> section of this pattern and paste it into a code editor.</li> <li>Name the file <code>ct_terraform.sh</code> . Then, save the file locally inside a dedicated folder, such as <code>~/scripts</code> or <code>~/bin</code>.</li> </ol>	AWS administrator
Make the example code runnable.	Open a terminal window and authenticate into your AWS	AWS administrator

Task	Description	Skills required
	<p>AFT management account by doing one of the following:</p> <ul style="list-style-type: none"><li>• Use an existing <a href="#">AWS CLI profile</a> that's configured with the permissions required to access the AFT management account. To use the profile, you can run the following command:</li></ul> <pre data-bbox="594 737 1027 852">export AWS_PROFILE=&lt;aft account profile name&gt;</pre> <ul style="list-style-type: none"><li>• If your organization uses SSO to access AWS, enter the credentials for your AFT management account on your organization's SSO page.</li></ul> <p><b>Note:</b> Your organization might also have a custom tool to provide authentication credentials to your AWS environment.</p>	

Task	Description	Skills required
Verify access to AFT management account in the correct AWS Region.	<p><b>Important:</b> Make sure that you use the same terminal session that you authenticated into your AFT management account with.</p> <ol style="list-style-type: none"><li>1. Navigate to your AFT deployment's AWS Region by running the following command: <pre>export AWS_REGION=&lt;aft_region&gt;</pre></li><li>2. Make sure that you're in the correct account by doing the following:<ul style="list-style-type: none"><li>• Run the following command: <pre>aws code-commit list-repositories</pre></li><li>• Then, verify that the repositories listed in the output match the names of the repositories that are in your AFT management account.</li></ul></li></ol>	AWS administrator
Create a new, local directory to store the AFT repository code.	<p>In the same terminal session, run the following commands:</p> <pre>mkdir my_aft cd my_aft</pre>	AWS administrator

Task	Description	Skills required
Clone the remote AFT repository code.	<p>1. In your local terminal, run the following command:</p> <pre data-bbox="630 344 1029 543">git clone codecommit:::\$AWS_REGION://aft-global-customizations</pre> <p><b>Note:</b> For simplicity, this procedure and AFT use a main code branch only. To use code branching, you can enter code branching commands here as well. However, any applied changes from the non-main branch will be rolled back when AFT automation applies code from the main branch.</p> <p>2. Then, navigate into the cloned directory by running the following command:</p> <pre data-bbox="630 1377 1029 1499">cd aft-global-customizations/terraform</pre>	AWS administrator

### Create the Terraform configuration files required for the AFT pipeline to run locally

Task	Description	Skills required
Open a previously run AFT pipeline and copy the	<b>Note:</b> The <b>backend.tf</b> and <b>aft-providers.tf</b> configuration	AWS administrator

Task	Description	Skills required
Terraform configuration files to a local folder.	<p>files that are created in this epic are needed for the AFT pipeline to run locally. These files are created automatically within the cloud-based AFT pipeline, but must be created manually for the pipeline to run locally. Running the AFT pipeline locally requires one set of files that represents running the pipeline within a single AWS account.</p> <ol style="list-style-type: none"><li>1. Using your AWS Control Tower management account credentials, sign in to the AWS Management Console. Then open the <a href="#">AWS CodePipeline console</a>. Make sure that you're in the same AWS Region where you deployed AFT.</li><li>2. In the left navigation pane, choose <b>Pipelines</b>.</li><li>3. Choose <b>#####-customizations-pipeline</b>. (The <b>#####</b> is the AWS account ID that you're using to run Terraform code locally).</li><li>4. Make sure that <b>Most Recent Execution Marked</b> shows a <b>Succeeded</b> value. If it the value is different</li></ol>	

Task	Description	Skills required
	<p>, you must re-invoke your customizations in the AFT pipeline. For more information, see <a href="#">Re-invoke customizations</a> in the AWS Control Tower documentation.</p> <ol style="list-style-type: none"> <li>5. Choose the most recent runtime to bring up its details.</li> <li>6. In the <b>Apply-AFT-Global-Customizations</b> section, find the <b>Apply-Terraform</b> stage.</li> <li>7. Select the <b>Details</b> section of the <b>Apply-Terraform</b> stage.</li> <li>8. Find the runtime log for the <b>Apply-Terraform</b> stage.</li> <li>9. In the runtime log, look for the section that begins and ends with the following lines: <code>"\n\n aft-providers.tf ... "\n \n backend.tf"</code></li> <li>10. Copy the output between these two labels and save them as a local file named <code>aft-providers.tf</code> within the local Terraform folder (your terminal session's current working directory).</li> </ol>	

Task	Description	Skills required
	<p><b>Example auto generated providers.tf statement</b></p> <pre data-bbox="630 327 1029 1205">## Autogenerated providers.tf ## ## Updated on: 2022-05-31 16:27:45 ## provider "aws" {   region = "us-east-2"   assume_role {     role_arn = "arn:aws:iam::#### #####:role/AWSA FTExecution"   }   default_tags {     tags = {       managed_by         = "AFT"     }   } }</pre>	

11 In the runtime log, look for the section that begins and ends with the following lines: `"\n\n tf ... "\n\n backup.tf"`

12 Copy the output between these two labels and save them as a local file named `tf` within the local Terraform folder (your terminal session's current working directory).

Task	Description	Skills required
	<p><b>Example autogenerated backend.tf statement</b></p> <pre data-bbox="592 331 1029 1793"> ## Autogenerated backend.tf ## ## Updated on: 2022-05-3 1 16:27:45 ## terraform {   required_version = "&gt;= 0.15.0"   backend "s3" {     region          = "us-east-2"     bucket          = "aft-backend-##### #####-primary-re gion"     key             = "#####-aft- global-customizati ons/terraform.tfst ate"     dynamodb_table = "aft-backend-##### #####"     encrypt         = "true"     kms_key_id      = "cbdc21d6-e04d-4c3 7-854f-51e199cfcb7c"     kms_key_id      = "#####-####-####- ####-#####"     role_arn        = "arn:aws:iam::#### #####:role/AWS AFTEExecution"   } } </pre>	



Task	Description	Skills required
	<p><b>Note:</b> The <code>backend.tf</code> and <code>aft-providers.tf</code> files are tied to a specific AWS account, AFT deployment, and folder. These files are also different, depending on if they're in the <b>aft-global-customizations</b> repository and <b>aft-account-customizations</b> repository within the same AFT deployment. Make sure that you generate both files from the same runtime listing.</p>	

### Run the AFT pipeline locally by using the example bash script

Task	Description	Skills required
Implement the Terraform configuration changes that you want to validate.	<ol style="list-style-type: none"> <li>Navigate to the cloned <b>aft-global-customizations</b> repository by running the following command: <div data-bbox="630 1375 1031 1497" style="border: 1px solid #ccc; border-radius: 10px; padding: 10px; margin: 10px 0;"> <pre>cd aft-global-customizations/terraform</pre> </div> <p><b>Note:</b> The files <code>backend.tf</code> and <code>aft-providers.tf</code> are in this directory. The directory also contains Terraform files from the <b>aft-global-customizations</b> repository.</p> </li> </ol>	AWS administrator

Task	Description	Skills required
	2. Incorporate the Terraform code changes that you want to test locally into the configuration files.	

Task	Description	Skills required
Run the <code>ct_terraform.sh</code> script and review the output.	<ol style="list-style-type: none"><li>1. Navigate to the local folder that contains the <code>sh</code> script.</li><li>2. To validate your modified Terraform code, run the <code>ct_terraform.sh</code> script by running the following command: <pre>~/scripts/ct_terraform.sh apply</pre><p><b>Note:</b> you can run any Terraform command during this step. To see a complete list of Terraform commands, run the following command: <pre>terraform --help</pre></p></li><li>3. Review the command output. Then, debug the code changes locally before committing and pushing the changes back to the AFT repository.</li></ol> <p><b>Important:</b></p> <ul style="list-style-type: none"><li>• Any changes made locally and not pushed back to the remote repository are temporary and may be undone at any time by</li></ul>	AWS administrator

Task	Description	Skills required
	<p>a running AFT pipeline automation.</p> <ul style="list-style-type: none"> <li>AFT automation can run at any time, because it can be invoked by other users and AFT automation triggers.</li> <li>AFT will always apply code from the main branch of the repository, undoing any uncommitted changes.</li> </ul>	

### Commit and push your local code changes back to the AFT repository

Task	Description	Skills required
Add references to the backend.tf and aft-providers.tf files to a .gitignore file.	<p>Add the backend.tf and aft-providers.tf files that you created to a .gitignore file by running the following commands:</p> <pre>echo backend.tf &gt;&gt; .gitignore echo aft-providers.tf &gt;&gt;.gitignore</pre> <p><b>Note:</b> Moving the files to the .gitignore file ensures that they don't get committed and pushed back to the remote AFT repository.</p>	AWS administrator
Commit and push your code changes to the remote AFT repository.	<ol style="list-style-type: none"> <li>To add any new Terraform configuration files to</li> </ol>	AWS administrator

Task	Description	Skills required
	<p>the repository, run the following command:</p> <pre data-bbox="634 331 1027 411">git add &lt;filename&gt;</pre> <p>2. To commit your changes and push them to the remote AFT repository in AWS CodeCommit, run the following commands:</p> <pre data-bbox="634 688 1027 810">git commit -a git push</pre> <p><b>Important:</b> The code changes that you introduce by following this procedure up until this point are applied to one AWS account only.</p>	

## Roll-out the changes to multiple accounts managed by AFT

Task	Description	Skills required
Roll out the changes to all of your accounts managed by AFT.	To roll out the changes to multiple AWS accounts managed by AFT, follow the instructions in <a href="#">Re-invoke customizations</a> in the AWS Control Tower documentation.	AWS administrator

## More patterns

- [Add HA to Oracle PeopleSoft on Amazon RDS Custom by using a read replica](#)
- [Automate adding or updating Windows registry entries using AWS Systems Manager](#)
- [Automate AWS resource assessment](#)
- [Automate AWS Service Catalog portfolio and product deployment by using AWS CDK](#)
- [Automate cross-Region failover and failback by using DR Orchestrator Framework](#)
- [Automate RabbitMQ configuration in Amazon MQ](#)
- [Automate the replication of Amazon RDS instances across AWS accounts](#)
- [Automatically attach an AWS managed policy for Systems Manager to EC2 instance profiles using Cloud Custodian and AWS CDK](#)
- [Automatically build CI/CD pipelines and Amazon ECS clusters for microservices using AWS CDK](#)
- [Automatically detect changes and initiate different CodePipeline pipelines for a monorepo in CodeCommit](#)
- [Automatically re-enable AWS CloudTrail by using a custom remediation rule in AWS Config](#)
- [Build a data pipeline to ingest, transform, and analyze Google Analytics data using the AWS DataOps Development Kit](#)
- [Build a Micro Focus Enterprise Server PAC with Amazon EC2 Auto Scaling and Systems Manager](#)
- [Build and push Docker images to Amazon ECR using GitHub Actions and Terraform](#)
- [Centralize IAM access key management in AWS Organizations by using Terraform](#)
- [Centralize software package distribution in AWS Organizations by using Terraform](#)
- [Chain AWS services together using a serverless approach](#)
- [Configure a data center extension to VMware Cloud on AWS using Hybrid Linked Mode](#)
- [Configure read-only routing in an Always On availability group in SQL Server on AWS](#)
- [Configure VMware vRealize Automation to provision VMs on VMware Cloud on AWS](#)
- [Create a cross-account Amazon EventBridge connection in an organization](#)
- [Create dynamic CI pipelines for Java and Python projects automatically](#)
- [Deploy a VMware SDDC on AWS by using VMware Cloud on AWS](#)
- [Deploy an Amazon API Gateway API on an internal website using private endpoints and an Application Load Balancer](#)
- [Deploy and debug Amazon EKS clusters](#)

- [Deploy and manage AWS Control Tower controls by using AWS CDK and AWS CloudFormation](#)
- [Deploy and manage AWS Control Tower controls by using Terraform](#)
- [Deploy CloudWatch Synthetics canaries by using Terraform](#)
- [Deploy a Lustre file system for high-performance data processing by using Terraform and DRA](#)
- [Deploy resources in an AWS Wavelength Zone by using Terraform](#)
- [Deploy the Security Automations for AWS WAF solution by using Terraform](#)
- [Detect Amazon RDS and Aurora database instances that have expiring CA certificates](#)
- [Document your AWS landing zone design](#)
- [Ensure that an IAM profile is associated with an EC2 instance](#)
- [Export AWS Backup reports from across an organization in AWS Organizations as a CSV file](#)
- [Generate personalized and re-ranked recommendations using Amazon Personalize](#)
- [Identify and alert when Amazon Data Firehose resources are not encrypted with an AWS KMS key](#)
- [Implement Account Factory for Terraform \(AFT\) by using a bootstrap pipeline](#)
- [Install SSM Agent on Amazon EKS worker nodes by using Kubernetes DaemonSet](#)
- [Install the SSM Agent and CloudWatch agent on Amazon EKS worker nodes using preBootstrapCommands](#)
- [Integrate VMware vRealize Network Insight with VMware Cloud on AWS](#)
- [Manage AWS Service Catalog products in multiple AWS accounts and AWS Regions](#)
- [Manage on-premises container applications by setting up Amazon ECS Anywhere with the AWS CDK](#)
- [Migrate DNS records in bulk to an Amazon Route 53 private hosted zone](#)
- [Migrate Oracle E-Business Suite to Amazon RDS Custom](#)
- [Migrate Oracle PeopleSoft to Amazon RDS Custom](#)
- [Migrate RHEL BYOL systems to AWS License-Included instances by using AWS MGN](#)
- [Migrate VMware SDDC to VMware Cloud on AWS using VMware HCX](#)
- [Set up a minimum viable data space to share data between organizations](#)
- [Monitor Amazon ElastiCache clusters for at-rest encryption](#)
- [Monitor ElastiCache clusters for security groups](#)
- [Monitor SAP RHEL Pacemaker clusters by using AWS services](#)
- [Privately access a central AWS service endpoint from multiple VPCs](#)

- [Remove Amazon EC2 entries in the same AWS account from AWS Managed Microsoft AD by using AWS Lambda automation](#)
- [Rotate database credentials without restarting containers](#)
- [Send a notification when an IAM user is created](#)
- [Send logs from VMware Cloud on AWS to Splunk by using VMware Aria Operations for Logs](#)
- [Set up a CI/CD pipeline for hybrid workloads on Amazon ECS Anywhere by using AWS CDK and GitLab](#)
- [Set up a highly available PeopleSoft architecture on AWS](#)
- [Set up an auto scaling virtual desktop infrastructure \(VDI\) by using NICE EnginFrame and NICE DCV Session Manager](#)
- [Set up an HA/DR architecture for Oracle E-Business Suite on Amazon RDS Custom with an active standby database](#)
- [Set up AWS CloudFormation drift detection in a multi-Region, multi-account organization](#)
- [Set up Multi-AZ infrastructure for a SQL Server Always On FCI by using Amazon FSx](#)
- [Set up Oracle UTL\\_FILE functionality on Aurora PostgreSQL-Compatible](#)
- [Simplify private certificate management by using AWS Private CA and AWS RAM](#)
- [Tag Transit Gateway attachments automatically using AWS Organizations](#)
- [Transition roles for an Oracle PeopleSoft application on Amazon RDS Custom for Oracle](#)
- [Use Serverspec for test-driven development of infrastructure code](#)



# IoT

## Topics

- [Configure logging and monitoring for security events in your AWS IoT environment](#)
- [Extract and query AWS IoT SiteWise metadata attributes in a data lake](#)
- [Set up and troubleshoot AWS IoT Greengrass with client devices](#)
- [More patterns](#)

# Configure logging and monitoring for security events in your AWS IoT environment

Created by Prateek Prakash (AWS)

<b>Environment:</b> Production	<b>Technologies:</b> IoT; Security, identity, compliance; Operations	<b>Workload:</b> All other workloads
<b>AWS services:</b> Amazon CloudWatch; Amazon OpenSearch Service; Amazon GuardDuty; AWS IoT Core; AWS IoT Device Defender; AWS IoT Device Management; Amazon CloudWatch Logs		

## Summary

Ensuring that your Internet of Things (IoT) environments are secure is an important priority, particularly because organizations are connecting billions of devices to their IT environments. This pattern provides a reference architecture that you can use to implement logging and monitoring for security events across your IoT environment on the Amazon Web Services (AWS) Cloud. Typically, an IoT environment on the AWS Cloud has the following three layers:

- IoT devices that generate relevant telemetry data.
- AWS IoT services (for example, [AWS IoT Core](#), [AWS IoT Device Management](#), or [AWS IoT Device Defender](#)) that connect your IoT devices to other devices and AWS services.
- Backend AWS services that help process telemetry data and provide useful insights for your different business use cases.

The best practices provided by the [AWS IoT Lens - AWS Well-Architected Framework](#) whitepaper can help you review and improve your cloud-based architecture and better understand the business impact of your design decisions. An important recommendation is that you analyze

application logs and metrics on your devices and in the AWS Cloud. You can achieve this by leveraging different approaches and techniques (for example, [threat modeling](#)) to identify metrics and events that must be monitored to detect potential security issues.

This pattern describes how to use AWS IoT and security services to design and implement a security logging and monitoring reference architecture for an IoT environment on the AWS Cloud. This architecture builds on existing AWS security best practices and applies them to your IoT environment.

## Prerequisites and limitations

### Prerequisites

- An existing landing zone environment. For more information about this, see the guide [Setting up a secure and scalable multi-account AWS environment](#) on the AWS Prescriptive Guidance website.
- The following accounts must be available in your landing zone:
  - **Log Archive account** – This account is for users that need to access the logging information for accounts in your landing zone’s organizational units (OUs). For more information about this, see the [Security OU – Log Archive account](#) section of the guide [AWS Security Reference Architecture](#) on the AWS Prescriptive Guidance website.
  - **Security account** – Your security and compliance teams use this account for auditing or to perform emergency security operations. This account is also designated as the administrator account for Amazon GuardDuty. Users from the administrator account can configure GuardDuty, in addition to viewing and managing GuardDuty findings for their own account and all member accounts. For more information about this, see [Managing multiple accounts in GuardDuty](#) in the Amazon GuardDuty documentation.
  - **IoT account** – This account is for your IoT environment.

## Architecture

This pattern extends the [Centralized Logging solution](#) from the AWS Solutions Library to collect and process security-related IoT events. The Centralized Logging solution is deployed in the Security account and helps collect, analyze, and display Amazon CloudWatch logs in a single dashboard. This solution consolidates, manages, and analyzes log files from multiple sources. Finally, the Centralized Logging solution also uses Amazon OpenSearch Service and OpenSearch Dashboards to show a unified view of all log events.

The following architecture diagram shows the key components of an IoT security logging and reference architecture on the AWS Cloud.

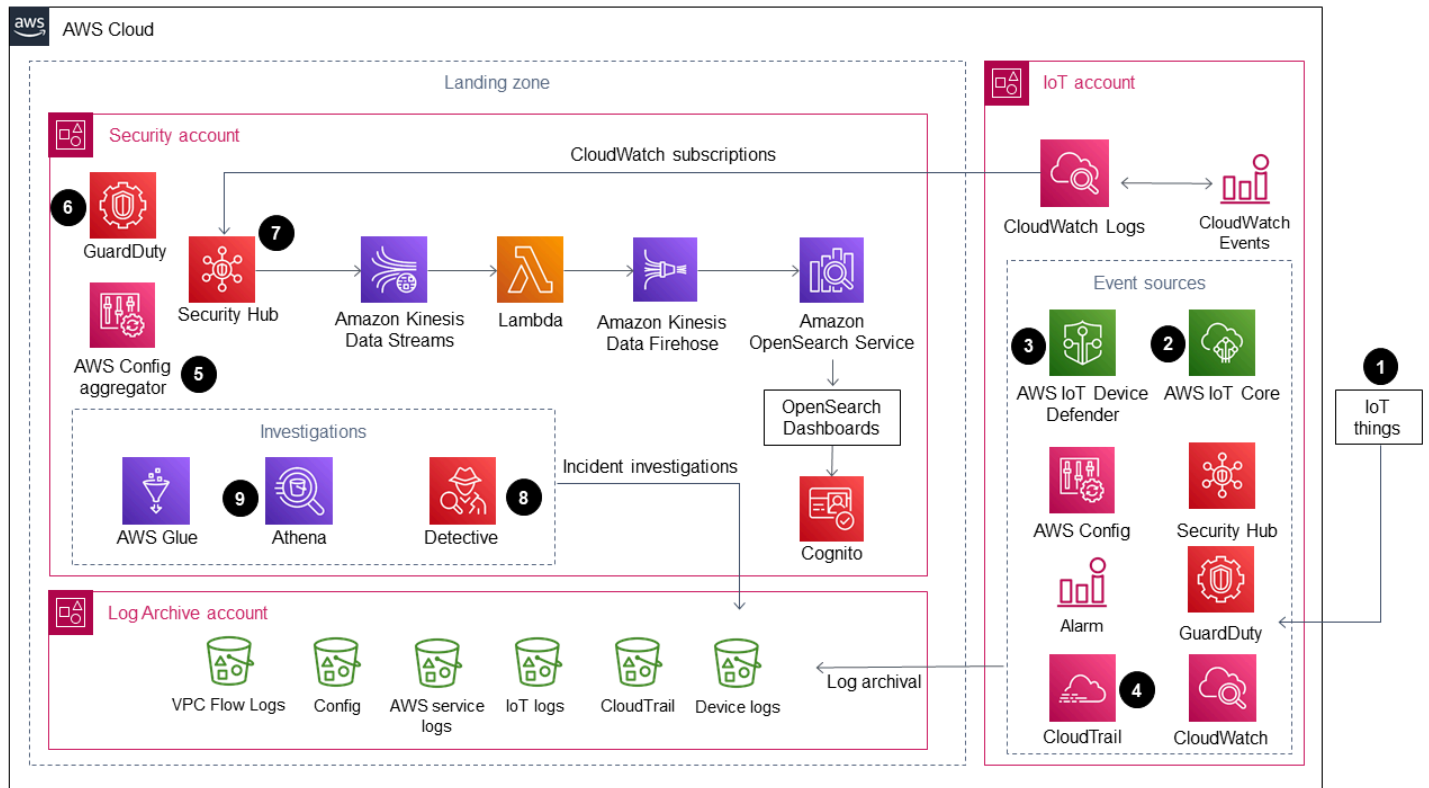

The diagram shows the following workflow:

- IoT things are the devices that must be monitored for anomalous security events. These devices run an agent to publish security events or metrics to AWS IoT Core and AWS IoT Device Defender.
- When AWS IoT logging is enabled, AWS IoT sends progress events about each message as it passes from your devices through the message broker and rules engine to Amazon CloudWatch Logs. You can use CloudWatch Logs subscriptions to push events to a [Centralized Logging solution](#). For more information about this, see [AWS IoT metrics and dimensions](#) in the AWS IoT Core documentation.
- AWS IoT Device Defender helps monitor insecure configurations and security metrics for your IoT devices. When an anomaly is detected, alarms notify Amazon Simple Notification Service (Amazon SNS), which has an AWS Lambda function as a subscriber. The Lambda function sends the alarm as a message to CloudWatch Logs. You can use CloudWatch Logs subscriptions to push events to your Centralized Logging solution. For more information about this, see [Audit checks](#), [Device-side metrics](#), and [Cloud-side metrics](#) in the AWS IoT Core documentation.

4. AWS CloudTrail logs AWS IoT Core control plane actions that make changes (for example, creating, updating, or attaching APIs). When CloudTrail is set up as part of a landing zone implementation, it sends events to CloudWatch Logs and you can use subscriptions to push events to your Centralized Logging solution
5. AWS Config managed rules or custom rules evaluate resources that are part of your IoT environment. Monitor your [compliance change notifications](#) using CloudWatch Events with CloudWatch Logs as the target. After compliance change notifications are sent to CloudWatch Logs, you can use subscriptions to push events to your Centralized Logging solution.
6. Amazon GuardDuty continuously analyzes CloudTrail management events and helps identify API calls made to AWS IoT Core endpoints from known malicious IP addresses, unusual geolocations, or anonymizing proxies. Monitor GuardDuty notifications using Amazon CloudWatch Events with log groups in CloudWatch Logs as the target. When GuardDuty notifications are sent to CloudWatch Logs, you can use subscriptions to push events to your Centralized Monitoring solution or use the GuardDuty console in your Security account to view the notifications.
7. AWS Security Hub monitors your IoT account by using security best practices. Monitor Security Hub notifications by using CloudWatch Events with log groups in CloudWatch Logs as the target. When Security Hub notifications are sent to CloudWatch Logs, use subscriptions to push events to your Centralized Monitoring solution or use the Security Hub console in your Security account to view the notifications.
8. Amazon Detective evaluates and analyzes information to isolate the root cause and take action on security findings for unusual calls to AWS IoT endpoints or other services in your IoT architecture.
9. Amazon Athena queries logs stored in your Log Archive account to enhance your understanding of security findings and identify trends and malicious activities.

## Tools

- [Amazon Athena](#) is an interactive query service that makes it easy to analyze data directly in Amazon Simple Storage Service (Amazon S3) using standard SQL.
- [AWS CloudTrail](#) helps you enable governance, compliance, and operational and risk auditing of your AWS account.
- [Amazon CloudWatch](#) monitors your AWS resources and the applications you run on AWS in real time. You can use CloudWatch to collect and track metrics, which are variables you can measure for your resources and applications.

- [Amazon CloudWatch Logs](#) centralizes the logs from all your systems, applications, and AWS services that you use. You can view and monitor the logs, search them for specific error codes or patterns, filter them based on specific fields, or archive them securely for future analysis.
- [AWS Config](#) provides a detailed view of the configuration of AWS resources in your AWS account.
- [Amazon Detective](#) makes it easy to analyze, investigate, and quickly identify the root cause of security findings or suspicious activities.
- [AWS Glue](#) is a fully managed extract, transform, and load (ETL) service that makes it simple and cost-effective to categorize your data, clean it, enrich it, and move it reliably between various data stores and data streams.
- [Amazon GuardDuty](#) is a continuous security monitoring service.
- [AWS IoT Core](#) provides secure, bi-directional communication for Internet-connected devices (such as sensors, actuators, embedded devices, wireless devices, and smart appliances) to connect to the AWS Cloud over MQTT, HTTPS, and LoRaWAN.
- [AWS IoT Device Defender](#) is a security service that allows you to audit the configuration of your devices, monitor connected devices to detect abnormal behavior, and mitigate security risks.
- [Amazon OpenSearch Service](#) is a managed service that makes it easy to deploy, operate, and scale OpenSearch clusters in the AWS Cloud.
- [AWS Organizations](#) is an account management service that enables you to consolidate multiple AWS accounts into an organization that you create and centrally manage.
- [AWS Security Hub](#) provides you with a comprehensive view of your security state in AWS and helps you check your environment against security industry standards and best practices.
- [Amazon Virtual Private Cloud \(Amazon VPC\)](#) provisions a logically isolated section of the AWS Cloud where you can launch AWS resources in a virtual network that you've defined. This virtual network closely resembles a traditional network that you'd operate in your own data center, with the benefits of using the scalable infrastructure of AWS.

## Epics

### Set up an IoT account in your landing zone environment

Task	Description	Skills required
Validate the security guardrails in the IoT account.	Validate that the guardrails for CloudTrail, AWS Config,	AWS administrator

Task	Description	Skills required
	GuardDuty, and Security Hub are enabled in your IoT account.	
Validate that your IoT account is configured as a member account of your Security account.	<p>Validate that your IoT account is configured and associated as a member account for GuardDuty and Security Hub in your Security account.</p> <p>For more information about this, see <a href="#">Managing GuardDuty accounts with AWS Organizations</a> in the Amazon GuardDuty documentation and <a href="#">Managing administrator and member accounts</a> in the AWS Security Hub documentation.</p>	AWS administrator
Validate log archiving.	Validate that CloudTrail, AWS Config, and VPC Flow Logs are stored in the Log Archive account.	AWS administrator

## Set up the Centralized Logging solution

Task	Description	Skills required
Set up the Centralized Logging solution in your Security account.	Sign in to the AWS Management Console for your Security account and set up the <a href="#">Centralized Logging solution</a> from the AWS Solutions Library to	AWS administrator

Task	Description	Skills required
	<p>collect, analyze, and display CloudWatch Logs in Amazon OpenSearch Service and OpenSearch Dashboards.</p> <p>For more information about this, see <a href="#">Collect, analyze, and display Amazon CloudWatch Logs in a single dashboard with the Centralized Logging solution</a> from the Centralized Logging implementation guide in the AWS Solutions Library.</p>	

## Set up and configure AWS resources in your IoT account

Task	Description	Skills required
Set up AWS IoT logging.	<p>Sign in to the AWS Management Console for your IoT account. Set up and configure AWS IoT Core to send logs to CloudWatch Logs.</p> <p>For more information about this, see <a href="#">Configure AWS IoT logging</a> and <a href="#">Monitor AWS IoT using CloudWatch Logs</a> in the AWS IoT Core documentation.</p>	AWS administrator
Set up AWS IoT Device Defender.	Set up AWS IoT Device Defender to audit your	AWS administrator



Task	Description	Skills required
	<p>IoT resources and detect anomalies.</p> <p>For more information about this, see <a href="#">Getting started with AWS IoT Device Defender</a> in the AWS IoT Core documentation.</p>	
Set up CloudTrail.	<p>Set up CloudTrail to send events to CloudWatch Logs.</p> <p>For more information about this, see <a href="#">Sending events to CloudWatch Logs</a> in the AWS CloudTrail documentation.</p>	AWS administrator
Set up AWS Config and AWS Config rules.	<p>Set up AWS Config and the required AWS Config rules.</p> <p>For more information about this, see <a href="#">Setting up AWS Config with the console</a> and <a href="#">Setting up AWS Config rules with the console</a> in the AWS Config documentation.</p>	AWS administrator

Task	Description	Skills required
Set up GuardDuty.	<p>Set up and configure GuardDuty to send findings to Amazon CloudWatch Events with log groups in CloudWatch Logs as the target.</p> <p>For more information about this, see <a href="#">Creating custom responses to GuardDuty findings with Amazon CloudWatch Events</a> in the Amazon GuardDuty documentation.</p>	AWS administrator
Set up Security Hub.	<p>Set up Security Hub and enable the <a href="#">CIS AWS Foundations Benchmark</a> and <a href="#">AWS Foundational Security Best Practices</a> standards.</p> <p>For more information about this, see <a href="#">Automated response and remediation</a> in the AWS Security Hub documentation.</p>	AWS administrator
Set up Amazon Detective.	<p>Set up Detective to facilitate analysis of security findings</p> <p>For more information about this, see <a href="#">Setting up Amazon Detective</a> in the Amazon Detective documentation.</p>	AWS administrator

Task	Description	Skills required
Set up Amazon Athena and AWS Glue.	Set up Athena and AWS Glue to query the AWS service logs that conduct security incident investigations.  For more information about this, see <a href="#">Querying AWS service logs</a> in the Amazon Athena documentation.	AWS administrator

## Related resources

- [What is a landing zone?](#)

# Extract and query AWS IoT SiteWise metadata attributes in a data lake

*Created by Ambarish Dongaonkar (AWS)*

**Environment:** Production

**Technologies:** IoT; Analytics;  
Big data

**AWS services:** AWS IoT  
SiteWise; AWS Lambda; AWS  
Glue

## Summary

AWS IoT SiteWise uses asset models and hierarchies to represent your industrial equipment, processes, and facilities. Each model or asset can have multiple attributes that are specific to your environment. Example metadata attributes include the site or physical location of the asset, plant details, and equipment identifiers. These attribute values complement asset measurement data to maximize the business value. Machine learning (ML) can provide additional insights into this metadata and streamline engineering tasks.

However, metadata attributes can't be queried directly from the AWS IoT SiteWise service. To make the attributes queryable, you must extract and ingest them into a data lake. This pattern uses a Python script to extract the attributes for all AWS IoT SiteWise assets and ingest them into a data lake in an Amazon Simple Storage Service (Amazon S3) bucket. When you have completed this process, you can use SQL queries in Amazon Athena to access the AWS IoT SiteWise metadata attributes and other datasets, such as measurement datasets. The metadata attribute information is also useful when working with AWS IoT SiteWise monitors or dashboards. You can also build an AWS QuickSight dashboard by using the extracted attributes in the S3 bucket.

The pattern has reference code, and you can implement the code by using the best compute services for your use case, such as AWS Lambda or AWS Glue.

## Prerequisites and limitations

### Prerequisites

- An active AWS account.

- Permissions to set up AWS Lambda functions or AWS Glue jobs.
- An Amazon S3 bucket.
- The asset models and hierarchies are set up in AWS IoT SiteWise. For more information, see [Creating asset models](#) (AWS IoT SiteWise documentation).

## Architecture

You can use a Lambda function or an AWS Glue job to complete this process. We recommend using Lambda if you have less than 100 models and each model has an average of 15 or fewer attributes. For all other use cases, we recommend using AWS Glue.

The solution architecture and workflow are shown in the following diagram.

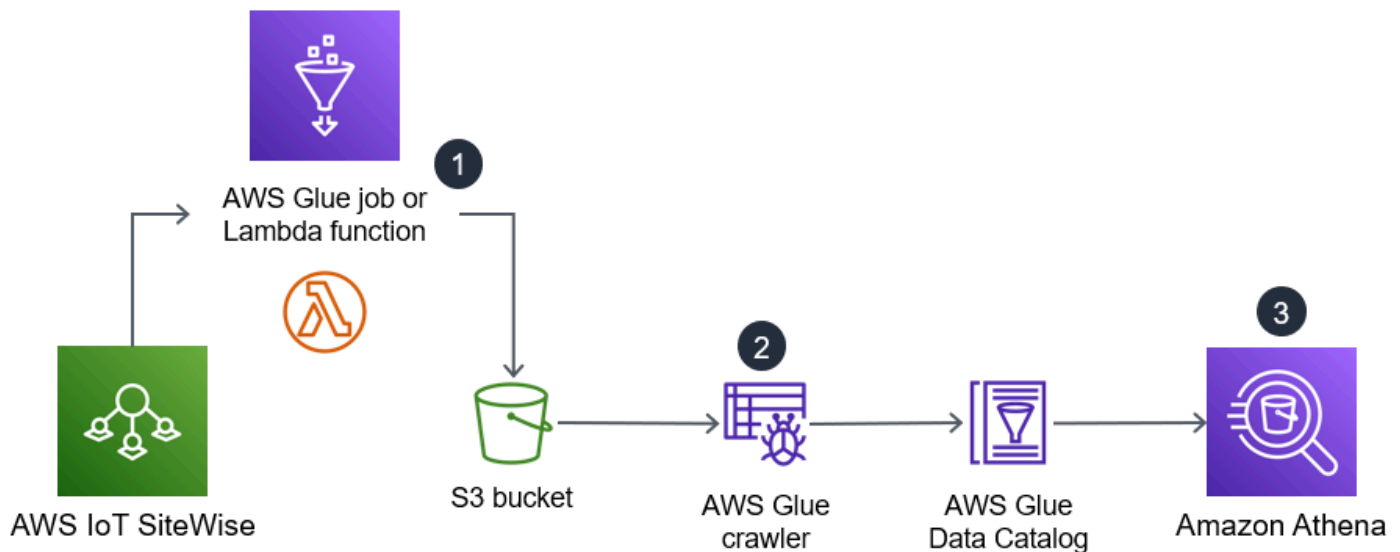

1. The scheduled AWS Glue job or Lambda function runs. It extracts the asset metadata attributes from AWS IoT SiteWise and ingests them into an S3 bucket.
2. An AWS Glue crawler crawls the extracted data in the S3 bucket and creates tables in an AWS Glue Data Catalog.
3. Using standard SQL, Amazon Athena queries the tables in the AWS Glue Data Catalog.

### Automation and scale

You can schedule the Lambda function or AWS Glue job to run daily or weekly, according to the update frequency of your AWS IoT SiteWise asset configurations.

There is no limit to the number of AWS IoT SiteWise assets that the sample code can process, but a large number of assets can increase the amount of time required to complete the process.

## Tools

- [Amazon Athena](#) is an interactive query service that helps you analyze data directly in Amazon Simple Storage Service (Amazon S3) by using standard SQL.
- [AWS Glue](#) is a fully managed extract, transform, and load (ETL) service. It helps you reliably categorize, clean, enrich, and move data between data stores and data streams.
- [AWS Identity and Access Management \(IAM\)](#) helps you securely manage access to your AWS resources by controlling who is authenticated and authorized to use them.
- [AWS IoT SiteWise](#) helps you collect, model, analyze, and visualize data from industrial equipment at scale.
- [AWS Lambda](#) is a compute service that helps you run code without needing to provision or manage servers. It runs your code only when needed and scales automatically, so you pay only for the compute time that you use.
- [Amazon Simple Storage Service \(Amazon S3\)](#) is a cloud-based object storage service that helps you store, protect, and retrieve any amount of data.
- [AWS SDK for Python \(Boto3\)](#) is a software development kit that helps you integrate your Python application, library, or script with AWS services.

## Epics

### Set up the job or function

Task	Description	Skills required
Configure permissions in IAM.	<p>In the IAM console, grant permissions to the IAM role assumed by the Lambda function or AWS Glue job to do the following:</p> <ul style="list-style-type: none"> <li>• Read from the AWS IoT SiteWise service</li> <li>• Write to the S3 bucket</li> </ul>	General AWS

Task	Description	Skills required
	For more information, see <a href="#">Creating a role for an AWS service</a> (IAM documentation).	
Create the Lambda function or AWS Glue job.	<p>If you are using Lambda, create a new Lambda function. For <b>Runtime</b>, choose <b>Python</b>. For more information, see <a href="#">Building Lambda functions with Python</a> (Lambda documentation).</p> <p>If you are using AWS Glue, create a new Python shell job in the AWS Glue console. For more information, see <a href="#">Adding Python shell jobs</a> (AWS Glue documentation).</p>	General AWS
Update the Lambda function or AWS Glue job.	Modify the new Lambda function or AWS Glue job, and enter the code sample in the <a href="#">Additional information</a> section. Modify the code as needed for your use case. For more information, see <a href="#">Edit code using the console editor</a> (Lambda documentation) and <a href="#">Working with scripts</a> (AWS Glue documentation).	General AWS

## Run the job or function

Task	Description	Skills required
Run the Lambda function or AWS Glue job.	Run the Lambda function or AWS Glue job. For more information, see <a href="#">Invoke the Lambda function</a> (Lambda documentation) or <a href="#">Starting jobs using triggers</a> (AWS Glue documentation). This extracts the metadata attributes for the assets and models in the AWS IoT SiteWise hierarchy and stores them in the specified S3 bucket.	General AWS
Set up an AWS Glue crawler.	Set up an AWS Glue crawler with the necessary format classifier for a CSV-formatted file. Use the S3 bucket and prefix details used in the Lambda function or AWS Glue job. For more information, see <a href="#">Defining crawlers</a> (AWS Glue documentation).	General AWS
Run the AWS Glue crawler.	Run the crawler to process the data file created by the Lambda function or AWS Glue job. The crawler creates a table in the specified AWS Glue Data Catalog. For more information, see or <a href="#">Starting crawlers using triggers</a> (AWS Glue documentation).	General AWS



Task	Description	Skills required
Query the metadata attributes.	Using Amazon Athena, use standard SQL to query the AWS Glue Data Catalog as needed for your use case. You can join the metadata attribute table with other databases and tables. For more information, see <a href="#">Getting Started</a> (Amazon Athena documentation).	General AWS

## Related resources

- [Amazon Athena documentation](#)
- [AWS Glue documentation](#)
- [AWS IoT SiteWise API reference](#)
- [AWS IoT SiteWise user guide](#)
  - [Getting started](#)
  - [Modeling industrial assets](#)
  - [Defining relationships between asset models \(hierarchies\)](#)
  - [Associating and disassociating assets](#)
  - [Creating the AWS IoT SiteWise demo](#)
- [IOTSiteWise](#) (SDK for Python documentation)
- [Lambda documentation](#)

## Additional information

### Code

The sample code provided is for reference, and you can customize this code as needed for your use case.

```
# Following code can be used in an AWS Lambda function or in an AWS Glue Python shell
job.
# IAM roles used for this job need read access to the AWS IoT SiteWise service and
write access to the S3 bucket.
sw_client = boto3.client('iotsitewise')
s3_client = boto3.client('s3')
output = io.StringIO()

attribute_list=[]
bucket = '{3_bucket name}'
prefix = '{s3_bucket prefix}'
output.write("model_id,model_name,asset_id,asset_name,attribuet_id,attribute_name,attribute_val
\n")

m_resp = sw_client.list_asset_models()
for m_rec in m_resp['assetModelSummaries']:
    model_id = m_rec['id']
    model_name = m_rec['name']

    attribute_list.clear()
    dam_response = sw_client.describe_asset_model(assetModelId=model_id)
    for rec in dam_response['assetModelProperties']:
        if 'attribute' in rec['type']:
            attribute_list.append(rec['name'])

    response = sw_client.list_assets(assetModelId=model_id, filter='ALL')
    for asset in response['assetSummaries']:
        asset_id = asset['id']
        asset_name = asset['name']
        resp = sw_client.describe_asset(assetId=asset_id)
        for rec in resp['assetProperties']:
            if rec['name'] in attribute_list:
                p_resp = sw_client.get_asset_property_value(assetId=asset_id,
propertyId=rec['id'])
                if 'propertyValue' in p_resp:
                    if p_resp['propertyValue']['value']:
                        if 'stringValue' in p_resp['propertyValue']['value']:
                            output.write(model_id + "," + model_name + ","
+ asset_id + "," + asset_name + "," + rec['id'] + "," + rec['name'] + "," +
str(p_resp['propertyValue']['value']['stringValue']) + "\n")

                            if 'doubleValue' in p_resp['propertyValue']['value']:
```

```
        output.write(model_id + "," + model_name + ","
+ asset_id + "," + asset_name + "," + rec['id'] + "," + rec['name'] + "," +
str(p_resp['propertyValue']['value']['doubleValue']) + "\n")
        if 'integerValue' in p_resp['propertyValue']['value']:
            output.write(model_id + "," + model_name + ","
+ asset_id + "," + asset_name + "," + rec['id'] + "," + rec['name'] + "," +
str(p_resp['propertyValue']['value']['integerValue']) + "\n")
            if 'booleanValue' in p_resp['propertyValue']['value']:
                output.write(model_id + "," + model_name + ","
+ asset_id + "," + asset_name + "," + rec['id'] + "," + rec['name'] + "," +
str(p_resp['propertyValue']['value']['booleanValue']) + "\n")

output.seek(0)
s3_client.put_object(Bucket=bucket, Key= prefix + '/data.csv', Body=output.getvalue())
output.close()
```

# Set up and troubleshoot AWS IoT Greengrass with client devices

Created by Marouane Sefiani and Akalanka De Silva (AWS)

**Environment:** PoC or pilot

**Technologies:** IoT

**AWS services:** AWS IoT Greengrass; AWS IoT Core

## Summary

AWS IoT Greengrass is an open-source edge runtime and cloud service for building, deploying, and managing Internet of Things (IoT) software on edge devices. Use cases for AWS IoT Greengrass include:

- Smart homes where an AWS IoT Greengrass gateway is used as a hub for home automation
- Smart factories where AWS IoT Greengrass can facilitate ingestion and local processing of data from the shop floor

AWS IoT Greengrass can act as a secure, authenticated, MQTT connection endpoint for other edge devices (also known as *client devices*), which otherwise would typically connect directly to AWS IoT Core. This capability is useful when client devices do not have direct network access to the AWS IoT Core endpoint.

You can set up AWS IoT Greengrass for use with client devices for the following use cases:

- For client devices to send data to AWS IoT Greengrass
- For AWS IoT Greengrass to forward data to AWS IoT Core
- To take advantage of advanced AWS IoT Core rules engine features

These capabilities require installing and configuring the following components on the AWS IoT Greengrass device:

- MQTT broker
- MQTT bridge

- Client device authentication
- IP detector

In addition, published messages from client devices must be in JSON format or [Protocol Buffers \(protobuf\)](#) format.

This pattern describes how to install and configure these required components, and provides troubleshooting tips and best practices.

## Prerequisites and limitations

### Prerequisites

- An active AWS account
- [AWS Command Line Interface \(AWS CLI\) version 2](#)
- Two client devices running Python 3.7 or later
- One core device running Java Runtime Environment (JRE) version 8 or later, and [Amazon Corretto 11](#) or [OpenJDK 11](#)

### Limitations

- You must choose an AWS Region where AWS IoT Core is available. For the current list of Regions for AWS IoT Core, see [AWS Services by Region](#).
- The core device must have at least 172 MB RAM and 512 MB of disk space.

## Architecture

The following diagram shows the solution architecture for this pattern.

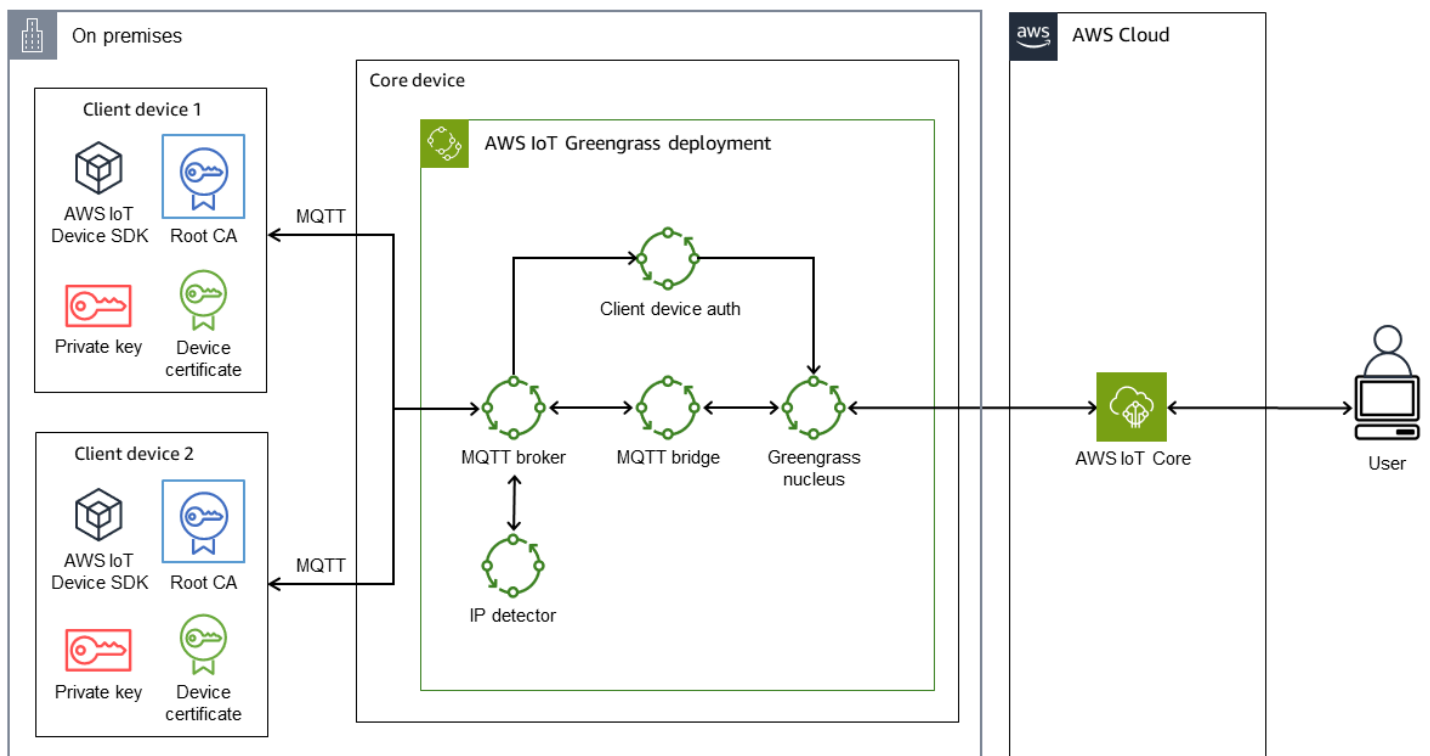

The architecture includes:

- Two client devices. Each device contains a private key, a device certificate, and a root certificate authority (CA) certificate. The AWS IoT Device SDK, which contains an MQTT client, is also installed on each client device.
- A core device that has AWS IoT Greengrass deployed with the following components:
  - MQTT broker
  - MQTT bridge
  - Client device authentication
  - IP detector

This architecture supports the following scenarios:

- Client devices can use their MQTT client to communicate with one another through the core device's MQTT broker.
- Client devices can also communicate with AWS IoT Core in the cloud through the core device's MQTT broker and the MQTT bridge.

- AWS IoT Core in the cloud can send messages to client devices through the MQTT test client and the core device's MQTT bridge and MQTT broker.

For more information about the communications between client devices and the core device, see the [Additional information](#) section.

## Tools

### AWS services

- [AWS IoT Greengrass](#) is an open source Internet of Things (IoT) edge runtime and cloud service that helps you build, deploy, and manage IoT applications on your devices.
- [AWS IoT Core](#) provides secure, bidirectional communication for internet-connected devices to connect to the AWS Cloud.
- [AWS IoT Device SDK](#) is a software development kit that includes open-source libraries, developer guides with samples, and porting guides so that you can build innovative IoT products or solutions on your choice of hardware platforms.
- [AWS Identity and Access Management \(IAM\)](#) helps you securely manage access to your AWS resources by controlling who is authenticated and authorized to use them.

## Best practices

- The payload of the messages from client devices should be in either JSON or Protobuf format in order to take advantage of the advanced features of the AWS IoT Core rules engine, such as transformation and conditional actions.
- Configure the MQTT bridge to allow bidirectional communication.
- Configure and deploy the IP detector component in AWS IoT Greengrass to ensure that the core device's IP addresses are included in the subject alternative name (SAN) field of the MQTT broker certificate.

# Epics

## Set up the core device

Task	Description	Skills required
Set up AWS IoT Greengrass on your core device.	Install the AWS IoT Greengrass Core software by following the instructions in the <a href="#">developer guide</a> .	AWS IoT Greengrass
Check the status of your installation.	Use the following command to check the status of the AWS IoT Greengrass service on your core device: <pre>sudo systemctl status greengrass.service</pre> The expected output of the command is: <pre>Launched Nucleus successfully</pre>	General AWS
Set up an IAM policy and attach it to the Greengrass service role.	<ol style="list-style-type: none"><li>1. Create an IAM policy to allow communications to and from the MQTT bridge. Here's an example policy:<pre>{  "Version":    "2012-10-17",  "Statement": [    {      "Effect":    "Allow",</pre></li></ol>	General AWS



Task	Description	Skills required
	<pre data-bbox="646 205 993 1171">       "Action":     [       "iot:*"     ],     "Resource": "*"   },   {     "Sid": "GreengrassActions",     "Effect": "Allow",     "Action": [       "greengrass:*"     ],     "Resource": "*"   } ] } </pre> <p data-bbox="591 1192 1029 1369">2. Attach the policy to the Greengrass service role. To get the service role, use the command:</p> <pre data-bbox="646 1411 993 1612"> aws greengrassv2   get-service-role-for-account --region   &lt;region&gt; </pre> <p data-bbox="630 1654 1013 1730">where &lt;region&gt; refers to your AWS Region.</p>	

Task	Description	Skills required
Configure and deploy required components in the AWS IoT Greengrass core device.	<p>Configure and deploy the following components:</p> <ul style="list-style-type: none"><li>• <code>greengrass.clientdevices.mqtt.Moquette</code> (see <a href="#">configuration details</a>)</li><li>• <code>greengrass.clientdevices.mqtt.Bridge</code> (see <a href="#">configuration details</a> and the next task)</li><li>• <code>greengrass.clientdevices.Auth</code> (see <a href="#">configuration details</a> and the task after the next one)</li><li>• <code>aws.greengrass.clientdevices.IPDetector</code> (see <a href="#">configuration details</a>)</li></ul>	AWS IoT Greengrass

Task	Description	Skills required
Confirm that the MQTT bridge allows bidirectional communication.	<p>To relay MQTT messages between client devices and AWS IoT Core, configure and deploy the MQTT bridge component and specify the topics to relay. Here's an example:</p> <pre data-bbox="592 583 1027 1461"> {   "mqttTopicMapping":   {     "ClientDevicesToCloud": {       "topic": "dt/#",       "source":       "LocalMqtt",       "target":       "IotCore"     },     "CloudToClientDevices": {       "topic": "cmd/#",       "source":       "IotCore",       "target":       "LocalMqtt"     }   } }</pre>	AWS IoT Greengrass

Task	Description	Skills required
<p>Confirm that the auth component allows client devices to connect and publish or subscribe to topics.</p>	<p>The following <code>aws.green</code> <code>grass.clientdevices.Auth</code> configuration allows all client devices to connect, publish messages, and subscribe to all topics.</p> <pre data-bbox="597 541 1029 1856"> {   "deviceGroups": {     "formatVersion":       "2021-03-05",     "definitions": {       "MyPermissiveDeviceGroup": {         "selectionRule": "thingName:           *",         "policyName":           "MyPermissivePolicy"       }     },     "policies": {       "MyPermissivePolicy": {         "AllowAll": {           "statementDescription": "Allow             client devices to             perform all actions.",           "operations":             [               "*"             ],           "resources":             [               "*"             ]         }       }     }   } } </pre>	<p>AWS IoT Greengrass</p>

Task	Description	Skills required
	<pre data-bbox="597 205 1024 306"> } } </pre>	

## Set up client devices

Task	Description	Skills required
Install the AWS IoT Device SDK.	<p data-bbox="589 590 1024 869">             Install the AWS IoT Device SDK on client devices. For a full list of supported languages and the associated SDKs, see the <a href="#">AWS IoT Core documentation</a>.           </p> <p data-bbox="589 911 1024 1087">             For example, the AWS IoT Device SDK for Python SDK is <a href="#">located on GitHub</a>. To install this SDK:           </p> <ol data-bbox="589 1129 1024 1465" style="list-style-type: none"> <li data-bbox="589 1129 1024 1360">1. Confirm that Python 3.7 or later is installed, as instructed on the <a href="#">Prerequisites page</a> of the GitHub repository.</li> <li data-bbox="589 1381 1024 1465">2. Use the <b>pip</b> command to install the SDK.</li> </ol> <p data-bbox="630 1507 951 1541">For MacOS and Linux::</p> <pre data-bbox="630 1583 1024 1703">python3 -m pip install awsiotsdk</pre> <p data-bbox="630 1734 824 1768">For Windows:</p>	General AWS IoT

Task	Description	Skills required
	<pre>python -m pip install awsiotsdk</pre> <p>Alternatively, you can install the SDK from the source repository:</p> <pre># Create a workspace directory to hold all the SDK files mkdir sdk-workspace cd sdk-workspace # Clone the repository git clone https://github.com/aws/aws-iot-device-sdk-python-v2.git # Install using Pip (use 'python' instead of 'python3' on Windows) python3 -m pip install ./aws-iot-device-sdk-python-v2</pre>	

Task	Description	Skills required
Create a thing.	<ol style="list-style-type: none"><li data-bbox="591 226 1024 499">1. In the <a href="#">AWS IoT console</a>, if a <b>Get started</b> button appears, choose it. Otherwise, in the navigation pane, choose <b>Security, Policies</b>.</li><li data-bbox="591 520 1024 751">2. If the <b>You don't have any policies yet</b> dialog box appears, choose <b>Create a policy</b>. Otherwise, choose <b>Create</b>.</li><li data-bbox="591 772 1024 961">3. Enter a name for the AWS IoT policy (for example, <code>ClientDevicePolicy</code>).</li><li data-bbox="591 982 1024 1339">4. In the <b>Add statements</b> section, replace the existing policy with the following JSON code. Replace <code>&lt;region&gt;</code> and <code>&lt;account&gt;</code> with your AWS Region and AWS account number.</li></ol> <pre data-bbox="630 1381 1024 1869">{   "Version":     "2012-10-17",   "Statement": [{     "Effect":       "Allow",     "Action":       "iot:Connect",     "Resource":       "arn:aws:iot:region:account:client/*"   }],</pre>	AWS IoT Core

Task	Description	Skills required
	<pre> {   "Effect": "Allow",   "Action": "iot:Publish",   "Resource": "*" }, {   "Effect": "Allow",   "Action": "iot:Receive",   "Resource": "*" }, {   "Effect": "Allow",   "Action": "iot:Subscribe",   "Resource": "*" }, {   "Effect": "Allow",   "Action": [     "iot:GetT hingShadow",     "iot:Upda teThingShadow",     "iot:Dele teThingShadow"   ],   "Resource": "arn:aws:iot:regio n:account:thing/*" } ] </pre>	



Task	Description	Skills required
	<pre data-bbox="630 205 1026 268">}</pre> <ol style="list-style-type: none"> <li data-bbox="592 283 852 315">5. Choose <b>Create</b>.</li> <li data-bbox="592 336 987 472">6. On the <a href="#">AWS IoT console</a>, in the navigation pane, choose <b>Manage, Things</b>.</li> <li data-bbox="592 493 1023 714">7. If the <b>You don't have any things yet</b> dialog box is displayed, choose <b>Register a thing</b>. Otherwise, choose <b>Create</b>.</li> <li data-bbox="592 735 1031 871">8. On the <b>Creating AWS IoT things</b> page, choose <b>Create a single thing</b>.</li> <li data-bbox="592 892 1023 1165">9. On the <b>Add your device to the device registry</b> page, enter a name for your IoT thing (for example, <code>ClientDevice1</code> ), and then choose <b>Next</b>.  <b>Note:</b> You can't change the name of a thing after you create it. To change the name, you must create a new thing, give it the new name, and then delete the old thing.</li> <li data-bbox="592 1554 1006 1690">10 On the <b>Add a certificate for your thing</b> page, choose <b>Create certificate</b>.</li> <li data-bbox="592 1711 1031 1785">11 Choose the <b>Download</b> links to download the certifica</li> </ol>	

Task	Description	Skills required
	<p>te, private key, and root CA certificate.</p> <p><b>Important:</b> This is your only opportunity to download your certificate and private key.</p> <p>12.To activate the certificate, choose <b>Activate</b>. The certificate must be active for a device to connect to AWS IoT.</p> <p>13Choose <b>Attach a policy</b>.</p> <p>14For <b>Add a policy for your thing</b>, choose <b>ClientDevicePolicy, Register Thing</b>.</p>	

Task	Description	Skills required
Download the CA certificate from the Greengrass core device.	<p>If you expect the Greengrass core device to work in offline environments, you have to make the Greengrass core CA certificate available to the client device so it can verify the MQTT broker's certificate (which is issued by the Greengrass core CA). Therefore, it is important to obtain a copy of this certificate. Use one of the following approaches to download the CA certificate:</p> <ul style="list-style-type: none"><li>• If you have network access to the AWS IoT Greengrass device from your PC, enter <code>https://&lt;device IP&gt;:8883</code> in your web browser and view the MQTT broker certificate and the CA certificate. You can also save the CA certificate to the client device.</li><li>• Alternatively, you can use the OpenSSL command line:</li></ul> <pre data-bbox="625 1629 1029 1789">openssl s_client - showcerts -connect &lt;device IP&gt;:8883</pre>	General AWS

<b>Task</b>	<b>Description</b>	<b>Skills required</b>
Copy credentials in the client devices.	Copy the Greengrass core CA certificate, the device certificate, and the private key in the client devices.	General AWS

Task	Description	Skills required
Associate client devices with the core device.	<p>Associate client devices with a core device so that they can discover the core device. The client devices can then use the <a href="#">Greengrass discovery API</a> to retrieve connectivity information and certificates for their associated core devices. For more information, see <a href="#">Associate client devices</a> in the AWS IoT Greengrass documentation.</p> <ol style="list-style-type: none"><li>1. On the <a href="#">AWS IoT Greengrass console</a>, choose <b>Core devices</b>.</li><li>2. Choose the core device to manage.</li><li>3. On the core device's details page, choose the <b>Client devices</b> tab.</li><li>4. In the <b>Associated client devices</b> section, choose <b>Associate client devices</b>.</li><li>5. In the <b>Associate client devices with core device</b> modal, do the following for each client device to associate:<ol style="list-style-type: none"><li>a. Enter the name of the AWS IoT thing to associate as a client device.</li><li>b. Choose <b>Add</b>.</li></ol></li></ol>	AWS IoT Greengrass

Task	Description	Skills required
	<p>6. Choose <b>Associate</b>.</p> <p>The client devices that you associated can now use the Greengrass discovery API to discover this core device.</p>	

## Send and receive data

Task	Description	Skills required
Send data from one client device to another client device.	Use the MQTT client in your device to publish a message on the <code>dt/client1/sensor</code> topic.	General AWS
Send data from the client device to AWS IoT Core.	<p>Use the MQTT client in your device to publish a message on the <code>dt/client1/sensor</code> topic.</p> <p>In the MQTT test client, subscribe to the topic that the device is sending messages on, or subscribe to <code>#</code> for all topics (see <a href="#">details</a>).</p>	General AWS
Send messages from AWS IoT Core to client devices.	On the MQTT test client page, in the <b>Publish to a topic</b> tab, in the <b>Topic name</b> field, enter the topic name of your message. In this example, use <code>cmd/client1</code> for the topic.	General AWS

# Troubleshooting

Issue	Solution
<b>Unable to verify server certificate error</b>	<p>This error occurs when the MQTT client cannot verify the certificate that's presented by the MQTT broker during the TLS handshake. The most common reason is that the MQTT client doesn't have the CA certificate. Follow these steps to make sure that the CA certificate is provided to the MQTT client.</p> <ol style="list-style-type: none"><li>1. If you have network access to the AWS IoT Greengrass device from your PC, enter <code>https://&lt;device IP&gt;:8883</code> in a browser window to view the MQTT broker certificate and the CA certificate. You can also save the CA certificate to the client device.  Alternatively use the OpenSSL command line: <pre>openssl s_client -showcerts -connect &lt;device IP&gt;:8883</pre></li><li>2. Save the contents of the Moquette CA and Greengrass Core CA certificates into files, and then view the decoded contents by using the command: <pre>openssl x509 -in &lt;Name of CA&gt;.pem -text</pre></li></ol> <p>The Moquette CA certificate should show the SAN field as in this example:</p>

Issue	Solution
	<pre>X509v3 Subject Alternative Name:   IP Address:XXX.XXX.XXX.XXX, IP   Address:127.0.0.1, DNS:localhost</pre>
<b>Unable to verify server name error</b>	<p>This error occurs when the MQTT client can't verify that it's connecting to the correct server. The most common reason is that the IP address of the Greengrass device isn't listed in the SAN field of the certificate.</p> <p>Follow the instructions in the previous solution to obtain the MQTT broker certificate and verify that the SAN field contains the IP address of the AWS IoT Greengrass device, as explained in the <a href="#">Additional information</a> section. If not, confirm that the IP detector component is installed correctly and restart the core device.</p>
<b>Unable to verify server name only when connecting from an embedded client device</b>	<p>Mbed TLS, which is a popular TLS library used in embedded devices, currently supports DNS name verification only in the SAN field of the certificate, as shown in the Mbed TLS library code. Because the core device doesn't have its own domain name and depends on the IP address, TLS clients that use Mbed TLS will fail the server name verification during the TLS handshake, causing a connection failure. We recommend that you add the SAN IP address verification to your Mbed TLS library at the <a href="#">x509_cert_check_san function</a>.</p>



## Related resources

- [AWS IoT Greengrass documentation](#)
- [AWS IoT Core documentation](#)
- [MQTT broker component](#)
- [MQTT bridge component](#)
- [Client device auth component](#)
- [IP detector component](#)
- [AWS IoT Device SDKs](#)
- [Implementing Local Client Devices with AWS IoT Greengrass](#) (AWS blog post)
- [RFC 5280 – Internet X.509 Public Key Infrastructure Certificate and Certificate Revocation List \(CRL\) Profile](#)

## Additional information

This section provides additional information about the communications between the client devices and the core device.

The MQTT broker listens on port 8883 in the core device for a TLS client connection attempt. The following illustration shows an example MQTT broker's server certificate.

## Certificate

aws.greengrass.clientdevices.mqtt.Moquette

Greengrass Core CA

**Subject Name**

Country	US
Organization	Amazon.com Inc.
Organizational Unit	Amazon Web Services
State/Province	Washington
Locality	Seattle
Common Name	aws.greengrass.clientdevices.mqtt.Moquette

**Issuer Name**

Country	US
Organization	Amazon.com Inc.
Organizational Unit	Amazon Web Services
State/Province	Washington
Locality	Seattle
Common Name	Greengrass Core CA

Certificate is issued by Greengrass Core CA (this device)

**Validity**

Not Before	Mon, 10 Apr 2023 00:57:41 GMT
Not After	Mon, 17 Apr 2023 00:57:41 GMT

Valid for only 7 days  
Rotated weekly  
automatically

**Subject Alt Names**

IP Address	192.168.1.12
DNS Name	localhost

TLS clients can connect to this broker on localhost or on the network interface with the IP 192.168.1.12.

The example certificate displays the following details:

- The certificate is issued by the AWS IoT Greengrass Core CA, which is local and specific to the core device; that is, it acts as a local CA.

- This certificate is automatically rotated every week by the client auth component as shown in the following illustration. You can set this interval in the client auth component configuration.

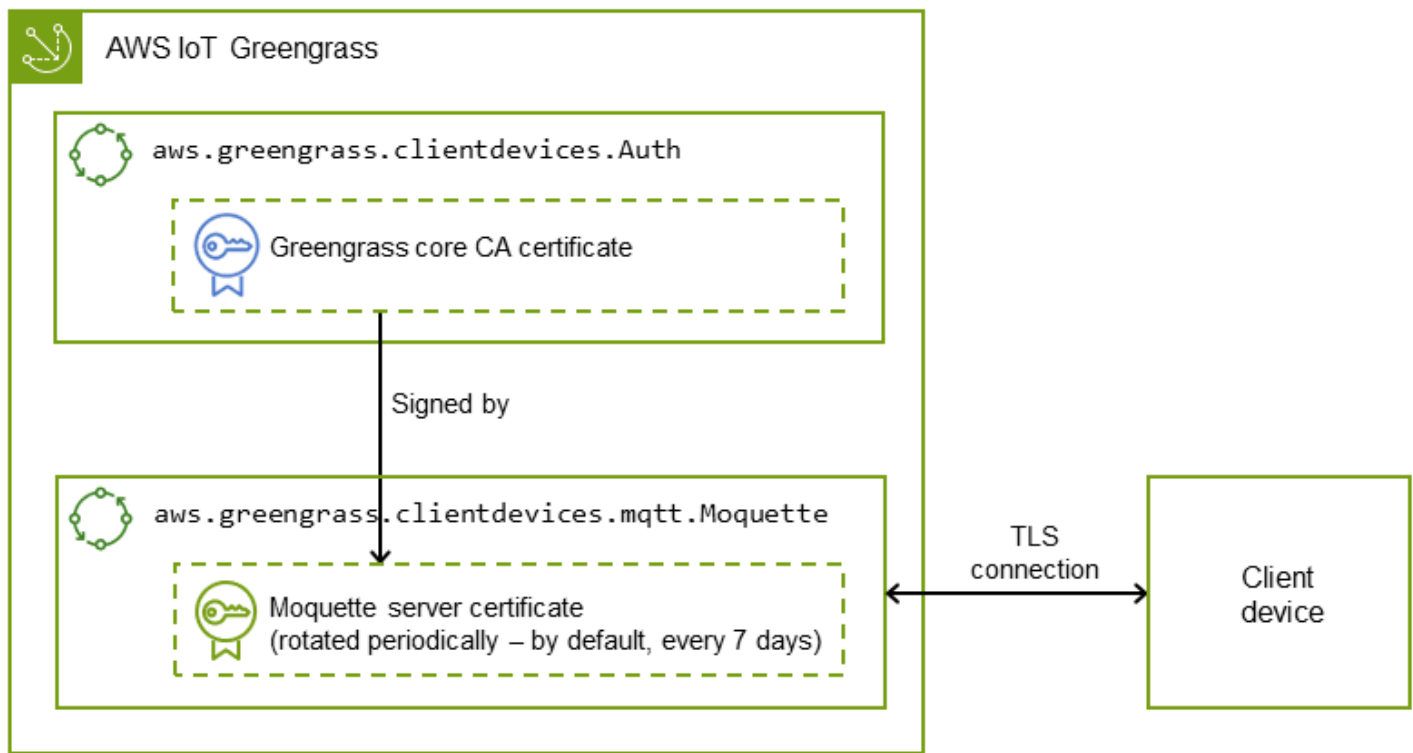

- The subject alternative name (SAN) plays a critical role in the server name verification on the TLS client end. It helps the TLS client ensure that it connects to the correct server and helps avoid man-in-the-middle attacks during TLS session setup. In the example certificate, the SAN field indicates that this server is listening on localhost (the local Unix domain socket), and the network interface has the IP address 192.168.1.12.

The TLS client uses the SAN field in the certificate to verify that it's connecting to a legitimate server during server verification. In contrast, during a typical TLS handshake between an HTTP server and a browser, the domain name in the common name (CN) field or SAN field is used to cross-check the domain that the browser is actually connecting to during the server verification process. If the core device doesn't have a domain name, the IP address included in the SAN field serves the same purpose. For more information, see the [Subject Alternative Name section](#) of *RFC 5280 – Internet X.509 Public Key Infrastructure Certificate and Certificate Revocation List (CRL) Profile*.

The IP detector component in AWS IoT Greengrass ensures that the correct IP addresses are included in the SAN field of the certificate.

The certificate in the example is signed by the AWS IoT Greengrass device acting as a local CA. The TLS client (MQTT client) isn't aware of this CA, so we must provide a CA certificate that looks like the following.

# Certificate

aws.greengrass.clientdevices.mqtt.Moquette

Greengrass Core CA

## Subject Name

Country	US
Organization	Amazon.com Inc.
Organizational Unit	Amazon Web Services
State/Province	Washington
Locality	Seattle
Common Name	Greengrass Core CA

## Issuer Name

Country	US
Organization	Amazon.com Inc.
Organizational Unit	Amazon Web Services
State/Province	Washington
Locality	Seattle
Common Name	Greengrass Core CA

## Validity

Not Before	Mon, 21 Nov 2022 11:42:51 GMT
Not After	Sat, 20 Nov 2027 11:42:51 GMT

## Public Key Info

Algorithm	RSA
Key Size	2048
Exponent	65537
Modulus	96:09:BE:45:DF:AA:AD:44:0D:B8:09:2D:A6:CE:25:70:7A:B2:8A:D3:53:9F:58:CB:C2:...

## More patterns

- [Cost-effectively ingest IoT data directly into Amazon S3 using AWS IoT Greengrass](#)

# Machine learning & AI

## Topics

- [Aggregate data in Amazon DynamoDB for ML forecasting in Athena](#)
- [Associate an AWS CodeCommit repository in one AWS account with SageMaker Studio in another account](#)
- [Automate Amazon Lookout for Vision training and deployment for anomaly detection](#)
- [Automatically extract content from PDF files using Amazon Textract](#)
- [Build an MLOps workflow by using Amazon SageMaker and Azure DevOps](#)
- [Create a custom Docker container image for SageMaker and use it for model training in AWS Step Functions](#)
- [Deploy preprocessing logic into an ML model in a single endpoint using an inference pipeline in Amazon SageMaker](#)
- [Develop advanced generative AI chat-based assistants by using RAG and ReAct prompting](#)
- [Develop a fully automated chat-based assistant by using Amazon Bedrock agents and knowledge bases](#)
- [Document institutional knowledge from voice inputs by using Amazon Bedrock and Amazon Transcribe](#)
- [Generate personalized and re-ranked recommendations using Amazon Personalize](#)
- [Train and deploy a custom GPU-supported ML model on Amazon SageMaker](#)
- [Use SageMaker Processing for distributed feature engineering of terabyte-scale ML datasets](#)
- [Visualize AI/ML model results using Flask and AWS Elastic Beanstalk](#)
- [More patterns](#)

# Aggregate data in Amazon DynamoDB for ML forecasting in Athena

Created by Sachin Doshi (AWS) and Peter Molnar (AWS)

<b>Code repository:</b> <a href="#">Use ML predictions over Amazon DynamoDB data with Amazon Athena ML</a>	<b>Environment:</b> Production	<b>Technologies:</b> Machine learning & AI; Databases; Serverless
<b>Workload:</b> Open-source	<b>AWS services:</b> Amazon Athena; Amazon DynamoDB; AWS Lambda; Amazon SageMaker; Amazon QuickSight	

## Summary

This pattern shows you how to build complex aggregations of Internet of Things (IoT) data in an Amazon DynamoDB table by using Amazon Athena. You also learn how to enrich the data with machine learning (ML) inference by using Amazon SageMaker and how to query geospatial data by using Athena. You can use this pattern as the basis for creating an ML forecasting solution that meets your organization's requirements.

For demonstration purposes, this pattern uses an example scenario of a business that's operating a scooter rideshare and wants to predict the optimal number of scooters that must be deployed for customers in different urban neighborhoods. The business uses a pre-trained ML model that predicts customer demand for the next hour based on the past four hours. The scenario uses a public dataset from the [Office of Civic Innovation & Technology](#) for the Louisville Metro government. The resources for this scenario are available in a GitHub repository.

## Prerequisites and limitations

- An active AWS account
- Permissions to create an AWS CloudFormation stack with AWS Identity and Access Management (IAM) roles for the following:



- Amazon Simple Storage Service (Amazon S3) bucket
- Athena
- DynamoDB
- SageMaker
- AWS Lambda

## Architecture

### Technology stack

- Amazon QuickSight
- Amazon S3
- Athena
- DynamoDB
- Lambda
- SageMaker

### Target architecture

The following diagram shows an architecture for building complex aggregations of data in DynamoDB by using the querying capabilities of Athena, a Lambda function, Amazon S3 storage, a SageMaker endpoint, and a QuickSight dashboard.

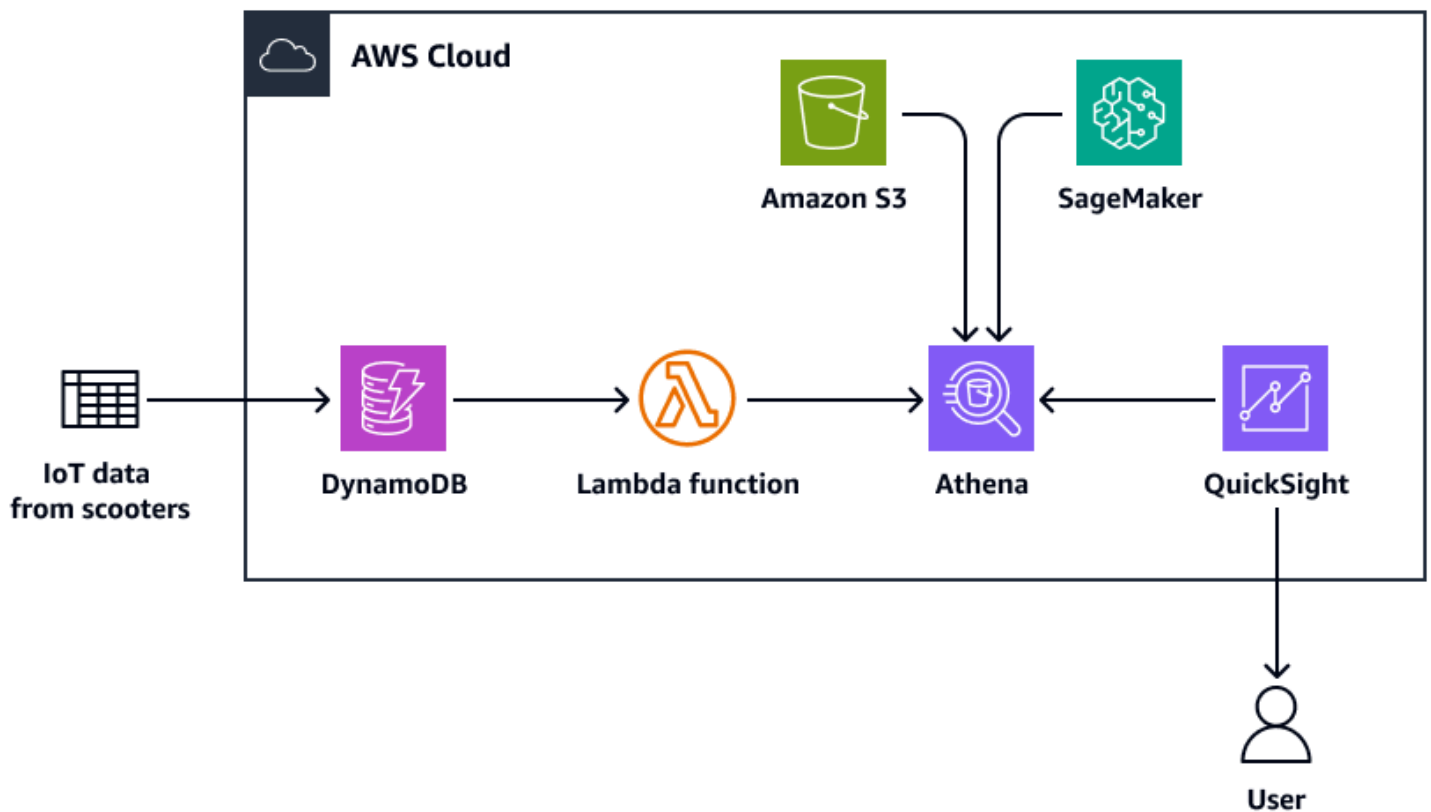

The diagram shows the following workflow:

1. A DynamoDB table ingests IoT data that's transmitted from a fleet of scooters.
2. A Lambda function loads the DynamoDB table with the ingested data.
3. An Athena query creates a new DynamoDB table for the geospatial data that represents the urban neighborhoods.
4. The query location is saved in an S3 bucket.
5. An Athena function queries the ML inference from the SageMaker endpoint that hosts the pre-trained ML model.
6. Athena queries data directly from the DynamoDB tables and aggregates the data for analysis.
7. A user views the output of the analyzed data in a QuickSight dashboard.

## Tools

### AWS services

- [Amazon Athena](#) is an interactive query service that helps you analyze data directly in Amazon S3 by using standard SQL.
- [Amazon DynamoDB](#) is a fully managed NoSQL database service that provides fast, predictable, and scalable performance.
- [Amazon SageMaker](#) is a managed ML service that helps you build and train ML models and then deploy them into a production-ready hosted environment.
- [Amazon Simple Storage Service \(Amazon S3\)](#) is a cloud-based object storage service that helps you store, protect, and retrieve any amount of data.
- [Amazon QuickSight](#) is a cloud-scale business intelligence (BI) service that helps you visualize, analyze, and report your data in a single dashboard.
- [AWS Lambda](#) is a compute service that helps you run code without needing to provision or manage servers. It runs your code only when needed and scales automatically, so you pay only for the compute time that you use.

## Code repository

The code for this pattern is available in the GitHub [Use ML predictions over Amazon DynamoDB data with Amazon Athena ML](#) repository. You can use the CloudFormation template from the repository to create the following resources used in the example scenario:

- A DynamoDB table
- A Lambda function to load the table with relevant data
- A SageMaker endpoint for inference requests, with the pre-trained XGBoost model that's stored in Amazon S3
- An Athena workgroup named V2EngineWorkGroup
- Named Athena queries to look up the geospatial shapefiles and predict scooter demand
- A prebuilt [Amazon Athena DynamoDB connector](#) that enables Athena to communicate with DynamoDB and uses [AWS Serverless Application Model \(AWS SAM\)](#) to build the application in reference to the DynamoDB connector

# Epics

## Get the example dataset

Task	Description	Skills required
Download the dataset and resources.	<ol style="list-style-type: none"><li>1. Download a <a href="#">public dataset of dockless vehicle rentals</a>. For demo purposes, this data is prepopulated in DynamoDB as part of the use case, but in a production environment you send this data to DynamoDB through various mechanisms such as IoT devices or <a href="#">Amazon Kinesis</a> consumers. These mechanisms use Lambda to insert data into DynamoDB.</li><li>2. Download the <a href="#">GIS shapefiles</a> that represent the boundaries of historical and cultural neighborhoods within the city of Louisville, KY. The public dataset is provided by the <a href="#">Louisville and Jefferson County, KY Information Consortium</a>. The original shapefiles are already converted into a text file that you can query with Athena, but you can find the Python code for transforming shapefiles</li></ol>	App developer, Data scientist

Task	Description	Skills required
	<p>in the Jupyter notebook at <a href="#">Geo-Spatial processing of GIS shapefiles with Amazon Athena</a> in GitHub.</p> <ol style="list-style-type: none"> <li>Download the pretrained <a href="#">Python code</a> that trains the ML model for hourly forecasts by using SageMaker and Athena.</li> <li>Get the SQL query in Athena that brings everything together for live predictions from the data stored in DynamoDB.</li> <li>(Optionally) Use QuickSight to <a href="#">visualize geospatial data over a map of Louisville, Kentucky</a>.</li> </ol>	

### Use a CloudFormation template to deploy the required resources

Task	Description	Skills required
Create a CloudFormation stack.	<ol style="list-style-type: none"> <li>Download the CloudFormation template from the GitHub <a href="#">repository</a>.</li> <li>Sign in to the AWS Management Console, and then choose us-east-1 . <b>Note:</b> The ML model is stored in the Amazon Elastic Container Registry (Amazon ECR) for the us-</li> </ol>	AWS DevOps

Task	Description	Skills required
	<p>east-1 AWS Region, but the pattern is Region agnostic. You can replicate the pattern in any Region where the AWS services used in this pattern are supported.</p> <ol style="list-style-type: none"><li>3. Open the <a href="#">CloudFormation console</a>, and then choose <b>Stacks</b> on the navigation pane.</li><li>4. Choose <b>Create stack</b>, and then choose <b>With existing resources (import resources)</b>.</li><li>5. On the <b>Identify resources</b> page, choose <b>Next</b>.</li><li>6. In the <b>Specify template</b> section, for <b>Template source</b>, select <b>Upload a template file</b>.</li><li>7. Choose <b>File</b>, and then choose the CloudFormation template that you downloaded earlier.</li><li>8. Choose <b>Next</b>, accept the default parameter values, and choose <b>Next</b> to step through the rest of the setup wizard.</li><li>9. Select the <b>I acknowledge that AWS CloudFormation might create IAM</b></li></ol>	

Task	Description	Skills required
	<p><b>resources with custom names</b> check box.</p> <p>10Choose <b>Create stack</b>.</p> <p><b>Note:</b> It can take 15–20 minutes for the CloudFormation stack to create these resources.</p>	

Task	Description	Skills required
Verify the CloudFormation deployment.	<p>To verify that the sample data from the CloudFormation template is loaded into DynamoDB, do the following:</p> <ol style="list-style-type: none"><li>1. Open the <a href="#">DynamoDB console</a>, and then choose <b>Tables</b> from the navigation pane.</li><li>2. In the <b>Tables</b> section, check for the DynamoDBT ableDocklessVehicles table.</li><li>3. After resource creation is complete, open the <a href="#">Athena console</a>, and then choose <b>Workgroups</b> from the navigation pane.</li><li>4. Choose the V2EngineWorkgroup workgroup , and then choose <b>Switch workgroup</b>.</li><li>5. If you get a prompt to save the query result location, choose an Amazon S3 location where you have write permissions.</li><li>6. Choose <b>Save</b>.</li><li>7. In the navigation pane, choose <b>Query editor</b>, and then select the athena-ml-db-<code>&lt;your-AWS-account-number&gt;</code> database.</li></ol>	App developer



## Load geolocation files into Athena

Task	Description	Skills required
Create an Athena table with geospatial data.	<p>To load the geolocation files into Athena, do the following:</p> <ol style="list-style-type: none"><li>1. Open the <a href="#">Athena console</a>, and then choose <b>Query editor</b> from the navigation pane.</li><li>2. Choose the <b>Saved queries</b> tab.</li><li>3. Search for and select <b>Q1: Neighborhoods</b>.</li><li>4. To return to the query editor, choose the <b>Editor</b> tab.</li><li>5. Choose <b>Run</b>. This creates a table named <code>louisville_ky_neighborhoods</code> in your database. Make sure the table is created in the <code>athena-ml-db- &lt;your-AWS-account-number&gt;</code> database.</li></ol> <p>The query creates a new table for the geospatial data that represents the urban neighborhoods. The data table is created from GIS shapefiles. The CREATE EXTERNAL TABLE statement defines the schema of the table and the location and</p>	Data engineer

Task	Description	Skills required
	<p>format of the underlying data file.</p> <p>For the Python code to process shapefiles and produce this table, see <a href="#">Geo-Spatial processing of GIS shapefiles with Amazon Athena</a> in AWS Samples. For detailed SQL code, see <a href="#">create_neighborhood_table.sql</a> on GitHub.</p>	

## Predict demand for scooters by neighborhood from the aggregated DynamoDB data

Task	Description	Skills required
Declare a function in Athena to query SageMaker.	<ol style="list-style-type: none"> <li>1. Open the <a href="#">Athena console</a>, choose <b>Query editor</b> from the navigation pane, and then choose the <b>Editor</b> tab.</li> <li>2. Copy and paste the following SQL statement into the query editor.</li> </ol> <pre> USING EXTERNAL   FUNCTION predict_d   emand   ( location_id     BIGINT,     hr BIGINT ,     dow BIGINT,     n_pickup_1 BIGINT,     n_pickup_2 BIGINT,     n_pickup_3 BIGINT,     n_pickup_4 BIGINT, </pre>	Data scientist, Data engineer

Task	Description	Skills required
	<pre data-bbox="630 205 1026 508">n_dropoff_1 BIGINT, n_dropoff_2 BIGINT, n_dropoff_3 BIGINT, n_dropoff_4 BIGINT ) RETURNS DOUBLE SAGEMAKER '&lt;Your SageMaker endpoint&gt;'</pre> <p data-bbox="630 541 1013 865">The first part of the SQL statement declares the external function to query ML inferences from the SageMaker endpoint that hosts the pre-trained model.</p> <ol data-bbox="591 886 1013 1117" style="list-style-type: none"><li>3. Define the order and type of the input parameters and the type of the return values.</li><li>4. Choose <b>Run</b>.</li></ol>	

Task	Description	Skills required
Predict demand for scooters by neighborhood from the aggregated DynamoDB data.	<p>Now you can use Athena to query transactional data directly from DynamoDB, and then aggregate the data for analysis and forecasting. This isn't easily achieved by directly querying a DynamoDB NoSQL database.</p> <ol style="list-style-type: none"><li>1. Open the <a href="#">Athena console</a>, and then choose the <b>Query editor</b> from the navigation pane.</li><li>2. Choose the <b>Saved queries</b> tab.</li><li>3. Search for and select <b>Q2: DynamoDBAthenaMLScooterPredict</b>.</li><li>4. To return to the query editor, choose the <b>Editor</b> tab.</li><li>5. Choose <b>Run</b>.</li></ol> <p>The SQL statement does the following:</p> <ul style="list-style-type: none"><li>• Uses an <a href="#">Athena Federated Query</a> to query the DynamoDB table with the raw trip data</li><li>• Places geographic coordinates into neighborhoods by using the geospatial functions of Athena</li></ul>	App developer, Data scientist

Task	Description	Skills required
	<ul style="list-style-type: none"> <li>Enriches data with ML inference by using SageMaker</li> </ul> <p>For information about using SQL to aggregate DynamoDB data and SageMaker inference data in Athena, see <a href="#">athena_loading.sql</a> in GitHub.</p>	
Verify the output.	<p>The output table includes the neighborhood, longitude, and latitude of the centroid of the neighborhood. It also includes the number of vehicles that are predicted for the next hour.</p> <p>The query produces the predictions for a selected point in time. You can make predictions for any other time by changing the expression <code>on TIMESTAMP '2019-09-07 15:00'</code> everywhere in the statement.</p> <p>If you have a real-time data feed in your DynamoDB table, change the timestamp to <code>NOW()</code>.</p>	App developer, Data scientist

## Clean up the environment

Task	Description	Skills required
Delete resources.	<ol style="list-style-type: none"><li>1. Open the <a href="#">Athena console</a> and <a href="#">empty the bucket</a> that you created as part of the CloudFormation stack.</li><li>2. Open the <a href="#">CloudFormation console</a>, and then <a href="#">delete the stack</a> named <code>bdb-1462-athena-dynamodb-ml-stack</code>.</li><li>3. Open the <a href="#">Amazon CloudWatch console</a>, and then <a href="#">delete the log group</a> named <code>/aws/sagemaker/Endpoints/SageMaker-athena-ml-dynamodb-model-endpoint</code>.</li></ol>	App developer, AWS DevOps

## Related resources

- [Amazon Athena Query Federation SDK](#) (GitHub)
- [Querying geospatial data](#) (AWS documentation)
- [Use ML predictions over Amazon DynamoDB data with Amazon Athena ML](#) (AWS Big Data Blog)
- [Amazon ElastiCache \(Redis OSS\)](#) (AWS documentation)
- [Amazon Neptune](#) (AWS documentation)

# Associate an AWS CodeCommit repository in one AWS account with SageMaker Studio in another account

Created by Laurens van der Maas (AWS) and Aubrey Oosthuizen (AWS)

**Environment:** Production

**Technologies:** Machine learning & AI; DevOps; Security, identity, compliance; CloudNative

**AWS services:** AWS CodeCommit; Amazon SageMaker; AWS Identity and Access Management

## Summary

This pattern provides instructions and code on how to associate an AWS CodeCommit repository in one AWS account (Account A) with Amazon SageMaker Studio in another AWS account (Account B). To set up the association, you must create an AWS Identity and Access Management (IAM) policy and role in Account A and an IAM inline policy in Account B. Then, you use a shell script to clone the CodeCommit repository from Account A to SageMaker Studio in Account B.

## Prerequisites and limitations

### Prerequisites

- Two [AWS accounts](#), one containing the CodeCommit repository and the other containing a SageMaker Domain with a user
- Provisioned [SageMaker Domain and user](#), with internet access or access to CodeCommit and AWS Security Token Service (AWS STS) through virtual private network (VPC) endpoints
- A basic understanding of [IAM](#)
- A basic understanding of [SageMaker Studio](#)
- A basic understanding of [Git](#) and [CodeCommit](#)

### Limitations

This pattern applies to SageMaker Studio only, not to RStudio on Amazon SageMaker.

# Architecture

## Technology stack

- Amazon SageMaker
- Amazon SageMaker Studio
- AWS CodeCommit
- AWS Identity and Access Management (IAM)
- Git

## Target architecture

The following diagram shows an architecture that associates a CodeCommit repository from Account A to SageMaker Studio in Account B.

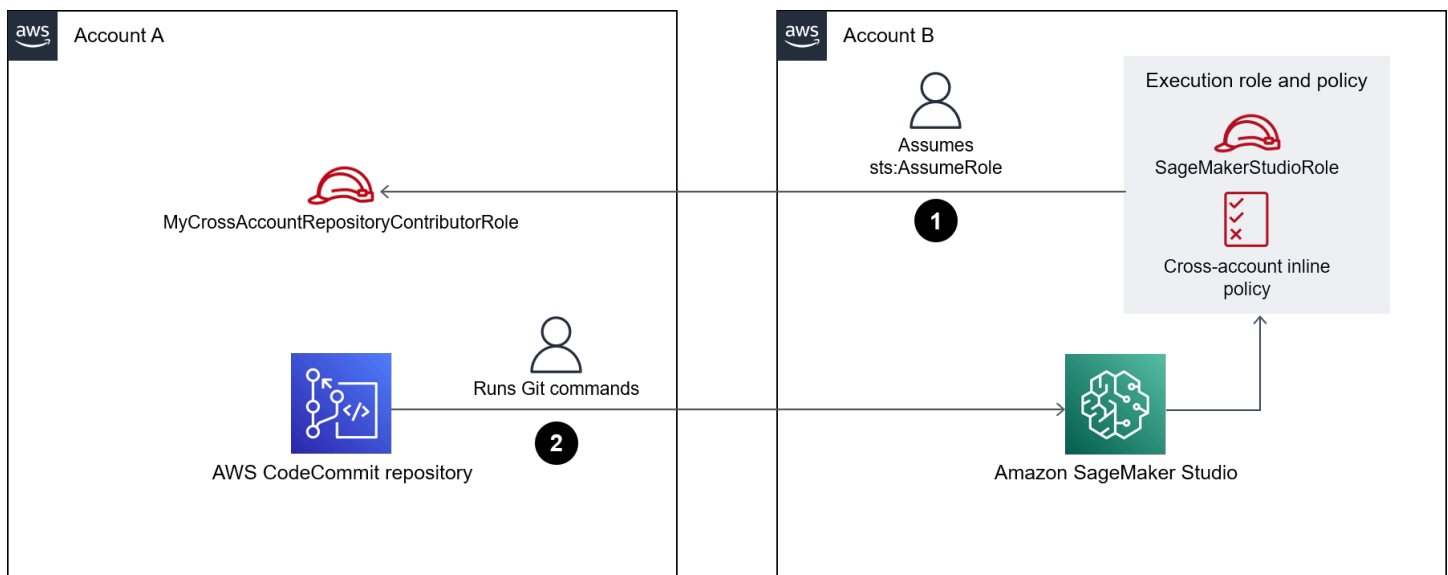

The diagram shows the following workflow:

1. A user assumes the `MyCrossAccountRepositoryContributorRole` role in Account A through the `sts:AssumeRole` role, while using the SageMaker execution role in SageMaker Studio in Account B. The assumed role includes the CodeCommit permissions to clone and interact with the specified repository.
2. The user performs Git commands from the system terminal in SageMaker Studio.

## Automation and scale



This pattern consists of manual steps that can be automated by using the [AWS Cloud Development Kit \(AWS CDK\)](#), [AWS CloudFormation](#), or [Terraform](#).

## Tools

### AWS tools

- [Amazon SageMaker](#) is a managed machine learning (ML) service that helps you build and train ML models and then deploy them into a production-ready hosted environment.
- [Amazon SageMaker Studio](#) is a web-based, integrated development environment (IDE) for machine learning that lets you build, train, debug, deploy, and monitor your machine learning models.
- [AWS CodeCommit](#) is a version control service that helps you privately store and manage Git repositories, without needing to manage your own source control system.
- [AWS Identity and Access Management \(IAM\)](#) helps you securely manage access to your AWS resources by controlling who is authenticated and authorized to use them.

### Other tools

- [Git](#) is a distributed version-control system for tracking changes in source code during software development.

## Epics

### Create an IAM policy and IAM role in Account A

Task	Description	Skills required
Create an IAM policy for repository access in Account A.	<ol style="list-style-type: none"><li>1. Sign in to the AWS Management Console and open the <a href="#">IAM console</a>.</li><li>2. In the navigation pane, choose <b>Policies</b>, and then choose <b>Create policy</b>.</li><li>3. Choose the <b>JSON</b> tab.</li></ol>	AWS DevOps

Task	Description	Skills required
	<ol style="list-style-type: none"><li>4. Copy the policy statement from <i>Example IAM policy</i> in the <a href="#">Additional information</a> section of this pattern, and then paste the statement into the JSON editor. Make sure to replace all placeholder values in the policy.</li><li>5. Choose <b>Next:Tags</b>, and then choose <b>Next:Review</b>.</li><li>6. For <b>Name</b>, enter a name for the policy. <b>Note:</b> In this pattern, the IAM policy is referred to as <code>CrossAccountAccessForMySharedDemoRepo</code>, but you can choose whatever policy name that you prefer.</li><li>7. Choose <b>Create policy</b>.</li></ol> <p><b>Tip:</b> It's a best practice to restrict the scope of your IAM policies to the minimum required permissions for your use case.</p>	

Task	Description	Skills required
Create an IAM role for repository access in Account A.	<ol style="list-style-type: none"><li>1. In the navigation pane of the <a href="#">IAM console</a>, choose <b>Roles</b>, and then choose <b>Create role</b>.</li><li>2. For <b>Trusted entity type</b>, select <b>AWS account</b>.</li><li>3. In the <b>AWS account</b> section, select <b>Another AWS account</b>.</li><li>4. For <b>Account ID</b>, enter the account ID for Account B.</li><li>5. On the <b>Add permissions</b> page, search for and choose the <code>CrossAccountAccessForMySharedDemoRepo</code> policy that you created earlier.</li><li>6. Choose <b>Next</b>.</li><li>7. For <b>Role name</b>, enter a name. <b>Note:</b> In this pattern, the IAM role name is referred to as <code>MyCrossAccountRepositoryContributorRole</code>, but you can choose whatever role name that you prefer.</li><li>8. Choose <b>Create role</b>, and then copy the Amazon Resource Name (ARN) of the new role.</li></ol>	AWS DevOps

## Create an IAM inline policy in Account B

Task	Description	Skills required
<p>Attach an inline policy to the execution role that's attached to your SageMaker Domain user in Account B.</p>	<ol style="list-style-type: none"><li>1. In the navigation pane of the <a href="#">IAM console</a>, choose <b>Roles</b>.</li><li>2. Search for and choose the execution role that's attached to your SageMaker Domain user in Account B.</li><li>3. Choose <b>Add permissions</b>, and then choose <b>Create inline policy</b>.</li><li>4. Choose the <b>JSON</b> tab.</li><li>5. Copy the following policy statement, and then paste it into the JSON editor.</li></ol> <pre data-bbox="630 1087 1029 1885">{   "Version":     "2012-10-17",   "Statement": [     {       "Sid":         "VisualEditor0",       "Effect":         "Allow",       "Action":         "sts:AssumeRole",       "Resource":         ": "arn:aws: iam::&lt;Account_A_ID &gt;:role/&lt;Account_A_ Role_Name&gt;"     }   ] }</pre>	AWS DevOps

Task	Description	Skills required
	<ol style="list-style-type: none"> <li>6. Replace &lt;Account_A_ID&gt; with the account ID for Account A. Replace &lt;Account_A_Role_Name&gt; with the name of the IAM role that you created earlier.</li> <li>7. Choose <b>Review policy</b>.</li> <li>8. For <b>Name</b>, enter a name for your inline policy.</li> <li>9. Choose <b>Create policy</b>.</li> </ol>	

### Clone the repository in SageMaker Studio for Account B

Task	Description	Skills required
<p>Create the shell script in SageMaker Studio in Account B.</p>	<ol style="list-style-type: none"> <li>1. In the navigation pane of the <a href="#">SageMaker console</a>, choose <b>Studio</b>.</li> <li>2. Select your user profile and then choose <b>Open Studio</b>.</li> <li>3. In the <b>Home</b> section, choose <b>Open Launcher</b>.</li> <li>4. In the <b>Utilities and files</b> section, choose <b>Text file</b>.</li> <li>5. Copy the script from <i>Example SageMaker shell script</i> in the <a href="#">Additional information</a> section of this pattern, and then paste the statement into the new file. Make sure to replace</li> </ol>	<p>AWS DevOps</p>

Task	Description	Skills required
	<p>all placeholder values in the script.</p> <p>6. Right-click the <b>untitled.txt</b> tab of your new file, and then choose <b>Rename Text</b>. For <b>New Name</b>, enter <b>cross_account_git_clone.sh</b>, and then choose <b>Rename</b>.</p>	
<p>Invoke the shell script from the system terminal.</p>	<ol style="list-style-type: none"> <li>1. In the <b>Home</b> section of the <a href="#">SageMaker console</a>, choose <b>Open Launcher</b>.</li> <li>2. In the <b>Utilities and files</b> section, choose <b>System terminal</b>.</li> <li>3. In the terminal, run the following command: <div data-bbox="630 1108 1029 1306" style="border: 1px solid #ccc; border-radius: 10px; padding: 10px; margin: 10px 0;"> <pre>chmod u+x ./cross_a ccount_git_clone.s h &amp;&amp; ./cross_a ccount_git_clone.sh</pre> </div> </li> </ol> <p>You have cloned your CodeCommit repository in a SageMaker Studio cross-account. You can now perform all Git commands from the system terminal.</p>	<p>AWS DevOps</p>

## Additional information

### Example IAM policy

If you use this example policy, do the following:

- Replace <CodeCommit\_Repository\_Region> with the AWS Region for the repository.
- Replace <Account\_A\_ID> with the account ID for Account A.
- Replace <CodeCommit\_Repository\_Name> with the name of your CodeCommit repository in Account A.

```
{
  "Version": "2012-10-17",
  "Statement": [
    {
      "Effect": "Allow",
      "Action": [
        "codecommit:BatchGet*",
        "codecommit:Create*",
        "codecommit>DeleteBranch",
        "codecommit:Get*",
        "codecommit:List*",
        "codecommit:Describe*",
        "codecommit:Put*",
        "codecommit:Post*",
        "codecommit:Merge*",
        "codecommit:Test*",
        "codecommit:Update*",
        "codecommit:GitPull",
        "codecommit:GitPush"
      ],
      "Resource": [
        "arn:aws:codecommit:<CodeCommit_Repository_Region>:<Account_A_ID>:<CodeCommit_Repository_Name>"
      ]
    }
  ]
}
```

### Example SageMaker shell script

If you use this example script, do the following:

- Replace <Account\_A\_ID> with the account ID for Account A.
- Replace <Account\_A\_Role\_Name> with the name of the IAM role that you created earlier.

- Replace `<CodeCommit_Repository_Region>` with the AWS Region for the repository.
- Replace `<CodeCommit_Repository_Name>` with the name of your CodeCommit repository in Account A.

```
#!/usr/bin/env bash
#Launch from system terminal
pip install --quiet git-remote-codecommit

mkdir -p ~/.aws
touch ~/.aws/config

echo "[profile CrossAccountAccessProfile]
region = <CodeCommit_Repository_Region>
credential_source=EcsContainer
role_arn = arn:aws:iam::<Account_A_ID>:role/<Account_A_Role_Name>
output = json" > ~/.aws/config

echo '[credential "https://git-
codecommit.<CodeCommit_Repository_Region>.amazonaws.com"]
    helper = !aws codecommit credential-helper $@ --profile
CrossAccountAccessProfile
    UseHttpPath = true' > ~/.gitconfig

git clone codecommit::<CodeCommit_Repository_Region>://
CrossAccountAccessProfile@<CodeCommit_Repository_Name>
```



# Automate Amazon Lookout for Vision training and deployment for anomaly detection

Created by Michael Wallner (AWS), Gabriel Rodriguez Garcia (AWS), Kangkang Wang (AWS), Shukhrat Khodjaev (AWS), Sanjay Ashok (AWS), Yassine Zaafouri (AWS), and Gabriel Zylka (AWS)

**Code repository:** [automated-silicon-wafer-anomaly-detection-using-amazon-lookout-for-vision](#)

**Environment:** Production

**Technologies:** Machine learning & AI; CloudNative; DevOps

**AWS services:** AWS CloudFormation; AWS CodeBuild; AWS CodeCommit; AWS CodePipeline; AWS Lambda; Amazon Lookout for Vision

## Summary

This pattern helps you automate the training and deployment of [Amazon Lookout for Vision](#) machine learning models for visual inspection. Although this pattern concentrates on anomaly detection for silicon wafers, you can adapt the solution for use in a wide range of products and industries.

In 2020, the annual capacity of one of the largest semiconductor manufacturers in the world exceeded 12 million 12-inch equivalent wafers. To ensure the quality and reliability of these wafers, visual inspection is an essential step in the production process. The traditional methods of visual inspection, such as manual sampling or the use of outdated, legacy tools that rely on statistical measures, can be time-consuming and inefficient. Given the scale of this process and its importance to the broader semiconductor industry, there is a significant opportunity to optimize and automate visual inspection by using advanced artificial intelligence (AI) technologies.

Lookout for Vision helps streamline the image and object inspection process, reducing the need for costly and inconsistent manual inspection. This solution improves quality control, facilitates

accurate defect and damage assessment, and ensures compliance with industry standards. Additionally, you can automate the Lookout for Vision inspection process, without specialized machine learning expertise.

Using this solution, you can integrate your computer vision model into any system. For instance, you might integrate a model into a website where users upload images and analyze them for defects. The following image shows an example of a silicon wafer with scratch defects from a chemical mechanical polishing (CMP) process. You can use Lookout for Vision to detect these anomalies. For example, Lookout for Vision detected anomalies in this image with 99.04% confidence.

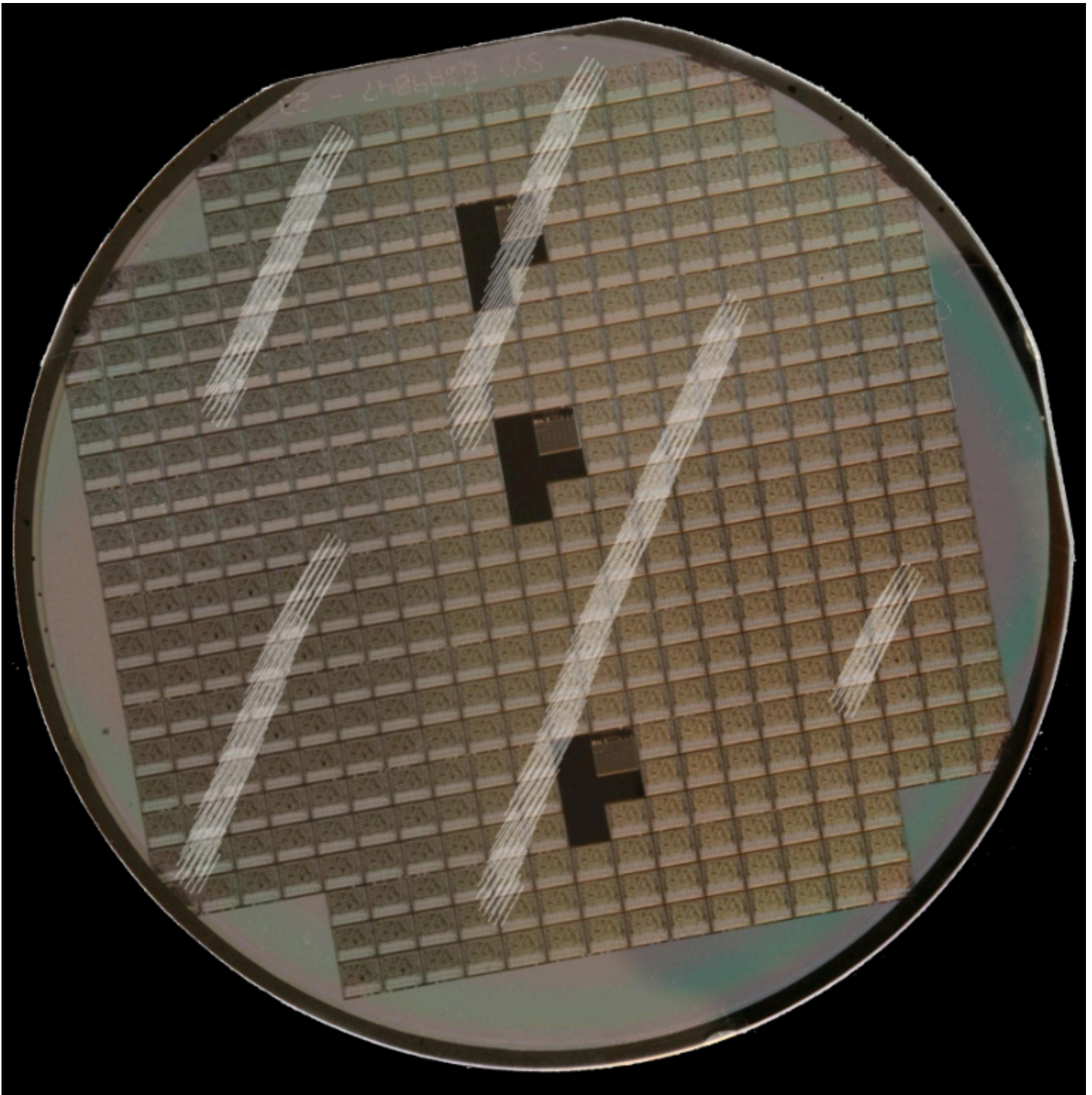

This solution is based on the code and the use case described in the [Build an event-based tracking solution using Amazon Lookout for Vision blog post](#). This solution modifies the original code to enable CI/CD pipeline automation and to integrate the open source [Amazon Lookout for Vision Python SDK](#) (GitHub). For more information about the Python SDK, see the [Build, train, and deploy Amazon Lookout for Vision models using the Python SDK](#) blog post.

# Prerequisites and limitations

## Prerequisites

- An active AWS account
- Administrative permissions in the AWS account
- AWS Command Line Interface (AWS CLI), [installed](#) and [configured](#)
- AWS CDK, [installed and configured](#)
- Python version 3.10, [installed](#)

## Architecture

### Target architecture

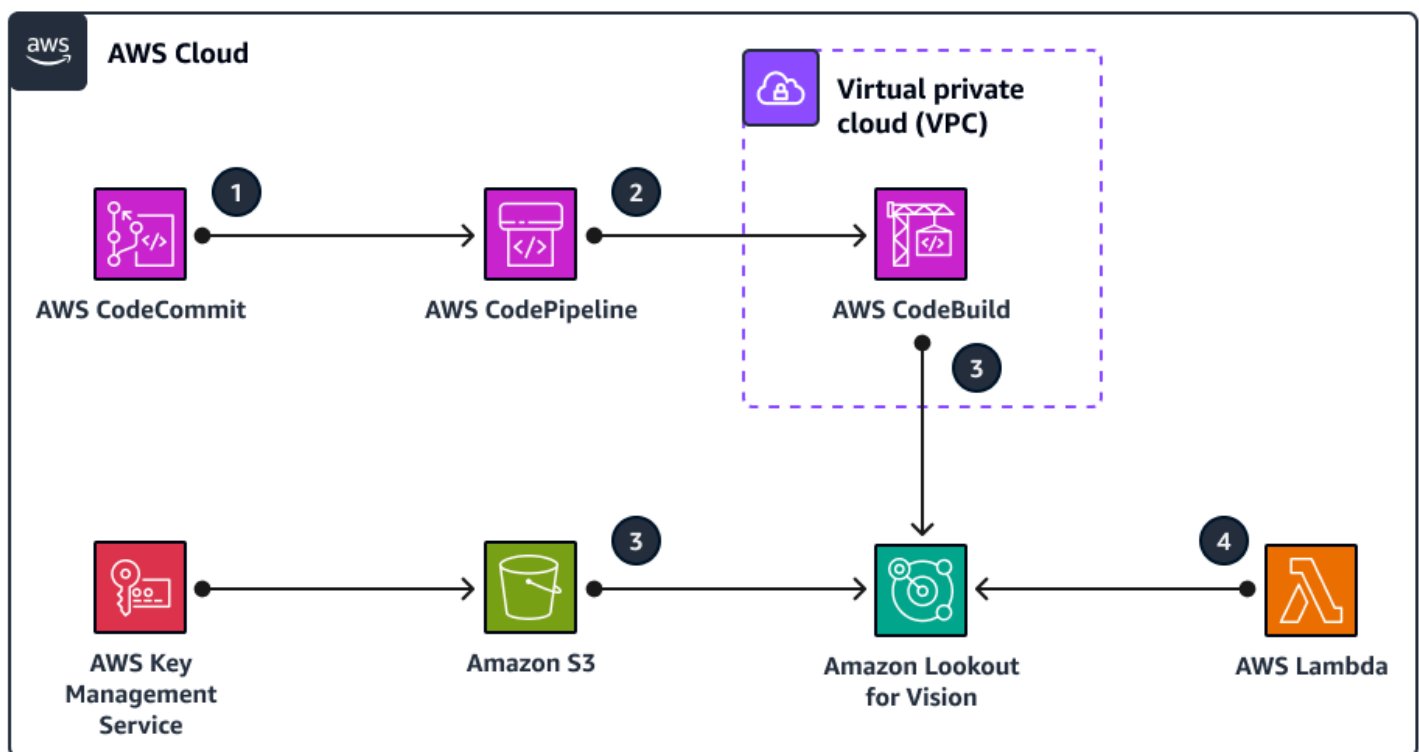

This architecture illustrates automation of build, train and deployment of Amazon Lookout for Vision models through a CI/CD pipeline. The diagram shows the following workflow:

1. The code is stored in an Amazon CodeCommit repository. Developers can modify the code, change input images, or add other steps to the automation pipeline.

2. After deploying the solution or updating the main branch of the CodeCommit repository, Amazon CodePipeline automatically pushes the code into Amazon CodeBuild.
3. CodeBuild uses the Lookout for Vision Python SDK to train and deploy the images classification model. The images used for training are stored in an Amazon Simple Storage Service (Amazon S3) bucket. CodeBuild automatically downloads these images and stores them. To customize the solution to your needs, you can import your own images.
4. The Lookout for Vision model is exposed to end users through AWS Lambda. However, you are not limited to this approach. You can also deploy Lookout for Vision at the edge on IoT devices, or you can run it as batch process on a scheduled basis to generate predictions.

## Tools

### AWS services

- [AWS CodeBuild](#) is a fully managed build service that helps you compile source code, run unit tests, and produce artifacts that are ready to deploy.
- [AWS CodeCommit](#) is a version control service that helps you privately store and manage Git repositories, without needing to manage your own source control system.
- [AWS CodePipeline](#) helps you quickly model and configure the different stages of a software release and automate the steps required to release software changes continuously.
- [AWS Key Management Service \(AWS KMS\)](#) helps you create and control cryptographic keys to help protect your data.
- [AWS Lambda](#) is a compute service that helps you run code without needing to provision or manage servers. It runs your code only when needed and scales automatically, so you pay only for the compute time that you use.
- [Amazon Lookout for Vision](#) uses computer vision to find visual defects in industrial products, accurately and at scale.
- [Amazon Simple Storage Service \(Amazon S3\)](#) is a cloud-based object storage service that helps you store, protect, and retrieve any amount of data.

### Code repository

The code for this pattern is available in the GitHub [Automate Amazon Lookout for Vision training and deployment for Silicon Wafer Anomaly Detection](#) repository.

## Best practices

When running the code as an experiment, make sure to [stop your Amazon Lookout for Vision endpoint](#).

## Epics

### Deploy the solution

Task	Description	Skills required
Clone the GitHub repository.	<p>Clone the GitHub <a href="#">Automate Amazon Lookout for Vision training and deployment for Silicon Wafer Anomaly Detection</a> repository to your local workstation.</p> <pre>git clone https://github.com/aws-samples/automated-silicon-wafer-anomaly-detection-using-amazon-lookout-for-vision.git</pre>	Bash
Create a virtual environment.	<p>Enter the following command to create a virtual environment on your local workstation.</p> <pre>python3 -m venv .venv</pre>	Python
Install dependencies.	<p>After the virtual environment is created, enter the following command to install the required dependencies.</p>	Python

Task	Description	Skills required
	<pre>pip install -r requirements.txt</pre>	
(Linux users only) Activate the virtual environment.	<p>After the initialization is completed and the virtual environment is created, use the following command to activate the virtual environment.</p> <pre>source .venv/bin/activate</pre>	Bash
(Windows users only) Activate the virtual environment.	<p>After the initialization is completed and the virtual environment is created, use the following command to activate the virtual environment.</p> <pre>.venv\Scripts\activate.bat</pre>	PowerShell

Task	Description	Skills required
Deploy the stack.	<ol style="list-style-type: none"> <li>In the AWS CDK CLI, enter the following command to synthesize the AWS CloudFormation template.           <pre>cdk synth</pre> </li> <li>Enter the following command to deploy the CloudFormation stack.           <pre>cdk deploy --all --require-approval never</pre> <p>The <code>--all</code> flag ensures that all components are installed at once. <code>--require-approval never</code> eliminates the need to approve each component deployment.</p> </li> </ol>	AWS administrator

## Test the solution

Task	Description	Skills required
Enter an example test event.	<ol style="list-style-type: none"> <li>Open the <a href="#">Functions page</a> of the Lambda console.</li> <li>Choose the <code>amazon-lookout-for-vision-project-lambda</code> function.</li> <li>Choose the <b>Test</b> tab.</li> </ol>	General AWS



Task	Description	Skills required
	<p>4. Under <b>Test event</b>, choose <b>Create new event</b>.</p> <p>5. Enter the following.</p> <p>6. Choose <b>Test</b>.</p> <pre data-bbox="630 445 1029 604">{   "tbd": "tbd" }</pre> <p>7. To review the test results, under <b>Execution result</b>, expand <b>Details</b>.</p>	

## Related resources

### AWS documentation

- [Getting started with Amazon Lookout for Vision](#)
- [Getting started with AWS CDK](#)

### AWS blog posts

- [Build, train, and deploy Amazon Lookout for Vision models using the Python SDK](#)
- [Build an event-based tracking solution using Amazon Lookout for Vision](#)
- [Amazon Lookout for Vision Python SDK: Cross-validation and Integration with Other AWS Services](#)

# Automatically extract content from PDF files using Amazon Textract

*Created by Tianxia Jia (AWS)*

**Environment:** Production

**Technologies:** Machine learning & AI; Analytics; Big data

**AWS services:** Amazon S3; Amazon Textract; Amazon SageMaker

## Summary

Many organizations need to extract information from PDF files that are uploaded to their business applications. For example, an organization could need to accurately extract information from tax or medical PDF files for tax analysis or medical claim processing.

On the Amazon Web Services (AWS) Cloud, Amazon Textract automatically extracts information (for example, printed text, forms, and tables) from PDF files and produces a JSON-formatted file that contains information from the original PDF file. You can use Amazon Textract in the AWS Management Console or by implementing API calls. We recommend that you use [programmatic API calls](#) to scale and automatically process large numbers of PDF files.

When Amazon Textract processes a file, it creates the following list of Block objects: pages, lines and words of text, forms (key-value pairs), tables and cells, and selection elements. Other object information is also included, for example, [bounding boxes](#), confidence intervals, IDs, and relationships. Amazon Textract extracts the content information as strings. Correctly identified and transformed data values are required because they can be more easily used by your downstream applications.

This pattern describes a step-by-step workflow for using Amazon Textract to automatically extract content from PDF files and process it into a clean output. The pattern uses a template matching technique to correctly identify the required field, key name, and tables, and then applies post-processing corrections to each data type. You can use this pattern to process different types of PDF files and you can then scale and automate this workflow to process PDF files that have an identical format.

## Prerequisites and limitations

### Prerequisites

- An active AWS account.
- An existing Amazon Simple Storage Service (Amazon S3) bucket to store the PDF files after they are converted to JPEG format for processing by Amazon Textract. For more information about S3 buckets, see [Buckets overview](#) in the Amazon S3 documentation.
- The `Textract_PostProcessing.ipynb` Jupyter notebook (attached), installed and configured. For more information about Jupyter notebooks, see [Create a Jupyter notebook](#) in the Amazon SageMaker documentation.
- Existing PDF files that have an identical format.
- An understanding of Python.

### Limitations

- Your PDF files must be of good quality and clearly readable. Native PDF files are recommended, but you can use scanned documents that are converted to a PDF format if all the individual words are clear. For more information about this, see [PDF document preprocessing with Amazon Textract: Visuals detection and removal](#) on the AWS Machine Learning Blog.
- For multipage files, you can use an asynchronous operation or split the PDF files into a single page and use a synchronous operation. For more information about these two options, see [Detecting and analyzing text in multipage documents](#) and [Detecting and analyzing text in single-page documents](#) in the Amazon Textract documentation.

## Architecture

This pattern's workflow first runs Amazon Textract on a sample PDF file (*First-time run*) and then runs it on PDF files that have an identical format to the first PDF (*Repeat run*). The following diagram shows the combined *First-time run* and *Repeat run* workflow that automatically and repeatedly extracts content from PDF files with identical formats.

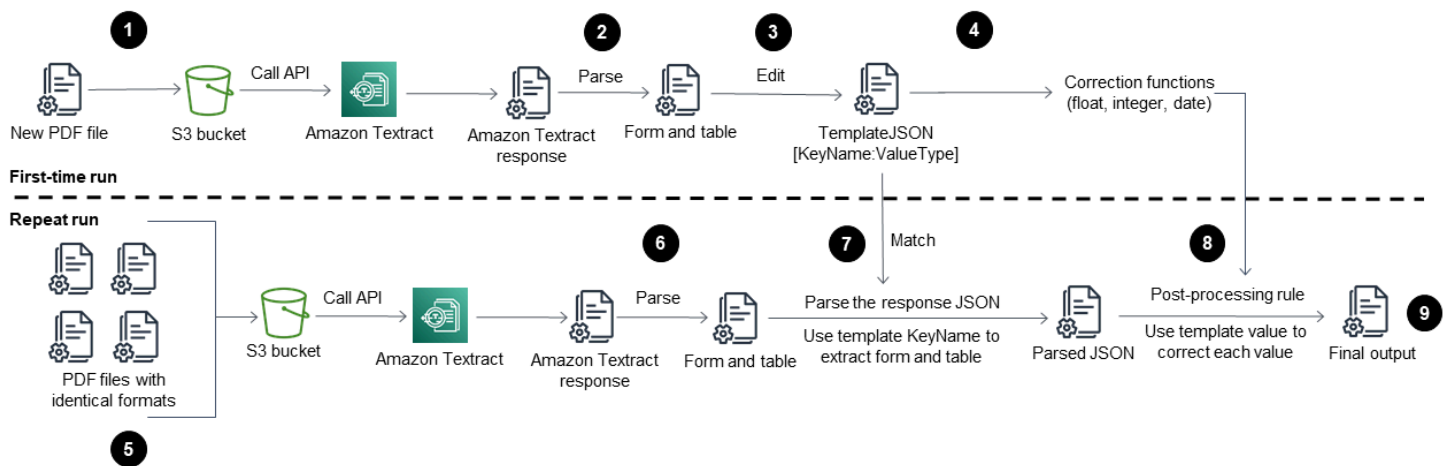

The diagram shows the following workflow for this pattern:

1. Convert a PDF file into JPEG format and store it in an S3 bucket.
2. Call the Amazon Textract API and parse the Amazon Textract response JSON file.
3. Edit the JSON file by adding the correct `KeyName:DataType` pair for each required field. Create a `TemplateJSON` file for the *Repeat run* stage.
4. Define the post-processing correction functions for each data type (for example, float, integer, and date).
5. Prepare the PDF files that have an identical format to your first PDF file.
6. Call the Amazon Textract API and parse the Amazon Textract response JSON.
7. Match the parsed JSON file with the `TemplateJSON` file.
8. Implement post-processing corrections.

The final JSON output file has the correct `KeyName` and `Value` for each required field.

### Target technology stack

- Amazon SageMaker
- Amazon S3
- Amazon Textract

### Automation and scale

You can automate the *Repeat run* workflow by using an AWS Lambda function that initiates Amazon Textract when a new PDF file is added to Amazon S3. Amazon Textract then runs the

processing scripts and the final output can be saved to a storage location. For more information about this, see [Using an Amazon S3 trigger to invoke a Lambda function](#) in the Lambda documentation.

## Tools

- [Amazon SageMaker](#) is a fully managed ML service that helps you to quickly and easily build and train ML models, and then directly deploy them into a production-ready hosted environment.
- [Amazon Simple Storage Service \(Amazon S3\)](#) is a cloud-based object storage service that helps you store, protect, and retrieve any amount of data.
- [Amazon Textract](#) makes it easy to add document text detection and analysis to your applications.

## Epics

### First-time run

Task	Description	Skills required
Convert the PDF file.	<p>Prepare the PDF file for your first-time run by splitting it into a single page and converting it into JPEG format for the Amazon Textract <a href="#">synchronous operation</a> (Syn API).</p> <p><b>Note:</b> You can also use the Amazon Textract <a href="#">asynchronous operation</a> (Asyn API) for multipage PDF files.</p>	Data scientist, Developer
Parse the Amazon Textract response JSON.	<p>Open the <code>Texttract_PostProcessing.ipynb</code> Jupyter notebook (attached) and call the Amazon Textract API by using the following code:</p>	Data scientist, Developer

Task	Description	Skills required
	<pre data-bbox="609 226 1027 762"> response = textract. analyze_document( Document={     'S3Object': {         'Bucket': BUCKET,         'Name': '{}'.format(filename)     } }, FeatureTy pes=["TABLES", "FORMS"]) </pre> <p data-bbox="591 804 1021 930">Parse the response JSON into a form and table by using the following code:</p> <pre data-bbox="609 972 1027 1203"> parseformKV=form_k v_from_JSON(response) parseformTable s=get_tables_fromJ SON(response) </pre>	
<p data-bbox="115 1247 516 1283">Edit the TemplateJSON file.</p>	<p data-bbox="591 1247 1024 1570">Edit the parsed JSON for each KeyName and corresponding DataType (for example, string, float, integer, or date), and table headers (for example, ColumnNames and RowNames).</p> <p data-bbox="591 1612 1029 1843">This template is used for each individual PDF file type, which means that the template can be reused for PDF files that have an identical format.</p>	<p data-bbox="1068 1247 1430 1283">Data scientist, Developer</p>

Task	Description	Skills required
Define the post-processing correction functions.	<p>The values in Amazon Textract's response for the TemplateJSON file are strings. There is no differentiation for date, float, integer, or currency. These values must be converted to the correct data type for your downstream use case.</p> <p>Correct each data type according to the TemplateJSON file by using the following code:</p> <pre data-bbox="597 905 1027 1104">finalJSON=postprocessingCorrection(parsedJSON,templateJSON)</pre>	Data scientist, Developer

## Repeat run

Task	Description	Skills required
Prepare the PDF files.	<p>Prepare the PDF files by splitting them into a single page and converting them into JPEG format for the Amazon Textract <a href="#">synchronous operation</a> (Syn API).</p> <p><b>Note:</b> You can also use the Amazon Textract <a href="#">asynchron</a></p>	Data scientist, Developer

Task	Description	Skills required
	<a href="#">ous operation</a> (Asyn API) for multipage PDF files.	
Call the Amazon Textract API.	Call the Amazon Textract API by using the following code: <pre data-bbox="597 457 1026 1018">response = textract. analyze_document(     Document={         'S3Object': {             'Bucket': BUCKET,             'Name': '{}'.format(filename)         }     },     FeatureTy pes=["TABLES", "FORMS"])</pre>	Data scientist, Developer
Parse the Amazon Textract response JSON.	Parse the response JSON into a form and table by using the following code: <pre data-bbox="597 1220 1026 1459">parseformKV=form_k v_from_JSON(response) parseformTable s=get_tables_fromJ SON(response)</pre>	Data scientist, Developer



Task	Description	Skills required
Load the TemplateJSON file and match it with the parsed JSON.	<p>Use the TemplateJSON file to extract the correct key-value pairs and table by using the following commands:</p> <pre data-bbox="602 443 1027 961">form_kv_corrected= form_kv_correction (parseformKV,templ ateJSON) form_table_correct ed=form_Table_corr ection(parseformTa bles, templateJSON) form_kv_table_correc ted_final=**form_kv _corrected , **form_ta ble_corrected}</pre>	Data scientist, Developer
Post-processing corrections.	<p>Use DataType in the TemplateJSON file and post-processing functions to correct data by using the following code:</p> <pre data-bbox="602 1262 1027 1499">finalJSON=postproc essingCorrection(f orm_kv_table_corre cted_final,templat eJSON)</pre>	Data scientist, Developer

## Related resources

- [Automatically extract text and structured data from documents with Amazon Textract](#)
- [Extract text and structured data with Amazon Textract](#)
- [Amazon Textract resources](#)

## Attachments

To access additional content that is associated with this document, unzip the following file:

[attachment.zip](#)

# Build an MLOps workflow by using Amazon SageMaker and Azure DevOps

*Created by Deepika Kumar (AWS) and Sara van de Moosdijk (AWS)*

**Environment:** Production

**Technologies:** Machine learning & AI; DevOps; Operations

**Workload:** Microsoft

**AWS services:** Amazon API Gateway; Amazon ECR; Amazon EventBridge; AWS Lambda; Amazon SageMaker

## Summary

Machine learning operations (MLOps) is a set of practices that automate and simplify machine learning (ML) workflows and deployments. MLOps focuses on automating the ML lifecycle. It helps ensure that models are not just developed but also deployed, monitored, and retrained systematically and repeatedly. It brings DevOps principles to ML. MLOps results in faster deployment of ML models, better accuracy over time, and stronger assurance that they provide real business value.

Organizations often have existing DevOps tools and data storage solutions before starting their MLOps journey. This pattern showcases how to harness the strengths of both Microsoft Azure and AWS. It helps you integrate Azure DevOps with Amazon SageMaker to create an MLOps workflow.

The solution simplifies working between Azure and AWS. You can use Azure for development and AWS for machine learning. It promotes an effective process for making machine learning models from start to finish, including data handling, training, and deployment on AWS. For efficiency, you manage these processes through Azure DevOps pipelines.

## Prerequisites and limitations

### Prerequisites

- **Azure subscription** – Access to Azure services, such as Azure DevOps, for setting up the continuous integration and continuous deployment (CI/CD) pipelines.
- **Active AWS account** – Permissions to use the AWS services used in this pattern.
- **Data** – Access to historical data for training the machine learning model.
- **Familiarity with ML concepts** – Understanding of Python, Jupyter Notebooks, and machine learning model development.
- **Security configuration** – Proper configuration of roles, policies, and permissions across both Azure and AWS to ensure secure data transfer and access.

## Limitations

- This guidance does not provide guidance on secure cross-cloud data transfers. For more information about cross-cloud data transfers, see [AWS Solutions for Hybrid and Multicloud](#).
- Multicloud solutions may increase latency for real-time data processing and model inference.
- This guidance provides one example of a multi-account MLOps architecture. Adjustments are necessary based on your machine learning and AWS strategy.

## Architecture

### Target architecture

The target architecture integrates Azure DevOps with Amazon SageMaker, creating a cross-cloud ML workflow. It uses Azure for CI/CD processes and SageMaker for ML model training and deployment. It outlines the process of obtaining data (from sources such as Amazon S3, Snowflake, and Azure Data Lake) through model building and deployment. Key components include CI/CD pipelines for model building and deployment, data preparation, infrastructure management, and Amazon SageMaker for training, evaluation, and deployment of ML models. This architecture is designed to provide efficient, automated, and scalable ML workflows across cloud platforms.

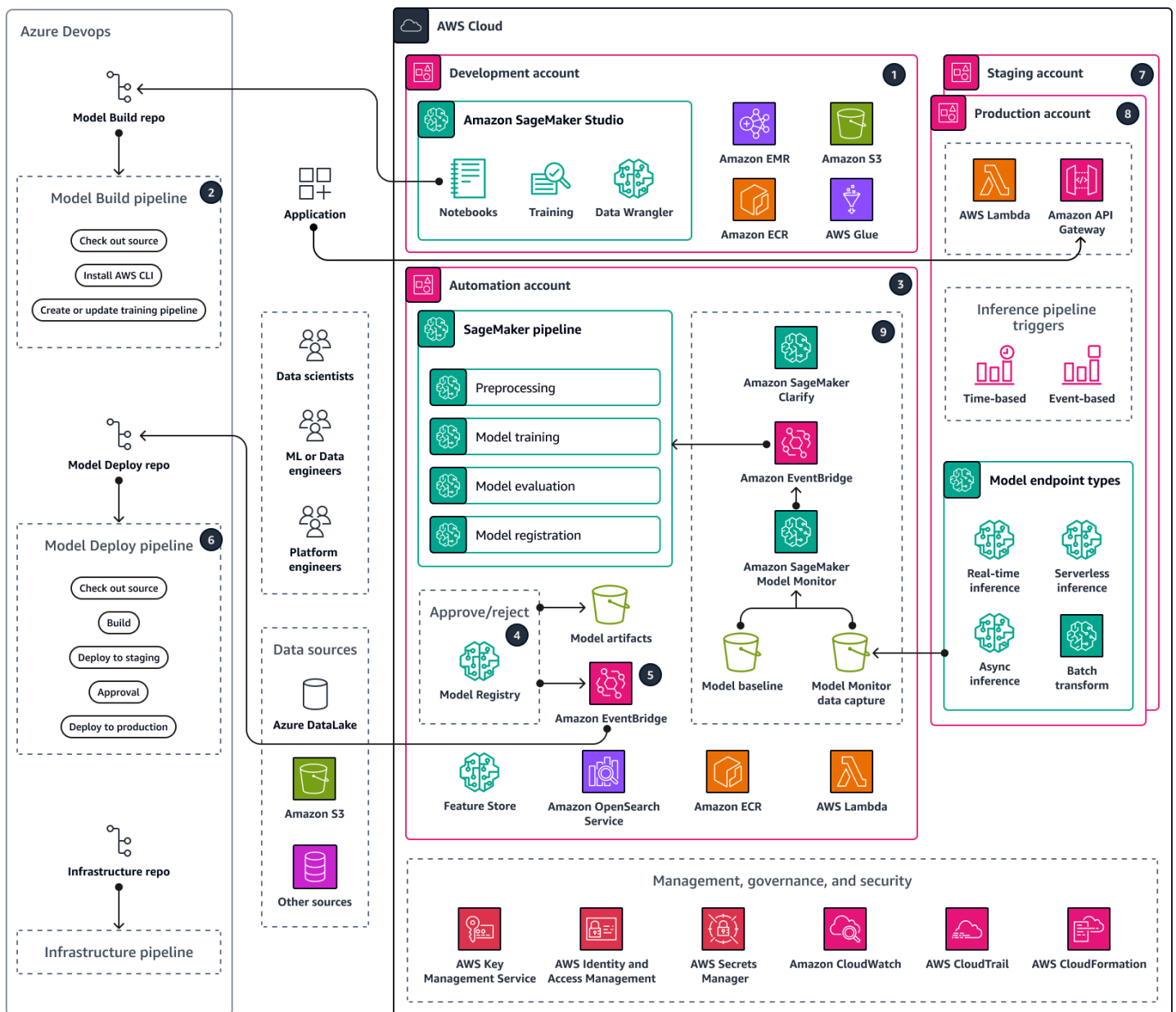

The architecture consists of the following components:

1. Data scientists perform ML experiments in the development account to explore different approaches for ML use cases by using various data sources. Data scientists perform unit tests and trials. Following model evaluation, Data scientists push and merge the code to the Model Build repository, which is hosted on Azure DevOps. This repository contains code for a multi-step model building pipeline.
2. On Azure DevOps, the Model Build Pipeline, which provides continuous integration (CI), can be activated automatically or manually upon code merge to the main branch. In the Automation

- account, this activates the SageMaker pipeline for data preprocessing, model training and evaluation, and conditional model registration based on accuracy.
3. The Automation account is a central account across ML platforms that hosts ML environments (Amazon ECR), models (Amazon S3), model metadata (SageMaker Model Registry), features (SageMaker Feature Store), automated pipelines (SageMaker Pipelines), and ML log insights (CloudWatch and OpenSearch Service). This account allows reusability of ML assets and enforces best practices to accelerate delivery of ML use cases.
  4. The latest model version is added to SageMaker Model Registry for review. It tracks model versions and respective artifacts (lineage and metadata). It also manages the status of the model (approve, reject, or pending), and it manages the version for downstream deployment.
  5. After a trained model in Model Registry is approved through the studio interface or an API call, an event can be dispatched to Amazon EventBridge. EventBridge starts the Model Deploy pipeline on Azure DevOps.
  6. The Model Deploy pipeline, which provides continuous deployment (CD), checks out the source from the Model Deploy repository. The source contains code, the configuration for the model deployment, and test scripts for quality benchmarks. The Model Deploy pipeline can be tailored to your inference type.
  7. After quality control checks, the Model Deploy pipeline deploys the model to the Staging account. The Staging account is a copy of the Production account, and it is used for integration testing and evaluation. For a batch transformation, the Model Deploy pipeline can automatically update the batch inference process to use the latest approved model version. For a real-time, serverless, or asynchronous inference, it sets up or updates the respective model endpoint.
  8. After successful testing in the Staging account, a model can be deployed to the Production account by manual approval through the Model Deploy pipeline. This pipeline provisions a production endpoint in the **Deploy to production** step, including model monitoring and a data feedback mechanism.
  9. After the model is in production, use tools such as SageMaker Model Monitor and SageMaker Clarify to identify bias, detect drift, and continuously monitor the model's performance.

## Automation and scale

Use infrastructure as code (IaC) to automatically deploy to multiple accounts and environments. By automating the process of setting up an MLOps workflow, it is possible to separate the environments used by ML teams working on different projects. [AWS CloudFormation](#) helps you model, provision, and manage AWS resources by treating infrastructure as code.

# Tools

## AWS services

- [Amazon SageMaker](#) is a managed ML service that helps you build and train ML models and then deploy them into a production-ready hosted environment.
- [AWS Glue](#) is a fully managed extract, transform, and load (ETL) service. It helps you reliably categorize, clean, enrich, and move data between data stores and data streams.
- [Amazon Simple Storage Service \(Amazon S3\)](#) is a cloud-based object storage service that helps you store, protect, and retrieve any amount of data. In this pattern, Amazon S3 is used for data storage and integrated with SageMaker for model training and model objects.
- [AWS Lambda](#) is a compute service that helps you run code without needing to provision or manage servers. It runs your code only when needed and scales automatically, so you pay only for the compute time that you use. In this pattern, Lambda is used for data pre-processing and post-processing tasks.
- [Amazon Elastic Container Registry \(Amazon ECR\)](#) is a managed container image registry service that's secure, scalable, and reliable. In this pattern, it stores Docker containers that SageMaker uses as training and deployment environments.
- [Amazon EventBridge](#) is a serverless event bus service that helps you connect your applications with real-time data from a variety of sources. In this pattern, EventBridge orchestrates event-driven or time-based workflows that initiate automatic model retraining or deployment.
- [Amazon API Gateway](#) helps you create, publish, maintain, monitor, and secure REST, HTTP, and WebSocket APIs at any scale. In this pattern, it is used to create an external-facing, single point of entry for Amazon SageMaker endpoints.

## Other tools

- [Azure DevOps](#) helps you manage CI/CD pipelines and facilitate code builds, tests, and deployment.
- [Azure Data Lake Storage](#) or [Snowflake](#) are possible third-party sources of training data for ML models.

## Best practices

Before implementing any component of this multicloud MLOps workflow, complete the following activities:

- Define and understand the machine learning workflow and the tools required to support it. Different use cases require different workflows and components. For example, a feature store might be required for feature reuse and low latency inference in a personalization use case, but it may not be required for other use cases. Understanding the target workflow, use case requirements, and preferred collaboration methods of the data science team is needed to successfully customize the architecture.
- Create a clear separation of responsibility for each component of the architecture. Spreading data storage across Azure Data Lake Storage, Snowflake, and Amazon S3 can increase complexity and cost. If possible, choose a consistent storage mechanism. Similarly, avoid using a combination of Azure and AWS DevOps services, or a combination of Azure and AWS ML services.
- Choose one or more existing models and datasets to perform end-to-end testing of the MLOps workflow. The test artifacts should reflect real use cases that the data science teams develop when the platform enters production.

## Epics

### Design your MLOps architecture

Task	Description	Skills required
Identify data sources.	Based on current and future use cases, available data sources, and types of data (such as confidential data), document the data sources that need to be integrated with the MLOps platform. Data can be stored in Amazon S3, Azure Data Lake Storage, Snowflake, or other sources. Create a plan for integrati	Data engineer, Data scientist, Cloud architect



Task	Description	Skills required
	ng these sources with your platform and securing access to the correct resources.	
Choose applicable services.	Customize the architecture by adding or removing services based on the desired workflow of the data science team, applicable data sources, and existing cloud architecture. For example, data engineers and data scientists may perform data preprocessing and feature engineering in SageMaker, AWS Glue, or Amazon EMR. It is unlikely that all three services would be required.	AWS administrator, Data engineer, Data scientist, ML engineer

Task	Description	Skills required
Analyze security requirements.	<p>Gather and document security requirements. This includes determining:</p> <ul style="list-style-type: none"><li>• Which teams or engineers can access specific data sources</li><li>• Whether teams are allowed to access the code and models of other teams</li><li>• Which permissions (if any) team members should have for non-development accounts</li><li>• Which security measures need to be implemented for cross-cloud data transfer</li></ul>	AWS administrator, Cloud architect

## Set up AWS Organizations

Task	Description	Skills required
Set up AWS Organizations.	<p>Set up AWS Organizations on the root AWS account. This helps you manage the subsequent accounts that you create as part of a multi-account MLOps strategy. For more information, see the <a href="#">AWS Organizations documentation</a>.</p>	AWS administrator

## Set up the development environment and versioning

Task	Description	Skills required
Create an AWS development account.	Create an AWS account where data engineers and data scientists have permissions to experiment and create ML models. For instructions, see <a href="#">Creating a member account in your organization</a> in the AWS Organizations documentation.	AWS administrator
Create a Model Build repository.	Create a Git repository in Azure where data scientists can push their model build and deployment code after the experimentation phase is complete. For instructions, see <a href="#">Set up a Git repository</a> in the Azure DevOps documentation.	DevOps engineer, ML engineer
Create a Model Deploy repository.	Create a Git repository in Azure that stores standard deployment code and templates. It should include code for every deployment option that the organization uses, as identified in the design phase. For example, it should include real-time endpoints, asynchronous endpoints, serverless inference, or batch transforms. For instructions, see <a href="#">Set up</a>	DevOps engineer, ML engineer

Task	Description	Skills required
	<a href="#">a Git repository</a> in the Azure DevOps documentation.	
Create an Amazon ECR repository.	Set up an Amazon ECR repository that stores the approved ML environments as Docker images. Allow data scientists and ML engineers to define new environments. For instructions, see <a href="#">Creating a private repository</a> in the Amazon ECR documentation.	ML engineer
Set up SageMaker Studio.	Set up SageMaker Studio on the development account according to the previously defined security requirements and preferred data science tools, such as your choice of integrated development environment (IDE). Use lifecycle configurations to automate the installation of key functionality and create a uniform development environment for data scientists. For more information, see <a href="#">Amazon SageMaker Studio</a> in the SageMaker documentation.	ML engineer, Data scientist

## Integrate CI/CD pipelines

Task	Description	Skills required
Create an Automation account.	Create an AWS account where automated pipelines and jobs run. You can give data science teams read access to this account. For instructions, see <a href="#">Creating a member account in your organization</a> in the AWS Organizations documentation.	AWS administrator
Set up a model registry.	Set up SageMaker Model Registry in the Automation account. This registry stores the metadata for ML models and helps certain data scientists or team leads to approve or reject models. For more information, see <a href="#">Register and deploy models with Model Registry</a> in the SageMaker documentation.	ML engineer
Create a Model Build pipeline.	Create a CI/CD pipeline in Azure that starts manually or automatically when code is pushed to the Model Build repository. The pipeline should check out the source code and create or update a SageMaker pipeline in the Automation account. The pipeline should add a new model to the model registry.	DevOps engineer, ML engineer

Task	Description	Skills required
	For more information about creating a pipeline, see the <a href="#">Azure Pipelines documentation</a> .	

## Build the deployment stack

Task	Description	Skills required
Create AWS staging and deployment accounts.	Create AWS accounts for staging and deployment of ML models. These accounts should be identical to allow for accurate testing of the models in staging before moving to production. You can give data science teams read access to the staging account. For instructions, see <a href="#">Creating a member account in your organization</a> in the AWS Organizations documentation.	AWS administrator
Set up S3 buckets for model monitoring.	Complete this step if you want to enable model monitoring for the deployed models that are created by the Model Deploy pipeline. Create Amazon S3 buckets for storing the input and output data. For more information about creating S3 buckets, see <a href="#">Creating a bucket</a> in the Amazon	ML engineer

Task	Description	Skills required
	S3 documentation. Set up cross-account permissions so that the automated model monitoring jobs run in the Automation account. For more information, see <a href="#">Monitor data and model quality</a> in the SageMaker documentation.	
Create a Model Deploy pipeline.	Create a CI/CD pipeline in Azure that starts when a model is approved in the model registry. The pipeline should check out the source code and model artifact, build the infrastructure templates for deploying the model in the staging and production accounts, deploy the model in the staging account, run automated tests, wait for manual approval, and deploy the approved model into the production account. For more information about creating a pipeline, see the <a href="#">Azure Pipelines documentation</a> .	DevOps engineer, ML engineer

### (Optional) Automate ML environment infrastructure

Task	Description	Skills required
Build AWS CDK or CloudFormation templates.	Define AWS Cloud Development Kit (AWS CDK) or AWS	AWS DevOps

Task	Description	Skills required
	<p>CloudFormation templates for all environments that need to be deployed automatically. This might include the development environment, automation environment, and staging and deployment environments. For more information, see the <a href="#">AWS CDK</a> and <a href="#">CloudFormation</a> documentation.</p>	
<p>Create an Infrastructure pipeline.</p>	<p>Create a CI/CD pipeline in Azure for infrastructure deployment. An administrator can initiate this pipeline to create new AWS accounts and set up the environments that the ML team requires.</p>	<p>DevOps engineer</p>

## Troubleshooting

Issue	Solution
<p><b>Insufficient monitoring and drift detection</b> – Inadequate monitoring can lead to missed detection of model performance issues or data drift.</p>	<p>Strengthen monitoring frameworks with tools such as Amazon CloudWatch, SageMaker Model Monitor, and SageMaker Clarify. Configure alerts for immediate action on identified issues.</p>
<p><b>CI pipeline trigger errors</b> – The CI pipeline in Azure DevOps might not be triggered upon code merge due to misconfiguration.</p>	<p>Check the Azure DevOps project settings to ensure that the webhooks are properly set up and pointing to the correct SageMaker endpoints.</p>



Issue	Solution
<b>Governance</b> – The central Automation account might not enforce best practices across ML platforms, leading to inconsistent workflows.	Audit the Automation account settings, ensuring that all ML environments and models conform to predefined best practices and policies.
<b>Model registry approval delays</b> – This happens when there's a delay in checking and approving the model, either because people take time to review it or because of technical issues.	Implement a notification system to alert stakeholders of models that are pending approval, and streamline the review process.
<b>Model deployment event failures</b> – Events dispatched to start model deployment pipelines might fail, causing deployment delays.	Confirm that Amazon EventBridge has the correct permissions and event patterns to invoke Azure DevOps pipelines successfully.
<b>Production deployment bottlenecks</b> – Manual approval processes can create bottlenecks, delaying the production deployment of models.	Optimize the approval workflow within the model deploy pipeline, promoting timely reviews and clear communication channels.

## Related resources

### AWS documentation

- [Amazon SageMaker documentation](#)
- [Machine Learning Lens](#) (AWS Well Architected Framework)
- [Planning for successful MLOps](#) (AWS Prescriptive Guidance)

### Other AWS resources

- [MLOps foundation roadmap for enterprises with Amazon SageMaker](#) (AWS blog post)
- [AWS Summit ANZ 2022 - End-to-end MLOps for architects](#) (YouTube video)

## Azure documentation

- [Azure DevOps documentation](#)
- [Azure Pipelines documentation](#)

# Create a custom Docker container image for SageMaker and use it for model training in AWS Step Functions

Created by Julia Bluszcz (AWS), Neha Sharma (AWS), Aubrey Oosthuizen (AWS), Mohan Gowda Purushothama (AWS), and Mateusz Zaremba (AWS)

**Environment:** Production

**Technologies:** Machine learning & AI; DevOps

**AWS services:** Amazon ECR; Amazon SageMaker; AWS Step Functions

## Summary

This pattern shows how to create a Docker container image for [Amazon SageMaker](#) and use it for a training model in [AWS Step Functions](#). By packaging custom algorithms in a container, you can run almost any code in the SageMaker environment, regardless of programming language, framework, or dependencies.

In the example [SageMaker notebook](#) provided, the custom Docker container image is stored in [Amazon Elastic Container Registry \(Amazon ECR\)](#). Step Functions then uses the container that's stored in Amazon ECR to run a Python processing script for SageMaker. Then, the container exports the model to [Amazon Simple Storage Service \(Amazon S3\)](#).

## Prerequisites and limitations

### Prerequisites

- An active AWS account
- An [AWS Identity and Access Management \(IAM\) role for SageMaker](#) with Amazon S3 permissions
- An [IAM role for Step Functions](#)
- Familiarity with Python
- Familiarity with the Amazon SageMaker Python SDK
- Familiarity with the AWS Command Line Interface (AWS CLI)
- Familiarity with AWS SDK for Python (Boto3)
- Familiarity with Amazon ECR
- Familiarity with Docker

## Product versions

- AWS Step Functions Data Science SDK version 2.3.0
- Amazon SageMaker Python SDK version 2.78.0

## Architecture

The following diagram shows an example workflow for creating a Docker container image for SageMaker, then using it for a training model in Step Functions:

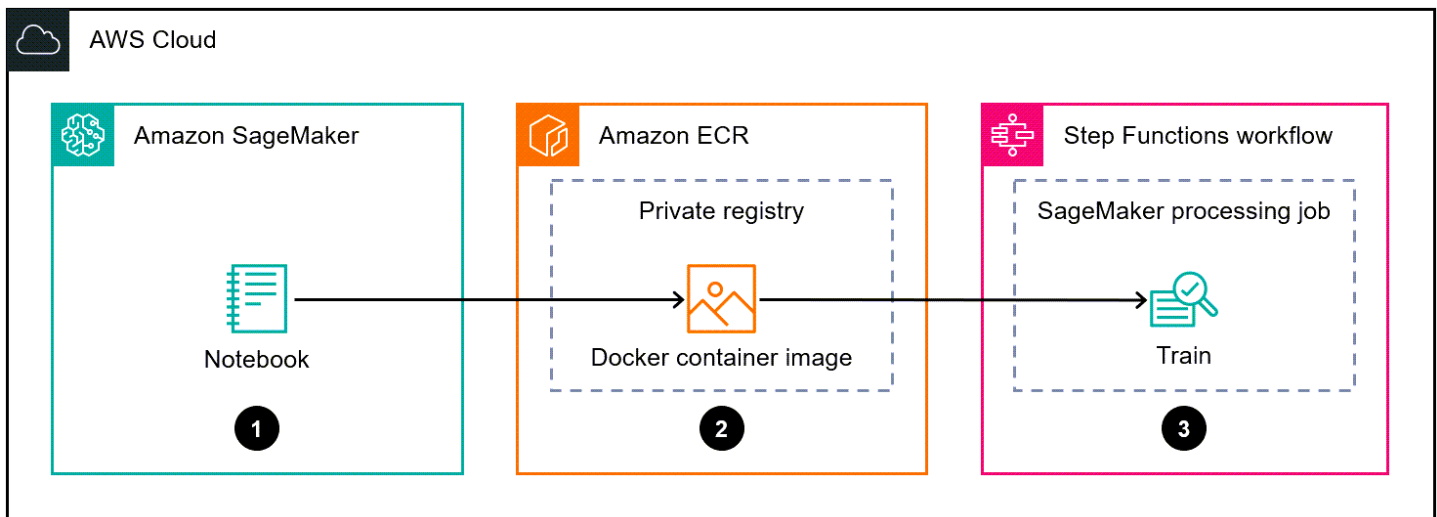

The diagram shows the following workflow:

1. A data scientist or DevOps engineer uses a Amazon SageMaker notebook to create a custom Docker container image.
2. A data scientist or DevOps engineer stores the Docker container image in an Amazon ECR private repository that's in a private registry.
3. A data scientist or DevOps engineer uses the Docker container to run a Python SageMaker processing job in a Step Functions workflow.

## Automation and scale

The example SageMaker notebook in this pattern uses an `m1.m5.xlarge` notebook instance type. You can change the instance type to fit your use case. For more information about SageMaker notebook instance types, see [Amazon SageMaker Pricing](#).

## Tools

- [Amazon Elastic Container Registry \(Amazon ECR\)](#) is a managed container image registry service that's secure, scalable, and reliable.
- [Amazon SageMaker](#) is a managed machine learning (ML) service that helps you build and train ML models and then deploy them into a production-ready hosted environment.
- [Amazon SageMaker Python SDK](#) is an open source library for training and deploying machine-learning models on SageMaker.
- [AWS Step Functions](#) is a serverless orchestration service that helps you combine AWS Lambda functions and other AWS services to build business-critical applications.
- [AWS Step Functions Data Science Python SDK](#) is an open source library that helps you create Step Functions workflows that process and publish machine learning models.

## Epics

### Create a custom Docker container image and store it in Amazon ECR

Task	Description	Skills required
Setup Amazon ECR and create a new private registry.	If you haven't already, set up Amazon ECR by following the instructions in <a href="#">Setting up with Amazon ECR</a> in the <i>Amazon ECR User Guide</i> . Each AWS account is provided with a default private Amazon ECR registry.	DevOps engineer
Create an Amazon ECR private repository.	Follow the instructions in <a href="#">Creating a private repository</a> in the <i>Amazon ECR User Guide</i> .  <b>Note:</b> The repository that you create is where you'll store	DevOps engineer

Task	Description	Skills required
	your custom Docker container images.	

Task	Description	Skills required
Create a Dockerfile that includes the specifications needed to run your SageMaker processing job.	<p>Create a Dockerfile that includes the specifications needed to run your SageMaker processing job by configuring a Dockerfile. For instructions, see <a href="#">Adapting your own training container</a> in the <i>Amazon SageMaker Developer Guide</i>.</p> <p>For more information about Dockerfiles, see the <a href="#">Dockerfile Reference</a> in the Docker documentation.</p> <p><b>Example Jupyter notebook code cells to create a Dockerfile</b></p> <p><i>Cell 1</i></p> <pre># Make docker folder !mkdir -p docker</pre> <p><i>Cell 2</i></p> <pre>%%writefile docker/Dockerfile  FROM python:3.7-slim-buster  RUN pip3 install     pandas==0.25.3 scikit-learn==0.21.3 ENV PYTHONUNBUFFERED=TRUE</pre>	DevOps engineer

Task	Description	Skills required
	ENTRYPOINT ["python3"]	



Task	Description	Skills required
Build your Docker container image and push it to Amazon ECR.	<ol style="list-style-type: none"><li data-bbox="591 226 1026 451">1. Build the container image using the Dockerfile that you created by running the <code>docker build</code> command in the AWS CLI.</li><li data-bbox="591 472 1026 651">2. Push the container image to Amazon ECR by running the <code>docker push</code> command.</li></ol> <p data-bbox="591 730 997 955">For more information, see <a href="#">Building and registering the container</a> in <i>Building your own algorithm container</i> on GitHub.</p> <p data-bbox="591 1003 997 1129"><b>Example Jupyter notebook code cells to build and register a Docker image</b></p> <p data-bbox="591 1178 1026 1690"><b>Important:</b> Before running the following cells, make sure that you've created a Dockerfile and stored it in the directory called <code>docker</code>. Also, make sure that you've created an Amazon ECR repository, and that you replace the <code>ecr_repository</code> value in the first cell with your repository's name.</p> <p data-bbox="591 1732 672 1764"><i>Cell 1</i></p> <pre data-bbox="591 1801 1026 1858">import boto3</pre>	DevOps engineer

Task	Description	Skills required
	<pre>tag = ':latest' account_id = boto3.client('sts').get_caller_identity().get('Account') region = boto3.Session().region_name ecr_repository = 'byoc'  image_uri = '{}.dkr.ecr.{}.amazonaws.com/{}'.format(account_id, region, ecr_repository + tag)</pre> <p><i>Cell 2</i></p> <pre># Build docker image !docker build -t \$image_uri docker</pre> <p><i>Cell 3</i></p> <pre># Authenticate to ECR !aws ecr get-login -password --region {region}   docker login --username AWS --password-stdin {account_id}.dkr.ecr.{region}.amazonaws.com</pre> <p><i>Cell 4</i></p> <pre># Push docker image !docker push \$image_uri</pre>	

Task	Description	Skills required
	<p><b>Note:</b> You must <a href="#">authenticate your Docker client to your private registry</a> so that you can use the <code>docker push</code> and <code>docker pull</code> commands. These commands push and pull images to and from the repositories in your registry.</p>	

### Create a Step Functions workflow that uses your custom Docker container image

Task	Description	Skills required
Create a Python script that includes your custom processing and model training logic.	<p>Write custom processing logic to run in your data processing script. Then, save it as a Python script named <code>training.py</code> .</p> <p>For more information, see <a href="#">Bring your own model with SageMaker Script Mode</a> on GitHub.</p> <p><b>Example Python script that includes custom processing and model training logic</b></p> <pre>%%writefile training.py from numpy import empty import pandas as pd import os from sklearn import datasets, svm</pre>	Data scientist

Task	Description	Skills required
	<pre>from joblib import dump, load  if __name__ == '__main__':     digits = datasets. load_digits()     #create classifier object     clf = svm.SVC(g amma=0.001, C=100.)      #fit the model     clf.fit(digits.dat a[:-1], digits.ta rget[:-1])      #model output in binary format     output_path = os.path.join('/opt/ ml/processing/model', "model.joblib")     dump(clf, output_pa th)</pre>	

Task	Description	Skills required
Create a Step Functions workflow that includes your SageMaker Processing job as one of the steps.	<p>Install and import the <a href="#">AWS Step Functions Data Science SDK</a> and upload the <b>training.py</b> file to Amazon S3. Then, use the <a href="#">Amazon SageMaker Python SDK</a> to define a processing step in Step Functions.</p> <p><b>Important:</b> Make sure that you've <a href="#">created an IAM execution role for Step Functions</a> in your AWS account.</p> <p><b>Example environment set up and custom training script to upload to Amazon S3</b></p> <pre data-bbox="597 1077 1027 1768">!pip install stepfunctions  import boto3 import stepfunctions import sagemaker import datetime  from stepfunctions     import steps from stepfunction     s.inputs import     ExecutionInput from stepfunction     s.steps import (         Chain     )</pre>	Data scientist

Task	Description	Skills required
	<pre>from stepfunctions.workflow import Workflow from sagemaker .processing import ScriptProcessor, ProcessingInput, ProcessingOutput  sagemaker_session = sagemaker.Session() bucket = sagemaker _session.default_bucket() role = sagemaker .get_execution_role() prefix = 'byoc-training-model'  # See prerequisites section to create this role workflow_execution_role = f"arn:aws:iam:: {account_id}:role/AmazonSageMaker-StepFunctionsWorkflowExecutionRole"  execution_input = ExecutionInput(     schema={         "PreprocessingJobName": str})  input_code = sagemaker _session.upload_data(     "training.py",     bucket=bucket,     key_prefix="preprocessing.py",</pre>	

Task	Description	Skills required
	<p data-bbox="597 205 1024 268">)</p> <p data-bbox="597 310 1024 485"><b>Example SageMaker processing step definition that uses a custom Amazon ECR image and Python script</b></p> <p data-bbox="597 527 1024 1283"><b>Note:</b> Make sure that you use the <code>execution_input</code> parameter to specify the job name. The parameter's value must be unique each time the job runs. Also, the <b>training.py</b> file's code is passed as an input parameter to the <code>ProcessingStep</code>, which means that it will be copied inside the container. The destination for the <code>ProcessingInput</code> code is the same as the second argument inside the <code>container_entrypoint</code>.</p> <pre data-bbox="597 1325 1024 1822">script_processor =     ScriptProcessor(command=['python3'],                     image_uri=image_uri,                     role=role,                     instance_count=1,                     instance_type='ml.m5.xlarge')</pre>	

Task	Description	Skills required
	<pre> processing_step =   steps.ProcessingStep(     "training-step",     processor=script_p rocessor,     job_name=execution _input["Preprocess ingJobName"],     inputs=[       Processin gInput(         source=in put_code,         destinati on="/opt/ml/proces sing/input/code",         input_nam e="code",       ),     ],     outputs=[       Processin gOutput(         source='/ opt/ml/processing/ model',         destinati on="s3://{}/{}".fo rmat(bucket, prefix),         output_na me='byoc-example')     ],     container_entrypoi nt=["python3", "/opt/ ml/processing/input/c ode/training.py"],   ) </pre>	



Task	Description	Skills required
	<p><b>Example Step Functions workflow that runs a SageMaker processing job</b></p> <p><b>Note:</b> This example workflow includes the SageMaker processing job step only, not a complete Step Functions workflow. For a full example workflow, see <a href="#">Example notebooks in SageMaker</a> in the AWS Step Functions Data Science SDK documentation.</p> <pre>workflow_graph =   Chain([processing_ step])  workflow = Workflow(   name="ProcessingWo rkflow",   definition=workflo w_graph,   role=workflow_exec ution_role )  workflow.create() # Execute workflow execution = workflow. execute(   inputs={     "Preproce ssingJobName":   str(datetime.datet ime.now().strftime ("%Y%m%d%H%M-%SS")),   # Each pre processin g job (SageMaker</pre>	

Task	Description	Skills required
	<pre>processing job) requires a unique name, } ) execution_output = execution.get_output(wait=True)</pre>	

## Related resources

- [Process data](#) (*Amazon SageMaker Developer Guide*)
- [Adapting your own training container](#) (*Amazon SageMaker Developer Guide*)

# Deploy preprocessing logic into an ML model in a single endpoint using an inference pipeline in Amazon SageMaker

Created by Mohan Gowda Purushothama (AWS), Gabriel Rodriguez Garcia (AWS), and Mateusz Zaremba (AWS)

**Environment:** Production

**Technologies:** Machine learning & AI; Containers & microservices

**AWS services:** Amazon SageMaker; Amazon ECR

## Summary

This pattern explains how to deploy multiple pipeline model objects in a single endpoint by using an [inference pipeline](#) in Amazon SageMaker. The pipeline model object represents different machine learning (ML) workflow stages, such as preprocessing, model inference, and postprocessing. To illustrate the deployment of serially connected pipeline model objects, this pattern shows you how to deploy a preprocessing [Scikit-learn](#) container and a regression model based on the [linear learner algorithm](#) built into SageMaker. The deployment is hosted behind a single endpoint in SageMaker.

**Note:** The deployment in this pattern uses the ml.m4.2xlarge instance type. We recommend using an instance type that aligns with your data size requirements and the complexity of your workflow. For more information, see [Amazon SageMaker Pricing](#). This pattern uses [prebuilt Docker images for Scikit-learn](#), but you can use your own Docker containers and integrate them into your workflow.

## Prerequisites and limitations

### Prerequisites

- An active AWS account
- [Python 3.9](#)
- [Amazon SageMaker Python SDK](#) and [Boto3 library](#)
- AWS Identity and Access Management (AWS IAM) [role](#) with basic SageMaker [permissions](#) and Amazon Simple Storage Service (Amazon S3) [permissions](#)

## Product versions

- [Amazon SageMaker Python SDK 2.49.2](#)

## Architecture

### Target technology stack

- Amazon Elastic Container Registry (Amazon ECR)
- Amazon SageMaker
- Amazon SageMaker Studio
- Amazon Simple Storage Service (Amazon S3)
- [Real-time inference](#) endpoint for Amazon SageMaker

### Target architecture

The following diagram shows the architecture for the deployment of an Amazon SageMaker pipeline model object.

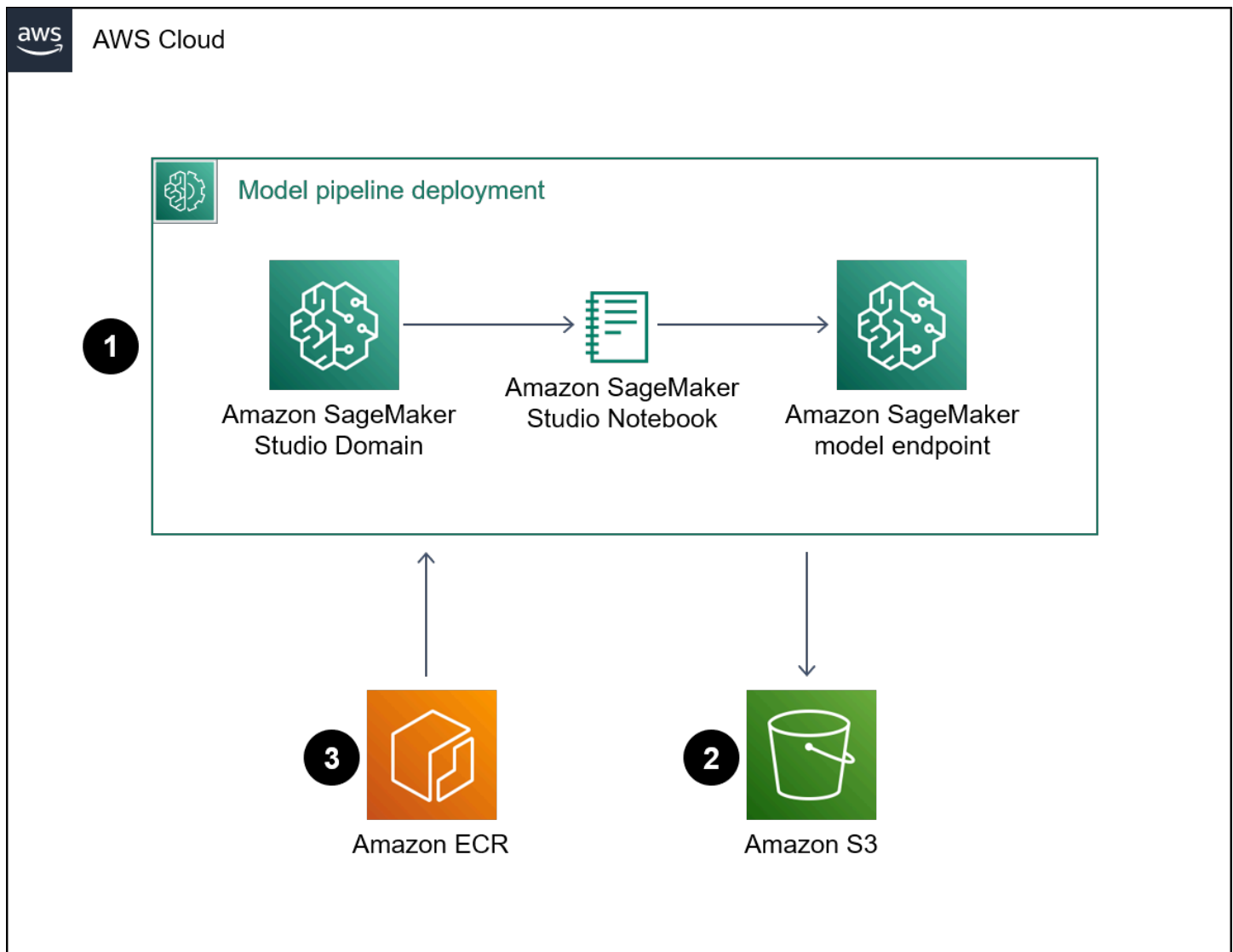

The diagram shows the following workflow:

1. A SageMaker notebook deploys a pipeline model.
2. An S3 bucket stores the model artifacts.
3. Amazon ECR gets the source container images from the S3 bucket.

## Tools

### AWS tools

- [Amazon Elastic Container Registry \(Amazon ECR\)](#) is a managed container image registry service that's secure, scalable, and reliable.

- [Amazon SageMaker](#) is a managed ML service that helps you build and train ML models and then deploy them into a production-ready hosted environment.
- [Amazon SageMaker Studio](#) is a web-based, integrated development environment (IDE) for ML that lets you build, train, debug, deploy, and monitor your ML models.
- [Amazon Simple Storage Service \(Amazon S3\)](#) is a cloud-based object storage service that helps you store, protect, and retrieve any amount of data.

## Code

The code for this pattern is available in the GitHub [Inference Pipeline with Scikit-learn and Linear Learner](#) repository.

## Epics

### Prepare the dataset

Task	Description	Skills required
Prepare the dataset for your regression task.	<p><a href="#">Open a notebook</a> in Amazon SageMaker Studio.</p> <p>To import all necessary libraries and initialize your working environment, use the following example code in your notebook:</p> <pre>import sagemaker from sagemaker import get_execution_role  sagemaker_session = sagemaker.Session()  # Get a SageMaker- compatible role used by this Notebook Instance.</pre>	Data scientist

Task	Description	Skills required
	<pre data-bbox="609 210 1015 619">role = get_execution_role()  # S3 prefix bucket = sagemaker_session.default_bucket() prefix = "Scikit-LearnLearner-pipeline-abalone-example"</pre> <p data-bbox="592 661 974 787">To download a sample dataset, add the following code to your notebook:</p> <pre data-bbox="609 829 1015 1102">! mkdir abalone_data ! aws s3 cp s3://sagemaker-sample-files/datasets/tabular/uci_abalone/abalone.csv ./abalone_data</pre> <p data-bbox="592 1144 1015 1323"><b>Note:</b> The example in this pattern uses the <a href="#">Abalone Data Set</a> from the UCI Machine Learning Repository.</p>	

Task	Description	Skills required
Upload the dataset to an S3 bucket.	<p>In the notebook where you prepared your dataset earlier, add the following code to upload your sample data to an S3 bucket:</p> <pre data-bbox="594 491 1027 1045"> WORK_DIRECTORY =   "abalone_data"  train_input = sagemaker _session.upload_data(   path="{}/{}".forma t(WORK_DIRECTORY,   "abalone.csv"),   bucket=bucket,   key_prefix="{}/ {}".format(prefix,   "train"),   ) </pre>	Data scientist

## Create the data preprocessor using SKLearn

Task	Description	Skills required
Prepare the preprocessor.py script.	<ol style="list-style-type: none"> <li>Copy the preprocessing logic from the Python file in the GitHub <a href="#">sklearn_abalone_featurizer.py</a> repository, and then paste the code into a separate Python file called <code>sklearn_abalone_featurizer.py</code>. You can modify the code to fit your custom dataset and custom workflow.</li> </ol>	Data scientist



Task	Description	Skills required
	2. Save the <code>sklearn_balone_featurizer.py</code> file in the root directory of your project (that is, in the same location where you run your SageMaker notebook).	

Task	Description	Skills required
Create the SKLearn preprocessor object.	<p>To create an SKLearn preprocessor object (called SKLearn Estimator) that you can incorporate into your final inference pipeline, run the following code in your SageMaker notebook:</p> <pre data-bbox="592 583 1024 1619">from sagemaker.sklearn. estimator import SKLearn  FRAMEWORK_VERSION = "0.23-1" script_path = "sklearn_abalone_f eaturizer.py"  sklearn_preprocessor = SKLearn(     entry_point=script _path,     role=role,     framework_version= FRAMEWORK_VERSION,     instance_type="ml. c4.xlarge",     sagemaker_session= sagemaker_session, ) sklearn_preproc essor.fit({"train": train_input})</pre>	Data scientist

Task	Description	Skills required
Test the preprocessor's inference.	<p>To confirm that your preprocessor is defined correctly, launch a <a href="#">batch transform job</a> by entering the following code in your SageMaker notebook:</p> <pre data-bbox="597 537 1029 1772"># Define a SKLearn Transformer from the trained SKLearn Estimator transformer = sklearn_preprocessor.transformer(     instance_count=1,     instance_type="ml.m5.xlarge",     assemble_with="Line",     accept="text/csv" )  # Preprocess training input transformer.transform(train_input,     content_type="text/csv") print("Waiting for transform job: " +     transformer.latest_transform_job.job_name) transformer.wait() preprocessed_train = transformer.output_path</pre>	

## Create a machine learning model

Task	Description	Skills required
Create a model object.	<p>To create a model object based on the linear learner algorithm, enter the following code in your SageMaker notebook:</p> <pre data-bbox="594 594 1026 1833">import boto3 from sagemaker .image_uris import retrieve  ll_image = retrieve( "linear-learner", boto3.Session().re gion_name) s3_ll_output_key _prefix = "ll_train ing_output" s3_ll_output_location = "s3://{}/{}/{}/{}" .format(     bucket, prefix,     s3_ll_output_key_p refix, "ll_model" )  ll_estimator = sagemaker.estimato r.Estimator(     ll_image,     role,     instance_count=1,     instance_type="ml. m4.2xlarge",     volume_size=20,     max_run=3600,     input_mode="File",</pre>	Data scientist

Task	Description	Skills required
	<pre>        output_path=s3_ll_ output_location,         sagemaker_session= sagemaker_session,     )  ll_estimator.s et_hyperparameters (feature_dim=10,  predictor_type="re gressor", mini_batch size=32)  ll_train_data = sagemaker.inputs.Tr ainingInput(     preprocessed_train ,     distribution="Full yReplicated",     content_type="text /csv",     s3_data_type="S3Pr efix", )  data_channels = {"train": ll_train_ data} ll_estimator.fit(inpu ts=data_channels,  logs=True)</pre> <p>The preceding code retrieves the relevant Amazon ECR Docker image from the public Amazon ECR Registry for the model, creates an estimator object, and then uses that</p>	

Task	Description	Skills required
	object to train the regression model.	

## Deploy the final pipeline

Task	Description	Skills required
Deploy the pipeline model.	<p>To create a pipeline model object (that is, a preprocessor object) and deploy the object, enter the following code in your SageMaker notebook:</p> <pre> from sagemaker.model import Model from sagemaker .pipeline import PipelineModel import boto3 from time import gmtime, strftime  timestamp_prefix =     strftime("%Y-%m-%d- %H-%M-%S", gmtime())  scikit_learn_inf erencee_model =     sklearn_preprocess or.create_model() linear_learner_model = ll_estimator.creat e_model()  model_name = "inferenc e-pipeline-" +     timestamp_prefix </pre>	Data scientist

Task	Description	Skills required
	<pre>endpoint_name =     "inference-pipeline-     ep-" + timestamp_prefix sm_model = PipelineM odel(     name=model_name,     role=role, models=     [scikit_learn_infe     rencee_model,     linear_learner_model] )  sm_model.deploy(init ial_instance_count =1, instance_type="ml. c4.xlarge", endpoint_ name=endpoint_name)</pre> <p><b>Note:</b> You can adjust the instance type used in the model object to meet your needs.</p>	

Task	Description	Skills required
Test the inference.	<p>To confirm the endpoint is working correctly, run the following sample inference code in your SageMaker notebook:</p> <pre data-bbox="597 489 1027 1329">from sagemaker.predictor import Predictor from sagemaker.serializers import CSVSerializer  payload = "M, 0.44, 0.365, 0.125, 0.516, 0.2155, 0.114, 0.155" actual_rings = 10 predictor = Predictor(endpoint_name=endpoint_name, sagemaker_session=sagemaker_session, serializer=CSVSerializer())  print(predictor.predict(payload))</pre>	Data scientist

## Related resources

- [Preprocess input data before making predictions using Amazon SageMaker inference pipelines and Scikit-learn](#) (AWS Machine Learning Blog)
- [End to end Machine Learning with Amazon SageMaker](#) (GitHub)



# Develop advanced generative AI chat-based assistants by using RAG and ReAct prompting

Created by Praveen Kumar Jeyarajan (AWS), Jundong Qiao (AWS), Kara Yang (AWS), Kiowa Jackson (AWS), Noah Hamilton (AWS), and Shuai Cao (AWS)

**Code repository:** [genai-bedrock-chatbot](#)

**Environment:** PoC or pilot

**Technologies:** Machine learning & AI; Databases; DevOps; Serverless

**AWS services:** Amazon Bedrock; Amazon ECS; Amazon Kendra; AWS Lambda

## Summary

A typical corporation has 70 percent of its data trapped in siloed systems. You can use generative AI-powered chat-based assistants to unlock insights and relationships between these data silos through natural language interactions. To get the most out of generative AI, the outputs must be trustworthy, accurate, and inclusive of the available corporate data. Successful chat-based assistants depend on the following:

- Generative AI models (such as Anthropic Claude 2)
- Data source vectorization
- Advanced reasoning techniques, such as the [ReAct framework](#), for prompting the model

This pattern provides data-retrieval approaches from data sources such as Amazon Simple Storage Service (Amazon S3) buckets, AWS Glue, and Amazon Relational Database Service (Amazon RDS). Value is gained from that data by interleaving [Retrieval Augmented Generation \(RAG\)](#) with chain-of-thought methods. The results support complex chat-based assistant conversations that draw on the entirety of your corporation's stored data.

This pattern uses Amazon SageMaker manuals and pricing data tables as an example to explore the capabilities of a generative AI chat-based assistant. You will build a chat-based assistant that helps

customers evaluate the SageMaker service by answering questions about pricing and the service's capabilities. The solution uses a Streamlit library for building the frontend application and the LangChain framework for developing the application backend powered by a large language model (LLM).

Inquiries to the chat-based assistant are met with an initial intent classification for routing to one of three possible workflows. The most sophisticated workflow combines general advisory guidance with complex pricing analysis. You can adapt the pattern to suit enterprise, corporate, and industrial use cases.

## Prerequisites and limitations

### Prerequisites

- [AWS Command Line Interface \(AWS CLI\)](#) installed and configured
- [AWS Cloud Development Kit \(AWS CDK\) Toolkit 2.114.1 or later](#) installed and configured
- Basic familiarity with Python and AWS CDK
- [Git](#) installed
- [Docker](#) installed
- [Python 3.11 or later](#) installed and configured (for more information, see the [Tools](#) section)
- An [active AWS account](#) bootstrapped by using [AWS CDK](#)
- Amazon Titan and Anthropic Claude [model access](#) enabled in the Amazon Bedrock service
- [AWS security credentials](#), including `AWS_ACCESS_KEY_ID`, correctly configured in your terminal environment

### Limitations

- LangChain doesn't support every LLM for streaming. The Anthropic Claude models are supported, but models from AI21 Labs are not.
- This solution is deployed to a single AWS account.
- This solution can be deployed only in AWS Regions where Amazon Bedrock and Amazon Kendra are available. For information about availability, see the documentation for [Amazon Bedrock](#) and [Amazon Kendra](#).

### Product versions

- Python version 3.11 or later
- Streamlit version 1.30.0 or later
- Streamlit-chat version 0.1.1 or later
- LangChain version 0.1.12 or later
- AWS CDK version 2.132.1 or later

## Architecture

### Target technology stack

- Amazon Athena
- Amazon Bedrock
- Amazon Elastic Container Service (Amazon ECS)
- AWS Glue
- AWS Lambda
- Amazon S3
- Amazon Kendra
- Elastic Load Balancing

### Target architecture

The AWS CDK code will deploy all the resources that are required to set up the chat-based assistant application in an AWS account. The chat-based assistant application shown in the following diagram is designed to answer SageMaker related queries from users. Users connect through an Application Load Balancer to a VPC that contains an Amazon ECS cluster hosting the Streamlit application. An orchestration Lambda function connects to the application. S3 bucket data sources provide data to the Lambda function through Amazon Kendra and AWS Glue. The Lambda function connects to Amazon Bedrock for answering queries (questions) from chat-based assistant users.

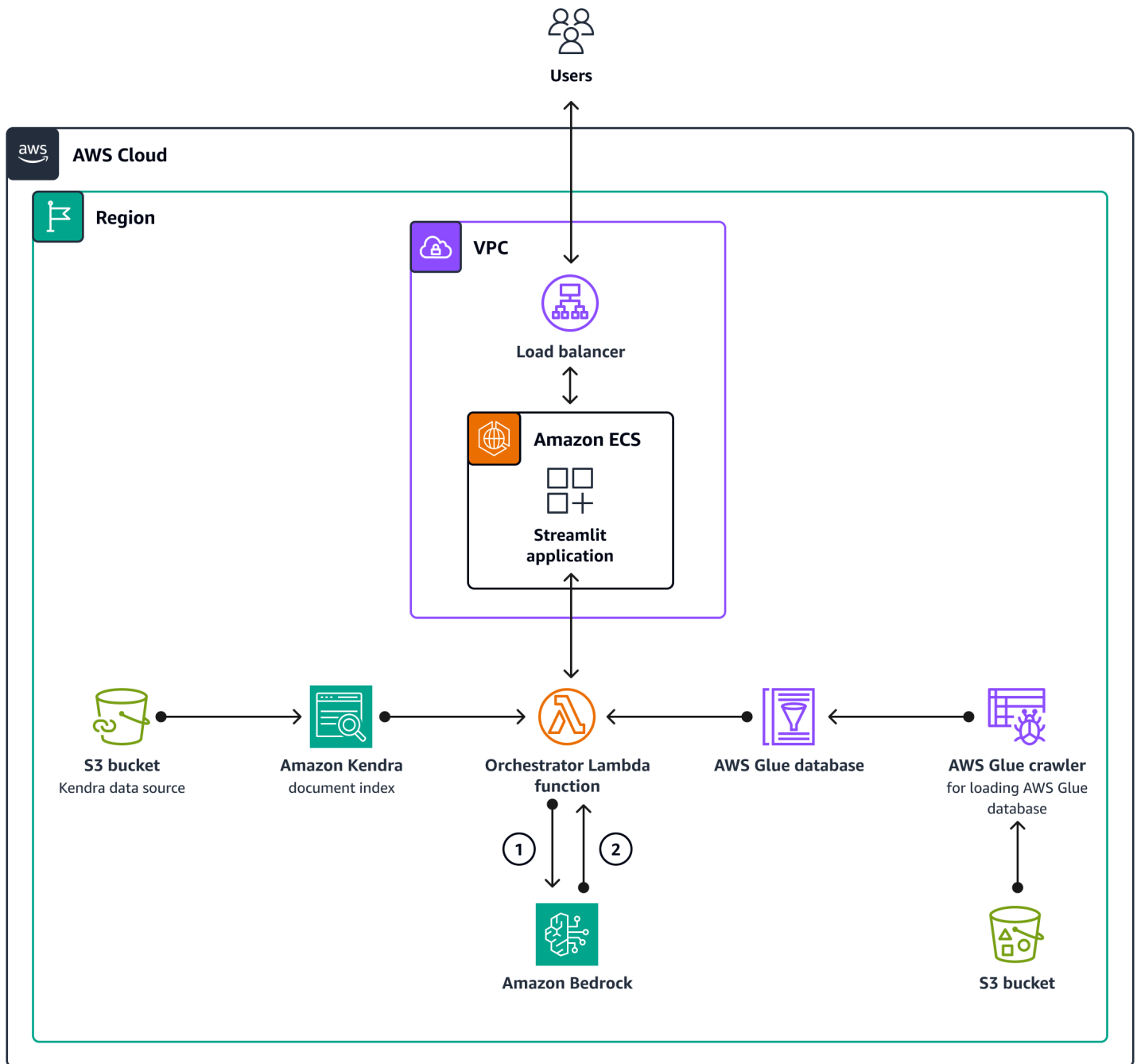

1. The orchestration Lambda function sends the LLM prompt request to the Amazon Bedrock model (Claude 2).
2. Amazon Bedrock sends the LLM response back to the orchestration Lambda function.

**Logic flow within the orchestration Lambda function**

When users ask a question through the Streamlit application, it invokes the orchestration Lambda function directly. The following diagram shows the logic flow when the Lambda function is invoked.

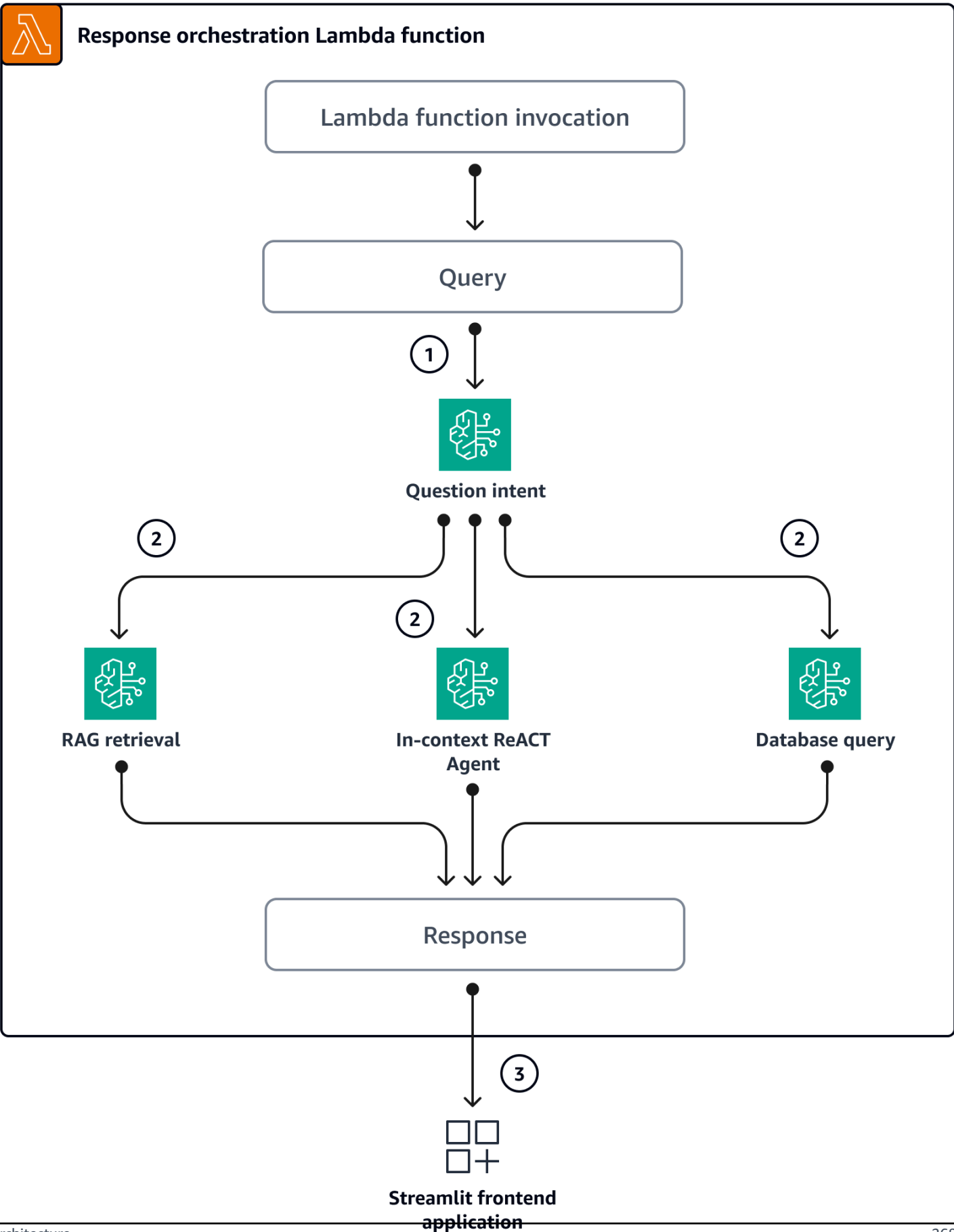

- Step 1 – The input query (question) is classified into one of the three intents:
  - General SageMaker guidance questions
  - General SageMaker pricing (training/inference) questions
  - Complex questions related to SageMaker and pricing
- Step 2 – The input query initiates one of the three services:
  - RAG Retrieval service, which retrieves relevant context from the [Amazon Kendra](#) vector database and calls the LLM through [Amazon Bedrock](#) to summarize the retrieved context as the response.
  - Database Query service, which uses- the LLM, database metadata, and sample rows from relevant tables to convert the input query into a SQL query. Database Query service runs the SQL query against the SageMaker pricing database through [Amazon Athena](#) and summarizes the query results as the response.
  - In-context ReACT Agent service, which breaks down the input query into multiple steps before providing a response. The agent uses RAG Retrieval service and Database Query service as tools to retrieve relevant information during the reasoning process. After the reasoning and actions processes are complete, the agent generates the final answer as the response.
- Step 3 – The response from the orchestration Lambda function is sent to the Streamlit application as output.

## Tools

### AWS services

- [Amazon Athena](#) is an interactive query service that helps you analyze data directly in Amazon Simple Storage Service (Amazon S3) by using standard SQL.
- [Amazon Bedrock](#) is a fully managed service that makes high-performing foundation models (FMs) from leading AI startups and Amazon available for your use through a unified API.
- [AWS Cloud Development Kit \(AWS CDK\)](#) is a software development framework that helps you define and provision AWS Cloud infrastructure in code.
- [AWS Command Line Interface \(AWS CLI\)](#) is an open-source tool that helps you interact with AWS services through commands in your command-line shell.
- [Amazon Elastic Container Service \(Amazon ECS\)](#) is a fast and scalable container management service that helps you run, stop, and manage containers on a cluster.

- [AWS Glue](#) is a fully managed extract, transform, and load (ETL) service. It helps you reliably categorize, clean, enrich, and move data between data stores and data streams. This pattern uses an AWS Glue crawler and an AWS Glue Data Catalog table.
- [Amazon Kendra](#) is an intelligent search service that uses natural language processing and advanced machine learning algorithms to return specific answers to search questions from your data.
- [AWS Lambda](#) is a compute service that helps you run code without needing to provision or manage servers. It runs your code only when needed and scales automatically, so you pay only for the compute time that you use.
- [Amazon Simple Storage Service \(Amazon S3\)](#) is a cloud-based object storage service that helps you store, protect, and retrieve any amount of data.
- [Elastic Load Balancing \(ELB\)](#) distributes incoming application or network traffic across multiple targets. For example, you can distribute traffic across Amazon Elastic Compute Cloud (Amazon EC2) instances, containers, and IP addresses in one or more Availability Zones.

## Code repository

The code for this pattern is available in the GitHub [genai-bedrock-chatbot](#) repository.

The code repository contains the following files and folders:

- `assets` folder – The static assets the architecture diagram and the public dataset
- `code/lambda-container` folder – The Python code that is run in the Lambda function
- `code/streamlit-app` folder – The Python code that is run as the container image in Amazon ECS
- `tests` folder – The Python files that are run to unit test the AWS CDK constructs
- `code/code_stack.py` – The AWS CDK construct Python files used to create AWS resources
- `app.py` – The AWS CDK stack Python files used to deploy AWS resources in the target AWS account
- `requirements.txt` – The list of all Python dependencies that must be installed for AWS CDK
- `requirements-dev.txt` – The list of all Python dependencies that must be installed for AWS CDK to run the unit-test suite
- `cdk.json` – The input file to provide values required to spin up resources



**Note:** The AWS CDK code uses [L3 \(layer 3\) constructs](#) and [AWS Identity and Access Management \(IAM\) policies managed by AWS](#) for deploying the solution.

## Best practices

- The code example provided here is for a proof-of-concept (PoC) or pilot demo only. If you want to take the code to Production, be sure to use the following best practices:
  - [Amazon S3 access logging is enabled.](#)
  - [VPC Flow Logs is enabled.](#)
  - The [Amazon Kendra Enterprise Edition index](#) is enabled.
- Set up monitoring and alerting for the Lambda function. For more information, see [Monitoring and troubleshooting Lambda functions](#). For general best practices when working with Lambda functions, see the [AWS documentation](#).

## Epics

### Set up AWS credentials on your local machine

Task	Description	Skills required
Export variables for the account and AWS Region where the stack will be deployed.	To provide AWS credentials for AWS CDK by using environment variables, run the following commands. <pre>export CDK_DEFAULT_ACCOUNT=&lt;12 Digit AWS Account Number&gt; export CDK_DEFAULT_REGION=&lt;region&gt;</pre>	DevOps engineer, AWS DevOps
Set up the AWS CLI profile.	To set up the AWS CLI profile for the account, follow the instructions in the <a href="#">AWS documentation</a> .	DevOps engineer, AWS DevOps

## Set up your environment

Task	Description	Skills required
Clone the repo on your local machine.	<p>To clone the repository, run the following command in your terminal.</p> <pre data-bbox="594 499 1027 699">git clone https://github.com/aws-labs/genai-bedrock-chat-bot.git</pre>	DevOps engineer, AWS DevOps
Set up the Python virtual environment and install required dependencies.	<p>To set up the Python virtual environment, run the following commands.</p> <pre data-bbox="594 905 1027 1142">cd genai-bedrock-chat-bot python3 -m venv .venv source .venv/bin/activate</pre> <p>To set up the required dependencies, run the following command.</p> <pre data-bbox="594 1352 1027 1467">pip3 install -r requirements.txt</pre>	DevOps engineer, AWS DevOps
Set up the AWS CDK environment and synthesize the AWS CDK code.	<p>1. To set up the AWS CDK environment in your AWS account, run the following command.</p> <pre data-bbox="630 1724 1027 1875">cdk bootstrap aws://ACCOUNT-NUMBER/REGION</pre>	DevOps engineer, AWS DevOps

Task	Description	Skills required
	2. To convert the code to an AWS CloudFormation stack configuration, run the command <code>cdk synth</code> .	

## Configure and deploy the chat-based assistant application

Task	Description	Skills required
Provision Claude model access.	To enable Anthropic Claude model access for your AWS account, follow the instructions in the <a href="#">Amazon Bedrock documentation</a> .	AWS DevOps
Deploy resources in the account.	<p>To deploy resources in the AWS account by using the AWS CDK, do the following:</p> <ol style="list-style-type: none"> <li>1. In the root of the cloned repository, in the <code>cdk.json</code> file, provide inputs for the logging parameters. Example values are INFO, DEBUG, WARN, and ERROR.</li> </ol> <p>These values define log-level messages for the Lambda function and the Streamlit application.</p> <ol style="list-style-type: none"> <li>2. The <code>app.py</code> file in the root of the cloned repository contains the AWS CloudFormation stack</li> </ol>	AWS DevOps, DevOps engineer

Task	Description	Skills required
	<p>name used for deployment. The default stack name is <code>chatbot-stack</code>.</p> <p>3. To deploy resources, run the command <code>cdk deploy</code>.</p> <p>The <code>cdk deploy</code> command uses L3 constructs to create multiple Lambda functions for copying documents and CSV dataset files to S3 buckets.</p> <p>4. After the command is complete, sign in to the AWS Management Console, open the CloudFormation console, and <a href="#">review that the stack deployed successfully</a>.</p> <p>Upon successful deployment, you can access the chat-based assistant application by using the URL provided in the CloudFormation <b>Outputs</b> section.</p>	

Task	Description	Skills required
Run the AWS Glue crawler and create the Data Catalog table.	<p>An <a href="#">AWS Glue crawler</a> is used to keep the data schema dynamic. The solution creates and updates partitions in the <a href="#">AWS Glue Data Catalog table</a> by running the crawler on demand. After the CSV dataset files are copied into the S3 bucket, run the AWS Glue crawler and create the Data Catalog table schema for testing:</p> <ol style="list-style-type: none"><li>1. Navigate to the AWS Glue console.</li><li>2. In the navigation pane, under <b>Data Catalog</b>, choose <b>Crawlers</b>.</li><li>3. Select the crawler with suffix <code>sagemaker-pricing-crawler</code> .</li><li>4. Run the crawler.</li><li>5. After the crawler runs successfully, it creates an AWS Glue Data Catalog table.</li></ol> <p><b>Note:</b> The AWS CDK code configures the AWS Glue crawler to run on demand, but you can also <a href="#">schedule</a> it to run periodically.</p>	DevOps engineer, AWS DevOps

Task	Description	Skills required
Initiate document indexing.	<p>After the files are copied into the S3 bucket, use Amazon Kendra to crawl and index them:</p> <ol style="list-style-type: none"> <li>1. Navigate to the Amazon Kendra console.</li> <li>2. Select the index with the suffix chatbot-index .</li> <li>3. In the navigation pane, choose <b>Data sources</b>, and select the data source connector with the suffix chatbot-index .</li> <li>4. Choose <b>Sync Now</b> to initiate the indexing process.</li> </ol> <p><b>Note:</b> The AWS CDK code configures the Amazon Kendra index sync to run on demand, but you can also run periodically by using the <a href="#">Schedule parameter</a>.</p>	AWS DevOps, DevOps engineer

## Clean up all AWS resources in the solution

Task	Description	Skills required
Remove the AWS resources.	<p>After you test the solution, clean up the resources:</p> <ol style="list-style-type: none"> <li>1. To remove AWS resources deployed by the solution,</li> </ol>	DevOps engineer, AWS DevOps

Task	Description	Skills required
	<p>run the command <code>cdk destroy</code>.</p> <p>2. Delete all objects from the two S3 buckets, and then remove the buckets.</p> <p>For more information, see <a href="#">Deleting a bucket</a>.</p>	

## Troubleshooting

Issue	Solution
AWS CDK returns errors.	For help with AWS CDK issues, see <a href="#">Troubleshooting common AWS CDK issues</a> .

## Related resources

- Amazon Bedrock:
  - [Model access](#)
  - [Inference parameters for foundation models](#)
- [Building Lambda functions with Python](#)
- [Get started with the AWS CDK](#)
- [Working with the AWS CDK in Python](#)
- [Generative AI Application Builder on AWS](#)
- [LangChain documentation](#)
- [Streamlit documentation](#)

## Additional information

### AWS CDK commands

When working with AWS CDK, keep in mind the following useful commands:

- Lists all stacks in the app

```
cdk ls
```

- Emits the synthesized AWS CloudFormation template

```
cdk synth
```

- Deploys the stack to your default AWS account and Region

```
cdk deploy
```

- Compares the deployed stack with the current state

```
cdk diff
```

- Opens the AWS CDK documentation

```
cdk docs
```

- Deletes the CloudFormation stack and removes AWS deployed resources

```
cdk destroy
```



# Develop a fully automated chat-based assistant by using Amazon Bedrock agents and knowledge bases

Created by Jundong Qiao (AWS), Kara Yang (AWS), Kiowa Jackson (AWS), Noah Hamilton (AWS), Praveen Kumar Jeyarajan (AWS), and Shuai Cao (AWS)

**Code repository:** [genai-bedrock-agent-chatbot](#)

**Environment:** PoC or pilot

**Technologies:** Machine learning & AI; Serverless

**AWS services:** Amazon Bedrock; AWS CDK; AWS Lambda

## Summary

Many organizations face challenges when creating a chat-based assistant that is capable of orchestrating diverse data sources to offer comprehensive answers. This pattern presents a solution for developing a chat-based assistant that is capable of answering queries from both documentation and databases, with a straightforward deployment.

Starting with [Amazon Bedrock](#), this fully managed generative artificial intelligence (AI) service provides a wide array of advanced foundation models (FMs). This facilitates the efficient creation of generative AI applications with a strong focus on privacy and security. In the context of documentation retrieval, the [Retrieval Augmented Generation \(RAG\)](#) is a pivotal feature. It uses [knowledge bases](#) to augment FM prompts with contextually relevant information from external sources. An [Amazon OpenSearch Serverless](#) index serves as the vector database behind the knowledge bases for Amazon Bedrock. This integration is enhanced through careful prompt engineering to minimize inaccuracies and make sure that responses are anchored in factual documentation. For database queries, the FMs of Amazon Bedrock transform textual inquiries into structured SQL queries, incorporating specific parameters. This enables the precise retrieval of data from databases managed by [AWS Glue databases](#). [Amazon Athena](#) is used for these queries.

For handling more intricate queries, achieving comprehensive answers demands information sourced from both documentation and databases. [Agents for Amazon Bedrock](#) is a generative AI feature that helps you build autonomous agents that can understand complex tasks and break

them down into simpler tasks for orchestration. The combination of insights retrieved from the simplified tasks, facilitated by Amazon Bedrock autonomous agents, enhances the synthesis of information, leading to more thorough and exhaustive answers. This pattern demonstrates how to build a chat-based assistant by using Amazon Bedrock and the related generative AI services and features within an automated solution.

## Prerequisites and limitations

### Prerequisites

- An active AWS account
- Docker, [installed](#)
- AWS Cloud Development Kit (AWS CDK), [installed](#) and [bootstrapped](#) to the us-east-1 or us-west-2 AWS Regions
- AWS CDK Toolkit version 2.114.1 or later, [installed](#)
- AWS Command Line Interface (AWS CLI), [installed](#) and [configured](#)
- Python version 3.11 or later, [installed](#)
- In Amazon Bedrock, [enable access](#) to Claude 2, Claude 2.1, Claude Instant, and Titan Embeddings G1 – Text

### Limitations

- This solution is deployed to a single AWS account.
- This solution can be deployed only in AWS Regions where Amazon Bedrock and Amazon OpenSearch Serverless are supported. For more information, see the documentation for [Amazon Bedrock](#) and [Amazon OpenSearch Serverless](#).

### Product versions

- Llama-index version 0.10.6 or later
- SQLAlchemy version 2.0.23 or later
- Opensearch-py version 2.4.2 or later
- Requests\_aws4auth version 1.2.3 or later
- AWS SDK for Python (Boto3) version 1.34.57 or later

# Architecture

## Target technology stack

The [AWS Cloud Development Kit \(AWS CDK\)](#) is an open source software development framework for defining cloud infrastructure in code and provisioning it through AWS CloudFormation. The AWS CDK stack used in this pattern deploys the following AWS resources:

- AWS Key Management Service (AWS KMS)
- Amazon Simple Storage Service (Amazon S3)
- AWS Glue Data Catalog, for the AWS Glue database component
- AWS Lambda
- AWS Identity and Access Management (IAM)
- Amazon OpenSearch Serverless
- Amazon Elastic Container Registry (Amazon ECR)
- Amazon Elastic Container Service (Amazon ECS)
- AWS Fargate
- Amazon Virtual Private Cloud (Amazon VPC)
- [Application Load Balancer](#)

## Target architecture

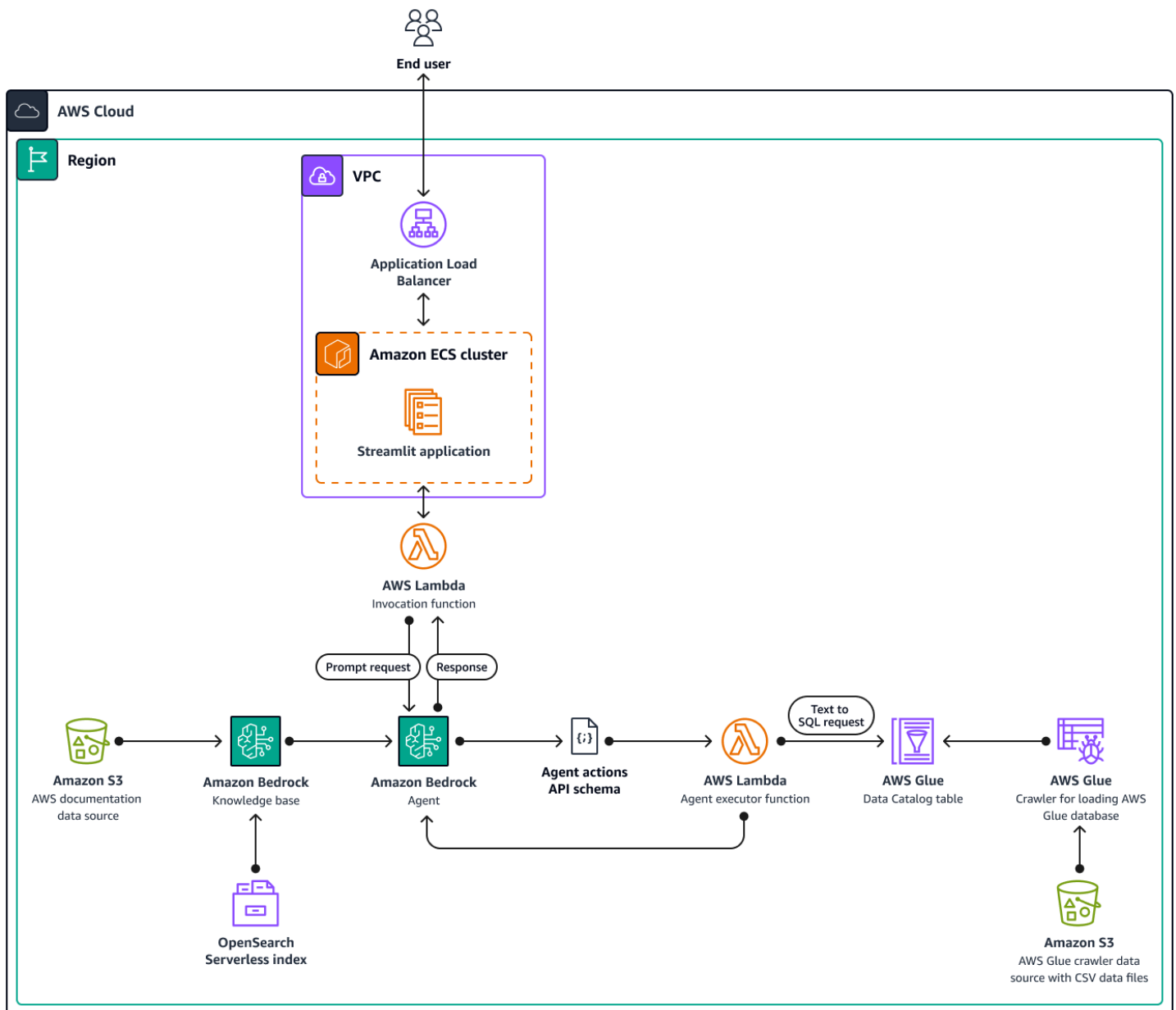

The diagram shows a comprehensive AWS cloud-native setup within a single AWS Region, using multiple AWS services. The primary interface for the chat-based assistant is a [Streamlit](#) application hosted on an Amazon ECS cluster. An [Application Load Balancer](#) manages accessibility. Queries made through this interface activate the Invocation Lambda function, which then interfaces with agents for Amazon Bedrock. This agent responds to user inquiries by either consulting the knowledge bases for Amazon Bedrock or by invoking an Agent executor Lambda function. This function triggers a set of actions associated with the agent, following a predefined API schema. The knowledge bases for Amazon Bedrock use an OpenSearch Serverless index as their vector

database foundation. Additionally, the Agent executor function generates SQL queries that are executed against the AWS Glue database through Amazon Athena.

## Tools

### AWS services

- [Amazon Athena](#) is an interactive query service that helps you analyze data directly in Amazon Simple Storage Service (Amazon S3) by using standard SQL.
- [Amazon Bedrock](#) is a fully managed service that makes high-performing foundation models (FMs) from leading AI startups and Amazon available for your use through a unified API.
- [AWS Cloud Development Kit \(AWS CDK\)](#) is a software development framework that helps you define and provision AWS Cloud infrastructure in code.
- [AWS Command Line Interface \(AWS CLI\)](#) is an open source tool that helps you interact with AWS services through commands in your command-line shell.
- [Amazon Elastic Container Service \(Amazon ECS\)](#) is a fast and scalable container management service that helps you run, stop, and manage containers on a cluster.
- [Elastic Load Balancing \(ELB\)](#) distributes incoming application or network traffic across multiple targets. For example, you can distribute traffic across Amazon Elastic Compute Cloud (Amazon EC2) instances, containers, and IP addresses in one or more Availability Zones.
- [AWS Glue](#) is a fully managed extract, transform, and load (ETL) service. It helps you reliably categorize, clean, enrich, and move data between data stores and data streams. This pattern uses an AWS Glue crawler and an AWS Glue Data Catalog table.
- [AWS Lambda](#) is a compute service that helps you run code without needing to provision or manage servers. It runs your code only when needed and scales automatically, so you pay only for the compute time that you use.
- [Amazon OpenSearch Serverless](#) is an on-demand serverless configuration for Amazon OpenSearch Service. In this pattern, an OpenSearch Serverless index serves as a vector database for the knowledge bases for Amazon Bedrock.
- [Amazon Simple Storage Service \(Amazon S3\)](#) is a cloud-based object storage service that helps you store, protect, and retrieve any amount of data.

### Other tools

- [Streamlit](#) is an open source Python framework to create data applications.

## Code repository

The code for this pattern is available in the GitHub [genai-bedrock-agent-chatbot](#) repository. The code repository contains the following files and folders:

- `assets` folder – The static assets, such as the architecture diagram and the public dataset.
- `code/lambda/action-lambda` folder – The Python code for the Lambda function that acts as an action for the Amazon Bedrock agent.
- `code/lambda/create-index-lambda` folder – The Python code for the Lambda function that creates the OpenSearch Serverless index.
- `code/lambda/invoke-lambda` folder – The Python code for the Lambda function that invokes the Amazon Bedrock agent, which is called directly from the Streamlit application.
- `code/lambda/update-lambda` folder – The Python code for the Lambda function that updates or deletes resources after the AWS resources are deployed through the AWS CDK.
- `code/layer/boto3_layer` folder – The AWS CDK stack that creates a Boto3 layer that is shared across all Lambda functions.
- `code/layer/opensearch_layer` folder – The AWS CDK stack that creates an OpenSearch Serverless layer that installs all dependencies to create the index.
- `code/streamlit-app` folder – The Python code that is run as the container image in Amazon ECS
- `code/code_stack.py` – The AWS CDK construct Python files that create AWS resources.
- `app.py` – The AWS CDK stack Python files that deploy AWS resources in the target AWS account.
- `requirements.txt` – The list of all Python dependencies that must be installed for the AWS CDK.
- `cdk.json` – The input file to provide the values that are required to create resources. Also, in the `context/config` fields, you can customize the solution accordingly. For more information about customization, see the [Additional information](#) section.

## Best practices

- The code example provided here is for proof-of-concept (PoC) or pilot purposes only. If you want to take the code to production, be sure to use the following best practices:
  - Enable [Amazon S3 access logging](#)
  - Enable [VPC Flow Logs](#)

- Set up monitoring and alerting for the Lambda functions. For more information, see [Monitoring and troubleshooting Lambda functions](#). For best practices, see the [Best practices for working with AWS Lambda functions](#).

## Epics

### Set up AWS credentials on your local workstation

Task	Description	Skills required
Export variables for the account and Region.	To provide AWS credentials for the AWS CDK by using environment variables, run the following commands. <pre>export CDK_DEFAULT_ACCOUNT=&lt;12-digit AWS account number&gt; export CDK_DEFAULT_REGION=&lt;Region&gt;</pre>	AWS DevOps, DevOps engineer
Set up the AWS CLI named profile.	To set up the AWS CLI named profile for the account, follow the instructions in <a href="#">Configuration and credential file settings</a> .	AWS DevOps, DevOps engineer

### Set up your environment

Task	Description	Skills required
Clone the repo to your local workstation.	To clone the repository, run the following command in your terminal. <pre>git clone https://github.com/aws-labs/</pre>	DevOps engineer, AWS DevOps

Task	Description	Skills required
	<pre>genai-bedrock-agent- chatbot.git</pre>	
Set up the Python virtual environment.	<p>To set up the Python virtual environment, run the following commands.</p> <pre>cd genai-bedrock-agent- chatbot python3 -m venv .venv source .venv/bin/ activate</pre> <p>To set up the required dependencies, run the following command.</p> <pre>pip3 install -r requirements.txt</pre>	DevOps engineer, AWS DevOps
Set up the AWS CDK environment.	To convert the code to an AWS CloudFormation template, run the command <code>cdk synth</code> .	AWS DevOps, DevOps engineer

## Configure and deploy the application

Task	Description	Skills required
Deploy resources in the account.	<p>To deploy resources in the AWS account by using the AWS CDK, do the following:</p> <ol style="list-style-type: none"> <li>1. In the root of the cloned repository, in the <code>cdk.json</code> file, provide</li> </ol>	DevOps engineer, AWS DevOps



Task	Description	Skills required
	<p>inputs for the logging parameters. Example values are INFO, DEBUG, WARN, and ERROR.</p> <p>These values define log-level messages for the Lambda functions and the Streamlit application.</p> <ol style="list-style-type: none"><li data-bbox="592 636 1024 1245">2. The <code>cdk.json</code> file in the root of the cloned repository contains the AWS CloudFormation stack name used for deployment. The default stack name is <code>chatbot-stack</code>. The default Amazon Bedrock agent name is <code>ChatbotBedrockAgent</code>, and the default Amazon Bedrock agent alias is <code>Chatbot_Agent</code>.</li><li data-bbox="592 1268 954 1398">3. To deploy resources, run the command <code>cdk deploy</code>.</li></ol> <p>The <code>cdk deploy</code> command uses <code>layer-3</code> constructs to create multiple Lambda functions for copying documents and CSV dataset files to S3 buckets. It also deploys the Amazon Bedrock agent, knowledge bases, and</p>	

Task	Description	Skills required
	<p>Action group Lambda function for the Amazon Bedrock agent.</p> <ol style="list-style-type: none"> <li>4. Sign in to the AWS Management Console, and then open the CloudFormation console at <a href="https://console.aws.amazon.com/cloudformation/">https://console.aws.amazon.com/cloudformation/</a>.</li> <li>5. Confirm that the stack deployed successfully. For instructions, see <a href="#">Reviewing your stack on the AWS CloudFormation console</a>.</li> </ol> <p>After successful deployment, you can access the chat-based assistant application by using the URL provided on the <b>Outputs</b> tab in the CloudFormation console.</p>	

## Clean up all AWS resources in the solution

Task	Description	Skills required
Remove the AWS resources.	After you test the solution, to clean up the resources, run the command <code>cdk destroy</code> .	AWS DevOps, DevOps engineer

## Related resources

### AWS documentation

- Amazon Bedrock resources:
  - [Model access](#)
  - [Inference parameters for foundation models](#)
  - [Agents for Amazon Bedrock](#)
  - [Knowledge bases for Amazon Bedrock](#)
- [Building Lambda functions with Python](#)
- AWS CDK resources:
  - [Get started with the AWS CDK](#)
  - [Troubleshooting common AWS CDK issues](#)
  - [Working with the AWS CDK in Python](#)
- [Generative AI Application Builder on AWS](#)

### Other AWS resources

- [Vector Engine for Amazon OpenSearch Serverless](#)

### Other resources

- [LlamaIndex documentation](#)
- [Streamlit documentation](#)

## Additional information

### Customize the chat-based assistant with your own data

To integrate your custom data for deploying the solution, follow these structured guidelines. These steps are designed to ensure a seamless and efficient integration process, enabling you to deploy the solution effectively with your bespoke data.

*For knowledge base data integration*

### Data preparation

1. Locate the `assets/knowledgebase_data_source/` directory.
2. Place your dataset within this folder.

## Configuration adjustments

1. Open the `cdk.json` file.
2. Navigate to the `context/configure/paths/knowledgebase_file_name` field, and then update it accordingly.
3. Navigate to the `bedrock_instructions/knowledgebase_instruction` field, and then update it to accurately reflect the nuances and context of your new dataset.

### *For structural data integration*

## Data organization

1. Within the `assets/data_query_data_source/` directory, create a subdirectory, such as `tabular_data`.
2. Put your structured dataset (acceptable formats include CSV, JSON, ORC, and Parquet) into this newly created subfolder.
3. If you are connecting to an existing database, update the function `create_sql_engine()` in `code/lambda/action-lambda/build_query_engine.py` to connect to your database.

## Configuration and code updates

1. In the `cdk.json` file, update the `context/configure/paths/athena_table_data_prefix` field to align with the new data path.
2. Revise `code/lambda/action-lambda/dynamic_examples.csv` by incorporating new text-to-SQL examples that correspond with your dataset.
3. Revise `code/lambda/action-lambda/prompt_templates.py` to mirror the attributes of your structured dataset.
4. In the `cdk.json` file, update the `context/configure/bedrock_instructions/action_group_description` field to explain the purpose and functionality of the Action group Lambda function.
5. In the `assets/agent_api_schema/artifacts_schema.json` file, explain the new functionalities of your Action group Lambda function.

### *General update*

In the `cdk.json` file, in the `context/configure/bedrock_instructions/agent_instruction` section, provide a comprehensive description of the Amazon Bedrock agent's intended functionality and design purpose, taking into account the newly integrated data.

# Document institutional knowledge from voice inputs by using Amazon Bedrock and Amazon Transcribe

Created by Praveen Kumar Jeyarajan (AWS), Jundong Qiao (AWS), Megan Wu (AWS), and Rajiv Upadhyay (AWS)

**Code repository:** [genai-knowledge-capture](#)

**Environment:** PoC or pilot

**Technologies:** Machine learning & AI; Business productivity; CloudNative

**AWS services:** Amazon Bedrock; AWS CDK; AWS Lambda; Amazon SNS; AWS Step Functions; Amazon Transcribe

## Summary

Capturing institutional knowledge is paramount for ensuring organizational success and resilience. Institutional knowledge represents the collective wisdom, insights, and experiences accumulated by employees over time, often tacit in nature and passed down informally. This wealth of information encompasses unique approaches, best practices, and solutions to intricate problems that might not be documented elsewhere. By formalizing and documenting this knowledge, companies can preserve institutional memory, foster innovation, enhance decision-making processes, and accelerate learning curves for new employees. Additionally, it promotes collaboration, empowers individuals, and cultivates a culture of continuous improvement. Ultimately, harnessing institutional knowledge helps companies use their most valuable asset—the collective intelligence of their workforce—to navigate challenges, drive growth, and maintain competitive advantage in dynamic business environments.

This pattern explains how to capture institutional knowledge through voice recordings from senior employees. It uses [Amazon Transcribe](#) and [Amazon Bedrock](#) for systematic documentation and verification. By documenting this informal knowledge, you can preserve it and share it with subsequent cohorts of employees. This endeavor supports operational excellence and improves

the effectiveness of training programs through the incorporation of practical knowledge acquired through direct experience.

## Prerequisites and limitations

### Prerequisites

- An active AWS account
- Docker, [installed](#)
- AWS Cloud Development Kit (AWS CDK) version 2.114.1 or later, [installed](#) and [bootstrapped](#) to the us-east-1 or us-west-2 AWS Regions
- AWS CDK Toolkit version 2.114.1 or later, [installed](#)
- AWS Command Line Interface (AWS CLI), [installed](#) and [configured](#)
- Python version 3.12 or later, [installed](#)
- Permissions to create Amazon Transcribe, Amazon Bedrock, Amazon Simple Storage Service (Amazon S3), and AWS Lambda resources

### Limitations

- This solution is deployed to a single AWS account.
- This solution can be deployed only in AWS Regions where Amazon Bedrock and Amazon Transcribe are available. For information about availability, see the documentation for [Amazon Bedrock](#) and [Amazon Transcribe](#).
- The audio files must be in a format that Amazon Transcribe supports. For a list of supported formats, see [Media formats](#) in the Transcribe documentation.

### Product versions

- AWS SDK for Python (Boto3) version 1.34.57 or later
- LangChain version 0.1.12 or later

## Architecture

The architecture represents a serverless workflow on AWS. [AWS Step Functions](#) orchestrates Lambda functions for audio processing, text analysis, and document generation. The following diagram shows the Step Functions workflow, also known as a *state machine*.

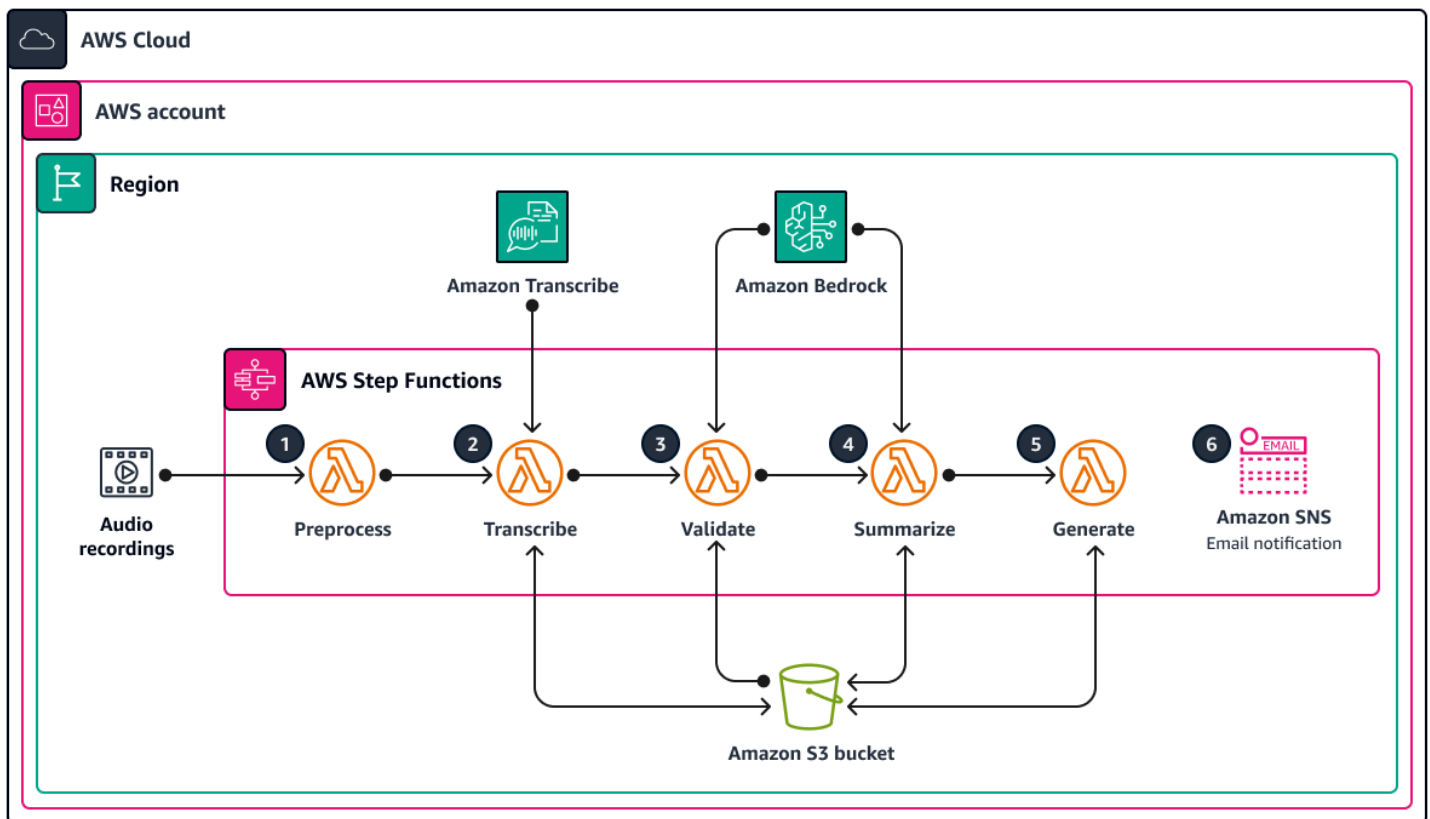

Each step in the state machine is handled by a distinct Lambda function. The following are the steps in the document generation process:

1. The `preprocess` Lambda function validates the input passed to Step Functions and lists all of the audio files present in the provided Amazon S3 URI folder path. Downstream Lambda functions in the workflow use the file list to validate, summarize, and generate the document.
2. The `transcribe` Lambda function uses Amazon Transcribe to convert audio files into text transcripts. This Lambda function is responsible for initiating the transcription process and accurately transforming speech into text, which is then stored for subsequent processing.
3. The `validate` Lambda function analyzes the text transcripts, determining the relevance of the responses to the initial questions. By using a large language model (LLM) through Amazon Bedrock, it identifies and separates on-topic answers from off-topic responses.



4. The `summarize` Lambda function uses Amazon Bedrock to generate a coherent and concise summary of the on-topic answers.
5. The `generate` Lambda function assembles the summaries into a well-structured document. It can format the document according to predefined templates and include any additional necessary content or data.
6. If any of the Lambda functions fail, you receive an email notification through Amazon Simple Notification Service (Amazon SNS).

Throughout this process, AWS Step Functions makes sure that each Lambda function is initiated in the correct sequence. This state machine has the capacity for parallel processing to enhance efficiency. An Amazon S3 bucket acts as the central storage repository, supporting the workflow by managing the various media and document formats involved.

## Tools

### AWS services

- [Amazon Bedrock](#) is a fully managed service that makes high-performing foundation models (FMs) from leading AI startups and Amazon available for your use through a unified API.
- [AWS Lambda](#) is a compute service that helps you run code without needing to provision or manage servers. It runs your code only when needed and scales automatically, so you pay only for the compute time that you use.
- [Amazon Simple Notification Service \(Amazon SNS\)](#) helps you coordinate and manage the exchange of messages between publishers and clients, including web servers and email addresses.
- [Amazon Simple Storage Service \(Amazon S3\)](#) is a cloud-based object storage service that helps you store, protect, and retrieve any amount of data.
- [AWS Step Functions](#) is a serverless orchestration service that helps you combine AWS Lambda functions and other AWS services to build business-critical applications.
- [Amazon Transcribe](#) is an automatic speech recognition service that uses machine learning models to convert audio to text.

### Other tools

- [LangChain](#) is a framework for developing applications that are powered by large language models (LLMs).

## Code repository

The code for this pattern is available in the GitHub [genai-knowledge-capture](#) repository.

The code repository contains the following files and folders:

- `assets` folder – The static assets for the solution, such as the architecture diagram and the public dataset
- `code/lambda`s folder – The Python code for all Lambda functions
  - `code/lambda`s/`generate` folder - The Python code that generates a document from the summarized data in the S3 bucket
  - `code/lambda`s/`preprocess` folder - The Python code that processes the inputs for the Step Functions state machine
  - `code/lambda`s/`summarize` folder - The Python code that summarizes the transcribed data by using Amazon Bedrock service
  - `code/lambda`s/`transcribe` folder - The Python code that converts speech data (audio file) into text by using Amazon Transcribe
  - `code/lambda`s/`validate` folder - The Python code that validates whether all answers pertain to the same topic
- `code/code_stack.py` – The AWS CDK construct Python file that is used to create AWS resources
- `app.py` – The AWS CDK app Python file that is used to deploy AWS resources in the target AWS account
- `requirements.txt` – The list of all Python dependencies that must be installed for the AWS CDK
- `cdk.json` – The input file to provide values that are required to create resources

## Best practices

The code example provided is for proof-of-concept (PoC) or pilot purposes only. If you want to take the solution to production, use the following best practices:

- Enable [Amazon S3 access logging](#)
- Enable [VPC Flow Logs](#)

## Epics

### Set up AWS credentials on your local workstation

Task	Description	Skills required
Export variables for the account and AWS Region.	To provide AWS credentials for the AWS CDK by using environment variables, run the following commands. <pre>export CDK_DEFAULT_ACCOUNT=&lt;12-digit AWS account number&gt; export CDK_DEFAULT_REGION=&lt;Region&gt;</pre>	AWS DevOps, DevOps engineer
Set up the AWS CLI named profile.	To set up the AWS CLI named profile for the account, follow the instructions in <a href="#">Configuration and credential file settings</a> .	AWS DevOps, DevOps engineer

### Set up your environment

Task	Description	Skills required
Clone the repo to your local workstation.	To clone the <a href="#">genai-knowledge-capture</a> repository, run the following command in your terminal. <pre>git clone https://github.com/aws-samples/genai-knowledge-capture</pre>	AWS DevOps, DevOps engineer

Task	Description	Skills required
(Optional) Replace the audio files.	<p>To customize the sample application to incorporate your own data, do the following:</p> <ol style="list-style-type: none"><li>1. Navigate to the <code>assets/audio_samples</code> folder in the cloned repository.</li><li>2. Delete the folders containing the sample audio files.</li><li>3. Create a folder for each topic you want to analyze.</li><li>4. Transfer your audio files to their respective folders.</li></ol>	AWS DevOps, DevOps engineer
Set up the Python virtual environment.	<p>To set up the Python virtual environment, run the following commands.</p> <pre data-bbox="594 1157 1027 1476">cd genai-knowledge-capture python3 -m venv .venv source .venv/bin/activate pip install -r requirements.txt</pre>	AWS DevOps, DevOps engineer
Synthesize the AWS CDK code.	<p>To convert the code to an AWS CloudFormation stack configuration, run the following command.</p> <pre data-bbox="594 1730 1027 1808">cdk synth</pre>	AWS DevOps, DevOps engineer

## Configure and deploy the solution

Task	Description	Skills required
Provision foundation model access.	Enable access to the Anthropic Claude 3 Sonnet model for your AWS account. For instructions, see <a href="#">Add model access</a> in the Bedrock documentation.	AWS DevOps
Deploy resources in the account.	<p>To deploy resources in the AWS account by using the AWS CDK, do the following:</p> <ol style="list-style-type: none"><li>1. (Optional) In the root of the cloned repository, in the <code>app.py</code> file, update the AWS CloudFormation stack name. The default stack name is <code>genai-knowledge-capture-stack</code>.</li><li>2. To deploy resources, run the command <code>cdk deploy</code>.</li></ol> <p>The <code>cdk deploy</code> command uses <code>layer-3</code> constructs to create a set of Lambda functions, an S3 bucket, an Amazon SNS topic, and a Step Functions state machine. Audio files in the <code>assets/audio_samples</code> folder are</p>	AWS DevOps, DevOps engineer

Task	Description	Skills required
	<p>copied into the S3 bucket during deployment.</p> <ol style="list-style-type: none"> <li>3. Sign in to the AWS Management Console, and then open the CloudFormation console at <a href="https://console.aws.amazon.com/cloudformation/">https://console.aws.amazon.com/cloudformation/</a>.</li> <li>4. Confirm that the stack deployed successfully. For instructions, see <a href="#">Reviewing your stack on the AWS CloudFormation console</a>.</li> </ol>	
<p>Subscribe to the Amazon SNS topic.</p>	<p>To subscribe to the Amazon SNS topic for notification, do the following:</p> <ol style="list-style-type: none"> <li>1. In the CloudFormation console, in the navigate pane, choose <b>Stacks</b>.</li> <li>2. Choose the <code>genai-knowledge-capture-stack</code> stack.</li> <li>3. Choose the <b>Outputs</b> tab.</li> <li>4. Find the Amazon SNS topic name with the key <code>SNSTopicName</code>.</li> <li>5. Configure an email address to receive notifications by following the instructions in <a href="#">Subscribe an email address to an Amazon SNS topic</a>.</li> </ol>	<p>General AWS</p>

## Test the solution

Task	Description	Skills required
Run the state machine.	<ol style="list-style-type: none"><li>1. Open the <a href="#">Step Functions console</a>.</li><li>2. On the <b>State machines</b> page, choose <b>genai-knowledge-capture-stack-state-machine</b>.</li><li>3. Choose <b>Start execution</b>.</li><li>4. (Optional) In the <b>Name</b> box, enter a name for the execution.</li><li>5. In the <b>Input</b> area, enter the following JSON object by replacing the placeholder text, where:<ul style="list-style-type: none"><li>• &lt;Name&gt; is what you want to name the document.</li><li>• &lt;S3 bucket name&gt; is the name of the Amazon S3 bucket that contains the audio files.</li><li>• &lt;Folder path&gt; is the directory that contains the audio files.</li></ul></li></ol> <pre data-bbox="630 1566 1029 1885">{   "documentName":   "&lt;Name&gt;",   "audioFileFolderUri": "s3://&lt;S3 bucket name&gt;/&lt;Folder path&gt;" }</pre>	App developer, General AWS

Task	Description	Skills required
	<ol style="list-style-type: none"><li>6. Choose <b>Start Execution</b>.</li><li>7. On the execution details page, review the results and wait for the execution to complete.</li></ol>	

## Clean up all AWS resources in the solution

Task	Description	Skills required
Remove the AWS resources.	<p>After you test the solution, clean up the resources:</p> <ol style="list-style-type: none"><li>1. Delete all objects from the S3 bucket, and then delete the bucket. For more information, see <a href="#">Deleting a bucket</a>.</li><li>2. From the cloned repository, run the command <code>cdk destroy</code>.</li></ol>	AWS DevOps, DevOps engineer

## Related resources

### AWS documentation

- Amazon Bedrock resources:
  - [Model access](#)
  - [Inference parameters for foundation models](#)
- AWS CDK resources:
  - [Get started with the AWS CDK](#)
  - [Working with the AWS CDK in Python](#)
  - [Troubleshooting common AWS CDK issues](#)



- [Toolkit commands](#)
- AWS Step Functions resources:
  - [Getting started with AWS Step Functions](#)
  - [Troubleshooting](#)
- [Building Lambda functions with Python](#)
- [Generative AI Application Builder on AWS](#)

### Other resources

- [LangChain documentation](#)

# Generate personalized and re-ranked recommendations using Amazon Personalize

Created by Mason Cahill (AWS), Matthew Chasse (AWS), and Tayo Olajide (AWS)

<b>Code repository:</b> <a href="#">personalize-pet-recommendations</a>	<b>Environment:</b> PoC or pilot	<b>Technologies:</b> Machine learning & AI; CloudNative; DevOps; Infrastructure; Serverless
<b>Workload:</b> Open-source	<b>AWS services:</b> AWS CloudFormation; Amazon Data Firehose; AWS Lambda; Amazon Personalize; AWS Step Functions	

## Summary

This pattern shows you how to use Amazon Personalize to generate personalized recommendations—including re-ranked recommendations—for your users based on the ingestion of real-time user-interaction data from those users. The example scenario used in this pattern is based on a pet adoption website that generates recommendations for its users based on their interactions (for example, what pets a user visits). By following the example scenario, you learn to use Amazon Kinesis Data Streams to ingest interaction data, AWS Lambda to generate recommendations and re-rank the recommendations, and Amazon Data Firehose to store the data in an Amazon Simple Storage Service (Amazon S3) bucket. You also learn to use AWS Step Functions to build a state machine that manages the solution version (that is, a trained model) that generates your recommendations.

## Prerequisites and limitations

### Prerequisites

- An active [AWS account](#) with a [bootstrapped](#) AWS Cloud Development Kit (AWS CDK)
- [AWS Command Line Interface \(AWS CLI\)](#) with configured credentials

- [Python 3.9](#)

## Product versions

- Python 3.9
- AWS CDK 2.23.0 or later
- AWS CLI 2.7.27 or later

## Architecture

### Technology stack

- Amazon Data Firehose
- Amazon Kinesis Data Streams
- Amazon Personalize
- Amazon Simple Storage Service (Amazon S3)
- AWS Cloud Development Kit (AWS CDK)
- AWS Command Line Interface (AWS CLI)
- AWS Lambda
- AWS Step Functions

### Target architecture

The following diagram illustrates a pipeline for ingesting real-time data into Amazon Personalize. The pipeline then uses that data to generate personalized and re-ranked recommendations for users.

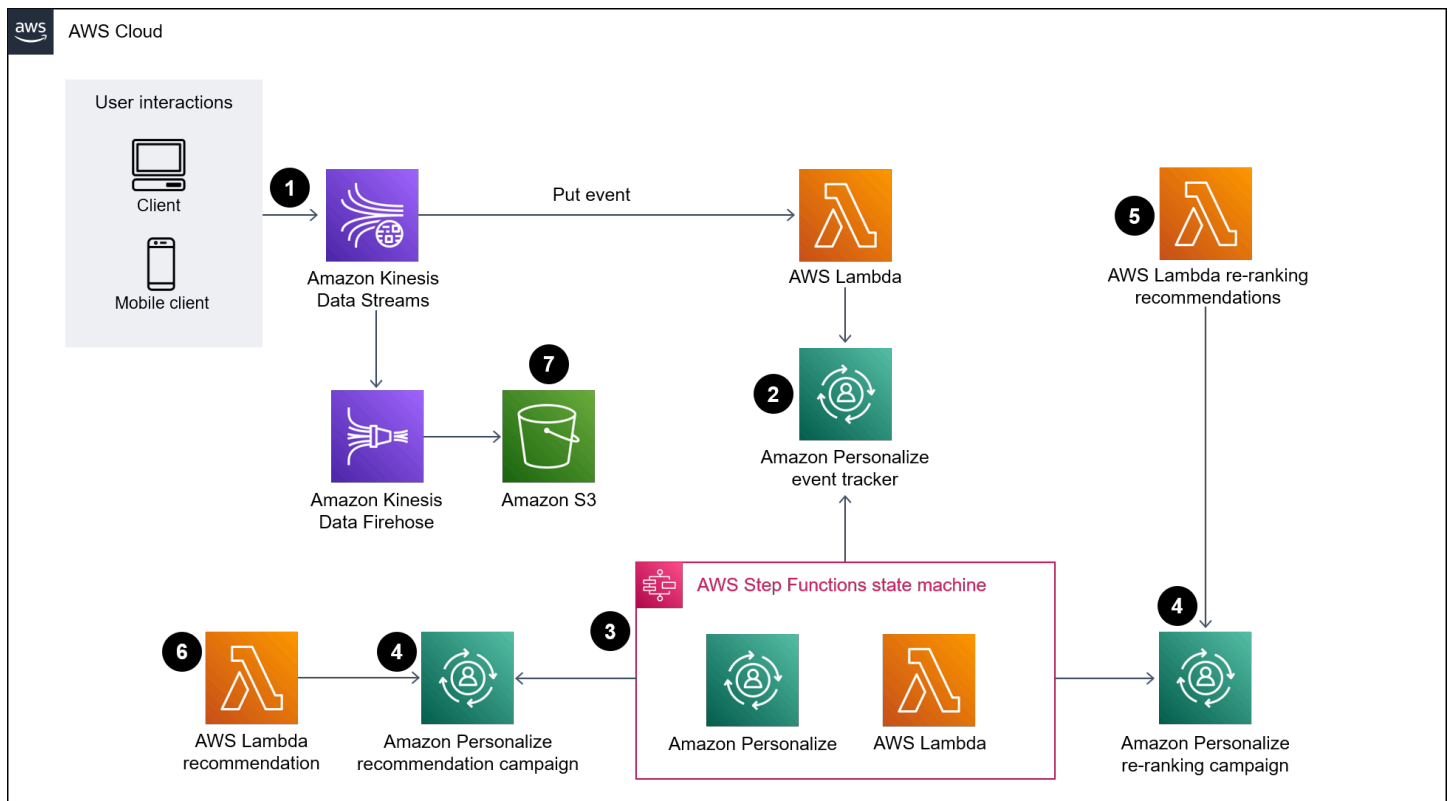

The diagram shows the following workflow:

1. Kinesis Data Streams ingests real-time user data (for example, events like visited pets) for processing by Lambda and Firehose.
2. A Lambda function processes the records from Kinesis Data Streams and makes an API call to add the user-interaction in the record to an event tracker in Amazon Personalize.
3. A time-based rule invokes a Step Functions state machine and generates new solution versions for the recommendation and re-ranking models by using the events from the event tracker in Amazon Personalize.
4. Amazon Personalize [campaigns](#) are updated by the state machine to use the new [solution version](#).
5. Lambda re-ranks the list of recommended items by calling the Amazon Personalize re-ranking campaign.
6. Lambda retrieves the list of recommended items by calling the Amazon Personalize recommendations campaign.
7. Firehose saves the events to an S3 bucket where they can be accessed as historical data.

## Tools

### AWS tools

- [AWS Cloud Development Kit \(AWS CDK\)](#) is a software development framework that helps you define and provision AWS Cloud infrastructure in code.
- [AWS Command Line Interface \(AWS CLI\)](#) is an open-source tool that helps you interact with AWS services through commands in your command-line shell.
- [Amazon Data Firehose](#) helps you deliver real-time [streaming data](#) to other AWS services, custom HTTP endpoints, and HTTP endpoints owned by supported third-party service providers.
- [Amazon Kinesis Data Streams](#) helps you collect and process large streams of data records in real time.
- [AWS Lambda](#) is a compute service that helps you run code without needing to provision or manage servers. It runs your code only when needed and scales automatically, so you pay only for the compute time that you use.
- [Amazon Personalize](#) is a fully managed machine learning (ML) service that helps you generate item recommendations for your users based on your data.
- [AWS Step Functions](#) is a serverless orchestration service that helps you combine Lambda functions and other AWS services to build business-critical applications.

### Other tools

- [pytest](#) is a Python framework for writing small, readable tests.
- [Python](#) is a general-purpose computer programming language.

### Code

The code for this pattern is available in the GitHub [Animal Recommender](#) repository. You can use the AWS CloudFormation template from this repository to deploy the resources for the example solution.

**Note:** The Amazon Personalize solution versions, event tracker, and campaigns are backed by [custom resources](#) (within the infrastructure) that expand on native CloudFormation resources.

# Epics

## Create the infrastructure

Task	Description	Skills required
Create an isolated Python environment.	<p><b>Mac/Linux setup</b></p> <ol style="list-style-type: none"><li>1. To manually create a virtual environment, run the <code>\$ python3 -m venv .venv</code> command from your terminal.</li><li>2. After the init process completes, run the <code>\$ source .venv/bin/activate</code> command to activate the virtual environment.</li></ol> <p><b>Windows setup</b></p> <p>To manually create a virtual environment, run the <code>% .venv\Scripts\activate.bat</code> command from your terminal.</p>	DevOps engineer
Synthesize the CloudFormation template.	<ol style="list-style-type: none"><li>1. To install the required dependencies, run the <code>\$ pip install -r requirements.txt</code> command from your terminal.</li><li>2. In the AWS CLI, set the following environment variables:</li></ol>	DevOps engineer

Task	Description	Skills required
	<ul style="list-style-type: none"><li>• <code>export ACCOUNT_ID=123456789</code></li><li>• <code>export CDK_DEPLOY_REGION=us-east-1</code></li><li>• <code>export CDK_ENVIRONMENT=dev</code></li></ul> <ol style="list-style-type: none"><li>3. In the <code>config/{env}.yaml</code> file, update <code>vpcId</code> to match your virtual private cloud (VPC) ID.</li><li>4. To synthesize the CloudFormation template for this code, run the <code>\$ cdk synth</code> command.</li></ol> <p><b>Note:</b> In step 2, <code>CDK_ENVIRONMENT</code> refers to the <code>config/{env}.yaml</code> file.</p>	

Task	Description	Skills required
Deploy resources and create infrastructure.	<p>To deploy the solution resources, run the <code>./deploy.sh</code> command from your terminal.</p> <p>This command installs the required Python dependencies. A Python script creates an S3 bucket and an AWS Key Management Service (AWS KMS) key, and then adds the seed data for the initial model creations. Finally, the script runs <code>cdk deploy</code> to create the remaining infrastructure.</p> <p><b>Note:</b> The initial model training happens during stack creation. It can take up to two hours for the stack to finish getting created.</p>	DevOps engineer

## Related resources

- [Animal Recommender](#) (GitHub)
- [AWS CDK Reference Documentation](#)
- [Boto3 Documentation](#)
- [Optimize personalized recommendations for a business metric of your choice with Amazon Personalize](#) (AWS Machine Learning Blog)

## Additional information

### Example payloads and responses



## Recommendation Lambda function

To retrieve recommendations, submit a request to the recommendation Lambda function with a payload in the following format:

```
{
  "userId": "3578196281679609099",
  "limit": 6
}
```

The following example response contains a list of animal groups:

```
[{"id": "1-domestic short hair-1-1"},
{"id": "1-domestic short hair-3-3"},
{"id": "1-domestic short hair-3-2"},
{"id": "1-domestic short hair-1-2"},
{"id": "1-domestic short hair-3-1"},
{"id": "2-beagle-3-3"},
```

If you leave out the `userId` field, the function returns general recommendations.

## Re-ranking Lambda function

To use re-ranking, submit a request to the re-ranking Lambda function. The payload contains the `userId` of all the item IDs to be re-ranked and their metadata. The following example data uses the Oxford Pets classes for `animal_species_id` (1=cat, 2=dog) and integers 1-5 for `animal_age_id` and `animal_size_id`:

```
{
  "userId": "12345",
  "itemMetadataList": [
    {
      "itemId": "1",
      "animalMetadata": {
        "animal_species_id": "2",
        "animal_primary_breed_id": "Saint_Bernard",
        "animal_size_id": "3",
        "animal_age_id": "2"
      }
    },
    {
      "itemId": "2",
```

```
    "animalMetadata":{
      "animal_species_id":"1",
      "animal_primary_breed_id":"Egyptian_Mau",
      "animal_size_id":"1",
      "animal_age_id":"1"
    }
  },
  {
    "itemId":"3",
    "animalMetadata":{
      "animal_species_id":"2",
      "animal_primary_breed_id":"Saint_Bernard",
      "animal_size_id":"3",
      "animal_age_id":"2"
    }
  }
]
}
```

The Lambda function re-ranks these items, and then returns an ordered list that includes the item IDs and the direct response from Amazon Personalize. This is a ranked list of the animal groups that the items are in and their score. Amazon Personalize uses [User-Personalization](#) and [Personalized-Ranking](#) recipes to include a score for each item in the recommendations. These scores represent the relative certainty that Amazon Personalize has about which item the user will choose next. Higher scores represent greater certainty.

```
{
  "ranking":[
    "1",
    "3",
    "2"
  ],
  "personalizeResponse":{
    "ResponseMetadata":{
      "RequestId":"a2ec0417-9dcd-4986-8341-a3b3d26cd694",
      "HTTPStatusCode":200,
      "HTTPHeaders":{
        "date":"Thu, 16 Jun 2022 22:23:33 GMT",
        "content-type":"application/json",
        "content-length":"243",
        "connection":"keep-alive",
        "x-amzn-requestid":"a2ec0417-9dcd-4986-8341-a3b3d26cd694"
      }
    }
  }
}
```

```
    },
    "RetryAttempts":0
  },
  "personalizedRanking":[
    {
      "itemId":"2-Saint_Bernard-3-2",
      "score":0.8947961
    },
    {
      "itemId":"1-Siamese-1-1",
      "score":0.105204
    }
  ],
  "recommendationId":"RID-d97c7a87-bd4e-47b5-a89b-ac1d19386aec"
}
}
```

### *Amazon Kinesis payload*

The payload to send to Amazon Kinesis has the following format:

```
{
  "Partitionkey": "randomstring",
  "Data": {
    "userId": "12345",
    "sessionId": "sessionId4545454",
    "eventType": "DetailView",
    "animalMetadata": {
      "animal_species_id": "1",
      "animal_primary_breed_id": "Russian_Blue",
      "animal_size_id": "1",
      "animal_age_id": "2"
    },
    "animal_id": "98765"
  }
}
```

**Note:** The `userId` field is removed for an unauthenticated user.

# Train and deploy a custom GPU-supported ML model on Amazon SageMaker

*Created by Ankur Shukla (AWS)*

**Environment:** PoC or pilot

**Technologies:** Machine learning & AI; Containers & microservices

**AWS services:** Amazon ECS; Amazon SageMaker

## Summary

Training and deploying a graphics processing unit (GPU)-supported machine learning (ML) model requires an initial setup and initialization of certain environment variables to fully unlock the benefits of NVIDIA GPUs. However, it can be time-consuming to set up the environment and make it compatible with Amazon SageMaker architecture on the Amazon Web Services (AWS) Cloud.

This pattern helps you train and build a custom GPU-supported ML model using Amazon SageMaker. It provides steps to train and deploy a custom CatBoost model built on an open-source Amazon reviews dataset. You can then benchmark its performance on a p3.16xlarge Amazon Elastic Compute Cloud (Amazon EC2) instance.

This pattern is useful if your organization wants to deploy existing GPU-supported ML models on SageMaker. Your data scientists can follow the steps in this pattern to create NVIDIA GPU-supported containers and deploy ML models on those containers.

## Prerequisites and limitations

### Prerequisites

- An active AWS account.
- An Amazon Simple Storage Service (Amazon S3) source bucket to store the model artifacts and predictions.
- An understanding of SageMaker notebook instances and Jupyter notebooks.
- An understanding of how to create an AWS Identity and Access Management (IAM) role with basic SageMaker role permissions, S3 bucket access and update permissions, and additional permissions for Amazon Elastic Container Registry (Amazon ECR).

## Limitations

- This pattern is intended for supervised ML workloads with a train and deploy code written in Python.

## Architecture

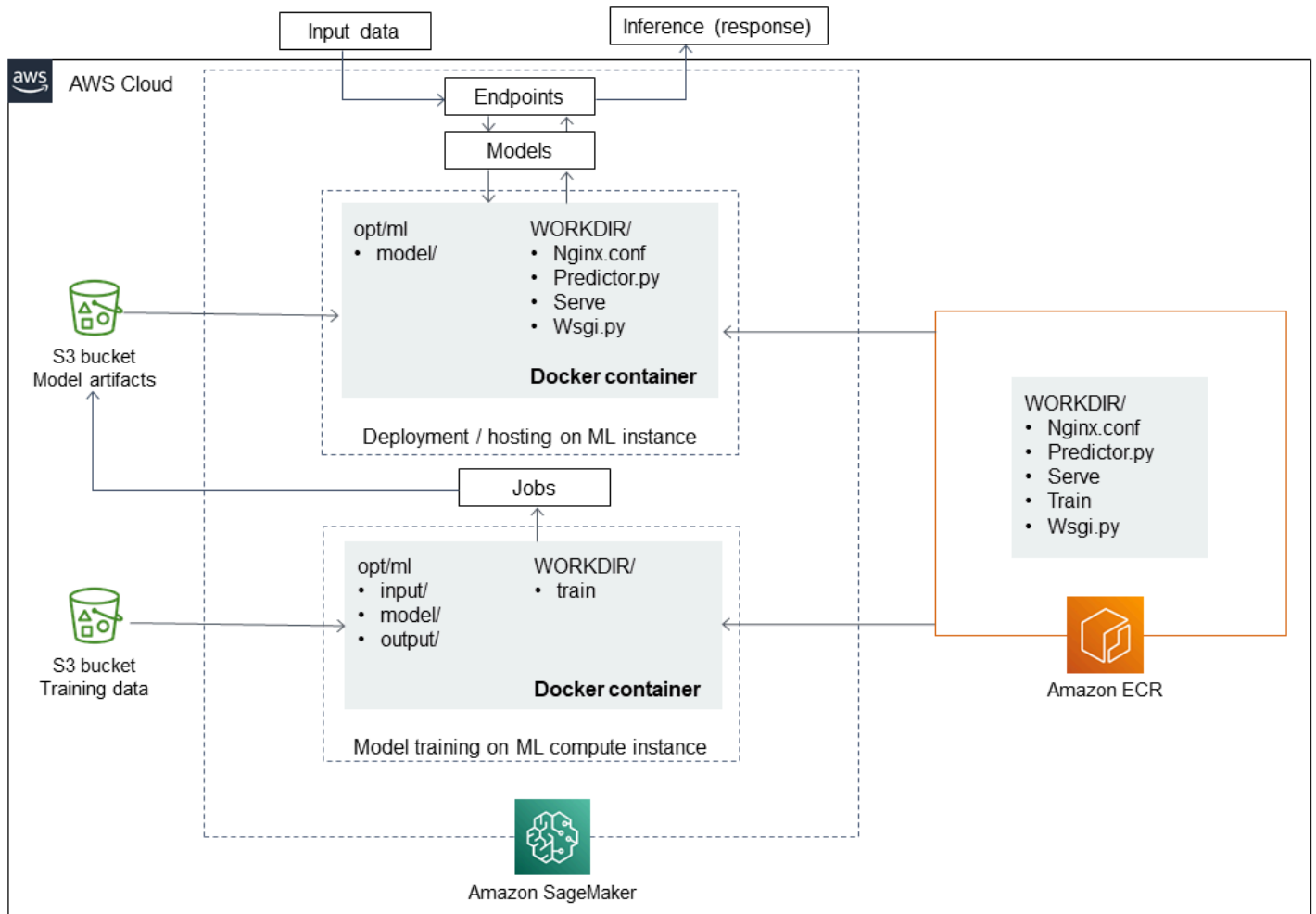

## Technology stack

- SageMaker
- Amazon ECR

## Tools

### Tools

- [Amazon ECR](#) – Amazon Elastic Container Registry (Amazon ECR) is an AWS managed container image registry service that is secure, scalable, and reliable.
- [Amazon SageMaker](#) – SageMaker is a fully managed ML service.
- [Docker](#) – Docker is a software platform for building, testing, and deploying applications quickly.
- [Python](#) – Python is a programming language.

### Code

The code for this pattern is available on the GitHub [Implementing a review classification model with Catboost and SageMaker](#) repository.

## Epics

### Prepare the data

Task	Description	Skills required
Create an IAM role and attach the required policies.	<p>Sign in to the AWS Management Console, open the IAM console, and create a new IAM role. Attach the following policies to the IAM role:</p> <ul style="list-style-type: none"><li>• AmazonEC2ContainerRegistryFullAccess</li><li>• AmazonS3FullAccess</li><li>• AmazonSageMakerFullAccess</li></ul> <p>For more information about this, see <a href="#">Create a notebook</a></p>	Data scientist

Task	Description	Skills required
	<p><a href="#">instance</a> in the Amazon SageMaker documentation.</p>	
Create the SageMaker notebook instance.	<p>Open the SageMaker console, choose <b>Notebook instances</b>, and then choose <b>Create notebook instance</b>. For <b>IAM role</b>, choose the IAM role that you created earlier. Configure the notebook instance according to your requirements and then choose <b>Create notebook instance</b>.</p> <p>For detailed steps and instructions, see <a href="#">Create a notebook instance</a> in the Amazon SageMaker documentation.</p>	Data scientist
Clone the repository.	<p>Open the terminal in the SageMaker notebook instance and clone the GitHub <a href="#">Implementing a review classification model with Catboost and SageMaker</a> repository by running the following command:</p> <pre data-bbox="594 1570 1027 1812">git clone https://github.com/aws-samples/review-classification-using-catboost-sagemaker.git</pre>	

Task	Description	Skills required
Start the Jupyter notebook.	Start the Review classification model with Catboost and SageMaker.ipynb Jupyter notebook, which contains the predefined steps.	Data scientist

## Feature engineering

Task	Description	Skills required
Run commands in Jupyter notebook.	Open the Jupyter notebook and run the commands from the following stories to prepare the data to train your ML model.	Data scientist
Read the data from the S3 bucket.	<pre>import pandas as pd import csv fname = 's3://amazon-reviews-pds/tsv/amazon_reviews_us_Digital_Video_Download_v1_00.tsv.gz' df = pd.read_csv(fname, sep='\t', delimiter='\t', error_bad_lines=False)</pre>	Data scientist
Preprocess the data.	<pre>import numpy as np def pre_process(df):      df.fillna(value={'review_body': '', 'review_headline': ''}, inplace=True)</pre>	Data scientist



Task	Description	Skills required
	<pre>df.fillna( value={'verified_purchase': 'Unk'}, inplace=True)  df.fillna(0, inplace=True) return df df = pre_process(df) df.review_date = pd.to_datetime(df. review_date) df['target'] = np.where(df['star_ rating']&gt;=4,1,0)</pre> <p><b>Note:</b> This code replaces null values in the 'review_body' with an empty string and replaces the 'verified_purchase' column with 'Unk', which means "unknown."</p>	

Task	Description	Skills required
Split the data into training, validation, and test datasets.	<p>To keep the distribution of the target label identical across the split sets, you must stratify the sampling by using the <a href="#">scikit-learn library</a>.</p> <pre data-bbox="594 491 1027 1845">from sklearn.model_selection import StratifiedShuffleSplit sss = StratifiedShuffleSplit(n_splits=2, test_size=0.10, random_state=0) sss.get_n_splits(df, df['target']) for train_index, test_index in sss.split(df, df['target']):     X_train_val, X_test = df.iloc[train_index], df.iloc[test_index]  sss.get_n_splits(X_train_val, X_train_val['target']) for train_index, test_index in sss.split(X_train_val, X_train_val['target']):     X_train, X_val = X_train_val.iloc[train_index], X_train_val.iloc[test_index]</pre>	Data scientist

## Build, run, and push the Docker image to Amazon ECR

Task	Description	Skills required
Prepare and push the Docker image.	In the Jupyter notebook, run the commands from the following stories to prepare the Docker image and push it to Amazon ECR.	ML engineer
Create a repository in Amazon ECR.	<pre>%%sh  algorithm_name=sagemaker-catboost-github-gpu-img  chmod +x code/train chmod +x code/serve  account=\$(aws sts get-caller-identity --query Account --output text)  # Get the region defined in the current configuration (default to us-west-2 if none defined) region=\$(aws configure get region) region=\${region:-us-east-1}  fullname="\${account}.dkr.ecr.\${region}.amazonaws.com/\${algorithm_name}:latest"  aws ecr create-repository --repository-</pre>	ML engineer

Task	Description	Skills required
	<pre>name "\${algorithm_name} " &gt; /dev/nul</pre>	
Build a Docker image locally.	<pre>docker build -t "\${algorithm_name}" . docker tag \${algorit hm_name} \${fullname}</pre>	ML engineer
Run the Docker image and push it to Amazon ECR.	<pre>docker push \${fullname}</pre>	ML engineer

## Training

Task	Description	Skills required
Create a SageMaker hyperparameter tuning job.	In the Jupyter notebook, run the commands from the following stories to create a SageMaker hyperparameter tuning job using your Docker image.	Data scientist
Create a SageMaker estimator .	Create a <a href="#">SageMaker estimator</a> by using the Docker image's name. <pre>import sagemaker as sage from time import gmtime, strftime sess = sage.Session() from sagemaker.tuner import IntegerPa rameter, Categori alParameter, Continuou sParameter, Hyperpara meterTuner</pre>	Data scientist

Task	Description	Skills required
	<pre>account = sess.boto _session.client('s ts').get_caller_id entity()['Account'] region = sess.boto _session.region_name image = '{}.dkr.e cr.{}.amazonaws.co m/sagemaker-catboo st-github-gpu-img: latest'.format(acc ount, region) tree_hpo = sage.esti mator.Estimator(im age,  role, 1,  'ml.p3.16xlarge',  train_volume_size = 100,  output_path="s3:// {}/sagemaker/DEMO- GPU-Catboost/outputs".format(bucket),  sagemaker_session= sess)</pre>	

Task	Description	Skills required
Create an HPO job.	<p>Create a hyperparameter optimization (HPO) tuning job with parameter ranges and pass the train and validation sets as parameters to the function.</p> <pre data-bbox="594 537 1029 1822">hyperparameter_ranges = {'iterations': IntegerParameter(80000, 130000),      'max_depth': IntegerParameter(6, 10),      'max_ctr_complexity': IntegerParameter(4, 10),      'learning_rate': ContinuousParameter(0.01, 0.5)}  objective_metric_name = 'auc' metric_definitions = [{'Name': 'auc',      'Regex': 'auc: ([0-9\\.]+'}]  tuner = HyperparameterTuner(tree_hpo,      objective_metric_name,      hyperparameter_ranges,</pre>	Data scientist

Task	Description	Skills required
	<pre>metric_definitions , objective_type='Ma ximize', max_jobs=50, max_parallel_jobs= 2)</pre>	
Run the HPO job.	<pre>train_location = 's3://' + bucket + '/s agemaker/DEMO-GPU- Catboost/data/train/' valid_location = 's3://' + bucket + '/s agemaker/DEMO-GPU- Catboost/data/valid/'  tuner.fit({'train': train_location, 'validati on': valid_location })</pre>	Data scientist
Receive the best performing training job.	<pre>import sagemaker as sage from time import gmtime, strftime sess = sage.Session()  best_job =tuner.be st_training_job()</pre>	Data scientist

## Batch transform

Task	Description	Skills required
<p>Create a SageMaker batch transform job on test data for model prediction.</p>	<p>In the Jupyter notebook, run the commands from the following stories to create the model from your SageMaker hyperparameter tuning job and submit a SageMaker batch transform job on the test data for model prediction.</p>	<p>Data scientist</p>
<p>Create the SageMaker model.</p>	<p>Create a model in SageMaker model using the best training job.</p> <pre data-bbox="594 953 1026 1881"> attached_estimator =   sage.estimator.Estimator.attach(best_job)  output_path = 's3://' +   bucket + '/sagemaker/DEMO-GPU-Catboost/data/test-predictions/' input_path = 's3://' +   bucket + '/sagemaker/DEMO-GPU-Catboost/data/test/'  transformer = attached_estimator.transformer(instance_count=1,  instance_type='ml.p3.16xlarge', </pre>	<p>Data scientist</p>



Task	Description	Skills required
	<pre> assemble_with='Line',  accept='text/csv',  max_payload=1,  output_path=output_path,  env = {'SAGEMAKER_MODEL_SERVER_TIMEOUT' : '3600' }) </pre>	
Create batch transform job.	<p>Create batch transform job on the test data set.</p> <pre> transformer.transform(input_path,  content_type='text/csv',  split_type='Line') </pre>	Data scientist

## Analyze the results

Task	Description	Skills required
Read the results and evaluate the model's performance.	In the Jupyter notebook, run the commands from the following stories to read	Data scientist

Task	Description	Skills required
	<p>the results and evaluate the performance of the model on Area Under the ROC Curve (ROC-AUC) and Area Under the Precision Recall Curve (PR-AUC) model metrics.</p> <p>For more information about this, see <a href="#">Amazon Machine Learning key concepts</a> in the Amazon Machine Learning (Amazon ML) documentation.</p>	
Read the batch transform job results.	<p>Read the batch transform job results into a data frame.</p> <pre data-bbox="597 919 1027 1675">file_name = 's3://' + bucket + '/sagemaker/DEMO-GPU-Catboost/data/test-predictions/file_1.out'  results =     pd.read_csv(file_name, names=['review_id', 'target', 'score'], sep='\t', escapechar='\\', quoting=csv.QUOTE_NONE,      lineterminator='\n', quotechar='') display(results)</pre>	Data scientist

Task	Description	Skills required
Evaluate the performance metrics.	<p>Evaluate the performance of the model on ROC-AUC and PR-AUC.</p> <pre data-bbox="592 394 1027 1877">from sklearn import metrics import matplotlib import pandas as pd matplotlib.use('agg', warn=False, force=True) from matplotlib import pyplot as plt  %matplotlib inline  def analyze_results(labels, predictions):     precision, recall,     thresholds = metrics.p recision_recall_cu rve(labels, predictio ns)     auc = metrics.a uc(recall, precision)      fpr, tpr, _ = metrics.roc_curve( labels, predictions)     roc_auc_score = metrics.roc_auc_sc ore(labels, predictio ns)      print('Neural- Nets: ROC auc=%.3f' % ( roc_auc_score))      plt.plot(fpr, tpr, label="data 1, auc=" + str(roc_auc_score))</pre>	Data scientist

Task	Description	Skills required
	<pre>plt.xlabel('1-Specificity') plt.ylabel('Sensitivity') plt.legend(loc=4) plt.show()  lr_precision, lr_recall, _ = metrics.precision_ recall_curve(labels, predictions) lr_auc = metrics.a uc(lr_recall, lr_precision) # summarize scores print('Neural- Nets: PR auc=%.3f' % (lr_auc)) # plot the precision -recall curves no_skill = len(label s[labels==1.0]) / len(labels) plt.plot([0, 1], [no_skill, no_skill] , linestyle='--', label='No Skill')  plt.plot(lr_recall , lr_precision, marker='.', label='Ne ural-Nets') # axis labels plt.xlabel('Recall ') plt.ylabel('Precis ion') # show the legend plt.legend() # show the plot</pre>	

Task	Description	Skills required
	<pre>plt.show()  return auc  analyze_results(results['target'].values, results['score'].values)</pre>	

## Related resources

- [Train and host Scikit-Learn models in Amazon SageMaker by building a Scikit Docker container](#)

## Additional information

The following list shows the different elements of the Dockerfile that is run in the *Build, run, and push the Docker image into Amazon ECR* epic.

### Install Python with aws-cli.

```
FROM amazonlinux:1

RUN yum update -y && yum install -y python36 python36-devel python36-libs python36-
tools python36-pip && \
yum install gcc tar make wget util-linux kmod man sudo git -y && \
yum install wget -y && \
yum install aws-cli -y && \
yum install nginx -y && \
yum install gcc-c++.noarch -y && yum clean all
```

### Install the Python packages

```
RUN pip-3.6 install --no-cache-dir --upgrade pip && \pip3 install --no-cache-dir --
upgrade setuptools && \
pip3 install Cython && \
```

```
pip3 install --no-cache-dir numpy==1.16.0 scipy==1.4.1 scikit-learn==0.20.3
pandas==0.24.2 \
flask gevent unicorn boto3 s3fs matplotlib joblib catboost==0.20.2
```

## Install CUDA and CuDNN

```
RUN wget https://developer.nvidia.com/compute/cuda/9.0/Prod/local_installers/
cuda_9.0.176_384.81_linux-run \
&& chmod u+x cuda_9.0.176_384.81_linux-run \
&& ./cuda_9.0.176_384.81_linux-run --tmpdir=/data --silent --toolkit --override \
&& wget https://custom-gpu-sagemaker-image.s3.amazonaws.com/installation/cudnn-9.0-
linux-x64-v7.tgz \
&& tar -xvzf cudnn-9.0-linux-x64-v7.tgz \
&& cp /data/cuda/include/cudnn.h /usr/local/cuda/include \
&& cp /data/cuda/lib64/libcudnn* /usr/local/cuda/lib64 \

&& chmod a+r /usr/local/cuda/include/cudnn.h /usr/local/cuda/lib64/libcudnn* \
&& rm -rf /data/*
```

## Create the required directory structure for SageMaker

```
RUN mkdir /opt/ml /opt/ml/input /opt/ml/input/config /opt/ml/input/data /opt/ml/input/
data/training /opt/ml/model /opt/ml/output /opt/program
```

## Set the NVIDIA environment variables

```
ENV PYTHONPATH=/opt/program
ENV PYTHONUNBUFFERED=TRUE
ENV PYTHONDONTWRITEBYTECODE=TRUE
ENV PATH="/opt/program:${PATH}"

# Set NVIDIA mount environments
ENV LD_LIBRARY_PATH=/usr/local/nvidia/lib:/usr/local/nvidia/lib64:$LD_LIBRARY_PATH
ENV NVIDIA_VISIBLE_DEVICES="all"
ENV NVIDIA_DRIVER_CAPABILITIES="compute,utility"
ENV NVIDIA_REQUIRE_CUDA "cuda>=9.0"
```

## Copy training and inference files into the Docker image

```
COPY code/* /opt/program/
WORKDIR /opt/program
```



# Use SageMaker Processing for distributed feature engineering of terabyte-scale ML datasets

Created by Chris Boomhower (AWS)

**Environment:** Production

**Technologies:** Machine learning & AI; Big data

**AWS services:** Amazon SageMaker

## Summary

Many terabyte-scale or larger datasets often consist of a hierarchical folder structure, and the files in the dataset sometimes share interdependencies. For this reason, machine learning (ML) engineers and data scientists must make thoughtful design decisions to prepare such data for model training and inference. This pattern demonstrates how you can use manual macrosharding and microsharding techniques in combination with Amazon SageMaker Processing and virtual CPU (vCPU) parallelization to efficiently scale feature engineering processes for complicated big data ML datasets.

This pattern defines *macrosharding* as the splitting of data directories across multiple machines for processing, and *microsharding* as the splitting of data on each machine across multiple processing threads. The pattern demonstrates these techniques by using Amazon SageMaker with sample time-series waveform records from the [PhysioNet MIMIC-III](#) dataset. By implementing the techniques in this pattern, you can minimize the processing time and costs for feature engineering while maximizing resource utilization and throughput efficiency. These optimizations rely on distributed SageMaker Processing on Amazon Elastic Compute Cloud (Amazon EC2) instances and vCPUs for similar, large datasets, regardless of data type.

## Prerequisites and limitations

### Prerequisites

- Access to SageMaker notebook instances or SageMaker Studio, if you want to implement this pattern for your own dataset. If you are using Amazon SageMaker for the first time, see [Get started with Amazon SageMaker](#) in the AWS documentation.
- SageMaker Studio, if you want to implement this pattern with the [PhysioNet MIMIC-III](#) sample data.



- The pattern uses SageMaker Processing, but doesn't require any experience running SageMaker Processing jobs.

## Limitations

- This pattern is well suited to ML datasets that include interdependent files. These interdependencies benefit the most from manual macrosharding and running multiple, single-instance SageMaker Processing jobs in parallel. For datasets where such interdependencies do not exist, the `ShardedByS3Key` feature in SageMaker Processing might be a better alternative to macrosharding, because it sends sharded data to multiple instances that are managed by the same Processing job. However, you can implement this pattern's microsharding strategy in both scenarios to best utilize instance vCPUs.

## Product versions

- Amazon SageMaker Python SDK version 2

## Architecture

### Target technology stack

- Amazon Simple Storage Service (Amazon S3)
- Amazon SageMaker

### Target architecture

#### *Macrosharding and distributed EC2 instances*

The 10 parallel processes represented in this architecture reflect the structure of the MIMIC-III dataset. (Processes are represented by ellipses for diagram simplification.) A similar architecture applies to any dataset when you use manual macrosharding. In the case of MIMIC-III, you can use the dataset's raw structure to your advantage by processing each patient group folder separately, with minimal effort. In the following diagram, the record groups block appears on the left (1). Given the distributed nature of the data, it makes sense to shard by patient group.

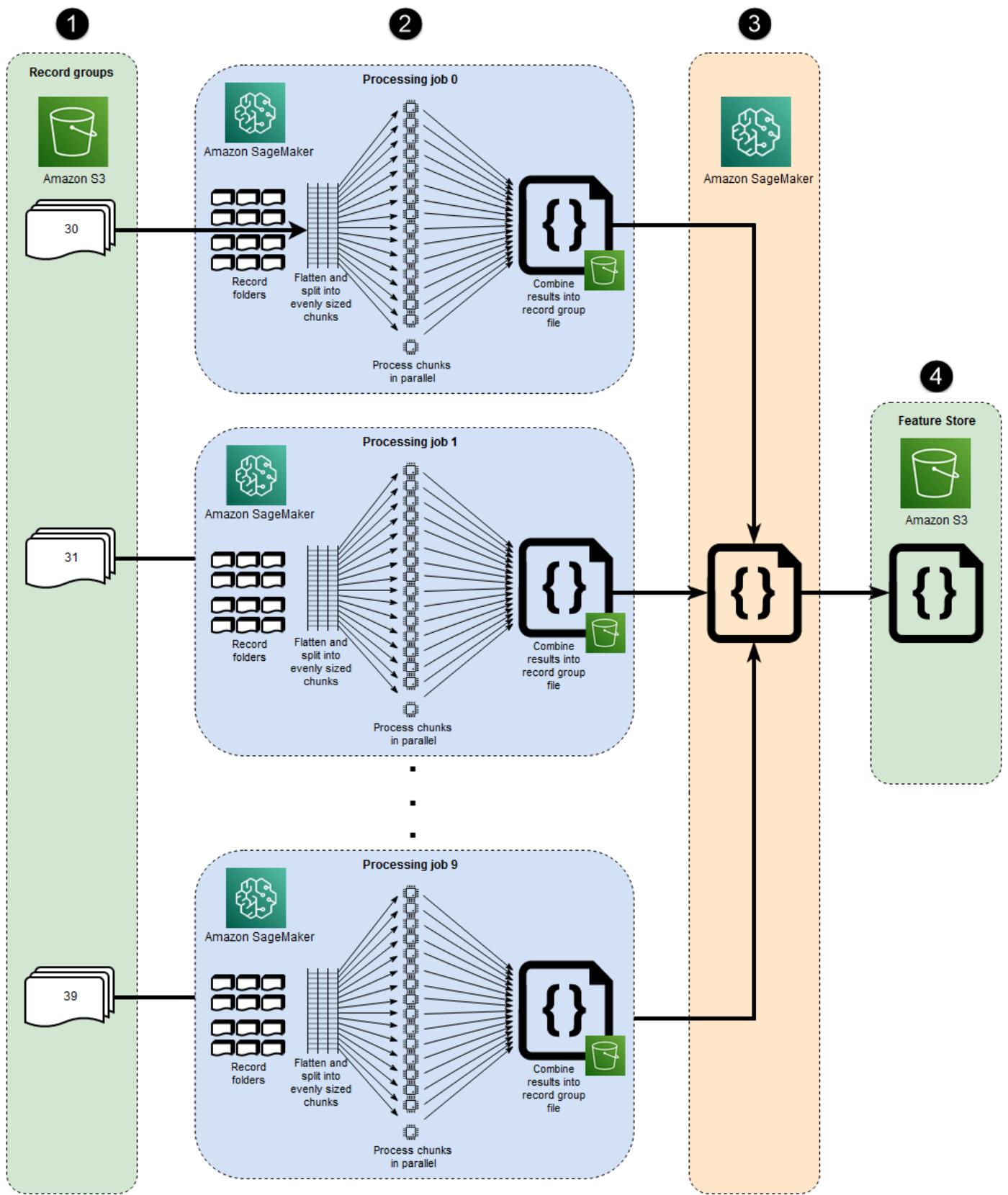

However, manually sharding by patient group means that a separate Processing job is required for each patient group folder, as you can see in the middle section of the diagram (2), instead of a single Processing job with multiple EC2 instances. Because MIMIC-III's data includes both binary waveform files and matching text-based header files, and there is a required dependency on the [wfdb library](#) for binary data extraction, all the records for a specific patient must be made available on the same instance. The only way to be certain that each binary waveform file's associated header file is also present is to implement manual sharding to run each shard within its own Processing job, and to specify `s3_data_distribution_type='FullyReplicated'` when you define the Processing job input. Alternatively, if all data were available in a single directory and no dependencies existed between files, a more suitable option might be to launch a single Processing job with multiple EC2 instances and `s3_data_distribution_type='ShardedByS3Key'` specified. Specifying `ShardedByS3Key` as the Amazon S3 data distribution type directs SageMaker to manage data sharding automatically across instances.

Launching a Processing job for each folder is a cost-efficient way to preprocess the data, because running multiple instances concurrently saves time. For additional cost and time savings, you can use microsharding within each Processing job.

### *Microsharding and parallel vCPUs*

Within each Processing job, the grouped data is further divided to maximize use of all available vCPUs on the SageMaker fully managed EC2 instance. The blocks in the middle section of the diagram (2) depict what happens within each primary Processing job. The contents of the patient record folders are flattened and divided evenly based on the number of available vCPUs on the instance. After the folder contents are divided, the evenly sized set of files are distributed across all vCPUs for processing. When processing is complete, the results from each vCPU are combined into a single data file for each Processing job.

In the attached code, these concepts are represented in the following section of the `src/feature-engineering-pass1/preprocessing.py` file.

```
def chunks(lst, n):
    """
    Yield successive n-sized chunks from lst.

    :param lst: list of elements to be divided
    :param n: number of elements per chunk
    :type lst: list
    :type n: int
```

```
:return: generator comprising evenly sized chunks
:rtype: class 'generator'
"""
for i in range(0, len(lst), n):
    yield lst[i:i + n]

# Generate list of data files on machine
data_dir = input_dir
d_subs = next(os.walk(os.path.join(data_dir, '.')))[1]
file_list = []
for ds in d_subs:
    file_list.extend(os.listdir(os.path.join(data_dir, ds, '.')))
dat_list = [os.path.join(re.split('_|\.', f)[0].replace('n', ''), f[:-4]) for f in
    file_list if f[-4:] == '.dat']

# Split list of files into sub-lists
cpu_count = multiprocessing.cpu_count()
splits = int(len(dat_list) / cpu_count)
if splits == 0: splits = 1
dat_chunks = list(chunks(dat_list, splits))

# Parallelize processing of sub-lists across CPUs
ws_df_list = Parallel(n_jobs=-1, verbose=0)(delayed(run_process)(dc) for dc in
    dat_chunks)

# Compile and pickle patient group dataframe
ws_df_group = pd.concat(ws_df_list)
ws_df_group = ws_df_group.reset_index().rename(columns={'index': 'signal'})
ws_df_group.to_json(os.path.join(output_dir, group_data_out))
```

A function, `chunks`, is first defined to consume a given list by dividing it into evenly sized chunks of length `n` and by returning these results as a generator. Next, the data is flattened across patient folders by compiling a list of all binary waveform files that are present. After this is done, the number of vCPUs available on the EC2 instance is obtained. The list of binary waveform files is evenly divided across these vCPUs by calling `chunks`, and then each waveform sublist is processed on its own vCPU by using [joblib's Parallel class](#). Results are automatically combined into a single list of dataframes by the Processing job, which SageMaker then processes further before writing it to Amazon S3 upon job completion. In this example, there are 10 files written to Amazon S3 by the Processing jobs (one for each job).

When all the initial Processing jobs are complete, a secondary Processing job, which is shown in the block to the right of the diagram (3) combines the output files produced by each primary Processing job and writes the combined output to Amazon S3 (4).

## Tools

### Tools

- [Python](#) – The sample code used for this pattern is Python (version 3).
- [SageMaker Studio](#) – Amazon SageMaker Studio is a web-based, integrated development environment (IDE) for machine learning that lets you build, train, debug, deploy, and monitor your machine learning models. You run SageMaker Processing jobs by using Jupyter notebooks inside SageMaker Studio.
- [SageMaker Processing](#) – Amazon SageMaker Processing provides a simplified way to run your data processing workloads. In this pattern, the feature engineering code is implemented at scale by using SageMaker Processing jobs.

### Code

The attached .zip file provides the complete code for this pattern. The following section describes the steps to build the architecture for this pattern. Each step is illustrated by sample code from the attachment.

## Epics

### Set up your SageMaker Studio environment

Task	Description	Skills required
Access Amazon SageMaker Studio.	Onboard to SageMaker Studio in your AWS account by following the directions provided in the <a href="#">Amazon SageMaker documentation</a> .	Data scientist, ML engineer
Install the wget utility.	Install <i>wget</i> if you onboarded with a new SageMaker Studio configuration or if you've	Data scientist, ML engineer

Task	Description	Skills required
	<p>never used these utilities in SageMaker Studio before.</p> <p>To install, open a terminal window in the SageMaker Studio console and run the following command:</p> <pre>sudo yum install wget</pre>	
Download and unzip the sample code.	<p>Download the attachments.zip file in the <i>Attachments</i> section. In a terminal window, navigate to the folder where you downloaded the file and extract its contents:</p> <pre>unzip attachment.zip</pre> <p>Navigate to the folder where you extracted the .zip file, and extract the contents of the Scaled-Processing.zip file.</p> <pre>unzip Scaled-Processing.zip</pre>	Data scientist, ML engineer

Task	Description	Skills required
Download the sample dataset from <a href="https://physionet.org">physionet.org</a> and upload it to Amazon S3.	Run the <code>get_data.ipynb</code> Jupyter notebook within the folder that contains the <code>Scaled-Processing</code> files. This notebook downloads a sample MIMIC-III dataset from <a href="https://physionet.org">physionet.org</a> and uploads it to your SageMaker Studio session bucket in Amazon S3.	Data scientist, ML engineer

### Configure the first preprocessing script

Task	Description	Skills required
Flatten the file hierarchy across all subdirectories.	<p>In large datasets such as MIMIC-III, files are often distributed across multiple subdirectories even within a logical parent group. Your script should be configured to flatten all group files across all subdirectories, as the following code demonstrates.</p> <pre># Generate list of .dat files on machine data_dir = input_dir d_subs = next(os.walk(os.path.join(data_dir, '.')))[1] file_list = [] for ds in d_subs:     file_list.extend(os.listdir(os.path.</pre>	Data scientist, ML engineer

Task	Description	Skills required
	<pre> join(data_dir, ds,       '.')) dat_list = [os.path. join(re.split('_ \ .', f)[0].replace('n', '), f[:-4]) for f in file_list if f[-4:] == '.dat'] </pre> <p><b>Note</b> The example code snippets in this epic are from the <code>src/feature-engineering-pass1/preprocessing.py</code> file, which is provided in the attachment.</p>	
<p>Divide files into subgroups based on vCPU count.</p>	<p>Files should be divided into evenly sized subgroups, or chunks, depending on the number of vCPUs present on the instance that runs the script. For this step, you can implement code similar to the following.</p> <pre> # Split list of files into sub-lists cpu_count = multiprocessing. cpu_count() splits = int(len(d at_list) / cpu_count) if splits == 0: splits = 1 dat_chunks = list(chun ks(dat_list, splits)) </pre>	<p>Data scientist, ML engineer</p>



Task	Description	Skills required
Parallelize processing of subgroups across vCPUs.	<p>Script logic should be configured to process all subgroups in parallel. To do this, use the Joblib library's <code>Parallel</code> class and <code>delayed</code> method as follows.</p> <pre data-bbox="597 537 1026 894"># Parallelize processing of sub-lists across CPUs ws_df_list = Parallel( n_jobs=-1, verbose=0) (delayed(run_process) (dc) for dc in dat_chunks)</pre>	Data scientist, ML engineer

Task	Description	Skills required
Save single file group output to Amazon S3.	<p>When parallel vCPU processing is complete, the results from each vCPU should be combined and uploaded to the file group's S3 bucket path. For this step, you can use code similar to the following.</p> <pre data-bbox="597 632 1027 1188"> # Compile and pickle patient group dataframe ws_df_group = pd.concat (ws_df_list) ws_df_group = ws_df_group .reset_index().r ename(columns={'index': 'signal'}) ws_df_group.to_j son(os.path.join(o utput_dir, group_dat a_out)) </pre>	Data scientist, ML engineer

## Configure the second preprocessing script

Task	Description	Skills required
Combine data files produced across all Processing jobs that ran the first script.	The previous script outputs a single file for each SageMaker Processing job that processes a group of files from the dataset. Next, you need to combine these output files into a single object and write a single output dataset to Amazon S3. This is demonstra	Data scientist, ML engineer

Task	Description	Skills required
	<p>ted in the src/feature-engineering-pass1p5/preprocessing.py file, which is provided in the attachment, as follows.</p> <pre data-bbox="592 472 1031 1877">def write_parquet(wavs_df, path):     """     Write waveform summary dataframe to S3 in parquet format.      :param wavs_df:     waveform summary dataframe     :param path: S3 directory prefix     :type wavs_df:     pandas dataframe     :type path: str     :return: None     """     extra_args = {"ServerSideEncryption": "aws:kms"}     wr.s3.to_parquet(df=wavs_df, path=path, compression='snappy', s3_additional_kwargs=extra_args)  def combine_data():     """     Get combined data and write to parquet.</pre>	

Task	Description	Skills required
	<pre> : return: waveform summary dataframe : rtype: pandas dataframe """ wavs_df = get_data( ) wavs_df = normalize _signal_names(wavs _df) write_parquet(wavs _df, "s3://{}/{}/" {}.format(bucket_xform, dataset_p refix, pass1p5ou t_data))  return wavs_df  wavs_df = combine_d ata() </pre>	

## Run Processing jobs

Task	Description	Skills required
Run the first Processing job.	To perform macrosharding, run a separate Processing job for each file group. Microsharding is performed inside each Processing job, because each job runs your first script. The following code demonstrates how to launch a Processing job for each file group directory in the	Data scientist, ML engineer

Task	Description	Skills required
	<p>following snippet (included in notebooks/FeatExtract_Pass1.ipynb ).</p> <pre>pat_groups = list(range(30,40)) ts = str(int(time.time()))  for group in pat_groups:     sklearn_processor = SKLearnProcessor(         framework_version='0.20.0',         role=role,         instance_type='ml.m5.4xlarge',         instance_count=1,         volume_size_in_gb=5)     sklearn_processor.run(         code='../src/feature-engineering-pass1/preprocessing.py',         job_name='-'.join(['scaled-processing-p1', str(group), ts]),         arguments=["input_path", "/opt/ml/processing/input",</pre>	

Task	Description	Skills required
	<pre>                 "output_p ath", "/opt/ml/ processing/output",                 "group_da ta_out", "ws_df_gr oup.json"             ],             inputs=             [                 Processin gInput(                  source=f's3://{ses s.default_bucket()}/ data_inputs/{group}',                  destination='/opt/ml/ processing/input',                  s3_data_distributi on_type='FullyRepl icated'              )             ],             outputs=             [                 Processin gOutput(                  source='/opt/ml/pr ocessing/output',                  destination=f's3:/ /{sess.default_buc ket()}/data_outputs/ {group}'              )             ],             wait=False         ) </pre>	

Task	Description	Skills required
Run the second Processing job.	<p>To combine the outputs generated by the first set of processing jobs and perform any additional computations for preprocessing, you run your second script by using a single SageMaker Processing job. The following code demonstrates this (included in notebooks/FeatExtract_Pass1p5.ipynb ).</p> <pre data-bbox="597 779 1026 1785">ts = str(int(time.time( ))) bucket = sess.default_bucket()  sklearn_processor =     SKLearnProcessor(         framework_version=' 0.20.0',          role=role,          instance_ type='ml.t3.2xlarge',          instance_ count=1,          volume_si ze_in_gb=5) sklearn_processor.run(     code='../src/feature-engineering-pass1p5/preprocessing.py',</pre>	Data scientist, ML engineer

Task	Description	Skills required
	<pre> job_name='-'.join( ['scaled-processing', 'p1p5', ts]), arguments=['bucket ', bucket,           'passlout _prefix', 'data_out puts',           'passlout _data', 'ws_df_gr oup.json',           'pass1p5o ut_data', 'waveform _summary.parquet',           'statsdat a_name', 'signal_s tats.csv'], wait=True ) </pre>	

## Related resources

- [Onboard to Amazon SageMaker Studio Using Quick Start](#) (SageMaker documentation)
- [Process Data](#) (SageMaker documentation)
- [Data Processing with scikit-learn](#) (SageMaker documentation)
- [joblib.Parallel documentation](#)
- Moody, B., Moody, G., Villarroel, M., Clifford, G. D., & Silva, I. (2020). [MIMIC-III Waveform Database](#) (version 1.0). *PhysioNet*.
- Johnson, A. E. W., Pollard, T. J., Shen, L., Lehman, L. H., Feng, M., Ghassemi, M., Moody, B., Szolovits, P., Celi, L. A., & Mark, R. G. (2016). [MIMIC-III, a freely accessible critical care database](#). *Scientific Data*, 3, 160035.
- [MIMIC-III Waveform Database license](#)



## Attachments

To access additional content that is associated with this document, unzip the following file:

[attachment.zip](#)

# Visualize AI/ML model results using Flask and AWS Elastic Beanstalk

Created by Chris Caudill (AWS) and Durga Sury

**Environment:** PoC or pilot

**Technologies:** Machine learning & AI; Analytics; DevOps; Web & mobile apps

**Workload:** Open-source

**AWS services:** Amazon Comprehend; AWS Elastic Beanstalk

## Summary

Visualizing output from artificial intelligence and machine learning (AI/ML) services often requires complex API calls that must be customized by your developers and engineers. This can be a drawback if your analysts want to quickly explore a new dataset.

You can enhance the accessibility of your services and provide a more interactive form of data analysis by using a web-based user interface (UI) that enables users to upload their own data and visualize the model results in a dashboard.

This pattern uses [Flask](#) and [Plotly](#) to integrate Amazon Comprehend with a custom web application and visualize sentiments and entities from user-provided data. The pattern also provides the steps to deploy an application by using AWS Elastic Beanstalk. You can adapt the application by using [Amazon Web Services \(AWS\) AI services](#) or with a custom trained model hosted on an endpoint (for example, an [Amazon SageMaker endpoint](#)).

## Prerequisites and limitations

### Prerequisites

- An active AWS account.
- AWS Command Line Interface (AWS CLI), installed and configured on your local machine. For more information about this, see [Configuration basics](#) in the AWS CLI documentation. You can

also use an AWS Cloud9 integrated development environment (IDE); for more information about this, see [Python tutorial for AWS Cloud9](#) and [Previewing running applications in the AWS Cloud9 IDE](#) in the AWS Cloud9 documentation.

- An understanding of Flask's web application framework. For more information about Flask, see the [Quickstart](#) in the Flask documentation.
- Python version 3.6 or later, installed and configured. You can install Python by following the instructions from [Setting up your Python development environment](#) in the AWS Elastic Beanstalk documentation.
- Elastic Beanstalk Command Line Interface (EB CLI), installed and configured. For more information about this, see [Install the EB CLI](#) and [Configure the EB CLI](#) from the AWS Elastic Beanstalk documentation.

## Limitations

- This pattern's Flask application is designed to work with .csv files that use a single text column and are restricted to 200 rows. The application code can be adapted to handle other file types and data volumes.
- The application doesn't consider data retention and continues to aggregate uploaded user files until they are manually deleted. You can integrate the application with Amazon Simple Storage Service (Amazon S3) for persistent object storage or use a database such as Amazon DynamoDB for serverless key-value storage.
- The application only considers documents in the English language. However, you can use Amazon Comprehend to detect a document's primary language. For more information about the supported languages for each action, see [API reference](#) in the Amazon Comprehend documentation.
- A troubleshooting list that contains common errors and their solutions is available in the *Additional information* section.

## Architecture

### Flask application architecture

Flask is a lightweight framework for developing web applications in Python. It is designed to combine Python's powerful data processing with a rich web UI. The pattern's Flask application shows you how to build a web application that enables users to upload data, sends the data to

Amazon Comprehend for inference, and then visualizes the results. The application has the following structure:

- `static` – Contains all the static files that support the web UI (for example, JavaScript, CSS, and images)
- `templates` – Contains all of the application's HTML pages
- `userData` – Stores uploaded user data
- `application.py` – The Flask application file
- `comprehend_helper.py` – Functions to make API calls to Amazon Comprehend
- `config.py` – The application configuration file
- `requirements.txt` – The Python dependencies required by the application

The `application.py` script contains the web application's core functionality, which consists of four Flask routes. The following diagram shows these Flask routes.

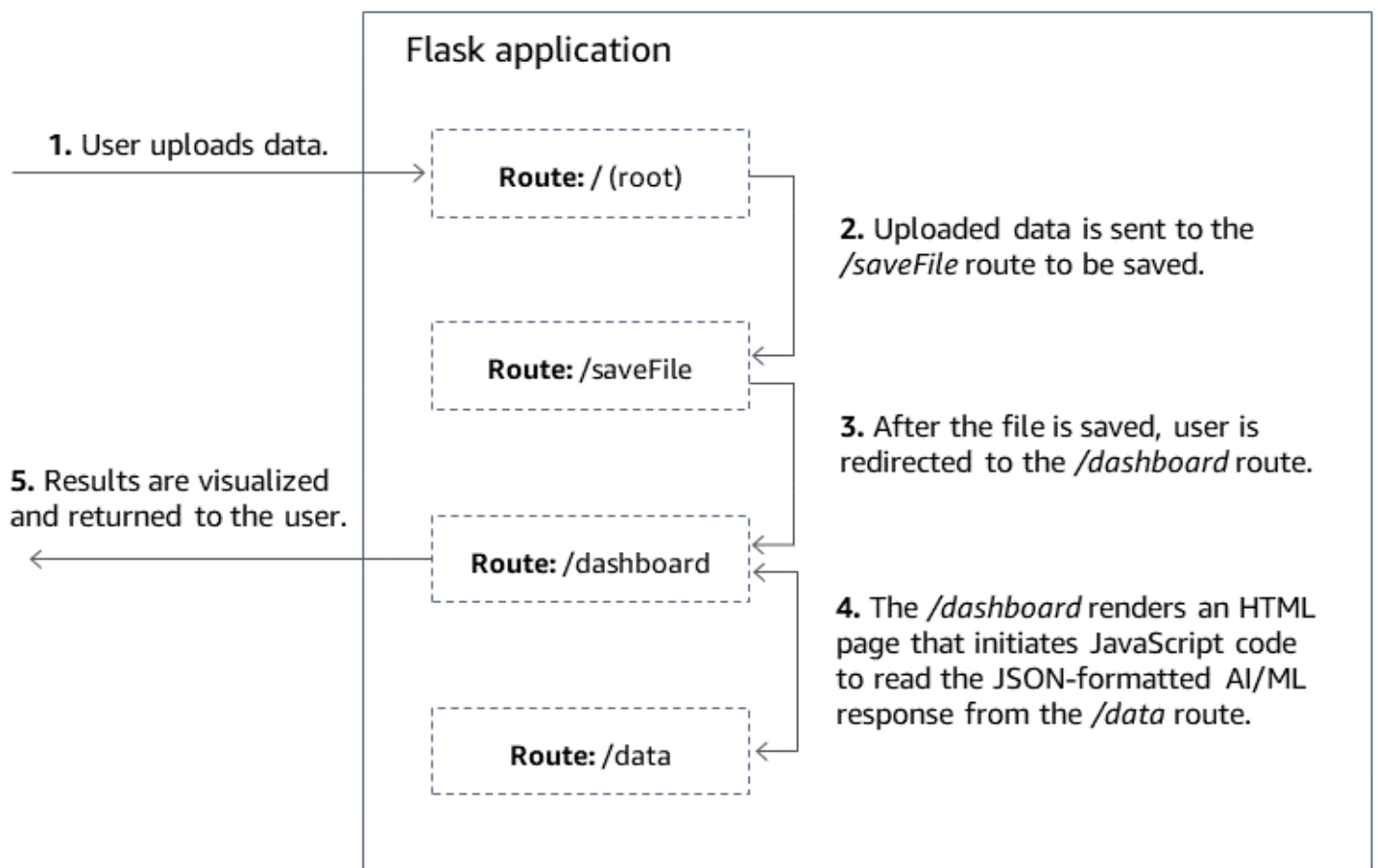

- `/` is the application's root and directs users to the `upload.html` page (stored in the `templates` directory).
- `/saveFile` is a route that is invoked after a user uploads a file. This route receives a POST request via an HTML form, which contains the file uploaded by the user. The file is saved in the `userData` directory and the route redirects users to the `/dashboard` route.
- `/dashboard` sends users to the `dashboard.html` page. Within this page's HTML, it runs the JavaScript code in `static/js/core.js` that reads data from the `/data` route and then builds visualizations for the page.
- `/data` is a JSON API that presents the data to be visualized in the dashboard. This route reads the user-provided data and uses the functions in `comprehend_helper.py` to send the user data to Amazon Comprehend for sentiment analysis and named entity recognition (NER). Amazon Comprehend's response is formatted and returned as a JSON object.

## Deployment architecture

For more information about design considerations for applications deployed using Elastic Beanstalk on the AWS Cloud, see in the [AWS Elastic Beanstalk documentation](#).

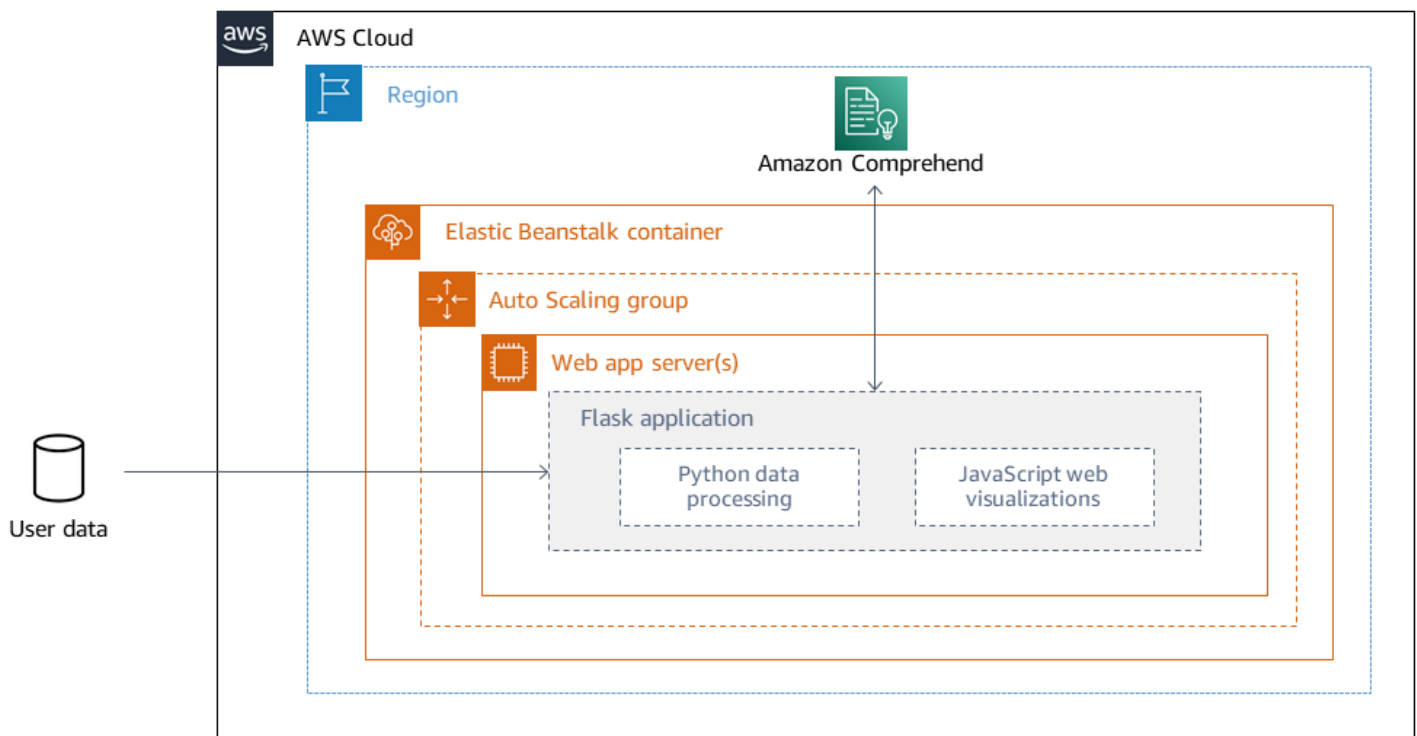

## [Design considerations](#)

## Technology stack

- Amazon Comprehend
- Elastic Beanstalk
- Flask

## Automation and scale

Elastic Beanstalk deployments are automatically set up with load balancers and auto scaling groups. For more configuration options, see [Configuring Elastic Beanstalk environments](#) in the AWS Elastic Beanstalk documentation.

## Tools

- [AWS Command Line Interface \(AWS CLI\)](#) is a unified tool that provides a consistent interface for interacting with all parts of AWS.
- [Amazon Comprehend](#) uses natural language processing (NLP) to extract insights about the content of documents without requiring special preprocessing.
- [AWS Elastic Beanstalk](#) helps you quickly deploy and manage applications in the AWS Cloud without having to learn about the infrastructure that runs those applications.
- [Elastic Beanstalk CLI \(EB CLI\)](#) is a command line interface for AWS Elastic Beanstalk that provides interactive commands to simplify creating, updating, and monitoring environments from a local repository.
- The [Flask](#) framework performs data processing and API calls using Python and offers interactive web visualization with Plotly.

## Code

The code for this pattern is available in the GitHub [Visualize AI/ML model results using Flask and AWS Elastic Beanstalk](#) repository.

## Epics

### Set up the Flask application

Task	Description	Skills required
Clone the GitHub repository.	Pull the application code from the GitHub <a href="#">Visualize AI/ML</a>	Developer

Task	Description	Skills required
	<p><a href="#">model results using Flask and AWS Elastic Beanstalk</a> repository by running the following command:</p> <pre>git clone git@github.com:aws-samples/aws-comprehend-elasticbeanstalk-for-flask.git</pre> <p><b>Note:</b> Make sure that you configure your SSH keys with GitHub.</p>	
Install the Python modules.	<p>After you clone the repository, a new local <code>aws-comprehend-elasticbeanstalk-for-flask</code> directory is created. In that directory, the <code>requirements.txt</code> file contains the Python modules and versions that run the application. Use the following commands to install the modules:</p> <pre>cd aws-comprehend-elasticbeanstalk-for-flask</pre> <pre>pip install -r requirements.txt</pre>	Python developer

Task	Description	Skills required
Test the application locally.	<p>Start the Flask server by running the following command:</p> <pre>python application.py</pre> <p>This returns information about the running server. You should be able to access the application by opening a browser and visiting <code>http://localhost:5000</code></p> <p><b>Note:</b> If you're running the application in an AWS Cloud9 IDE, you need to replace the <code>application.run()</code> command in the <code>application.py</code> file with the following line:</p> <pre>application.run(host=os.getenv('IP', '0.0.0.0'),port=int(os.getenv('PORT', 8080)))</pre> <p>You must revert this change before deployment.</p>	Python developer



## Deploy the application to Elastic Beanstalk

Task	Description	Skills required
Launch the Elastic Beanstalk application.	<p>To launch your project as an Elastic Beanstalk application, run the following command from your application's root directory:</p> <pre>eb init -p python-3.6 comprehend_flask --region us-east-1</pre> <p><b>Important:</b></p> <ul style="list-style-type: none"><li>• <code>comprehend_flask</code> is the name of the Elastic Beanstalk application and can be changed according to your requirements.</li><li>• You can replace the AWS Region with a Region of your choice. The default Region in AWS CLI is used if you don't specify a Region.</li><li>• The application was built with Python version 3.6. You might encounter errors if you use other Python versions.</li></ul> <p>Run the <code>eb init -i</code> command for more deployment configuration options.</p>	Architect, Developer

Task	Description	Skills required
Deploy the Elastic Beanstalk environment.	<p>Run the following command from the application's root directory:</p> <pre>eb create comprehend-flask-env</pre> <p><b>Note:</b> <code>comprehend-flask-env</code> is the name of the Elastic Beanstalk environment and can be changed according to your requirements. The name can only contain letters, numbers, and dashes.</p>	Architect, Developer

Task	Description	Skills required
Authorize your deployment to use Amazon Comprehend.	<p>Although your application might be successfully deployed, you should also provide your deployment with access to Amazon Comprehend. <code>ComprehendFullAccess</code> is an AWS managed policy that provides the deployed application with permissions to make API calls to Amazon Comprehend.</p> <p>Attach the <code>ComprehendFullAccess</code> policy to <code>aws-elasticbeanstalk-ec2-role</code> (this role is automatically created for your deployment's Amazon Elastic Compute Cloud (Amazon EC2) instances) by running the following command:</p> <pre>aws iam attach-role-policy --policy-arn arn:aws:iam::aws:policy/ComprehendFullAccess --role-name aws-elasticbeanstalk-ec2-role</pre> <p><b>Important:</b> <code>aws-elasticbeanstalk-ec2-role</code> is created when your application deploys. You must</p>	Developer, Security architect

Task	Description	Skills required
	complete the deployment process before you can attach the AWS Identity and Access Management (IAM) policy.	
Visit your deployed application.	<p>After your application successfully deploys, you can visit it by running the <code>eb open</code> command.</p> <p>You can also run the <code>eb status</code> command to receive details about your deployment. The deployment URL is listed under <code>CNAME</code>.</p>	Architect, Developer

### (Optional) Customize the application to your ML model

Task	Description	Skills required
Authorize Elastic Beanstalk to access the new model.	<p>Make sure that Elastic Beanstalk has the required access permissions for your new model endpoint. For example, if you use an Amazon SageMaker endpoint, your deployment needs to have permission to invoke the endpoint.</p> <p>For more information about this, see <a href="#">InvokeEndpoint</a> in the Amazon SageMaker documentation.</p>	Developer, Security architect

Task	Description	Skills required
Send the user data to a new model.	<p>To change the underlying ML model in this application, you must change the following files:</p> <ul style="list-style-type: none"><li>• <code>comprehend_helper.py</code> – This is the Python script that connects with Amazon Comprehend, processes the response, and returns the final result to the application. In this script, you can either route the data to another AI service on the AWS Cloud or you can send the data to a custom model endpoint. We recommend that you also format the results in this script for logical separation and the reusability of this pattern.</li><li>• <code>application.py</code> – If you change the name of the <code>comprehend_helper.py</code> script or functions, you need to update the <code>application.py</code> script to reflect those changes.</li></ul>	Data scientist

Task	Description	Skills required
Update the dashboard visualizations.	<p>Typically, incorporating a new ML model means that visualizations must be updated to reflect the new results. These changes are made in the following files:</p> <ul style="list-style-type: none"><li>• <code>templates/dashboard.html</code> – The prebuilt application only accounts for two basic visualizations. The entire layout of the page can be adjusted in this file.</li><li>• <code>static/js/core.js</code> – This script captures the formatted output of the Flask server's <code>/data</code> route and uses Plotly to create visualizations. You can add or update the page's charts.</li></ul>	Web developer

### (Optional) Deploy the updated application

Task	Description	Skills required
Update your application's requirements file.	Before sending changes to Elastic Beanstalk, update the <code>requirements.txt</code> file to reflect any new Python modules by running the following command in your application's root directory:	Python developer

Task	Description	Skills required
	<pre>pip freeze &gt; requirements.txt</pre>	
Redeploy the Elastic Beanstalk environment.	<p>To ensure that your application changes are reflected in your Elastic Beanstalk deployment, navigate to your application's root directory and run the following command:</p> <pre>eb deploy</pre> <p>This sends the most recent version of the application's code to your existing Elastic Beanstalk deployment.</p>	Systems administrator, Architect

## Related resources

- [Call an Amazon SageMaker model endpoint using Amazon API Gateway and AWS Lambda](#)
- [Deploying a Flask application to Elastic Beanstalk](#)
- [EB CLI command reference](#)
- [Setting up your Python development environment](#)

## Additional information

### Troubleshooting list

The following are six common errors and their solutions.

#### **Error 1**

```
Unable to assume role "arn:aws:iam:xxxxxxxxxx:role/aws-elasticbeanstalk-ec2-role".  
Verify that the role exists and is configured correctly.
```

**Solution:** If this error occurs when you run `eb create`, create a sample application on the Elastic Beanstalk console to create the default instance profile. For more information about this, see [Creating an Elastic Beanstalk environment](#) in the AWS Elastic Beanstalk documentation.

### Error 2

```
Your WSGIPath refers to a file that does not exist.
```

**Solution:** This error occurs in deployment logs because Elastic Beanstalk expects the Flask code to be named `application.py`. If you chose a different name, run `eb config` and edit the `WSGIPath` as shown in the following code sample:

```
aws:elasticbeanstalk:container:python:
  NumProcesses: '1'
  NumThreads: '15'
  StaticFiles: /static/=static/
  WSGIPath: application.py
```

Make sure that you replace `application.py` with your file name.

You can also leverage Gunicorn and a Procfile. For more information about this approach, see [Configuring the WSGI server with a Procfile](#) in the AWS Elastic Beanstalk documentation.

### Error 3

```
Target WSGI script '/opt/python/current/app/application.py' does not contain WSGI
application 'application'.
```

**Solution:** Elastic Beanstalk expects the variable that represents your Flask application to be named `application`. Make sure that the `application.py` file uses `application` as the variable name:

```
application = Flask(__name__)
```

### Error 4

```
The EB CLI cannot find your SSH key file for keyname
```

**Solution:** Use the EB CLI to specify which key pair to use or to create a key pair for your deployment's EC2 instances. To resolve the error, run `eb init -i` and one of the options will ask:



Do you want to set up SSH for your instances?

Respond with Y to either create a key pair or specify an existing key pair.

### **Error 5**

*I've updated my code and redeployed but my deployment is not reflecting my changes.*

**Solution:** If you're using a Git repository with your deployment, make sure that you add and commit your changes before redeploying.

### **Error 6**

*You are previewing the Flask application from an AWS Cloud9 IDE and run into errors.*

**Solution:** For more information about this, see [Previewing running applications in the AWS Cloud9 IDE](#) in the AWS Cloud9 documentation.

## **Natural language processing using Amazon Comprehend**

By choosing to use Amazon Comprehend, you can detect custom entities in individual text documents by running real-time analysis or asynchronous batch jobs. Amazon Comprehend also enables you to train custom entity recognition and text classification models that can be used in real time by creating an endpoint.

This pattern uses asynchronous batch jobs to detect sentiments and entities from an input file that contains multiple documents. The sample application provided by this pattern is designed for users to upload a .csv file containing a single column with one text document per row. The `comprehend_helper.py` file in the GitHub [Visualize AI/ML model results using Flask and AWS Elastic Beanstalk](#) repository reads the input file and sends the input to Amazon Comprehend for processing.

### *BatchDetectEntities*

Amazon Comprehend inspects the text of a batch of documents for named entities and returns the detected entity, location, [type of entity](#), and a score that indicates Amazon Comprehend's level of confidence. A maximum of 25 documents can be sent in one API call, with each document smaller than 5,000 bytes in size. You can filter the results to show only certain entities based on the use case. For example, you could skip the 'quantity' entity type and set a threshold

score for the detected entity (for example, 0.75). We recommend that you explore the results for your specific use case before choosing a threshold value. For more information about this, see [BatchDetectEntities](#) in the Amazon Comprehend documentation.

### *BatchDetectSentiment*

Amazon Comprehend inspects a batch of incoming documents and returns the prevailing sentiment for each document (POSITIVE, NEUTRAL, MIXED, or NEGATIVE). A maximum of 25 documents can be sent in one API call, with each document smaller than 5,000 bytes in size. Analyzing the sentiment is straightforward and you choose the sentiment with the highest score to be displayed in the final results. For more information about this, see [BatchDetectSentiment](#) in the Amazon Comprehend documentation.

## Flask configuration handling

Flask servers use a series of [configuration variables](#) to control how the server runs. These variables can contain debug output, session tokens, or other application settings. You can also define custom variables that can be accessed while the application is running. There are multiple approaches for setting configuration variables.

In this pattern, the configuration is defined in `config.py` and inherited within `application.py`.

- `config.py` contains the configuration variables that are set up on the application's startup. In this application, a `DEBUG` variable is defined to tell the application to run the server in [debug mode](#). **Note:** Debug mode should not be used when running an application in a production environment. `UPLOAD_FOLDER` is a custom variable that is defined to be referenced later in the application and inform it where uploaded user data should be stored.
- `application.py` initiates the Flask application and inherits the configuration settings defined in `config.py`. This is performed by the following code:

```
application = Flask(__name__)
application.config.from_pyfile('config.py')
```

## More patterns

- [Generate data insights by using AWS Mainframe Modernization and Amazon Q in QuickSight](#)
- [Give SageMaker notebook instances temporary access to a CodeCommit repository in another AWS account](#)
- [Migrate ML Build, Train, and Deploy workloads to Amazon SageMaker using AWS Developer Tools](#)
- [Perform advanced analytics using Amazon Redshift ML](#)

# Mainframe

## Topics

- [Access AWS services from IBM z/OS by installing the AWS CLI](#)
- [Back up and archive mainframe data to Amazon S3 using BMC AMI Cloud Data](#)
- [Build an advanced mainframe file viewer in the AWS Cloud](#)
- [Containerize mainframe workloads that have been modernized by Blu Age](#)
- [Convert and unpack EBCDIC data to ASCII on AWS by using Python](#)
- [Convert mainframe files from EBCDIC format to character-delimited ASCII format in Amazon S3 using AWS Lambda](#)
- [Convert mainframe data files with complex record layouts using Micro Focus](#)
- [Deploy an environment for containerized Blu Age applications by using Terraform](#)
- [Generate data insights by using AWS Mainframe Modernization and Amazon Q in QuickSight](#)
- [Integrate Stonebranch Universal Controller with AWS Mainframe Modernization](#)
- [Migrate and replicate VSAM files to Amazon RDS or Amazon MSK using Connect from Precisely](#)
- [Modernize mainframe output management on AWS by using OpenText Micro Focus Enterprise Server and LRS PageCenterX](#)
- [Modernize mainframe batch printing workloads on AWS by using Micro Focus Enterprise Server and LRS VPSX/MFI](#)
- [Modernize mainframe online printing workloads on AWS by using Micro Focus Enterprise Server and LRS VPSX/MFI](#)
- [Move mainframe files directly to Amazon S3 using Transfer Family](#)
- [Transfer large-scale Db2 z/OS data to Amazon S3 in CSV files](#)
- [More patterns](#)

# Access AWS services from IBM z/OS by installing the AWS CLI

Created by Souma Ghosh (AWS), Phil de Valence (AWS), and Paulo Vitor Pereira (AWS)

**Environment:** Production

**Technologies:** Mainframe;  
Migration; Storage & backup

**Workload:** IBM

**AWS services:** AWS CLI; AWS  
Mainframe Modernization;  
Amazon S3

## Summary

The [AWS Command Line Interface \(AWS CLI\)](#) is an open source tool for managing multiple AWS services by using commands in a command line shell. With minimal configuration, you can run commands from command line sessions such as the command prompt, terminal, and bash shell to implement functionality that's equivalent to that provided by the browser-based AWS Management Console.

All AWS infrastructure as a service (IaaS) administration, management, and access functions in the AWS Management Console are available in the AWS API and AWS CLI. You can install the AWS CLI on an IBM z/OS mainframe to directly access, manage, and interact with AWS services from z/OS. The AWS CLI enables users and applications to perform various tasks, such as:

- Transferring files or datasets between z/OS and Amazon Simple Storage Service (Amazon S3) object storage and viewing content of buckets
- Starting and stopping different AWS resources; for example, starting a batch job in an AWS Mainframe Modernization environment
- Calling an AWS Lambda function to implement common business logic
- Integrating with artificial intelligence and machine learning (AI/ML) and analytics services

This pattern describes how to install, configure, and use the AWS CLI on z/OS. You can install it globally, so it's available to all z/OS users, or at a user level. The pattern also details how to use the AWS CLI in an interactive command line session from z/OS Unix System Services (USS) or as a batch job.

## Prerequisites and limitations

### Prerequisites

- **Network communication from z/OS to AWS**

By default, the AWS CLI sends requests to AWS services by using HTTPS on TCP port 443. To use the AWS CLI successfully, you must be able to make outbound connections on TCP port 443. You can use any of the following z/OS USS commands (some of these might not be installed in your environment) to test network connectivity from z/OS to AWS:

```
ping amazonaws.com
dig amazonaws.com
traceroute amazonaws.com
curl -k https://docs.aws.amazon.com/cli/v1/userguide/cli-chap-welcome.html
```

- **AWS credentials**

In order to communicate with AWS Cloud services from z/OS, the AWS CLI requires you to configure some credentials with privileges to access the target AWS account. For programmatic commands to AWS, you can use access keys, which consist of an access key ID and secret access key. If you don't have access keys, you can create them from the AWS Management Console. As a best practice, do not use the access keys for the AWS account root user for any task unless the root user is required. Instead, [create a new administrator IAM user](#) and [prepare for least-privilege permissions](#) to set up the user with access keys. After you create the user, you can [create an access key ID and secret access key](#) for this user.

**Warning:** AWS Identity and Access Management (IAM) users have long-term credentials that present a security risk. To help mitigate this risk, we recommend that you provide these users with only the permissions they require to perform the task and that you remove these users when they are no longer needed.

- **IBM Python for z/OS**

The AWS CLI requires Python 3.8 or later. IBM has enabled Python to run on z/OS with [IBM Open Enterprise Python for z/OS](#). IBM Open Enterprise Python is available at no charge through Shopz SMP/E, or you can download the PAX file from the [IBM website](#). For instructions, see the [installation and configuration documentation](#) for IBM Open Enterprise Python for z/OS.

## Limitations

- The installation instructions provided in this pattern are applicable to **AWS CLI version 1 only**. The latest version of the AWS CLI is version 2. However, this pattern uses the older version because the installation methods are different for version 2, and the binary executables available for version 2 aren't compatible with the z/OS system.

## Product versions

- AWS CLI version 1
- Python 3.8 or later

## Architecture

### Technology stack

- Mainframe running z/OS
- Mainframe z/OS UNIX System Services (USS)
- Mainframe Open MVS (OMVS) – z/OS UNIX shell environment command interface
- Mainframe disk, such as a direct-access storage device (DASD)
- AWS CLI

### Target architecture

The following diagram shows an AWS CLI deployment on IBM z/OS. You can invoke the AWS CLI from an interactive user session, such as SSH, and telnet sessions. You can also invoke it from a batch job by using job control language (JCL), or from any program that can call a z/OS Unix shell command.

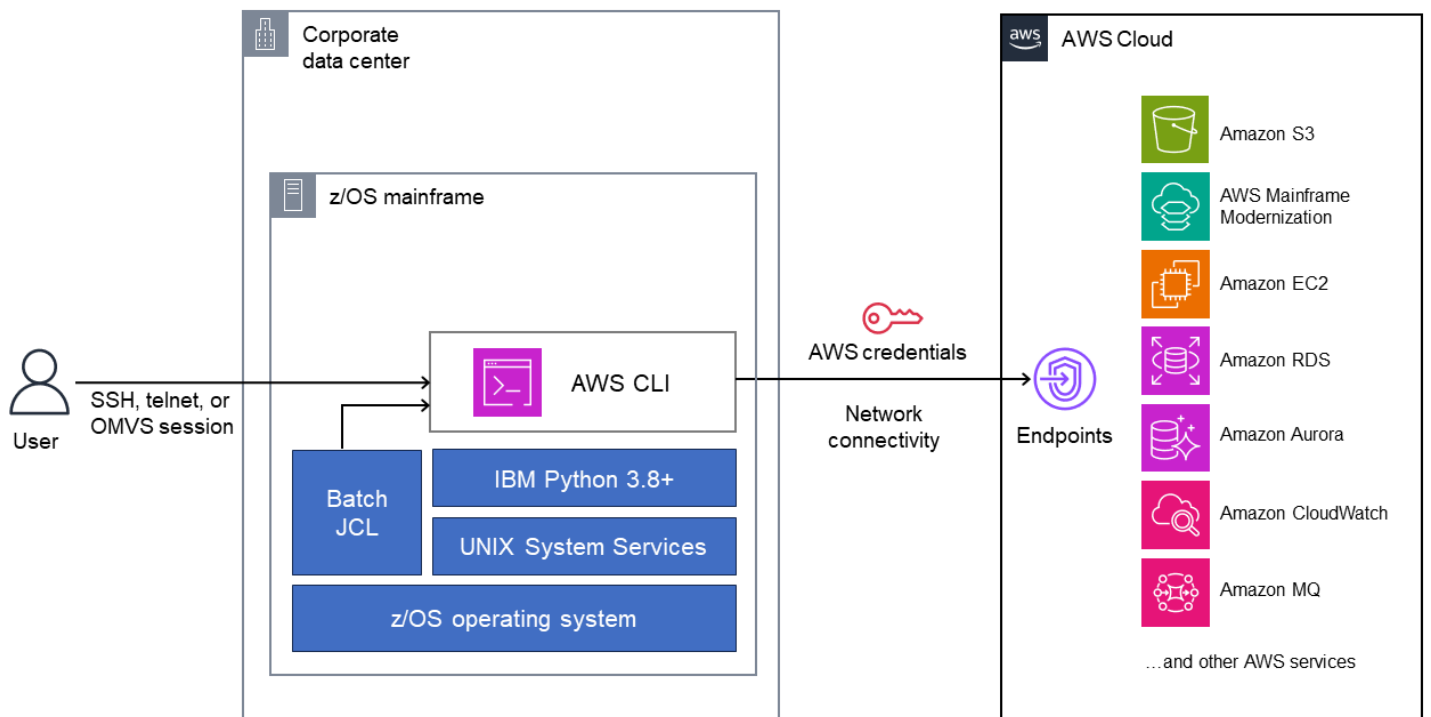

The AWS CLI communicates with AWS service endpoints over a TCP/IP network. This network connection can happen over the internet or through a private AWS Direct Connect connection from the customer data center to AWS Cloud data centers. The communication is authenticated with AWS credentials and encrypted.

## Automation and scale

You can explore the capabilities of an AWS service with the AWS CLI and develop USS shell scripts to manage your AWS resources from z/OS. You can also run AWS CLI commands and shell scripts from the z/OS batch environment, and you can automate batch jobs to run on a specific schedule by integrating with mainframe schedulers. AWS CLI commands or scripts can be coded inside parameters (PARMs) and procedures (PROCs), and can be scaled by following the standard approach of calling the PARM or PROC from different batch jobs with different parameters.

## Tools

- [AWS Command Line Interface \(AWS CLI\)](#) is an open source tool that helps you interact with AWS services through commands in your command-line shell.



## Best practices

- For security reasons, restrict the access permissions to the USS directory where the AWS access key details are stored. Allow access to only the users or programs that use the AWS CLI.
- Do not use the AWS account root user access keys for any task. Instead, [create a new administrator IAM user](#) for yourself and set it up with access keys.

**Warning:** IAM users have long-term credentials that present a security risk. To help mitigate this risk, we recommend that you provide these users with only the permissions they require to perform the task and that you remove these users when they are no longer needed.

## Epics

### Install AWS CLI version 1 on z/OS USS

Task	Description	Skills required
Install Python 3.8 or later.	<ol style="list-style-type: none"> <li>1. Log in to the z/OS USS command prompt interface by using one of these methods: <ul style="list-style-type: none"> <li>• Use a <a href="#">Time Sharing Option (TSO) OMVS</a> command from the <a href="#">Interactive System Productivity Facility (ISPF)</a> panel, or</li> <li>• Use SSH or telnet to connect to the IP of the mainframe logical partition (LPAR).</li> </ul> <p>This pattern assumes that <code>cliuser</code> is the userid used to log in to</p> </li> </ol>	Mainframe z/OS administrator

Task	Description	Skills required
	<p>the USS environment and <code>/u/cliuser/</code> is the home directory for the user. You can set the user home directory differently in your z/OS environment depending on your installation requirements.</p> <p>2. Follow the installation guide for <a href="#">IBM Open Enterprise Python for z/OS</a> to install Python 3.8 or later if it isn't already installed.</p>	

Task	Description	Skills required
Set USS environment variables.	<p>Add environment variables to the profile. You can add these either to the <code>/u/cliuser/.profile</code> file for an individual user (<code>cliuser</code>) or to the <code>/etc/profile</code> file for all users.</p> <p><b>Note:</b> This pattern assumes that Python has been installed in the <code>/u/awsccli/python</code> directory. If your installation directory is different, update the code accordingly.</p> <pre data-bbox="594 953 1027 1749"># Python configuration export BPXKAUTO VT='ON' export CEERUNOPT S='FILETAG(AUTOCVT ,AUTOTAG) POSIX(ON)' export TAGREDIR_ERR=txt export TAGREDIR_IN=txt export TAGREDIR_ OUT=txt  # AWS CLI configura tion export PATH=/u/c liuser/python/bin: \$PATH export PYTHONPATH=/u/ cliuser/python:\$PYTHON PATH</pre>	Mainframe z/OS administr ator

Task	Description	Skills required
Test the Python installation.	<p>Run the <b>python</b> command:</p> <pre>python --version</pre> <p>The output should confirm that you have Python 3.8 or later installed correctly.</p>	Mainframe z/OS administrator
Verify or install <b>pip</b> .	<ol style="list-style-type: none"><li>1. The <b>pip</b> command is usually installed automatically when you install Python from the IBM website. To verify, run the command:<pre>pip --version</pre><p>If <b>pip</b> is installed, this command should show the installed version.</p></li><li>2. If the <b>pip</b> command isn't found, install <b>pip</b> by running the following command:<pre>python -m ensurepip --upgrade</pre><p>For more installation options, see the <a href="#">pip documentation</a>.</p></li></ol>	Mainframe z/OS administrator

Task	Description	Skills required
Install AWS CLI version 1.	<p>1. To install the AWS CLI, run the command:</p> <pre>python -m pip install awscli</pre> <p>The output should be similar to the following.</p> <pre>Successfully installed PyYAML-6. 0.1 awscli-1.32.23 botocore-1.34.23 colorama-0.4.4 docutils-0.16 jmespath-1.0.1 pyasn1-0.5.1 python- dateutil-2.8.2 rsa-4.7.2 s3transfe r-0.10.0 urllib3-2 .0.7</pre> <p>2. Change the permission of the <b>aws</b> executable by running the following command. Make sure to update the placeholder directory <code>&lt;python_installation_dir&gt;</code> with your Python installation path.</p> <pre>chmod 744 &lt;python_installation_dir&gt;/bin/aws</pre>	Mainframe z/OS administrator

Task	Description	Skills required
	<p>3. Run the following command to test the AWS CLI installation:</p> <pre data-bbox="630 380 1027 457">aws --version</pre> <p>The output should show the versions of the AWS CLI, Python, and botocore, similar to the following.</p> <pre data-bbox="630 709 1027 909">aws-cli/1.32.3 Python/3.9.5 OS/390/27.00 botocore/1.34.3</pre>	

## Configure AWS CLI access from z/OS

Task	Description	Skills required
<p>Configure the AWS access keys, default Region, and output.</p>	<p>The <a href="#">AWS CLI documentation</a> describes different options for setting up AWS access. You can choose a configuration according to your organization's standards. This example uses the short-term credential configuration.</p> <p>1. <a href="#">Configure the AWS CLI</a> with the following command:</p> <pre data-bbox="630 1730 1027 1808">aws configure</pre>	<p>AWS administrator, Mainframe z/OS administrator, Mainframe z/OS developer</p>

Task	Description	Skills required
	<p>2. Provide the details for the following items when prompted. The access key ID and secret access key values are from the keys you obtained when you set AWS credentials in the <a href="#">Prerequisites</a> steps.</p> <pre data-bbox="634 617 1029 1371"> AWS Access Key ID [None]: ASIAIOSFO DNN7EXAMPLE AWS Secret Access Key [None]: wJalrXUtn FEMI/K7MDENG/bPxRf iCYEXAMPLEKEY Default region name [None]: us-east-1 Default output format [None]: aws configure set aws_session_token IQoJb3JpZ21uX2IQoJ b3JpZ21uX2IQoJb3Jp Z21uX2IQoJb3JpZ21u X2IQoJb3JpZVERYLON GSTRINGEXAMPLE </pre> <p>This configuration, including access keys, is stored in the <code>/u/cliuser/.aws</code> folder. For security reasons, restrict this folder to allow access only to the users or programs that use the AWS CLI.</p>	

Task	Description	Skills required
Test the AWS CLI.	<ol style="list-style-type: none"><li>1. Run the following command at the command prompt to test the AWS CLI with a simple command: <pre>aws s3 ls</pre><p>The output should list all the S3 buckets for the configured AWS account without any errors.</p></li><li>2. Follow the instructions in the next two epics to transfer data from USS to Amazon S3. You can choose one of these two options:<ul style="list-style-type: none"><li>• Option 1 (next epic): Interactively transfer an EBCDIC comma-separated value (CSV) file to Amazon S3 and query the file from Amazon Athena.</li><li>• Option 2: Transfer an EBCDIC fixed-length dataset to Amazon S3 as a batch job.</li></ul></li></ol>	Mainframe z/OS administrator, Mainframe z/OS developer



## Option 1 – Transfer data from USS to Amazon S3 interactively from a USS session

Task	Description	Skills required
Download and transfer the sample CSV file.	<ol style="list-style-type: none"> <li>1. Download sales-records.csv from the <a href="#">Attachments</a> section. This file provides a sample CSV file with sales records.</li> <li>2. Transfer the file to z/OS USS.</li> <li>3. Verify that the /u/cliuser/sales-records.csv file is readable in EBCDIC format in USS by using a text editor of your choice.</li> </ol>	App developer, Mainframe z/OS developer
Create an S3 bucket and upload the CSV file.	<ol style="list-style-type: none"> <li>1. Create an S3 bucket to store the CSV file.           <pre>aws s3 mb s3://&lt;s3_bucket_name&gt;</pre> <p>where &lt;s3_bucket_name&gt; is the unique name for a bucket; for example:</p> <pre>aws s3 mb s3://DOC-EXAMPLE-BUCKET1</pre> </li> <li>2. Upload the CSV file from z/OS USS to the S3 bucket:</li> </ol>	App developer, Mainframe z/OS developer

Task	Description	Skills required
	<pre>aws s3 cp &lt;csv_file _path&gt; s3://&lt;s3_ bucket_name&gt;</pre> <p>For example:</p> <pre>aws s3 cp /u/cliuser/ sales-records.csv s3://DOC-EXAMPLE-B UCKET1</pre> <p>3. List the contents of the S3 bucket and confirm that they include the uploaded file:</p> <pre>aws s3 ls s3://&lt;s3_ bucket_name&gt;</pre> <p>For example:</p> <pre>aws s3 ls s3://DOC- EXAMPLE-BUCKET1</pre>	

Task	Description	Skills required
View the S3 bucket and uploaded file.	<ol style="list-style-type: none"><li data-bbox="591 226 1029 407">1. Sign in to the AWS Management Console and open the <a href="#">Amazon S3 console</a>.</li><li data-bbox="591 428 1029 554">2. Navigate to see the new S3 bucket and the uploaded object.</li></ol> <p data-bbox="591 638 1029 856">For more information about uploading objects, see <a href="#">Getting started with Amazon S3</a> in the Amazon S3 documentation.</p>	General AWS

Task	Description	Skills required
Run a SQL query on an Amazon Athena table.	<ol style="list-style-type: none"> <li>1. Open the <a href="#">Amazon Athena console</a>.</li> <li>2. Create a new table (for example, DOC-EXAMPLE-BUCKET ) by using the CSV data from Amazon S3. For more information, see <a href="#">Querying Amazon S3 Inventory with Amazon Athena</a> in the Amazon S3 documentation.</li> <li>3. Run the SELECT query against the table to view the data.</li> </ol> <pre data-bbox="634 940 1027 1058">SELECT * FROM &lt;table_name&gt;;</pre> <p data-bbox="634 1094 818 1129">For example:</p> <pre data-bbox="634 1171 1027 1289">SELECT * FROM DOC- EXAMPLE-BUCKET;</pre> <p data-bbox="591 1356 1008 1486">The output of the SQL query will display the contents of your CSV file.</p>	General AWS, App developer

## Option 2 – Transfer data from USS to Amazon S3 by using batch JCL

Task	Description	Skills required
Upload the sample file.	<ol style="list-style-type: none"> <li>1. Download sales-rec ords-fixed.txt from</li> </ol>	Mainframe z/OS developer

Task	Description	Skills required
	<p>the <a href="#">Attachments</a> section.</p> <p>This is a sample file with sales records. Rename the text file; for example, to <code>USER.DATA.FIXED</code> .</p> <ol style="list-style-type: none"><li>2. Transfer the file to z/OS as a fixed-blocked (FB), 256 record length (LRECL), physical sequential (PS) dataset.</li><li>3. Use the dataset list utility to verify that the <code>USER.DATA.FIXED</code> dataset is readable in EBCDIC format under ISPF option 3.4. See the <a href="#">Additional information</a> section for example output.</li></ol>	

Task	Description	Skills required
Create batch JCL.	<p>Code the batch JCL as follows to create the destination S3 bucket, upload the dataset, and list the bucket content. Make sure to replace the directory name, file names, and bucket name to your own values.</p> <pre data-bbox="597 632 1026 1837"> //AWSCLICP JOB   ACTINFO1, 'IBMUSER'   ,CLASS=A,MSGCLASS= H,MSGLLEVEL=(1,1), // NOTIFY=&amp;SYSUID,TIM E=1440 //*----- ----- ----- //* Sample job for AWS   CLI //*----- ----- ----- //USSCMD EXEC PGM=BPXBAT TCH //STDERR DD SYSOUT=* //STDOUT DD SYSOUT=* //STDENV DD *   export PATH=/u/c   liuser/python/bin:   \$PATH //STDPARM DD * SH   export _BPXK_AUT OCVT=ON;   aws s3 mb s3://DOC- EXAMPLE-BUCKET2; </pre>	Mainframe z/OS developer

Task	Description	Skills required
	<pre>cp "'USER.DATA.FIXE D'" /tmp/tmpfile; aws s3 cp /tmp/tmpf ile s3://DOC-EXAMPLE- BUCKET2/USER.DATA.F IXED; rm /tmp/tmpfile; aws s3 ls s3://DOC- EXAMPLE-BUCKET2; /*</pre>	
Submit the batch JCL job.	<ol style="list-style-type: none"> <li>1. Submit the JCL job that you coded in the previous step.</li> <li>2. Check the status of the job in System Display and Search Facility (SDSF). If successful, the job should end with return code 0.</li> <li>3. The standard output (STDOUT) from the job log shows the successful bucket creation, dataset upload, and list of bucket contents. For a sample screen illustration, see the <a href="#">Additional information</a> section.</li> </ol>	Mainframe z/OS developer

Task	Description	Skills required
View the dataset uploaded to the S3 bucket.	<ol style="list-style-type: none"><li>1. Sign in to the AWS Management Console and open the <a href="#">Amazon S3 console</a>.</li><li>2. Navigate to see the uploaded file in the test bucket.</li><li>3. You can further process the USER.DATA.FIXED file or analyze it by using analytics services such as Amazon Redshift.</li></ol>	General AWS

## Related resources

- [AWS CLI version 1 documentation](#)
- [AWS Mainframe Modernization CLI Command Reference](#)
- [AWS Mainframe Modernization](#)

## Additional information

**USER.DATA.FIXED in ISPF option 3.4 (dataset list utility)**



```

File Edit Edit_Settings Menu Utilities Compilers Test Help
EDIT PHIL.DATA.FIXED Columns 00001 00124
Command ==> Scroll ==> CSR
***** Top of Data *****
000001 Region Country Item Type Sales Channel Order
000002 Middle East and North Africa Libya Cosmetics Offline M
000003 North America Canada Vegetables Online M
000004 Middle East and North Africa Libya Baby Food Offline C
000005 Asia Japan Cereal Offline C
000006 Sub-Saharan Africa Chad Fruits Offline H
000007 Europe Armenia Cereal Online H
000008 Sub-Saharan Africa Eritrea Cereal Online H
000009 Europe Montenegro Clothes Offline M
000010 Central America and the Caribbean Jamaica Vegetables Online H
000011 Australia and Oceania Fiji Vegetables Offline H
000012 Sub-Saharan Africa Togo Clothes Online M
000013 Europe Montenegro Snacks Offline M
000014 Europe Greece Household Online C
000015 Sub-Saharan Africa Sudan Cosmetics Online C
000016 Asia Maldives Fruits Offline L
000017 Europe Montenegro Clothes Offline H
000018 Europe Estonia Office Supplies Online H
000019 North America Greenland Beverages Online M
000020 Sub-Saharan Africa Cape Verde Clothes Online C
F1=Help F2=Split F3=Exit F4=Expand F5=Rfind F6=Rchange F7=Up F8=Down F9=Swap F10=Left F11=Right
F12=Cancel
3279-E TL S00006 04/015

```

## SYSOUT of the submitted batch job

```

Display Filter View Print Options Search Help
-----
SDSF OUTPUT DISPLAY AWSCLICP JOB04870 DSID 104 LINE 0 COLS 02- 133
COMMAND INPUT ==> _ SCROLL ==> PAGE
***** TOP OF DATA *****
make_bucket: test-zos-aws-cli-bucket2
Completed 234.6 KiB/234.6 KiB (183.8 KiB/s) with 1 file(s) remaining upload: ../../tmp/tmpfile to s3://test-zos-aws-cli-bucket2/USER
2020-11-30 21:33:18 240236 USER.DATA.FIXED
***** BOTTOM OF DATA *****

```

## Attachments

To access additional content that is associated with this document, unzip the following file:

[attachment.zip](#)

# Back up and archive mainframe data to Amazon S3 using BMC AMI Cloud Data

Created by Santosh Kumar Singh (AWS), Mikhael Liberman (Model9 Mainframe Software), Gilberto Biondo (AWS), and Maggie Li (AWS)

<b>Environment:</b> PoC or pilot	<b>Source:</b> Mainframe	<b>Target:</b> Amazon S3
<b>R Type:</b> N/A	<b>Technologies:</b> Mainframe; Storage & backup; Modernization	<b>AWS services:</b> Amazon EC2; Amazon EFS; Amazon S3; AWS Direct Connect

## Summary

This pattern demonstrates how to back up and archive mainframe data directly to Amazon Simple Storage Service (Amazon S3), and then recall and restore that data to the mainframe by using BMC AMI Cloud Data (previously known as Model9 Manager). If you are looking for a way to modernize your backup and archive solution as part of a mainframe modernization project or to meet compliance requirements, this pattern can help meet those goals.

Typically, organizations that run core business applications on mainframes use a virtual tape library (VTL) to back up data stores such as files and logs. This method can be expensive because it consumes billable MIPS, and the data stored on tapes outside the mainframe is inaccessible. To avoid these issues, you can use BMC AMI Cloud Data to quickly and cost-effectively transfer operational and historical mainframe data directly to Amazon S3. You can use BMC AMI Cloud Data to back up and archive data over TCP/IP to AWS while taking advantage of IBM z Integrated Information Processor (zIIP) engines to reduce cost, parallelism, and transfer times.

## Prerequisites and limitations

### Prerequisites

- An active AWS account
- BMC AMI Cloud Data with a valid license key
- TCP/IP connectivity between the mainframe and AWS

- An AWS Identity and Access Management (IAM) role for read/write access to an S3 bucket
- Mainframe security product (RACF) access in place to run BMC AMI Cloud processes
- A BMC AMI Cloud z/OS agent (Java version 8 64-bit SR5 FP16 or later) that has available network ports, firewall rules permitting access to S3 buckets, and a dedicated z/FS file system
- [Requirements](#) met for the BMC AMI Cloud management server

## Limitations

- BMC AMI Cloud Data stores its operational data in a PostgreSQL database that runs as a Docker container on the same Amazon Elastic Compute Cloud (Amazon EC2) instance as the management server. Amazon Relational Database Service (Amazon RDS) is not currently supported as a backend for BMC AMI Cloud Data. For more information about the latest product updates, see [What's New?](#) in the BMC documentation.
- This pattern backs up and archives z/OS mainframe data only. BMC AMI Cloud Data backs up and archives only mainframe files.
- This pattern doesn't convert data into standard open formats such as JSON or CSV. Use an additional transformation service such as [BMC AMI Cloud Analytics](#) (previously known as Model9 Gravity) to convert the data into standard open formats. Cloud-native applications and data analytics tools can access the data after it's written to the cloud.

## Product versions

- BMC AMI Cloud Data version 2.x

## Architecture

### Source technology stack

- Mainframe running z/OS
- Mainframe files such as datasets and z/OS UNIX System Services (USS) files
- Mainframe disk, such as a direct-access storage device (DASD)
- Mainframe tape (virtual or physical tape library)

### Target technology stack

- Amazon S3
- Amazon EC2 instance in a virtual private cloud (VPC)
- AWS Direct Connect
- Amazon Elastic File System (Amazon EFS)

## Target architecture

The following diagram shows a reference architecture where BMC AMI Cloud Data software agents on a mainframe drive the legacy data backup and archive processes that store the data in Amazon S3.

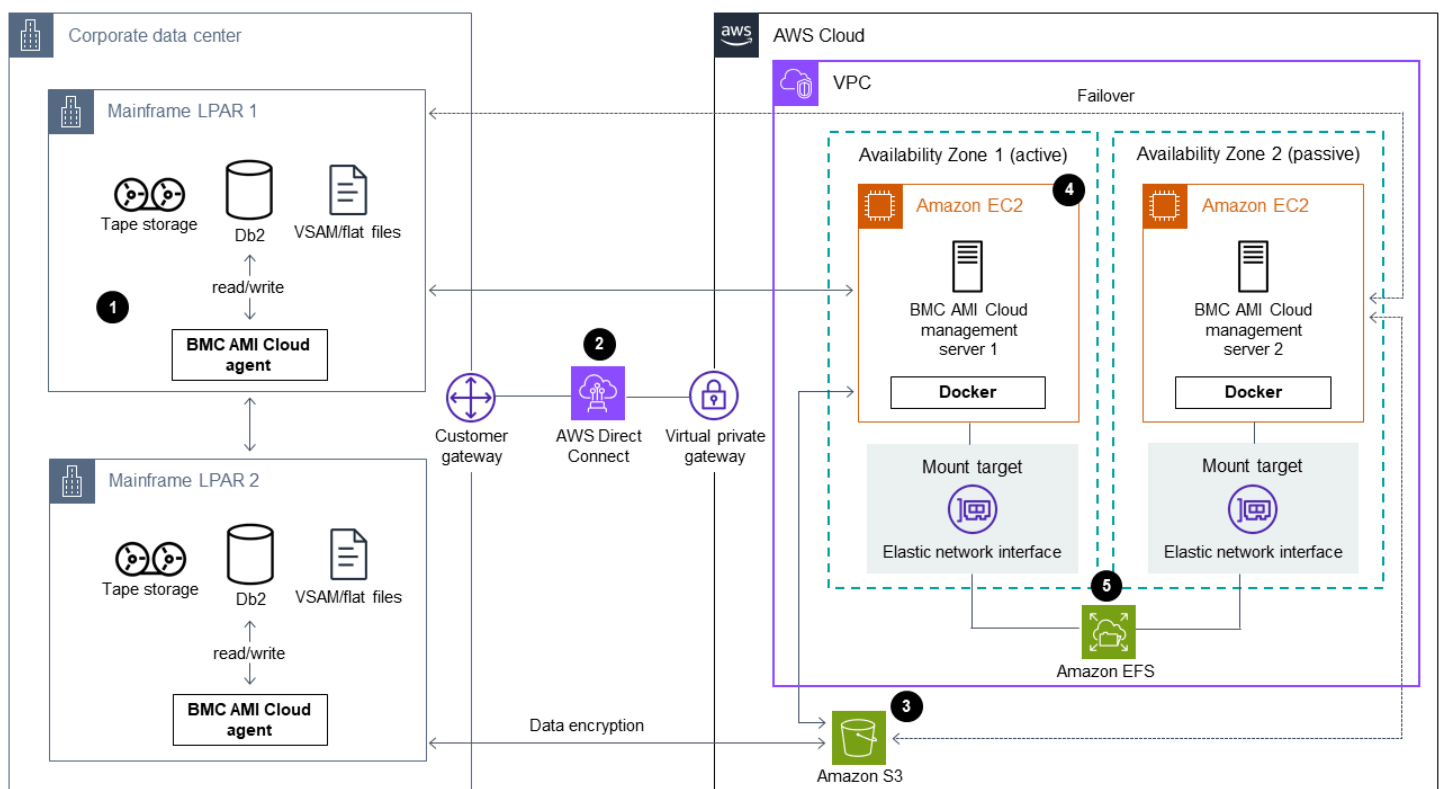

The diagram shows the following workflow:

1. BMC AMI Cloud Data software agents run on mainframe logical partitions (LPARs). The software agents read and write mainframe data from DASD or tape directly to Amazon S3 over TCP/IP.
2. AWS Direct Connect sets up a physical, isolated connection between the on-premises network and AWS. For enhanced security, run a site-to-site VPN on top of AWS Direct Connect to encrypt data in transit.

3. The S3 bucket stores mainframe files as object storage data, and BMC AMI Cloud Data agents directly communicate with the S3 buckets. Certificates are used for HTTPS encryption of all communications between the agent and Amazon S3. Amazon S3 data encryption is used to encrypt and protect the data at rest.
4. BMC AMI Cloud Data management servers run as Docker containers on EC2 instances. The instances communicate with agents running on mainframe LPARs and S3 buckets.
5. Amazon EFS is mounted on both active and passive EC2 instances to share the Network File System (NFS) storage. This is to make sure that metadata related to a policy created on the management server isn't lost in the event of a failover. In the event of a failover by the active server, the passive server can be accessed without any data loss. If the passive server fails, the active server can be accessed without any data loss.

## Tools

### AWS services

- [Amazon Elastic Compute Cloud \(Amazon EC2\)](#) provides scalable computing capacity in the AWS Cloud. You can launch as many virtual servers as you need and quickly scale them up or down.
- [Amazon Elastic File System \(Amazon EFS\)](#) helps you create and configure shared file systems in the AWS Cloud.
- [Amazon Simple Storage Service \(Amazon S3\)](#) is a cloud-based object storage service that helps you store, protect, and retrieve nearly any amount of data.
- [Amazon Virtual Private Cloud \(Amazon VPC\)](#) helps you launch AWS resources into a virtual network that you've defined. This virtual network resembles a traditional network that you'd operate in your own data center, with the benefits of using the scalable infrastructure of AWS.
- [AWS Direct Connect](#) links your internal network to a AWS Direct Connect location over a standard Ethernet fiber-optic cable. With this connection, you can create virtual interfaces directly to public AWS services while bypassing internet service providers in your network path.
- [AWS Identity and Access Management \(IAM\)](#) helps you securely manage access to your AWS resources by controlling who is authenticated and authorized to use them.

### BMC tools

- [BMC AMI Cloud management server](#) is a GUI application that runs as a Docker container on an Amazon Linux Amazon Machine Image (AMI) for Amazon EC2. The management server provides

the functionality to manage BMC AMI Cloud activities such as reporting, creating and managing policies, running archives, and performing backups, recalls, and restores.

- [BMC AMI Cloud agent](#) runs on an on-premises mainframe LPAR that reads and writes files directly to object storage by using TCP/IP. A started task runs on a mainframe LPAR and is responsible for reading and writing backup and archive data to and from Amazon S3.
- [BMC AMI Cloud Mainframe Command Line Interface \(M9CLI\)](#) provides you with a set of commands to perform BMC AMI Cloud actions directly from TSO/E or in batch operations, without the dependency on the management server.

## Epics

### Create an S3 bucket and IAM policy

Task	Description	Skills required
Create an S3 bucket.	<a href="#">Create an S3 bucket</a> to store the files and volumes that you want to back up and archive from your mainframe environment.	General AWS
Create an IAM policy.	<p>All BMC AMI Cloud management servers and agents require access to the S3 bucket that you created in the previous step.</p> <p>To grant the required access, create the following IAM policy:</p> <pre>{   "Version":   "2012-10-17",   "Statement": [     {       "Sid":       "Listfolder",</pre>	General AWS

Task	Description	Skills required
	<pre>                 "Action": [                     "s3:ListBucket",                     "s3:GetBucketLocat ion",                     "s3:ListBucketVers ions"                 ],                 "Effect":                 "Allow",                 "Resource":                 [                     "arn:aws:s3:::&lt;Bucket Name&gt;"                 ]             },             {                 "Sid":                 "Objectaccess",                 "Effect":                 "Allow",                 "Action": [                     "s3:PutObject",                     "s3:GetObjectAcl",                     "s3:GetObject",                     "s3:DeleteObjectVe rsion",                     "s3:DeleteObject",                     "s3:PutObjectAcl",                     "s3:GetObjectVersion"                 ],             } </pre>	

Task	Description	Skills required
	<pre>                 "Resource":             [                 "arn:aws:s3:::&lt;Bucket                 Name&gt;/*"             ]         }     ] } </pre>	

## Get the BMC AMI Cloud software license and download the software

Task	Description	Skills required
Get a BMC AMI Cloud software license.	To get a software license key, contact the <a href="#">BMC AMI Cloud team</a> . The output of the z/OS D M=CPU command is required for generating a license.	Build lead
Download the BMC AMI Cloud software and license key.	Obtain the installation files and license key by following the instructions in the <a href="#">BMC documentation</a> .	Mainframe infrastructure administrator

## Install the BMC AMI Cloud software agent on the mainframe

Task	Description	Skills required
Install the BMC AMI Cloud software agent.	1. Before you start the installation process, verify that <a href="#">minimum software and hardware requireme</a>	Mainframe infrastructure administrator



Task	Description	Skills required
	<p><a href="#">nts</a> for the agent have been met.</p> <p>2. To install the agent, follow the instructions in the <a href="#">BMC documentation</a>.</p> <p>3. After the agent starts running on the mainframe LPAR, check for the ZM91000I MODEL9 BACKUP AGENT INITIALIZED message in the spool. Verify that the connectivity is successfully established between the agent and the S3 bucket by looking for the Object store connectivity has been established successfully message in the agent's STDOUT.</p>	

### Set up a BMC AMI Cloud management server on an EC2 instance

Task	Description	Skills required
Create Amazon EC2 Linux 2 instances.	Launch two Amazon EC2 Linux 2 instances in different Availability Zones by following the instructions from <a href="#">Step 1: Launch an instance</a> in the Amazon EC2 documentation.	Cloud architect, Cloud administrator

Task	Description	Skills required
	<p>The instance must meet the following recommended hardware and software requirements:</p> <ul style="list-style-type: none"> <li>• CPU – Minimum 4 cores</li> <li>• RAM – Minimum 8 GB</li> <li>• Drive – 40 GB</li> <li>• Recommended EC2 instance – C5.xlarge</li> <li>• OS – Linux</li> <li>• Software – Docker, unzip, vi/VIM</li> <li>• Network bandwidth – Minimum 1 GB</li> </ul> <p>For more information, see the <a href="#">BMC documentation</a>.</p>	
<p>Create an Amazon EFS file system.</p>	<p>Create an Amazon EFS file system by following the instructions from <a href="#">Step 1: Create your Amazon EFS file system</a> in the Amazon EFS documentation.</p> <p>When creating the file system, do the following:</p> <ul style="list-style-type: none"> <li>• Choose the Standard storage class.</li> <li>• Choose the same VPC that you used to launch your EC2 instances.</li> </ul>	<p>Cloud administrator, Cloud architect</p>

Task	Description	Skills required
Install Docker and configure the management server.	<p><b>Connect to your EC2 instances:</b></p> <p>Connect to your EC2 instances by following the instructions from <a href="#">Connect to your Linux instance</a> in the Amazon EC2 documentation.</p> <p><b>Configure your EC2 instances :</b></p> <p>For each EC2 instance, do the following:</p> <ol style="list-style-type: none"><li>1. To install Docker, run the command: <pre>sudo yum install docker</pre></li><li>2. To start Docker, run the command: <pre>sudo service docker start</pre></li><li>3. To validate the status of Docker, run the command: <pre>sudo service docker status</pre></li><li>4. In the <code>/etc/selinux</code> folder, change the config file to <code>SELINUX=permissive</code>.</li></ol>	Cloud architect, Cloud administrator

Task	Description	Skills required
	<p>5. Upload the model9-v2 .x.y_build_build-id-server.zip and VerificationScripts.zip files (that you downloaded earlier) to a temporary folder in one of the EC2 instances (for example, into the /var/tmp folder in your instance)</p> <p>6. To go to the tmp folder, run the command:</p> <pre>cd/var/tmp</pre> <p>7. To unzip the verification script, run the command:</p> <pre>unzip VerificationScripts.zip</pre> <p>8. To change the directory, run the command:</p> <pre>cd /var/tmp/sysutils/PrereqsScripts</pre> <p>9. To run the verification script, run the command:</p> <pre>./M9VerifyPrereqs.sh</pre> <p>10 After the verification script prompts for the input,</p>	

Task	Description	Skills required
	<p>enter the Amazon S3 URL and port number. Then, enter the z/OS IP/DNS and port number.</p> <p><b>Note:</b> The script runs a check to confirm that EC2 instance can connect with the S3 bucket and agent that's running on the mainframe. If a connection is established, a success message is displayed.</p>	

Task	Description	Skills required
Install the management server software.	<ol style="list-style-type: none"><li data-bbox="591 226 1027 499">1. Create a folder and subfolder in the root directory (for example, /data/model9 ) in the EC2 instance that you plan to make the active server.</li><li data-bbox="591 520 1027 751">2. To install the amazon-efs-utils package and to mount the Amazon EFS file system created earlier, run the following commands: <pre data-bbox="634 789 1027 1024">sudo yum install -y amazon-efs-utils sudo mount -t efs -o tls &lt;File System ID&gt;:/ /data/model9</pre></li><li data-bbox="591 1045 1027 1465">3. To update the EC2 instance's /etc/fstab file with an entry for the Amazon EFS file system (so that Amazon EFS is automatically remounted when Amazon EC2 reboots), run the command: <pre data-bbox="634 1503 1027 1696">&lt;Amazon-EFS-file-system-id&gt;:/ /data/model9 efs defaults, _netdev 0 0</pre></li><li data-bbox="591 1717 1027 1833">4. To define the path to the BMC AMI Cloud installation files and the target</li></ol>	Cloud architect, Cloud administrator

Task	Description	Skills required
	<p>installation location, run the following commands to export variables:</p> <pre data-bbox="634 380 1027 575">export MODEL9_HOME=/data/model9 export M9INSTALL=/var/tmp</pre> <p><b>Note:</b> We recommend that you add these EXPORT commands to your .bashrc script.</p> <p>5. To change the directory , run the <code>cd \$MODEL9_HOME</code> command, and then create another subdirectory by running the <code>mkdir diag</code> command.</p> <p>6. To unzip the installation file, run the command:</p> <pre data-bbox="634 1234 1027 1430">unzip \$M9INSTALL/model9-&lt;v2.x.y&gt;_build_&lt;build-id&gt;-server.zip</pre> <p><b>Note:</b> Replace <code>x.y</code> (the version) and <code>build-id</code> with your values.</p> <p>7. To deploy the application, run the following commands:</p>	

Task	Description	Skills required
	<pre data-bbox="634 212 1029 562">docker load -i   \$MODEL9_HOME/model 9-&lt;v2.x.y&gt;_build_&lt; build-id&gt;.docker docker load -i   \$MODEL9_HOME/postg res-12.10-x86.dock er.gz</pre> <p data-bbox="630 604 1024 737"><b>Note:</b> Replace <code>v2.x.y</code> (the version) and <code>build-id</code> with your values.</p> <p data-bbox="592 758 993 932">8. In the <code>\$MODEL9_HOME/conf</code> folder, update the <code>model9-local.yml</code> file.</p> <p data-bbox="630 982 1019 1304"><b>Note:</b> Some of the parameters have default values and others can be updated as necessary. For more information, see the instructions in the <code>model9-local.yml</code> file.</p> <p data-bbox="592 1325 980 1549">9. Create a file called <code>\$MODEL9_HOME/conf</code>, and then add the following parameters to the file:</p> <pre data-bbox="634 1591 1029 1745">TZ=America/New_York EXTRA_JVM_ARGS=- Xmx2048m</pre> <p data-bbox="592 1766 1024 1843">10.To create a Docker network bridge, run the command:</p>	



Task	Description	Skills required
	<pre data-bbox="634 212 1027 365">docker network create -d bridge model9net work</pre> <p data-bbox="594 384 985 562"><b>11</b>To start the PostgreSQL database container for BMC AMI Cloud, run the following command:</p> <pre data-bbox="634 600 1027 1234">docker run -p 127.0.0.1:5432:5432 \ -v \$MODEL9_HOME/db/data:/var/lib/postgresql/data:z \ --name model9db -- restart unless-stopped \ --network model9network \ -e POSTGRES_PASSWORD= model9 -e POSTGRES_ DB=model9 -d postgres:12.10</pre> <p data-bbox="594 1253 985 1478"><b>12</b>After the PostgreSQL container starts running, run the following command to start the application server:</p> <pre data-bbox="634 1516 1027 1772">docker run -d -p 0.0.0.0:443:443 -p 0.0.0.0:80:80 \ --sysctl net.ipv4. tcp_keepalive_time =600 \</pre>	

Task	Description	Skills required
	<pre data-bbox="646 212 992 919"> --sysctl net.ipv4. tcp_keepalive_intv l=30 \ --sysctl net.ipv4. tcp_keepalive_prob es=10 \ -v \$MODEL9_HOME:/mode l9:z -h \$(hostname) --restart unless-st opped \ --env-file \$MODEL9_H OME/conf/model9.env \ --network model9net work \ --name model9-v2.x.y model9:&lt;v2.x.y&gt;.&lt;b uild-id&gt; </pre> <p data-bbox="630 982 1024 1108"><b>Note:</b> Replace <code>v2.x.y</code> (the version) and <code>build-id</code> with your values.</p> <p data-bbox="594 1136 1019 1262">13.To check the health status of both containers, run the command:</p> <pre data-bbox="634 1304 1027 1381"> docker ps -a </pre> <p data-bbox="594 1398 1027 1577">14.To install a management server on the passive EC2 instances, repeat steps 1–4, 7, and 10–13.</p> <p data-bbox="594 1654 1016 1829"><b>Note:</b> To troubleshoot issues, go to the logs stored in the <code>/data/model9/logs/</code> folder. For more informati</p>	

Task	Description	Skills required
	on, see the <a href="#">BMC documentation</a> .	

## Add an agent and define a backup or archive policy on the BMC AMI Cloud management server

Task	Description	Skills required
Add a new agent.	<p>Before you add a new agent, confirm the following:</p> <ul style="list-style-type: none"> <li>• A BMC AMI Cloud agent is running on the mainframe LPAR and has been initialized completely. Identify the agent by looking for the ZM91000I MODEL9 BACKUP AGENT INITIALIZED initialization message in the spool.</li> <li>• A Docker container for the management server is fully initialized and running.</li> </ul> <p>You must create an agent on the management server before you define any backup and archive policies. To create the agent, do the following:</p> <ol style="list-style-type: none"> <li>1. Use a web browser to access the management server that's deployed on your Amazon EC2 machine,</li> </ol>	Mainframe storage administrator or developer

Task	Description	Skills required
	<p>and then log in with your mainframe credentials.</p> <ol style="list-style-type: none"><li>2. Choose the <b>AGENTS</b> tab, and then choose <b>ADD NEW AGENT</b>.</li><li>3. For <b>Name</b>, enter the agent name.</li><li>4. For <b>Hostname/IP Address</b>, enter the host name or IP address of your mainframe.</li><li>5. For <b>Port</b>, enter your port number.</li><li>6. Choose <b>TEST CONNECTION</b>. You can see a <b>success</b> message if the connectivity is successfully established.</li><li>7. Choose <b>CREATE</b>.</li></ol> <p>After the agent is created, you'll see the <b>connected</b> status against the object storage and mainframe agent in a new window that appears in the table.</p>	

Task	Description	Skills required
Create a backup or archive policy.	<ol style="list-style-type: none"> <li>1. Choose <b>POLICIES</b>.</li> <li>2. Choose <b>CREATE POLICY</b>.</li> <li>3. On the <b>CREATE A NEW POLICY</b> page, enter your policy specifications.</li> </ol> <p><b>Note:</b> For more information about the available specifications, see <a href="#">Creating a new policy</a> in the BMC documentation.</p> <ol style="list-style-type: none"> <li>4. Choose <b>FINISH</b>.</li> <li>5. The new policy is now listed as a table. To see this table, choose the <b>POLICIES</b> tab.</li> </ol>	Mainframe storage administrator or developer

### Run the backup or archive policy from the management server

Task	Description	Skills required
Run the backup or archive policy.	<p>Run the data backup or archive policy that you created earlier from the management server either manually or automatically (based on a schedule). To run the policy manually:</p> <ol style="list-style-type: none"> <li>1. Choose the <b>POLICIES</b> tab from the navigation menu.</li> <li>2. On the right side of the table for the policy that</li> </ol>	Mainframe storage administrator or developer

Task	Description	Skills required
	<p>you want to run, choose the three-dot menu.</p> <ol style="list-style-type: none"><li>3. Choose <b>Run Now</b>.</li><li>4. In the pop-up confirmation window, choose <b>YES, RUN POLICY NOW</b>.</li><li>5. After the policy runs, verify the run status in the policy activity section.</li><li>6. For the policy that ran, choose the three-dot menu, and then choose <b>View Run Log</b> to see the logs.</li><li>7. To verify that the backup was created, check the S3 bucket.</li></ol>	

Task	Description	Skills required
Restore the backup or archive policy.	<ol style="list-style-type: none"><li data-bbox="591 226 1003 308">1. On the navigation menu, choose the <b>POLICIES</b> tab.</li><li data-bbox="591 329 1013 604">2. Choose the policy to run your restore process on. This will list all the backup or archive activities that ran in the past for that specific policy.</li><li data-bbox="591 625 1019 947">3. To select the backups that you want to restore, choose the <b>Date-time</b> column. The file/Volume/Storage group name shows the run details of the policy.</li><li data-bbox="591 968 976 1150">4. On the right side of the table, choose the three-dot menu, and then choose <b>RESTORE</b>.</li><li data-bbox="591 1171 1027 1354">5. In the pop-up window, enter your target name, volume, and storage group, and then choose <b>RESTORE</b>.</li><li data-bbox="591 1375 976 1507">6. Enter your mainframe credentials, and then choose <b>RESTORE</b> again.</li><li data-bbox="591 1528 995 1654">7. To verify that the restore was successful, check the logs or the mainframe.</li></ol>	Mainframe storage administrator or developer

## Run the backup or archive policy from the mainframe

Task	Description	Skills required
<p>Run the backup or archive policy by using M9CLI.</p>	<p>Use the M9CLI to perform backup and restore processes from TSO/E, REXX, or through JCLs without setting up rules on the BMC AMI Cloud management server.</p> <p><b>Using TSO/E:</b></p> <p>If you use TSO/E, make sure that M9CLI REXX is concatenated to TSO. To back up a dataset through TSO/E, use the TSO M9CLI BACKDSN &lt;DSNAME&gt; command.</p> <p><b>Note:</b> For more information about M9CLI commands, see <a href="#">CLI reference</a> in the BMC documentation.</p> <p><b>Using JCLs:</b></p> <p>To run the backup and archive policy by using JCLs, run the M9CLI command.</p> <p><b>Using batch operations:</b></p> <p>The following example shows you how to archive a dataset by running the M9CLI command in batch:</p>	<p>Mainframe storage administrator or developer</p>



Task	Description	Skills required
	<pre>//JOBNAME JOB ... //M9CLI EXEC PGM=IKJEF T01 //STEPLIB DD DISP=SHR, DSN=&lt;MODEL9 LOADLIB&gt; //SYSEXEC DD DISP=SHR, DSN=&lt;MODEL9 EXEC LIB&gt; //SYSTSPRT DD SYSOUT=* //SYSPRINT DD SYSOUT=* //SYSTSIN DD TSO M9CLI ARCHIVE M9CLI ARCHIVE &lt;DSNNAME OR DSN PATTERN&gt; /</pre>	

Task	Description	Skills required
Run the backup or archive policy in JCL batch.	<p>BMC AMI Cloud provides a sample JCL routine called <b>M9SAPIJ</b>. You can customize <b>M9SAPIJ</b> to run a specific policy created on the management server with a JCL. This job can also be part of a batch scheduler for running backup and restore processes automatically.</p> <p>The batch job expects the following mandatory values:</p> <ul style="list-style-type: none"><li>• Management server IP address/host name</li><li>• Port number</li><li>• Policy ID or policy name (which is created on the management server)</li></ul> <p><b>Note:</b> You can also change other values by following the instructions on the sample job.</p>	Mainframe storage administrator or developer

## Related resources

- [Mainframe Modernization with AWS](#) (AWS documentation)
- [How Cloud Backup for Mainframes Cuts Costs with Model9 and AWS](#) (AWS Partner Network Blog)
- [How to Enable Mainframe Data Analytics on AWS Using Model9](#) (AWS Partner Network Blog)
- [AWS Direct Connect Resiliency Recommendations](#) (AWS documentation)

- [BMC AMI Cloud documentation](#) (BMC website)

# Build an advanced mainframe file viewer in the AWS Cloud

Created by Boopathy GOPALSAMY (AWS) and Jeremiah O'Connor (AWS)

**Environment:** PoC or pilot

**Technologies:** Mainframe;  
Migration; Serverless

**Workload:** IBM

**AWS services:** Amazon  
Athena; AWS Lambda;  
Amazon OpenSearch Service;  
AWS Step Functions

## Summary

This pattern provides code samples and steps to help you build an advanced tool for browsing and reviewing your mainframe fixed-format files by using AWS serverless services. The pattern provides an example of how to convert a mainframe input file to an Amazon OpenSearch Service document for browsing and searching. The file viewer tool can help you achieve the following:

- Retain the same mainframe file structure and layout for consistency in your AWS target migration environment (for example, you can maintain the same layout for files in a batch application that transmits files to external parties)
- Speed up development and testing during your mainframe migration
- Support maintenance activities after the migration

## Prerequisites and limitations

### Prerequisites

- An active AWS account
- A virtual private cloud (VPC) with a subnet that's reachable by your legacy platform
- An input file and its corresponding common business-oriented language (COBOL) copybook (**Note:** For input file and COBOL copybook examples, see [gfs-mainframe-solutions](#) on the GitHub repository. For more information about COBOL copybooks, see the [Enterprise COBOL for z/OS 6.3 Programming Guide](#) on the IBM website.)

## Limitations

- Copybook parsing is limited to no more than two nested levels (OCCURS)

## Architecture

### Source technology stack

- Input files in [FB \(Fixed Blocked\)](#) format
- COBOL copybook layout

### Target technology stack

- Amazon Athena
- Amazon OpenSearch Service
- Amazon Simple Storage Service (Amazon S3)
- AWS Lambda
- AWS Step Functions

### Target architecture

The following diagram shows the process of parsing and converting a mainframe input file to an OpenSearch Service document for browsing and searching.

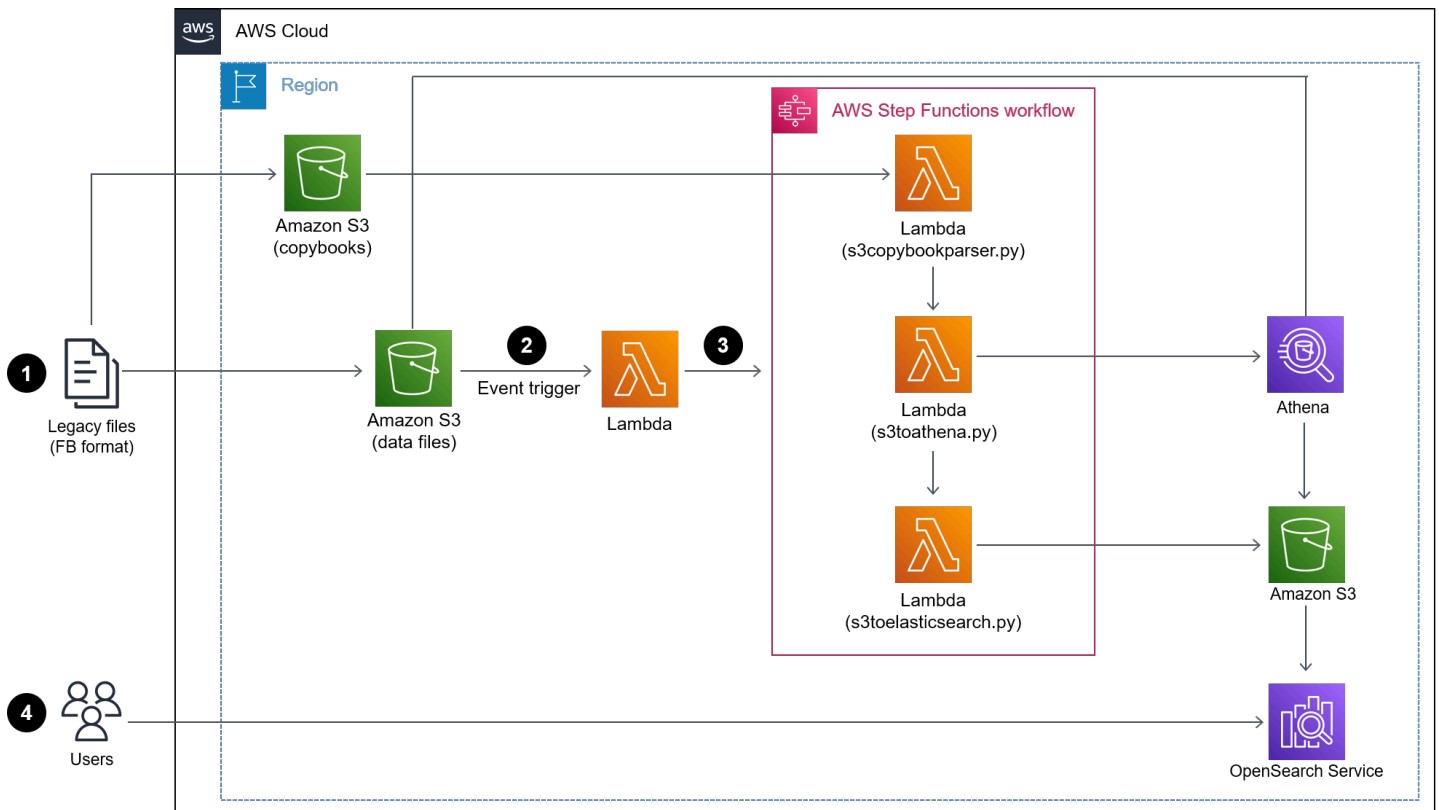

The diagram shows the following workflow:

1. An admin user or application pushes input files to one S3 bucket and COBOL copybooks to another S3 bucket.
2. The S3 bucket with the input files invokes a Lambda function that kicks off a serverless Step Functions workflow. **Note:** The use of an S3 event trigger and Lambda function to drive the Step Functions workflow in this pattern is optional. The GitHub code samples in this pattern don't include the use of these services, but you can use these services based on your requirements.
3. The Step Functions workflow coordinates all the batch processes from the following Lambda functions:
  - The `s3copybookparser.py` function parses the copybook layout and extracts field attributes, data types, and offsets (required for input data processing).
  - The `s3toathena.py` function creates an Athena table layout. Athena parses the input data that's processed by the `s3toathena.py` function and converts the data to a CSV file.
  - The `s3toelasticsearch.py` function ingests the results file from the S3 bucket and pushes the file to OpenSearch Service.
4. Users access OpenSearch Dashboards with OpenSearch Service to retrieve the data in various table and column formats and then run queries against the indexed data.

# Tools

## AWS services

- [Amazon Athena](#) is an interactive query service that helps you analyze data directly in Amazon Simple Storage Service (Amazon S3) using standard SQL.
- [AWS Lambda](#) is a compute service that helps you run code without needing to provision or manage servers. It runs your code only when needed and scales automatically, so you pay only for the compute time that you use. In this pattern, you use Lambda to implement core logic, such as parsing files, converting data, and loading data into OpenSearch Service for interactive file access.
- [Amazon OpenSearch Service](#) is a managed service that helps you deploy, operate, and scale OpenSearch Service clusters in the AWS Cloud. In this pattern, you use OpenSearch Service to index the converted files and provide interactive search capabilities for users.
- [Amazon Simple Storage Service \(Amazon S3\)](#) is a cloud-based object storage service that helps you store, protect, and retrieve any amount of data.
- [AWS Command Line Interface \(AWS CLI\)](#) is an open-source tool that helps you interact with AWS services through commands in your command-line shell.
- [AWS Identity and Access Management \(IAM\)](#) helps you securely manage access to your AWS resources by controlling who is authenticated and authorized to use them.
- [AWS Step Functions](#) is a serverless orchestration service that helps you combine Lambda functions and other AWS services to build business-critical applications. In this pattern, you use Step Functions to orchestrate Lambda functions.

## Other tools

- [GitHub](#) is a code-hosting service that provides collaboration tools and version control.
- [Python](#) is a high-level programming language.

## Code

The code for this pattern is available in the GitHub [gfs-mainframe-patterns](#) repository.

# Epics

## Prepare the target environment

Task	Description	Skills required
Create the S3 bucket.	<p><a href="#">Create an S3 bucket</a> for storing the copybooks, input files, and output files. We recommend the following folder structure for your S3 bucket:</p> <ul style="list-style-type: none"> <li>• copybook/</li> <li>• input/</li> <li>• output/</li> <li>• query/</li> <li>• results/</li> </ul>	General AWS
Create the s3copybookparser function.	<ol style="list-style-type: none"> <li>1. <a href="#">Create a Lambda function</a> called <code>s3copybookparser</code> and upload the source code (<code>s3copybookparser.py</code> and <code>copybook.py</code>) from the <a href="#">GitHub</a> repository.</li> <li>2. <a href="#">Attach the IAM policy</a> <code>S3ReadOnly</code> to the Lambda function.</li> </ol>	General AWS
Create the s3toathena function.	<ol style="list-style-type: none"> <li>1. Create a Lambda function called <code>s3toathena</code> and upload the source code (<code>s3toathena.py</code>) from the <a href="#">GitHub</a> repository. Configure the Lambda timeout to &gt; 60 seconds.</li> </ol>	General AWS



Task	Description	Skills required
	2. To provide access to the required resources, attach the IAM policies <code>AmazonAthenaFullAccess</code> and <code>S3FullAccess</code> to the Lambda function.	

Task	Description	Skills required
Create the <code>s3toelasticsearch</code> function.	<ol style="list-style-type: none"><li data-bbox="592 226 1026 787">1. <a href="#">Add a Python dependency to your Lambda environment</a>. <b>Important:</b> To use the <code>s3toelasticsearch</code> function, you must add the Python dependency because the Lambda function uses Python Elasticsearch client dependencies (<code>Elasticsearch==7.9.0</code> and <code>requests_aws4auth</code> ).</li><li data-bbox="592 808 1026 1134">2. Create a Lambda function called <code>s3toelasticsearch</code> and upload the source code (<code>s3toelasticsearch.py</code> ) from the <a href="#">GitHub</a> repository.</li><li data-bbox="592 1155 1026 1281">3. Import the Python dependency as a Lambda layer.</li><li data-bbox="592 1302 1026 1533">4. Attach the IAM policies <code>S3ReadOnly</code> and <code>AmazonOpenSearchServiceReadOnlyAccess</code> to the Lambda function.</li></ol>	General AWS

Task	Description	Skills required
<p>Create the OpenSearch Service cluster.</p>	<p><b>Create the cluster</b></p> <ol style="list-style-type: none"> <li>1. <a href="#">Create an OpenSearch Service cluster</a>. When you create the cluster, do the following: <ul style="list-style-type: none"> <li>• <a href="#">Create a master user and password</a> for the cluster that you can use for signing in to <a href="#">OpenSearch Dashboards</a>. <b>Note:</b> This step is not required if you use authentication through Amazon Cognito.</li> <li>• Choose fine-grained access control. This gives you additional ways of controlling access to your data in OpenSearch Service.</li> </ul> </li> <li>2. Copy the domain URL and pass it as the environment variable <b>'HOST'</b> to the Lambda function <code>s3toelasticsearch</code>.</li> </ol> <p><b>Grant access to the IAM role</b></p> <p>To provide fine-grained access to the Lambda function's IAM role (<code>arn:aws:iam::**:role/service-role/s3toelasticsearch</code></p>	<p>General AWS</p>

Task	Description	Skills required
	<p>search-role-** ), do the following:</p> <ol style="list-style-type: none"><li>1. Sign in to OpenSearch Dashboards as the master user.</li><li>2. Choose the <b>Security</b> tab, and then choose <b>Roles</b>, <b>all_access</b>, <b>Map user</b>, <b>Backend roles</b>.</li><li>3. Add the Amazon Resource Name (ARN) of the Lambda function's IAM role, and then choose <b>Save</b>. For more information, see <a href="#">Mapping roles to users</a> in the OpenSearch Service documentation.</li></ol>	
Create Step Functions for orchestration.	<ol style="list-style-type: none"><li>1. <a href="#">Create a Step Functions state machine</a> with the standard flow. The definition is included in the <a href="#">GitHub</a> repository.</li><li>2. In the JSON script, replace the Lambda function's ARNs with the ARNs from the Lambda function in your environment.</li></ol>	General AWS

## Deploy and run

Task	Description	Skills required
<p>Upload the input files and copybooks to the S3 bucket.</p>	<p>Download sample files from the <a href="#">GitHub</a> repository sample folder and upload the files to the S3 bucket that you created earlier.</p> <ol style="list-style-type: none"> <li>1. Upload Mockedcopy.cpy and acctix.cpy to the &lt;S3_Bucket&gt;/copybook folder.</li> <li>2. Upload the Modeduplicate.txt and acctindex.cpy sample input files to the &lt;S3_Bucket&gt;/input folder.</li> </ol>	<p>General AWS</p>
<p>Invoke the Step Functions.</p>	<ol style="list-style-type: none"> <li>1. Sign in to the AWS Management Console and open the <a href="#">Step Functions console</a>.</li> <li>2. In the navigation pane, choose <b>State machines</b>.</li> <li>3. Choose your state machine, and then choose <b>Start execution</b>.</li> <li>4. In the <b>Input</b> box, enter the following copybook/file path as a JSON variable to the S3 bucket, and then choose <b>Start execution</b>.</li> </ol> <pre data-bbox="592 1827 1031 1879">{</pre>	<p>General AWS</p>

Task	Description	Skills required
	<pre>"s3_copybook_bucket_name": "&lt;BUCKET NAME&gt;", "s3_copybook_bucket_key": "&lt;COPYBOOK PATH&gt;", "s3_source_bucket_name": "&lt;BUCKET NAME", "s3_source_bucket_key": "INPUT FILE PATH" }</pre> <p>For example:</p> <pre>{ "s3_copybook_bucket_name": "fileaidtest", "s3_copybook_bucket_key": "copybook/ acctix.cpy", "s3_source_bucket_name": "fileaidtest", "s3_source_bucket_key": "input/ac ctindex" }</pre>	

Task	Description	Skills required
Validate the workflow execution in Step Functions.	<p>In the <a href="#">Step Functions console</a>, review the workflow execution in the <b>Graph inspector</b>. The execution run states are color coded to represent execution status. For example, blue indicates <b>In Progress</b>, green indicates <b>Succeeded</b>, and red indicates <b>Failed</b>. You can also review the table in the <b>Execution event history</b> section for more detailed information about the execution events.</p> <p>For an example of a graphical workflow execution, see <i>Step Functions graph</i> in the <i>Additional information</i> section of this pattern.</p>	General AWS

Task	Description	Skills required
Validate the delivery logs in Amazon CloudWatch.	<ol style="list-style-type: none"><li data-bbox="591 226 1008 405">1. Sign in to the AWS Management Console and open the <a href="#">CloudWatch console</a>.</li><li data-bbox="591 426 959 562">2. In the navigation pane, expand <b>Logs</b>, and then choose <b>Log groups</b>.</li><li data-bbox="591 583 1008 762">3. In the search box, search for the <code>s3toelast icsearch</code> function's log group.</li></ol> <p data-bbox="591 835 1019 1056">For an example of successful delivery logs, see <i>CloudWatch delivery logs</i> in the <i>Additional information</i> section of this pattern.</p>	General AWS



Task	Description	Skills required
Validate the formatted file in OpenSearch Dashboards and perform file operations.	<ol style="list-style-type: none"><li>1. Sign in to the AWS Management Console. Under <b>Analytics</b>, choose <b>Amazon OpenSearch Service</b>.</li><li>2. In the navigation pane, choose <b>Domains</b>.</li><li>3. In the search box, enter the URL for your domain in <a href="#">OpenSearch Dashboards</a>.</li><li>4. Choose your dashboard , and then <a href="#">sign in as the master user</a>.</li><li>5. Browse the indexed data in table format.</li><li>6. Compare the input file against the formatted output file (indexed document) in OpenSearch Dashboards. The dashboard view shows the added column headers for your formatted files. Confirm that the source data from your unformatted input files matches the target data in the dashboard view.</li><li>7. Perform actions such as search (for example, by using field names, values, or expressions), filter, and <a href="#">DQL</a> (Dashboard Query</li></ol>	General AWS

Task	Description	Skills required
	Language) operations against the indexed file.	

## Related resources

### References

- [Example COBOL copybook](#) (IBM documentation)
- [BMC Compuware File-AID](#) (BMC documentation)

### Tutorials

- [Tutorial: Using an Amazon S3 trigger to invoke a Lambda function](#) (AWS Lambda documentation)
- [How do I create a serverless workflow with AWS Step Functions and AWS Lambda](#) (AWS documentation)
- [Using OpenSearch Dashboards with Amazon OpenSearch Service](#) (AWS documentation)

## Additional information

### Step Functions graph

The following example shows a Step Functions graph. The graph shows the execution run status for the Lambda functions used in this pattern.

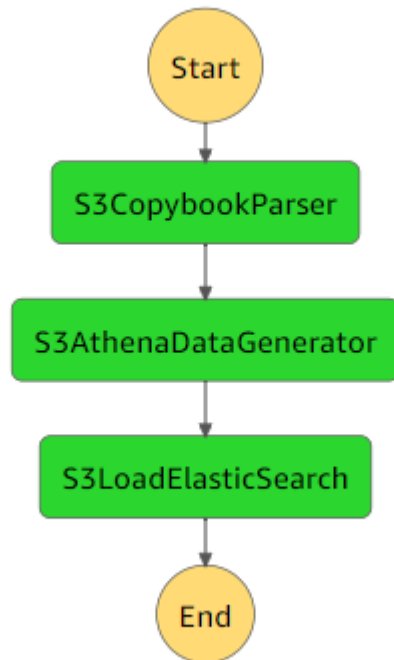

## CloudWatch delivery logs

The following example shows successful delivery logs for the execution of the `s3toelasticsearch` execution.

2022-08-10T15:53:3  
3.033-05:00

Number of processing  
documents: 100

2022-08-10T15:53:3  
3.171-05:00

[INFO] 2022-08-10T20:53:3  
3.171Z a1b2c3d4-5678-90ab  
-cdef-EXAMPLE11111  
POST https://search-  
essearch-3h4uqclifeqa  
j2vg4mphe7ffle.us-east-2.es  
.amazonaws.com:443/\_bulk  
[status:200 request:0.100s]

2022-08-10T15:53:3  
3.172-05:00

Bulk write succeed: 100  
documents



# Containerize mainframe workloads that have been modernized by Blu Age

Created by Richard Milner-Watts (AWS)

<b>Code repository:</b> <a href="#">Blu Age Application Container Example</a>	<b>Environment:</b> Production	<b>Source:</b> Mainframe workloads
<b>Target:</b> Containers	<b>R Type:</b> Re-architect	<b>Workload:</b> IBM; All other workloads
<b>Technologies:</b> Mainframe; Containers & microservices; Migration; Modernization	<b>AWS services:</b> Amazon ECS; Amazon ECR	

## Summary

This pattern provides a sample container environment for running mainframe workloads that have been modernized by using the [Blu Age](#) tool. Blu Age converts legacy mainframe workloads into modern Java code. This pattern provides a wrapper around the Java application so you can run it by using container orchestration services such as [Amazon Elastic Container Service \(Amazon ECS\)](#) or [Amazon Elastic Kubernetes Service \(Amazon EKS\)](#).

For more information about modernizing your workloads by using Blu Age and AWS services, see these AWS Prescriptive Guidance publications:

- [Running modernized Blu Age mainframe workloads on serverless AWS infrastructure](#)
- [Deploy an environment for containerized Blu Age applications by using Terraform](#)

For assistance with using Blu Age to modernize your mainframe workloads, contact the Blu Age team by choosing **Contact our experts** on the [Blu Age website](#). For assistance with migrating your modernized workloads to AWS, integrating them with AWS services, and moving them into production, contact your AWS account manager or fill out the [AWS Professional Services form](#).

## Prerequisites and limitations

### Prerequisites

- A modernized Java application that was created by Blu Age. For testing purposes, this pattern provides a sample Java application that you can use as a proof of concept.
- A [Docker](#) environment that you can use to build the container.

### Limitations

Depending on the container orchestration platform that you use, the resources that can be made available to the container (such as CPU, RAM, and storage) might be limited. For example, if you're using Amazon ECS with AWS Fargate, see the [Amazon ECS documentation](#) for limits and considerations.

## Architecture

### Source technology stack

- Blu Age
- Java

### Target technology stack

- Docker

### Target architecture

The following diagram shows the architecture of the Blu Age application within a Docker container.

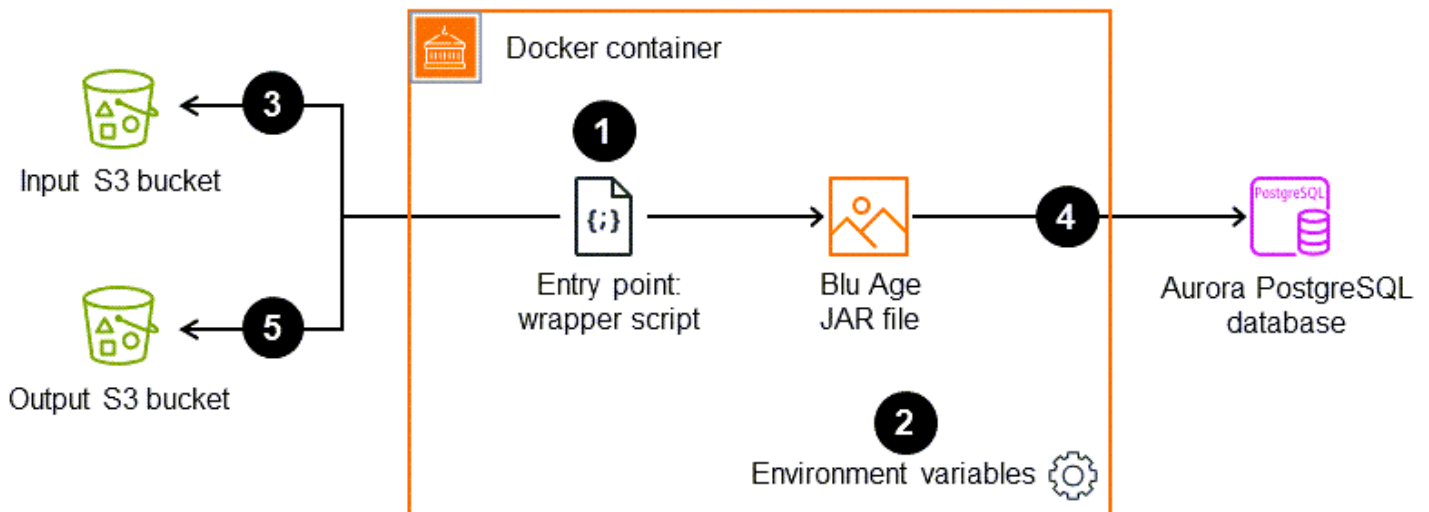

1. The entry point for the container is the wrapper script. This bash script is responsible for preparing the runtime environment for the Blu Age application and processing outputs.
2. Environment variables within the container are used to configure variables in the wrapper script, such as the Amazon Simple Storage Service (Amazon S3) bucket names and database credentials. Environment variables are supplied by either AWS Secrets Manager or Parameter Store, a capability of AWS Systems Manager. If you're using Amazon ECS as your container orchestration service, you can also hardcode the environment variables in the Amazon ECS task definition.
3. The wrapper script is responsible for pulling any input files from the S3 bucket into the container before you run the Blu Age application. The AWS Command Line Interface (AWS CLI) is installed within the container. This provides a mechanism for accessing objects that are stored in Amazon S3 through the gateway virtual private cloud (VPC) endpoint.
4. The Java Archive (JAR) file for the Blu Age application might need to communicate with other data sources, such as Amazon Aurora.
5. After completion, the wrapper script delivers the resulting output files into an S3 bucket for further processing (for example, by Amazon CloudWatch logging services). The pattern also supports delivering zipped log files to Amazon S3, if you're using an alternative to standard CloudWatch logging.

## Tools

### AWS services

- [Amazon Elastic Container Registry \(Amazon ECR\)](#) is a managed container image registry service that's secure, scalable, and reliable.
- [Amazon Elastic Container Service \(Amazon ECS\)](#) is a fast and scalable container management service that helps you run, stop, and manage containers on a cluster.

## Tools

- [Docker](#) is a software platform for building, testing, and deploying applications. Docker packages software into standardized units called [containers](#), which have everything the software needs to run, including libraries, system tools, code, and runtime. You can use Docker to deploy and scale applications into any environment.
- [Bash](#) is a command language interface (shell) for the GNU operating system.
- [Java](#) is the programming language and development environment used in this pattern.
- [Blu Age](#) is an AWS mainframe modernization tool that converts legacy mainframe workloads, including application code, dependencies, and infrastructure, into modern workloads for the cloud.

## Code repository

The code for this pattern is available in the GitHub [Blu Age sample container repository](#).

## Best practices

- Externalize the variables for altering your application's behavior by using environment variables. These variables enable the container orchestration solution to alter the runtime environment without rebuilding the container. This pattern includes examples of environment variables that can be useful for Blu Age applications.
- Validate any application dependencies before you run your Blu Age application. For example, verify that the database is available and credentials are valid. Write tests in the wrapper script to verify dependencies, and fail early if they are not met.
- Use verbose logging within the wrapper script. Interacting directly with a running container can be challenging, depending on the orchestration platform and how long the job takes. Make sure that useful output is written to STDOUT to help diagnose any issues. For example, output might include the contents of the application's working directory both before and after you run the application.



## Epics

### Obtain a Blu Age application JAR file

Task	Description	Skills required
Option 1 - Work with Blu Age to obtain your application's JAR file.	<p>The container in this pattern requires a Blu Age application. Alternatively, you can use the sample Java application that's provided with this pattern for a prototype.</p> <p>Work with the Blu Age team to obtain a JAR file for your application that can be baked into the container. If the JAR file isn't available, see the next task to use the sample application instead.</p>	Cloud architect
Option 2 - Build or use the supplied sample application JAR file.	<p>This pattern provides a prebuilt sample JAR file. This file outputs the application's environment variables to STDOUT before sleeping for 30 seconds and exiting.</p> <p>This file is named <code>bluAgeSample.jar</code> and is located in the <a href="#">docker folder</a> of the GitHub repository.</p> <p>If you want to alter the code and build your own version of the JAR file, use the source code located at <a href="#">./java_sample/src/sample_java_app.jar</a></p>	App developer

Task	Description	Skills required
	<p><a href="#">va</a> in the GitHub repository. You can use the build script at <a href="#">./java_sample/build.sh</a> to compile the Java source and build a new JAR file.</p>	

## Build the Blu Age container

Task	Description	Skills required
Clone the GitHub repository.	<p>Clone the sample code repository by using the command:</p> <pre data-bbox="594 898 1027 1098">git clone https://github.com/aws-samples/aws-blu-age-sample-container</pre>	AWS DevOps
Use Docker to build the container.	<p>Use Docker to build the container before you push it to a Docker registry such as Amazon ECR:</p> <ol style="list-style-type: none"> <li>1. From your chosen terminal, navigate to the <code>docker</code> folder within your local GitHub repository.</li> <li>2. Use this command to build the container:</li> </ol> <pre data-bbox="634 1682 1027 1793">docker build -t &lt;tag&gt; .</pre>	AWS DevOps

Task	Description	Skills required
	where <tag> is the container name you want to use.	
Test the Blu Age container.	<p>(Optional) If necessary, test the container locally by using the command:</p> <pre data-bbox="597 583 1029 705">docker run -it &lt;tag&gt; /bin/bash</pre>	AWS DevOps

Task	Description	Skills required
Authenticate to your Docker repository.	<p>If you plan to use Amazon ECR, follow the instructions in the <a href="#">Amazon ECR documentation</a> to install and configure the AWS CLI and authenticate the Docker CLI to your default registry.</p> <p>We recommend that you use the <a href="#">get-login-password command</a> for authentication.</p> <p><b>Note:</b> The <a href="#">Amazon ECR console</a> provides a pre-populated version of this command if you use the <b>View push commands</b> button. For more information, see the <a href="#">Amazon ECR documentation</a>.</p> <pre>aws ecr get-login -password --region &lt;region&gt;   docker login --username AWS --password-stdin &lt;account&gt;.dkr.ecr. &lt;region&gt;.amazonaws .com</pre> <p>If you don't plan to use Amazon ECR, follow the instructions provided for your container registry system.</p>	AWS DevOps

Task	Description	Skills required
Create a container repository.	<p>Create a repository in Amazon ECR. For instructions, see the pattern <a href="#">Deploy an environment for containerized Blue applications by using Terraform</a>.</p> <p>If you're using another container registry system, follow the instructions provided for that system.</p>	AWS DevOps

Task	Description	Skills required
Tag and push your container to the target repository.	<p>If you're using Amazon ECR:</p> <ol style="list-style-type: none"><li>1. Tag the local Docker image with the Amazon ECR registry and repository, so you can push it to your remote repository:</li></ol> <pre data-bbox="634 569 1027 846">docker tag &lt;tag&gt;:latest &lt;account&gt;.dkr.ecr.&lt;region&gt;.amazonaws.com/&lt;repository&gt;:&lt;versionNumber&gt;</pre> <ol style="list-style-type: none"><li>2. Push the image to the remote repository:</li></ol> <pre data-bbox="634 982 1027 1220">docker push &lt;account&gt;.dkr.ecr.&lt;region&gt;.amazonaws.com/&lt;repository&gt;:&lt;versionNumber&gt;</pre> <p>For more information, see <a href="#">Pushing a Docker image</a> in the <i>Amazon ECR User Guide</i>.</p>	AWS DevOps

## Related resources

### AWS resources

- [AWS Blu Age sample container repository](#)
- [Running modernized Blu Age mainframe workloads on serverless AWS infrastructure](#)
- [Deploy an environment for containerized Blu Age applications by using Terraform](#)

- [Using Amazon ECR with the AWS CLI](#) (*Amazon ECR User Guide*)
- [Private registry authentication](#) (*Amazon ECR User Guide*)
- [Amazon ECS documentation](#)
- [Amazon EKS documentation](#)

### **Additional resources**

- [Blu Age website](#)
- [Docker website](#)

# Convert and unpack EBCDIC data to ASCII on AWS by using Python

Created by Luis Gustavo Dantas (AWS)

<b>Code repository:</b> <a href="#">Mainframe Data Utilities</a>	<b>Environment:</b> PoC or pilot	<b>Source:</b> Mainframe EBCDIC data
<b>Target:</b> Distributed or cloud modernized ASCII data	<b>R Type:</b> Replatform	<b>Workload:</b> IBM
<b>Technologies:</b> Mainframe; Databases; Storage & backup; Modernization	<b>AWS services:</b> Amazon EBS; Amazon EC2	

## Summary

Because mainframes typically host critical business data, modernizing data is one of the most important tasks when migrating data to the Amazon Web Services (AWS) Cloud or other American Standard Code for Information Interchange (ASCII) environment. On mainframes, data is typically encoded in extended binary-coded decimal interchange code (EBCDIC) format. Exporting database, Virtual Storage Access Method (VSAM), or flat files generally produces packed, binary EBCDIC files, which are more complex to migrate. The most commonly used database migration solution is change data capture (CDC), which, in most cases, automatically converts data encoding. However, CDC mechanisms might not be available for these database, VSAM, or flat files. For these files, an alternative approach is required to modernize the data.

This pattern describes how to modernize EBCDIC data by converting it to ASCII format. After conversion, you can load the data into distributed databases or have applications in the cloud process the data directly. The pattern uses the conversion script and sample files in the [mainframe-data-utilities](#) GitHub repository.

## Prerequisites and limitations

### Prerequisites



- An active AWS account.
- An EBCDIC input file and its corresponding common business-oriented language (COBOL) copybook. A sample EBCDIC file and COBOL copybook are included in the [mainframe-data-utilities](#) GitHub repository. For more information about COBOL copybooks, see [Enterprise COBOL for z/OS 6.4 Programming Guide](#) on the IBM website.

## Limitations

- File layouts defined inside COBOL programs are not supported. They must be made available separately.

## Product versions

- Python version 3.8 or later

## Architecture

### Source technology stack

- EBCDIC data on a mainframe
- COBOL copybook

### Target technology stack

- Amazon Elastic Compute Cloud (Amazon EC2) instance in a virtual private cloud (VPC)
- Amazon Elastic Block Store (Amazon EBS)
- Python and its required packages, JavaScript Object Notation (JSON), sys, and datetime
- ASCII flat file ready to be read by a modern application or loaded in a relational database table

### Target architecture

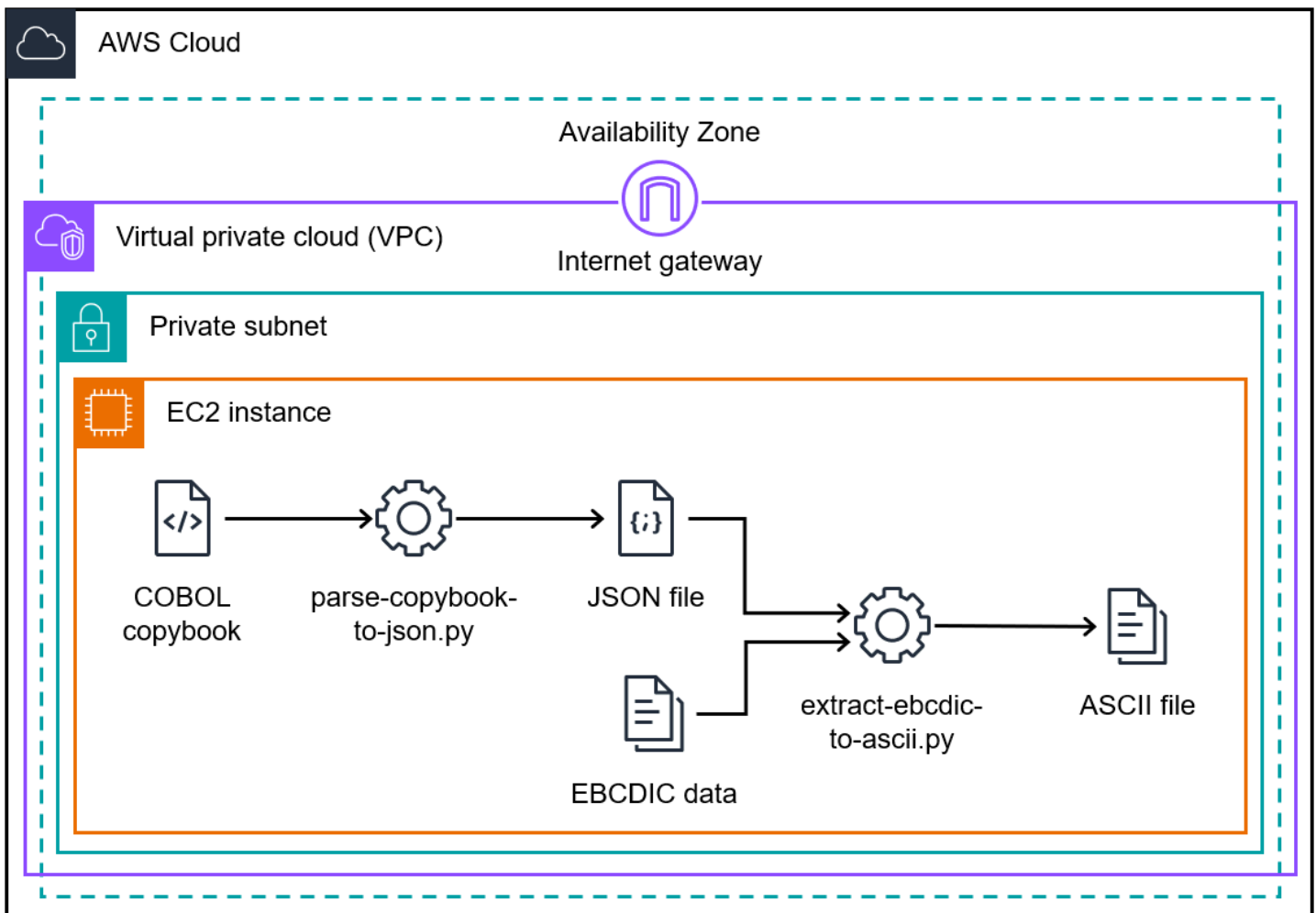

The architecture diagram shows the process of converting an EBCDIC file to an ASCII file on an EC2 instance:

1. Using the **parse\_copybook\_to\_json.py** script, you convert the COBOL copybook to a JSON file.
2. Using the JSON file and the **extract\_ebcdic\_to\_ascii.py** script, you convert the EBCDIC data to an ASCII file.

### Automation and scale

After the resources needed for the first manual file conversions are in place, you can automate file conversion. This pattern doesn't include instructions for automation. There are multiple ways to automate the conversion. The following is an overview of one possible approach:

1. Encapsulate the AWS Command Line Interface (AWS CLI) and Python script commands into a shell script.

2. Create an AWS Lambda function that asynchronously submits the shell script job into an EC2 instance. For more information, see [Scheduling SSH jobs using AWS Lambda](#).
3. Create an Amazon Simple Storage Service (Amazon S3) trigger that invokes the Lambda function every time a legacy file is uploaded. For more information, see [Using an Amazon S3 trigger to invoke a Lambda function](#).

## Tools

### AWS services

- [Amazon Elastic Compute Cloud \(Amazon EC2\)](#) provides scalable computing capacity in the AWS Cloud. You can launch as many virtual servers as you need, and quickly scale them up or down.
- [Amazon Elastic Block Store \(Amazon EBS\)](#) provides block-level storage volumes for use with Amazon Elastic Compute Cloud (Amazon EC2) instances.
- [AWS Command Line Interface \(AWS CLI\)](#) is an open-source tool that helps you interact with AWS services through commands in your command-line shell.
- [AWS Identity and Access Management \(IAM\)](#) helps you securely manage access to your AWS resources by controlling who is authenticated and authorized to use them.

### Other tools

- [GitHub](#) is a code-hosting service that provides collaboration tools and version control.
- [Python](#) is a high-level programming language.

### Code repository

The code for this pattern is available in the [mainframe-data-utilities](#) GitHub repository.

## Epics

### Prepare the EC2 instance

Task	Description	Skills required
Launch an EC2 instance.	The EC2 instance must have outbound internet access.	General AWS

Task	Description	Skills required
	<p>This allows the instance to access the Python source code available on GitHub. To create the instance:</p> <ol style="list-style-type: none"><li data-bbox="594 436 1019 613">1. Open the Amazon EC2 console at <a href="https://console.aws.amazon.com/ec2">https://console.aws.amazon.com/ec2</a>.</li><li data-bbox="594 634 1019 1150">2. Launch an EC2 Linux instance. Use a public IP address and allow inbound access through port 22. Ensure that the storage size of the instance is at least twice the size of the EBCDIC data file. For instructions, see the <a href="#">Amazon EC2 documentation</a>.</li></ol>	

Task	Description	Skills required
Install Git.	<ol style="list-style-type: none"><li data-bbox="594 226 1026 499">1. Using a secure shell (SSH) client, connect to the EC2 instance you just launched. For more information, see <a href="#">Connect to your Linux instance</a>.</li><li data-bbox="594 520 1026 699">2. In the Amazon EC2 console, run the following command. This installs Git on the EC2 instance. <pre data-bbox="634 741 1026 814">sudo yum install git</pre></li><li data-bbox="594 835 1026 1014">3. Run the following command and confirm that Git has been successfully installed. <pre data-bbox="634 1056 1026 1129">git --version</pre></li></ol>	General AWS, Linux

Task	Description	Skills required
Install Python.	<ol style="list-style-type: none"><li data-bbox="592 226 1027 451">1. In the Amazon EC2 console, run the following command. This installs Python on the EC2 instance. <pre data-bbox="630 489 1027 606">sudo yum install python3</pre></li><li data-bbox="592 625 1027 804">2. In the Amazon EC2 console, run the following command. This installs Pip3 on the EC2 instance. <pre data-bbox="630 842 1027 959">sudo yum install python3-pip</pre></li><li data-bbox="592 978 1027 1245">3. In the Amazon EC2 console, run the following command. This installs AWS SDK for Python (Boto3) on the EC2 instance. <pre data-bbox="630 1283 1027 1400">sudo pip3 install boto3</pre></li><li data-bbox="592 1419 1027 1829">4. In the Amazon EC2 console, run the following command, where <code>&lt;us-east-1&gt;</code> is the code for your AWS Region. For a complete list of Region codes, see <a href="#">Available Regions</a> in the Amazon EC2 documentation.</li></ol>	General AWS, Linux

Task	Description	Skills required
	<pre>export AWS_DEFAU LT_REGION=&lt;us-east -1&gt;</pre>	
Clone the GitHub repository.	<ol style="list-style-type: none"> <li>In the Amazon EC2 console, run the following command. This clones the <b>mainframe-data-utilities</b> repository from GitHub and opens the default copy location, the home folder. <pre>git clone https://g ithub.com/aws-samp les/mainframe-data- utilities.git</pre> </li> <li>In the home folder, confirm that the <code>mainframe-data-utilities</code> folder is present.</li> </ol>	General AWS, GitHub

## Create the ASCII file from the EBCDIC data

Task	Description	Skills required
Parse the COBOL copybook into the JSON layout file.	Inside the <code>mainframe-data-utilities</code> folder, run the <b>parse_copybook_to_json.py</b> script. This automation module reads the file layout from a COBOL copybook and creates a JSON file. The JSON file contains the informati	General AWS, Linux

Task	Description	Skills required
	<p>on required to interpret and extract the data from the source file. This creates the JSON metadata from the COBOL copybook.</p> <p>The following command converts the COBOL copybook to a JSON file.</p> <pre data-bbox="592 646 1031 1207">python3 parse_copybook_to_json.py \ -copybook LegacyReference/COBPACK2.cpy \ -output sample-data/cobpack2-list.json \ -dict sample-data/cobpack2-dict.json \ -ebcdic sample-data/COBPACK.OUTFILE.txt \ -ascii sample-data/COBPACK.ASCII.txt \ -print 10000</pre> <p>The script prints the received arguments.</p> <pre data-bbox="592 1360 1031 1774">----- ----- ----- ----- Copybook file..... .....  LegacyReference/COBPACK2.cpy Parsed copybook (JSON List).  sample-data/cobpack2-list.json</pre>	



Task	Description	Skills required
	<pre> JSON Dict (document ation)...  sample-da ta/cobpack2-dict.json ASCII file..... .....  sample- data/COBPACK.ASCII.t xt EBCDIC file..... .....  sample- data/COBPACK.OUTFILE .txt Print each..... .....  10000 ----- ----- ----- -----                     </pre> <p>For more information about the arguments, see the <a href="#">README file</a> in the GitHub repository.</p>	

Task	Description	Skills required
Inspect the JSON layout file.	<ol style="list-style-type: none"><li>1. Navigate to the output path defined in the <b>parse_copybook_to_json.py</b> script.</li><li>2. Check the creation time of the <b>sample-data/cobpack2-list.json</b> file to confirm that you have selected the appropriate JSON layout file.</li><li>3. Examine the JSON file and confirm that the contents are similar to the following.</li></ol> <pre data-bbox="594 926 1027 1724">"input": "extract-ebcdic-to-ascii/COBPACK.OUTFILE.txt", "output": "extract-ebcdic-to-ascii/COBPACK.ASCII.txt", "max": 0, "skip": 0, "print": 10000, "lrecl": 150, "rem-low-values": true, "separator": " ", "transf": [ { "type": "ch", "bytes": 19, "name": "OUTFILE-TEXT" } ]</pre> <p data-bbox="594 1759 1027 1845">The most important attributes of the JSON layout file are:</p>	General AWS, JSON

Task	Description	Skills required
	<ul style="list-style-type: none"><li>• <code>input</code> – Contains the path of the EBCDIC file to be converted</li><li>• <code>output</code> – Defines the path where the ASCII file will be generated</li><li>• <code>lrec1</code> – Specifies the size in bytes of the logical record length</li><li>• <code>transf</code> – Lists all fields and their size in bytes</li></ul> <p>For more information about the JSON layout file, see the <a href="#">README file</a> in the GitHub repository.</p>	

Task	Description	Skills required
Create the ASCII file.	<p>Run the <b>extract_ebcdic_to_ascii.py</b> script, which is included in the cloned GitHub repository. This script reads the EBCDIC file and writes a converted and readable ASCII file.</p> <pre data-bbox="594 583 1029 785">python3 extract_ebcdic_to_ascii.py -local-json sample-data/cobpack2-list.json</pre> <p>As the script processes the EBCDIC data, it prints a message for every batch of 10,000 records. See the following example.</p> <pre data-bbox="594 1083 1029 1812">----- ----- ----- ----- 2023-05-15 21:21:46. 322253   Local Json file   -local-json   sample-data/cobpack2- list.json 2023-05-15 21:21:47. 034556   Records processed   10000 2023-05-15 21:21:47. 736434   Records processed   20000 2023-05-15 21:21:48. 441696   Records processed   30000</pre>	General AWS

Task	Description	Skills required
	<pre> 2023-05-15 21:21:49. 173781   Records processed   40000 2023-05-15 21:21:49. 874779   Records processed   50000 2023-05-15 21:21:50. 705873   Records processed   60000 2023-05-15 21:21:51. 609335   Records processed   70000 2023-05-15 21:21:52. 292989   Records processed   80000 2023-05-15 21:21:52. 938366   Records processed   89280 2023-05-15 21:21:52. 938448 Seconds 6.616232                 </pre> <p>For information about how to change the print frequency , see the <a href="#">README file</a> in the GitHub repository.</p>	

Task	Description	Skills required
Examine the ASCII file.	<ol style="list-style-type: none"><li data-bbox="592 226 998 451">1. Check the creation time of the <b>extract-ebcdic-to-ascii/COBPACK.ASCII.txt</b> file to verify that it was recently created.</li><li data-bbox="592 472 998 697">2. In the Amazon EC2 console, enter the following command. This opens the first record of the ASCII file. <pre data-bbox="633 735 1031 892">head sample-data/COBPACK.ASCII.txt -n 1   xxd</pre></li><li data-bbox="592 913 998 1470">3. Examine the contents of the first record. Because EBCDIC files are usually binary, they don't have carriage return and line feed (CRLF) special characters. The <b>extract_ebcdic_to_ascii.py</b> script adds a pipe character as a column separator, which is defined in the script parameters.</li></ol> <p data-bbox="592 1543 998 1722">If you used the sample EBCDIC file provided, the following is the first record in the ASCII file.</p>	General AWS, Linux

Task	Description	Skills required
	<pre> 00000000: 2d30 3030 3030 3030 3030 3130 3030 3030 -0000000000100000 00000010: 3030 307c 3030 3030 3030 3030 3031 3030 000 00000 0000100 00000020: 3030 3030 3030 7c2d 3030 3030 3030 3030 000000 -0 0000000 00000030: 3031 3030 3030 3030 3030 7c30 7c30 7c31 0100000000  0 0 1 00000040: 3030 3030 3030 3030 7c2d 3130 3030 3030 00000000  -100000 00000050: 3030 307c 3130 3030 3030 3030 307c 2d31 000 10000 0000 -1 00000060: 3030 3030 3030 3030 7c30 3030 3030 7c30 00000000  00000 0 00000070: 3030 3030 7c31 3030 3030 3030 3030 7c2d 0000 1000 00000 - 00000080: 3130 3030 3030 3030 307c 3030 3030 3030 100000000  000000 00000090: 3030 3030 3130 3030 3030 3030 307c 2d30 000010000 0000 -0 000000a0: 3030 3030 3030 3030 3031 3030 </pre>	

Task	Description	Skills required
	<pre>3030 3030 0000000000 1000000 000000b0: 3030 7c41 7c41 7c0a 00 A A .</pre>	



Task	Description	Skills required
Evaluate the EBCDIC file.	<p>In the Amazon EC2 console, enter the following command. This opens the first record of the EBCDIC file.</p> <pre data-bbox="592 441 1031 598">head sample-data/COBPAC K.OUTFILE.txt -c 150   xxd</pre> <p>If you used the sample EBCDIC file, the following is the result.</p> <pre data-bbox="592 808 1031 1848">00000000: 60f0 f0f0 f0f0 f0f0 f0f0 f1f0 f0f0 f0f0 `..... ..... 00000010: f0f0 f0f0 f0f0 f0f0 f0f0 f0f0 f1f0 f0f0 ..... ..... 00000020: f0f0 f0f0 f0f0 f0f0 f0f0 f0f0 f0f0 f1f0 ..... ..... 00000030: f0f0 f0f0 f0f0 d000 0000 0005 f5e1 00fa ..... ..... 00000040: 0a1f 0000 0000 0005 f5e1 00ff ffff fffa ..... ..... 00000050: 0a1f 0000 000f 0000 0c10 0000 000f 1000 ..... ..... 00000060: 0000 0d00 0000 0000 1000 0000</pre>	General AWS, Linux, EBCDIC

Task	Description	Skills required
	<pre data-bbox="592 205 1031 703"> 0f00 0000 ..... ..... 00000070: 0000 1000 0000 0dc1 c100 0000 0000 0000 ..... ..... 00000080: 0000 0000 0000 0000 0000 0000 0000 0000 ..... ..... 00000090: 0000 0000 0000 ..... </pre> <p data-bbox="592 735 1031 1509">To evaluate the equivalence between the source and target files, comprehensive knowledge of EBCDIC is required. For example, the first character of the sample EBCDIC file is a hyphen (-). In hexadecimal notation of the EBCDIC file, this character is represented by 60, and in hexadecimal notation of the ASCII file, this character is represented by 2D. For an EBCDIC-to-ASCII conversion table, see <a href="#">EBCDIC to ASCII</a> on the IBM website.</p>	

## Related resources

### References

- [The EBCDIC character set](#) (IBM documentation)
- [EBCDIC to ASCII](#) (IBM documentation)

- [COBOL](#) (IBM documentation)
- [Basic JCL concepts](#) (IBM documentation)
- [Connect to your Linux instance](#) (Amazon EC2 documentation)

## Tutorials

- [Scheduling SSH jobs using AWS Lambda](#) (AWS blog post)
- [Using an Amazon S3 trigger to invoke a Lambda function](#) (AWS Lambda documentation)

# Convert mainframe files from EBCDIC format to character-delimited ASCII format in Amazon S3 using AWS Lambda

Created by Luis Gustavo Dantas (AWS)

<b>Code repository:</b> <a href="#">Mainframe Data Utilities</a>	<b>Environment:</b> PoC or pilot	<b>Source:</b> IBM EBCDIC files
<b>Target:</b> Delimited ASCII files	<b>R Type:</b> Replatform	<b>Workload:</b> IBM
<b>Technologies:</b> Mainframe	<b>AWS services:</b> AWS CloudShell; AWS Lambda; Amazon S3; Amazon CloudWatch	

## Summary

This pattern shows you how to launch an AWS Lambda function that automatically converts mainframe EBCDIC (Extended Binary Coded Decimal Interchange Code) files to character-delimited ASCII (American Standard Code for Information Interchange) files. The Lambda function runs after the ASCII files are uploaded to an Amazon Simple Storage Service (Amazon S3) bucket. After the file conversion, you can read the ASCII files on x86-based workloads or load the files into modern databases.

The file conversion approach demonstrated in this pattern can help you overcome the challenges of working with EBCDIC files on modern environments. Files encoded in EBCDIC often contain data represented in a binary or packed decimal format, and fields are fixed-length. These characteristics create obstacles because modern x86-based workloads or distributed environments generally work with ASCII-encoded data and can't process EBCDIC files.

## Prerequisites and limitations

### Prerequisites

- An active AWS account
- An S3 bucket

- An AWS Identity and Access Management (IAM) user with administrative permissions
- AWS CloudShell
- [Python 3.8.0](#) or later
- A flat file encoded in EBCDIC and its corresponding data structure in a common business-oriented language (COBOL) copybook

**Note:** This pattern uses a sample EBCDIC file ([CLIENT.EBCDIC.txt](#)) and its corresponding COBOL copybook ([COBKS05.cpy](#)). Both files are available in the GitHub [mainframe-data-utilities](#) repository.

## Limitations

- COBOL copybooks usually hold multiple layout definitions. The [mainframe-data-utilities](#) project can parse this kind of copybook but can't infer which layout to consider on data conversion. This is because copybooks don't hold this logic (which remains on COBOL programs instead). Consequently, you must manually configure the rules for selecting layouts after you parse the copybook.
- This pattern is subject to [Lambda quotas](#).

## Architecture

### Source technology stack

- IBM z/OS, IBM i, and other EBCDIC systems
- Sequential files with data encoded in EBCDIC (such as IBM Db2 unloads)
- COBOL copybook

### Target technology stack

- Amazon S3
- Amazon S3 event notification
- IAM
- Lambda function
- Python 3.8 or later
- Mainframe Data Utilities

- JSON metadata
- Character-delimited ASCII files

## Target architecture

The following diagram shows an architecture for converting mainframe EBCDIC files to ASCII files.

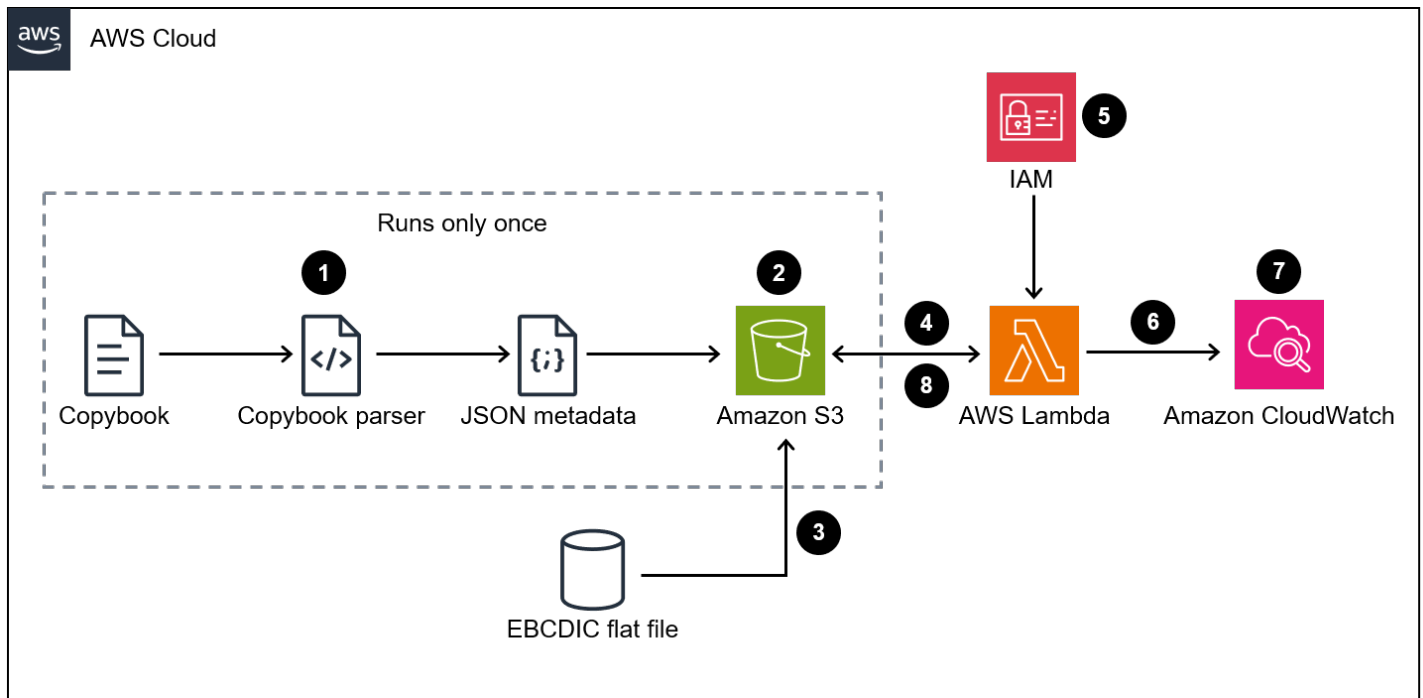

The diagram shows the following workflow:

1. The user runs the copybook parser script to convert the COBOL copybook into a JSON file.
2. The user uploads the JSON metadata to an S3 bucket. This makes the metadata readable by the data conversion Lambda function.
3. The user or an automated process uploads the EBCDIC file to the S3 bucket.
4. The S3 notification event triggers the data conversion Lambda function.
5. AWS verifies the S3 bucket read-write permissions for the Lambda function.
6. Lambda reads the file from the S3 bucket and locally converts the file from EBCDIC to ASCII.
7. Lambda logs the process status in Amazon CloudWatch.
8. Lambda writes the ASCII file back to Amazon S3.

**Note:** The copybook parser script runs only once, after it converts the metadata to JSON and then uploads that data to an S3 bucket. After the initial conversion, any EBCDIC file that uses the same JSON file that's uploaded to the S3 bucket will use the same metadata.

## Tools

### AWS tools

- [Amazon CloudWatch](#) helps you monitor the metrics of your AWS resources and the applications that you run on AWS in real time.
- [Amazon Simple Storage Service \(Amazon S3\)](#) is a cloud-based object storage service that helps you store, protect, and retrieve any amount of data.
- [AWS CloudShell](#) is a browser-based shell that you can use to manage AWS services by using the AWS Command Line Interface (AWS CLI) and a range of preinstalled development tools.
- [AWS Identity and Access Management \(IAM\)](#) helps you securely manage access to your AWS resources by controlling who is authenticated and authorized to use them.
- [AWS Lambda](#) is a compute service that helps you run code without needing to provision or manage servers. Lambda runs your code only when needed and scales automatically, so you pay only for the compute time that you use.

### Other tools

- [GitHub](#) is a code-hosting service that provides collaboration tools and version control.
- [Python](#) is a high-level programming language.

### Code

The code for this pattern is available in the GitHub [mainframe-data-utilities](#) repository.

## Best practices

Consider the following best practices:

- Set the required permissions at the Amazon Resource Name (ARN) level.
- Always grant least-privilege permissions for IAM policies. For more information, see [Security best practices in IAM](#) in the IAM documentation.

# Epics

## Create environment variables and a working folder

Task	Description	Skills required
Create the environment variables.	<p>Copy the following environment variables to a text editor, and then replace the &lt;placeholder&gt; values in the following example with your resource values:</p> <pre data-bbox="594 716 1027 995">bucket=&lt;your_bucket_name&gt; account=&lt;your_account_number&gt; region=&lt;your_region_code&gt;</pre> <p><b>Note:</b> You will create references to your S3 bucket, AWS account, and AWS Region later.</p> <p>To define environment variables, open the <a href="#">CloudShell console</a>, and then copy and paste your updated environment variables onto the command line.</p> <p><b>Note:</b> You must repeat this step every time the CloudShell session restarts.</p>	General AWS
Create a working folder.	To simplify the resource clean-up process later on, create a working folder in	General AWS



Task	Description	Skills required
	<p>CloudShell by running the following command:</p> <pre data-bbox="594 331 1027 449">mkdir workdir; cd workdir</pre> <p><b>Note:</b> You must change the directory to the working directory (<code>workdir</code>) every time you lose a connection to your CloudShell session.</p>	

## Define an IAM role and policy

Task	Description	Skills required
<p>Create a trust policy for the Lambda function.</p>	<p>The EBCDIC converter runs in a Lambda function. The function must have an IAM role. Before you create the IAM role, you must define a trust policy document that enables resources to assume that policy.</p> <p>From the CloudShell working folder, create a policy document by running the following command:</p> <pre data-bbox="594 1629 1027 1885">E2ATrustPol=\$(cat &lt;&lt;EOF {   "Version":   "2012-10-17",   "Statement": [     {</pre>	<p>General AWS</p>

Task	Description	Skills required
	<pre> "Effect":   "Allow",   "Principa 1": {    "Service": "lambda.a mazonaws.com"     },     "Action":     "sts:AssumeRole"   } ] } EOF ) printf "\$E2ATrustPol" &gt; E2ATrustPol.json </pre>	
<p>Create the IAM role for Lambda conversion.</p>	<p>To create an IAM role, run the following AWS CLI command from the CloudShell working folder:</p> <pre> aws iam create-role   --role-name E2AConvLa mbdaRole --assume- role-policy-docume nt file://E2ATrustPol .json </pre>	<p>General AWS</p>

Task	Description	Skills required
Create the IAM policy document for the Lambda function.	<p>The Lambda function must have read-write access to the S3 bucket and write permissions for Amazon CloudWatch Logs.</p> <p>To create an IAM policy, run the following command from the CloudShell working folder:</p> <pre data-bbox="594 709 1029 1877">E2APolicy=\$(cat &lt;&lt;EOF {   "Version":   "2012-10-17",   "Statement": [     {       "Sid":       "Logs",       "Effect":       "Allow",       "Action": [         "logs:PutLogEvents",         "logs:CreateLogStream",         "logs:CreateLogGroup"       ],       "Resource":       [         "arn:aws:logs:*:*:log-group:*",         "arn:aws:logs:*:*:log-group:*:log-stream:*"       ]     }   ] }</pre>	General AWS

Task	Description	Skills required
	<pre>        },         {             "Sid": "S3",             "Effect":                 "Allow",             "Action": [                 "s3:GetObject",                 "s3:PutObject",                 "s3:GetObjectVersion"             ],             "Resource":                 [                     "arn:aws:s3:::%s/*",                     "arn:aws:s3:::%s"                 ]         }     ] } EOF ) printf "\$E2APolicy" "\$bucket" "\$bucket" &gt; E2AConvLambdaPolic y.json</pre>	

Task	Description	Skills required
Attach the IAM policy document to the IAM role.	<p>To attach the IAM policy to the IAM role, run the following command from your CloudShell working folder:</p> <pre data-bbox="597 489 1027 806">aws iam put-role-policy   --role-name E2AConvLambdaRole --policy-name   E2AConvLambdaPolicy --policy-document   file://E2AConvLambdaPolicy.json</pre>	General AWS

### Create the Lambda function for EBCDIC conversion

Task	Description	Skills required
Download the EBCDIC conversion source code.	<p>From the CloudShell working folder, run the following command to download the mainframe-data-utilities source code from GitHub:</p> <pre data-bbox="597 1360 1027 1560">git clone https://github.com/aws-samples/mainframe-data-utilities.git mdu</pre>	General AWS
Create the ZIP package.	<p>From the CloudShell working folder, run the following command to create the ZIP package that creates the Lambda function for EBCDIC conversion:</p>	General AWS

Task	Description	Skills required
	<pre>cd mdu; zip ../mdu.zip *.py; cd ..</pre>	
Create the Lambda function.	<p>From the CloudShell working folder, run the following command to create the Lambda function for EBCDIC conversion:</p> <pre>aws lambda create-function \ --function-name E2A \ --runtime python3.9 \ --zip-file fileb://mdu.zip \ --handler extract_ebcdic_to_ascii.lambda_handler \ --role arn:aws:iam::\$account:role/E2AConvLambdaRole \ --timeout 10 \ --environment "Variables={layout=\$bucket/layout/}"</pre> <p><b>Note:</b> The environment variable layout tells the Lambda function where the JSON metadata resides.</p>	General AWS

Task	Description	Skills required
<p>Create the resource-based policy for the Lambda function.</p>	<p>From the CloudShell working folder, run the following command to allow your Amazon S3 event notification to trigger the Lambda function for EBCDIC conversion:</p> <pre data-bbox="597 583 1024 1100">aws lambda add-permission \ --function-name E2A \ --action lambda:InvokeFunction \ --principal s3.amazonaws.com \ --source-arn arn:aws:s3:::\$bucket \ --source-account \$account \ --statement-id 1</pre>	<p>General AWS</p>

## Create the Amazon S3 event notification

Task	Description	Skills required
<p>Create the configuration document for the Amazon S3 event notification.</p>	<p>The Amazon S3 event notification initiates the EBCDIC conversion Lambda function when files are placed in the input folder.</p> <p>From the CloudShell working folder, run the following command to create the JSON document for the Amazon S3 event notification:</p>	<p>General AWS</p>

Task	Description	Skills required
	<pre>{   "LambdaFunctionConfigurations": [     {       "Id": "E2A",       "LambdaFunctionArn": "arn:aws:lambda:%s:%s:function:E2A",       "Events": [         "s3:ObjectCreated:Put" ],       "Filter": {         "Key": {           "FilterRules": [             {               "Name": "prefix",               "Value": "input/"             }           ]         }       }     }   ] } EOF ) printf "\$S3E2AEvent" "\$region" "\$account" &gt; S3E2AEvent.json</pre>	



Task	Description	Skills required
Create the Amazon S3 event notification.	<p>From the CloudShell working folder, run the following command to create the Amazon S3 event notification:</p> <pre>aws s3api put-bucket-notification-configuration --bucket \$bucket --notification-configuration file://S3E2AEvent.json</pre>	General AWS

### Create and upload the JSON metadata

Task	Description	Skills required
Parse the COBOL copybook.	<p>From the CloudShell working folder, run the following command to parse a sample COBOL copybook into a JSON file (which defines how to read and slice the data file properly):</p> <pre>python3 mdu/parse_copybook_to_json.py \ -copybook mdu/LegacyReference/COBKS05.cpy \ -output CLIENT.json \ -output-s3key CLIENT.ASCII.txt \ -output-s3bkt \$bucket \ -output-type s3 \</pre>	General AWS

Task	Description	Skills required
	<pre>-print          25</pre>	
Add the transformation rule.	<p>The sample data file and its corresponding COBOL copybook is a multi-layout file. This means that the conversion must slice data based on certain rules. In this case, bytes on position 3 and 4 in each row define the layout.</p> <p>From the CloudShell working folder, edit the <code>CLIENT.js</code> on file and change the contents from <code>"transf-rule": []</code>, to the following:</p> <pre>"transf-rule": [   {     "offset": 4,     "size": 2,     "hex": "0002",     "transf": "transf1"   },   {     "offset": 4,     "size": 2,     "hex": "0000",     "transf": "transf2"   } ],</pre>	General AWS, IBM Mainframe , Cobol

Task	Description	Skills required
Upload the JSON metadata to the S3 bucket.	<p>From the CloudShell working folder, run the following AWS CLI command to upload the JSON metadata to your S3 bucket:</p> <pre>aws s3 cp CLIENT.json s3://\$bucket/layout/ CLIENT.json</pre>	General AWS

## Convert the EBCDIC file

Task	Description	Skills required
Send the EBCDIC file to the S3 bucket.	<p>From the CloudShell working folder, run the following command to send the EBCDIC file to the S3 bucket:</p> <pre>aws s3 cp mdu/sample- data/CLIENT.EBCDIC.txt s3://\$bucket/input/</pre> <p><b>Note:</b> We recommend that you set different folders for input (EBCDIC) and output (ASCII) files to avoid calling the Lambda conversion function again when the ASCII file is uploaded to the S3 bucket.</p>	General AWS
Check the output.	From the CloudShell working folder, run the following command to check if the	General AWS

Task	Description	Skills required
	<p>ASCII file is generated in your S3 bucket:</p> <pre>awss3 ls s3://\$bucket/</pre> <p><b>Note:</b> The data conversion can take several seconds to happen. We recommend that you check for the ASCII file a few times.</p> <p>After the ASCII file is available , run the following command to download the file from the S3 bucket to the current folder:</p> <pre>aws s3 cp s3://\$bucket/CLIENT.ASCII.txt .</pre> <p>Check the ASCII file content:</p> <pre>head CLIENT.ASCII.txt</pre>	

## Clean the environment

Task	Description	Skills required
(Optional) Prepare the variables and folder.	If you lose connection with CloudShell, reconnect and then run the following command to change the directory to the working folder:	General AWS

Task	Description	Skills required
	<pre>cd workdir</pre> <p>Ensure that the environment variables are defined:</p> <pre>bucket=&lt;your_bucket_name&gt; account=&lt;your_account_number&gt; region=&lt;your_region_code&gt;</pre>	
Remove the notification configuration for the bucket.	<p>From the CloudShell working folder, run the following command to remove the Amazon S3 event notification configuration:</p> <pre>aws s3api put-bucket-notification-configuration \ --bucket=\$bucket \ --notification-configuration="{}</pre>	General AWS
Delete the Lambda function.	<p>From the CloudShell working folder, run the following command to delete the Lambda function for the EBCDIC converter:</p> <pre>aws lambda delete-function --function-name E2A</pre>	General AWS

Task	Description	Skills required
Delete the IAM role and policy.	<p>From the CloudShell working folder, run the following command to remove the EBCDIC converter role and policy:</p> <pre>aws iam delete-role-policy --role-name E2AConvLambdaRole --policy-name E2AConvLambdaPolicy  aws iam delete-role --role-name E2AConvLambdaRole</pre>	General AWS
Delete the files generated in the S3 bucket.	<p>From the CloudShell working folder, run the following command to delete the files generated in the S3 bucket:</p> <pre>aws s3 rm s3://\$bucket/layout --recursive aws s3 rm s3://\$bucket/input --recursive aws s3 rm s3://\$bucket/CLIENT.ASCII.txt</pre>	General AWS
Delete the working folder.	<p>From the CloudShell working folder, run the following command to remove <code>workdir</code> and its contents:</p> <pre>cd ..; rm -Rf workdir</pre>	General AWS

## Related resources

- [Mainframe Data Utilities README](#) (GitHub)
- [The EBCDIC character set](#) (IBM documentation)
- [EBCDIC to ASCII](#) (IBM documentation)
- [COBOL](#) (IBM documentation)
- [Using an Amazon S3 trigger to invoke a Lambda function](#) (AWS Lambda documentation)

# Convert mainframe data files with complex record layouts using Micro Focus

Created by Peter West

<b>Environment:</b> Production	<b>Source:</b> Mainframe EBCDIC Data Files	<b>Target:</b> Micro Focus ASCII Data Files
<b>R Type:</b> Rehost	<b>Workload:</b> All other workloads	<b>Technologies:</b> Mainframe; Modernization
<b>AWS services:</b> AWS Mainframe Modernization		

## Summary

This pattern shows you how to convert mainframe data files with non-text data and complex record layouts from EBCDIC (Extended Binary Coded Decimal Interchange Code) character encoding to ASCII (American Standard Code for Information Interchange) character encoding by using a Micro Focus structure file. To complete the file conversion, you must do the following:

1. Prepare a single source file that describes all the data items and record layouts in your mainframe environment.
2. Create a structure file that contains the record layout of the data by using the Micro Focus Data File Editor as part of the Micro Focus Classic Data File Tools or Data File Tools. The structure file identifies the non-text data so that you can correctly convert your mainframe files from EBCDIC to ASCII.
3. Test the structure file by using the Classic Data File Tools or Data File Tools.

## Prerequisites and limitations

### Prerequisites

- An active AWS account
- Micro Focus Enterprise Developer for Windows, available through [AWS Mainframe Modernization](#)



## Product versions

- Micro Focus Enterprise Server 7.0 and later

## Tools

- [Micro Focus Enterprise Developer](#) provides the run environment for applications created with any integrated development environment (IDE) variant of Enterprise Developer.
- Micro Focus [Classic Data File Tools](#) help you convert, navigate, edit, and create data files. The Classic Data File Tools include [Data File Converter](#), [Record Layout Editor](#), and [Data File Editor](#).
- Micro Focus [Data File Tools](#) help you create, edit, and move data files. The Data File Tools include [Data File Editor](#), [File Conversion Utilities](#), and the [Data File Structure Command Line Utility](#).

## Epics

### Prepare the source file

Task	Description	Skills required
Identify source components.	<p>Identify all possible record layouts for the file, including any redefinitions that contain non-text data.</p> <p>If you have layouts that contain redefinitions, you must factor these layouts down to unique layouts that describe each possible permutation of the data structure. Typically, a data file's record layouts can be described by the following archetypes:</p> <ul style="list-style-type: none"> <li>• Record layout with only text data</li> </ul>	App developer

Task	Description	Skills required
	<ul style="list-style-type: none"><li>• Record layout with non-text data</li><li>• Record layout with non-text data subordinate to a REDEFINES clause</li></ul> <p>For more information on creating flattened record layouts for files that contain complex record layouts, see <a href="#">Rehosting EBCDIC applications on ASCII environments for mainframe migrations.</a></p>	

Task	Description	Skills required
Identify record layout conditions.	<p>For files with multiple record layouts or files that contain complex layouts with a REDEFINES clause, identify the data and conditions within a record that you can use to define which layout to use during conversion. We recommend that you discuss this task with a subject matter expert (SME) who understands the programs that process these files.</p> <p>For example, a file might contain two record types that contain non-text data. You can inspect the source and possibly find code similar to the following:</p> <pre data-bbox="594 1192 1027 1465">MOVE "M" TO PART-TYPE MOVE "MAIN ASSEMBLY" TO PART-NAME MOVE "S" TO PART-TYPE MOVE "SUB ASSEMBLY 1" TO PART-NAME</pre> <p>The code helps you identify the following:</p> <ul data-bbox="594 1633 984 1864" style="list-style-type: none"><li>• The "PART-TYPE" field is used to determine the record type</li><li>• The value "M" is used for the "M-PART-RECORD"</li></ul>	App developer

Task	Description	Skills required
	<ul style="list-style-type: none"><li>The value "S" is used for the "S-PART-RECORD"</li></ul> <p>You can document the values that are used by this field to associate the record layouts with the correct data records in the file.</p>	
Build the source file.	<p>If the file is described over multiple source files or if the record layout contains non-text data that's subordinate to a REDEFINES clause, then create a new source file that contains the record layouts. The new program doesn't need to describe the file using SELECT and FD statements. The program can simply contain the record descriptions as 01 levels within Working-Storage.</p> <p><b>Note:</b> You can create a source file for each data file or create a master source file that describes all the data files.</p>	App developer

Task	Description	Skills required
Compile the source file.	<p>Compile the source file to build the data dictionary. We recommend that you compile the source file by using the EBCDIC character set. If the IBMCOMP directive or ODOSLIDE directives are being used, then you must use these directives in the source file too.</p> <p><b>Note:</b> IBMCOMP affects the byte storage of COMP fields and ODOSLIDE affects padding on OCCURS VARYING structures. If these directives are set incorrectly, then the conversion tool won't read the data record correctly. This results in bad data in the converted file.</p>	App developer

### (Option A) Create the structure file using Classic Data File Tools

Task	Description	Skills required
Start the tool and load the dictionary.	<ol style="list-style-type: none"> <li>1. Choose the Windows Start menu icon, search for and choose <b>Micro Focus Enterprise Developer</b>, and then choose <b>Classic Data File Tools</b>.</li> <li>2. Choose <b>File</b>, and then choose <b>Record Layout</b>.</li> </ol>	App developer

Task	Description	Skills required
	<ol style="list-style-type: none"><li data-bbox="591 210 1032 533">3. In the <b>Select a file to construct the layouts from</b> dialog box, for <b>File name</b>, select the IDY (.idy) file that was created when you compiled the source file earlier. Then, choose <b>Open</b>.</li><li data-bbox="591 554 1032 877">4. To confirm that Classic Data File Tools is using EBCDIC, in the <b>Data File Tools</b> dialog box, choose <b>YES</b> if the IDY file is set to <b>EBCDIC</b> and <b>Datatools</b> is set to <b>ANSI</b>.</li></ol>	

Task	Description	Skills required
Create the default record layout.	<p>Use the default record layout for all records that don't match any conditional layouts.</p> <ol style="list-style-type: none"><li>1. In the <b>Layout</b> window, expand the data structure , and then locate the 01 level used for the default layout.</li><li>2. Right-click the 01 item, and then choose <b>New Layout</b>.</li><li>3. In the <b>New Record Layout Wizard</b> dialog box, choose <b>Default Layout</b>, and then choose <b>Next</b>.</li><li>4. Choose <b>Finish</b>.</li></ol> <p>The default layout appears in the <b>Layouts</b> pane and can be identified by the red folder icon.</p>	App developer

Task	Description	Skills required
Create a conditional record layout.	<p>Use the conditional record layout when there is more than one record layout in a file.</p> <ol style="list-style-type: none"><li>1. In the <b>Layouts</b> pane, expand the data structure , and then locate the 01 level used for the conditional layout.</li><li>2. Right-click the 01 item, and then choose <b>New Layout</b>.</li><li>3. In the <b>New Record Layout Wizard</b> dialog box, choose <b>Conditional Layout</b>, and then choose <b>Next</b>.</li><li>4. Choose <b>Finish</b>. The conditional layout appears in the <b>Layouts</b> pane and can be identified by the yellow folder icon.</li><li>5. Expand the conditional layout, right-click the field where you must place a condition, and then choose <b>Properties</b>.</li><li>6. In the <b>Field Properties</b> dialog box, enter the condition. Confirm that the character set is set to <b>EBCDIC</b>, and then choose <b>OK</b>. A checkmark appears</li></ol>	App developer



Task	Description	Skills required
	<p>next to the field that has a condition set.</p> <ol style="list-style-type: none"> <li>7. Repeat steps 5–6 for any other fields that require conditions for this layout.</li> <li>8. Repeat steps 1–6 for any other conditional layouts that must be added.</li> <li>9. Choose <b>File</b>, choose <b>Save As</b>, and then save the structure file to disk.</li> </ol>	

### (Option B) Create the structure file using Data File Tools

Task	Description	Skills required
<p>Start the tool and load the dictionary.</p>	<ol style="list-style-type: none"> <li>1. Choose the Windows Start menu icon, search for and choose <b>Micro Focus Enterprise Developer</b>, and then choose <b>Data File Tools</b>.</li> <li>2. Choose <b>File, New, Structure File</b>.</li> <li>3. In the <b>Open</b> dialog box, for <b>File name</b>, select the IDY (.idy) file that was created when you compiled the source file earlier. Then, choose <b>Open</b>.</li> <li>4. To confirm that Data File Tools is using EBCDIC, confirm that the drop-</li> </ol>	<p>App developer</p>

Task	Description	Skills required
	down menu in the <b>Debug File</b> section is set to <b>EBCDIC</b> .	
Create the default record layout.	<p>Use the default record layout for all records that do not match any conditional layouts.</p> <ol style="list-style-type: none"><li>1. In the <b>Available Layouts</b> section on the left pane, expand the data structure , and then locate the 01 level used for the default layout.</li><li>2. Right-click the 01 item, and then choose <b>Create Default Layout</b>.</li></ol> <p>The default layout appears in the <b>Layouts</b> pane and can be identified by the blue “D” icon.</p>	App developer

Task	Description	Skills required
Create a conditional record layout.	<p>Use the conditional record layout when there is more than one record layout in a file.</p> <ol style="list-style-type: none"><li>1. In the <b>Selected Layouts</b> section on the right pane, expand the data structure , and then locate the 01 level used for the conditional layout.</li><li>2. Right-click the 01 item, and then choose <b>Create Conditional Layout</b>. The conditional layout appears in the <b>Layouts</b> pane on the right side and can be identified by the green "C" icon.</li><li>3. Expand the conditional layout, right-click the field where you must place a condition, and then choose <b>Properties</b>.</li><li>4. In the <b>Field Properties</b> dialog box, enter the condition. Confirm that the character set is set to <b>EBCDIC</b>, and then choose <b>OK</b>. A red "IF" icon appears next to the field that has a condition set.</li></ol>	App developer

Task	Description	Skills required
	<ol style="list-style-type: none"> <li>5. Repeat steps 3–4 for any other fields that require conditions for this layout.</li> <li>6. Repeat steps 1–4 for any other conditional layouts that must be added.</li> <li>7. Choose <b>File</b>, choose <b>Save As</b>, and then save the structure file to disk.</li> </ol>	

### (Option A) Test the structure file using Classic Data File Tools

Task	Description	Skills required
Test an EBCDIC data file.	<p>Confirm that you can use your structure file to view an EBCDIC test data file correctly</p> <ul style="list-style-type: none"> <li>•</li> <li>1. Choose the Windows Start menu icon, find and choose <b>Micro Focus Enterprise Developer</b>, and then choose <b>Classic Data Tools</b>.</li> <li>2. Choose <b>File</b>, and then choose <b>Open</b>.</li> <li>3. In the <b>Open</b> dialog box, for <b>File name</b>, select the EBCDIC dataset, and then choose <b>Open</b>.</li> <li>4. Choose <b>File, Data File Editor, Load Record Layouts</b>.</li> </ul>	App developer

Task	Description	Skills required
	<ol style="list-style-type: none"> <li>5. In the <b>Open</b> dialog box, for <b>File name</b>, select the structure file, and then choose <b>Open</b>.</li> <li>6. To confirm that the character set mode is set to EBCDIC, confirm that the drop-down menu is set to <b>EBCDIC</b>. You can see the raw record data in the left pane and the formatted data in the right pane.</li> <li>7. Choose various records to ensure that all formats are rendered with the correct layout.</li> </ol>	

### (Option B) Test the structure file using Data File Tools

Task	Description	Skills required
Test an EBCDIC data file.	<p>Confirm that you can use your structure file to view an EBCDIC test data file correctly</p> <ul style="list-style-type: none"> <li>•</li> <li>1. Choose the Windows Start menu icon, find and select <b>Micro Focus Enterprise Developer</b>, and then choose <b>Data File Tools</b>.</li> <li>2. Choose <b>File, Open, Data File</b>.</li> </ul>	App developer

Task	Description	Skills required
	<ol style="list-style-type: none"><li>3. In the <b>Open Data File</b> dialog box, on the <b>Local</b> tab, for <b>Filename</b>, choose <b>Browse</b> to find the location of the EBCDIC test file.</li><li>4. For <b>Structure File (optional)</b>, choose <b>Browse</b> to find the location of the structure file.</li><li>5. In the <b>File Details</b> section, enter the details of the file and confirm that <b>Encoding</b> is set to <b>EBCDIC</b>.</li><li>6. Choose either <b>Open Shared</b> or <b>Open Exclusive</b> mode depending on your requirements.</li><li>7. Confirm that the drop-down menu in the <b>Appearance</b> section of the toolbar is set to <b>EBCDIC</b>. You will see the raw record data in the left pane and the formatted data in the right pane.</li><li>8. Choose various records to ensure that all formats are rendered with the correct layout.</li></ol>	

## Test data file conversion

Task	Description	Skills required
Test the conversion of an EBCDIC file.	<ol style="list-style-type: none"><li>1. Choose the Windows Start menu icon, find and select <b>Micro Focus Enterprise Developer</b>, and then choose <b>Classic Data Tools</b>.</li><li>2. Choose <b>Tools</b>, and then choose <b>Convert</b>.</li><li>3. In the <b>Data File Convert</b> dialog box, in the <b>Input file</b> section, for <b>Filename</b>, choose <b>Browse</b> to find and select the EBCDIC input file. Confirm that <b>Character set</b> is set to <b>EBCDIC</b>.</li><li>4. In the <b>Character Set Conversion</b> section, select the <b>Convert character set</b> and <b>Records contain non-text data items</b> check boxes. Choose <b>Select layout for conversion</b>, and then choose <b>Browse</b> to find and select the structure file.</li><li>5. In the <b>New file</b> section, for <b>Filename</b>, enter the path and file name of the ASCII output file that you want to create. By default, the conversion tool defaults to the same format as the</li></ol>	App developer

Task	Description	Skills required
	<p>input file. For testing, leave the options set to their default values.</p> <ol style="list-style-type: none"><li>6. Choose <b>Convert</b>.</li><li>7. Follow the steps in either the <i>(Option A) Test the structure file using Classic Data File Tools</i> or <i>(Option B) Test the structure file using Data File Tools</i> section, but load the ASCII output file instead of the EBCDIC file.</li><li>8. Load both the EBCDIC and ASCII files into the Data File Editor, and then compare the files side by side to check the accuracy of the conversion.</li></ol>	

## Related resources

- [Micro Focus](#) (Micro Focus documentation)
- [Mainframe and legacy code](#) (AWS Blog posts)
- [AWS Prescriptive Guidance](#) (AWS documentation)
- [AWS Documentation](#) (AWS documentation)
- [AWS General Reference](#) (AWS documentation)
- [AWS glossary](#) (AWS documentation)



# Deploy an environment for containerized Blu Age applications by using Terraform

Created by Richard Milner-Watts (AWS)

<b>Code repository:</b> <a href="#">Blu Age Sample ECS Infrastructure (Terraform)</a>	<b>Environment:</b> Production	<b>Source:</b> Mainframe
<b>Target:</b> Containers	<b>R Type:</b> Replatform	<b>Workload:</b> IBM; All other workloads
<b>Technologies:</b> Mainframe; Containers & microservices	<b>AWS services:</b> Amazon ECS; AWS Step Functions; Amazon VPC; Amazon Aurora	

## Summary

Migrating legacy mainframe workloads into modern cloud architectures can eliminate the costs of maintaining a mainframe—costs that only increase as the environment ages. However, migrating jobs from a mainframe can pose unique challenges. Internal resources might not be familiar with the job logic, and the high performance of mainframes at these specialized tasks can be difficult to replicate when compared to commodity, generalized CPUs. Rewriting these jobs can be a large undertaking and require significant effort.

Blu Age converts legacy mainframe workloads into modern Java code, which you can then run as a container.

This pattern provides a sample serverless architecture for running a containerized application that has been modernized with the Blu Age tool. The included HashiCorp Terraform files will build a secure architecture for the orchestration of Blu Age containers, supporting both batch tasks and real-time services.

For more information about modernizing your workloads by using Blu Age and AWS services, see these AWS Prescriptive Guidance publications:

- [Running mainframe workloads that have been modernized with Blu Age on AWS serverless infrastructure](#)
- [Containerize mainframe workloads that have been modernized by Blu Age](#)

For assistance with using Blu Age to modernize your mainframe workloads, contact the Blu Age team by choosing **Contact our experts** on the [Blu Age website](#). For assistance with migrating your modernized workloads to AWS, integrating them with AWS services, and moving them into production, contact your AWS account manager or fill out the [AWS Professional Services form](#).

## Prerequisites and limitations

### Prerequisites

- The sample containerized Blu Age application provided by the [Containerize mainframe workloads that have been modernized by Blu Age](#) pattern. The sample application provides the logic to handle the processing of input and output for the modernized application, and it can integrate with this architecture.
- Terraform is required to deploy these resources.

### Limitations

- Amazon Elastic Container Service (Amazon ECS) places limits on the task resources that can be made available to the container. These resources include CPU, RAM, and storage. For example, when using Amazon ECS with AWS Fargate, the [task resource limits apply](#).

### Product versions

This solution was tested with the following versions:

- Terraform 1.3.6
- Terraform AWS Provider 4.46.0

## Architecture

### Source technology stack

- Blu Age

- Terraform

### **Target technology stack**

- Amazon Aurora PostgreSQL-Compatible Edition
- AWS Backup
- Amazon Elastic Container Registry (Amazon ECR)
- Amazon ECS
- AWS Identity and Access Management Service (IAM)
- AWS Key Management Server (AWS KMS)
- AWS Secrets Manager
- Amazon Simple Notification Service (Amazon SNS)
- Amazon Simple Storage Service (Amazon S3)
- AWS Step Functions
- AWS Systems Manager

### **Target architecture**

The following diagram shows the solution architecture.

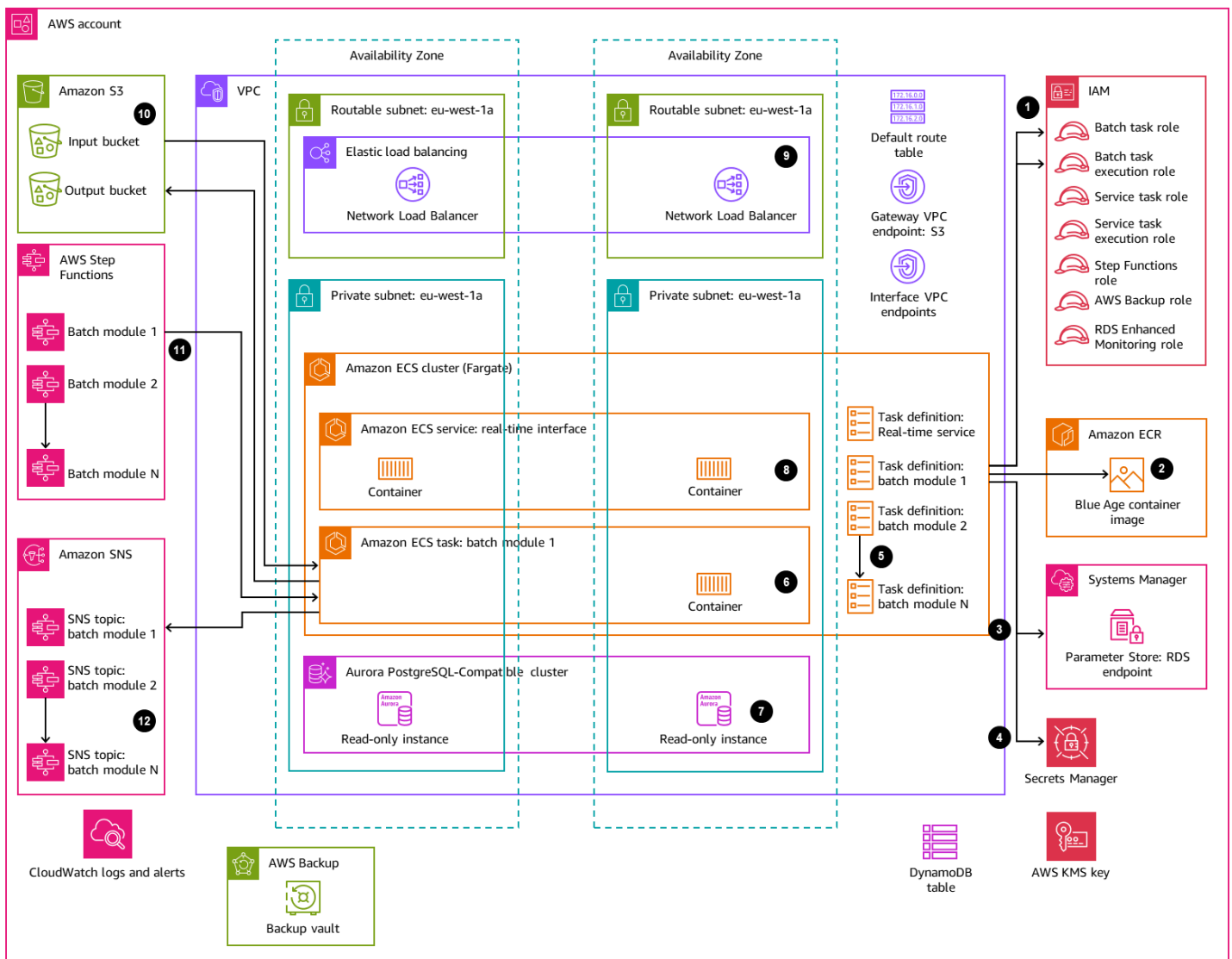

1. The solution deploys the following IAM roles:

- Batch task role
- Batch task execution role
- Service task role
- Service task execution role
- Step Functions role
- AWS Backup role
- RDS Enhanced Monitoring role.

The roles conform to least-privileged access principles.

2. Amazon ECR is used to store the container image that is orchestrated by this pattern.
3. AWS Systems Manager Parameter Store provides configuration data about each environment to the Amazon ECS task definition at runtime.
4. AWS Secrets Manager provides sensitive configuration data about the environment to the Amazon ECS task definition at runtime. The data has been encrypted by AWS KMS.
5. The Terraform modules create Amazon ECS task definitions for all real-time and batch tasks.
6. Amazon ECS runs a batch task by using AWS Fargate as the compute engine. This is a short-lived task, initiated as required by AWS Step Functions.
7. Amazon Aurora PostgreSQL-Compatible provides a database to support the modernized application. This replaces mainframe databases such as IBM Db2 or IBM IMS DB.
8. Amazon ECS runs a long-lived service to deliver a modernized real-time workload. These stateless applications run permanently with containers spread across Availability Zones.
9. A Network Load Balancer is used to grant access to the real-time workload. The Network Load Balancer supports earlier protocols, such as IBM CICS. Alternatively, you can use an Application Load Balancer with HTTP-based workloads.
- 10 Amazon S3 provides object storage for job inputs and outputs. The container should handle pull and push operations into Amazon S3 to prepare the working directory for the Blu Age application.
- 11 The AWS Step Functions service is used to orchestrate running the Amazon ECS tasks to process batch workloads.
- 12 SNS topics for each batch workload are used to integrate the modernized application with other systems, such as email, or to initiate additional actions, such as delivering output objects from Amazon S3 into FTP.

**Note:** By default, the solution has no access to the internet. This pattern assumes that the virtual private cloud (VPC) will be connected to other networks using a service such as [AWS Transit Gateway](#). As such, multiple interface VPC endpoints are deployed to grant access to the AWS services used by the solution. To turn on direct internet access, you can use the toggle in the Terraform module to replace the VPC endpoints with an internet gateway and the associated resources.

## Automation and scale

The use of serverless resources throughout this pattern helps to ensure that, by scaling out, there are few limits on the scale of this design. This reduces *noisy neighbor concerns*, such as the

competition for compute resources that might be experienced on the original mainframe. Batch tasks can be scheduled to run simultaneously as needed.

Individual containers are limited by the maximum sizes supported by Fargate. For more information, see the [Task CPU and memory](#) section in the Amazon ECS documentation.

To [scale real-time workloads horizontally](#), you can add containers.

## Tools

### AWS services

- [Amazon Aurora PostgreSQL-Compatible Edition](#) is a fully managed, ACID-compliant relational database engine that helps you set up, operate, and scale PostgreSQL deployments.
- [AWS Backup](#) is a fully managed service that helps you centralize and automate data protection across AWS services, in the cloud, and on premises.
- [Amazon Elastic Container Registry \(Amazon ECR\)](#) is a managed container image registry service that's secure, scalable, and reliable.
- [Amazon Elastic Container Service \(Amazon ECS\)](#) is a fast and scalable container management service that helps you run, stop, and manage containers on a cluster.
- [AWS Identity and Access Management \(IAM\)](#) helps you securely manage access to your AWS resources by controlling who is authenticated and authorized to use them.
- [AWS Key Management Service \(AWS KMS\)](#) helps you create and control cryptographic keys to help protect your data.
- [AWS Secrets Manager](#) helps you replace hardcoded credentials in your code, including passwords, with an API call to Secrets Manager to retrieve the secret programmatically.
- [Amazon Simple Notification Service \(Amazon SNS\)](#) helps you coordinate and manage the exchange of messages between publishers and clients, including web servers and email addresses.
- [Amazon Simple Storage Service \(Amazon S3\)](#) is a cloud-based object storage service that helps you store, protect, and retrieve any amount of data.
- [AWS Step Functions](#) is a serverless orchestration service that helps you combine AWS Lambda functions and other AWS services to build business-critical applications.
- [AWS Systems Manager Parameter Store](#) provides secure, hierarchical storage for configuration data management and secrets management.

## Other services

- [HashiCorp Terraform](#) is an open-source infrastructure as code (IaC) tool that helps you use code to provision and manage cloud infrastructure and resources. This pattern uses Terraform to create the sample architecture.

## Code repository

The source code for this pattern is available in the GitHub [Blu Age Sample ECS Infrastructure \(Terraform\)](#) repository.

## Best practices

- For test environments, use features such as the `forceDate` option to configure the modernized application to generate consistent test results by always running for a known time period.
- Tune each task individually to consume the optimal amount of resources. You can use [Amazon CloudWatch Container Insights](#) to obtain guidance on potential bottlenecks.

## Epics

### Prepare the environment for deployment

Task	Description	Skills required
Clone the solution source code.	Clone the solution code from the <a href="#">GitHub project</a> .	DevOps engineer
Bootstrap the environment by deploying resources to store the Terraform state.	<ol style="list-style-type: none"> <li>1. Open a terminal window, and confirm that Terraform is installed and that AWS credentials are available.</li> <li>2. Navigate to the <code>bootstrap-terraform</code> folder.</li> <li>3. Edit the file <code>main.tf</code> if you want to change the names of the S3 bucket</li> </ol>	DevOps engineer

Task	Description	Skills required
	<p>(<code>&lt;accountId&gt;-terraform-backend</code> ) and Amazon DynamoDB table (<code>terraform-lock</code> ).</p> <p>4. Run the <code>terraform apply</code> command to deploy the resources. Make a note of the S3 bucket and DynamoDB table names.</p>	

## Deploy the solution infrastructure

Task	Description	Skills required
Review and update the Terraform configuration.	<p>In the root directory, open the file <code>main.tf</code>, review the contents, and consider making the following updates:</p> <ol style="list-style-type: none"> <li>1. Update the AWS Region by searching for and replacing the string <code>eu-west-1</code> with desired Region that you want to use.</li> <li>2. Update the bucket name in the Terraform Backend block if the default was altered in the previous epic.</li> <li>3. Update the <code>dynamodb_table</code> value if the default was altered in the previous epic.</li> </ol>	DevOps engineer



Task	Description	Skills required
	<ol style="list-style-type: none"><li data-bbox="592 212 1008 533">4. Update the value of the <code>stack_prefix</code> variable to the string that you want. This string will be prepended to the names of all resources created by this pattern.</li><li data-bbox="592 554 992 737">5. Update the value of the <code>vpc_cidr</code>. This should be at least a /24 address range.</li><li data-bbox="592 758 1024 1703">6. Review the <code>Locals</code> section. This is used to define the Blu Age tasks that will be deployed. The solution will iterate over the list object <code>bluage_batch_modules</code>, creating the associated resources (Step Functions state machine, task definition, and SNS topic) for each element of the list. In some cases, you might want to adjust variables for different environments. For example, to force the runtime in test environments, you can change value of the <code>force_execution_time</code> variable.</li><li data-bbox="592 1724 1008 1850">7. To turn on internet access, change the value for <code>direct_internet_ac</code></li></ol>	

Task	Description	Skills required
	<p>cess_required from false to true. This will deploy an internet gateway, along with the NAT gateways and route tables that turn on public internet access for the infrastructure. By default, the solution will deploy interface VPC endpoints into a VPC without direct internet access.</p> <p>8. To grant access to any client-server workloads that are served through Elastic Load Balancing , update the values of additional_nlb_igress_cidrs with the CIDR networks that should be allowed.</p>	
Deploy the Terraform file.	<p>From your terminal, run the terraform apply command to deploy all resources. Review the changes generated by Terraform, and enter <b>yes</b> to initiate the build.</p> <p>Note that it can take over 15 minutes to deploy this infrastructure.</p>	DevOps engineer

## (Optional) Deploy a valid Blu Age containerized application

Task	Description	Skills required
Push the Blu Age container image to Amazon ECR.	Push the container into the Amazon ECR repository that you created in the previous epic. For instructions, see the <a href="#">Amazon ECR documentation</a> .  Make a note of the container image URI.	DevOps engineer
Update the Terraform to reference the Blu Age container image.	Update the file <code>main.tf</code> to reference the container image that you uploaded.	DevOps engineer
Redeploy the Terraform file.	From your terminal, run <code>terraform apply</code> to deploy all resources. Review the suggested updates from Terraform, and then enter <b>yes</b> to proceed with the deployment.	DevOps engineer

## Related resources

- [Blu Age](#)
- [Running mainframe workloads that have been modernized with Blu Age on AWS serverless infrastructure](#)
- [Containerize mainframe workloads that have been modernized by Blu Age](#)

# Generate data insights by using AWS Mainframe Modernization and Amazon Q in QuickSight

Created by Shubham Roy (AWS), Roshna Razack (AWS), and Santosh Kumar Singh (AWS)

**Environment:** PoC or pilot

**Technologies:** Mainframe  
; Analytics; Migration;  
Modernization; Machine  
learning & AI

**Workload:** IBM

**AWS services:** AWS Lambda;  
AWS Mainframe Moderniza  
tion; Amazon QuickSight;  
Amazon S3

## Summary

If your organization is hosting business-critical data in a mainframe environment, gaining insights from that data is crucial for driving growth and innovation. By unlocking mainframe data, you can build faster, secure, and scalable business intelligence to accelerate data-driven decision-making, growth, and innovation in the Amazon Web Services (AWS) Cloud.

This pattern presents a solution for generating business insights and creating sharable narratives from mainframe data by using [AWS Mainframe Modernization File Transfer](#) with BMC and [Amazon Q in QuickSight](#). Mainframe datasets are transferred to [Amazon Simple Storage Service \(Amazon S3\)](#) by using AWS Mainframe Modernization File Transfer with BMC. An AWS Lambda function formats and prepares mainframe data file for loading into Amazon QuickSight.

After the data is available in Amazon QuickSight, you can use natural language prompts with Amazon Q in QuickSight to create summaries of the data, ask questions, and generate data stories. You don't have to write SQL queries or learn a business intelligence (BI) tool.

## Business context

This pattern presents a solution for mainframe data analytics and data insights use cases. Using the pattern, you build a visual dashboard for your company's data. To demonstrate the solution,

this pattern uses a health care company that provides medical, dental, and vision plans to its members in the US. In this example, member demographics and plan information are stored in the mainframe datasets. The visual dashboard shows the following:

- Member distribution by region
- Member distribution by gender
- Member distribution by age
- Member distribution by plan type
- Members who have not completed preventive immunization

After you create the dashboard, you generate a data story that explains the insights from the previous analysis. The data story provides recommendations for increasing the number of members who have completed preventive immunizations.

## Prerequisites and limitations

### Prerequisites

- An active AWS account
- Mainframe datasets with business data
- Access to install a file transfer agent on the mainframe

### Limitations

- Your mainframe data file should be in one of the file formats supported by Amazon QuickSight. For a list supported file formats, see the [Amazon QuickSight documentation](#).

This pattern uses a Lambda function to convert the mainframe file into a format supported by Amazon QuickSight.

## Architecture

The following diagram shows an architecture for generating business insights from mainframe data by using AWS Mainframe Modernization File Transfer with BMC and Amazon Q in QuickSight.

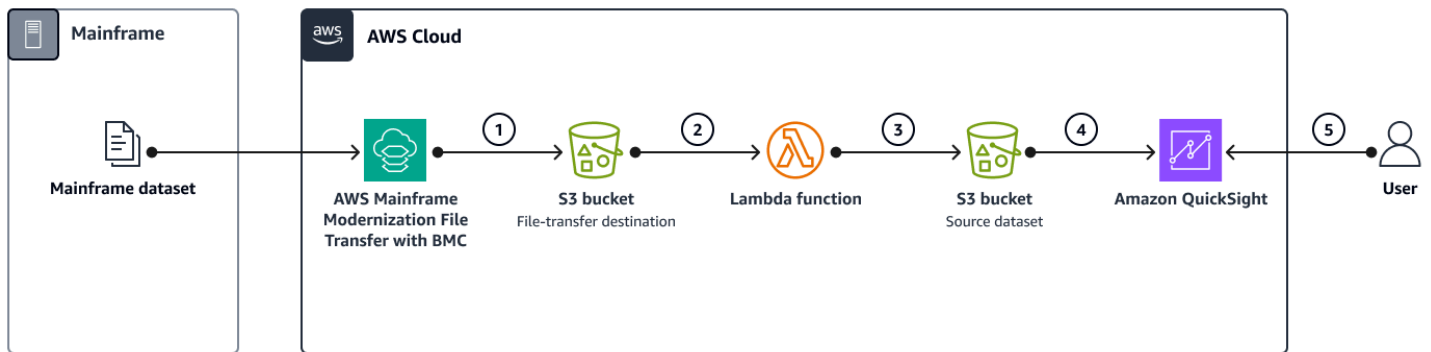

The diagram shows the following workflow:

1. A mainframe dataset containing business data is transferred to Amazon S3 by using AWS Mainframe Modernization File Transfer with BMC.
2. The Lambda function converts the file that's in the file-transfer destination S3 bucket to comma-separated values (CSV) format.
3. The Lambda function sends the converted file to the source dataset S3 bucket.
4. The data in the file is ingested by Amazon QuickSight.
5. Users access the data in Amazon QuickSight. You can use Amazon Q in QuickSight to interact with the data by using natural language prompts.

## Tools

### AWS services

- [AWS Lambda](#) is a compute service that helps you run code without needing to provision or manage servers. It runs your code only when needed and scales automatically, so you pay only for the compute time that you use.
- [AWS Mainframe Modernization File Transfer with BMC](#) converts and transfers mainframe datasets to Amazon S3 for mainframe modernization, migration, and augmentation use cases.
- [Amazon QuickSight](#) is a cloud-scale BI service that helps you visualize, analyze, and report your data in a single dashboard. This pattern uses the generative BI capabilities of [Amazon Q in QuickSight](#).
- [Amazon Simple Storage Service \(Amazon S3\)](#) is a cloud-based object storage service that helps you store, protect, and retrieve any amount of data.

## Best practices

- When you create the AWS Identity and Access Management (IAM) roles for AWS Mainframe Modernization File Transfer with BMC and the Lambda function, follow the principle of [least privilege](#).
- Ensure that your source dataset has [supported data types](#) for Amazon QuickSight. If your source dataset contains unsupported data types, convert them to supported data types. For information about unsupported mainframe data types and how to convert them to data types supported by Amazon Q in QuickSight, see the [Related resources](#) section.

## Epics

### Set up AWS Mainframe Modernization File Transfer with BMC

Task	Description	Skills required
Install the file transfer agent.	To install AWS Mainframe Modernization File Transfer Agent on your mainframe, follow the instructions in the <a href="#">AWS documentation</a> .	Mainframe system administrator
Create an S3 bucket for mainframe file transfer.	<a href="#">Create an S3 bucket</a> to store the output file from AWS Mainframe Modernization File Transfer with BMC. In the architecture diagram, this is the file-transfer destination bucket.	Migration engineer
Create the data transfer endpoint.	<ol style="list-style-type: none"> <li>1. Create an S3 bucket to stage the input mainframe file for AWS Mainframe Modernization File Transfer with BMC.</li> <li>2. To create the mainframe data transfer endpoint,</li> </ol>	AWS Mainframe Modernization specialist

Task	Description	Skills required
	follow the instructions in the <a href="#">AWS documentation</a> .	

## Convert the mainframe file name extension for Amazon QuickSight integration

Task	Description	Skills required
Create an S3 bucket.	<a href="#">Create an S3 bucket</a> for the Lambda function to copy the converted mainframe file from the source to the final destination bucket.	Migration engineer
Create a Lambda function.	To create a Lambda function that changes the file extension and copies the mainframe file to the destination bucket, do the following: <ol style="list-style-type: none"> <li>1. Sign in to the AWS Management Console, and navigate to the AWS Lambda console.</li> <li>2. Choose <b>Create function</b>, and then choose <b>Author from scratch</b>.</li> <li>3. For <b>Function name</b>, enter a name for your function.</li> <li>4. In the <b>Runtime</b> dropdown list, choose <b>Python.3.X</b>.</li> <li>5. Expand <b>Change default execution role</b>, and then choose <b>Create a new</b></li> </ol>	Migration engineer



Task	Description	Skills required
	<p><b>role with basic Lambda permissions.</b></p> <ol style="list-style-type: none"><li>6. Choose <b>Create function</b>.</li><li>7. Choose the <b>Code</b> tab, and then paste the <code>S3CopyLambda.py</code> Python code that's provided in the <a href="#">Additional information</a> section. The Python code was generated by using <a href="#">Amazon Q Developer</a> in the Microsoft Visual Studio integrated development environment (IDE).</li><li>8. Edit the <code>destination_bucket_name</code> to the name of the S3 bucket that you created previously, and change <code>destination_file_key</code> to the mainframe file name.</li><li>9. Deploy the Lambda function.</li></ol>	

Task	Description	Skills required
Create an Amazon S3 trigger to invoke the Lambda function.	<p>To configure a trigger that invokes the Lambda function, do the following:</p> <ol style="list-style-type: none"><li>1. On the Lambda console, open the <b>Functions</b> page.</li><li>2. Choose the Lambda function.</li><li>3. In <b>Function overview</b>, choose <b>Add trigger</b>.</li><li>4. In the <b>Trigger configuration</b> dropdown list, choose <b>S3</b>.</li><li>5. In the <b>Bucket</b> field, enter the name of your source bucket.</li><li>6. In the <b>Event type</b> dropdown list, choose <b>All object create events</b>.</li><li>7. Select the <b>I acknowledge that using the same S3 bucket for both input and output is not recommended</b> check box, and then choose <b>Add</b>.</li></ol> <p>For more information, see <a href="#">Tutorial: Using an Amazon S3 trigger to invoke a Lambda function</a>.</p>	Migration lead

Task	Description	Skills required
Provide IAM permissions for the Lambda function.	<p>IAM permissions are required for the Lambda function to access the file-transfer destination and source dataset S3 buckets. Update the policy associated with the Lambda function execution role by allowing <code>s3:GetObject</code> and <code>s3:DeleteObject</code> permissions for the file-transfer destination S3 bucket and <code>s3:PutObject</code> access for the source dataset S3 bucket.</p> <p>For more information, see the <a href="#">Create a permissions policy</a> section in <i>Tutorial: Using an Amazon S3 trigger to invoke a Lambda function</i>.</p>	Migration lead

## Define a mainframe data transfer task

Task	Description	Skills required
Create a transfer task to copy the mainframe file to the S3 bucket.	<p>To create a mainframe file transfer task, follow the instructions in the <a href="#">AWS Mainframe Modernization documentation</a>.</p> <p><b>Note:</b> Specify <b>Source code page</b> encoding as <b>IBM1047</b></p>	Migration engineer

Task	Description	Skills required
	and <b>Target code page</b> encoding as <b>UTF-8</b> .	
Verify the transfer task.	To verify that the data transfer is successful, follow the instructions in the <a href="#">AWS Mainframe Modernization documentation</a> . Confirm that the mainframe file is in the file-transfer destination S3 bucket.	Migration lead
Verify the Lambda copy function.	<p>Verify that the Lambda function is initiated and that the file is copied with a .csv extension to the source dataset S3 bucket.</p> <p>The .csv file created by the Lambda function is the input data file for Amazon QuickSight. For example data, see the Sample-data-member-healthcare-APG file in the <a href="#">Attachments</a> section.</p>	Migration lead

## Connect Amazon QuickSight to the mainframe data

Task	Description	Skills required
Set up Amazon QuickSight.	To set up Amazon QuickSight, follow the instructions in the <a href="#">AWS documentation</a> .	Migration lead

Task	Description	Skills required
Create a dataset for Amazon QuickSight.	To create a dataset for Amazon QuickSight, follow the instructions in the <a href="#">AWS documentation</a> . The input data file is the converted mainframe file that was created when you defined the mainframe data transfer task.	Migration lead

### Get business insights from the mainframe data by using Amazon Q in QuickSight

Task	Description	Skills required
Set up Amazon Q in QuickSight.	<p>This capability requires Enterprise Edition. To set up Amazon Q in QuickSight, do the following:</p> <ol style="list-style-type: none"> <li>1. To get the Amazon Q add-on, follow the instructions Step 1: Get the Q add-on in the <a href="#">AWS documentation</a>.</li> <li>2. To use the generative BI capabilities in Amazon Q, upgrade your users' accounts. Follow the instructions in the <a href="#">AWS documentation</a>.</li> <li>3. Create an Amazon Q topic by using the dataset that you created previously. Follow the instructions in the <a href="#">AWS documentation</a>.</li> </ol>	Migration lead

Task	Description	Skills required
	4. To configure the topic metadata so that it's natural language–friendly, follow the instructions in the <a href="#">AWS documentation</a> .	

Task	Description	Skills required
Analyze mainframe data and build a visual dashboard.	<p>To analyze and visualize your data in Amazon QuickSight, do the following:</p> <ol style="list-style-type: none"><li>1. To create the mainframe data analysis, follow the instructions in the <a href="#">AWS documentation</a>. For the dataset, choose the dataset created in the previous step.</li><li>2. On the analysis page choose <b>Build visual</b>.</li><li>3. In the <b>Create topic for analysis</b> window, choose <b>Update existing topic</b>.</li><li>4. In the <b>Select a topic</b> dropdown list, choose the topic that you created previously.</li><li>5. Choose <b>Topic linking</b>.</li><li>6. After you link the topic, choose <b>Build visual</b> to open the Amazon Q <b>Build a Visual</b> window.</li><li>7. In the prompt bar. write your analysis questions . The example questions used for this pattern are the following:<ul style="list-style-type: none"><li>• Show member distribution by region</li></ul></li></ol>	Migration engineer

Task	Description	Skills required
	<ul style="list-style-type: none"> <li>• Show members distribution by age</li> <li>• Show member distribution by gender</li> <li>• Show member distribution by plan type</li> <li>• Show member not completed preventive immunization</li> </ul> <p>After you enter your questions, choose <b>Build</b>. Amazon Q in QuickSight creates the visuals.</p> <p>8. To add the visuals to your visual dashboard, choose <b>ADD TO ANALYSIS</b>.</p> <p>When you're finished, you can publish your dashboard to share with others in your organization. For examples, see <i>Mainframe visual dashboard</i> in the <a href="#">Additional information</a> section.</p>	

### Create a data story with Amazon Q in QuickSight from the mainframe data

Task	Description	Skills required
Create a data story.	Create a data story to explain insights from the previous	Migration engineer



Task	Description	Skills required
	<p>analysis, and generate a recommendation to increase preventive immunization for members:</p> <ol style="list-style-type: none"><li>1. To create the data story, follow the instructions in the <a href="#">AWS documentation</a>.</li><li>2. For the data story prompt, use the following:  Build a data story about Region with most numbers of members. Also show the member distribution by medical plan, vision plan, dental plan. Recommend how to motivate members to complete immunization. Include 4 points of supporting data for this pattern.  You can also build your own prompt to generate data stories for other business insights.</li><li>3. Choose <b>Add visuals</b>, and add the visuals that are relevant to the data story. For this pattern, use the</li></ol>	

Task	Description	Skills required
	<p>visuals that you created previously.</p> <p>4. Choose <b>Build</b>.</p> <p>5. For example data story output, see <i>Data story output</i> in the <a href="#">Additional information</a> section.</p>	
View the generated data story.	To view the generated data story, follow the instructions in the <a href="#">AWS documentation</a> .	Migration lead
Edit a generated data story.	To change the formatting, layout, or visuals in a data story, follow the instructions in the <a href="#">AWS documentation</a> .	Migration lead
Share a data story.	To share a data story, follow the instructions in the <a href="#">AWS documentation</a> .	Migration engineer

## Troubleshooting

Issue	Solution
Unable to discover the mainframe files or datasets entered in <b>Data sets search criteria</b> for <b>Create transfer task</b> in AWS Mainframe Modernization File Transfer with BMC.	<ol style="list-style-type: none"> <li>1. First, check the connection by choosing <b>Data transfer endpoints</b> on the AWS Mainframe Modernization Transfer with BMC console. If the last heartbeat time is greater than two minutes, the connection for file transfer hasn't been established. If the last heartbeat time is less than 2 minutes for the agent running on the</li> </ol>

Issue	Solution
	<p>mainframe, the connection to the agent is successful. Proceed to step 2.</p> <ol style="list-style-type: none"><li>2. Check the AWS Secrets Manager setup. A secret key must be configured in Secrets Manager with a <b>key</b> of <code>userId</code> (uppercase I) with a <b>value</b> of the mainframe's user ID and a <b>key</b> of <code>password</code> with the <b>value</b> of the mainframe password. The <code>userId</code> and <code>password</code> secret keys are case-sensitive and must be entered as is.</li></ol>

## Related resources

To convert mainframe data types such as [PACKED-DECIMAL \(COMP-3\)](#) or [BINARY \(COMP or COMP-4\)](#) to a [data type](#) supported by Amazon QuickSight, see the following patterns:

- [Convert and unpack EBCDIC data to ASCII on AWS by using Python](#)
- [Convert mainframe files from EBCDIC format to character-delimited ASCII format in Amazon S3 using AWS Lambda](#)

## Additional information

### S3CopyLambda.py

The following Python code was generated by using a prompt with Amazon Q Developer in an IDE:

```
#Create a lambda function triggered by S3. display the S3 bucket name and key
import boto3
s3 = boto3.client('s3')
def lambda_handler(event, context):
    print(event)
    bucket = event['Records'][0]['s3']['bucket']['name']
    key = event['Records'][0]['s3']['object']['key']
    print(bucket, key)
    #If key starts with object_created, skip copy, print "copy skipped". Return lambda with
    key value.
```

```
if key.startswith('object_created'):
    print("copy skipped")
    return {
        'statusCode': 200,
        'body': key
    }
# Copy the file from the source bucket to the destination bucket.
Destination_bucket_name = 'm2-filetransfer-final-opt-bkt'. Destination_file_key =
'healthdata.csv'
copy_source = {'Bucket': bucket, 'Key': key}
s3.copy_object(Bucket='m2-filetransfer-final-opt-bkt', Key='healthdata.csv',
    CopySource=copy_source)
print("file copied")
#Delete the file from the source bucket.
s3.delete_object(Bucket=bucket, Key=key)
return {
    'statusCode': 200,
    'body': 'Copy Successful'
}
```

## Mainframe visual dashboard

The following data visual was created by Amazon Q in QuickSight for the analysis question show member distribution by region.

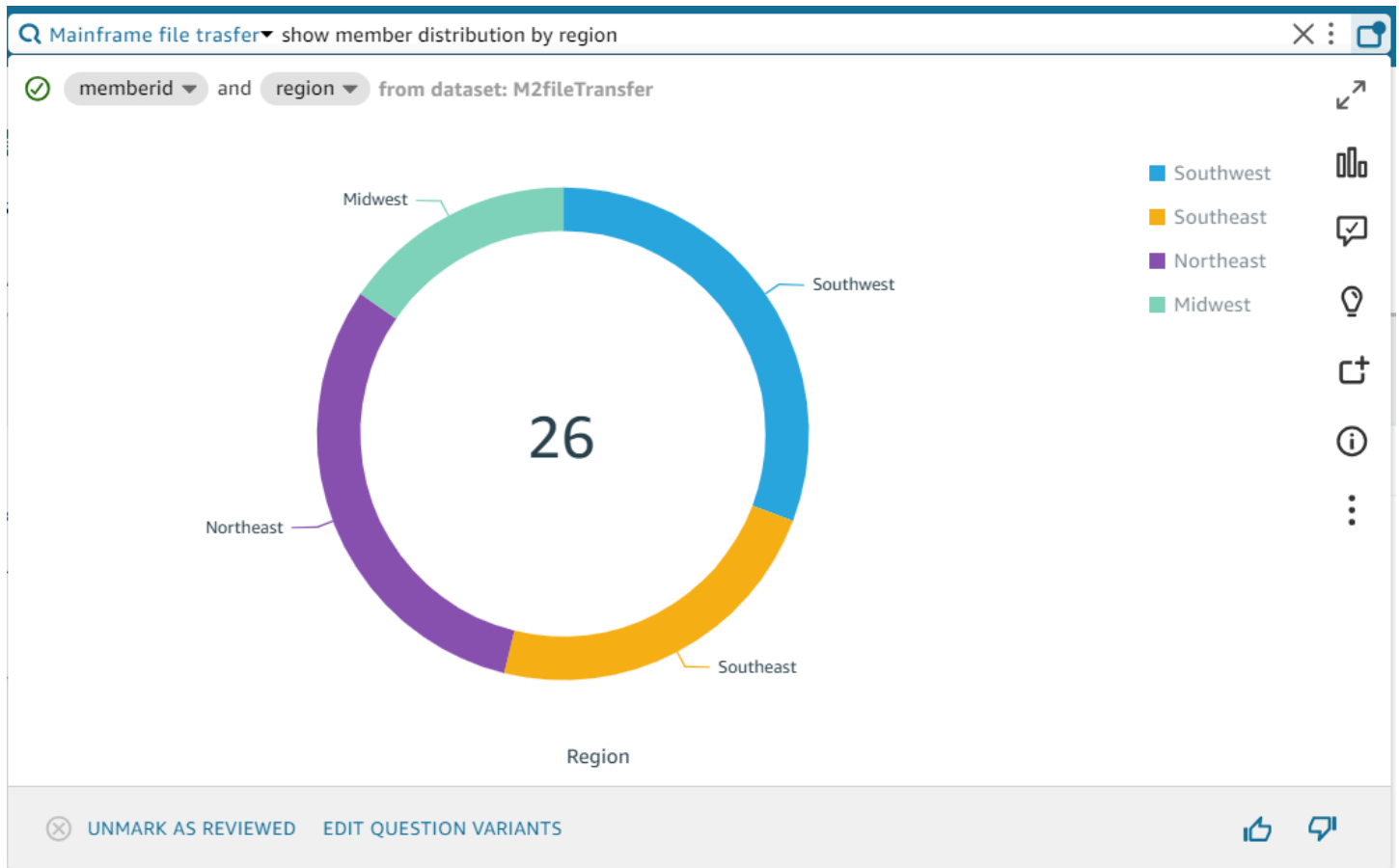

The following data visual was created by Amazon Q in QuickSight for the question show member distribution by Region who have not completed preventive immunization, in pie chart.

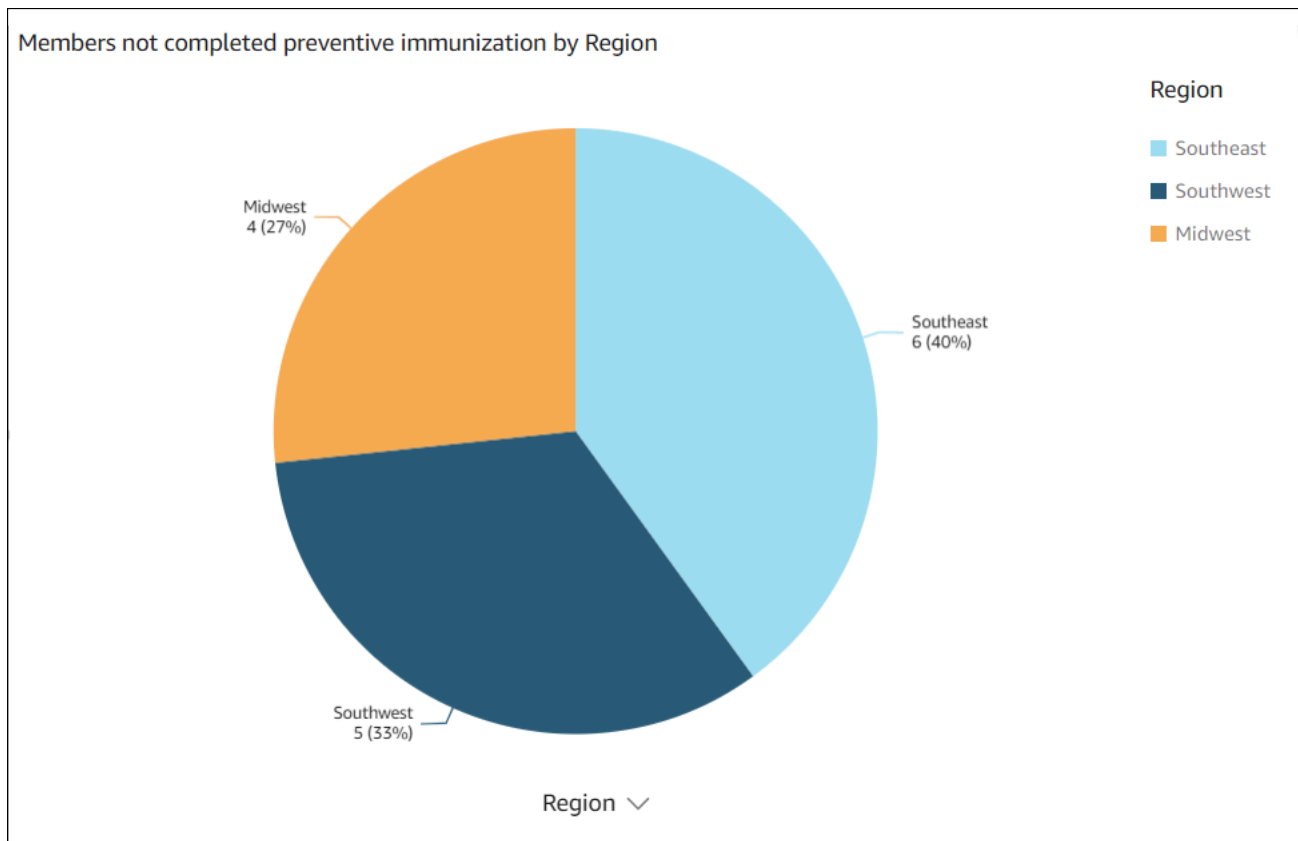

## Data story output

The following screenshots show sections of the data story created by Amazon Q in QuickSight for the prompt Build a data story about Region with most numbers of members. Also show the member distribution by medical plan, vision plan, dental plan. Recommend how to motivate members to complete immunization. Include 4 points of supporting data.

In the introduction, the data story recommends choosing the region with the most members to gain the greatest impact from immunization efforts.

QuickSight | Leveraging Data to Strengthen Community Health: ...

BACK TO EDITOR | SHARE

# Leveraging Data to Strengthen Community Health: A Story of Immunization Rates

Prepared by [Name]

## Introduction

This presentation will focus on immunization completion rates among members of one health insurance provider. Understanding differences in rates across various regions served and demographic groups can point to areas that would most benefit from targeted efforts to increase immunizations. With insights drawn from member data, recommendations will be suggested for improving collaboration with at-risk communities.

## Member Distribution by Region

The data story provides an analysis of member numbers for the top three regions, and names the Southwest as the leading region for focusing on immunization efforts.

QuickSight | Increasing Immunization Rates: A Data-Driven Appr...

SCROLLABLE PAGE | Publish Changes | BACK TO EDITOR | SHARE

## Region with Most Members

Region	Number of Members	Percentage
Southwest	8	31%
Northeast	8	31%
Southeast	6	23%
Midwest	4	15%
<b>Total</b>	<b>26</b>	<b>100%</b>

According to the graph, the Southwest region has the highest number of enrolled members at 8. This is followed closely by the Northeast region also with 8 members. The Southeast region comes in third for total enrollment with 6 members. Given that the objective is to identify the region with the highest number of enrolled members, and based on the data insights from the graph showing the Southwest region in the lead, the Southwest region currently has the most health plan members enrolled of any region.

**Note:** The Southwest and Northeast regions each have eight members. However, the Southwest has more members that aren't fully vaccinated, so it has more potential to benefit from initiatives to increase immunization rates.

## Attachments

To access additional content that is associated with this document, unzip the following file:

[attachment.zip](#)



# Integrate Stonebranch Universal Controller with AWS Mainframe Modernization

Created by Vaidy Sankaran (AWS), Robert Lemieux (Stonebranch), Huseyin Gomleksizoglu (Stonebranch), and Pablo Alonso Prieto (AWS)

<b>Code repository:</b> <a href="#">aws-mainframe-modernization-stonebranch-integration</a>	<b>Environment:</b> PoC or pilot	<b>Technologies:</b> Mainframe ; DevOps; Modernization; Operations; SaaS
<b>Workload:</b> Open-source; Microsoft	<b>AWS services:</b> AWS Mainframe Modernization; Amazon RDS; Amazon S3	

## Summary

This pattern explains how to integrate [Stonebranch Universal Automation Center \(UAC\) workload orchestration](#) with [Amazon Web Services \(AWS\) Mainframe Modernization service](#). AWS Mainframe Modernization service migrates and modernizes mainframe applications to the AWS Cloud. It offers two patterns: [AWS Mainframe Modernization Replatform](#) with Micro Focus Enterprise Technology and [AWS Mainframe Modernization Automated Refactor](#) with AWS Blu Age.

Stonebranch UAC is a real-time IT automation and orchestration platform. UAC is designed to automate and orchestrate jobs, activities, and workflows across hybrid IT systems, from on-premises to AWS. Enterprise clients using mainframe systems are transitioning to cloud-centric modernized infrastructures and applications. Stonebranch's tools and professional services facilitate the migration of existing schedulers and automation capabilities to the AWS Cloud.

When you migrate or modernize your mainframe programs to the AWS Cloud using AWS Mainframe Modernization service, you can use this integration to automate batch scheduling, increase agility, improve maintenance, and decrease costs.

This pattern provides instructions for integrating [Stonebranch scheduler](#) with mainframe applications migrated to the [AWS Mainframe Modernization service Micro Focus Enterprise runtime](#). This pattern is for solutions architects, developers, consultants, migration specialists, and others working in migrations, modernizations, operations, or DevOps.

## Targeted outcome

This pattern focuses on providing the following target outcomes:

- The ability to schedule, automate, and run mainframe batch jobs running in [AWS Mainframe Modernization service \(Microfocus runtime\)](#) from [Stonebranch Universal Controller](#).
- Monitor the application's batch processes from the Stonebranch Universal Controller.
- Start/Restart/Rerun/Stop batch processes automatically or manually from the Stonebranch Universal Controller.
- Retrieve the results of the AWS Mainframe Modernization batch processes.
- Capture the [AWS CloudWatch](#) logs of the batch jobs in Stonebranch Universal Controller.

## Prerequisites and limitations

### Prerequisites

- An active AWS account
- A Micro Focus [Bankdemo](#) application with job control language (JCL) files, and a batch process deployed in a [AWS Mainframe Modernization service \(Micro Focus runtime\)](#) environment
- Basic knowledge of how to build and deploy a mainframe application that runs on Micro Focus [Enterprise Server](#)
- Basic knowledge of [Stonebranch Universal Controller](#)
- Stonebranch trial license (contact [Stonebranch](#))
- Windows or Linux Amazon Elastic Compute Cloud (Amazon EC2) instances (for example, xlarge) with a minimum of four cores, 8 GB memory, and 2 GB disk space
- Apache Tomcat version 8.5.x or 9.0.x
- Oracle Java Runtime Environment (JRE) or OpenJDK version 8 or 11
- [Amazon Aurora MySQL–Compatible Edition](#)
- [Amazon Simple Storage Service \(Amazon S3\)](#) bucket for export repository
- [Amazon Elastic File System \(Amazon EFS\)](#) for agent Stonebranch Universal Message Service (OMS) connections for high availability (HA)
- Stonebranch Universal Controller 7.2 Universal Agent 7.2 Installation Files
- AWS Mainframe Modernization [task scheduling template](#) (latest released version of the .zip file)

## Limitations

- The product and solution has been tested and compatibility validated only with OpenJDK 8 and 11.
- The [aws-mainframe-modernization-stonebranch-integration](#) task scheduling template will work only with AWS Mainframe Modernization service.
- This task scheduling template will work on only a Unix, Linux, or Windows edition of Stonebranch agents.

## Architecture

### Target state architecture

The following diagram shows the example AWS environment that is required for this pilot.

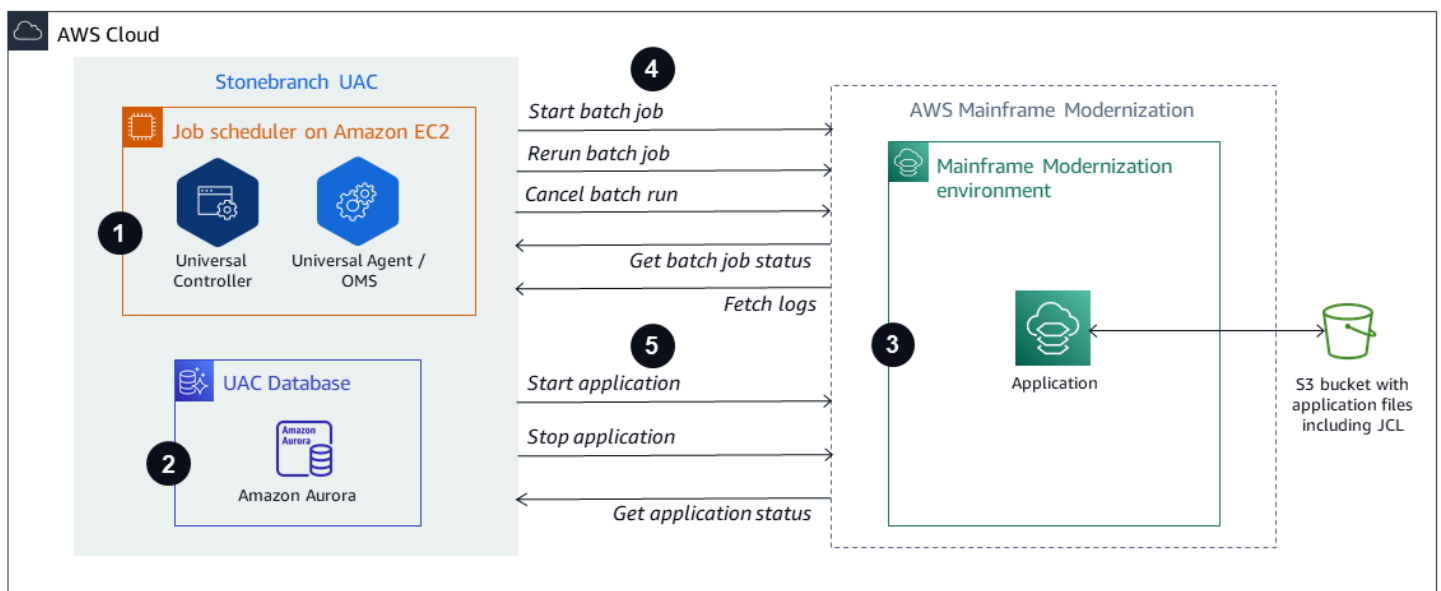

1. Stonebranch Universal Automation Center (UAC) includes two main components: Universal Controller and Universal Agents. Stonebranch OMS is used as a message bus between the controller and individual agents.
2. Stonebranch UAC Database is used by Universal Controller. The database can be MySQL, Microsoft SQL Server, Oracle, or Aurora MySQL–Compatible.
3. AWS Mainframe Modernization service – Micro Focus runtime environment with the [BankDemo application deployed](#). The BankDemo application files will be stored in an S3 bucket. This bucket also contains the mainframe JCL files.

4. Stonebranch UAC can run the following functions for the batch run:
  - a. Start a batch job using the JCL file name that exists in the S3 bucket linked to the AWS mainframe modernization service.
  - b. Get the status of the batch job run.
  - c. Wait until the batch job run is completed.
  - d. Fetch logs of the batch job run.
  - e. Rerun the failed batch jobs.
  - f. Cancel the batch job while the job is running.
5. Stonebranch UAC can run the following functions for the application:
  - a. Start Application
  - b. Get Status of the Application
  - c. Wait until the Application is started or stopped
  - d. Stop Application
  - e. Fetch Logs of Application operation

### **Stonebranch jobs conversion**

The following diagram represents Stonebranch's job conversion process during the modernization journey. It describes how the job schedules and tasks definitions are converted into a compatible format that can run AWS Mainframe Modernization batch tasks.

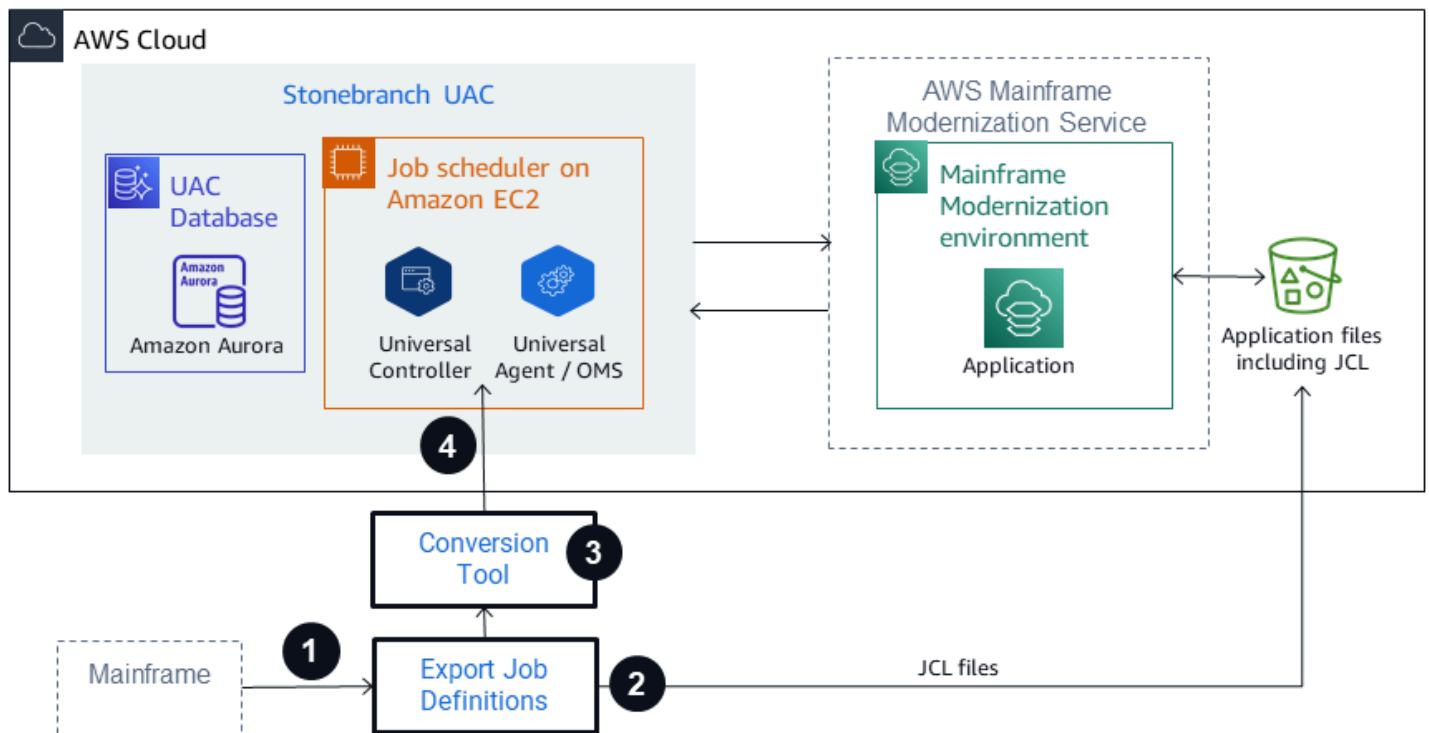

1. For the conversion process, the job definitions are exported from the existing mainframe system.
2. JCL files can be uploaded to the S3 bucket for the Mainframe Modernization application so that these JCL files can be deployed by the AWS Mainframe Modernization service.
3. The conversion tool converts the exported job definitions to UAC tasks.
4. After all the task definitions and job schedules are created, these objects will be imported to the Universal Controller. The converted tasks then run the processes in the AWS Mainframe Modernization service instead of running them on the mainframe.

## Stonebranch UAC architecture

The following architecture diagram represents an active-active-passive model of high availability (HA) Universal Controller. Stonebranch UAC is deployed in multiple Availability Zones to provide high availability and support disaster recovery (DR).

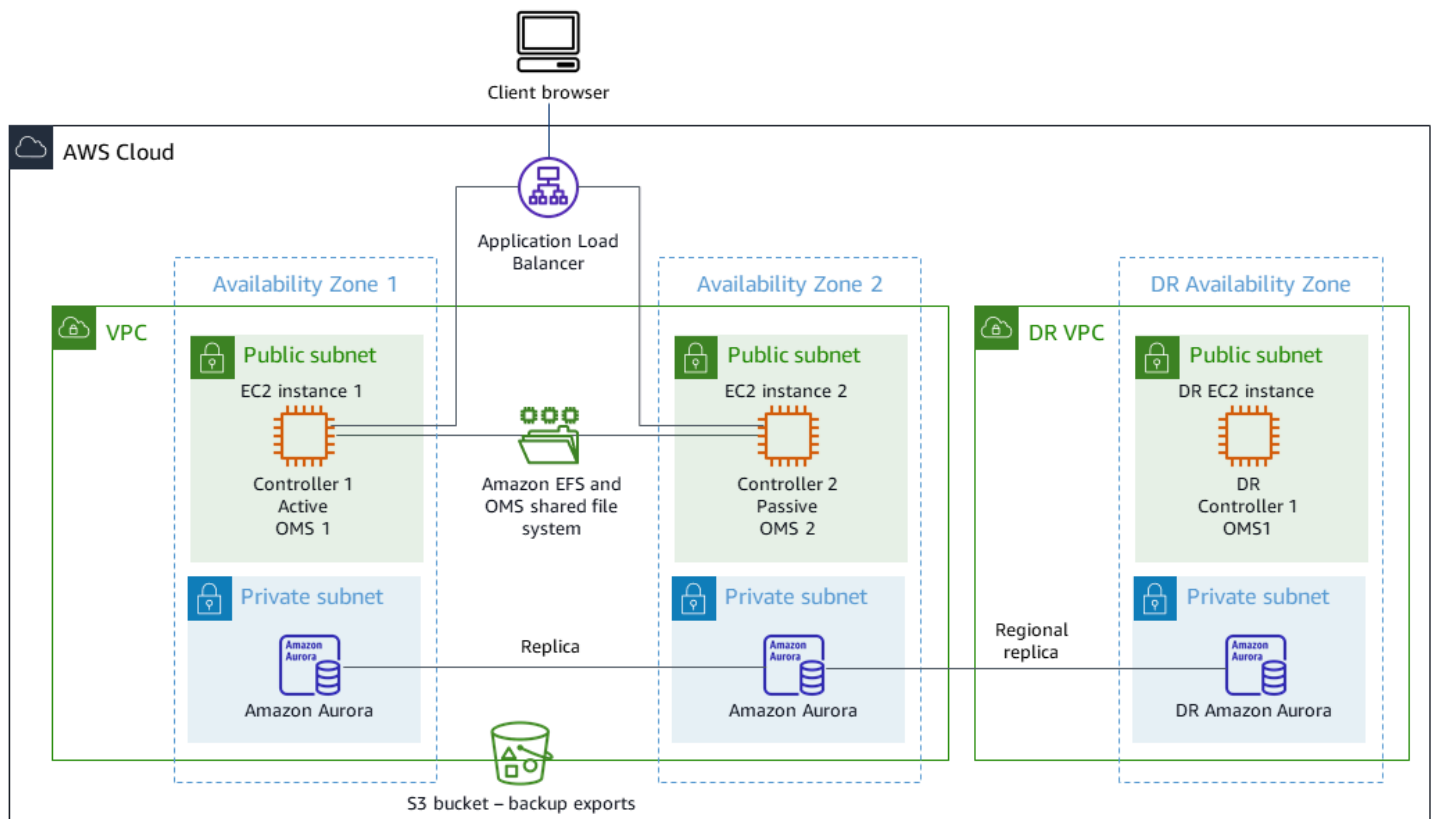

## Universal Controller

Two Linux servers are provisioned as Universal Controllers. Both connect to the same database endpoint. Each server houses a Universal Controller application and OMS. The most recent version of Universal Controller is used at the time it is provisioned.

The Universal Controllers are deployed in the Tomcat webapp as the document ROOT and are served on port 80. This deployment eases the configuration of the frontend load balancer.

HTTP over TLS or HTTPS is enabled using the Stonebranch wildcard certificate (for example, <https://customer.stonebranch.cloud>). This secures communication between the browser and the application.

## OMS

A Universal Agent and OMS (Opwise Message Service) reside on each Universal Controller server. All deployed Universal Agents from the customer end are set up to connect to both OMS services. OMS acts as a common messaging service between the Universal Agents and the Universal Controller.

Amazon EFS mounts a spool directory on each server. OMS uses this shared spool directory to keep the connection and task information from controllers and agents. OMS works in a high-availability mode. If the active OMS goes down, the passive OMS has access to all the data, and it resumes active operations automatically. Universal Agents detect this change and automatically connect to the new active OMS.

### *Database*

Amazon Relational Database Service (Amazon RDS) houses the UAC database, with Amazon Aurora MySQL–Compatible as its engine. Amazon RDS helps in managing and offering scheduled backups at regular intervals. Both Universal Controller instances connect to the same database endpoint.

### *Load balancer*

An Application Load Balancer is set-up for each instance. The load balancer directs traffic to the active controller at any given moment. Your instance domain names point to the respective load balancer endpoints.

### *URLs*

Each of your instances has a URL, as shown in the following example.

<b>Environment</b>	<b>Instance</b>
<b>Production</b>	<a href="https://customer.stonebranch.cloud">customer.stonebranch.cloud</a>
<b>Development (non-production)</b>	<a href="https://customerdev.stonebranch.cloud">customerdev.stonebranch.cloud</a>
<b>Testing (non-production)</b>	<a href="https://customertest.stonebranch.cloud">customertest.stonebranch.cloud</a>

**Note:** Non-production instance names can be set based on your needs.

### *High availability*

High availability (HA) is the ability of a system to operate continuously without failure for a designated period of time. Such failures include, but are not limited to, storage, server communication response delays caused by CPU or memory issues, and networking connectivity.

To meet HA requirements:

- All EC2 instances, databases, and other configurations are mirrored across two separate Availability Zones within the same AWS Region.
- The controller is provisioned through an Amazon Machine Image (AMI) on two Linux servers in the two Availability Zones. For example, if you are provisioned in the Europe eu-west-1 Region, you have a Universal Controller in Availability Zone eu-west-1a and Availability Zone eu-west-1c.
- No jobs are allowed to run directly on the application servers and no data is allowed to be stored on these servers.
- The Application Load Balancer runs health checks on each Universal Controller to identify the active one and direct traffic to it. In the event that one server incurs issues, the load balancer automatically promotes the passive Universal Controller to an active state. The load balancer then identifies the new active Universal Controller instance from the health checks and starts directing traffic. The failover happens within four minutes with no job loss, and the frontend URL remains the same.
- The Aurora MySQL–Compatible database service stores Universal Controller data. For production environments, a database cluster is built with two database instances in two different Availability Zones within a single AWS Region. Both Universal Controllers use a Java Database Connectivity (JDBC) interface that points to a single database cluster endpoint. In the event that one database instance incurs issues, the database cluster endpoint dynamically points to the healthy instance. No manual intervention is required.

### *Backup and purge*

Stonebranch Universal Controller is set to back up and purge old data following the schedule shown in the table.

<b>Type</b>	<b>Schedule</b>
<b>Activity</b>	7 days
<b>Audit</b>	90 days
<b>History</b>	60 days

Backup data older than the dates shown is exported to .xml format and stored in the file system. After the backup process is complete, older data is purged from the database and archived in an S3 bucket for up to one year for production instances.



You can adjust this schedule in your Universal Controller interface. However, increasing these time-frames might cause a longer downtime during maintenance.

## Tools

### AWS services

- [AWS Mainframe Modernization](#) is an AWS cloud-native platform that helps you modernize your mainframe applications to AWS managed runtime environments. It provides tools and resources to help you plan and implement migration and modernization.
- [Amazon Elastic Block Store \(Amazon EBS\)](#) provides block-level storage volumes for use with Amazon EC2 instances.
- [Amazon Elastic File System \(Amazon EFS\)](#) helps you create and configure shared file systems in the AWS Cloud.
- [Amazon Relational Database Service \(Amazon RDS\)](#) helps you set up, operate, and scale a relational database in the AWS Cloud. This pattern uses Amazon Aurora MySQL-Compatible Edition.
- [Amazon Simple Storage Service \(Amazon S3\)](#) is a cloud-based object storage service that helps you store, protect, and retrieve any amount of data.
- [Elastic Load Balancing \(ELB\)](#) distributes incoming application or network traffic across multiple targets. For example, you can distribute traffic across Amazon EC2 instances, containers, and IP addresses in one or more Availability Zones. This pattern uses an Application Load Balancer.

### Stonebranch

- [Universal Automation Center \(UAC\)](#) is a system of enterprise workload automation products. This pattern uses the following UAC components:
  - [Universal Controller](#), a Java web application running in a Tomcat web container, is the enterprise job scheduler and workload automation broker solution of [Universal Automation Center](#). The Controller presents a user interface for creating, monitoring, and configuring Controller information; handles the scheduling logic; processes all messages to and from [Universal Agents](#); and synchronizes much of the [high availability](#) operation of Universal Automation Center.
  - [Universal Agent](#) is a vendor-independent scheduling agent that collaborates with existing job scheduler on all major computing platforms, both legacy and distributed. All schedulers that run on z/Series, i/Series, Unix, Linux, or Windows are supported.

- [Universal Agent](#) is a vendor-independent scheduling agent that collaborates with existing job scheduler on all major computing platforms, both legacy and distributed. All schedulers that run on z/Series, i/Series, Unix, Linux, or Windows are supported.
- [Stonebranch aws-mainframe-modernization-stonebranch-integration AWS Mainframe Modernization Universal Extension](#) is the integration template to run, monitor and rerun batch jobs in AWS Mainframe Modernization platform.

## Code

The code for this pattern is available in the [aws-mainframe-modernization-stonebranch-integration](#) GitHub repository.

## Epics

### Install Universal Controller and Universal Agent on Amazon EC2

Task	Description	Skills required
Download the installation files.	Download the installation from Stonebranch servers. To get the installation files, contact with Stonebranch.	Cloud architect
Launch the EC2 instance.	You will need about 3 GB of extra space for the Universal Controller and Universal Agent installations. So provide at least 30 GB of disk space for the instance.  Add port 8080 to the security group so that it's accessible.	Cloud architect
Check prerequisites.	Before the installation, do the following:	Cloud administrator, Linux administrator

Task	Description	Skills required
	<ol style="list-style-type: none"><li data-bbox="592 212 1031 982">1. Install Java as described in <a href="#">Downloading Java Runtime Environment</a>. <pre data-bbox="630 380 1031 575">\$ sudo yum -y update \$ sudo yum install   java-11-amazon-cor   retto</pre><p data-bbox="630 617 1031 982">Be sure to use one of the supported JAVA versions. The previous command should install java-11. Check the Java version and be sure you are using version 11 before continuing.</p></li><li data-bbox="592 1010 1031 1184">2. As described in <a href="#">Installing Apache Tomcat</a> document, run the following commands. <pre data-bbox="630 1220 1031 1541">\$ sudo yum install   tomcat tomcat-admin-   webapps \$ sudo systemctl   enable tomcat \$ sudo systemctl start   tomcat</pre></li><li data-bbox="592 1556 1031 1877">3. Create an Amazon Aurora database as described in <a href="#">Creating an Aurora MySQL DB cluster and connecting to it</a>. Use Amazon Aurora MySQL-Compatible Edition.</li></ol>	

Task	Description	Skills required
	Choose a Master username and Master password. Keep the default values for the rest of the settings.	

Task	Description	Skills required
Install Universal Controller.	<ol style="list-style-type: none"><li data-bbox="591 226 1024 407">1. Upload the <code>universal-controller-7.2.0.0.tar</code> installation file to the EC2 instance.</li><li data-bbox="591 428 1024 512">2. Unarchive the installation files to a temp folder. <pre data-bbox="634 548 1029 705">\$ tar -xvf universal-controller-7.2.0.0.tar</pre></li><li data-bbox="591 722 1024 806">3. Give the installation script run permission. <pre data-bbox="634 842 1029 957">\$ chmod a+x install-controller.sh</pre></li><li data-bbox="591 974 1024 1394">4. Install the controller. This example uses the following command to install Universal Controller under <code>/usr/share/tomcat</code>. Use the Amazon Aurora database that you created in the previous steps. <pre data-bbox="634 1430 1029 1843">\$ sudo ./install-controller.sh --tomcat-dir /usr/share/tomcat/ --controller-file universal-controller-7.2.0.0-build.145.war --dbuser admin --dbpass "*****" --dbname uc --rdbms mysql --dburl</pre></li></ol>	Cloud architect, Linux administrator

Task	Description	Skills required
	<pre data-bbox="634 205 1027 426">jdbc:mysql://database-2-instance-1.ci63miincgy.us-east-1.rds.amazonaws.com:3306/</pre> <p data-bbox="630 464 1011 594">The last line of the output of the script should be "Installation complete."</p> <p data-bbox="592 615 1000 695">5. Navigate to the following URL in the EC2 instance.</p> <pre data-bbox="634 737 1027 852">http://&lt;public_ip&gt;:8080/uc</pre> <p data-bbox="592 871 980 1098">6. On the login screen, enter <b>ops.admin</b> in the <b>Username</b> section, and keep the <b>Password</b> field empty.</p> <p data-bbox="592 1119 1024 1199">7. Set a new password for the <code>ops.admin</code> user.</p>	

Task	Description	Skills required
Install Universal Agent.	<ol style="list-style-type: none"><li data-bbox="594 226 1026 407">1. Upload the <code>sb-7.2.0.1-linux-3.10-x86_64.tar.Z</code> installation file to the EC2 instance.</li><li data-bbox="594 428 1016 462">2. Log in to the EC2 instance.</li><li data-bbox="594 483 1026 571">3. Unarchive the Universal Agent installation package. <pre data-bbox="646 609 1026 764">\$ zcat sb-7.2.0.1-linux-3.10-x86_64.tar.Z   tar xvf -</pre></li><li data-bbox="594 785 1026 873">4. Run the following command. <pre data-bbox="646 903 1026 1138">\$ sudo ./unvinst --oms_servers 7878@localhost --oms_automstart yes --python yes</pre></li><li data-bbox="594 1159 1026 1192">5. Create a PAM file. <pre data-bbox="646 1230 1026 1344">\$ cp /etc/pam.d/login /etc/pam.d/ucmd</pre></li><li data-bbox="594 1365 1026 1453">6. Enable Autostart for Universal Agent. <pre data-bbox="646 1482 1026 1638">\$ /sbin/restorecon -v /etc/rc.d/init.d/ubrokerd</pre></li></ol>	Cloud administrator, Linux administrator

Task	Description	Skills required
Add OMS to Universal Controller.	<ol style="list-style-type: none"> <li>1. Log in to Universal Controller with the <code>ops.admin</code> user.</li> <li>2. Choose the <b>Services</b> menu at the top left corner of the screen, and then choose the <b>OMS Servers</b> menu in the <b>System</b></li> <li>3. In the OMS Server Address field, type <a href="#">localhost</a>, and then save.</li> <li>4. You will see the status of the OMS server as <b>Connected</b> and the <b>Session Status</b> as <b>Operational</b>.</li> </ol>	Universal Controller administrator

### Import AWS Mainframe Modernization Universal Extension and create a task

Task	Description	Skills required
Import Integration Template.	<p>For this step, you need the <a href="#">AWS Mainframe Modernization Universal Extension</a>. Ensure the latest released version of the .zip file is downloaded.</p> <ol style="list-style-type: none"> <li>1. Log in to the Universal Controller with the <code>ops.admin</code> user.</li> </ol>	Universal Controller administrator



Task	Description	Skills required
	<ol style="list-style-type: none"><li data-bbox="591 212 938 342">2. Navigate to <b>Services</b>, <b>Import Integration Template</b>.</li><li data-bbox="591 365 1013 638">3. Select the Integration Template .zip file (aws_mainframe_modernization_stonebranch_extension.zip ), and choose <b>Import</b>.</li></ol> <p data-bbox="591 716 997 940">After the Integration Template is imported, you will see <b>AWS Mainframe Modernization Tasks</b> under <b>Available Services</b>.</p>	

Task	Description	Skills required
Enable resolvable credentials.	<ol style="list-style-type: none"> <li>Navigate to <b>Services, AWS Mainframe Modernization Tasks</b>.</li> <li>On the right panel, fill in the required fields: <ul style="list-style-type: none"> <li><b>Name:</b> New Mainframe Modernization Task</li> <li><b>Agent:</b> Select the only agent (AGNT0001).</li> </ul> <p>Under <b>AWS Mainframe Modernization Details:</b></p> <ul style="list-style-type: none"> <li><b>Action:</b> List Environments</li> <li><b>AWS Credentials:</b> If you have an AWS Identity and Access Management (IAM) role added to the EC2 instance, you can keep this field empty. If you will use <code>AWSAccessKeyID</code> and <code>AWSSecretKey</code>, choose the icon <b>( )</b> next to the field.</li> </ul> <p>In the <b>Credential Details</b> window that opens, enter the following information and then save.</p> <ul style="list-style-type: none"> <li><b>Name:</b> AWS Mainframe Modernization Credentials</li> </ul> </li> </ol>	Universal Controller administrator

Task	Description	Skills required
	<ul style="list-style-type: none"><li>• <b>Runtime User:</b> Write the AWS access key ID in this field.</li><li>• <b>Runtime Password:</b> Write the AWS secret key in this field.</li><li>• <b>End Point:</b> Be sure that the endpoint has the correct AWS Region. The default is <a href="https://m2.us-east-1.amazonaws.com">https://m2.us-east-1.amazonaws.com</a>.</li><li>• <b>Region:</b> Enter the Region of the AWS Mainframe Modernization service. The default is us-east-1 .</li></ul> <p>3. Keep the default values in the rest of the fields, and save the task.</p>	

Task	Description	Skills required
Launch the task.	<ol style="list-style-type: none"><li>1. At the top of the right panel, choose <b>Launch Task</b>.</li><li>2. In the <b>Confirm</b> window, choose <b>Launch</b>. After that, the Universal Controller Console will display a message similar to the following message.  <i>2022-08-24 10:11:49 AM</i>  <i>Successfully launched the Universal task "New Mainframe Modernization Task" with task instance sys_id 1661291493634146313NC8E38DB8OZJY.</i></li><li>3. Navigate to the <b>Instances</b> If you don't see the <b>Instances</b> tab, choose the right arrow to scroll right.</li><li>4. Open the context (right-click) menu for the task instance in the list, choose <b>Retrieve Output</b>, and then choose <b>Submit</b> in the <b>Retrieve Output</b></li><li>5. In the <b>Retrieve Output</b> window, you will see the list of environments in STDOUT.</li></ol>	Universal Controller administrator

## Test starting a batch job

Task	Description	Skills required
<p>Create a task for the batch job.</p>	<ol style="list-style-type: none"> <li>Navigate to <b>Services, AWS Mainframe Modernization Tasks</b>.</li> <li>On the right panel, fill in the required fields: <ul style="list-style-type: none"> <li><b>Name:</b> New Mainframe Modernization Task</li> <li><b>Agent:</b> Select the only agent (AGNT0001).</li> </ul> <p>Under <b>AWS Mainframe Modernization Details:</b></p> <ul style="list-style-type: none"> <li><b>Action:</b> Start Batch (or Start Batch and Wait to run the batch job and wait until the task completes in AWS)</li> <li><b>AWS Credentials:</b> If you have an IAM role added to the EC2 instance, you can keep this field empty. If you will use <code>AWSAccessKeyId</code> and <code>AWSSecretKey</code>, choose the icon <b>()</b> next to the field.</li> <li><b>End Point:</b> Be sure that the endpoint has the correct AWS Region. The default is <a href="https://m2.us-east-1.amazonaws.com">https://m2.us-east-1.amazonaws.com</a>.</li> </ul> </li> </ol>	<p>Universal Controller administrator</p>

Task	Description	Skills required
	<ul style="list-style-type: none"><li>• <b>Region:</b> Enter the Region of the AWS Mainframe Modernization service. The default is us-east-1 .</li><li>• <b>Application:</b> Choose the icon next to the field (<b> </b>), and choose <b>Submit</b> in the <b>Refresh Application Choices</b>. This will connect to the AWS Mainframe Modernization service and return the list of applications. Now you can select the application from the dropdown list. Select the application you want to run the batch job.</li><li>• <b>JCL File Name:</b> RUNHELLO.jcl</li><li>• <b>Wait for Success or Failure:</b> If this option is selected, the task will wait until the status of the batch job is success or failure.</li><li>• <b>Polling Interval:</b> This is the amount of time between each polling.</li><li>• <b>Fetch Execution Logs:</b> If selected, logs will be fetched automatically</li></ul>	

Task	Description	Skills required
	<p>when the batch job has completed.</p> <ul style="list-style-type: none"><li>• <b>Log Format:</b> This is the format of the logs to be printed out. It can be Text or JSON format.</li></ul> <p>3. Keep the default values in the rest of the fields, and save the task.</p>	

Task	Description	Skills required
Launch the task.	<ol style="list-style-type: none"><li>1. At the top of the right panel, choose <b>Launch Task</b>.</li><li>2. In the <b>Confirm</b> window, choose <b>Launch</b>. After that, the Universal Controller Console will display a message similar to the following message.  <i>2022-08-24 11:11:59 AM</i>  <i>Successfully launched the Universal task "Mainframe Modernization Start Batch" with task instance sys_id &lt;sys id&gt;.</i></li><li>3. Navigate to the <b>Instances</b> If you don't see the <b>Instances</b> tab, choose the right arrow to scroll right.</li><li>4. Open the context (right-click) menu for the task instance in the list, choose <b>Retrieve Output</b>, and then choose <b>Submit</b> in the <b>Retrieve Output</b></li><li>5. In the <b>Retrieve Output</b> window, you will see the list of environments in STDOUT.</li></ol>	Universal Controller administrator



## Create a workflow for multiple tasks

Task	Description	Skills required
Copy the tasks.	<ol style="list-style-type: none"> <li>1. Open the context (right click) menu for the task that you want to create copies of, and choose <b>Copy</b>.</li> <li>2. In the <b>Copy AWS Mainframe Modernization Task</b> window enter the following new name for the new task: Mainframe Modernization Start Batch - <i>RUNAWS2</i>.</li> <li>3. Copy the task again, using the following name: Mainframe Modernization Start Batch - <i>RUNAWS3</i>.</li> <li>4. Copy with the task again, using the following name: Mainframe Modernization Start Batch - <i>RUNAWS4</i>.</li> <li>5. Copy the task a final time, using the following name: Mainframe Modernization Start Batch - <i>FOOBAR</i>.</li> </ol>	Universal Controller administrator
Update tasks.	<ol style="list-style-type: none"> <li>1. Open (double-click) the Mainframe Modernization Start Batch - <i>RUNAWS2</i> task, change the <b>JCL File Name</b> field to <i>RUNAWS2.jcl</i> , and save.</li> <li>2. Open (double-click) the Mainframe Modernization</li> </ol>	Universal Controller administrator

Task	Description	Skills required
	<p>Start Batch - RUNAWS3 task, change the <b>JCL File Name</b> field to RUNAWS3.jc1 , and save.</p> <p>3. Open (double-click) the Mainframe Modernization Start Batch - RUNAWS4 task, change the <b>JCL File Name</b> field to RUNAWS4.jc1 , and save.</p> <p>4. Open (double-click) the Mainframe Modernization Start Batch - FOOBAR task, change the <b>JCL File Name</b> field to MISSING.jc1 , and save. <b>This task will fail because the JCL File Name value is incorrect.</b></p>	

Task	Description	Skills required
Create a workflow.	<ol style="list-style-type: none"><li>1. Navigate to <b>Services, Workflows</b>.</li><li>2. On the right panel, enter <b>Mainframe Modernization Workflow</b> in the <b>Name</b> field, and save.</li><li>3. In the right panel, choose <b>Edit Workflow</b>.</li><li>4. On the <b>Workflow Editor Tab</b>, the <b>Add Task</b> button <b>(+)</b>.</li><li>5. In the <b>Task Find</b> window, choose <b>Search</b> to see all the tasks in the Universal Controller.</li><li>6. Click the icon next to <b>Mainframe Modernization Start Batch Task</b>, and drag the icon into an empty place in the <b>Workflow Editor</b>.</li><li>7. Repeat the same action for the other <b>Mainframe Modernization</b> tasks and place them as shown in the <i>Additional information</i> section.</li><li>8. Choose the <b>Connect</b> button <b>( )</b>, and connect the tasks together. To connect a task with another, click in the middle of a task, and drag it to the target task.</li></ol>	Universal Controller administrator

Task	Description	Skills required
	<p>9. Connect the tasks as shown in the <i>Additional information</i> section, and save the workflow.</p> <p>10 Right-click an empty place in the Workflow Editor, choose <b>Launch Workflow</b>, and then choose <b>OK</b>.</p>	
<p>Check the status of the workflow.</p>	<ol style="list-style-type: none"> <li>1. On the left menu, choose the <b>Activity</b></li> <li>2. In the middle of the window, choose <b>Start</b>.  You will see the list of task instances in the list.</li> <li>3. Open (double-click) Mainframe Modernization Workflow in the list, or open the context (right-click) menu and choose <b>Workflow Task Commands, View Workflow</b>.  You will see the tasks as shown in the Additional information section. The second task was expected to fail because you used a missing JCL file.</li> </ol>	<p>Univeral Controller administrator</p>

## Troubleshoot failed batch jobs and rerun

Task	Description	Skills required
Fix the failed task and rerun.	<ol style="list-style-type: none"><li>1. Open (double-click) the failed task to see the error for the task.</li><li>2. You have two options for fixing the failed task.<ul style="list-style-type: none"><li>• Fix the JCL file name, and set it to <code>FOOBAR.jcl</code>.</li><li>• Add the correct JCL file name to the <b>JCL File Name (Temp)</b>. This field will overwrite the <b>JCL File Name</b> field.</li></ul><p>For this pilot, choose the second option, and save the task instance.</p></li><li>3. In the <b>Workflow Monitor</b>, open the context (right-click) menu for the failed task, and choose <b>Commands, Re-run</b>.</li><li>4. After that, all the tasks will complete successfully.</li></ol>	Universal Controller administrator

## Create Start Application and Stop Application tasks

Task	Description	Skills required
Create the Start Application action.	<ol style="list-style-type: none"><li>1. Navigate to <b>Services, AWS Mainframe Modernization Tasks</b>.</li><li>2. On the right panel, fill in the required fields.<ul style="list-style-type: none"><li>• <b>Name:</b> Mainframe Modernization Start Application</li><li>• <b>Agent:</b> Select the only agent (AGNT0001)</li></ul></li></ol> <p>Under <b>AWS Mainframe Modernization Details:</b></p> <ul style="list-style-type: none"><li>• <b>Action:</b> Start Application</li><li>• <b>AWS Credentials:</b> If you have an IAM role added to the EC2 instance, you can keep this field empty. If you will use <code>AWSAccessKeyId</code> and <code>AWSSecretKey</code>, select the credential that you created before.</li><li>• <b>End Point:</b> Be sure that the endpoint has the correct Region. The default is <a href="https://m2.us-east-1.amazonaws.com">https://m2.us-east-1.amazonaws.com</a>.</li><li>• <b>Region:</b> Enter the Region of the AWS Mainframe Modernization service.</li></ul>	Universal Controller administrator

Task	Description	Skills required
	<p>The default is us-east-1 .</p> <ul style="list-style-type: none"><li>• <b>Application:</b> Choose the icon next to the field (<b>○</b>), and choose <b>Submit</b> in the <b>Refresh Application Choices</b>. This will connect to the AWS Mainframe Modernization service and return the list of applications. Now you can select the application from the dropdown list. Select the application you want to run the batch job.</li><li>• <b>Wait for Success or Failure:</b> If this option is selected, the task will wait until the status of the batch job is success or failure.</li><li>• <b>Polling Interval:</b> This is the amount of time between each polling.</li><li>• <b>Fetch Execution Logs:</b> If selected, logs will be fetched automatically when the batch job has completed.</li><li>• <b>Log Format:</b> This is the format of the logs to be printed out. It can be Text or JSON format.</li></ul>	

Task	Description	Skills required
	<ol style="list-style-type: none"> <li>3. Keep the default values in the rest of the fields, and save the task.</li> <li>4. Now copy this task and create a task for Stop Application. Change the name to <b>Mainframe Modernization Stop Application</b>, and change the action to <b>Stop Application</b>.</li> </ol>	

### Create a Cancel Batch Execution task

Task	Description	Skills required
<p>Create the Cancel Batch action.</p>	<ol style="list-style-type: none"> <li>1. Navigate to <b>Services, AWS Mainframe Modernization Tasks</b>.</li> <li>2. On the right panel, fill in the required fields. <ul style="list-style-type: none"> <li>• <b>Name:</b> Mainframe Modernization Cancel Batch Execution</li> <li>• <b>Agent:</b> Select the only agent (AGNT0001)</li> </ul> <p>Under <b>AWS Mainframe Modernization Details:</b></p> <ul style="list-style-type: none"> <li>• <b>Action:</b> Cancel Batch Execution</li> <li>• <b>AWS Credentials:</b> If you have an IAM role added</li> </ul> </li> </ol>	



Task	Description	Skills required
	<p>to the EC2 instance, you can keep this field empty. If you will use <code>AWSAccessKeyId</code> and <code>AWSSecretKey</code>, select the credential that you created before.</p> <ul style="list-style-type: none"><li>• <b>End Point:</b> Be sure that the endpoint has the correct Region. The default is <a href="https://m2.us-east-1.amazonaws.com">https://m2.us-east-1.amazonaws.com</a>.</li><li>• <b>Region:</b> Enter the Region of the AWS Mainframe Modernization service. The default is <code>us-east-1</code>.</li><li>• <b>Application:</b> Choose the icon next to the field <b>( )</b>, and choose <b>Submit</b> in the <b>Refresh Application Choices</b>. This will connect to the AWS Mainframe Modernization service and return the list of applications. Now you can select the application from the dropdown list. Select the application you want to run the batch job.</li><li>• <b>Wait for Success or Failure:</b> If this option is selected, the task will</li></ul>	

Task	Description	Skills required
	<p>wait until the status of the batch job is success or failure.</p> <ul style="list-style-type: none"><li>• <b>Polling Interval:</b> This is the amount of time between each polling.</li><li>• <b>Fetch Execution Logs:</b> If selected, logs will be fetched automatically when the batch job has completed.</li><li>• <b>Log Format:</b> This is the format of the logs to be printed out. It can be Text or JSON format.</li></ul> <p>3. Keep the default values in the rest of the fields, and save the task.</p>	

## Related resources

- [Universal Controller](#)
- [Universal Agent](#)
- [LDAP Settings](#)
- [Single Sign-On Settings](#)
- [High Availability](#)
- [Xpress Conversion Tool](#)

## Additional information

### Icons in the Workflow Editor



Mainframe Modernization RUNHELLO



Mainframe Modernization FOOBAR



Mainframe Modernization RUNAWS2



Mainframe Modernization RUNAWS3



Mainframe Modernization RUNAWS4

### All tasks connected



Mainframe Modernization RUNHELLO



Mainframe Modernization FOOBAR



Mainframe Modernization RUNAWS2



Mainframe Modernization RUNAWS3



Mainframe Modernization RUNAWS4

### Workflow status

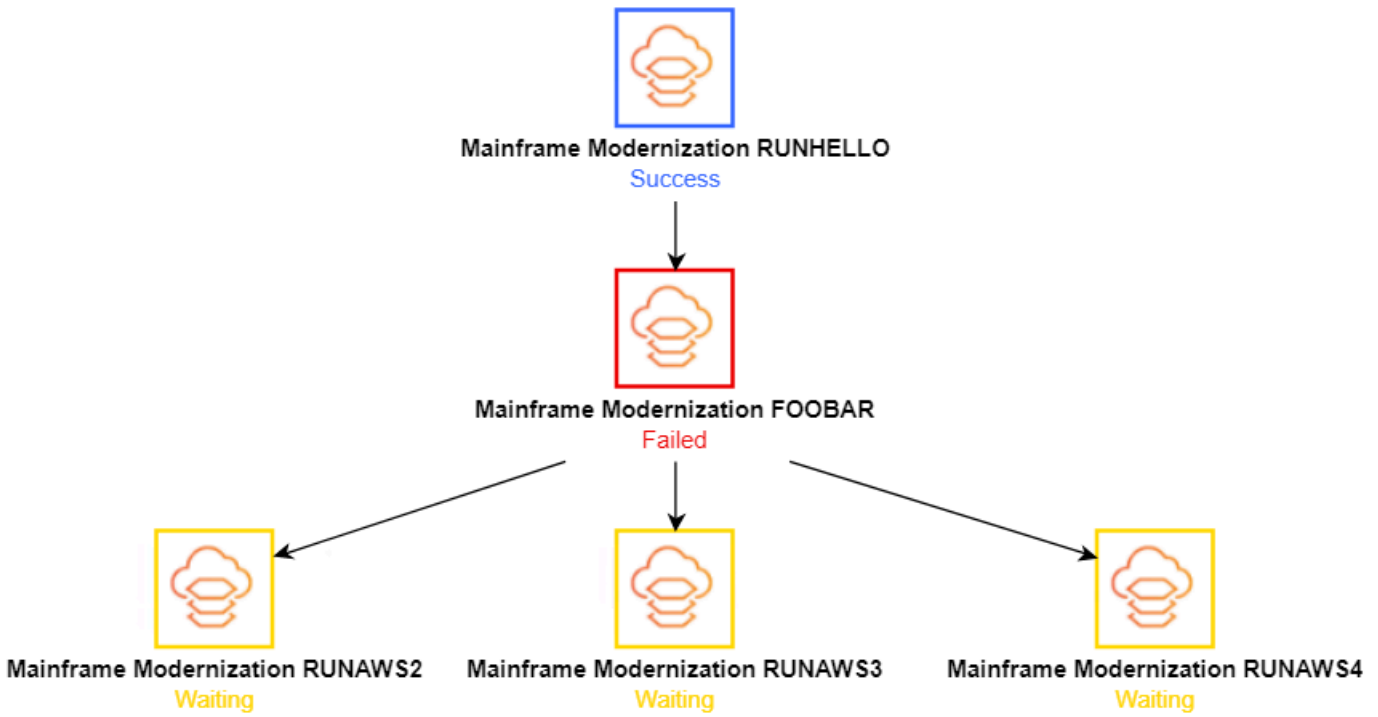

# Migrate and replicate VSAM files to Amazon RDS or Amazon MSK using Connect from Precisely

Created by Prachi Khanna (AWS) and Boopathy GOPALSAMY (AWS)

<b>Environment:</b> PoC or pilot	<b>Source:</b> VSAM	<b>Target:</b> Database
<b>R Type:</b> Re-architect	<b>Workload:</b> IBM	<b>Technologies:</b> Mainframe; Modernization
<b>AWS services:</b> Amazon MSK; Amazon RDS; AWS Mainframe Modernization		

## Summary

This pattern shows you how to migrate and replicate Virtual Storage Access Method (VSAM) files from a mainframe to a target environment in the AWS Cloud by using [Connect](#) from Precisely. The target environments covered in this pattern include Amazon Relational Database Service (Amazon RDS) and Amazon Managed Streaming for Apache Kafka (Amazon MSK). Connect uses [change data capture \(CDC\)](#) to continuously monitor updates to your source VSAM files and then transfer these updates to one or more of your AWS target environments. You can use this pattern to meet your application modernization or data analytics goals. For example, you can use Connect to migrate your VSAM application files to the AWS Cloud with low latency, or migrate your VSAM data to an AWS data warehouse or data lake for analytics that can tolerate synchronization latencies that are higher than required for application modernization.

## Prerequisites and limitations

### Prerequisites

- [IBM z/OS V2R1](#) or later
- [CICS Transaction Server for z/OS \(CICS TS\) V5.1](#) or later (CICS/VSAM data capture)
- [IBM MQ 8.0](#) or later
- Compliance with [z/OS security requirements](#) (for example, APF authorization for SQData load libraries)

- VSAM recovery logs turned on
- (Optional) [CICS VSAM Recovery Version \(CICS VR\)](#) to automatically capture CDC logs
- An active AWS account
- An [Amazon Virtual Private Cloud \(VPC\)](#) with a subnet that's reachable by your legacy platform
- A VSAM Connect license from Precisely

## Limitations

- Connect doesn't support automatic target table creation based on source VSAM schemas or copybooks. You must define the target table structure for the first time.
- For non-streaming targets such as Amazon RDS, you must specify the conversion source to target mapping in the Apply Engine configuration script.
- Logging, monitoring, and alerting functions are implemented through APIs and require external components (such as Amazon CloudWatch) to be fully operational.

## Product versions

- SQData 40134 for z/OS
- SQData 4.0.43 for the Amazon Linux Amazon Machine Image (AMI) on Amazon Elastic Compute Cloud (Amazon EC2)

## Architecture

### Source technology stack

- Job Control Language (JCL)
- z/OS Unix shell and Interactive System Productivity Facility (ISPF)
- VSAM utilities (IDCAMS)

### Target technology stack

- Amazon EC2
- Amazon MSK
- Amazon RDS

- Amazon VPC

## Target architecture

### *Migrating VSAM files to Amazon RDS*

The following diagram shows how to migrate VSAM files to a relational database, such as Amazon RDS, in real time or near real time by using the CDC agent/publisher in the source environment (on-premises mainframe) and the [Apply Engine](#) in the target environment (AWS Cloud).

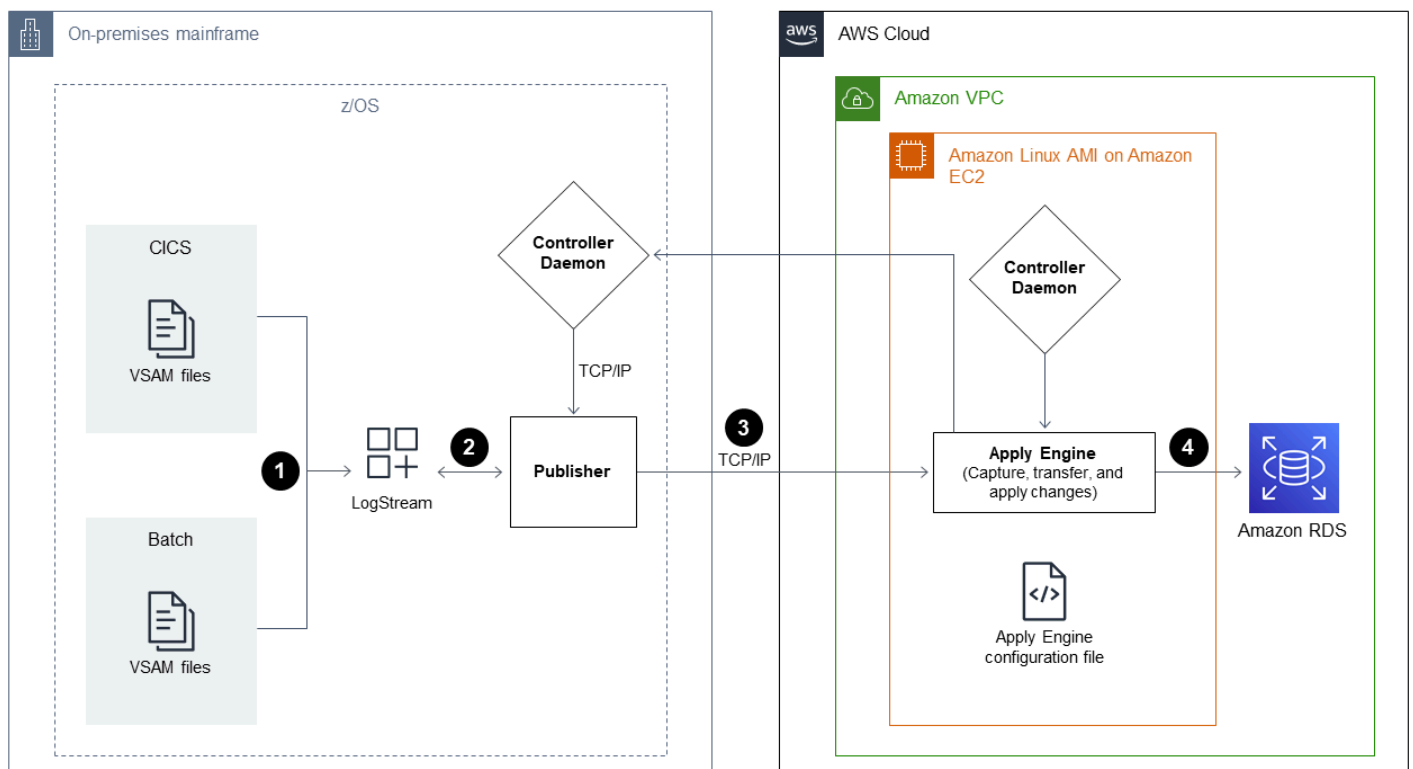

The diagram shows the following batch workflow:

1. Connect captures changes to a file by comparing VSAM files from backup files to identify changes and then sends the changes to the logstream.
2. The publisher consumes data from the system logstream.
3. The publisher communicates captured data changes to a target engine through TCP/IP. The Controller Daemon authenticates communication between the source and target environments.
4. The Apply Engine in the target environment receives the changes from the Publisher agent and applies them to a relational or non-relational database.

The diagram shows the following online workflow:

1. Connect captures changes in the online file by using a log replicate and then streams captured changes to a logstream.
2. The publisher consumes data from the system logstream.
3. The publisher communicates captured data changes to the target engine through TCP/IP. The Controller Daemon authenticates communication between the source and target environments.
4. The Apply Engine in the target environment receives the changes from the Publisher agent and then applies them to a relational or non-relational database.

### Migrating VSAM files to Amazon MSK

The following diagram shows how to stream VSAM data structures from a mainframe to Amazon MSK in high-performance mode and automatically generate JSON or AVRO schema conversions that integrate with Amazon MSK.

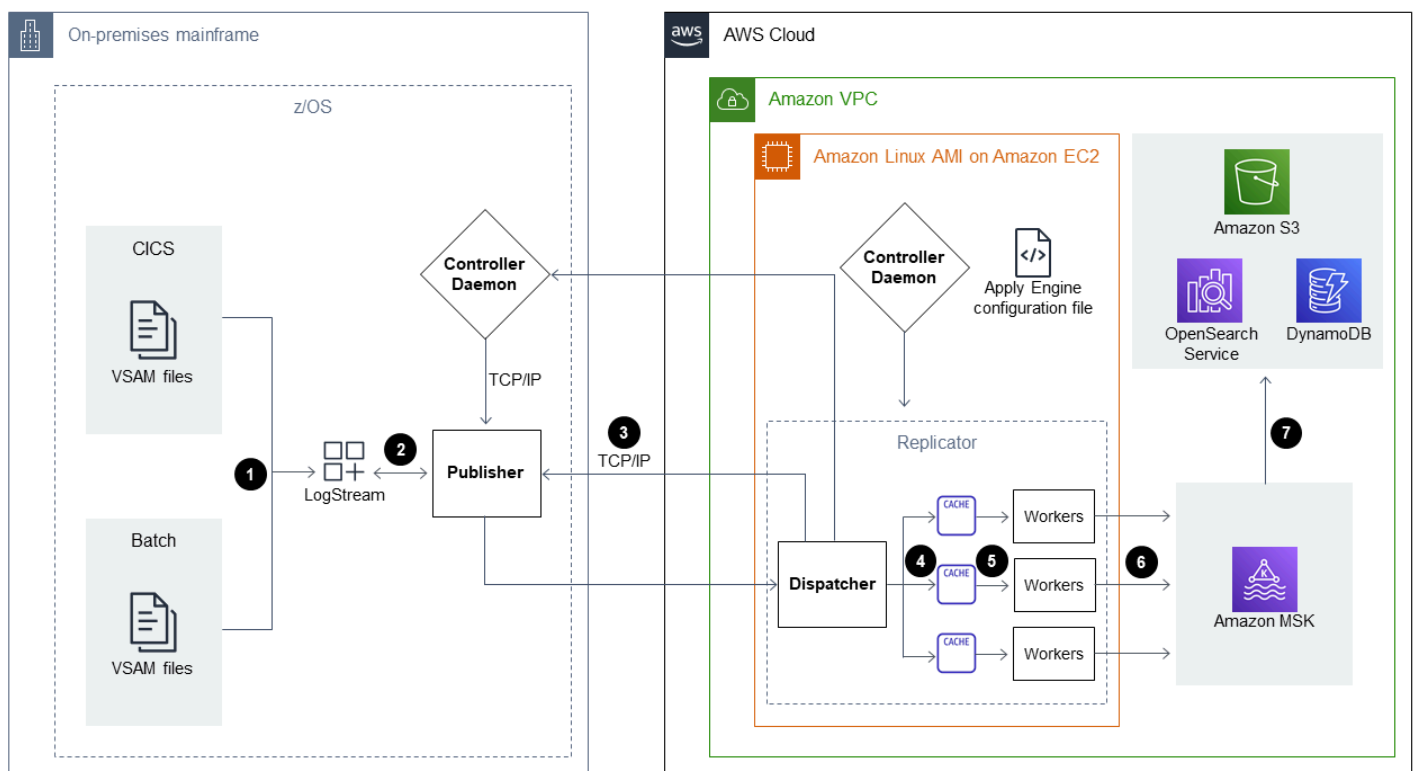

The diagram shows the following batch workflow:



1. Connect captures changes to a file by using CICS VR or by comparing VSAM files from backup files to identify changes. Captured changes are sent to the logstream.
2. The publisher consumes data from the system logstream.
3. The publisher communicates captured data changes to the target engine through TCP/IP. The Controller Daemon authenticates communication between the source and target environments.
4. The Replicator Engine that's operating in parallel processing mode splits the data to a unit of work cache.
5. Worker threads capture the data from the cache.
6. Data is published to Amazon MSK topics from the worker threads.
7. Users apply changes from Amazon MSK to targets such as Amazon DynamoDB, Amazon Simple Storage Service (Amazon S3), or Amazon OpenSearch Service by using [connectors](#).

The diagram shows the following online workflow:

1. Changes in the online file are captured by using a log replicate. Captured changes are streamed to the logstream.
2. The publisher consumes data from the system logstream.
3. The publisher communicates captured data changes to the target engine through TCP/IP. The Controller Daemon authenticates communication between the source and target environments.
4. The Replicator Engine that's operating in parallel processing mode splits the data to a unit of work cache.
5. Worker threads capture the data from the cache.
6. Data is published to Amazon MSK topics from the worker threads.
7. Users apply changes from Amazon MSK to targets such as DynamoDB, Amazon S3, or OpenSearch Service by using [connectors](#).

## Tools

- [Amazon Managed Streaming for Apache Kafka \(Amazon MSK\)](#) is a fully managed service that helps you build and run applications that use Apache Kafka to process streaming data.
- [Amazon Relational Database Service \(Amazon RDS\)](#) helps you set up, operate, and scale a relational database in the AWS Cloud.

## Epics

### Prepare the source environment (mainframe)

Task	Description	Skills required
Install Connect CDC 4.1.	<ol style="list-style-type: none"> <li>1. <a href="#">Contact the Precisely Support team</a> to obtain a license and installation packages.</li> <li>2. Use example JCLs to install Connect CDC 4.1. For instructions, see <a href="#">Install Connect CDC (SQData) using JCL</a> in the Precisely documentation.</li> <li>3. Run the SETPROG APF command to authorize the Connect load libraries SQDATA.V4nnn.LOADLIB.</li> </ol>	IBM Mainframe Developer/Admin
Set up the zFS directory.	<p>To set up a zFS directory, follow the instructions from <a href="#">zFS variable directories</a> in the Precisely documentation.</p> <p><b>Note:</b> Controller Daemon and Capture/Publisher agent configurations are stored in the z/OS UNIX Systems Services file system (referred to as zFS). The Controller Daemon, Capture, Storage, and Publisher agents require a predefined zFS directory structure for storing a small number of files.</p>	IBM Mainframe Developer/Admin

Task	Description	Skills required
Configure TCP/IP ports.	<p>To configure TCP/IP ports, follow the instructions from <a href="#">TCP/IP ports</a> in the Precisely documentation.</p> <p><b>Note:</b> The Controller Daemon requires TCP/IP ports on source systems. The ports are referenced by the engines on the target systems (where captured change data is processed).</p>	IBM Mainframe Developer/Admin
Create a z/OS logstream.	<p>To create a <a href="#">z/OS logstream</a>, follow the instructions from <a href="#">Create z/OS system logStreams</a> in the Precisely documentation.</p> <p><b>Note:</b> Connect uses the logstream to capture and stream data between your source environment and target environment during migration.</p> <p>For an example JCL that creates a z/OS LogStream, see <a href="#">Create z/OS system logStreams</a> in the Precisely documentation.</p>	IBM Mainframe Developer

Task	Description	Skills required
Identify and authorize IDs for zFS users and started tasks.	Use RACF to grant access to the OMVS zFS file system. For an example JCL, see <a href="#">Identify and authorize zFS user and started task IDs</a> in the Precisely documentation.	IBM Mainframe Developer/Admin
Generate z/OS public/private keys and the authorized key file.	Run the JCL to generate the key pair. For an example, see <i>Key pair example</i> in the <i>Additional information</i> section of this pattern.  For instructions, see <a href="#">Generate z/OS public and private keys and authorized key file</a> in the Precisely documentation.	IBM Mainframe Developer/Admin
Activate the CICS VSAM Log Replicate and attach it to the logstream.	Run the following JCL script: <pre data-bbox="594 1108 1029 1509">//STEP1 EXEC PGM=IDCAM S //SYSPRINT DD SYSOUT=* //SYSIN DD *   ALTER SQDATA.CI CS.FILEA -   LOGSTREAMID(SQDATA .VSAMCDC.LOG1) -   LOGREPLICATE</pre>	IBM Mainframe Developer/Admin

Task	Description	Skills required
Activate the VSAM File Recovery Log through an FCT.	<p>Modify the File Control Table (FCT) to reflect the following parameter changes:</p> <pre> Configure FCT Params   CEDA ALT FILE(name)   GROUP(groupname)   DSNAME(data set name)   RECOVERY(NONE BACK OUTONLY ALL)   FWDRECOVLOG(NO 1-9 9)   BACKUPTYPE(STATIC  DYNAMIC)   RECOVERY PARAMETERS   RECOVry : None   Backoutonly   All   Fwdrecovlog : No   1-99   BAckuptype : Static   Dynamic           </pre>	IBM Mainframe Developer/ Admin
Set up CDCzLog for the Publisher agent.	<ol style="list-style-type: none"> <li>1. Create the CDCzLog Publisher CAB file.</li> <li>2. Encrypt the published data.</li> <li>3. Prepare the CDCzLog Publisher Runtime JCL.</li> </ol>	IBM Mainframe Developer/ Admin

Task	Description	Skills required
Activate the Controller Daemon.	<ol style="list-style-type: none"><li>1. Open the ISPF panel and run the following command to open the Precisely menu: EXEC 'SQDATA.V4nnnnn.IS PFLIB(SQDC\$STA) ' 'SQDATA.V4nnnnn '</li><li>2. To set up the Controller Daemon, choose option 2 from the menu.</li></ol>	IBM Mainframe Developer/ Admin
Activate the publisher.	<ol style="list-style-type: none"><li>1. Open the ISPF panel and run the following command to open the Precisely menu: EXEC 'SQDATA.V4nnnnn.IS PFLIB(SQDC\$STA) ' 'SQDATA.V4nnnnn '</li><li>2. To set up the publisher, choose option 3 from the menu and I for insert.</li></ol>	IBM Mainframe Developer/ Admin

Task	Description	Skills required
Activate the logstream.	<ol style="list-style-type: none"> <li>1. Open the ISPF panel and run the following command to open the Precisely menu: EXEC 'SQDATA.V4nnnnn.IS PFLIB(SQDC\$STA)' 'SQDATA.V4nnnnn'</li> <li>2. To set up the logstream , choose option 4 from the menu and I for insert. Then, enter the name of the logstream created in the preceding steps.</li> </ol>	IBM Mainframe Developer/ Admin

### Prepare the target environment (AWS)

Task	Description	Skills required
Install Precisely on an EC2 instance.	To install Connect from Precisely on the Amazon Linux AMI for Amazon EC2, follow the instructions from <a href="#">Install Connect CDC (SQData) on UNIX</a> in the Precisely documentation.	General AWS
Open TCP/IP ports.	To modify the security group to include the Controller Daemon ports for inbound and outbound access, follow the instructions from <a href="#">TCP/IP</a> in the Precisely documentation.	General AWS

Task	Description	Skills required
Create file directories.	To create file directories, follow the instructions from <a href="#">Prepare target apply environment</a> in the Precisely documentation.	General AWS
Create the Apply Engine configuration file.	<p>Create the Apply Engine configuration file in the working directory of the Apply Engine. The following example configuration file shows Apache Kafka as the target:</p> <pre data-bbox="597 856 1026 1293">builtin.features=S ASL_SCRAM   security.protocol= SASL_SSL   sasl.mechanism=SCR AM-SHA-512   sasl.username=   sasl.password=   metadata.broker.li st=</pre> <p><b>Note:</b> For more information, see <a href="#">Security</a> in the Apache Kafka documentation.</p>	General AWS
Create scripts for Apply Engine processing.	Create the scripts for the Apply Engine to process source data and replicate source data to the target. For more information, see <a href="#">Create an apply engine script</a> in the Precisely documentation.	General AWS



Task	Description	Skills required
Run the scripts.	Use the SQDPARSE and SQDENG commands to run the script. For more information, see <a href="#">Parse a script for zOS</a> in the Precisely documentation.	General AWS

## Validate the environment

Task	Description	Skills required
Validate the list of VSAM files and target tables for CDC processing.	<ol style="list-style-type: none"> <li>1. Validate VSAM files, including replication logs, recovery logs, FCT parameters, and the logstream.</li> <li>2. Validate target database tables, including whether the tables are created as per the required schema definition, table access, and other criteria.</li> </ol>	General AWS, Mainframe
Verify that the Connect CDC SQData product is linked.	<p>Run a testing job and verify that the return code from this job is 0 (Successful).</p> <p><b>Note:</b> Connect CDC SQData Apply Engine status messages should show active connection messages.</p>	General AWS, Mainframe

## Run and validate test cases (Batch)

Task	Description	Skills required
Run the batch job in the mainframe.	<p>Run the batch application job using a modified JCL. Include steps in the modified JCL that do the following:</p> <ol style="list-style-type: none"> <li>1. Take a backup of the data files.</li> <li>2. Compare the backup file with the modified data files, generate the delta file, and then note the delta record count from the messages.</li> <li>3. Push the delta file to the z/OS logstream.</li> <li>4. Run the JCL. For an example JCL, see <a href="#">Prepare file compare capture JCL</a> in the Precisely documentation.</li> </ol>	General AWS, Mainframe
Check the logstream.	Check the logstream to confirm that you can see the change data for the completed mainframe batch job.	General AWS, Mainframe
Validate the counts for the source delta changes and target table.	<p>To confirm the records are tallied, do the following:</p> <ol style="list-style-type: none"> <li>1. Gather the source delta count from the batch JCL messages.</li> </ol>	General AWS, Mainframe

Task	Description	Skills required
	<ol style="list-style-type: none"> <li>2. Monitor the Apply Engine for record level counts of the number of records inserted, updated, or deleted in the VSAM file.</li> <li>3. Query the target table for record counts.</li> <li>4. Compare and tally all the different record counts.</li> </ol>	

### Run and validate test cases (Online)

Task	Description	Skills required
Run the online transaction in a CICS region.	<ol style="list-style-type: none"> <li>1. Run the online transaction to validate the test case.</li> <li>2. Validate the transaction execution code (RC=0 – Success).</li> </ol>	IBM Mainframe Developer
Check the logstream.	Confirm that the logstream is populated with specific record level changes.	AWS Mainframe Developer
Validate the count in the target database.	Monitor the Apply Engine for record level counts.	Precisely, Linux
Validate the record counts and data records in the target database.	Query the target database to validate the record counts and data records.	General AWS

## Related resources

- [VSAM z/OS](#) (Precisely documentation)

- [Apply engine](#) (Precisely documentation)
- [Replicator engine](#) (Precisely documentation)
- [The log stream](#) (IBM documentation)

## Additional information

### Configuration file example

This is an example configuration file for a logstream where the source environment is a mainframe and the target environment is Amazon MSK:

```
-- JOBNAME -- PASS THE SUBSCRIBER NAME
-- REPORT progress report will be produced after "n" (number) of Source records
processed.

JOBNAME VSMTOKFK;
--REPORT EVERY 100;
-- Change Op has been 'I' for insert, 'D' for delete , and 'R' for Replace. For RDS
it is 'U' for update
-- Character Encoding on z/OS is Code Page 1047, on Linux and UNIX it is Code Page
819 and on Windows, Code Page 1252
OPTIONS
CDCOP('I', 'U', 'D'),
PSEUDO NULL = NO,
USE AVRO COMPATIBLE NAMES,
APPLICATION ENCODING SCHEME = 1208;

-- SOURCE DESCRIPTIONS

BEGIN GROUP VSAM_SRC;
DESCRIPTION COBOL ../copybk/ACCOUNT AS account_file;
END GROUP;

-- TARGET DESCRIPTIONS

BEGIN GROUP VSAM_TGT;
DESCRIPTION COBOL ../copybk/ACCOUNT AS account_file;
END GROUP;

-- SOURCE DATASTORE (IP & Publisher name)
```

```

DATASTORE cdc://10.81.148.4:2626/vsmcdct/VSMTOKFK
OF VSAMCDC
AS CDCIN
DESCRIBED BY GROUP VSAM_SRC ACCEPT ALL;

--          TARGET DATASTORE(s) - Kafka and topic name

DATASTORE 'kafka:///MSKTutorialTopic/key'
OF JSON
AS CDCOUT
DESCRIBED BY GROUP VSAM_TGT FOR INSERT;

--          MAIN SECTION

PROCESS INTO
CDCOUT
SELECT
{
SETURL(CDCOUT, 'kafka:///MSKTutorialTopic/key')
REMAP(CDCIN, account_file, GET_RAW_RECORD(CDCIN, AFTER), GET_RAW_RECORD(CDCIN,
BEFORE))
REPLICATE(CDCOUT, account_file)
}
FROM CDCIN;

```

## Key pair example

This an example of how to run the JCL to generate the key pair:

```

//SQDUTIL EXEC PGM=SQDUTIL //SQDPUBL DD DSN=&USER..NACL.PUBLIC, //
DCB=(RECFM=FB,LRECL=80,BLKSIZE=21200), // DISP=(,CATLG,DELETE),UNIT=SYSDA, //
SPACE=(TRK,(1,1)) //SQDPKEY DD DSN=&USER..NACL.PRIVATE, //
DCB=(RECFM=FB,LRECL=80,BLKSIZE=21200), // DISP=(,CATLG,DELETE),UNIT=SYSDA, //
SPACE=(TRK,(1,1)) //SQDPARMS DD keygen //SYSPRINT DD SYSOUT= //SYSOUT DD SYSOUT=* //
SQDLOG DD SYSOUT=* //*SQDLOG8 DD DUMMY

```

# Modernize mainframe output management on AWS by using OpenText Micro Focus Enterprise Server and LRS PageCenterX

Created by Shubham Roy (AWS), Abraham Rondon (Micro Focus), and Guy Tucker (Levi, Ray and Shoup Inc)

<b>Environment:</b> PoC or pilot	<b>Source:</b> IBM mainframe	<b>Target:</b> AWS
<b>R Type:</b> Replatform	<b>Workload:</b> IBM	<b>Technologies:</b> Mainframe; Migration; Modernization
<b>AWS services:</b> AWS Managed Microsoft AD; Amazon EC2; Amazon FSx for Windows File Server; Amazon RDS; AWS Mainframe Modernization		

## Summary

By modernizing your mainframe output management, you can achieve cost savings, mitigate the technical debt of maintaining legacy systems, and improve resiliency and agility through DevOps and Amazon Web Services (AWS) cloud-native technologies. This pattern shows you how to modernize your business-critical mainframe output-management workloads on the AWS Cloud. The pattern uses [OpenText Micro Focus Enterprise Server](#) as a runtime for a modernized mainframe application, with Levi, Ray & Shoup, Inc. (LRS) VPSX/MFI (Micro Focus Interface) as a print server and LRS PageCenterX as an archive server. LRS PageCenterX provides output-management solutions for viewing, indexing, searching, archiving, and securing access to business outputs.

The pattern is based on the [replatform](#) mainframe modernization approach. Mainframe applications are migrated by [AWS Mainframe Modernization](#) on Amazon Elastic Compute Cloud (Amazon EC2). Mainframe output-management workloads are migrated to Amazon EC2, and a mainframe database, such as IBM Db2 for z/OS, is migrated to Amazon Relational Database Service (Amazon RDS). The LRS Directory Integration Server (LRS/DIS) works with AWS Directory Service for Microsoft Active Directory for output-management workflow authentication and authorization.

## Prerequisites and limitations

### Prerequisites

- An active AWS account.
- A mainframe output-management workload.
- Basic knowledge of how to rebuild and deliver a mainframe application that runs on OpenText Micro Focus Enterprise Server. For more information, see the [Enterprise Server](#) data sheet in the OpenText Micro Focus documentation.
- Basic knowledge of LRS cloud printing solutions and concepts. For more information, see *Output Modernization* in the LRS documentation.
- Micro Focus Enterprise Server software and license. For more information, contact OpenText [Micro Focus sales](#).
- LRS VPSX/MFI, LRS PageCenterX, LRS/Queue, and LRS/DIS software and licenses. For more information, [contact LRS](#). You must provide the hostnames of the EC2 instances where the LRS products will be installed.

**Note:** For more information about configuration considerations for mainframe output-management workloads, see *Considerations* in the [Additional information](#) section of this pattern.

### Product versions

- [OpenText Micro Focus Enterprise Server](#) 8.0 or later
- [LRS VPSX/MFI](#)
- [LRS PageCenterX](#) V1R3 or later

## Architecture

### Source technology stack

- Operating system – IBM z/OS
- Programming language – Common business-oriented language (COBOL), job control language (JCL), and Customer Information Control System (CICS)

- Database – IBM Db2 for z/OS, IBM Information Management System (IMS) database, and Virtual Storage Access Method (VSAM)
- Security – Resource Access Control Facility (RACF), CA Top Secret for z/OS, and Access Control Facility 2 (ACF2)
- Print and archive solutions – IBM mainframe z/OS output and printing products (IBM Infoprint Server for z/OS, LRS, and CA Deliver) and archiving solutions (CA Deliver, ASG Mobius, or CA Bundle)

## Source architecture

The following diagram shows a typical current state architecture for a mainframe output-management workload.

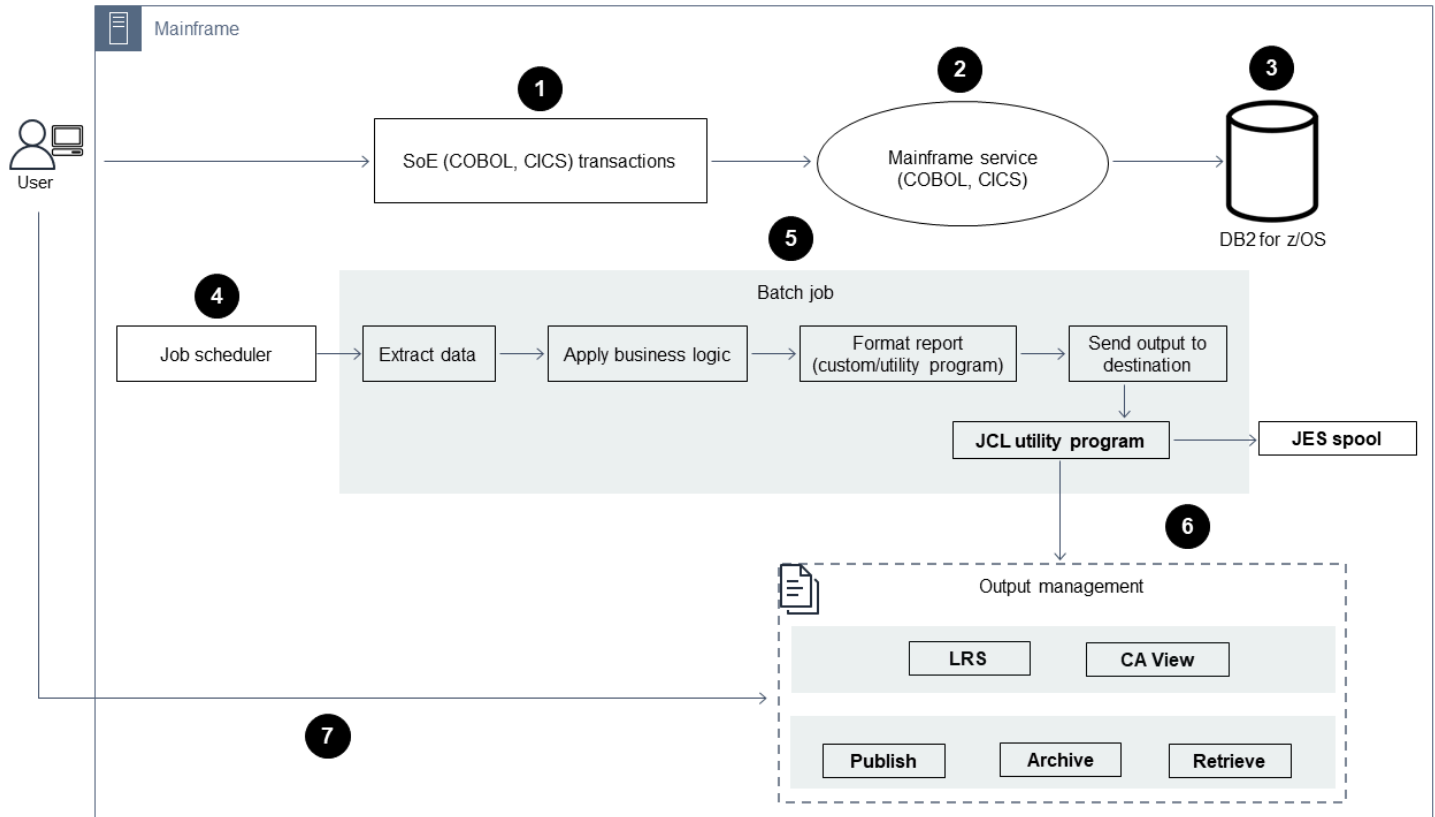

The diagram shows the following workflow:

1. Users perform business transactions on a system of engagement (SoE) that's built on an IBM CICS application written in COBOL.



2. The SoE invokes the mainframe service, which records the business transaction data in a system-of-records (SoR) database such as IBM Db2 for z/OS.
3. The SoR persists the business data from the SoE.
4. The batch job scheduler initiates a batch job to generate print output.
5. The batch job extracts data from the database. It formats the data according to business requirements, and then it generates business output such as billing statements, ID cards, or loan statements. Finally, the batch job routes the output to output management for format, publish, and storage of the output based on the business requirements.
6. Output management receives output from the batch job. Output management indexes, arranges, and publishes the output to a specified destination in the output-management system, such as LRS PageCenterX solutions (as demonstrated in this pattern) or CA View.
7. Users can view, search, and retrieve the output.

### Target technology stack

- Operating system – Windows Server running on Amazon EC2
- Compute – Amazon EC2
- Storage – Amazon Elastic Block Store (Amazon EBS) and Amazon FSx for Windows File Server
- Programming language – COBOL, JCL, and CICS
- Database – Amazon RDS
- Security – AWS Managed Microsoft AD
- Printing and archiving – LRS printing (VPSX) and archiving (PageCenterX) solution on AWS
- Mainframe runtime environment – OpenText Micro Focus Enterprise Server

### Target architecture

The following diagram shows an architecture for a mainframe output-management workload that's deployed in the AWS Cloud.

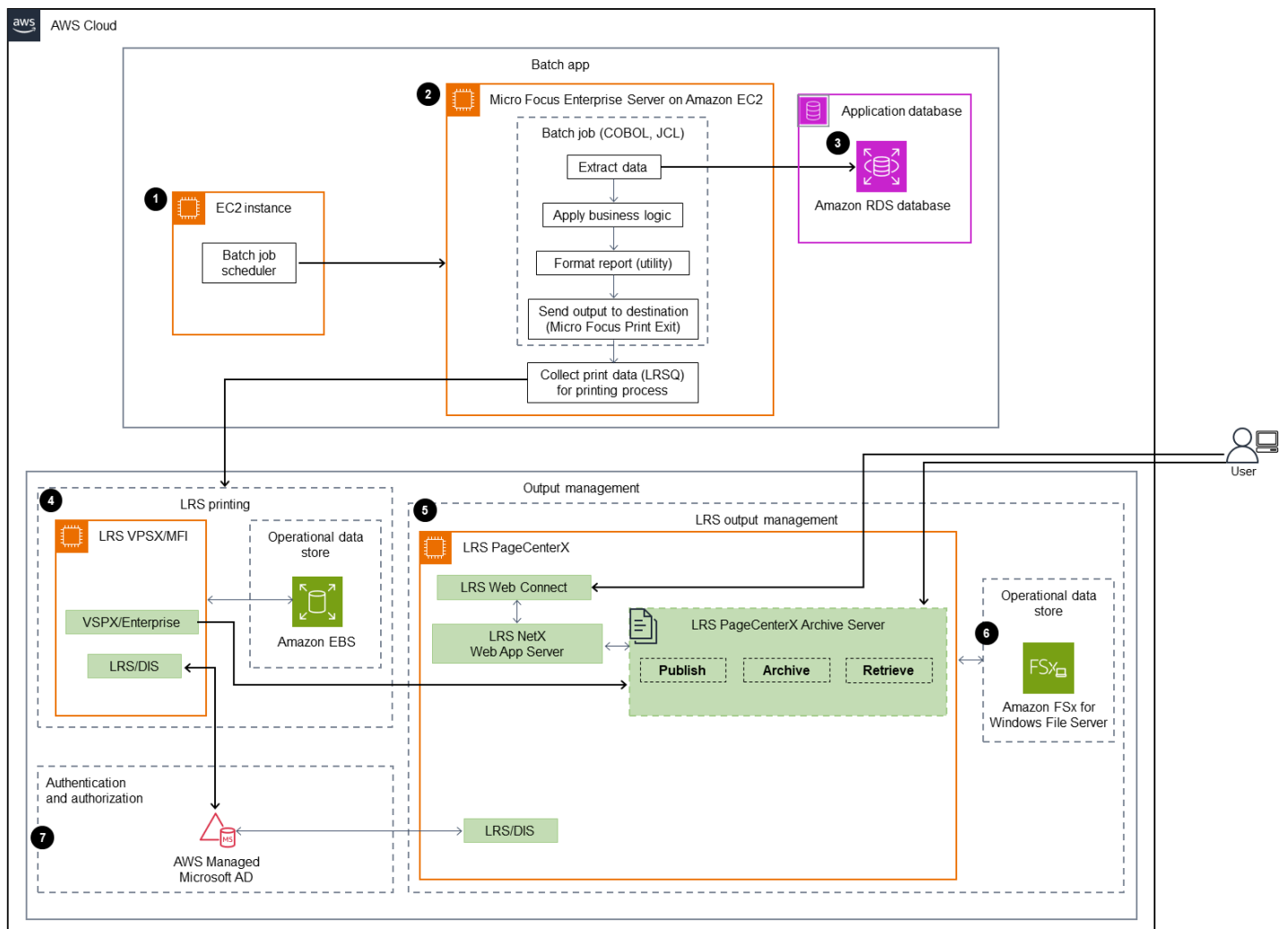

The diagram shows the following workflow:

1. The batch job scheduler initiates a batch job to create output, such as billing statements, ID cards, or loan statements.
2. The mainframe batch job ([replatformed to Amazon EC2](#)) uses the OpenText Micro Focus Enterprise Server runtime to extract data from the application database, apply business logic to the data, and format the data. It then sends the data to an output destination by using [OpenText Micro Focus printer exit module](#) (OpenText Micro Focus documentation).
3. The application database (an SoR that runs on Amazon RDS) persists data for print output.
4. The LRS VPSX/MFI printing solution is deployed on Amazon EC2, and its operational data is stored in Amazon EBS. LRS VPSX/MFI uses the TCP/IP-based LRS/Queue transmission agent to collect output data through the OpenText Micro Focus JES Print Exit API.

LRS VPSX/MFI does data preprocessing, such as EBCDIC to ASCII translation. It also does more complex tasks, including converting mainframe-exclusive data streams such as IBM Advanced Function Presentation (AFP) and Xerox Line Conditioned Data Stream (LCDS) into more common viewing and printing data streams such as Printer Command Language (PCL) and PDF.

During the maintenance window of LRS PageCenterX, LRS VPSX/MFI persists the output queue and serves as backup for the output queue. LRS VPSX/MFI connects and sends output to LRS PageCenterX by using the LRS/Queue protocol. LRS/Queue performs an exchange of both readiness and completion for the jobs to help ensure that the data transfer occurs.

**Notes:**

For more information on print data passed from OpenText Micro Focus Print Exit to LRS/Queue and LRS VPSX/MFI supported mainframe batch mechanisms, see *Print data capture* in the [Additional information](#) section.

LRS VPSX/MFI can perform health checks at the printer-fleet level. For more information, see *Printer-fleet health checks* in the [Additional information](#) section of this pattern.

5. The LRS PageCenterX output-management solution is deployed on Amazon EC2, and its operational data is stored in Amazon FSx for Windows File Server. LRS PageCenterX provides a central report management system of all files imported into LRS PageCenterX along with all users able to access the files. Users can view specific file content or perform searches across multiple files for matching criteria.

The LRS/NetX component is a multi-threaded web application server that provides a common runtime environment for the LRS PageCenterX application and other LRS applications. The LRS/Web Connect component is installed on your web server and provides a connector from the web server to the LRS/NetX web application server.

6. LRS PageCenterX provides storage for file system objects. The operational data of LRS PageCenterX is stored in Amazon FSx for Windows File Server.
7. Output-management authentication and authorization are performed by AWS Managed Microsoft AD with LRS/DIS.

**Note:** The target solution typically doesn't require application changes to accommodate mainframe formatting languages, such as IBM AFP or Xerox LCDS.

## **AWS infrastructure architecture**

The following diagram shows a highly available and secure AWS infrastructure architecture for a mainframe output-management workload.

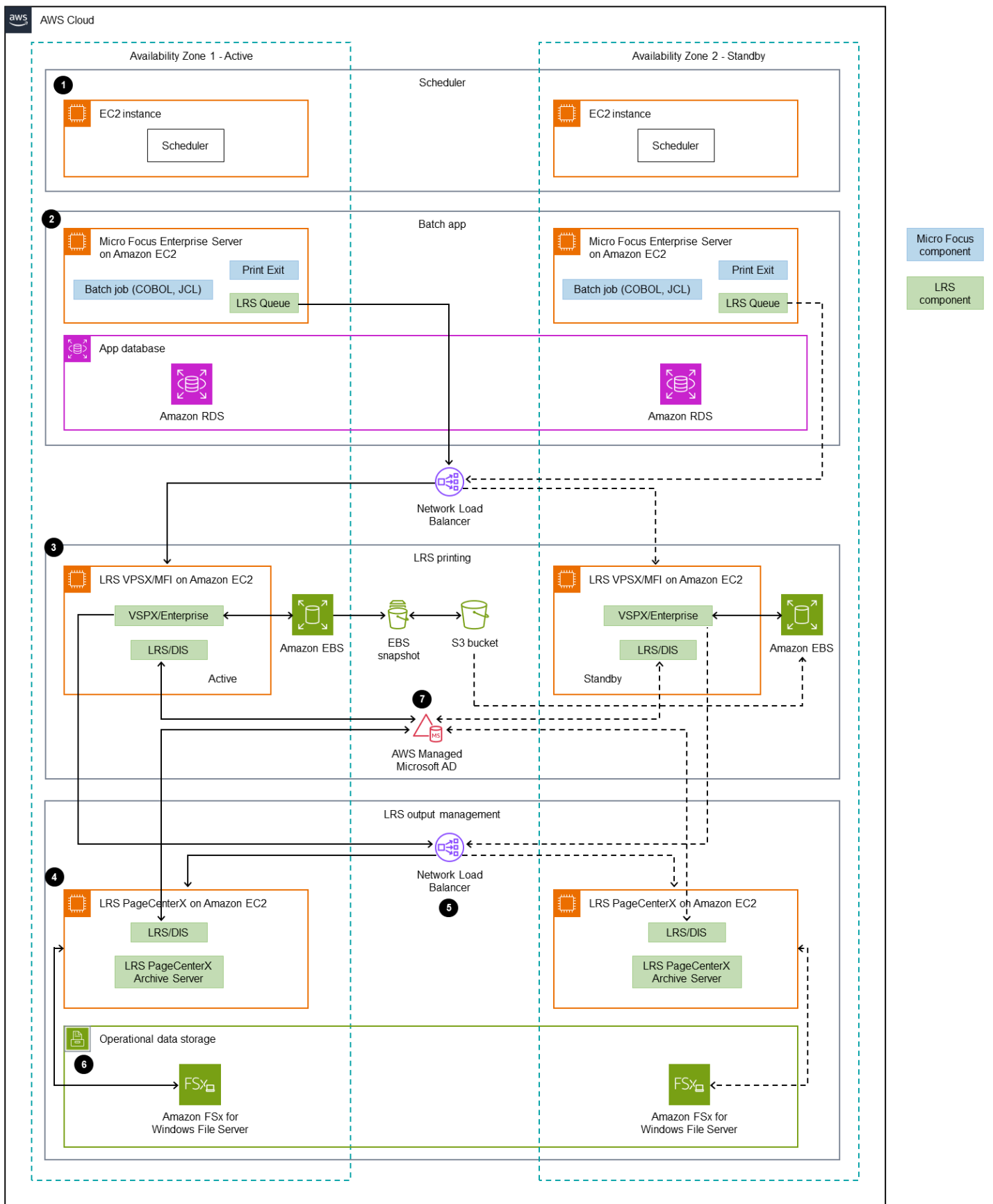

The diagram shows the following workflow:

1. The batch scheduler initiates the batch process and is deployed on Amazon EC2 across multiple [Availability Zones](#) for high availability (HA).

**Note:** This pattern doesn't cover the implementation of the batch scheduler. For more information about implementation, see the software vendor documentation for your scheduler.

2. The mainframe batch job (written in a programming language such as JCL or COBOL) uses core business logic to process and generate print output, such as billing statements, ID cards, and loan statements. The batch job is deployed on Amazon EC2 across two Availability Zones for HA. It uses the OpenText Micro Focus Print Exit API to route print output to LRS VPSX/MFI for data preprocessing.
3. The LRS VPSX/MFI print server is deployed on Amazon EC2 across two Availability Zones for HA (active-standby redundant pair). It uses [Amazon EBS](#) as an operational data store. The Network Load Balancer performs a health check on the LRS VPSX/MFI EC2 instances. If an active instance is in an unhealthy state, the load balancer routes traffic to hot standby instances in the other Availability Zone. The print requests are persisted in the LRS Job Queue locally in each of the EC2 instances. In the event of a failure, a failed instance must be restarted before the LRS services can resume processing the print request.

**Note:** LRS VPSX/MFI can also perform health checks at the printer-fleet level. For more information, see *Printer-fleet health checks* in the [Additional information](#) section of this pattern.

4. LRS PageCenterX output management is deployed on Amazon EC2 across two Availability Zones for HA (active-standby redundant pair). It uses [Amazon FSx for Windows File Server](#) as an operational data store. If an active instance is in an unhealthy state, the load balancer performs a health check on the LRS PageCenterX EC2 instances and routes traffic to standby instances in the other Availability Zone.
5. A [Network Load Balancer](#) provides a DNS name to integrate the LRS VPSX/MFI Server with LRS PageCenterX.

**Note:** LRS PageCenterX supports a Layer 4 load balancer.

6. LRS PageCenterX uses Amazon FSx for Windows File Server as an operational data store deployed across two Availability Zones for HA. LRS PageCenterX understands only files that are in the file share, not in an external database.
7. [AWS Managed Microsoft AD](#) is used with LRS/DIS to perform output-management workflow authentication and authorization. For more information, see *Print output authentication and authorization* in the [Additional information](#) section.

## Tools

### AWS services

- [AWS Directory Service for Microsoft Active Directory](#) enables your directory-aware workloads and AWS resources to use Microsoft Active Directory in the AWS Cloud.
- [Amazon Elastic Block Store \(Amazon EBS\)](#) provides block-level storage volumes for use with Amazon Elastic Compute Cloud (Amazon EC2) instances.
- [Amazon Elastic Compute Cloud \(Amazon EC2\)](#) provides scalable computing capacity in the AWS Cloud. You can launch as many virtual servers as you need and quickly scale them up or down.
- [Elastic Load Balancing \(ELB\)](#) distributes incoming application or network traffic across multiple targets. For example, you can distribute traffic across Amazon EC2 instances, containers, and IP addresses in one or more Availability Zones. This pattern uses a Network Load Balancer.
- [Amazon FSx](#) provides file systems that support industry-standard connectivity protocols and offer high availability and replication across AWS Regions. This pattern uses Amazon FSx for Windows File Server.
- [Amazon Relational Database Service \(Amazon RDS\)](#) helps you set up, operate, and scale a relational database in the AWS Cloud.

### Other tools

- [LRS PageCenterX](#) software provides a scalable document and report content management solution that helps users obtain maximum value from information through automated indexing, encryption, and advanced search features.
- [LRS VPSX/MFI \(Micro Focus Interface\)](#), codeveloped by LRS and OpenText Micro Focus, captures output from an OpenText Micro Focus Enterprise Server JES spool and reliably delivers it to a specified print destination.

- LRS/Queue is a transmission agent that's TCP/IP based. LRS VPSX/MFI uses LRS/Queue to collect or capture print data through the OpenText Micro Focus JES Print Exit programming interface.
- LRS Directory Integration Server (LRS/DIS) is used for authentication and authorization during the print workflow.
- [OpenText Micro Focus Enterprise Server](#) is an application deployment environment for mainframe applications. It provides the runtime environment for mainframe applications that are migrated or created by using any version of OpenText Micro Focus Enterprise Developer.

## Epics

### Set up the OpenText Micro Focus runtime and deploy a mainframe batch application

Task	Description	Skills required
Set up the runtime and deploy a demo application.	<p>To set up OpenText Micro Focus Enterprise Server on Amazon EC2 and deploy the OpenText Micro Focus BankDemo demonstration application, follow the instructions in <a href="#">AWS Mainframe Modernization user-guide</a>.</p> <p>The BankDemo application is a mainframe batch application that creates and then initiates print output.</p>	Cloud architect

### Set up an LRS print server on Amazon EC2

Task	Description	Skills required
Create an Amazon EC2 Windows instance.	To launch an Amazon EC2 Windows instance, follow the instructions in <a href="#">Step 1: Launch</a>	Cloud architect



Task	Description	Skills required
	<p><a href="#">an instance</a> in the Amazon EC2 documentation. Use the same hostname that you used for your LRS product license.</p> <p>Your instance must meet the following hardware and software requirements for LRS VPSX/MFI:</p> <ul style="list-style-type: none"><li>• CPU – Dual Core</li><li>• RAM – 16 GB</li><li>• Drive – 500 GB</li><li>• Minimum EC2 instance – m5.xlarge</li><li>• OS – Windows</li><li>• Software – Internet Information Services (IIS) or Apache</li></ul> <p><b>Note:</b> The preceding hardware and software requirements are intended for a small printer fleet (around 500-1000). To get the full requirements, consult with your LRS and AWS contacts.</p> <ol style="list-style-type: none"><li>1. When you create your Windows instance, confirm that the EC2 hostname is the same hostname used for the LRS product license.</li></ol>	

Task	Description	Skills required
	<ol style="list-style-type: none"><li data-bbox="592 212 1027 485">2. Connect to your EC2 instance by following the instructions from <a href="#">Step 2: Connect to your instance</a> in the Amazon EC2 documentation.</li><li data-bbox="592 506 1027 638">3. On the Windows <b>Start</b> menu, find and open <b>Server Manager</b>.</li><li data-bbox="592 659 1027 884">4. In Server Manager, choose <b>Dashboard, Quick Start, Add roles and features</b>, and then choose <b>Server roles</b>.</li><li data-bbox="592 905 1027 1087">5. In Server roles, choose <b>WebServer (IIS)</b>, and then choose <b>Application Development</b>.</li><li data-bbox="592 1108 1027 1234">6. In Application Development, select the <b>CGI</b> check box.</li><li data-bbox="592 1255 1027 1480">7. To install CGI, follow the instructions in the Windows Server Manager <b>Add roles and features</b> wizard.</li><li data-bbox="592 1501 1027 1684">8. Open port 5500 in the Windows firewall of the EC2 instance for LRS/ Queue communication.</li></ol>	

Task	Description	Skills required
Install LRS VPSX/MFI on the EC2 instance.	<ol style="list-style-type: none"><li data-bbox="591 226 927 308">1. Connect to your EC2 instance.</li><li data-bbox="591 329 992 558">2. Open the link to the product download page from the LRS email message that you should have received.  <b>Note:</b> LRS products are distributed by electronic file transfer (EFT).</li><li data-bbox="591 751 1008 884">3. Download LRS VPSX/MFI, and unzip the file (default folder: c:\LRS).</li><li data-bbox="591 905 1024 1083">4. To install LRS VPSX/MFI, launch the LRS Product Installer from the unzipped folder.</li><li data-bbox="591 1104 1003 1476">5. On the <b>Select Features</b> menu, select <b>VPSX® Server</b>, and then choose <b>Next</b> to start the installation process. You will receive a success message when installation is complete.</li></ol>	Cloud architect

Task	Description	Skills required
Install LRS/Queue.	<ol style="list-style-type: none"><li data-bbox="594 226 1029 357">1. Connect to your OpenText Micro Focus Enterprise Server EC2 instance.</li><li data-bbox="594 378 1029 697">2. Open the link to the LRS product download page from the LRS email message that you should have received, download LRS/Queue, and then unzip the file.</li><li data-bbox="594 718 1029 949">3. Navigate to the location where you downloaded the files, and then launch the LRS Product Installer to install LRS/Queue.</li><li data-bbox="594 970 1029 1150">4. Follow the instructions in the LRS Product Installer to complete the installation process.</li></ol>	Cloud architect

Task	Description	Skills required
Install LRS/DIS.	<p>The LRS/DIS product often is included in LRS VPSX installation. However, if LRS/DIS wasn't installed along with LRS VPSX, use the following steps to install it:</p> <ol style="list-style-type: none"><li>1. Connect to your LRS VPSX/MFI EC2 instance.</li><li>2. Open the link to the LRS product download page from the LRS email message that you should have received, download LRS/DIS, and then unzip the file.</li><li>3. Navigate to the location where you downloaded the files, and then launch the LRS Product Installer.</li><li>4. In the LRS Product Installer, expand <b>LRS Misc Tools</b>, select <b>LRS DIS</b>, and then choose <b>Next</b>.</li><li>5. Follow the rest of the instructions in the LRS Product Installer to complete the installation process.</li></ol>	Cloud architect

Task	Description	Skills required
Create a target group.	<p>Create a target group by following the instructions in <a href="#">Create a target group for your Network Load Balancer</a>. When you create the target group, register the LRS VPSX/MFI EC2 instance as the target:</p> <ol style="list-style-type: none"><li>1. On the <b>Specify group details</b> page, for <b>Choose a Target Type</b>, choose <b>Instances</b>.</li><li>2. For <b>Protocol</b>, choose <b>TCP</b>.</li><li>3. For <b>Port</b>, choose <b>5500</b>.</li><li>4. On the <b>Register targets</b> page, in the <b>Available instances</b> section, select the LRS VPSX/MFI EC2 instance.</li></ol>	Cloud architect

Task	Description	Skills required
Create a Network Load Balancer.	<p>To create the Network Load Balancer, follow the instructions in the <a href="#">Elastic Load Balancing documentation</a>.</p> <p>Your Network Load Balancer routes traffic from OpenText Micro Focus Enterprise Server to the LRS VPSX/MFI EC2 instance.</p> <p>When you create the Network Load Balancer, choose the following values on the <b>Listeners and Routing</b> page:</p> <ol style="list-style-type: none"> <li>1. For <b>Protocol</b>, choose <b>TCP</b>.</li> <li>2. For <b>Port</b>, choose <b>5500</b>.</li> <li>3. For <b>Default action</b>, choose <b>Forward to</b> for the target group that you created earlier.</li> </ol>	Cloud architect

## Integrate OpenText Micro Focus Enterprise Server with LRS/Queue and LRS VPSX/MFI

Task	Description	Skills required
Configure Micro Focus Enterprise Server for LRS/Queue integration.	<ol style="list-style-type: none"> <li>1. Connect to your OpenText Micro Focus Enterprise Server EC2 instance by following the instructions in the <a href="#">Amazon EC2 documentation</a>.</li> <li>2. On the Windows <b>Start</b> menu, open the OpenText</li> </ol>	Cloud architect

Task	Description	Skills required
	<p>Micro Focus Enterprise Server Administration UI.</p> <ol style="list-style-type: none"><li>In the menu bar, choose <b>NATIVE</b>.</li><li>In the navigation pane, choose <b>Directory Server</b>, and then choose <b>BANKDEMO</b> for your Enterprise Server region.</li><li>From <b>General</b> in the left navigation pane, scroll down to the <b>Additional</b> section to configure the environment variables (LRSQ_ADDRESS , LRSQ_PORT , LRSQ_COMMAND ) to point to LRSQ.<ul style="list-style-type: none"><li>For <b>LRSQ_ADDRESS</b>, enter the IP address or DNS name of the Network Load Balancer that you created earlier.</li><li>For <b>LRSQ_PORT</b>, enter <b>VPSX LRSQ Listener Port (5500)</b>.</li><li>For <b>LRSQ_COMMAND</b>, enter the path location of the LRSQ executable.</li></ul></li></ol> <p><b>Note:</b> LRS currently supports a maximum character limit of 50 for DNS names. If your DNS name is longer than 50</p>	



Task	Description	Skills required
	<p>characters, you can use the IP address of the Network Load Balancer as an alternative.</p>	
<p>Configure OpenText Micro Focus Enterprise Server for LRS VPSX/MFI integration.</p>	<ol style="list-style-type: none"> <li>1. Copy the VPSX_MFI_R2 folder from the LRS VPSX/MFI installer to the Micro Focus Enterprise Server location at C\BANKDEMO\print.</li> <li>2. Connect to your Micro Focus Enterprise Server EC2 instance by following the instructions in the <a href="#">Amazon EC2 documentation</a>.</li> <li>3. On the Windows <b>Start</b> menu, open the Micro Focus Enterprise Server Administration UI.</li> <li>4. On the menu bar, choose <b>NATIVE</b>.</li> <li>5. In the navigation pane, choose <b>Directory Server</b>, and then choose <b>BANKDEMO</b>.</li> <li>6. Under BANKDEMO, choose <b>JES</b>.</li> <li>7. Under <b>JES Program Path</b>, add the DLL (VPSX_MFI_R2) path from C\BANKDEMO\print .</li> </ol>	<p>Cloud architect</p>

## Set up the print queue and the print users

Task	Description	Skills required
<p>Associate the OpenText Micro Focus Print Exit module with the Micro Focus Enterprise Server batch printer Server Execution Process.</p>	<ol style="list-style-type: none"> <li>1. Connect to your OpenText Micro Focus Enterprise Server EC2 instance by following the instructions in the <a href="#">Amazon EC2 documentation</a>.</li> <li>2. On the Windows <b>Start</b> menu, open the OpenText Micro Focus Enterprise Server Administration UI.</li> <li>3. On the menu bar, choose <b>NATIVE</b>.</li> <li>4. In the navigation pane, choose <b>Directory Server</b>, and then choose <b>BANKDEMO</b>.</li> <li>5. Under BANKDEMO, choose <b>JES</b>, and scroll down to <b>Printers</b>.</li> <li>6. In Printers, associate the OpenText Micro Focus Print Exit module (<b>LRS PRTE6 for Batch</b>) to the OpenText Micro Focus Enterprise Server batch printer <b>Server Execution Process (SEP)</b>. This enables print output routing to LRS VPSX/MFI.</li> </ol> <p>For more information about configuration, see <a href="#">Using the Exit</a> in the</p>	<p>Cloud architect</p>

Task	Description	Skills required
	<p>OpenText Micro Focus documentation.</p>	
<p>Create a print output queue in LRS VPSX/MFI and integrate it with LRS PageCenterX.</p>	<ol style="list-style-type: none"> <li>1. Connect to your LRS VPSX/MFI EC2 instance.</li> <li>2. On the Windows <b>Start</b> menu, open <b>VPSX Web Interface</b>.</li> <li>3. In the navigation pane, choose <b>Printers</b>.</li> <li>4. Choose <b>Add</b>, and then choose <b>Add Printer</b>.</li> <li>5. On the <b>Printer Configuration</b> page, for <b>Printer Name</b>, enter <b>Local</b>.</li> <li>6. For <b>VPSX ID</b>, enter <b>VPS1</b>.</li> <li>7. For <b>CommType</b>, select <b>TCPIP/LRSQ</b>.</li> <li>8. For <b>Host/IP Address</b>, enter the IP address of the Network Load Balancer fronting the LRS PageCenterX EC2 instances .</li> <li>9. For <b>Remote port</b>, enter 5800.</li> <li>10 For <b>Remote queue</b>, enter the name of the LRS PageCenterX document folder where output will be stored.</li> <li>11 Choose <b>Add</b>.</li> </ol>	<p>Cloud architect</p>

Task	Description	Skills required
Create a print user in LRS VPSX/MFI.	<ol style="list-style-type: none"><li>1. Connect to your LRS VPSX/ MFI EC2 instance.</li><li>2. On the Windows <b>Start</b> menu, open <b>VPSX Web Interface</b>.</li><li>3. In the navigation pane, choose <b>Security</b>, and then choose <b>Users</b>.</li><li>4. In the <b>User Name</b> column, choose <b>admin</b>, and then choose <b>Copy</b>.</li><li>5. In the <b>User Profile Maintenance</b> window, for <b>User Name</b>, enter a username (for example, <b>PrintUser</b>).</li><li>6. For <b>Description</b>, enter a brief description (for example, <b>User for test print</b>).</li><li>7. Choose <b>Update</b>. This creates a print user (for example, <b>PrintUser</b>).</li><li>8. In the navigation pane, under <b>User</b>, choose the new user that you created.</li><li>9. On the <b>Command</b> menu, choose <b>Security</b>.</li><li>10 On the <b>Security Rules</b> page, choose all the applicable printer security and job security options, and then choose <b>Save</b>.</li></ol>	Cloud architect

Task	Description	Skills required
	<p>11.To add your new print user to the <b>Administrator</b> group, on the navigation pane, choose <b>Security</b>, and then choose <b>Configure</b>.</p> <p>12In the <b>Security configuration</b> window, add your new print user to the <b>Administrator</b> column.</p>	

### Set up an LRS PageCenterX server on Amazon EC2

Task	Description	Skills required
<p>Create an Amazon EC2 Windows instance.</p>	<p>Launch an Amazon EC2 Windows instance by following the instructions from <a href="#">Step 1: Launch an instance</a> in the Amazon EC2 documentation. Use the same hostname that you used for your LRS product license.</p> <p>Your instance must meet the following hardware and software requirements for LRS PageCenterX:</p> <ul style="list-style-type: none"> <li>• CPU – Dual Core</li> <li>• RAM – 16 GB</li> <li>• Drive – 500 GB</li> <li>• Minimum EC2 instance – m5.xlarge</li> <li>• OS – Windows</li> </ul>	<p>Cloud architect</p>

Task	Description	Skills required
	<ul style="list-style-type: none"><li>• Software –IIS or Apache</li></ul> <p><b>Note:</b> The preceding hardware and software requirements are intended for a small printer fleet (around 500–1000). To get the full requirements, consult with your LRS and AWS contacts.</p> <ol style="list-style-type: none"><li>1. When you create your Windows instance, confirm that the EC2 hostname is the same hostname used for the LRS product license.</li><li>2. Connect to your EC2 instance by following the instructions in the <a href="#">Amazon EC2 documentation</a>.</li><li>3. On the Windows <b>Start</b> menu, find and open <b>Server Manager</b>.</li><li>4. In Server Manager, choose <b>Dashboard, Quick Start, Add roles and features</b>, then choose <b>Server roles</b>.</li><li>5. In Server roles, choose <b>WebServer (IIS)</b>, and then choose <b>Application Development</b>.</li><li>6. In Application Development, select the <b>CGI</b> check box.</li></ol>	

Task	Description	Skills required
	<ol style="list-style-type: none"><li data-bbox="591 210 987 436">7. To install CGI, follow the instructions in the Windows Server Manger <b>Add roles and features</b> wizard.</li><li data-bbox="591 457 993 827">8. Open port 5800 for inbound TCP/IP traffic in the Windows firewall of the EC2 instance. LRS VPSX uses the TCPIP/LRS Q protocol on 5800 port to communicate to LRS PageCenterX.</li></ol>	

Task	Description	Skills required
Install LRS PageCenterX on the EC2 instance.	<ol style="list-style-type: none"><li>1. Connect to your EC2 instance.</li><li>2. Open the link to the product download page from the LRS email message that you should have received.  <b>Note:</b> LRS products are distributed by electronic file transfer (EFT).</li><li>3. Download LRS PageCenterX, and unzip the file (default folder: c:\LRS).</li><li>4. To install LRS PageCenterX, launch the LRS Product Installer from the unzipped folder.</li><li>5. On the <b>Select Features</b> menu, select <b>PageCenterX</b>, and then choose <b>Next</b> to start the installation process. You will receive a success message when installation is complete.</li></ol>	Cloud architect



Task	Description	Skills required
Install LRS/DIS.	<p>The LRS/DIS product often is included in LRS VPSX installation. However, if LRS/DIS wasn't installed along with LRS VPSX, use the following steps to install it:</p> <ol style="list-style-type: none"><li>1. Connect to your LRS PageCenterX EC2 instance.</li><li>2. Open the link to the LRS product download page from the LRS email that you should have received, download LRS/DIS, and then unzip the file.</li><li>3. Navigate to the location where you downloaded the files, and then launch the LRS Product Installer.</li><li>4. In the LRS Product Installer , expand <b>LRS Misc Tools</b>, select <b>LRS DIS</b>, and then choose <b>Next</b>.</li><li>5. Follow the rest of the instructions in the LRS Product Installer to complete the installation process.</li></ol>	Cloud architect

Task	Description	Skills required
Create a target group.	<p>Create a target group by following the instructions in <a href="#">Create a target group for your Network Load Balancer</a>. When you create the target group, register the LRS PageCenterX EC2 instance as the target:</p> <ol style="list-style-type: none"><li>1. On the <b>Specify group details</b> page, for <b>Choose a Target Type</b>, choose <b>Instances</b>.</li><li>2. For <b>Protocol</b>, choose <b>TCP</b>.</li><li>3. For <b>Port</b>, choose <b>5800</b>.</li><li>4. On the <b>Register targets</b> page, in the <b>Available instances</b> section, select the LRS PageCenterX EC2 instance.</li></ol>	Cloud architect

Task	Description	Skills required
<p>Create a Network Load Balancer.</p>	<p>To create the Network Load Balancer, follow the instructions in the <a href="#">Elastic Load Balancing documentation</a>. Your Network Load Balancer routes traffic from LRS VPSX/MFI to the LRS PageCenterX EC2 instance.</p> <p>When you create the Network Load Balancer, choose the following values on the <b>Listeners and Routing</b> page:</p> <ol style="list-style-type: none"> <li>1. For <b>Protocol</b>, choose <b>TCP</b>.</li> <li>2. For <b>Port</b>, choose <b>5800</b>.</li> <li>3. For <b>Default action</b>, choose <b>Forward to</b> for the target group that you created earlier.</li> </ol>	<p>Cloud architect</p>

### Set up output-management features in LRS PageCenterX

Task	Description	Skills required
<p>Enable the Import function in LRS PageCenterX.</p>	<p>You can use the LRS PageCenterX Import function to recognize the outputs landing on LRS PageCenterX by criteria such as Job name or Form ID. You can then route the outputs to specific folders in LRS PageCenterX.</p>	<p>Cloud architect</p>

Task	Description	Skills required
	<p>To enable the Import function, do the following:</p> <ol style="list-style-type: none"><li>1. Connect to your LRS PageCenterX EC2 instance by following the instructions in the <a href="#">Amazon EC2 documentation</a>.</li><li>2. On the Windows <b>Start</b> menu, open <b>PCX Web Interface</b>.</li><li>3. In <b>Folder Explorer</b>, choose <b>Admin</b>.</li><li>4. On the <b>Configuration</b> page, choose <b>Advanced, Import parameter</b>.</li><li>5. In the <b>Import parameter section</b>, select the <b>Advanced Import</b> check box.</li><li>6. To commit the changes, choose <b>Update</b>.</li></ol>	

Task	Description	Skills required
Configure the document retention policy.	<p>LRS PageCenterX uses a document retention policy to decide how long to keep a document in LRS PageCenterX.</p> <p>To configure the document retention policy, do the following:</p> <ol style="list-style-type: none"><li>1. Connect to your LRS PageCenterX EC2 instance.</li><li>2. On the Windows <b>Start</b> menu, open <b>PCX Web Interface</b>.</li><li>3. In <b>Folder Explorer</b>, choose <b>Admin</b>.</li><li>4. On the Admin page, choose <b>Archive Group List/General admin</b>, and then choose <b>Retention policy</b>.</li><li>5. In the Retention policy section, choose <b>Add</b> to create a retention policy.</li><li>6. On the <b>Retention Policy Information</b> page, enter a <b>Retention policy name</b>, <b>Description</b>, and <b>Document retention period</b>.</li><li>7. To save your changes and create the policy, choose <b>Ok</b>.</li></ol>	Cloud architect

Task	Description	Skills required
<p>Create a rule to route the output document to a specific folder in LRS PageCenterX.</p>	<p>In LRS PageCenterX, <b>Destination</b> determines the folder path where output will be sent when this destination is invoked by <b>Report Definition</b>. For this example, create a folder based on the <b>Form ID</b> folder in the report definition, and save the output to that folder.</p> <ol style="list-style-type: none"><li>1. Connect to your LRS PageCenterX EC2 instance.</li><li>2. On the Windows Start menu, open <b>PCX Web Interface</b>.</li><li>3. In <b>Folder Explorer</b>, choose <b>Admin, Advance Import, Destination</b>.</li><li>4. In the Destination section, choose <b>Add</b> to open the <b>Destination Maintenance</b> form.</li><li>5. On the Destination Maintenance form, enter the following values:<ul style="list-style-type: none"><li>• <b>Destination name</b> – Form</li><li>• <b>Description</b> – Description of the destination, such as <b>Form-based folder structure</b></li></ul></li></ol>	<p>Cloud architect</p>

Task	Description	Skills required
	<ul style="list-style-type: none"> <li>• <b>Destination type</b> – Folder</li> <li>• <b>Folder Parameters</b> – Import folder path (the folder path that will be created in PageCenterX when the document arrives; for example, the path /Test/&amp;FORM/&amp;IMPORTDATE/&amp;IMPORTTIME will create a base Test folder, a subfolder based on <b>Form-Id</b> named STD, a subfolder based on <b>Import date</b>, and then a subfolder based on <b>Import time</b>)</li> <li>• <b>Document name</b> – Dynamic name assigned to a document when it's stored in the folder.</li> </ul> <p>6. In the dropdown list, choose a retention policy. For example, choose <b>Year1</b> to retain the document for 1 year.</p> <p>7. To save the changes, choose <b>Ok</b>.</p>	

Task	Description	Skills required
Create a report definition.	<ol style="list-style-type: none"><li>1. Connect to your LRS PageCenterX EC2 instance.</li><li>2. On the Windows <b>Start</b> menu, open <b>PCX Web Interface</b>.</li><li>3. In <b>Folder Explorer</b>, choose <b>Admin, Advance Import, Report Definition</b>, and then choose <b>Add</b>.</li><li>4. On the <b>Report definition maintenance</b> page, on the <b>General</b> tab, enter the <b>Report Definition name</b>.</li><li>5. On the <b>General</b> tab, under <b>Fields</b>, you can specify selection criteria such as <b>Job Name, Form, Class</b>, and <b>Author</b>. For example, you could enter a <b>Job Name</b> of <b>MFIDEMO</b>. The <b>Job Name</b> value will be the name of the batch job that will generate print output.</li><li>6. On the <b>Destination</b> tab, under <b>Available Destination</b>, choose the previously created destination (<b>Form</b>).</li><li>7. Choose <b>Add</b> to add the <b>Form</b> destination as <b>Assigned destination</b>.</li></ol> <p><b>Note:</b> This example includes a report definition where an output generated</p>	Cloud architect



Task	Description	Skills required
	by the MFIDEMO and routed to LRS PageCenterX is saved in the folder structure defined in the destination definition.	

## Set up authentication and authorization for output management

Task	Description	Skills required
Create an AWS Managed Microsoft AD domain with users and groups.	<ol style="list-style-type: none"> <li>1. To create a directory on AWS Managed Microsoft AD, follow the instructions in <a href="#">Create your AWS Managed Microsoft AD directory</a>.</li> <li>2. To deploy an EC2 instance (Active Directory manager) and install Active Directory tools to manage your AWS Managed Microsoft AD, follow the instructions in <a href="#">Step 3: Deploy an EC2 instance to manage your AWS Managed Microsoft AD</a>.</li> <li>3. To connect to your EC2 instance, follow the instructions in the <a href="#">Amazon EC2 documentation</a>.</li> </ol> <p><b>Note:</b> When you connect to the EC2 instance, in the <b>Windows Security</b> window,</p>	Cloud architect

Task	Description	Skills required
	<p>enter the administrator credentials for the directory that you created in step 1.</p> <p>4. On the Windows <b>Start</b> menu, under <b>Windows Administrative Tools</b>, choose <b>Active Directory Users and Computers</b>.</p> <p>5. To create a print user in the Active Directory domain, follow the instructions in <a href="#">Create a user</a>.</p>	
Join the EC2 instances to an AWS Managed Microsoft AD domain.	Join the LRS VPSX/MFI and LRS PageCenterX EC2 instances to your AWS Managed Microsoft AD domain <a href="#">automatically</a> (AWS Knowledge Center documentation) or <a href="#">manually</a> (AWS Directory Service documentation).	Cloud architect

Task	Description	Skills required
Configure and integrate LRS/DIS with AWS Managed Microsoft AD for the LRS PageCenterX EC2 instance.	<ol style="list-style-type: none"><li>1. Connect to your LRS PageCenterX EC2 instance.</li><li>2. On the Windows <b>Start</b> menu, open <b>PCX Web Interface</b>.</li><li>3. In <b>Folder Explorer</b>, choose <b>Admin</b>.</li><li>4. On the <b>Configuration</b> page, in the <b>Security Parameters</b> section, for <b>Security Type</b>, select <b>LRS/DIS</b>.</li><li>5. Enter your preferences for the rest of the options in the Security Parameters section.</li><li>6. On the Windows <b>Start</b> menu, open the <b>PageCenterX</b> folder, choose <b>Server Start</b>, and then choose <b>Server Stop</b>.</li><li>7. Log in to LRS PageCenterX with your Active Directory username and password.</li></ol>	Cloud architect

Task	Description	Skills required
Configure an Import group to import output from LRS VPSX to LRS PageCenterX.	<ol style="list-style-type: none"><li>1. Connect to your LRS PageCenterX EC2 instance.</li><li>2. On the Windows <b>Start</b> menu, open <b>PCX Web Interface</b>.</li><li>3. In <b>Folder Explorer</b>, choose <b>Admin, Security admin, Groups</b>.</li><li>4. In the Groups section, choose <b>Add</b> to open the <b>Group preference</b> form.</li><li>5. In the Group preference form, enter values for <b>Group name</b> and <b>Description</b>.</li><li>6. Expand <b>General options</b>, and then select the <b>Import</b> check box.</li><li>7. To save the changes, choose <b>Ok</b>.</li></ol>	Cloud architect
Add a security rule to the Import group.	<ol style="list-style-type: none"><li>1. Open the context (right-click) menu for <b>Import group</b>.</li><li>2. Choose <b>Advance</b>, and then choose <b>Security</b>.</li><li>3. In the Security section, choose <b>Import</b>, and select the <b>Subfolder</b> check box.</li><li>4. To save the changes, choose <b>Apply</b>.</li></ol>	Cloud architect

Task	Description	Skills required
Create a user in LRS PageCenterX to perform output import from LRS VPSX/MFI.	<p>When you create a user in LRS PageCenterX to perform output import, the username should be the same as the <b>VPSX ID</b> of the print output queue in LRS VPSX/MFI. In this example, the VPSX ID is <b>VPS1</b>.</p> <ol style="list-style-type: none"><li>1. Connect to your LRS PageCenterX EC2 instance.</li><li>2. On the Windows <b>Start</b> menu, open <b>PCX Web Interface</b>.</li><li>3. In <b>Folder Explorer</b>, choose <b>Admin, Security admin, User</b>.</li><li>4. Choose <b>Add</b> to open the <b>User profile maintenance</b> form.</li><li>5. In User profile maintenance, for <b>User name</b>, enter <b>VPS1</b>.</li></ol>	Cloud architect

Task	Description	Skills required
Add the LRS PageCenterX Import user to the Import only group.	<p>To provide necessary permission for document import from LRS VPSX to LRS PageCenterX, do the following:</p> <ol style="list-style-type: none"><li>1. Connect to your LRS PageCenterX EC2 instance.</li><li>2. On the Windows <b>Start</b> menu, open <b>PCX Web Interface</b>.</li><li>3. In <b>Folder Explorer</b>, choose <b>Admin, Security admin, Groups</b>.</li><li>4. In the Groups section, open the context (right-click) menu for the <b>Import only</b> group, and then choose <b>Advance, Security</b>.</li><li>5. On the <b>Folder Security Records (ImportOnly)</b> page, choose the <b>User</b> tab.</li><li>6. On the User tab, under <b>Name</b>, select user <b>VPS1</b> from the dropdown list, and choose <b>Apply</b>.</li></ol>	Cloud architect

Task	Description	Skills required
Configure LRS/DIS with AWS Managed Microsoft AD for the LRS VPSX/MFI EC2 instance.	<ol style="list-style-type: none"><li>1. Connect to your LRS VPSX/MFI EC2 instance.</li><li>2. On the Windows <b>Start</b> menu, open <b>VPSX Web Interface</b>.</li><li>3. In the navigation pane, choose <b>Security</b>, and then choose <b>Configure</b>.</li><li>4. On the <b>Security Configuration</b> page, in the <b>Security Parameters</b> section, for <b>Security Type</b>, select <b>LRS/DIS (External)</b>.</li><li>5. Enter your preferences for the rest of the options in the Security Parameters section.</li><li>6. On the Windows <b>Start</b> menu, open the <b>LRS Output Management</b> folder, choose <b>Server Start</b>, and then choose <b>Server Stop</b>.</li><li>7. Log in to LRS VPSX/MFI with your Active Directory username and password.</li></ol>	Cloud architect

## Configure Amazon FSx for Windows File Server as the operational data store for LRS PageCenterX

Task	Description	Skills required
Create a file system for LRS PageCenterX.	To use Amazon FSx for Windows File Server as an operational data store for LRS PageCenterX in a Multi-AZ environment, follow the instructions in <a href="#">Step 1: Create your file system</a> .	Cloud architect
Map the file share to the LRS PageCenterX EC2 instance.	To map the file share created in previous step to the LRS PageCenterX EC2 instance, follow the instructions in <a href="#">Step 2: Map your file share to an EC2 instance running Windows Server</a> .	Cloud architect
Map LRS PageCenterX Control Directory and Master Folder Directory to the Amazon FSx network share drive.	<ol style="list-style-type: none"> <li>1. Connect to your LRS PageCenterX EC2 instance by following the instructions in the <a href="#">Amazon EC2 documentation</a>.</li> <li>2. On the Windows <b>Start</b> menu, open <b>PCX Web Interface</b>.</li> <li>3. In <b>Folder Explorer</b>, choose <b>Admin, Configuration</b>.</li> <li>4. On the Configuration page, choose <b>Directories</b>, and then choose <b>Control Directory</b>.</li> </ol>	Cloud architect



Task	Description	Skills required
	<p>5. In <b>Control Directories</b>, enter <code>\\FSx file share DNS name\share\cntl</code> .</p> <p>6. In <b>Master Folder Directory</b>, enter <code>\\FSx file share DNS name\share\mstr</code> .</p>	

### Test an output-management workflow

Task	Description	Skills required
Initiate a batch print request from the OpenText Micro Focus BankDemo app.	<ol style="list-style-type: none"> <li>1. Open the 3270-terminal emulator in your OpenText Micro Focus Enterprise Server EC2 instance.</li> <li>2. Connect to the BankDemo app by running the command <code>connect 127.0.0.1:9278</code> .</li> <li>3. On the BankDemo command line interface, for <b>User id</b>, enter <b>B0001</b>. For <b>Password</b>, enter a non-blank key.</li> <li>4. For the <b>Request printed statement(s)</b> option, enter <b>X</b> on the blank line.</li> <li>5. In the <b>Send statement by</b> section, for <b>Mail</b>, enter <b>Y</b>, and then press F10.</li> </ol>	Test engineer
Check the print output in LRS PageCenterX.	1. Connect to your LRS PageCenterX EC2 instance	Test engineer

Task	Description	Skills required
	<p>by following the instructions in the <a href="#">Amazon EC2 documentation</a>.</p> <ol style="list-style-type: none"> <li>2. On the Windows <b>Start</b> menu, open <b>PCX Web Interface</b>.</li> <li>3. In the navigation pane, open the <b>Test</b> folder, open the <b>STD</b> folder, and then open the folder with the job run date, such as 08-03-2023 (MM-DD-YY YY).</li> </ol> <p><b>Note:</b> This is the same folder structure as defined in the story <i>Create a rule to route the output document to a specific folder in LRS PageCenterX</i>.</p> <ol style="list-style-type: none"> <li>4. Open the <code>formtest-STD.txt</code> file.</li> </ol> <p>You can now see the print output of an account statement with columns for <b>Account No.</b>, <b>Description</b>, <b>Date</b>, <b>Amount</b>, and <b>Balance</b>. For an example, see the <code>batch_print_output</code> attachment for this pattern.</p>	

## Related resources

- [LRS](#)
- [Advanced Function Presentation data stream](#) (IBM documentation)
- [Line Conditioned Data Stream \(LCDS\)](#) (Compart documentation)
- [Micro Focus Enterprise Server on AWS](#) (AWS Quick Starts)
- [Empowering Enterprise Mainframe Workloads on AWS with Micro Focus](#) (blog post)
- [Modernize your mainframe online printing workloads on AWS](#) (AWS Prescriptive Guidance)
- [Modernize your mainframe batch printing workloads on AWS](#) (AWS Prescriptive Guidance)

## Additional information

### Considerations

During your modernization journey, you might consider a wide variety of configurations for mainframe batch and online processes and the output they generate. The mainframe platform has been customized by every customer and vendor that uses it with particular requirements that directly affect print. For example, your current platform might incorporate the IBM AFP data stream or Xerox LCDS into the current workflow. Additionally, [mainframe carriage control characters](#) and [channel command words](#) can affect the look of the printed page and might need special handling. As part of the modernization planning process, we recommend that you assess and understand the configurations in your specific print environment.

### Print data capture

OpenText Micro Focus Print Exit passes the necessary information for LRS VPSX/MFI to effectively process the spool file. The information consists of fields passed in the relevant control blocks, such as the following:

- JOBNAME
- OWNER (USERID)
- DESTINATION
- FORM
- FILENAME
- WRITER

LRS VPSX/MFI supports the following mainframe batch mechanisms for capturing data from OpenText Micro Focus Enterprise Server:

- BATCH COBOL print/spool processing using standard z/OS JCL SYSOUT DD/OUTPUT statements.
- BATCH COBOL print/spool processing using standard z/OS JCL CA-SPOOL SUBSYS DD statements.
- IMS/COBOL print/spool processing using the CBLTDLI interface. For a full list of supported methods and programming examples, see the LRS documentation that's included with your product license.

### Printer-fleet health checks

LRS VPSX/MFI (LRS LoadX) can perform deep dive health checks, including device management and operational optimization. Device management can detect failure in a printer device and route the print request to a healthy printer. For more information about deep-dive health checks for printer fleets, see the LRS documentation that's included with your product license.

### Print authentication and authorization

LRS/DIS enables LRS applications to authenticate user IDs and passwords by using Microsoft Active Directory or a Lightweight Directory Access Protocol (LDAP) server. In addition to basic print authorization, LRS/DIS can also apply granular-level print security controls in the following use cases:

- Manage who can browse the printer job.
- Manage the browsing level of other user's jobs.
- Manage operational tasks—for example, command-level security such as hold or release, purge, modify, copy, and reroute. Security can be set up by either the user-ID or the group, similar to an Active Directory security group or an LDAP group.

## Attachments

To access additional content that is associated with this document, unzip the following file: [attachment.zip](#)

# Modernize mainframe batch printing workloads on AWS by using Micro Focus Enterprise Server and LRS VPSX/MFI

Created by Shubham Roy (AWS), Abraham Rondon (Micro Focus), Guy Tucker (Levi, Ray and Shoup Inc), and Kevin Yung (AWS)

<b>Environment:</b> PoC or pilot	<b>Source:</b> IBM Mainframe	<b>Target:</b> AWS
<b>R Type:</b> Replatform	<b>Workload:</b> IBM	<b>Technologies:</b> Mainframe; Modernization
<b>AWS services:</b> AWS Managed Microsoft AD; Amazon EC2; Amazon S3; Amazon EBS		

## Summary

This pattern shows you how to modernize your business-critical mainframe batch printing workloads on the Amazon Web Services (AWS) Cloud by using Micro Focus Enterprise Server as a runtime for a modernized mainframe application and LRS VPSX/MFI (Micro Focus Interface) as a print server. The pattern is based on the [replatform](#) mainframe modernization approach. In this approach, you migrate your mainframe batch jobs to Amazon Elastic Compute Cloud (Amazon EC2) and migrate your mainframe database, such as IBM DB2 for z/OS, to Amazon Relational Database Service (Amazon RDS). The authentication and authorization for the modernized print workflow is performed by AWS Directory Service for Microsoft Active Directory, also known as AWS Managed Microsoft AD. The LRS Directory Information Server (LRS/DIS) is integrated with AWS Managed Microsoft AD. By modernizing your batch printing workloads, you can reduce IT infrastructure costs, mitigate the technical debt of maintaining legacy systems, remove data silos, increase agility and efficiency with a DevOps model, and take advantage of on-demand resources and automation in the AWS Cloud.

## Prerequisites and limitations

### Prerequisites

- An active AWS account

- A mainframe printing or output management workload
- Basic knowledge of how to rebuild and deliver a mainframe application that runs on Micro Focus Enterprise Server (For more information, see the [Enterprise Server](#) data sheet in the Micro Focus documentation.)
- Basic knowledge of LRS cloud printing solutions and concepts (For more information, see [Output Modernization](#) in the LRS documentation.)
- Micro Focus Enterprise Server software and license (For more information, contact [Micro Focus sales](#).)
- LRS VPSX/MFI, LRS/Queue, and LRS/DIS software and licenses (For more information, contact [LRS sales](#).)

**Note:** For more information about configuration considerations for mainframe batch printing workloads, see *Considerations* in the *Additional information* section of this pattern.

### Product versions

- [Micro Focus Enterprise Server](#) 6.0 (product update 7)
- [LRS VPSX/MFI](#) V1R3 or higher

## Architecture

### Source technology stack

- Operating system – IBM z/OS
- Programming language – Common Business-Oriented Language (COBOL), job control language (JCL), and Customer Information Control System (CICS)
- Database – IBM DB2 for z/OS and Virtual Storage Access Method (VSAM)
- Security – Resource Access Control Facility (RACF), CA Top Secret for z/OS, and Access Control Facility 2 (ACF2)
- Printing and output management – IBM mainframe z/OS printing products (IBM Tivoli Output Manager for z/OS, LRS, and CA View)

### Target technology stack

- Operating system – Microsoft Windows Server running on Amazon EC2

- Compute – Amazon EC2
- Programming language – COBOL, JCL, and CICS
- Database – Amazon RDS
- Security – AWS Managed Microsoft AD
- Printing and output management – LRS printing solution on AWS
- Mainframe runtime environment – Micro Focus Enterprise Server

## Source architecture

The following diagram shows a typical current state architecture for a mainframe batch printing workload:

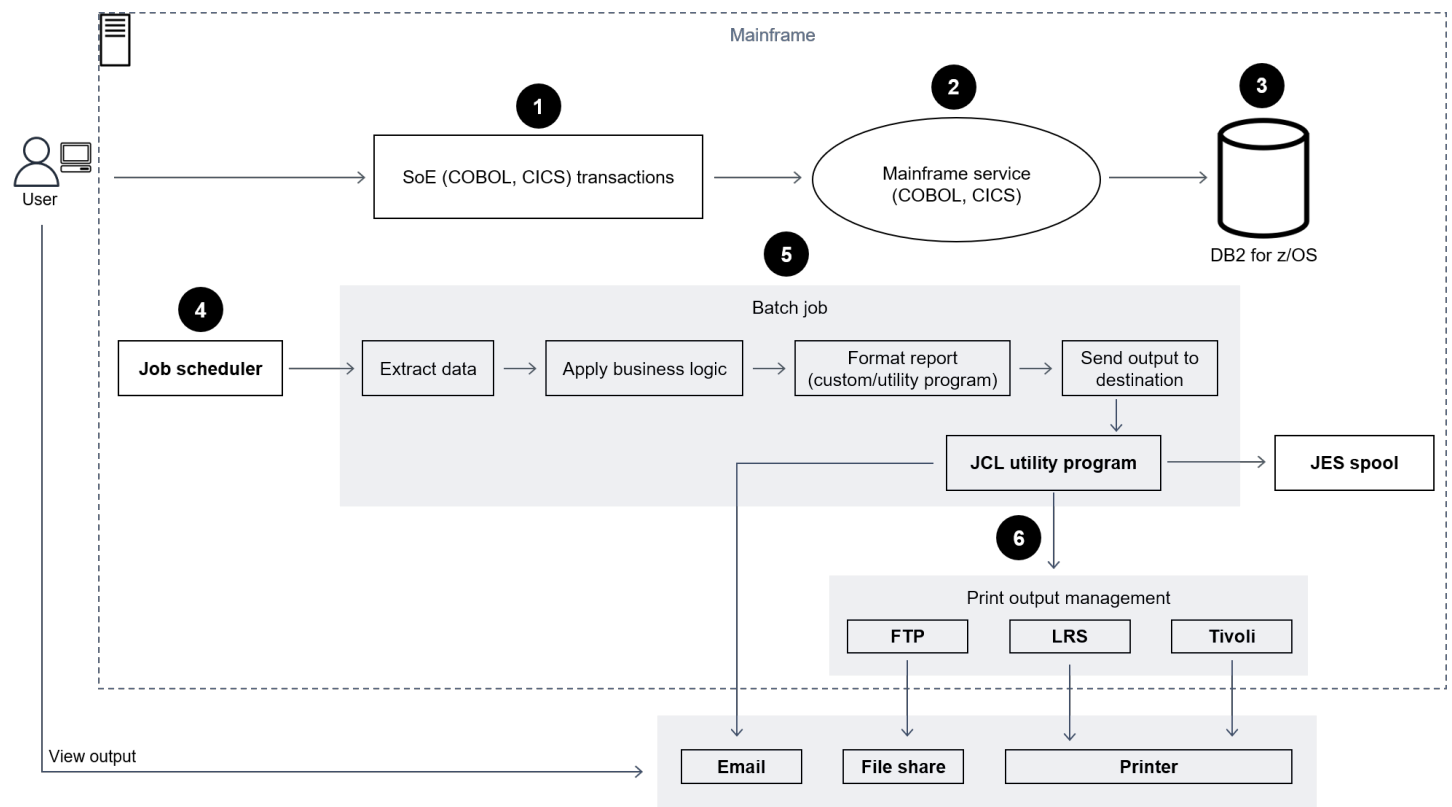

The diagram shows the following workflow:

1. Users perform business transactions on a system of engagement (SoE) that's built on an IBM CICS application written in COBOL.
2. The SoE invokes the mainframe service, which records the business transaction data in a system-of-records (SoR) database such as IBM DB2 for z/OS.

3. The SoR persists the business data from the SoE.
4. The batch job scheduler initiates a batch job to generate print output.
5. The batch job extracts data from the database, formats the data according to business requirements, and then generates business output such as billing statements, ID cards, or loan statements. Finally, the batch job routes the output to printing output management for processing and output delivery, based on the business requirements.
6. Printing output management receives print output from the batch job, and then delivers that output to a specified destination, such as email, a file share that uses secure FTP, a physical printer that uses LRS printing solutions (as demonstrated in this pattern), or IBM Tivoli.

## Target architecture

The following diagram shows an architecture for a mainframe batch printing workload that's deployed in the AWS Cloud:

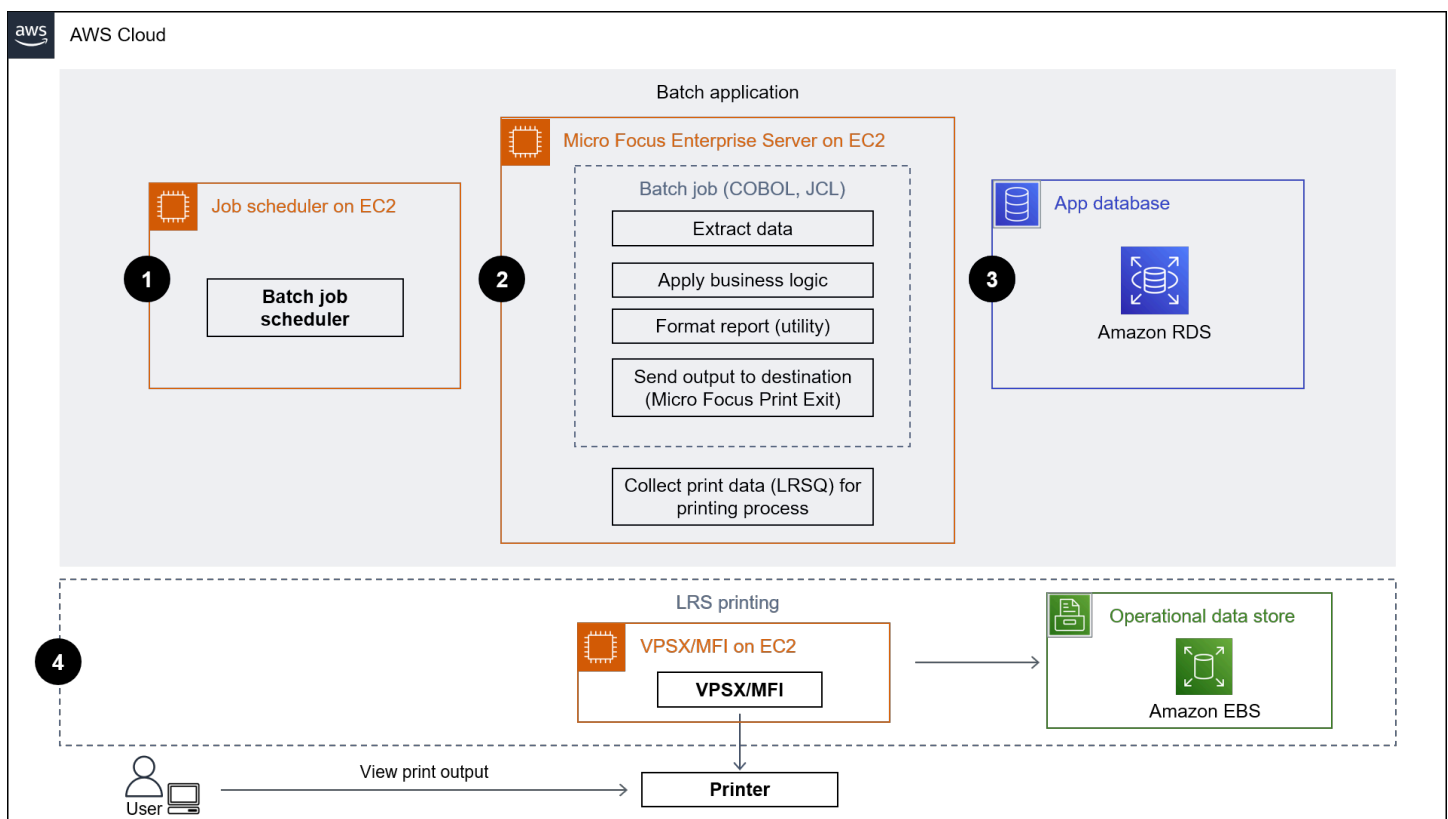

The diagram shows the following workflow:

1. The batch job scheduler initiates a batch job to create print output, such as billing statements, ID cards, or loan statements.



2. The mainframe batch job ([replatformed to Amazon EC2](#)) uses the Micro Focus Enterprise Server runtime to extract data from the application database, apply business logic to the data, format the data, and then send the data to a print destination by using [Micro Focus Print Exit](#) (Micro Focus documentation).
3. The application database (an SoR that runs on Amazon RDS) persists data for print output.
4. The LRS VPSX/MFI printing solution is deployed on Amazon EC2 and its operational data is stored in Amazon Elastic Block Store (Amazon EBS). LRS VPSX/MFI uses the TCP/IP-based LRS/Queue transmission agent to collect print data through the Micro Focus JES Print Exit API and deliver the data to a specified printer destination.

**Note:** The target solution typically doesn't require application changes to accommodate mainframe formatting languages, such as IBM Advanced Function Presentation (AFP) or Xerox Line Condition Data Stream (LCDS). For more information about using Micro Focus for mainframe application migration and modernization on AWS, see [Empowering Enterprise Mainframe Workloads on AWS with Micro Focus](#) in the AWS documentation.

### AWS infrastructure architecture

The following diagram shows a highly available and secure AWS infrastructure architecture for a mainframe batch printing workload:

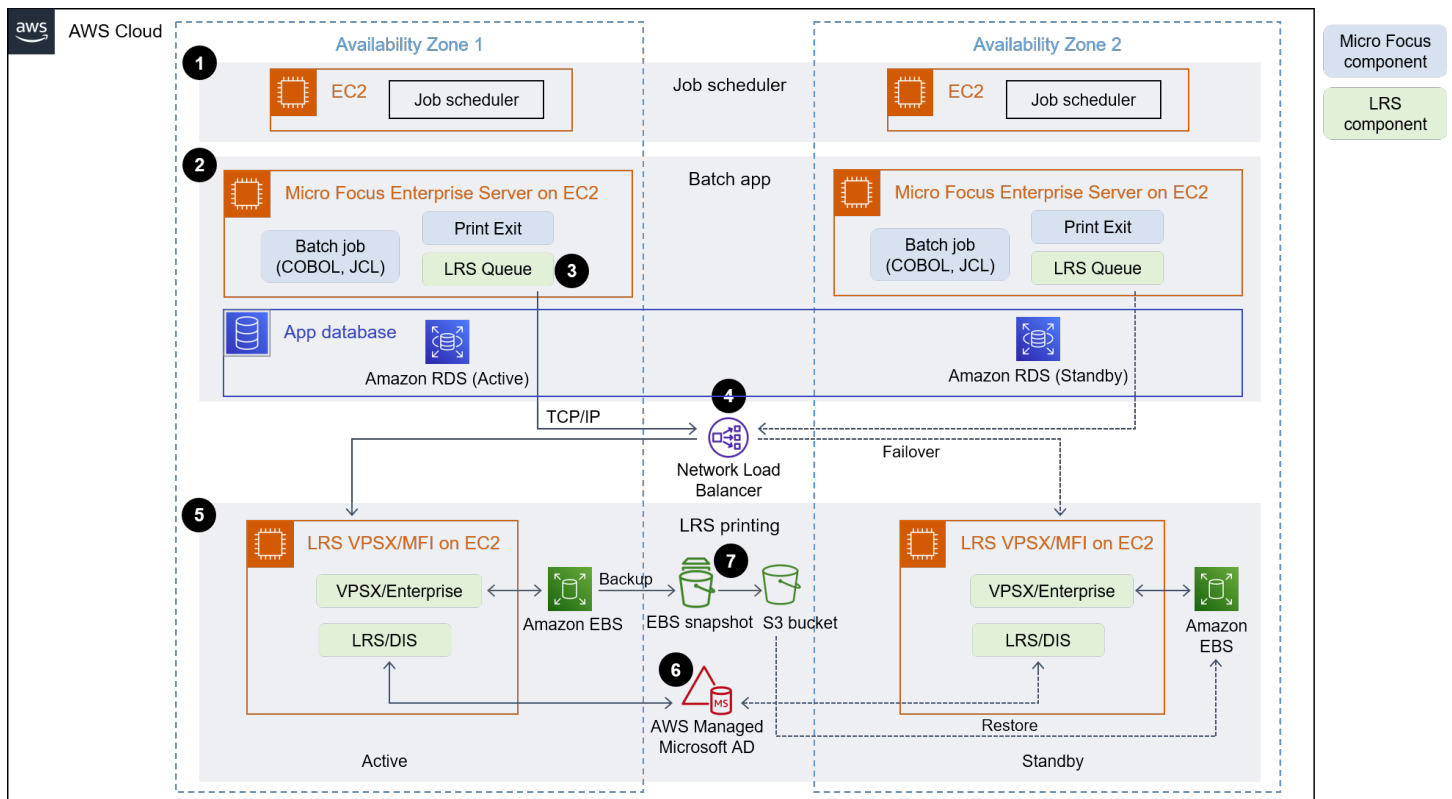

The diagram shows the following workflow:

1. The batch scheduler initiates the batch process and is deployed on Amazon EC2 across multiple [Availability Zones](#) for high availability (HA). **Note:** This pattern doesn't cover the implementation of the batch scheduler. For more information about implementation, see the software vendor documentation for your scheduler.
2. The mainframe batch job (written on a programming language such as JCL or COBOL) uses core business logic to process and generate print output, such as billing statements, ID cards, and loan statements. The job is deployed on Amazon EC2 across two Availability Zones for HA and uses Micro Focus Print Exit to route print output to LRS VPSX/MFI for end-user printing.
3. LRS VPSX/MFI uses a TCP/IP-based LRS/Queue transmission agent to collect or capture print data from the Micro Focus JES Print Exit programming interface. Print Exit passes the necessary information to enable LRS VPSX/MFI to effectively process the spool file and dynamically build LRS/Queue commands. The commands are then run using a standard built-in function from Micro Focus. **Note:** For more information on print data passed from Micro Focus Print Exit to LRS/Queue and LRS VPSX/MFI supported mainframe batch mechanisms, see *Print data capture* in the *Additional information* section of this pattern.
4. A [Network Load Balancer](#) provides a DNS name to integrate Micro Focus Enterprise Server with LRS VPSX/MFI. **Note:** LRS VPSX/MFI supports a Layer 4 load balancer. The Network Load

Balancer also does a basic health check on LRS VPSX/MFI and routes traffic to the registered targets that are healthy.

5. The LRS VPSX/MFI print server is deployed on Amazon EC2 across two Availability Zones for HA and uses [Amazon EBS](#) as an operational data store. LRS VPSX/MFI supports both the active-active and active-passive service modes. This architecture uses multiple AZs in an active-passive pair as an active and hot standby. The Network Load Balancer performs a health check on LRS VPSX/MFI EC2 instances and routes traffic to hot standby instances in the other AZ if an active instance is in an unhealthy state. The print requests are persisted in the LRS Job Queue locally in each of the EC2 instances. In the event of recovery, a failed instance has to be restarted for the LRS services to resume processing the print request. **Note:** LRS VPSX/MFI can also perform health checks at the printer fleet level. For more information, see *Printer fleet health checks* in the *Additional information* section of this pattern.
6. [AWS Managed Microsoft AD](#) integrates with LRS/DIS to perform print workflow authentication and authorization. For more information, see *Print authentication and authorization* in the *Additional information* section of this pattern.
7. LRS VPSX/MFI uses Amazon EBS for block storage. You can back up Amazon EBS data from active EC2 instances to Amazon S3 as point-in-time snapshots and restore them to hot standby EBS volumes. To automate the creation, retention, and deletion of Amazon EBS volume snapshots, you can use [Amazon Data Lifecycle Manager](#) to set the frequency of automated snapshots and restore them based on your [RTO/RPO requirements](#).

## Tools

### AWS services

- [Amazon EBS](#) – Amazon Elastic Block Store (Amazon EBS) provides block level storage volumes for use with EC2 instances. EBS volumes behave like raw, unformatted block devices. You can mount these volumes as devices on your instances.
- [Amazon EC2](#) – Amazon Elastic Compute Cloud (Amazon EC2) provides scalable computing capacity in the AWS Cloud. You can use Amazon EC2 to launch as many or as few virtual servers as you need, and you can scale out or scale in.
- [Amazon RDS](#) – Amazon Relational Database Service (Amazon RDS) is a web service that makes it easier to set up, operate, and scale a relational database in the AWS Cloud. It provides cost-efficient, resizable capacity for a relational database and manages common database administration tasks.

- [AWS Managed Microsoft AD](#) – AWS Directory Service for Microsoft Active Directory, also known as AWS Managed Microsoft Active Directory, enables your directory-aware workloads and AWS resources to use managed Active Directory in AWS.

## Other tools

- [LRS VPSX/MFI \(Micro Focus Interface\)](#) – VPSX/MFI, co-developed by LRS and Micro Focus, captures output from a Micro Focus Enterprise Server JES spool and reliably delivers it to a specified print destination.
- LRS Directory Information Server (LRS/DIS) – LRS/DIS is used for authentication and authorization during the print workflow.
- LRS/Queue – LRS VPSX/MFI uses a TCP/IP-based LRS/Queue transmission agent to collect or capture print data through the Micro Focus JES Print Exit programming interface.
- [Micro Focus Enterprise Server](#) – Micro Focus Enterprise Server is an application deployment environment for mainframe applications. It provides the execution environment for mainframe applications that are migrated or created by using any version of Micro Focus Enterprise Developer.

## Epics

### Set up Micro Focus Enterprise Server on Amazon EC2 and deploy a mainframe batch application

Task	Description	Skills required
Set up Micro Focus Enterprise Server and deploy a demo application.	Set up Micro Focus Enterprise Server on Amazon EC2, and then deploy the Micro Focus BankDemo demonstration application on Amazon EC2 by following the instructions in the <a href="#">Micro Focus Enterprise Server on AWS</a> Quick Start deployment guide.  The BankDemo application is a mainframe batch applicati	Cloud architect

Task	Description	Skills required
	on that creates and then initiates print output.	

## Set up an LRS print server on Amazon EC2

Task	Description	Skills required
Get an LRS product license for printing.	To get an LRS product license for LRS VPSX/MFI, LRS/Queue, and LRS/DIS, contact the <a href="#">LRS Output Management team</a> . You must provide the host names of the EC2 instances where the LRS products will be installed.	Build lead
Create an Amazon EC2 Windows instance to install LRS VPSX/MFI.	Launch an Amazon EC2 Windows instance by following the instructions from <a href="#">Step 1: Launch an instance</a> in the Amazon EC2 documentation. Your instance must meet the following hardware and software requirements for LRS VPSX/MFI: <ul style="list-style-type: none"> <li>• CPU – Dual Core</li> <li>• RAM – 16 GB</li> <li>• Drive – 500 GB</li> <li>• Minimum EC2 instance – m5.xlarge</li> <li>• OS – Windows/Linux</li> </ul>	Cloud architect

Task	Description	Skills required
	<ul style="list-style-type: none"><li>• Software – Internet Information Service (IIS) or Apache</li></ul> <p><b>Note:</b> The preceding hardware and software requirements are intended for a small printer fleet (around 500–1000). To get the full requirements, consult with your LRS and AWS contacts.</p> <p>When you create your Windows instance, do the following:</p> <ol style="list-style-type: none"><li>1. Confirm that the EC2 host name is the same host name used for the LRS product license.</li><li>2. Enable CGI in Amazon EC2 by completing the following:<ol style="list-style-type: none"><li>a. Connect to your EC2 instance by following the instructions from <a href="#">Step 2: Connect to your instance</a> in the Amazon EC2 documentation.</li><li>b. In the Windows Start menu, find and open Server Manager.</li><li>c. In Server Manager, choose <b>Dashboard</b>,</li></ol></li></ol>	

Task	Description	Skills required
	<p><b>Quick Start, Add roles and features.</b> Then, choose <b>Server roles</b>.</p> <p>d. In <b>Server roles</b>, choose <b>WebServer (IIS)</b>, and then choose <b>Application Development</b>.</p> <p>e. In <b>Application Development</b>, select the <b>CGI</b> check box.</p> <p>f. Follow the instructions on the Windows Server Manger <b>Add roles and features</b> wizard to install CGI.</p> <p>g. Open port 5500 in the Windows firewall of the EC2 instance for LRS/ Queue communication.</p>	

Task	Description	Skills required
Install LRS VPSX/MFI on the EC2 instance.	<ol style="list-style-type: none"><li>1. Connect to your EC2 instance by following the instructions from <a href="#">Step 2: Connect to your instance</a> in the Amazon EC2 documentation.</li><li>2. Open the link to the product download page from the LRS email that you should receive. <b>Note:</b> LRS products are distributed by electronic file transfer (EFT).</li><li>3. Download LRS VPSX/MFI and unzip the file (default folder: c:\LRS).</li><li>4. Launch the LRS Product Installer from the unzipped folder to install LRS VPSX/MFI.</li><li>5. In the <b>Select Features</b> menu, select <b>VPSX® Server (V1R3.022)</b>, and then choose <b>Next</b> to start the installation process. You will receive a success message when installation is complete.</li></ol>	Cloud architect



Task	Description	Skills required
Install LRS/Queue.	<ol style="list-style-type: none"><li data-bbox="592 226 1026 548">1. Connect to your Micro Focus Enterprise Server EC2 instance by following the instructions from <a href="#">Step 2: Connect to your instance</a> in the Amazon EC2 documentation.</li><li data-bbox="592 569 1026 842">2. Open the link to the LRS product download page from the LRS email that you should receive, download LRS/Queue, and then unzip the file.</li><li data-bbox="592 863 1026 1087">3. Go to the location where you downloaded the files, and then launch the LRS product installer to install LRS/Queue.</li></ol>	Cloud architect

Task	Description	Skills required
Install LRS/DIS.	<ol style="list-style-type: none"><li data-bbox="594 226 1000 548">1. Connect to your LRS VPSX/MFI EC2 instance by following the instructions from <a href="#">Step 2: Connect to your instance</a> in the Amazon EC2 documentation.</li><li data-bbox="594 569 1000 842">2. Open the link to the LRS product download page from the LRS email that you should receive, download LRS/DIS, and then unzip the file.</li><li data-bbox="594 863 1000 1041">3. Go to the location where you downloaded the files, and then launch the LRS Product Installer.</li><li data-bbox="594 1062 1000 1241">4. In the LRS Product Installer , expand <b>LRS Misc Tools</b>, select <b>LRS DIS</b>, and then choose <b>Next</b>.</li><li data-bbox="594 1262 1000 1482">5. Follow the rest of the instructions in the LRS Product Installer to complete the installation process.</li></ol>	Cloud architect

Task	Description	Skills required
Create a target group and register LRS VPSX/MFI EC2 as the target.	<p>Create a target group by following the instructions from <a href="#">Create a target group for your Network Load Balancer</a> in the Elastic Load Balancing documentation.</p> <p>When you create the target group, do the following:</p> <ol style="list-style-type: none"><li>1. On the <b>Specify group details</b> page, for <b>Choose a Target Type</b>, choose <b>Instances</b>.</li><li>2. For <b>Protocol</b>, choose <b>TCP</b>.</li><li>3. For <b>Port</b>, choose <b>5500</b>.</li><li>4. On the <b>Register targets</b> page, in the <b>Available instances</b> section, select the LRS VPSX/MFI EC2 instances.</li></ol>	Cloud architect

Task	Description	Skills required
<p>Create a Network Load Balancer.</p>	<p>Follow the instructions from <a href="#">Create a Network Load Balancer</a> in the Elastic Load Balancing documentation. Your Network Load Balancer routes traffic from Micro Focus Enterprise Server to LRS VPSX/MFI EC2.</p> <p>When you create the Network Load Balancer, do the following on the <b>Listeners and Routing</b> page:</p> <ol style="list-style-type: none"> <li>1. For <b>Protocol</b>, choose <b>TCP</b>.</li> <li>2. For <b>Port</b>, choose <b>5500</b>.</li> <li>3. For <b>Default action</b>, choose <b>Forward to</b> for the target group that you created earlier.</li> </ol>	<p>Cloud architect</p>

### Integrate Micro Focus Enterprise Server with LRS VPSX/MFI and LRS/Queue

Task	Description	Skills required
<p>Configure Micro Focus Enterprise Server for LRS/Queue integration.</p>	<ol style="list-style-type: none"> <li>1. Connect to your Micro Focus Enterprise Server EC2 instance by following the instructions from <a href="#">Step 2: Connect to your instance</a> in the Amazon EC2 documentation.</li> <li>2. In the Windows Start menu, open the Micro</li> </ol>	<p>Cloud architect</p>

Task	Description	Skills required
	<p>Focus Enterprise Server Administration UI.</p> <ol style="list-style-type: none"><li data-bbox="592 310 979 394">3. In the menu bar, choose <b>NATIVE</b>.</li><li data-bbox="592 415 984 594">4. In the navigation pane, choose <b>Directory Server</b>, and then choose <b>BANKDEMO</b>.</li><li data-bbox="592 615 1019 989">5. From <b>General</b> in the left navigation pane, scroll down to the <b>Additional</b> section to configure the environment variables (LRSQ_ADDRESS, LRSQ_PORT, LRSQ_COMMAND) to point to LRSQ.</li><li data-bbox="592 1010 1019 1234">6. For <b>LRSQ_ADDRESS</b>, enter the IP address or DNS name of the Network Load Balancer that you created earlier.</li><li data-bbox="592 1255 1003 1388">7. For <b>LRSQ_PORT</b>, enter <b>VPSX LRSQ Listener Port (5500)</b>.</li><li data-bbox="592 1409 1003 1541">8. For <b>LRSQ_COMMAND</b>, enter the path location of the LRSQ executable.</li></ol> <p><b>Note:</b> LRS currently supports a maximum character limit of 50 for DNS names, but this is subject to change in the future. If your DNS name</p>	

Task	Description	Skills required
	is greater than 50, then you can use the IP address of the Network Load Balancer as an alternative.	

Task	Description	Skills required
Configure Micro Focus Enterprise Server for LRS VPSX/MFI integration.	<ol style="list-style-type: none"><li>1. Copy the VPSX_MFI_R2 folder from the LRS VPSX/MFI installer to the Micro Focus Enterprise Server location at C:\BANKDEMO\print.</li><li>2. Connect to your Micro Focus Enterprise Server EC2 instance by following the instructions from <a href="#">Step 2: Connect to your instance</a> in the Amazon EC2 documentation.</li><li>3. In the Windows Start menu, open the Micro Focus Enterprise Server Administration UI.</li><li>4. In the menu bar, choose <b>NATIVE</b>.</li><li>5. In the navigation pane, choose <b>Directory Server</b>, and then choose <b>BANKDEMO</b>.</li><li>6. Under <b>BANKDEMO</b>, choose <b>JES</b>.</li><li>7. Under <b>JES Program Path</b>, add the DLL (VPSX_MFI_R2) path from the C:\BANKDEMO\print location.</li></ol>	Cloud architect

## Set up printers and print users in Micro Focus Enterprise Server and LRS VPSX/MFI

Task	Description	Skills required
Associate the Micro Focus Print Exit module to the Micro Focus Enterprise Server batch printer Server Execution Process.	<ol style="list-style-type: none"><li>1. Connect to your Micro Focus Enterprise Server EC2 instance by following the instructions from <a href="#">Step 2: Connect to your instance</a> in the Amazon EC2 documentation.</li><li>2. In the Windows Start menu, open the Micro Focus Enterprise Server Administration UI.</li><li>3. In the menu bar, choose <b>NATIVE</b>.</li><li>4. In the navigation pane, choose <b>Directory Server</b>, and then choose <b>BANKDEMO</b>.</li><li>5. Under <b>BANKDEMO</b>, choose <b>JES</b>, and scroll down to <b>Printers</b>.</li><li>6. In <b>Printers</b>, associate the Micro Focus Print Exit module (LRSPRTE6 for Batch) to the Micro Focus Enterprise Server batch printer Server Execution Process (SEP). This allows print output routing to LRS VPSX/MFI.</li><li>7. Sign in to the Enterprise Server Administration UI.</li></ol>	Cloud architect



Task	Description	Skills required
	For more information about configuration, see <a href="#">Using the Exit</a> in the Micro Focus documentation.	

Task	Description	Skills required
Add a printer in LRS VPSX/MFI.	<ol style="list-style-type: none"><li>1. Connect to your LRS VPSX/MFI EC2 instance by following the instructions from <a href="#">Step 2: Connect to your instance</a> in the Amazon EC2 documentation.</li><li>2. Open the VPSX Web Interface from the Windows Start menu.</li><li>3. In the navigation pane, choose <b>Printers</b>.</li><li>4. Choose <b>Add</b>, and then choose <b>Add Printer</b>.</li><li>5. On the <b>Printer Configuration</b> page, for <b>Printer Name</b>, enter <b>Local</b>.</li><li>6. For <b>VPSX ID</b>, enter <b>VPS1</b>.</li><li>7. For <b>CommType</b>, select <b>TCPIP/LRSQ</b>.</li><li>8. For <b>Host/IP Address</b>, enter the IP address of the physical printer that you want to add.</li><li>9. For <b>Device</b>, enter the name of your device.</li><li>10 Choose either <b>Windows Driver</b> or <b>Linux/Mac Driver</b>.</li><li>11 Choose <b>Add</b>.</li></ol>	Cloud architect

Task	Description	Skills required
Create a print user in LRS VPSX/MFI.	<ol style="list-style-type: none"><li>1. Connect to your LRS VPSX/MFI EC2 instance by following the instructions from <a href="#">Step 2: Connect to your instance</a> in the Amazon EC2 documentation.</li><li>2. Open the VPSX Web Interface from the Windows Start menu.</li><li>3. In the navigation pane, choose <b>Security</b>, and then choose <b>Users</b>.</li><li>4. In the <b>User Name</b> column, choose <b>admin</b>, and then choose <b>Copy</b>.</li><li>5. In the <b>User Profile Maintenance</b> window, for <b>User Name</b>, enter a user name (for example, <b>PrintUser</b>).</li><li>6. For <b>Description</b>, enter a brief description (for example, <b>User for test print</b>).</li><li>7. Choose <b>Update</b>. This creates a print user (for example, <b>PrintUser</b>).</li><li>8. In the navigation pane, under <b>User</b>, choose the new user that you created.</li><li>9. From the <b>Command</b> menu, choose <b>Security</b>.</li></ol>	Cloud architect

Task	Description	Skills required
	<p>10 On the <b>Security Rules</b> page, choose all the applicable printer security and job security options, and then choose <b>Save</b>.</p> <p>11 To add your new print user to the <b>Administrator</b> group, go to the navigation pane, choose <b>Security</b>, and then choose <b>Configure</b>.</p> <p>12 In the <b>Security configuration</b> window, add your new print user to the <b>Administrator</b> column.</p>	

## Set up print authentication and authorization

Task	Description	Skills required
Create an AWS Managed Microsoft AD domain with users and groups.	<ol style="list-style-type: none"> <li>1. Create an Active Directory on AWS Managed Microsoft AD by following the instructions from <a href="#">Create your AWS Managed Microsoft AD directory</a> in the AWS Directory Service documentation.</li> <li>2. Deploy an EC2 instance (Active Directory manager) and install Active Directory tools to manage your AWS Managed Microsoft AD by following the instructions from <a href="#">Step 3: Deploy an EC2</a></li> </ol>	Cloud architect

Task	Description	Skills required
	<p><a href="#">instance to manage your AWS Managed Microsoft AD</a> in the AWS Directory Service documentation.</p> <ol style="list-style-type: none"><li>3. Connect to your EC2 instance by following the instructions from <a href="#">Step 2: Connect to your instance</a> in the Amazon EC2 documentation. <b>Note:</b> When you connect to the EC2 instance, enter your administrator credentials (for the directory that you created in step one) in the Windows Security window.</li><li>4. In the Windows Start menu, under <b>Windows Administrative Tools</b>, choose <b>Active Directory Users and Computers</b>.</li><li>5. Create a print user in the Active Directory domain by following the steps from <a href="#">Create a user</a> in the AWS Directory service documentation.</li></ol>	

Task	Description	Skills required
Join LRS VPSX/MFI EC2 to an AWS Managed Microsoft AD domain.	Join LRS VPSX/MFI EC2 to your AWS Managed Microsoft AD domain <a href="#">automatically</a> (AWS Knowledge Center documentation) or <a href="#">manually</a> (AWS Directory Service documentation).	Cloud architect

Task	Description	Skills required
Configure and integrate LRS/DIS with AWS Managed Microsoft AD.	<ol style="list-style-type: none"><li data-bbox="592 226 1027 548">1. Connect to your LRS VPSX/MFI EC2 instance by following the instructions from <a href="#">Step 2: Connect to your instance</a> in the Amazon EC2 documentation.</li><li data-bbox="592 569 1027 695">2. In the Windows Start menu, open the VPSX Web Interface.</li><li data-bbox="592 716 1027 842">3. In the navigation pane, choose <b>Security</b>, and then choose <b>Configure</b>.</li><li data-bbox="592 863 1027 1094">4. On the <b>Security Configuration</b> page, in the <b>Security Parameters</b> section, for <b>Security Type</b>, select <b>Internal</b>.</li><li data-bbox="592 1115 1027 1283">5. Enter your preferences for the rest of the options in the <b>Security Parameters</b> section.</li><li data-bbox="592 1304 1027 1577">6. Open the <b>LRS Output Management</b> folder from the Microsoft Windows Start menu, choose <b>Server Start</b>, and then choose <b>Server Stop</b>.</li><li data-bbox="592 1598 1027 1745">7. Log in to LRS VPSX/MFI with your Active Directory user name and password.</li></ol>	Cloud architect

## Test a print workflow

Task	Description	Skills required
<p>Initiate a batch print request from the Micro Focus BankDemo app.</p>	<ol style="list-style-type: none"> <li>1. Open the 3270 terminal emulator in your Micro Focus Enterprise Server EC2 instance.</li> <li>2. Connect to the BankDemo app by running the following command: connect 127.0.0.1 :9278</li> <li>3. On the BankDemo command line interface, for <b>User id</b>, enter <b>B0001</b>. For <b>Password</b>, enter a non-blank key.</li> <li>4. For the <b>Request printed statement(s)</b> option, enter <b>X</b> on the blank line.</li> <li>5. In the <b>Send statement by</b> section, for <b>Mail</b>, enter <b>Y</b>, and then press F10.</li> </ol>	<p>Test engineer</p>
<p>Check the print output in LRS VPSX/MFI.</p>	<ol style="list-style-type: none"> <li>1. Connect to your LRS VPSX/MFI EC2 instance by following the instructions from <a href="#">Step 2: Connect to your instance</a> in the Amazon EC2 documentation.</li> <li>2. In Windows Start menu, open the VPSX Web Interface.</li> </ol>	<p>Test engineer</p>



Task	Description	Skills required
	<p>3. In the navigation pane, choose <b>Printers</b>, and then choose <b>Output Queue</b>.</p> <p>4. In the <b>Spool ID</b> column, choose the spool ID for the request in the printer queue.</p> <p>5. On the <b>Actions</b> tab, in the <b>COMMAND</b> column, choose <b>Browse</b>.</p> <p>You can now see the print output of an account statement with columns for <b>Account No.</b>, <b>Description</b>, <b>Date</b>, <b>Amount</b>, and <b>Balance</b>. For an example, see the <b>batch_print_output</b> attachment for this pattern.</p>	

## Related resources

- [LRS Output Modernization](#) (LRS documentation)
- [ANSI and machine carriage controls](#) (IBM documentation)
- [Channel command words](#) (IBM documentation)
- [Empowering Enterprise Mainframe Workloads on AWS with Micro Focus](#) (AWS Partner Network Blog)
- [Build a Micro Focus Enterprise Server PAC with Amazon EC2 Auto Scaling and Systems Manager](#) (AWS Prescriptive Guidance documentation)
- [Advanced Function Presentation \(AFP\) data stream](#) (IBM documentation)
- [Line Conditioned Data Stream \(LCDS\)](#) (Compart documentation)
- [Micro Focus Enterprise Server on AWS](#) (AWS Quick Starts)

## Additional information

### Considerations

During your modernization journey, you may consider a wide variety of configurations for both mainframe batch processes and the output they generate. The mainframe platform has been customized by every customer and vendor that uses it with particular requirements that directly affect print. For example, your current platform may incorporate the IBM Advanced Function Presentation (AFP) or the Xerox Line Condition Data Stream (LCDS) into the current workflow. Additionally, [mainframe carriage control characters](#) and [channel command words](#) can affect the look of the printed page and may need special handling. As part of the modernization planning process, we recommend that you assess and understand the configurations in your specific print environment.

### Print data capture

Micro Focus Print Exit passes the necessary information to enable LRS VPSX/MFI to effectively process the spool file. The information consists of fields passed in the relevant control blocks, such as:

- JOBNAME
- OWNER (USERID)
- DESTINATION
- FORM
- FILENAME
- WRITER

LRS VPSX/MFI supports the following mainframe batch mechanisms for capturing data from Micro Focus Enterprise Server.

- BATCH COBOL print/spool processing using standard z/OS JCL SYSOUT DD/OUTPUT statements
- BATCH COBOL print/spool processing using standard z/OS JCL CA-SPOOL SUBSYS DD statements
- IMS/COBOL print/spool processing using the CBLTDLI interface (For a full list of supported methods and programming examples, see the LRS documentation that's included with your product license.)

## Printer fleet health checks

LRS VPSX/MFI (LRS LoadX) can perform deep dive health checks, including device management and operational optimization. Device management can detect failure in a printer device and route the print request to a healthy printer. For more information about deep dive health checks for printer fleets, see the LRS documentation that's included with your product license.

## Print authentication and authorization

LRS/DIS enables LRS applications to authenticate user IDs and passwords by using Microsoft Active Directory or an LDAP server. In addition to basic print authorization, LRS/DIS can also apply granular-level print security controls in the following use cases:

- Manage who can browse the printer job.
- Manage the browsing level of other user's jobs.
- Manage operational tasks. For example, command-level security such as hold/release, purge, modify, copy, and reroute. Security can be set up by either the User-ID or Group (similar to AD group or LDAP group).

## Attachments

To access additional content that is associated with this document, unzip the following file: [attachment.zip](#)

# Modernize mainframe online printing workloads on AWS by using Micro Focus Enterprise Server and LRS VPSX/MFI

Created by Shubham Roy (AWS), Abraham Rondon (Micro Focus), Guy Tucker (Levi, Ray and Shoup Inc), and Kevin Yung (AWS)

<b>Environment:</b> PoC or pilot	<b>Source:</b> Mainframe	<b>Target:</b> AWS
<b>R Type:</b> Replatform	<b>Workload:</b> IBM	<b>Technologies:</b> Mainframe; Migration; Modernization

**AWS services:** AWS Managed Microsoft AD; Amazon EC2; Amazon RDS; Amazon EBS

## Summary

This pattern shows you how to modernize your business-critical mainframe online printing workloads on the Amazon Web Services (AWS) Cloud by using Micro Focus Enterprise Server as a runtime for a modernized mainframe application and LRS VPSX/MFI (Micro Focus Interface) as a print server. The pattern is based on the [replatform](#) mainframe modernization approach. In this approach, you migrate your mainframe online application to Amazon Elastic Compute Cloud (Amazon EC2) and migrate your mainframe database, such as IBM DB2 for z/OS, to Amazon Relational Database Service (Amazon RDS). The authentication and authorization for the modernized print workflow is performed by AWS Directory Service for Microsoft Active Directory, also known as AWS Managed Microsoft AD. The LRS Directory Information Server (LRS/DIS) is integrated with AWS Managed Microsoft AD for print workflow authentication and authorization. By modernizing your online printing workloads, you can reduce IT infrastructure costs, mitigate the technical debt of maintaining legacy systems, remove data silos, increase agility and efficiency with a DevOps model, and take advantage of on-demand resources and automation in the AWS Cloud.

## Prerequisites and limitations

### Prerequisites

- An active AWS account

- A mainframe online printing or output management workload
- Basic knowledge of how to rebuild and deliver a mainframe application that runs on Micro Focus Enterprise Server (For more information, see the [Enterprise Server](#) data sheet in the Micro Focus documentation.)
- Basic knowledge of LRS cloud printing solutions and concepts (For more information, see [Output Modernization](#) in the LRS documentation.)
- Micro Focus Enterprise Server software and license (For more information, contact [Micro Focus sales](#).)
- LRS VPSX/MFI, LRS/Queue, and LRS/DIS software and licenses (For more information, contact [LRS sales](#).)

**Note:** For more information about configuration considerations for mainframe online printing workloads, see *Considerations* in the *Additional information* section of this pattern.

### Product versions

- [Micro Focus Enterprise Server](#) 8.0 or later
- [LRS VPSX/MFI](#) V1R3 or later

## Architecture

### Source technology stack

- Operating system – IBM z/OS
- Programming language – Common Business-Oriented Language (COBOL) and Customer Information Control System (CICS)
- Database – IBM DB2 for z/OS IBM Information Management System (IMS) and Virtual Storage Access Method (VSAM)
- Security – Resource Access Control Facility (RACF), CA Top Secret for z/OS, and Access Control Facility 2 (ACF2)
- Printing and output management – IBM mainframe z/OS printing products (IBM Infoprint Server for z/OS, LRS, and CA View)

### Target technology stack

- Operating system – Microsoft Windows Server running on Amazon EC2
- Compute – Amazon EC2
- Programming language – COBOL and CICS
- Database – Amazon RDS
- Security – AWS Managed Microsoft AD
- Printing and output management – LRS printing solution on AWS
- Mainframe runtime environment – Micro Focus Enterprise Server

## Source architecture

The following diagram shows a typical current state architecture for a mainframe online printing workload.

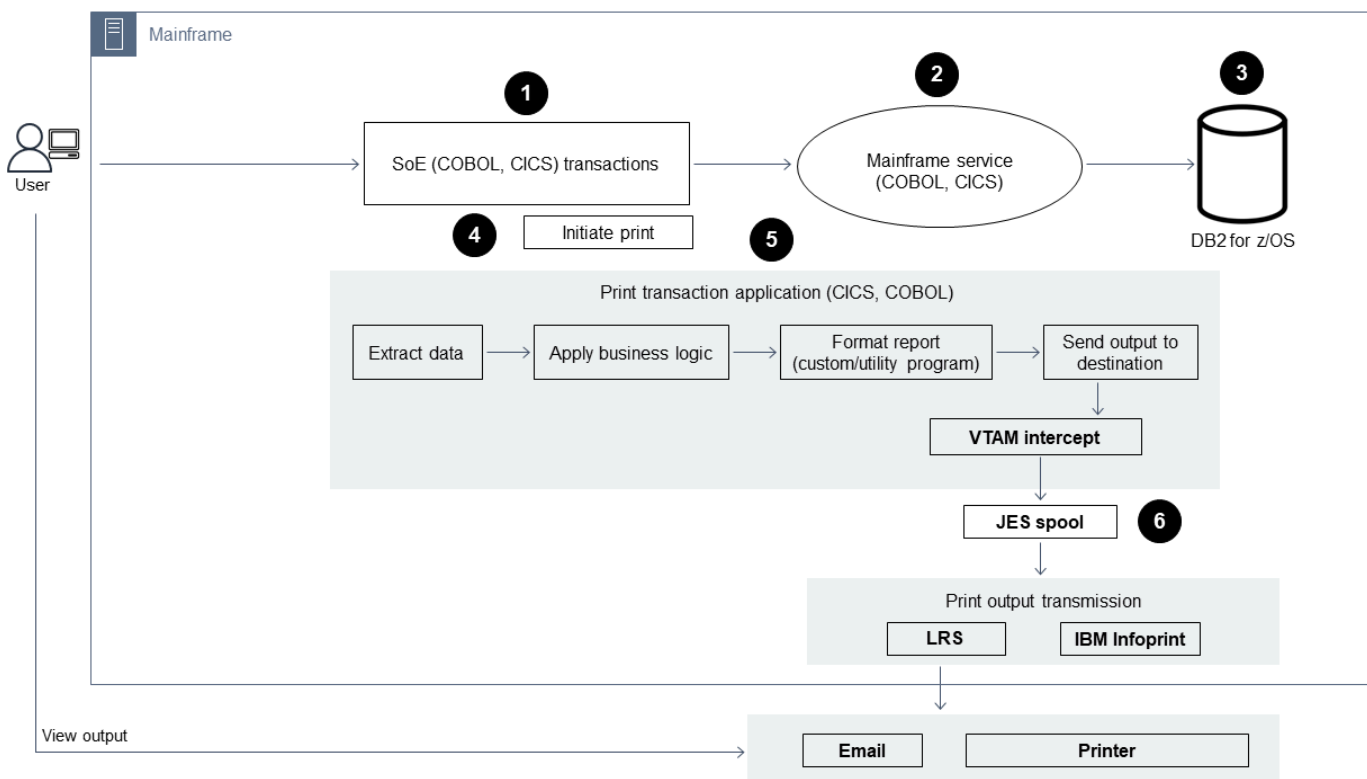

The diagram shows the following workflow:

1. Users perform business transactions on a system of engagement (SoE) that's built on an IBM CICS application written in COBOL.

2. The SoE invokes the mainframe service, which records the business transaction data in a system-of-records (SoR) database such as IBM DB2 for z/OS.
3. The SoR persists the business data from the SoE.
4. A user initiates a request to generate print output from the CICS SoE, which initiates a print transaction application to process the print request.
5. The print transaction application (such as a CICS and COBOL program) extracts data from the database, formats the data according to business requirements, and generates business output (print data) such as billing statements, ID cards, or loan statements. Then, the application sends a print request by using Virtual Telecommunications Access Method (VTAM). A z/OS print server (such as IBM Infoprint Server) uses NetSpool or a similar VTAM component to intercept the print requests, and then creates print output datasets on the JES spool by using JES output parameters. The JES output parameters specify routing information that the print server uses to transmit the output to a particular network printer. The term *VTAM* refers to the z/OS Communications Server and the System Network Architecture (SNA) services element of z/OS.
6. The printing output transmission component transmits the output print datasets from the JES spool to remote printers or print servers, such as LRS (as demonstrated in this pattern), IBM Infoprint Server, or email destinations.

## Target architecture

The following diagram shows an architecture for a mainframe online printing workload that's deployed in the AWS Cloud:

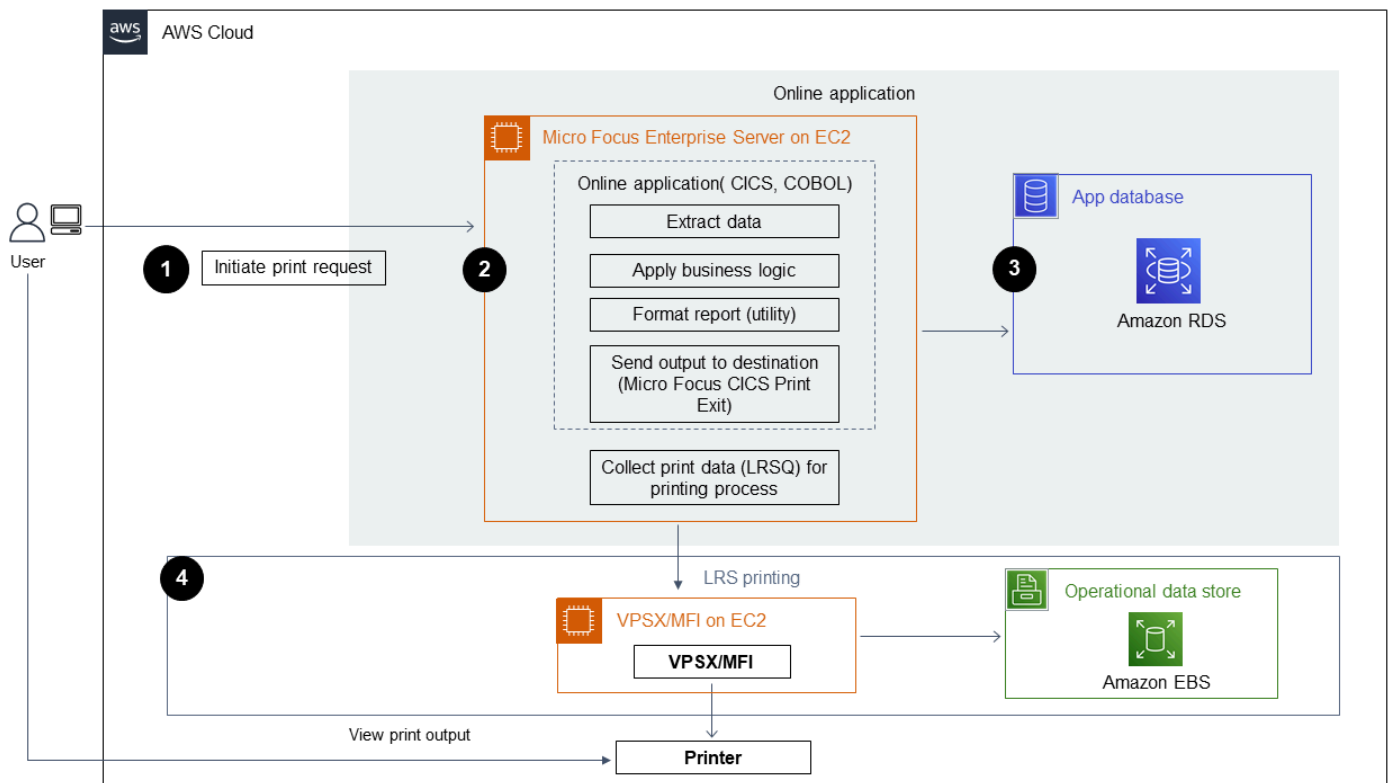

The diagram shows the following workflow:

1. A user initiates a print request from an online (CICS) user-interface to create print output, such as billing statements, ID cards, or loan statements.
2. The mainframe online application ([replatformed to Amazon EC2](#)) uses the Micro Focus Enterprise Server runtime to extract data from the application database, apply business logic to the data, format the data, and then send the data to a print destination by using [Micro Focus CICS Print Exit](#) (DFHUPRNT).
3. The application database (an SoR that runs on Amazon RDS) persists data for print output.
4. The LRS VPSX/MFI printing solution is deployed on Amazon EC2, and its operational data is stored in Amazon Elastic Block Store (Amazon EBS). LRS VPSX/MFI uses a TCP/IP-based LRS/Queue transmission agent to collect print data through the Micro Focus CICS Print Exit API (DFHUPRNT) and deliver the data to a specified printer destination. The original TERMID (TERM) that's used in the modernized CICS application is used as the VPSX/MFI Queue name.

**Note:** The target solution typically doesn't require application changes to accommodate mainframe formatting languages, such as IBM Advanced Function Presentation (AFP) or Xerox Line Condition Data Stream (LCDS). For more information about using Micro Focus for mainframe application



migration and modernization on AWS, see [Empowering Enterprise Mainframe Workloads on AWS with Micro Focus](#) in the AWS documentation.

## AWS infrastructure architecture

The following diagram shows a highly available and secure AWS infrastructure architecture for a mainframe online printing workload:

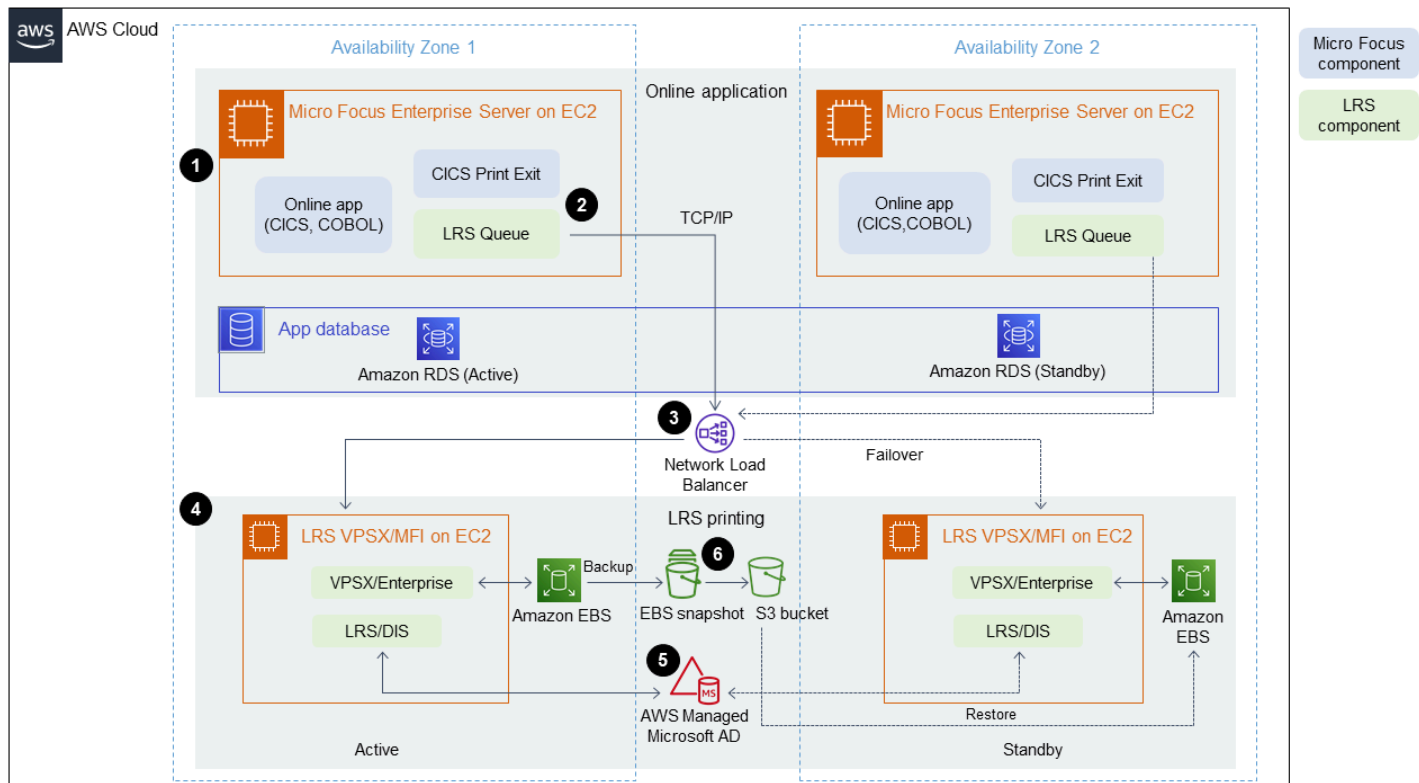

The diagram shows the following workflow:

1. The mainframe online application (written on a programming language such as CICS or COBOL) uses core business logic to process and generate print output, such as billing statements, ID cards, and loan statements. The online application is deployed on Amazon EC2 across two [Availability Zones](#) (AZ) for high availability (HA) and uses Micro Focus CICS Print Exit to route print output to LRS VPSX/MFI for end-user printing.
2. LRS VPSX/MFI uses a TCP/IP-based LRS/Queue transmission agent to collect or capture print data from the Micro Focus online Print Exit programming interface. Online Print Exit passes the necessary information to enable LRS VPSX/MFI to effectively process the print file and dynamically build LRS/Queue commands.

**Note:** For more information on various CICS application programming methods for print and how they are supported in Micro Focus Enterprise server and LRS VPSX/MFI, see *Print data capture* in the *Additional information* section of this pattern.

3. A [Network Load Balancer](#) provides a DNS name to integrate Micro Focus Enterprise Server with LRS VPSX/MFI. **Note:** LRS VPSX/MFI supports a Layer 4 load balancer. The Network Load Balancer also does a basic health check on LRS VPSX/MFI and routes traffic to the registered targets that are healthy.
4. The LRS VPSX/MFI print server is deployed on Amazon EC2 across two Availability Zones for HA and uses [Amazon EBS](#) as an operational data store. LRS VPSX/MFI supports both the active-active and active-passive service modes. This architecture uses multiple Availability Zones in an active-passive pair as an active and hot standby. The Network Load Balancer performs a health check on LRS VPSX/MFI EC2 instances and routes traffic to hot standby instances in another Availability Zone if an active instance is in an unhealthy state. The print requests are persisted in the LRS Job Queue locally in each of the EC2 instances. In the event of recovery, a failed instance has to be restarted for the LRS services to resume processing the print request.

**Note:** LRS VPSX/MFI can also perform health checks at the printer fleet level. For more information, see *Printer fleet health checks* in the *Additional information* section of this pattern.

5. [AWS Managed Microsoft AD](#) integrates with LRS/DIS to perform print workflow authentication and authorization. For more information, see *Print authentication and authorization* in the *Additional information* section of this pattern.
6. LRS VPSX/MFI uses Amazon EBS for block storage. You can back up Amazon EBS data from active EC2 instances to Amazon S3 as point-in-time snapshots and restore them to hot standby EBS volumes. To automate the creation, retention, and deletion of Amazon EBS volume snapshots, you can use [Amazon Data Lifecycle Manager](#) to set the frequency of automated snapshots and restore them based on your [RTO/RPO requirements](#).

## Tools

### AWS services

- [Amazon Elastic Block Store \(Amazon EBS\)](#) provides block-level storage volumes for use with Amazon EC2 instances. EBS volumes behave like raw, unformatted block devices. You can mount these volumes as devices on your instances.

- [Amazon Elastic Compute Cloud \(Amazon EC2\)](#) provides scalable computing capacity in the AWS Cloud. You can launch as many virtual servers as you need and quickly scale them up or down.
- [Amazon Relational Database Service \(Amazon RDS\)](#) helps you set up, operate, and scale a relational database in the AWS Cloud.
- [AWS Directory Service for Microsoft Active Directory \(AD\)](#), also known as AWS Managed Microsoft Active Directory, enables your directory-aware workloads and AWS resources to use managed Active Directory in AWS.

## Other tools

- [LRS VPSX/MFI \(Micro Focus Interface\)](#), co-developed by LRS and Micro Focus, captures output from a Micro Focus Enterprise Server JES spool and reliably delivers it to a specified print destination.
- LRS Directory Information Server (LRS/DIS) is used for authentication and authorization during the print workflow.
- LRS/Queue is a TCP/IP-based LRS/Queue transmission agent, used by LRS VPSX/MFI, to collect or capture print data through the Micro Focus online Print Exit programming interface.
- [Micro Focus Enterprise Server](#) is an application deployment environment for mainframe applications. It provides the execution environment for mainframe applications that are migrated or created by using any version of Micro Focus Enterprise Developer.

## Epics

### Set up Micro Focus Enterprise Server on Amazon EC2 and deploy a mainframe online application

Task	Description	Skills required
Set up Micro Focus Enterprise Server and deploy a demo online application.	Set up Micro Focus Enterprise Server on Amazon EC2, and then deploy the Micro Focus Account Demo application (ACCT Demo) on Amazon EC2 by following the instructions from <a href="#">Tutorial: CICS Support</a>	Cloud architect

Task	Description	Skills required
	<p>in the Micro Focus documentation.</p> <p>The ACCT Demo application is a mainframe online (CICS) application that creates and then initiates print output.</p>	

## Set up an LRS print server on Amazon EC2

Task	Description	Skills required
Get an LRS product license for printing.	To get an LRS product license for LRS VPSX/MFI, LRS/Queue, and LRS/DIS, contact the <a href="#">LRS Output Management team</a> . You must provide the host names of the EC2 instances where the LRS products will be installed.	Build lead
Create an Amazon EC2 Windows instance to install LRS VPSX/MFI.	<p>Launch an Amazon EC2 Windows instance by following the instructions from <a href="#">Step 1: Launch an instance</a> in the Amazon EC2 documentation. Your instance must meet the following hardware and software requirements for LRS VPSX/MFI:</p> <ul style="list-style-type: none"> <li>• CPU – Dual Core</li> <li>• RAM – 16 GB</li> <li>• Drive – 500 GB</li> </ul>	Cloud architect

Task	Description	Skills required
	<ul style="list-style-type: none"><li>• Minimum EC2 instance – m5.xlarge</li><li>• OS – Windows/Linux</li><li>• Software – Internet Information Service (IIS) or Apache</li></ul> <p><b>Note:</b> The preceding hardware and software requirements are intended for a small printer fleet (around 500–1000). To get the full requirements, consult with your LRS and AWS contacts.</p> <p>When you create your Windows instance, do the following:</p> <ol style="list-style-type: none"><li>1. Confirm that the EC2 host name is the same host name used for the LRS product license.</li><li>2. Enable CGI in Amazon EC2 by completing the following:<ol style="list-style-type: none"><li>a. Connect to your EC2 instance by following the instructions from <a href="#">Step 2: Connect to your instance</a> in the Amazon EC2 documentation.</li></ol></li></ol>	

Task	Description	Skills required
	<ul style="list-style-type: none"><li>b. In the Windows Start menu, find and open Server Manager.</li><li>c. In Server Manager, choose <b>Dashboard, Quick Start, Add roles and features</b>. Then, choose <b>Server roles</b>.</li><li>d. In <b>Server roles</b>, choose <b>WebServer (IIS)</b>, and then choose <b>Application Development</b>.</li><li>e. In <b>Application Development</b>, select the <b>CGI</b> check box.</li><li>f. Follow the instructions on the Windows Server Manager <b>Add roles and features</b> wizard to install CGI.</li><li>g. Open port 5500 in the Windows firewall of the EC2 instance for LRS/ Queue communication.</li></ul>	

Task	Description	Skills required
Install LRS VPSX/MFI on the EC2 instance.	<ol style="list-style-type: none"><li data-bbox="592 226 1027 499">1. Connect to your EC2 instance by following the instructions from <a href="#">Step 2: Connect to your instance</a> in the Amazon EC2 documentation.</li><li data-bbox="592 520 1027 846">2. Open the link to the product download page from the LRS email that you should receive. <b>Note:</b> LRS products are distributed by electronic file transfer (EFT).</li><li data-bbox="592 867 1027 993">3. Download LRS VPSX/MFI and unzip the file (default folder: c:\LRS).</li><li data-bbox="592 1014 1027 1192">4. Launch the LRS Product Installer from the unzipped folder to install LRS VPSX/MFI.</li><li data-bbox="592 1213 1027 1581">5. In the <b>Select Features</b> menu, select <b>VPSX® Server (V1R3.022)</b>, and then choose <b>Next</b> to start the installation process. You will receive a success message when installation is complete.</li></ol>	Cloud architect

Task	Description	Skills required
Install LRS/Queue.	<ol style="list-style-type: none"><li data-bbox="594 226 1026 546">1. Connect to your Micro Focus Enterprise Server EC2 instance by following the instructions from <a href="#">Step 2: Connect to your instance</a> in the Amazon EC2 documentation.</li><li data-bbox="594 567 1026 840">2. Open the link to the LRS product download page from the LRS email that you should receive, download LRS/Queue, and then unzip the file.</li><li data-bbox="594 861 1026 1092">3. Go to the location where you downloaded the files, and then launch the LRS product installer to install LRS/Queue.</li></ol>	Cloud architect



Task	Description	Skills required
Install LRS/DIS.	<ol style="list-style-type: none"><li data-bbox="594 226 1000 548">1. Connect to your LRS VPSX/MFI EC2 instance by following the instructions from <a href="#">Step 2: Connect to your instance</a> in the Amazon EC2 documentation.</li><li data-bbox="594 569 1000 842">2. Open the link to the LRS product download page from the LRS email that you should receive, download LRS/DIS, and then unzip the file.</li><li data-bbox="594 863 1000 1041">3. Go to the location where you downloaded the files, and then launch the LRS Product Installer.</li><li data-bbox="594 1062 1000 1241">4. In the LRS Product Installer , expand <b>LRS Misc Tools</b>, select <b>LRS DIS</b>, and then choose <b>Next</b>.</li><li data-bbox="594 1262 1000 1482">5. Follow the rest of the instructions in the LRS Product Installer to complete the installation process.</li></ol>	Cloud architect

Task	Description	Skills required
Create a target group and register LRS VPSX/MFI EC2 as the target.	<p>Create a target group by following the instructions from <a href="#">Create a target group for your Network Load Balancer</a> in the Elastic Load Balancing documentation.</p> <p>When you create the target group, do the following:</p> <ol style="list-style-type: none"><li>1. On the <b>Specify group details</b> page, for <b>Choose a Target Type</b>, choose <b>Instances</b>.</li><li>2. For <b>Protocol</b>, choose <b>TCP</b>.</li><li>3. For <b>Port</b>, choose <b>5500</b>.</li><li>4. On the <b>Register targets</b> page, in the <b>Available instances</b> section, select the LRS VPSX/MFI EC2 instances.</li></ol>	Cloud architect

Task	Description	Skills required
<p>Create a Network Load Balancer.</p>	<p>Follow the instructions from <a href="#">Create a Network Load Balancer</a> in the Elastic Load Balancing documentation. Your Network Load Balancer routes traffic from Micro Focus Enterprise Server to LRS VPSX/MFI EC2.</p> <p>When you create the Network Load Balancer, do the following on the <b>Listeners and Routing</b> page:</p> <ol style="list-style-type: none"> <li>1. For <b>Protocol</b>, choose <b>TCP</b>.</li> <li>2. For <b>Port</b>, choose <b>5500</b>.</li> <li>3. For <b>Default action</b>, choose <b>Forward to</b> for the target group that you created earlier.</li> </ol>	<p>Cloud architect</p>

### Integrate Micro Focus Enterprise Server with LRS VPSX/MFI and LRS/Queue

Task	Description	Skills required
<p>Configure Micro Focus Enterprise Server for LRS/Queue integration.</p>	<ol style="list-style-type: none"> <li>1. Connect to your Micro Focus Enterprise Server EC2 instance by following the instructions from <a href="#">Step 2: Connect to your instance</a> in the Amazon EC2 documentation.</li> <li>2. In the Windows Start menu, open the Micro</li> </ol>	<p>Cloud architect</p>

Task	Description	Skills required
	<p>Focus Enterprise Server Administration UI.</p> <ol style="list-style-type: none"><li>3. In the menu bar, choose <b>NATIVE</b>.</li><li>4. In the navigation pane, choose <b>Directory Server</b>, and then choose <b>BANKDEMO</b> or your Enterprise server region.</li><li>5. From <b>General</b> in the left navigation pane, scroll down to the <b>Additional</b> section to configure the environment variables (LRSQ_ADDRESS, LRSQ_PORT, LRSQ_COMMAND) to point to LRSQ.</li><li>6. For <b>LRSQ_ADDRESS</b>, enter the IP address or DNS name of the Network Load Balancer that you created earlier.</li><li>7. For <b>LRSQ_PORT</b>, enter <b>VPSX LRSQ Listener Port (5500)</b>.</li><li>8. For <b>LRSQ_COMMAND</b>, enter the path location of the LRSQ executable.</li><li>9. <b>Note:</b> LRS currently supports a maximum character limit of 50 for DNS names, but this is subject to change in the</li></ol>	

Task	Description	Skills required
	<p>future. If your DNS name is greater than 50, then you can use the IP address of the Network Load Balancer as an alternative.</p>	

Task	Description	Skills required
Make CICS Print Exit (DFHUPRNT) available to Micro Focus Enterprise Server initialization.	<ol style="list-style-type: none"><li data-bbox="591 226 1027 548">1. Connect to your Micro Focus Enterprise Server EC2 instance by following the instructions from <a href="#">Step 2: Connect to your instance</a> in the Amazon EC2 documentation.</li><li data-bbox="591 569 1027 1566">2. Copy CICS Print Exit (DFHUPRNT) from the LRS VPSX/MFI executable folder (named VPSX_MFI_R2 ) to the Micro Focus Enterprise Server EC2 instance location. For 32 bit systems, the location is C:\Program Files (x86) \Micro Focus\Enterprise Server\bin . For 64 bit systems, the location is C:\Program Files (x86) \Micro Focus \Enterprise Server \bin64 . <b>Note:</b> The DFHUPRNT_64.dll file must be renamed to DFHUPRNT.dll when copied.</li></ol> <p data-bbox="591 1640 976 1820"><b>Validate that Micro Focus Enterprise Server has detected CICS Print Exit (DFHUPRNT)</b></p>	Cloud architect

Task	Description	Skills required
	<ol style="list-style-type: none"><li data-bbox="592 212 1027 296">1. Stop and start Micro Focus Enterprise Server.</li><li data-bbox="592 317 1027 495">2. In the Administration panel of Micro Focus Enterprise Server, open <b>Monitor, Logs, Console logs</b>.</li><li data-bbox="592 516 1027 741">3. Check the console logs for the following message: "3270 printer user exit DFHUPRNT installed successfully."</li></ol>	

Task	Description	Skills required
<p>Define the CICS printer's terminal ID (TERMIDs) as Micro Focus Enterprise Server.</p>	<p><b>Enable 3270 printing in Micro Focus Enterprise Server</b></p> <ol style="list-style-type: none"> <li>In the Administration panel of Micro Focus Enterprise Server, open <b>CICS, Resources, By Group</b>.</li> <li>From the left navigation panel, choose <b>SIT (System Initialization Table)</b>, and then choose <b>BNKCICV</b>.</li> <li>In the <b>General</b> section, scroll down to <b>3270</b>, and then select the <b>3270 Print</b> check box.</li> </ol> <p><b>Define the CICS printer's terminal in Micro Focus Enterprise Server</b></p> <ol style="list-style-type: none"> <li>In the Administration panel of Micro Focus Enterprise Server, open <b>CICS, Resources, By Type</b>.</li> <li>From the left navigation panel, choose <b>Term</b>, and then choose <b>New</b>. The <b>Create Terminal Resource</b> form opens.</li> <li>For <b>Name</b>, enter the name of the LRS Print Queue. (<b>Note:</b> This pattern uses "<b>P275</b>" as the CICS</li> </ol>	<p>Cloud architect</p>



Task	Description	Skills required
	<p>printer's terminal ID and LRS VPSX Print Queue.)</p> <ol style="list-style-type: none"> <li>4. For <b>Group</b>, enter <b>BANKTERM</b>.</li> <li>5. For <b>Auto Install – Model</b>, enter <b>NO</b>.</li> <li>6. For <b>Terminal Identifiers - Terminal type</b>, enter <b>DFHPRT32</b>.</li> <li>7. For <b>Net name</b>, enter <b>VTAMP275</b>.</li> <li>8. For <b>Terminal Usage</b>, select the <b>In Service</b> check box.</li> <li>9. Scroll at the top of the page, and then chose <b>Save</b>.</li> <li>10. Choose <b>Install</b>. A pop-up message displays a successful installation message.</li> </ol>	

## Set up printers and print users in Micro Focus Enterprise Server and LRS VPSX/MFI

Task	Description	Skills required
Create a print queue in the LRS VPSX.	<ol style="list-style-type: none"> <li>1. Connect to your LRS VPSX/MFI EC2 instance by following the instructions from <a href="#">Step 2: Connect to your instance</a> in the Amazon EC2 documentation.</li> </ol>	Cloud architect

Task	Description	Skills required
	<ol style="list-style-type: none"><li>2. Open the VPSX Web Interface from the Windows Start menu.</li><li>3. In the navigation pane, choose <b>Printers</b>.</li><li>4. Choose <b>Add</b>, and then choose <b>Add Printer</b>.</li><li>5. On the <b>Printer Configuration</b> page, for <b>Printer Name</b>, enter <b>P275</b>.</li><li>6. For <b>VPSX ID</b>, enter <b>VPS1</b>.</li><li>7. For <b>CommType</b>, select <b>TCPIP/LRSQ</b>.</li><li>8. For <b>Host/IP Address</b>, enter the IP address of the physical printer that you want to add.</li><li>9. For <b>Device</b>, enter the name of your device.</li><li>10 Choose either <b>Windows Driver</b> or <b>Linux/Mac Driver</b>.</li><li>11 Choose <b>Add</b>.</li></ol> <p><b>Note:</b> The print queue must be equivalent to the Print TERMIDs created in Micro Focus Enterprise Server.</p>	

Task	Description	Skills required
Create a print user in LRS VPSX/MFI.	<ol style="list-style-type: none"><li>1. Connect to your LRS VPSX/MFI EC2 instance by following the instructions from <a href="#">Step 2: Connect to your instance</a> in the Amazon EC2 documentation.</li><li>2. Open the VPSX Web Interface from the Windows Start menu.</li><li>3. In the navigation pane, choose <b>Security</b>, and then choose <b>Users</b>.</li><li>4. In the <b>User Name</b> column, choose <b>admin</b>, and then choose <b>Copy</b>.</li><li>5. In the <b>User Profile Maintenance</b> window, for <b>User Name</b>, enter a user name (for example, <b>PrintUser</b>).</li><li>6. For <b>Description</b>, enter a brief description (for example, <b>User for test print</b>).</li><li>7. Choose <b>Update</b>. This creates a print user (for example, <b>PrintUser</b>).</li><li>8. In the navigation pane, under <b>User</b>, choose the new user that you created.</li><li>9. From the <b>Command</b> menu, choose <b>Security</b>.</li></ol>	Cloud architect

Task	Description	Skills required
	<p>10 On the <b>Security Rules</b> page, choose all the applicable printer security and job security options, and then choose <b>Save</b>.</p> <p>11 To add your new print user to the <b>Administrator</b> group, go to the navigation pane, choose <b>Security</b>, and then choose <b>Configure</b>.</p> <p>12 In the <b>Security configuration</b> window, add your new print user to the <b>Administrator</b> column.</p>	

## Set up print authentication and authorization

Task	Description	Skills required
<p>Create an AWS Managed Microsoft AD domain with users and groups.</p>	<ol style="list-style-type: none"> <li>1. Create an Active Directory on AWS Managed Microsoft AD by following the instructions from <a href="#">Create your AWS Managed Microsoft AD directory</a> in the AWS Directory Service documentation.</li> <li>2. Deploy an EC2 instance (Active Directory manager) and install Active Directory tools to manage your AWS Managed Microsoft AD by following the instructions from <a href="#">Step 3: Deploy an EC2</a></li> </ol>	<p>Cloud architect</p>

Task	Description	Skills required
	<p><a href="#">instance to manage your AWS Managed Microsoft AD</a> in the AWS Directory Service documentation.</p> <ol style="list-style-type: none"><li>3. Connect to your EC2 instance by following the instructions from <a href="#">Step 2: Connect to your instance</a> in the Amazon EC2 documentation. <b>Note:</b> When you connect to the EC2 instance, enter your administrator credentials (for the directory that you created in step one) in the Windows Security window.</li><li>4. In the Windows Start menu, under <b>Windows Administrative Tools</b>, choose <b>Active Directory Users and Computers</b>.</li><li>5. Create a print user in the Active Directory domain by following the steps from <a href="#">Create a user</a> in the AWS Directory service documentation.</li></ol>	

Task	Description	Skills required
Join LRS VPSX/MFI EC2 to an AWS Managed Microsoft AD domain.	Join LRS VPSX/MFI EC2 to your AWS Managed Microsoft AD domain <a href="#">automatically</a> (AWS Knowledge Center documentation) or <a href="#">manually</a> (AWS Directory Service documentation).	Cloud architect

Task	Description	Skills required
Configure and integrate LRS/DIS with AWS Managed Microsoft AD.	<ol style="list-style-type: none"><li data-bbox="592 226 1003 548">1. Connect to your LRS VPSX/MFI EC2 instance by following the instructions from <a href="#">Step 2: Connect to your instance</a> in the Amazon EC2 documentation.</li><li data-bbox="592 569 1029 699">2. In the Windows Start menu, open the <b>VPSX Web Interface</b>.</li><li data-bbox="592 720 1008 850">3. In the navigation pane, choose <b>Security</b>, and then choose <b>Configure</b>.</li><li data-bbox="592 871 1019 1098">4. On the <b>Security Configuration</b> page, in the <b>Security Parameters</b> section, for <b>Security Type</b>, select <b>Internal</b>.</li><li data-bbox="592 1119 1008 1297">5. Enter your preferences for the rest of the options in the <b>Security Parameters</b> section.</li><li data-bbox="592 1318 1019 1598">6. Open the <b>LRS Output Management</b> folder from the Microsoft Windows Start menu, choose <b>Server Start</b>, and then choose <b>Server Stop</b>.</li><li data-bbox="592 1619 1008 1749">7. Log in to LRS VPSX/MFI with your Active Directory user name and password.</li></ol>	Cloud architect

## Test an online print workflow

Task	Description	Skills required
Initiate an online print request from the Micro Focus ACCT Demo app.	<ol style="list-style-type: none"><li data-bbox="591 323 1026 600">1. Open the TN3270 terminal emulator in your Micro Focus Enterprise Server EC2 instance. (<b>Note:</b> This pattern uses 3270 terminal emulators.)</li><li data-bbox="591 621 1026 848">2. Connect to the TN3270 terminal emulator (Rumba). For <b>Host name address</b>, use <b>127.0.0.1</b>. For <b>Telnet Port</b>, use <b>9270</b>.</li><li data-bbox="591 869 1026 1045">3. After connecting to the 3270 screen, press CTL +SHIFT+Z to clear the screen.</li><li data-bbox="591 1066 1026 1583">4. To start the ACCT Demo application, in clear screen, enter <b>ACCT</b>. This opens the ACCT Demo online (CICS) application main screen. <b>Note:</b> The main screen includes menu options such as <b>Account file</b>, <b>To search by name</b>, <b>enter</b>, <b>Request type</b>, <b>Account</b>, and <b>Printer</b>.</li><li data-bbox="591 1604 1026 1873">5. To submit a print request from the ACCT Demo online (CICS) application, enter <b>P</b> in the <b>request type</b> field, <b>11111</b> in the <b>account</b> field, and <b>P275</b> in</li></ol>	Cloud architect



Task	Description	Skills required
	<p>the <b>printer</b> field. Be sure to set the value in the <b>printer</b> field to the value of the CICS printer's terminal ID.</p> <p>6. Press <b>Enter</b>.</p> <p>The "Print Request Scheduled" message appears at the bottom of the screen. This confirms that an online print request was generated from the ACCT Demo application and sent to LRS VPS/MFI for print processing.</p>	

Task	Description	Skills required
Check the print output in LRS VPSX/MFI.	<ol style="list-style-type: none"><li data-bbox="592 226 1027 548">1. Connect to your LRS VPSX/MFI EC2 instance by following the instructions from <a href="#">Step 2: Connect to your instance</a> in the Amazon EC2 documentation.</li><li data-bbox="592 569 1027 699">2. In the Windows Start menu, open the <b>VPSX Web Interface</b>.</li><li data-bbox="592 720 1027 995">3. In the navigation pane, choose <b>Printers</b>, and then choose <b>Output Queue</b>. Find the <b>P275</b> print queue that you created for online printing earlier.</li><li data-bbox="592 1016 1027 1245">4. For the print queue (<b>P275</b>), in the <b>Spool ID</b> column, choose the spool ID for the request in the printer queue.</li><li data-bbox="592 1266 1027 1396">5. On the <b>Actions</b> tab, in the <b>COMMAND</b> column, choose <b>Browse</b>.</li></ol> <p data-bbox="592 1472 1027 1795">You can now see the print output of an account statement with columns for Account No., SURNAME, FIRST, ADDRESS, TELEPHONE, No. Cards Issued, Date issued, Amount, and Balance.</p>	Test engineer

Task	Description	Skills required
	For an example, see the <b>online_print_output</b> attachment for this pattern.	

## Related resources

- [LRS Output Modernization](#) (LRS documentation)
- [VTAM networking concepts](#) (IBM documentation)
- [Summary of logical unit \(LU\) types](#) (IBM documentation)
- [ANSI and machine carriage controls](#) (IBM documentation)
- [Empowering Enterprise Mainframe Workloads on AWS with Micro Focus](#) (AWS Partner Network Blog)
- [Build a Micro Focus Enterprise Server PAC with Amazon EC2 Auto Scaling and Systems Manager](#) (AWS Prescriptive Guidance documentation)
- [Advanced Function Presentation \(AFP\) data stream](#) (IBM documentation)
- [Line Conditioned Data Stream \(LCDS\)](#) (Compart documentation)

## Additional information

### Considerations

During your modernization journey, you may consider a wide variety of configurations for mainframe online processes and the output they generate. The mainframe platform has been customized by every customer and vendor that uses it with particular requirements that directly affect print. For example, your current platform may incorporate the IBM Advanced Function Presentation (AFP) or the Xerox Line Condition Data Stream (LCDS) into the current workflow. Additionally, [mainframe carriage control characters](#) and [channel command words](#) can affect the look of the printed page and may need special handling. As part of the modernization planning process, we recommend that you assess and understand the configurations in your specific print environment.

### Print data capture

This section summarizes the CICS application programming methods that you can use in an IBM mainframe environment for printing. LRS VPSX/MFI components provide techniques to allow the same application programs to create data in the same way. The following table describes how each application programming method is supported in a modernized CICS application running in AWS and Micro Focus Enterprise Server with an LRS VPSX/MFI print server.

Method	Description	Support for the method in a modernized environment
EXEC CICS SEND TEXT.. or EXEC CICS SEND MAP..	These CICS and VTAM methods are responsible for creating and delivering 3270/SCS print data streams to LUTYPE0, LUTYPE1, and LUTYPE3 print devices.	A Micro Focus online Print Exit (DFHUPRNT) application program interface (API) enables print data to be processed by VPSX/MFI when 3270/SCS print data streams are created by using either of these methods.
EXEC CICS SEND TEXT.. or EXEC CICS SEND MAP.. (with third-party IBM mainframe software)	The CICS and VTAM methods are responsible for creating and delivering 3270/SCS print data streams to LUTYPE0, LUTYPE1, and LUTYPE3 print devices. Third-party software products intercept the print data, convert the data to standard print format data with an ASA/MCH control character, and place the data on the JES spool to be processed by mainframe-based printing systems that use JES.	A Micro Focus online Print Exit (DFHUPRNT) API enables print data to be processed by VPSX/MFI when 3270/SCS print data streams are created by using either of these methods.
EXEC CICS SPOOLOPEN	This method is used by CICS application programs to write data directly to the JES	Micro Focus Enterprise Server spools the data to the Enterprise Server spool where

	spool. The data then becomes available to be processed by mainframe-based printing systems that use JES.	it can be processed by the VPSX/MFI Batch Print Exit (LRSPRTE6) that spools the data to VPSX.
DRS/API	An LRS-supplied programmatic interface is used for writing print data to JES.	VPSX/MFI supplies a replacement interface that spools the print data directly to VPSX.

## Printer fleet health checks

LRS VPSX/MFI (LRS LoadX) can perform deep dive health checks, including device management and operational optimization. Device management can detect failure in a printer device and route the print request to a healthy printer. For more information about deep dive health checks for printer fleets, see the LRS documentation that's included with your product license.

## Print authentication and authorization

LRS/DIS enables LRS applications to authenticate user IDs and passwords by using Microsoft Active Directory or an LDAP server. In addition to basic print authorization, LRS/DIS can also apply granular-level print security controls in the following use cases:

- Manage who can browse the printer job.
- Manage the browsing level of other user's jobs.
- Manage operational tasks. For example, command-level security such as hold/release, purge, modify, copy, and reroute. Security can be set up by either the User-ID or Group (similar to AD group or LDAP group).

## Attachments

To access additional content that is associated with this document, unzip the following file:

[attachment.zip](#)

# Move mainframe files directly to Amazon S3 using Transfer Family

Created by Luis Gustavo Dantas (AWS)

<b>Environment:</b> Production	<b>Source:</b> Mainframe	<b>Target:</b> Amazon S3
<b>R Type:</b> N/A	<b>Workload:</b> IBM	<b>Technologies:</b> Mainframe; Storage & backup; Modernization
<b>AWS services:</b> AWS Transfer Family; Amazon S3		

## Summary

As part of the modernization journey, you can face the challenge of transferring files between your on-premises servers and the Amazon Web Services (AWS) Cloud. Transferring data from mainframes can be a significant challenge because mainframes typically can't access modern data stores like Amazon Simple Storage Service (Amazon S3), Amazon Elastic Block Store (Amazon EBS), or Amazon Elastic File System (Amazon EFS).

Many customers use intermediate staging resources, such as on-premises Linux, Unix, or Windows servers, to transfer files to the AWS Cloud. You can avoid this indirect method by using AWS Transfer Family with the Secure Shell (SSH) File Transfer Protocol (SFTP) to upload mainframe files directly to Amazon S3.

## Prerequisites and limitations

### Prerequisites

- An active AWS account
- A virtual private cloud (VPC) with a subnet that's reachable by your legacy platform
- A Transfer Family endpoint for your VPC
- Mainframe Virtual Storage Access Method (VSAM) files converted to sequential, [fixed-length files](#) (IBM documentation)

## Limitations

- SFTP transfers files in binary mode by default, which means that files are uploaded to Amazon S3 with EBCDIC encoding preserved. If your file doesn't contain binary or packed data, then you can use the `sftp` [ascii subcommand](#) (IBM documentation) to convert your files to text during the transfer.
- You must [unpack mainframe files](#) (AWS Prescriptive Guidance) that contain packed and binary content to use these files in your target environment.
- Amazon S3 objects can range in size from a minimum of 0 bytes to a maximum of 5 TB. For more information about Amazon S3 capabilities, see [Amazon S3 FAQs](#).

## Architecture

### Source technology stack

- Job control language (JCL)
- z/OS Unix shell and ISPF
- SFTP
- VSAM and flat files

### Target technology stack

- Transfer Family
- Amazon S3
- Amazon Virtual Private Cloud (Amazon VPC)

### Target architecture

The following diagram shows a reference architecture for using Transfer Family with SFTP to upload mainframe files directly to an S3 bucket.

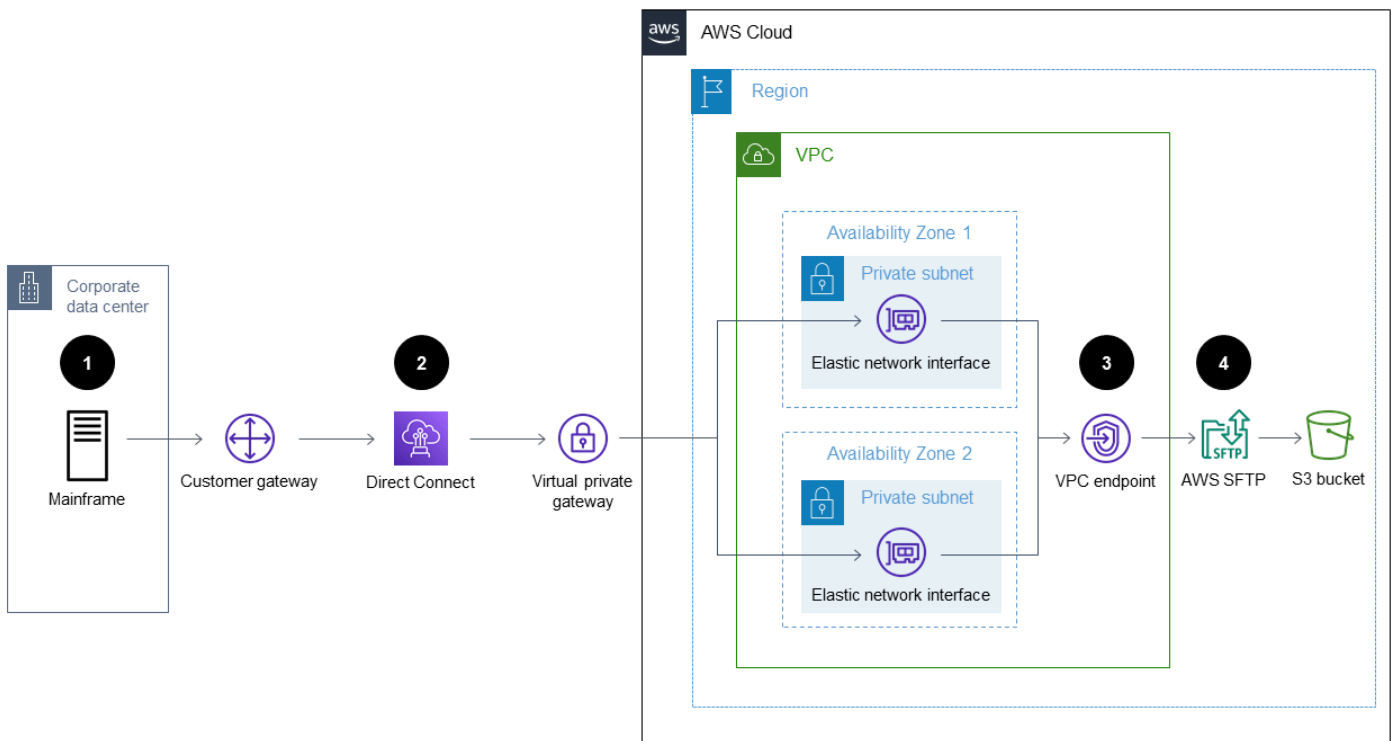

The diagram shows the following workflow:

1. You use a JCL job to transfer your mainframe files from the legacy mainframe to the AWS Cloud through Direct Connect.
2. Direct Connect enables your network traffic to remain on the AWS global network and bypass the public internet. Direct Connect also enhances the network speed, starting at 50 Mbps and scaling up to 100 Gbps.
3. The VPC endpoint enables connections between your VPC resources and the supported services without using the public internet. Access to Transfer Family and Amazon S3 achieves high availability by taking place through the elastic network interfaces located in two private subnets and Availability Zones.
4. Transfer Family authenticates users and uses SFTP to receive your files from the legacy environment and move them to an S3 bucket.

## Automation and scale

After the Transfer Family service is in place, you can transfer an unlimited number of files from the mainframe to Amazon S3 by using a JCL job as the SFTP client. You can also automate the



file transfer by using a mainframe batch job scheduler to run the SFTP jobs when you're ready to transfer the mainframe files.

## Tools

- [Amazon Simple Storage Service \(Amazon S3\)](#) is a cloud-based object storage service that helps you store, protect, and retrieve any amount of data.
- [Amazon Virtual Private Cloud \(Amazon VPC\)](#) helps you launch AWS resources into a virtual network that you've defined. This virtual network resembles a traditional network that you'd operate in your own data center, with the benefits of using the scalable infrastructure of AWS.
- [AWS Transfer Family](#) enables you to securely scale your recurring business-to-business file transfers to Amazon S3 and Amazon EFS by using SFTP, FTPS, and FTP protocols.

## Epics

### Create the S3 bucket and the access policy

Task	Description	Skills required
Create the S3 bucket.	<a href="#">Create an S3 bucket</a> to host the files that you transfer from your legacy environment.	General AWS
Create the IAM role and policy.	Transfer Family uses your AWS Identity and Access Management (IAM) role to grant access to the S3 bucket that you created earlier.  <a href="#">Create an IAM role</a> that includes the following <a href="#">IAM policy</a> :  <pre>{   "Version":   "2012-10-17",   "Statement": [</pre>	General AWS

Task	Description	Skills required
	<pre> {   "Sid":   "UserFolderListing",   "Action": [      "s3:ListBucket",      "s3:GetBucketLocat ion"   ],   "Effect":   "Allow",   "Resource":   [      "arn:aws:s3:::&lt;your- bucket-name&gt;"   ] }, {   "Sid":   "HomeDirObjectAcce ss",   "Effect":   "Allow",   "Action": [      "s3:PutObject",      "s3:GetObjectAcl",      "s3:GetObject",      "s3:DeleteObjectVe rsion",      "s3:DeleteObject",      "s3:PutObjectAcl",      "s3:GetObjectVersion"   ], </pre>	

Task	Description	Skills required
	<pre data-bbox="594 205 1024 464">           "Resource":             "arn:aws:s3:::&lt;your-             bucket-name&gt;/*"           }         ]       }     </pre> <p data-bbox="594 499 1024 632"><b>Note:</b> You must choose the Transfer use case when you create the IAM role.</p>	

## Define the transfer service

Task	Description	Skills required
Create the SFTP server.	<ol data-bbox="594 926 1024 1864" style="list-style-type: none"> <li>1. Sign in to the AWS Management console, open the <a href="#">Transfer Family console</a>, and then choose <b>Create server</b>.</li> <li>2. Choose only <b>SFTP (SSH File Transfer Protocol) - file transfer over Secure Shell protocol</b> and then choose <b>Next</b>.</li> <li>3. For <b>Identity provider</b>, choose <b>Service managed</b> and then choose <b>Next</b>.</li> <li>4. For <b>Endpoint type</b>, choose <b>VPC hosted</b>.</li> <li>5. For <b>Access</b>, choose <b>Internal</b>.</li> <li>6. For <b>VPC</b>, choose your VPC.</li> </ol>	General AWS

Task	Description	Skills required
	<p>7. In the <b>Availability Zones</b> section, choose your Availability Zones and subnets.</p> <p>8. In the <b>Security Groups</b> section, choose your security group, and then choose <b>Next</b>.</p> <p>9. For <b>Domain</b>, choose <b>Amazon S3</b> and then choose <b>Next</b>.</p> <p>10 Leave the default options on the <b>Configure additional details</b> page and then choose <b>Next</b>.</p> <p>11 Choose <b>Create server</b>.</p> <p><b>Note:</b> For more information about how to set up an SFTP server, see <a href="#">Create an SFTP-enabled server</a> (AWS Transfer Family User Guide).</p>	

Task	Description	Skills required
Get the server address.	<ol style="list-style-type: none"><li>1. Open the <a href="#">Transfer Family console</a> and choose your server ID in the <b>Server ID</b> column.</li><li>2. In the <b>Endpoint details</b> section, for <b>Endpoint type</b>, choose the endpoint ID. This takes you to the Amazon VPC console.</li><li>3. On the <b>Details</b> tab of the Amazon VPC console, find the DNS names next to <b>DNS names</b>.</li></ol>	General AWS
Create the SFTP client key pair.	Create an SSH key pair for either <a href="#">Microsoft Windows</a> or <a href="#">macOS/Linux/UNIX</a> .	General AWS, SSH

Task	Description	Skills required
Create the SFTP user.	<ol style="list-style-type: none"> <li>1. Open the <a href="#">Transfer Family console</a>, choose <b>Servers</b> from the navigation pane, and then select your server.</li> <li>2. In the <b>Server ID</b> column, choose the server ID for your server and then choose <b>Add user</b>.</li> <li>3. For <b>Username</b>, enter a user name that matches your SSH key pair user name.</li> <li>4. For <b>Role</b>, choose the IAM role that you created earlier.</li> <li>5. For <b>Home directory</b>, choose the S3 bucket that you created earlier.</li> <li>6. For <b>SSH public keys</b>, enter the key pair that you created earlier.</li> <li>7. Choose <b>Add</b>.</li> </ol>	General AWS

## Transfer the mainframe file

Task	Description	Skills required
Send the SSH private key to the mainframe.	<p>Use SFTP or SCP to send the SSH private key to the legacy environment.</p> <p>SFTP example:</p>	Mainframe, z/OS Unix shell, FTP, SCP

Task	Description	Skills required
	<pre>sftp [USERNAME@mainframeIP] [password] cd [/u/USERNAME] put [your-key-pair-file]</pre> <p>SCP example:</p> <pre>scp [your-key-pair-file] [USERNAME@MainframeIP]:[/u/USERNAME]</pre> <p>Next, store the SSH key in the z/OS Unix file system under the user name that will later run the file transfer batch job (for example, /u/CONTROLM ).</p> <p><b>Note:</b> For more information about z/OS Unix shell, see <a href="#">An introduction to the z/OS shells</a> (IBM documentation).</p>	

Task	Description	Skills required
Create the JCL SFTP client.	<p>Because mainframes don't have a native SFTP client, you must use the BPXBATCH utility to run the SFTP client from the z/OS Unix shell.</p> <p>In the ISPF editor, create the JCL SFTP client. For example:</p> <pre data-bbox="594 617 1027 1570">//JOBNAM JOB ... //***** ***** ***** ***** ****  //SFTP EXEC PGM=BPXBAT TCH,REGION=0M //STDPARM DD * SH cp '//MAINFR AME.FILE.NAME'   filename.txt; echo 'put filename.txt'   &gt; uplcmd; sftp -b uplcmd -i   ssh_private_key_fi le ssh_username@&lt;tran sfer service ip or   DNS&gt;; //SYSPRINT DD SYSOUT=* //STDOUT DD SYSOUT=* //STDENV DD * //STDERR DD SYSOUT=*</pre>	JCL, Mainframe, z/OS Unix shell



Task	Description	Skills required
	<p>information about how to create or edit JCL jobs in z/OS, see <a href="#">What is ISPF?</a> and <a href="#">The ISPF editor</a> (IBM documentation).</p>	
<p>Run the JCL SFTP client.</p>	<ol style="list-style-type: none"> <li>1. In the ISPF editor, enter <b>SUB</b>, and then press the ENTER key after the JCL job is created.</li> <li>2. Monitor the mainframe's file transfer batch job activity in SDSF.</li> </ol> <p><b>Note:</b> For more information about how to check the activity of batch jobs, see <a href="#">z/OS SDSF User's Guide</a> (IBM documentation).</p>	<p>Mainframe, JCL, ISPF</p>
<p>Validate the file transfer.</p>	<ol style="list-style-type: none"> <li>1. Sign in to the AWS Management console, open the <a href="#">Amazon S3 console</a>, and then choose <b>Buckets</b> from the navigation pane.</li> <li>2. Choose the bucket that's associated with your Transfer Family.</li> <li>3. In the <b>Objects</b> section of the <b>Objects</b> tab, find the file that you transferred from the mainframe.</li> </ol>	<p>General AWS</p>

Task	Description	Skills required
Automate the JCL SFTP client.	<p>Use job scheduler to automatically trigger the JCL SFTP client.</p> <p><b>Note:</b> You can use mainframe job schedulers, such as <a href="#">BMC Control-M</a> or <a href="#">CA Workload Automation</a>, to automate batch jobs for file transfers based on time and other batch job dependencies.</p>	Job scheduler

## Related resources

- [How AWS Transfer Family works](#)
- [Mainframe Modernization with AWS](#)

# Transfer large-scale Db2 z/OS data to Amazon S3 in CSV files

Created by Bruno Sahinoglu (AWS), Ivan Schuster (AWS), and Abhijit Kshirsagar (AWS)

<b>Code repository:</b> <a href="#">Unload DB2 z/OS to S3</a>	<b>Environment:</b> Production	<b>Source:</b> Db2
<b>Target:</b> Amazon S3	<b>R Type:</b> Replatform	<b>Workload:</b> IBM
<b>Technologies:</b> Mainframe ; Data lakes; Databases; DevelopmentAndTesting; Migration	<b>AWS services:</b> Amazon Aurora; AWS Glue; Amazon S3; AWS Transfer Family; Amazon Athena	

## Summary

A mainframe is still a system of record in many enterprises, containing a massive amount of data including master data entities with records of current as well as the historical business transactions. It is often siloed and not easily accessed by the distributed systems within the same enterprise. With the emergence of cloud technology and big data democratization, enterprises are interested in using the insights hidden in the mainframe data to develop new business capabilities.

With that objective, enterprises are looking to open their mainframe Db2 data to their Amazon Web Services (AWS) Cloud environment. The business reasons are several and the transfer methods differ from case to case. You might prefer to connect your application directly to the mainframe, or you might prefer to replicate your data in near real time. If the use case is to feed a data warehouse or a data lake, having an up-to-date copy is no longer a concern, and the procedure described in this pattern might suffice, especially if you want to avoid any third-party product licensing costs. Another use case might be the mainframe data transfer for a migration project. In a migration scenario, data is required for performing the functional equivalence testing. The approach described in this post is a cost effective way to transfer the Db2 data to the AWS Cloud environment.

Because Amazon Simple Storage Service (Amazon S3) is one of the most integrated AWS services, you can access the data from there and gather insights directly by using other AWS services such as Amazon Athena, AWS Lambda functions, or Amazon QuickSight . You can also load the data

to Amazon Aurora or Amazon DynamoDB by using AWS Glue or AWS Database Migration Service (AWS DMS). With that aim in mind, this describes how to unload Db2 data in CSV files in ASCII format on the mainframe and transfer the files to Amazon S3.

For this purpose, [mainframe scripts](#) have been developed to help to generate job control languages (JCLs) to unload and transfer as many Db2 tables as you need.

## Prerequisites and limitations

### Prerequisites

- An IBM z/OS operating system user with authorization to run Restructured Extended Executor (REXX) and JCL scripts.
- Access to z/OS Unix System Services (USS) to generate SSH (Secure Shell) private and public keys.
- A writable S3 bucket. For more information, see [Create your first S3 bucket](#) in the Amazon S3 documentation.
- An AWS Transfer Family SSH File Transfer Protocol (SFTP)-enabled server using **Service managed** as the identity provider and Amazon S3 as the AWS storage service. For more information, see [Create an SFTP-enabled server](#) in the AWS Transfer Family documentation.

### Limitations

- This approach isn't suitable for near real-time or real-time data synchronization.
- Data can be moved only from Db2 z/OS to Amazon S3, not the other way around.

## Architecture

### Source technology stack

- Mainframe running Db2 on z/OS

### Target technology stack

- AWS Transfer Family
- Amazon S3

- Amazon Athena
- Amazon QuickSight
- AWS Glue
- Amazon Relational Database Service (Amazon RDS)
- Amazon Aurora
- Amazon Redshift

## Source and target architecture

The following diagram shows the process for generating, extracting, and transferring Db2 z/OS data in ASCII CSV format to an S3 bucket.

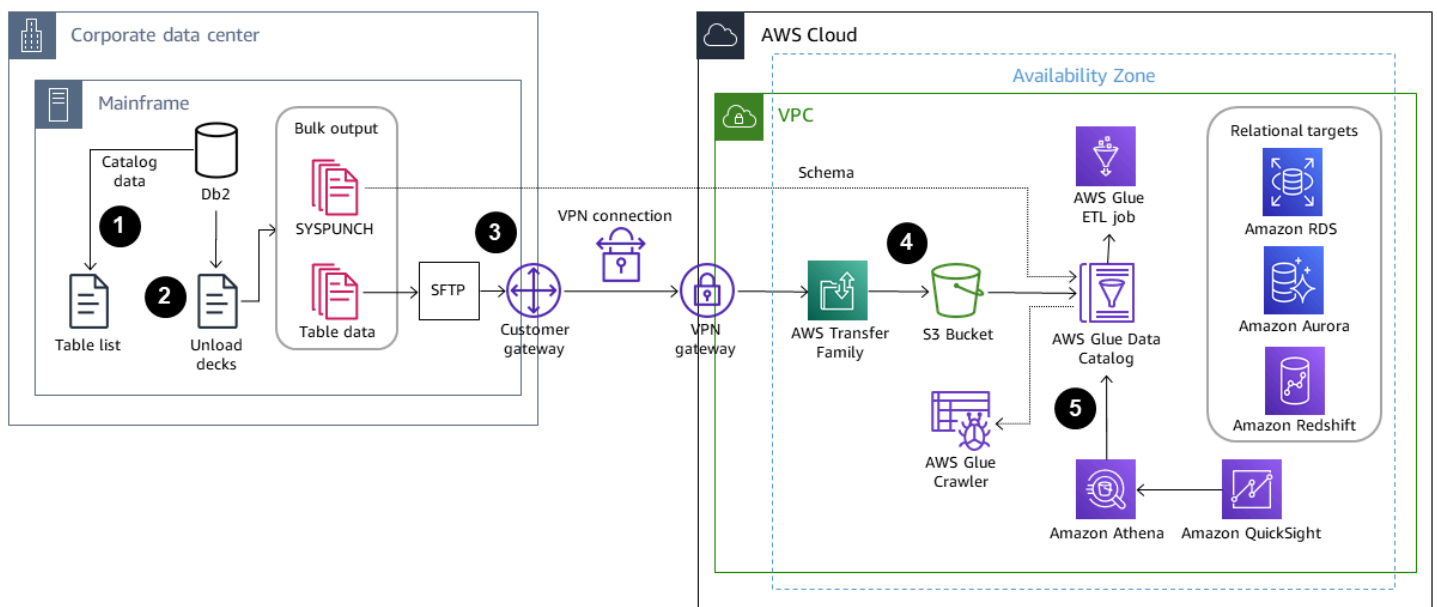

1. A list of tables is selected for data migration from the Db2 catalog.
2. The list is used to drive the generation of unload jobs with the numeric and data columns in the external format.
3. The data is then transferred over to Amazon S3 by using AWS Transfer Family.
4. An AWS Glue extract, transform, and load (ETL) job can transform the data and load it to a processed bucket in the specified format, or AWS Glue can feed the data directly into the database.
5. Amazon Athena and Amazon QuickSight can be used to query and render the data to drive analytics.

The following diagram shows a logical flow of the entire process.

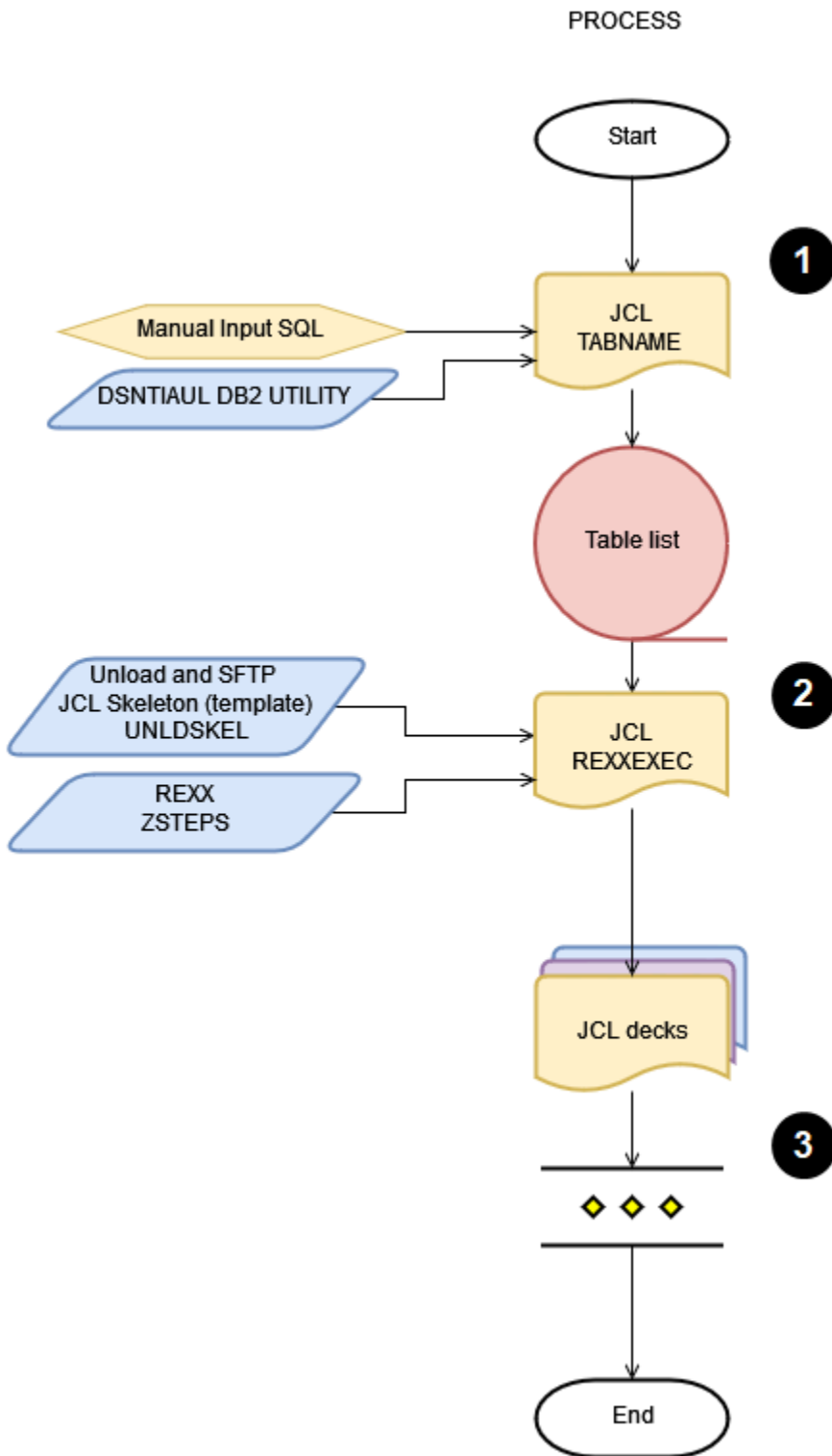

1. The first JCL, called TABNAME, will use the Db2 utility DSNTIAUL to extract and generate the list of tables that you plan to unload from Db2. To choose your tables, you must manually adapt the SQL input to select and add filter criteria to include one or more Db2 schemas.
2. The second JCL, called REXXEXEC, will use the a JCL skeleton and the REXX program that is provided to process the Table list created by the JCL TABNAME and generate one JCL per table name. Each JCL will contain one step for unloading the table and another step for sending the file to the S3 bucket by using the SFTP protocol.
3. The last step consists of running the JCL to unload the table and transferring the file to AWS. The entire process can be automated using a scheduler on premises or on AWS.

## Tools

### AWS services

- [Amazon Athena](#) is an interactive query service that helps you analyze data directly in Amazon Simple Storage Service (Amazon S3) by using standard SQL.
- [Amazon Aurora](#) is a fully managed relational database engine that's built for the cloud and compatible with MySQL and PostgreSQL.
- [AWS Glue](#) is a fully managed extract, transform, and load (ETL) service. It helps you reliably categorize, clean, enrich, and move data between data stores and data streams.
- [Amazon QuickSight](#) is a cloud-scale business intelligence (BI) service that helps you visualize, analyze, and report your data in a single dashboard.
- [Amazon Redshift](#) is a managed petabyte-scale data warehouse service in the AWS Cloud.
- [Amazon Relational Database Service \(Amazon RDS\)](#) helps you set up, operate, and scale a relational database in the AWS Cloud.
- [Amazon Simple Storage Service \(Amazon S3\)](#) is a cloud-based object storage service that helps you store, protect, and retrieve any amount of data.
- [AWS Transfer Family](#) is a secure transfer service that enables you to transfer files into and out of AWS storage services.

### Mainframe tools

- [SSH File Transfer Protocol \(SFTP\)](#) is a secure file transfer protocol that allows remote login to and file transfer between servers. SSH provides security by encrypting all traffic.

- [DSNTIAUL](#) is a sample program provided by IBM for unloading data.
- [DSNUTILB](#) is a utilities batch program provided by IBM for unloading data with different options from DSNTIAUL.
- [z/OS OpenSSH](#) is a port of Open Source Software SSH running on the Unix System Service under the IBM operating system z/OS. SSH is a secure, encrypted connection program between two computers running on a TCP/IP network. It provides multiple utilities, including ssh-keygen.
- [REXX \(Restructured Extended Executor\)](#) script is used to automate JCL generation with the Db2 Unload and SFTP steps.

## Code

The code for this pattern is available in the GitHub [unloaddb2](#) repository.

## Best practices

For the first unload, the generated JCLs should unload the entire table data.

After the first full unload, perform incremental unloads for better performance and cost savings. Update the SQL query in the template JCL deck to accommodate any changes to the unload process.

You can convert the schema manually or by using a script on Lambda with the Db2 SYSPUNCH as an input. For an industrial process, [AWS Schema Conversion Tool \(SCT\)](#) is the preferred option.

Finally, use a mainframe-based scheduler or a scheduler on AWS with an agent on the mainframe to help manage and automate the entire process.

## Epics

### Set up the S3 bucket

Task	Description	Skills required
Create the S3 bucket.	For instructions, see <a href="#">Create your first S3 bucket</a> .	General AWS



## Set up the Transfer Family server

Task	Description	Skills required
Create an SFTP-enabled server.	<p>To open and create an SFTP server on the <a href="#">AWS Transfer Family console</a>, do the following:</p> <ol style="list-style-type: none"><li>1. On the Choose protocols, page, select the <b>SFTP (SSH File Transfer Protocol) – file transfer over Secure Shell</b> check box.</li><li>2. For the identity provider, choose <b>Service managed</b>.</li><li>3. For the endpoint, choose <b>Publicly accessible</b>.</li><li>4. For the domain, choose <b>Amazon S3</b>.</li><li>5. On the <b>Configure additional details</b> page, keep the default settings.</li><li>6. Create the server.</li></ol>	General AWS
Create an IAM role for Transfer Family.	<p>To create an AWS Identity and Access Management (IAM) role for Transfer Family to access Amazon S3, follow the instructions in <a href="#">Create an IAM role and policy</a>.</p>	AWS administrator
Add an Amazon S3 service-managed user.	<p>To add the Amazon S3 service-managed user, follow the instructions in the <a href="#">AWS</a></p>	General AWS

Task	Description	Skills required
	<a href="#">documentation</a> , and use your mainframe user ID.	

## Secure the communication protocol

Task	Description	Skills required
Create the SSH key.	<p>Under your mainframe USS environment, run the following command.</p> <pre>ssh-keygen -t rsa</pre> <p><b>Note:</b> When prompted for a passphrase, keep it empty.</p>	Mainframe developer
Give the right authorization levels to the SSH folder and key files.	<p>By default, the public and private keys will be stored in the user directory <code>/u/home/u sername/.ssh</code> .</p> <p>You must give the authorization 644 to the key files and 700 to the folder.</p> <pre>chmod 644 .ssh/id_rsa chmod 700 .ssh</pre>	Mainframe developer
Copy the public key content to your Amazon S3 service-managed user.	<p>To copy the USS-generated public key content, open the <a href="#">AWS Transfer Family console</a>.</p> <ol style="list-style-type: none"> <li>1. In the navigation pane, choose <b>Servers</b>.</li> </ol>	Mainframe developer

Task	Description	Skills required
	<ol style="list-style-type: none"> <li>2. Choose the identifier in the <b>Server ID</b> column to see the <b>Server details</b></li> <li>3. Under <b>Users</b>, choose a user name to see the <b>User details</b></li> <li>4. Under <b>SSH public keys</b>, choose <b>Add SSH public key</b> to add the public key to a user. For the SSH public key, enter your public key. Your key is validated by the service before you can add your new user.</li> <li>5. Choose <b>Add key</b>.</li> </ol>	

## Generate the JCLs

Task	Description	Skills required
Generate the in-scope Db2 table list.	<p>Provide input SQL to create a list of the tables that are scoped for data migration . This step requires you to specify selection criteria querying the Db2 catalog table SYSIBM.SYSTABLES using a SQL where clause. Filters can be customized to include a specific schema or table names that start with a particular prefix or based on a timestamp for incremental</p>	Mainframe developer

Task	Description	Skills required
	<p>unload. Output is captured in a physical sequential (PS) dataset on the mainframe. This dataset will act as input for the next phase of JCL generation.</p> <p>Before you use the JCL TABNAME (You can rename it if necessary), make the following changes:</p> <ol style="list-style-type: none"><li>1. Substitute &lt;Jobcard&gt; with a job class and a user that is authorized to run Db2 utilities.</li><li>2. Substitute &lt;HLQ1&gt; or customize the output dataset names to meet your site standards.</li><li>3. Update the STEPLIB stack of PDSEs (partitioned data set extended) according to your site standards. The example in this pattern uses the IBM defaults.</li><li>4. Substitute the PLAN name and LIB with your installation-specific values.</li><li>5. Substitute &lt;Schema&gt; and &lt;Prefix&gt; with your selection criteria for the Db2 catalog.</li></ol>	

Task	Description	Skills required
	<p>6. Save the resultant JCL in a PDS (partitioned data set) library.</p> <p>7. Submit the JCL.</p> <p><b>Db2 table list extraction job</b></p> <pre data-bbox="592 546 1031 1837"> &lt;Jobcard&gt; //* //* UNLOAD ALL THE TABLE   NAMES FOR A PARTICULAR   SCHEMA //* //STEP01 EXEC PGM=IEFBR 14 //* //DD1      DD  DISP=(MOD ,DELETE,DELETE), //          UNIT=SYSDA, //          SPACE=(1000, (1,1)), //          DSN=&lt;HLQ1 &gt;.DSN81210.TABLIST //* //DD2      DD  DISP=(MOD ,DELETE,DELETE), //          UNIT=SYSDA, //          SPACE=(1000, (1,1)), //          DSN=&lt;HLQ1 &gt;.DSN81210.SYSPUNCH //* //UNLOAD  EXEC PGM=IKJEF T01,DYNAMNBR=20 //SYSTSPRT DD   SYSOUT=* //STEPLIB DD   DISP=SHR,DSN=DSNC1 0.DBCG.SDSNEXIT </pre>	

Task	Description	Skills required
	<pre>//          DD  DISP=SHR, DSN=DSNC10.SDSNLOAD //          DD  DISP=SHR, DSN=CEE.SCEERUN //          DD  DISP=SHR, DSN=DSNC10.DBCG.RU NLIB.LOAD //SYSTSIN DD *           DSN SYSTEM(DBCG)           RUN PROGRAM(D SNTIAUL) PLAN(DSNT IB12) PARS('SQL') -           LIB('DSNC 10.DBCG.RUNLIB.LOAD')           END //SYSPRINT DD SYSOUT=* //* //SYSUDUMP DD SYSOUT=* //* //SYSRECOO DD DISP=(NEW ,CATLG,DELETE), //          UNIT=SYSD A,SPACE=(32760,(10 00,500)), //          DSN=&lt;HLQ1 &gt;.DSN81210.TABLST //* //SYSPUNCH DD DISP=(NEW ,CATLG,DELETE), //          UNIT=SYSD A,SPACE=(32760,(10 00,500)), //          VOL=SER=S CR03,RECFM=FB,LREC L=120,BLKSIZE=12 //          DSN=&lt;HLQ1 &gt;.DSN81210.SYSPUNCH //* //SYSIN    DD *           SELECT CHAR(CREA TOR), CHAR(NAME)</pre>	

Task	Description	Skills required
	<pre>FROM SYSIBM.SY STABLES WHERE OWNER = '&lt;Schema&gt;' AND NAME LIKE '&lt;Prefix&gt;%' AND TYPE = 'T'; /*</pre>	

Task	Description	Skills required
Modify the JCL templates.	<p>The JCL templates that are provided with this pattern contain a generic job card and library names. However, most mainframe sites will have their own naming standards for dataset names, library names, and job cards. For example, a specific job class might be required to run Db2 jobs. The Job Entry Subsystem implementations JES2 and JES3 can impose additional changes. Standard load libraries might have a different first qualifier than SYS1, which is IBM default. Therefore, customize the templates to account for your site-specific standards before you run them.</p> <p>Make the following changes in the skeleton JCL UNLDSKEL:</p> <ol style="list-style-type: none"><li>1. Modify the job card with a job class and user that is authorized to run Db2 utilities.</li><li>2. Customize output dataset names to meet your site standards.</li><li>3. Update the STEPLIB stack of PDSEs according to</li></ol>	Mainframe developer



Task	Description	Skills required
	<p>your site standards. The example in this pattern uses the IBM defaults.</p> <ol style="list-style-type: none"> <li>4. Substitute &lt;DSN&gt; with your Db2 subsystem name and correlation ID.</li> <li>5. Save the resultant JCL in a PDS library that is part of your ISPSLIB stack, which is the standard skeleton template library for ISPF.</li> </ol> <p><b>Unload and SFTP JCL skeleton</b></p> <pre data-bbox="594 940 1026 1827"> //&amp;USRPFX.U JOB   (DB2UNLOAD), 'JOB',   CLASS=A,MSGCLASS=A,   //          TIME=1440   ,NOTIFY=&amp;USRPFX //* DELETE DATASETS //STEP01 EXEC   PGM=IEFBR14 //DD01 DD DISP=(MOD   ,DELETE,DELETE), //          UNIT=SYSD A, //          SPACE=(TR K,(1,1)), // DSN=&amp;USRPFX..DB2.P UNCH.&amp;JOBNAME //DD02 DD DISP=(MOD   ,DELETE,DELETE), //          UNIT=SYSD A, //          SPACE=(TR K,(1,1)), </pre>	

Task	Description	Skills required
	<pre> // DSN=&amp;USRPF..DB2.U NLOAD.&amp;JOBNAME //* //* RUNNING DB2 EXTRACTION BATCH JOB FOR AWS DEMO //* //UNLD01 EXEC PGM=DSNUTILB,REGIO N=0M, // PARM= '&lt;DSN&gt;,UNLOAD' //STEPLIB DD DISP=SHR,DSN=DSNC1 0.DBCG.SDSNEXIT // DD DISP=SHR, DSN=DSNC10.SDSNLOAD //SYSPRINT DD SYSOUT=* //UTPRINT DD SYSOUT=* //SYSOUT DD SYSOUT=* //SYSPUN01 DD DISP=(NEW,CATLG,DE LETE), // SPACE=(CY L,(1,1),RLSE), // DSN=&amp;USRPF..DB2.P UNCH.&amp;JOBNAME //SYSREC01 DD DISP=(NEW,CATLG,DE LETE), // SPACE=(CY L,(10,50),RLSE), // DSN=&amp;USRPF..DB2.U NLOAD.&amp;JOBNAME //SYSPRINT DD SYSOUT=* //SYSIN DD * UNLOAD DELIMITED COLDEL ',' FROM TABLE &amp;TABNAME UNLDDN SYSREC01 PUNCHDDN SYSPUN01 SHRLEVEL CHANGE ISOLATION UR; </pre>	

Task	Description	Skills required
	<pre>/* /** /** FTP TO AMAZON S3     BACKED FTP SERVER IF     UNLOAD WAS SUCCESSFUL /** //SFTP EXEC PGM=BPXB TCH,COND=(4,LE),RE GION=0M //STDPARM DD *   SH cp "'/'&amp;USRP FX..DB2.UNLOAD.&amp;JO BNAME'"     &amp;TABNAME..csv; echo "ascii " &gt;&gt; uplcmd; echo "PUT &amp;TABNAME. .csv " &gt;&gt;&gt;&gt; uplcmd; sftp -b uplcmd -i .ssh/ id_rsa &amp;FTPUSER. @&amp;FTPSITE; im &amp;TABNAME..csv; //SYSPRINT DD SYSOUT=* //STDOUT DD SYSOUT=* //STDENV DD * //STDERR DD SYSOUT=*</pre>	

Task	Description	Skills required
Generate the Mass Unload JCL.	<p>This step involves running a REXX script under an ISPF environment by using JCL. Provide the list of in-scope tables created on the first step as input for mass JCL generation against the TABLIST DD name. The JCL will generate one new JCL per table name in a user-specified partitioned dataset specified against the ISPFIL DD name. Allocate this library beforehand. Each new JCL will have two steps: one step to unload the Db2 table into a file, and one step to send the file to the S3 bucket.</p> <p>Make the following changes in the JCL REXXEXEC (you can change the name):</p> <ol style="list-style-type: none"><li>1. Substitute Job card user ID with a mainframe user ID that has unload authority on the tables. Substitute SYSPROC, ISPPLIB, ISPSLIB, ISPMLIB, and ISPTLIB &lt;HLQ1&gt; value or customize the DSN to meet your site standards. To find out your installation-specific values,</li></ol>	Mainframe developer

Task	Description	Skills required
	<p>you use the command TSO ISRDDN.</p> <ol style="list-style-type: none"> <li>2. Substitute &lt;MFUSER&gt; with a user ID that has job-running privileges in your installation.</li> <li>3. Substitute &lt;FTPUSER&gt; with a user ID that has the USS and FTP privilege in your installation.. It is assumed that this user ID and its SSH security keys are in place in the appropriate Unix Systems Services directory on the mainframe.</li> <li>4. Substitute &lt;AWS TransferFamily IP&gt; with the AWS Transfer Family IP address or the domain name. This address will be used for the SFTP step.</li> <li>5. Submit the JCL after applying the site standard accommodation and updating the REXX program as described below.</li> </ol> <p><b>Mass JCL generation job</b></p> <pre>//RUNREXX JOB (CREATEJCL), 'RUNS ISPF TABLIST',</pre>	

Task	Description	Skills required
	<pre> CLASS=A,MSGCLASS=A,  //          TIME=1440 ,NOTIFY=&amp;SYSUID /* Most of the values    required can be updated    to your site specific /* values using the    command 'TSO ISRDDN' in    your ISPF session. /* Update all the lines    tagged with //update    marker to desired /* site specific    values. //ISPF EXEC PGM=IKJEF T01,REGION=2048K,D YNAMNBR=25 //SYSPROC  DD    DISP=SHR,DSN=USER. Z23D.CLIST //SYSEXEC  DD    DISP=SHR,DSN=&lt;HLQ1 &gt;.TEST.REXXLIB //ISPPLIB  DD    DISP=SHR,DSN=ISP.S ISPPENU //ISPSLIB  DD    DISP=SHR,DSN=ISP.S ISPSENU //          DD    DISP=SHR,DSN=&lt;HLQ1 &gt;.TEST.ISPSLIB //ISPMLIB  DD    DSN=ISP.SISPMENU,D ISP=SHR //ISPTLIB  DD    DDNAME=ISPTABL //          DD DSN=ISP.S ISPTENU,DISP=SHR </pre>	

Task	Description	Skills required
	<pre> //ISPTABL DD   LIKE=ISP.SISPTENU,   UNIT=VIO //ISPPROF DD   LIKE=ISP.SISPTENU,   UNIT=VIO //ISPLLOG DD   SYSOUT=*,RECFM=VA,   LRECL=125 //SYSPRINT DD SYSOUT=* //SYSTSPRT DD   SYSOUT=* //SYSUDUMP DD   SYSOUT=* //SYSDBOUT DD   SYSOUT=* //SYSTSPRT DD   SYSOUT=* //SYSUDUMP DD   SYSOUT=* //SYSDBOUT DD   SYSOUT=* //SYSHELP DD   DSN=SYS1.HELP,DISP   =SHR //SYSOUT DD SYSOUT=* /* Input list of   tablenames //TABLIST DD   DISP=SHR,DSN=&lt;HLQ1 &gt;.DSN81210.TABLIST /* Output pds //ISPFIL DD   DISP=SHR,DSN=&lt;HLQ1 &gt;.TEST.JOBGEN //SYSTSIN DD * ISPSTART CMD(ZSTEPS   &lt;MFUSER&gt; &lt;FTPUSER&gt; &lt;AWS   TransferFamily IP&gt;) /* </pre>	

Task	Description	Skills required
	<p>Before you use the REXX script, make the following changes:</p> <ol style="list-style-type: none"><li>1. Save the REXX script in a PDS library defined under the SYSEXEC stack in the JCL REXXEXEC edited in the previous step with ZSTEPS as the member name. If you want to rename it, you should update the JCL to accommodate your needs.</li><li>2. This script uses the trace option to print additional information in case there are errors. You can instead add error handling code after the EXECIO, ISPEXEC, and TSO statements, and remove the trace line.</li><li>3. This script generates member names by using the LODnnnnn naming convention, which can support up to 100,000 members. If you have more than 100,000 tables, use a shorter prefix, and adjust the numbers in the tempjob statement.</li></ol>	



Task	Description	Skills required
	<p><b>ZSTEPS REXX script</b></p> <pre data-bbox="592 283 1031 1806"> /*REXX - - - - - - - - - - - - - - - */ /* 10/27/2021 - added new parms to accommoda te ftp */ Trace "o"     parse arg usrpfx ftpuser ftpsite     Say "Start"     Say "Ftpuser: " ftpuser "Ftpsite:" ftpsite     Say "Reading table name list"     "EXECIO * DISKR TABLIST (STEM LINE. FINIS"     DO I = 1 TO LINE.0     Say I     suffix = I     Say LINE.i     Parse var LINE.i schema table rest     tabname = schema !! "." !! table     Say tabname     tempjob= "LOD" !! RIGHT("0000" !! i, 5)     jobname=tempjob     Say tempjob     ADDRESS ISPEXEC "FTOPEN "     ADDRESS ISPEXEC "FTINCL UNLDSKEL"     /* member will be saved in ISPDSN library allocated in JCL */ </pre>	

Task	Description	Skills required
	<pre> ADDRESS ISPEXEC "FTCLOSE NAME("tem pjob")" END  ADDRESS TSO "FREE F(TABLIST) " ADDRESS TSO "FREE F(ISPFILE) "  exit 0 </pre>	

## Run the JCLs

Task	Description	Skills required
<p>Perform the Db2 Unload step.</p>	<p>After the JCL generation, you will have as many JCLs as you have tables that need to be unloaded.</p> <p>This story uses a JCL-generated example to explain the structure and the most important steps.</p> <p>No action is required on your part. The following information is for reference only. If your intention is to submit the JCLs that you have generated in the previous step, skip to the <i>Submit the LODnnnnn JCLs</i> task.</p> <p>When unloading Db2 data using a JCL with the IBM</p>	<p>Mainframe developer, System engineer</p>

Task	Description	Skills required
	<p>provided DSNUTILB Db2 utility, you must make sure that the unloaded data does not contain compressed numeric data. To accomplish this, use the DSNUTILB DELIMITED parameter.</p> <p>The DELIMITED parameter supports unloading the data in CSV format by adding a character as the delimiter and double quotation marks for the text field, removing the padding in the VARCHAR column, and converting all the numeric fields into EXTERNAL FORMAT, including the DATE fields.</p> <p>The following example shows what the unload step in the generated JCL looks like, using the comma character as a delimiter.</p> <pre data-bbox="592 1396 1031 1837">UNLOAD DELIMITED COLDEL ',' FROM TABLE SCHEMA_NAME.TBNAME UNLDDN SYSREC01 PUNCHDDN SYSPUN01 SHRLEVEL CHANGE ISOLATION UR;</pre>	

Task	Description	Skills required
Perform the SFTP step.	<p>To use the SFTP protocol from a JCL, use the BPXBATCH utility.</p> <p>The SFTP utility can't access the MVS datasets directly. You can use the copy command (cp) to copy the sequential file &amp;USRPFX..DB2.UNLOAD.&amp;JOBNAME to the USS directory, where it becomes &amp;TABNAME..csv .</p> <p>Run the sftp command using the private key (id_rsa) and using the RACF user ID as the user name to connect to the AWS Transfer Family IP address.</p> <pre>SH cp "'/'&amp;USRPFX..DB2.UNLOAD.&amp;JOBNAME'"     &amp;TABNAME..csv; echo "ascii " &gt;&gt; uplcmd; echo "PUT &amp;TABNAME.csv " &gt;&gt;&gt;&gt; uplcmd; sftp -b uplcmd -i .ssh/id_rsa &amp;FTPUSER. @&amp;FTP_TF_SITE; rm &amp;TABNAME..csv;</pre>	Mainframe developer, System engineer

Task	Description	Skills required
Submit the LODnnnnn JCLs.	<p>The prior JCL has generated all LODnnnnn JCL tables that need to be unloaded, transformed into CSV, and transferred to the S3 bucket.</p> <p>Run the submit command on all the JCLs that have been generated.</p>	Mainframe developer, System engineer

## Related resources

For more information about the different tools and solutions used in this document, see the following:

- [z/OS OpenSSH User's Guide](#)
- [Db2 z/OS – Sample UNLOAD control statements](#)
- [Db2 z/OS – Unloading delimited files](#)
- [Transfer Family – Create an SFTP-enabled server](#)
- [Transfer Family – Working with service-managed users](#)

## Additional information

After you have your Db2 data on Amazon S3, you have many ways to develop new insights. Because Amazon S3 integrates with AWS data analytics services, you can freely consume or expose this data on the distributed side. For example, you can do the following:

- Build a [data lake on Amazon S3](#), and extract valuable insights by using query-in-place, analytics, and machine learning tools without moving the data.
- Initiate a [Lambda function](#) by setting up a post-upload processing workflow that is integrated with AWS Transfer Family.

- Develop new microservices for accessing the data in Amazon S3 or in [fully managed database](#) by using [AWS Glue](#), which is a serverless data integration service that makes it easy to discover, prepare, and combine data for analytics, machine learning, and application development.

In a migration use case, because you can transfer any data from the mainframe to S3, you can do the following:

- Retire physical infrastructure, and create a cost-effective data archival strategy with Amazon S3 Glacier and S3 Glacier Deep Archive.
- Build scalable, durable, and secure backup and restore solutions with Amazon S3 and other AWS services, such as S3 Glacier and Amazon Elastic File System (Amazon EFS), to augment or replace existing on-premises capabilities.

## More patterns

- [Replicate mainframe databases to AWS by using Precisely Connect](#)

# Management & governance

## Topics

- [Identify and alert when Amazon Data Firehose resources are not encrypted with an AWS KMS key](#)
- [Automate adding or updating Windows registry entries using AWS Systems Manager](#)
- [Automatically stop and start an Amazon RDS DB instance using AWS Systems Manager Maintenance Windows](#)
- [Centralize software package distribution in AWS Organizations by using Terraform](#)
- [Configure VPC Flow Logs for centralization across AWS accounts](#)
- [Configure logging for .NET applications in Amazon CloudWatch Logs by using NLog](#)
- [Copy AWS Service Catalog products across different AWS accounts and AWS Regions](#)
- [Create alarms for custom metrics using Amazon CloudWatch anomaly detection](#)
- [Create an AWS Cloud9 IDE that uses Amazon EBS volumes with default encryption](#)
- [Document your AWS landing zone design](#)
- [Improve operational performance by enabling Amazon DevOps Guru across multiple AWS Regions, accounts, and OUs with the AWS CDK](#)
- [Implement Account Factory for Terraform \(AFT\) by using a bootstrap pipeline](#)
- [Manage AWS Service Catalog products in multiple AWS accounts and AWS Regions](#)
- [Migrate an AWS member account from AWS Organizations to AWS Control Tower](#)
- [Monitor use of a shared Amazon Machine Image across multiple AWS accounts](#)
- [Set up alerts for programmatic account closures in AWS Organizations](#)
- [More patterns](#)



# Identify and alert when Amazon Data Firehose resources are not encrypted with an AWS KMS key

Created by Ram Kandaswamy (AWS)

**Environment:** Production

**Technologies:** Management & governance; Analytics; Big data; CloudNative; Infrastructure; Security, identity, compliance

**AWS services:** AWS CloudTrail; Amazon CloudWatch; AWS Identity and Access Management; Amazon Kinesis; AWS Lambda; Amazon SNS

## Summary

For compliance, some organizations must have encryption enabled on data delivery resources such as Amazon Data Firehose. This pattern shows a way to monitor, detect, and notify when resources are out of compliance.

To maintain the encryption requirement, this pattern can be used on Amazon Web Services (AWS) to provide automated monitoring and detection of Firehose delivery resources that are not encrypted with AWS Key Management Service (AWS KMS) key. The solution sends alert notifications, and it can be extended to perform automatic remediation. This solution can be applied to an individual account or a multiple-account environment, such as an environment using AWS Landing Zone or AWS Control Tower.

## Prerequisites and limitations

### Prerequisites

- Firehose delivery stream
- Sufficient permissions and familiarity with AWS CloudFormation, which is used in this infrastructure automation

### Limitations

The solution is not real time because it uses AWS CloudTrail events for detection, and there is a delay between the time an unencrypted resource is created and the notification is sent.

## Architecture

### Target technology stack

The solution uses serverless technology and the following services:

- AWS CloudTrail
- Amazon CloudWatch
- AWS Command Line Interface (AWS CLI)
- AWS Identity and Access Management (IAM)
- Amazon Data Firehose
- AWS Lambda
- Amazon Simple Notification Service (Amazon SNS)

### Target architecture

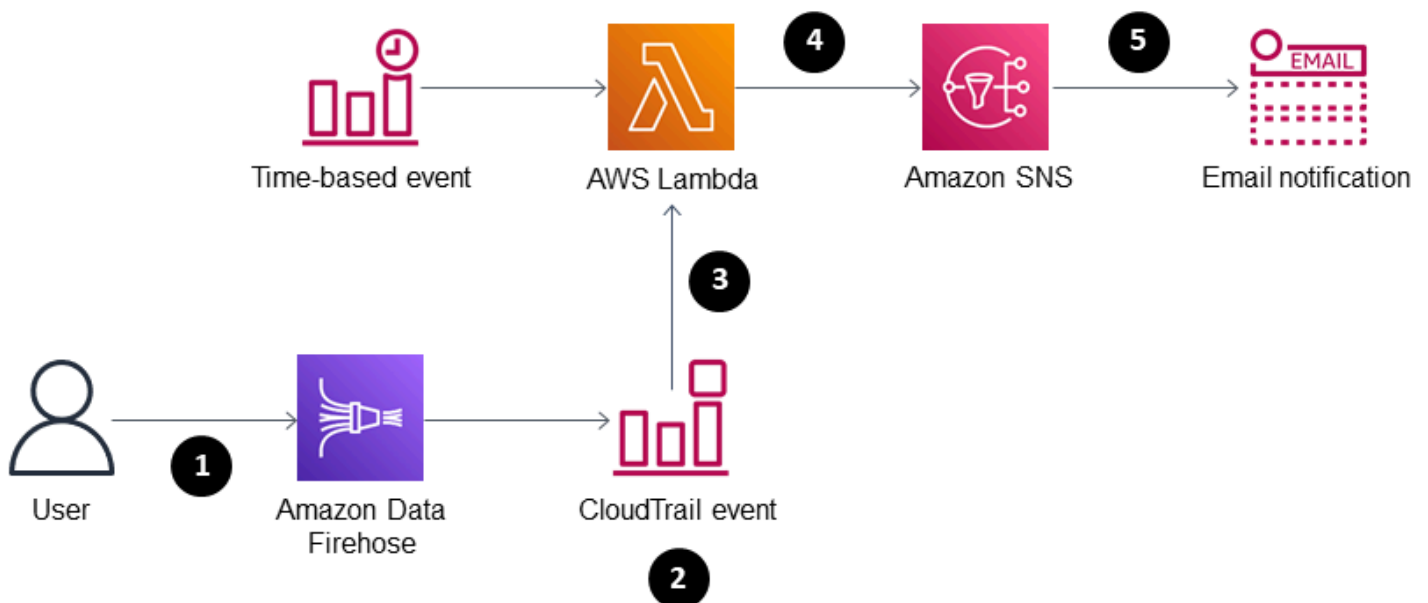

1. A user creates or modifies Firehose.
2. A CloudTrail event is detected and matched.

3. Lambda is invoked.
4. Noncompliant resources are identified.
5. Email notification is sent.

## Automation and scale

Using AWS CloudFormation StackSets, you can apply this solution to multiple AWS Regions or accounts with a single command.

## Tools

- [AWS CloudTrail](#) – AWS CloudTrail is an AWS service that helps you enable governance, compliance, and operational and risk auditing of your AWS account. Actions taken by a user, role, or an AWS service are recorded as events in CloudTrail. Events include actions taken in the AWS Management Console, AWS Command Line Interface, and AWS SDKs and API operations.
- [Amazon CloudWatch Events](#) – Amazon CloudWatch Events delivers a near-real-time stream of system events that describe changes in AWS resources.
- [AWS CLI](#) – AWS Command Line Interface (AWS CLI) is an open source tool that enables you to interact with AWS services using commands in your command line shell.
- [IAM](#) – AWS Identity and Access Management (IAM) is a web service that helps you securely control access to AWS resources. You use IAM to control who is authenticated (signed in) and authorized (has permissions) to use resources.
- [Amazon Data Firehose](#) – Amazon Data Firehose is a fully managed service for delivering real-time streaming data. With Firehose, you don't need to write applications or manage resources. You configure your data producers to send data to Firehose, and it automatically delivers the data to the destination that you specified.
- [AWS Lambda](#) – AWS Lambda is a compute service that supports running code without provisioning or managing servers. Lambda runs your code only when needed and scales automatically, from a few requests per day to thousands per second. You pay only for the compute time that you consume—there is no charge when your code is not running.
- [Amazon SNS](#) – Amazon Simple Notification Service (Amazon SNS) is a managed service that provides message delivery from publishers to subscribers (also known as producers and consumers).

# Epics

## Enforce encryption for compliance

Task	Description	Skills required
Deploy AWS CloudFormation StackSets.	<p>In the AWS CLI, use the <code>firehose-encryption-checker.yaml</code> template (attached) to create the stack set by running the following command. Provide a valid Amazon SNS topic Amazon Resource Name (ARN) for the parameter. The deployment should successfully create CloudWatch Events rules, the Lambda function, and an IAM role with the necessary permissions as described in the template.</p> <pre>aws cloudformation create-stack-set   --stack-set-name my-stack-set -- template-body file:// firehose-encryption- checker.yaml</pre>	Cloud architect, Systems administrator
Create stack instances.	<p>Stacks need to be created in the AWS Regions of your choice as well as in one or more accounts. To create stack instances, run the following command, replacing the stack name,</p>	Cloud architect, Systems administrator

Task	Description	Skills required
	<p>account numbers, and Regions with your own.</p> <pre>aws cloudformation create-stack-insta nces --stack-s et-name my-stack- set --account s 123456789012 223456789012 -- regions us-east-1 us- east-2 us-west-1 us- west-2 --operati on-preferences FailureToleranceCo unt=1</pre>	

## Related resources

- [Working with AWS CloudFormation StackSets](#)
- [What is Amazon CloudWatch Events?](#)

## Additional information

AWS Config does not support the Firehose delivery stream resource type, so an AWS Config rule cannot be used in the solution.

## Attachments

To access additional content that is associated with this document, unzip the following file: [attachment.zip](#)

# Automate adding or updating Windows registry entries using AWS Systems Manager

Created by Appasaheb Bagali (AWS)

**Environment:** PoC or pilot

**Technologies:** Management & governance; CloudNative; DevOps; Infrastructure; Modernization; Security, identity, compliance

**Workload:** Microsoft

**AWS services:** AWS Systems Manager

## Summary

AWS Systems Manager is a remote management tool for Amazon Elastic Compute Cloud (Amazon EC2) instances. Systems Manager provides visibility and control over your infrastructure on Amazon Web Services. This versatile tool can be used to fix Windows registry changes that are identified as vulnerabilities by the security vulnerability scan report.

This pattern covers the steps to keep your EC2 instances that are running Windows operating system secure by automating registry changes that are recommended for the safety of your environment. The pattern uses the Run command to run a Command document. The code is attached, and a portion of it is included in the *Code* section.

## Prerequisites and limitations

- An active AWS account
- Permissions to access the EC2 instance and Systems Manager

## Architecture

### Target technology stack

- A virtual private cloud (VPC), with two subnets and a network address translation (NAT) gateway

- A Systems Manager Command document to add or update the registry name and value
- Systems Manager Run Command to run the Command document on the specified EC2 instances

## Target architecture

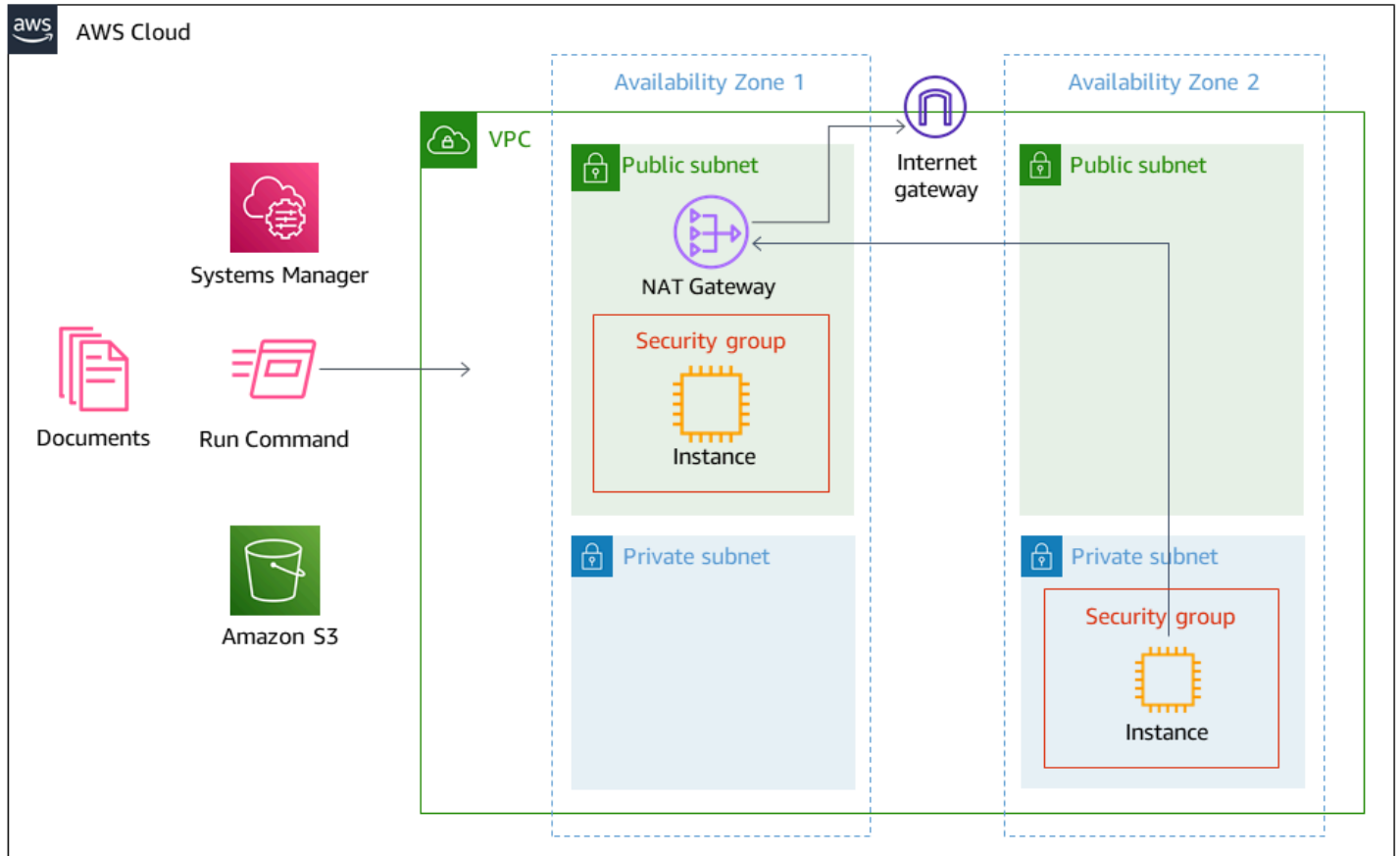

## Tools

### Tools

- [IAM policies and roles](#) – AWS Identity and Access Management (IAM) is a web service that helps you securely control access to AWS resources. You use IAM to control who is authenticated (signed in) and authorized (has permissions) to use resources.
- [Amazon Simple Storage Service](#) – Amazon Simple Storage Service (Amazon S3) is storage for the internet. It is designed to make web-scale computing easier for developers. In this pattern, an S3 bucket is used to store the Systems Manager logs.
- [AWS Systems Manager](#) – AWS Systems Manager is an AWS service that you can use to view and control your infrastructure on AWS. Systems Manager helps you maintain security and

compliance by scanning your *managed instances* and reporting (or taking corrective action on) any policy violations it detects.

- [AWS Systems Manager Command document](#) – AWS Systems Manager Command documents are used by Run Command. Most Command documents are supported on all Linux and Windows Server operating systems supported by Systems Manager.
- [AWS Systems Manager Run Command](#) – AWS Systems Manager Run Command gives you a way to manage the configuration of your managed instances remotely and securely. Using Run Command, you can automate common administrative tasks and perform one-time configuration changes at scale.

## Code

You can use the following example code to add or update a Microsoft Windows registry name to Version, registry path to HKCU:\Software\ScriptingGuys\Scripts, and value to 2.

```
#Windows registry path which needs to add/update
$registryPath = 'HKCU:\\Software\\ScriptingGuys\\Scripts'
#Windows registry Name which needs to add/update
$Name = 'Version'
#Windows registry value which needs to add/update
$value = 2
# Test-Path cmdlet to see if the registry key exists.
IF(!(Test-Path $registryPath))
{
    New-Item -Path $registryPath -Force | Out-Null
    New-ItemProperty -Path $registryPath -Name $name -Value $value ` -
PropertyType DWORD - Force | Out- Null
} ELSE {
    New-ItemProperty -Path $registryPath -Name $name -Value $value `
-PropertyType DWORD -Force | Out-Null
}
echo 'Registry Path:$registryPath
echo 'Registry Name:$registryPath
echo 'Registry Value: '(Get-ItemProperty -Path $registryPath -Name $Name).version
```

The full Systems Manager Command document JavaScript Object Notation (JSON) code example is attached.



## Epics

### Set up a VPC

Task	Description	Skills required
Create a VPC.	On the AWS Management Console, create a VPC that has public and private subnets and a NAT gateway. For more information, see the <a href="#">AWS documentation</a> .	Cloud administrator
Create security groups.	Ensure that each security group allows access for Remote Desktop Protocol (RDP) from the source IP address.	Cloud administrator

### Create an IAM policy and an IAM role

Task	Description	Skills required
Create an IAM policy.	Create an IAM policy that provides access to Amazon S3, Amazon EC2, and Systems Manager.	Cloud administrator
Create an IAM role.	Create an IAM role, and attach the IAM policy that provides access to Amazon S3, Amazon EC2, and Systems Manager.	Cloud administrator

## Run the automation

Task	Description	Skills required
Create the Systems Manager Command document.	Create a Systems Manager Command document that will deploy the Microsoft Windows registry changes to add or update.	Cloud administrator
Run the Systems Manager Run Command.	Run the Systems Manager Run Command, selecting the Command document and the Systems Manager target instances. This pushes the Microsoft Windows registry change in the selected Command document to the target instances.	Cloud administrator

## Related resources

- [AWS Systems Manager](#)
- [AWS Systems Manager documents](#)
- [AWS Systems Manager Run Command](#)

## Attachments

To access additional content that is associated with this document, unzip the following file:  
[attachment.zip](#)

# Automatically stop and start an Amazon RDS DB instance using AWS Systems Manager Maintenance Windows

Created by Ashita Dsilva (AWS)

**Environment:** Production

**Technologies:** Management & governance; Cost management; Databases

**AWS services:** AWS Systems Manager; Amazon RDS

## Summary

This pattern demonstrates how to automatically stop and start an Amazon Relational Database Service (Amazon RDS) DB instance on a specific schedule (for example, shutting down a DB instance outside of business hours to reduce costs) by using AWS Systems Manager Maintenance Windows.

AWS Systems Manager Automation provides the `AWS-StopRdsInstance` and `AWS-StartRdsInstance` runbooks to stop and start Amazon RDS DB instances. This means that you don't need to write custom logic with AWS Lambda functions or create an Amazon CloudWatch Events rule.

Systems Manager provides two capabilities for scheduling tasks: [State Manager](#) and [Maintenance Windows](#). State Manager sets and maintains the required state configuration for resources in your Amazon Web Services (AWS) account one time or on a specific schedule. Maintenance Windows runs tasks on the resources in your account during a specific time window. Although you can use this pattern's approach with State Manager or Maintenance Windows, we recommend that you use Maintenance Windows because it can run one or more tasks based on assigned priority and can also run AWS Lambda functions and AWS Step Functions tasks. For more information about State Manager and Maintenance Windows, see [Choosing between State Manager and Maintenance Windows](#) in the Systems Manager documentation.

This pattern provides detailed steps to configure two separate maintenance windows that use cron expressions to stop and then start an Amazon RDS DB instance.

## Prerequisites and limitations

### Prerequisites

- An active AWS account.
- An existing Amazon RDS DB instance that you want to stop and start on a specific schedule.
- Cron expressions for your required schedule. For example, the expression `cron(0 9 ? * MON-FRI *)` runs the task at 09:00 on every Monday, Tuesday, Wednesday, Thursday, and Friday. For more information, see [Cron and rate expressions for maintenance windows](#) in the Systems Manager documentation.
- Familiarity with Systems Manager.
- Permissions to start and stop the RDS instance. For more information, see the [Epics](#) section.

## Limitations

- An Amazon RDS DB instance can be stopped for up to seven days at one time. After seven days, the DB instance automatically restarts to ensure that it receives any required maintenance updates.
- You can't stop a DB instance that is a read replica or that has a read replica.
- You can't stop an Amazon RDS for SQL Server DB instance in a Multi-AZ configuration.
- Service quotas apply to Maintenance Windows and Systems Manager Automation. For more information about service quotas, see [AWS Systems Manager endpoints and quotas](#) in the AWS General Reference documentation.
- Some AWS services aren't available in all AWS Regions. For Region availability, see [AWS services by Region](#). For specific endpoints, see the [Service endpoints and quotas](#) page, and choose the link for the service.

## Architecture

The following diagram shows the workflow to automatically stop and start an Amazon RDS DB instance.

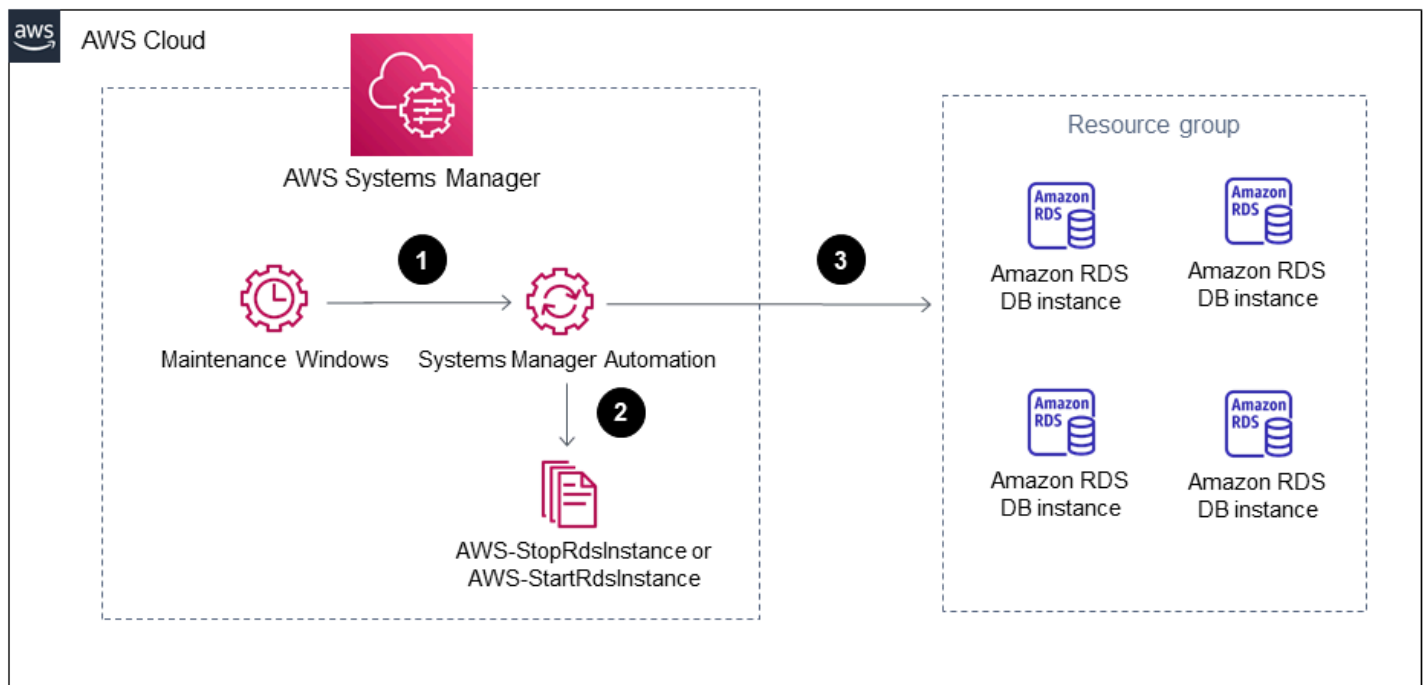

The workflow has the following steps:

1. Create a maintenance window and use cron expressions to define the stop and start schedule for your Amazon RDS DB instances.
2. Register a Systems Manager Automation task to the maintenance window by using the `AWS-StopRdsInstance` or `AWS-StartRdsInstance` runbook.
3. Register a target with the maintenance window by using a tag-based resource group for your Amazon RDS DB instances.

### Technology stack

- AWS CloudFormation
- AWS Identity and Access Management (IAM)
- Amazon RDS
- Systems Manager

### Automation and scale

You can stop and start multiple Amazon RDS DB instances at the same time by tagging the required Amazon RDS DB instances, creating a resource group that includes all the tagged DB instances, and registering this resource group as a target for the maintenance window.

## Tools

- [AWS CloudFormation](#) is a service that helps you model and set up your AWS resources.
- [AWS Identity and Access Management \(IAM\)](#) is a web service that helps you securely control access to AWS resources.
- [Amazon Relational Database Service \(Amazon RDS\)](#) is a web service that makes it easier to set up, operate, and scale a relational database in the AWS Cloud.
- [AWS Resource Groups](#) helps you organize AWS resources into groups, tag resources, and manage, monitor, and automate tasks on grouped resources.
- [AWS Systems Manager](#) is an AWS service that you can use to view and control your infrastructure on AWS. This pattern uses the following features of Systems Manager:
  - [AWS Systems Manager Automation](#) simplifies common maintenance and deployment tasks of Amazon Elastic Compute Cloud (Amazon EC2) instances and other AWS resources.
  - [AWS Systems Manager Maintenance Windows](#) helps you define a schedule for when to perform potentially disruptive actions on your instances.

## Epics

### Create and configure the IAM service role for Systems Manager Automation

Task	Description	Skills required
Configure the IAM service role for Systems Manager Automation.	<p>Sign in to the AWS Management Console and create a service role for Systems Manager Automation. You can use one of the following two methods to create this service role:</p> <ul style="list-style-type: none"> <li>• <a href="#">Use AWS CloudFormation to configure a service role for Systems Manager Automation</a></li> </ul>	AWS administrator

Task	Description	Skills required
	<ul style="list-style-type: none"><li>• <a href="#">Use IAM to configure roles for Systems Manager Automation</a></li></ul> <p>The Systems Manager Automation workflow invokes Amazon RDS by using a service role to perform start and stop actions on the Amazon RDS DB instance.</p> <p>The service role must be configured with the following <a href="#">inline policy</a> that has permissions to start and stop the Amazon RDS DB instance:</p> <pre data-bbox="592 1045 1031 1858">{   "Version":   "2012-10-17",   "Statement": [     {       "Sid":       "RdsStartStop",       "Effect":       "Allow",       "Action": [         "rds:StopDBInstance",         "rds:StartDBInstance"       ],       "Resource":       "&lt;RDS_Instance_ARN&gt;"     }   ],   {</pre>	

Task	Description	Skills required
	<pre data-bbox="609 210 1015 703">         "Sid":         "RdsDescribe",         "Effect":         "Allow",         "Action":         "rds:DescribeDBIns         tances",         "Resource":         "*"       }     ]   } </pre> <p data-bbox="592 745 1015 966">Make sure that you replace &lt;RDS_Instance_ARN&gt; with the Amazon Resource Name (ARN) of your Amazon RDS DB instance.</p> <p data-bbox="592 1008 1015 1333">If you are unfamiliar with using IAM policies and roles, follow the instructions in the <i>Solution Overview</i> section of the <a href="#">Schedule Amazon RDS stop and start using AWS Systems Manager</a> blog post.</p> <p data-bbox="592 1375 1015 1501"><b>Important:</b> Make sure that you record the ARN of the service role.</p>	

## Create a resource group

Task	Description	Skills required
Tag the Amazon RDS DB instances.	Open the <a href="#">Amazon RDS console</a> and tag the Amazon	AWS administrator



Task	Description	Skills required
	<p>RDS DB instances that you want to add to the resource group. A tag is metadata assigned to an AWS resource and consists of a key-value pair. We recommend that you use <i>Action</i> as the <b>Tag key</b> and <i>StartStop</i> as the <b>Value</b>.</p> <p>For more information about this, see <a href="#">Adding, listing, and removing tags</a> in the Amazon RDS documentation.</p>	

Task	Description	Skills required
Create a resource group for your tagged Amazon RDS DB instances.	<p>Open the <a href="#">AWS Resource Groups console</a> and create a resource group based on the tag that you created for your Amazon RDS DB instances.</p> <p>Under <b>Grouping Criteria</b>, make sure that you choose <b>AWS::RDS::DBInstance</b> for the resource type and then provide the tag's key-value pair (for example, "Action-StartStop"). This ensures that the service only checks for Amazon RDS DB instances and not other resources that have this tag. Make sure that you record the resource group's name.</p> <p>For more information and detailed steps, see <a href="#">Build a tag-based query and create a group</a> in the AWS Resource Groups documentation.</p>	AWS administrator

### Configure a maintenance window to stop the Amazon RDS DB instances

Task	Description	Skills required
Create a maintenance window.	<ol style="list-style-type: none"> <li>Open the <a href="#">Systems Manager console</a>, choose <b>Maintenance Windows</b>, and then choose <b>Create a maintenance window</b>.</li> </ol>	AWS administrator

Task	Description	Skills required
	<p>Provide a name for your maintenance window (for example, "StopRdsInstance"), enter a description, and then uncheck <b>Allow unregistered targets</b>.</p> <ol style="list-style-type: none"><li>2. Choose <b>CRON/Rate expression</b> and provide the schedule expression to define when the Amazon RDS DB instances should be stopped. Enter <b>1</b> for the <b>Duration</b> and <b>0</b> for <b>Stop initiating tasks</b>. By default, the <b>Time zone</b> shows UTC. You can change the time zone to initiate the maintenance window based on the timestamp defined in your cron expression.</li><li>3. Choose <b>Create maintenance window</b>. The system returns you to the maintenance window page and the state of your maintenance window is <b>Enabled</b>.</li></ol> <p><b>Important:</b> The task to stop the DB instance runs almost instantly when initiated and doesn't span the entire</p>	

Task	Description	Skills required
	<p>duration of the maintenance window. This pattern provides the minimum values for <b>Duration</b> and <b>Stop initiating tasks</b> because they are the required parameters for a maintenance window.</p> <p>For more information and detailed steps, see <a href="#">Create a maintenance window (console)</a> in the Systems Manager documentation.</p>	

Task	Description	Skills required
Assign a target to the maintenance window.	<ol style="list-style-type: none"><li>1. On the <a href="#">Systems Manager console</a>, choose <b>Maintenance Windows</b>, choose <b>Actions</b>, and then choose <b>Register targets</b>.</li><li>2. In the <b>Targets</b> area, specify <b>Choose a resource group</b> and then choose the name of an existing resource group in your account.</li><li>3. For <b>Resource types</b>, choose <b>AWS::RDS::DBInstance</b> and then choose <b>Register target</b>.</li></ol> <p>For more information and detailed steps, see <a href="#">Assign targets to a maintenance window (console)</a> in the Systems Manager documentation.</p>	AWS administrator

Task	Description	Skills required
Assign a task to the maintenance window.	<ol style="list-style-type: none"><li>1. On the <a href="#">Systems Manager console</a>, choose <b>Maintenance Windows</b>, and then choose your maintenance window. Choose <b>Actions</b>, and then choose <b>Register Automation task</b>.</li><li>2. For <b>Document</b>, choose <b>AWS-StopRdsInstance</b>.</li><li>3. In the <b>Targets</b> section, choose <b>Selecting registered target groups</b>, and then choose the maintenance window target that you registered with the current maintenance window.</li><li>4. For <b>Rate control</b>, specify 100 percent for <b>Concurrency</b> and <b>Error threshold</b>. You can change the <b>Rate control</b> values according to your requirements for task concurrency and error threshold. For more information about this, see <a href="#">About concurrency and error thresholds</a> in the Systems Manager documentation.</li><li>5. In the <b>IAM service role</b> section, for <b>Service role</b>, leave this box blank or create your own custom role. If you leave the box</li></ol>	AWS administrator

Task	Description	Skills required
	<p>blank, Systems Manager automatically creates the service-linked role <b>AWSServiceRoleForAmazonSSM</b> and then associates the role with the task. To create your own custom role, see <a href="#">Create a custom service role for maintenance windows (console)</a>, and then associate that custom role with the task.</p> <p>6. In the <b>Input Parameters</b> section, specify the following parameters for the runbook:</p> <ul style="list-style-type: none"> <li>• <b>InstanceID</b>: <code>{{RESOURCE_ID}}</code></li> </ul> <p><b>Note:</b> For <b>InstanceID</b>, a pseudo parameter is used to extract the Amazon RDS DB resource ID from the ARN. To learn more about pseudo parameters, see <a href="#">About pseudo parameters</a> in the Systems Manager documentation.</p> <ul style="list-style-type: none"> <li>• <b>AutomationAssumeRole</b>: Provide the ARN of the service role that</li> </ul>	

Task	Description	Skills required
	<p>you created for Systems Manager Automation.</p> <p>7. Choose <b>Register Automation task</b>.</p> <p><b>Important:</b> The <b>Service role</b> option defines the service role required for the maintenance window to run tasks. However, this role is not identical to the service role that you created earlier for Systems Manager Automation.</p> <p>For more information and detailed steps, see <a href="#">Assign tasks to a maintenance window (console)</a> in the Systems Manager documentation.</p>	

## Configure a maintenance window to start the Amazon RDS DB instances

Task	Description	Skills required
Configure a maintenance window to start the Amazon RDS DB instances.	Repeat the steps from the <i>Configure a maintenance window to stop the Amazon RDS DB instances</i> epic to configure another maintenance window to start the Amazon RDS DB instances at a scheduled time.	AWS administrator



Task	Description	Skills required
	<p><b>Important:</b> You must make the following changes when you configure the maintenance window to start the DB instances:</p> <ul style="list-style-type: none"><li>• Use a new name for the maintenance window (for example, "StartRdsInstance").</li><li>• Replace the cron expression with the cron expression that you want to use to start the DB instances.</li><li>• Replace the AWS-StopRdsInstance runbook with AWS-StartRdsInstance in <b>Task</b>.</li></ul>	

## Related resources

- [Use Systems Manager Automation documents to manage instances and cut costs off-hours](#) (AWS blog post)

# Centralize software package distribution in AWS Organizations by using Terraform

Created by Pradip kumar Pandey (AWS), Aarti Rajput (AWS), Chintamani Aphale (AWS), T.V.R.L.Phani Kumar Dadi (AWS), Mayuri Shinde (AWS), and Pratap Kumar Nanda (AWS)

**Environment:** Production

**Technologies:** Management & governance; Infrastructure

**AWS services:** AWS Organizations; AWS Systems Manager

## Summary

Enterprises often maintain multiple AWS accounts that are spread across multiple AWS Regions in order to create a strong isolation barrier between workloads. To stay secure and compliant, their administration teams install agent-based tools such as [CrowdStrike](#), [SentinelOne](#), or [TrendMicro](#) tools for security scanning, and the [Amazon CloudWatch agent](#), [Datadog Agent](#), or [AppDynamics agents](#) for monitoring. These teams often face challenges when they want to centrally automate software package management and distribution across this large landscape.

[Distributor](#), a capability of [AWS Systems Manager](#), automates the process of packaging and publishing software to managed Microsoft Windows and Linux instances across the cloud and on-premises servers through a single simplified interface. This pattern demonstrates how you can use Terraform to further simplify the process of managing the installation of software and to run scripts across a large number of instances and member accounts within AWS Organizations with minimal effort.

This solution works for Amazon, Linux, and Windows instances that are managed by Systems Manager.

## Prerequisites and limitations

- A [Distributor package](#) that has the software to be installed
- [Terraform](#) version 0.15.0 or later
- Amazon Elastic Compute Cloud (Amazon EC2) instances that are [managed by Systems Manager](#) and have basic [permissions to access Amazon Simple Storage Service \(Amazon S3\)](#) in the target account

- A landing zone for your organization that's set up by using [AWS Control Tower](#)
- (Optional) [Account Factory for Terraform \(AFT\)](#)

## Architecture

### Resource details

This pattern uses [Account Factory for Terraform \(AFT\)](#) to create all required AWS resources and the code pipeline to deploy the resources in a deployment account. The code pipeline runs in two repositories:

- **Global customization** contains Terraform code that will run across all accounts registered with AFT.
- **Account customizations** contains Terraform code that will run in the deployment account.

You can also deploy this solution without using AFT, by running [Terraform](#) commands in the account customizations folder.

The Terraform code deploys the following resources:

- AWS Identity and Access Management (IAM) role and policies
  - [SystemsManager-AutomationExecutionRole](#) grants the user permissions to run automations in the target accounts.
  - [SystemsManager-AutomationAdministrationRole](#) grants the user permissions to run automations in multiple accounts and organizational units (OUs).
- Compressed files and manifest.json for the package
  - In Systems Manager, a [package](#) includes at least one .zip file of software or installable assets.
  - The JSON manifest includes pointers to your package code files.
- S3 bucket
  - The distributed package that is shared across the organization is securely stored in an Amazon S3 bucket.
- AWS Systems Manager documents (SSM documents)
  - `DistributeSoftwarePackage` contains the logic to distribute the software package to every target instance in the member accounts.

- `AddSoftwarePackageToDistributor` contains the logic to package the installable software assets and add it to Automation, a capability of AWS Systems Manager.
- Systems Manager association
- A Systems Manager association is used to deploy the solution.

## Architecture and workflow

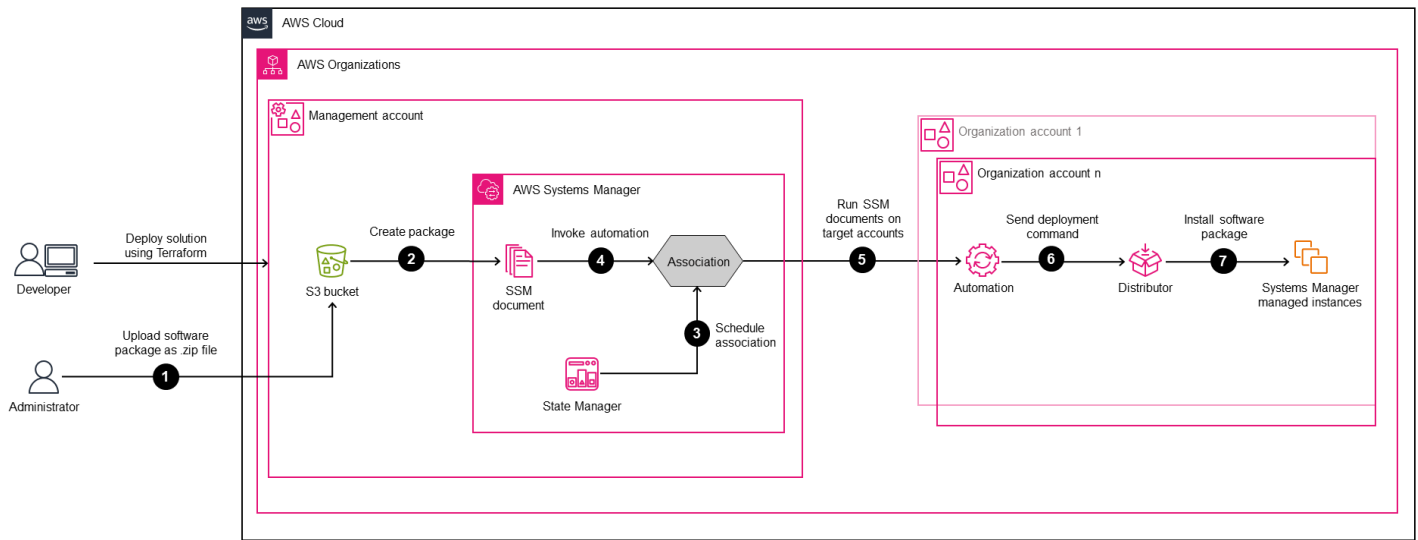

The diagram illustrates the following steps:

1. To run the solution from a centralized account, you upload your packages or software along with deployment steps to an S3 bucket.
2. Your customized package becomes available in the Systems Manager console [Documents](#) section, in the **Owned by me** tab.
3. State Manager, a capability of Systems Manager, creates, schedules, and runs an association for the package across the organization. The association specifies that the software package must be installed and running on a managed node before it can be installed on the target node.
4. The association instructs Systems Manager to install the package on the target node.
5. For any subsequent installations or changes, users can run the same association periodically or manually from a single location to perform deployments across accounts.
6. In member accounts, Automation sends deployment commands to Distributor.
7. Distributor distributes software packages across instances.

This solution uses the management account within AWS Organizations, but you can also designate an account (delegated administrator) to manage this on behalf of the organization.

## Tools

### AWS services

- [Amazon Simple Storage Service \(Amazon S3\)](#) is a cloud-based object storage service that helps you store, protect, and retrieve any amount of data. This pattern uses Amazon S3 to centralize and securely store the distributed package.
- [AWS Systems Manager](#) helps you manage your applications and infrastructure running in the AWS Cloud. It simplifies application and resource management, shortens the time to detect and resolve operational problems, and helps you manage your AWS resources securely at scale. This pattern uses the following Systems Manager capabilities:
  - [Distributor](#) helps you package and publish software to Systems Manager managed instances.
  - [Automation](#) simplifies common maintenance, deployment, and remediation tasks for many AWS services.
  - [Documents](#) performs actions on your Systems Manager managed instances across your organization and accounts.
- [AWS Organizations](#) is an account management service that helps you consolidate multiple AWS accounts into an organization that you create and centrally manage.

### Other tools

- [Terraform](#) is an infrastructure as code (IaC) tool from HashiCorp that helps you create and manage cloud and on-premises resources.

### Code repository

The instructions and code for this pattern are available in the GitHub [Centralized package distribution](#) repository.

## Best practices

- To assign tags to an association, use the [AWS Command Line Interface \(AWS CLI\)](#) or the [AWS Tools for PowerShell](#). Adding tags to an association by using the Systems Manager console

isn't supported. For more information, see [Tagging Systems Manager resources](#) in the Systems Manager documentation.

- To run an association by using a new version of a document shared from another account, set the document version to default.
- To tag only the target node, use one tag key. If you want to target your nodes by using multiple tag keys, use the resource group option.

## Epics

### Configure source files and accounts

Task	Description	Skills required
Clone the repository.	<ol style="list-style-type: none"> <li>1. Clone the GitHub <a href="#">Centralized package distribution</a> repository:           <pre>git clone https://github.com/aws-samples/aws-organization-centralised-package-distribution</pre> </li> <li>2. The Terraform code repository requires two customization folders that are managed by AFT. Confirm that your local copy of the repository contains these folders:           <pre>\$ cd centralised-package-distribution \$ ls global-customization account-customization</pre> </li> </ol>	DevOps engineer

Task	Description	Skills required
Update global variables.	<p>Update the following input parameters in the <code>global-customization/variables.tf</code> file. These variables apply to all accounts that are created and managed by AFT.</p> <ul style="list-style-type: none"><li>• <code>account_id</code> : The ID of the account where the Distributor solution will be deployed.</li><li>• <code>aws_region</code> : The AWS Region where the association will be deployed.</li></ul>	DevOps engineer
Update account variables.	<p>Update the following input parameters in the <code>account-customization/variables.tf</code> file. These variables apply only to specific accounts that are created and managed by AFT.</p> <ul style="list-style-type: none"><li>• <code>package_bucket_name</code> : The name of the S3 bucket that contains the package distribution file.</li><li>• <code>package_name</code> : The name of the package distribution file.</li><li>• <code>package_version</code> : The package version of the installer.</li></ul>	DevOps engineer

## Customize parameters and deployment files

Task	Description	Skills required
Update input parameters for the State Manager association.	<p>Update the following input parameters in the <code>account-customization/association.tf</code> file to define the state you want to maintain on your instances. You can use the default parameter values if they support your use case.</p> <ul style="list-style-type: none"><li>• <code>targetAccounts</code> : The organizational unit (OU) IDs within AWS Organizations that represent accounts with the target instances for distribution. OU IDs start with "ou".</li><li>• <code>targetRegions</code> : The AWS Regions (for example, "us-east-1" or "ap-south-east-2") where the target instances are running.</li><li>• <code>action</code>: Specify whether to install or uninstall the package.</li><li>• <code>installationType</code> : One of the following installation types:<ul style="list-style-type: none"><li>• <code>uninstall</code> : The package is uninstalled.</li><li>• <code>reinstall</code> : The application is taken</li></ul></li></ul>	DevOps engineer



Task	Description	Skills required
	<p>offline until the reinstallation process is complete.</p> <ul style="list-style-type: none"> <li>• <b>In-place update:</b> The application is available while new or updated files are added to the installation.</li> <li>• <b>name:</b> The name of the package to install or uninstall.</li> <li>• <b>version:</b> The version of the package to install or uninstall. If no version of the package is installed, the system returns an error.</li> <li>• <b>bucketName :</b> The S3 bucket name the package has been deployed to. This bucket should consist of the packages and the manifest file only.</li> <li>• <b>bucketPrefix :</b> The S3 prefix where the package assets are stored.</li> <li>• <b>AutomationAssumeRole :</b> The Amazon Resource Name (ARN) of <code>SystemsManager-AutomationAdministrationRole</code> .</li> </ul>	

Task	Description	Skills required
Prepare compressed files and the <code>manifest.json</code> file for the package.	<p>This pattern provides sample PowerShell installable files (.msi for Windows and .rpm for Linux) with install and uninstall scripts in the <code>account-customization/package</code> folder.</p> <ol style="list-style-type: none"> <li>1. Replace the PowerShell installable files with your own files, or provide your installable file, install and uninstall scripts, and manifest file to create a package in the <code>account-customization</code> folder in your account.</li> <li>2. Customize the default <code>manifest.json</code> file that Terraform generates in the <code>account-customization</code> folder according to your requirements.</li> </ol>	DevOps engineer

## Run Terraform commands to provision resources

Task	Description	Skills required
Initialize the Terraform configuration.	<p>To deploy the solution automatically with AFT, push the code to AWS CodeCommit:</p> <pre data-bbox="592 1822 1026 1873">\$ git add *</pre>	DevOps engineer

Task	Description	Skills required
	<pre>\$ git commit -m "message" \$ git push</pre> <p>You can also deploy this solution without using AFT by running a Terraform command from the <code>account-customization</code> folder. To initialize the working directory that contains the Terraform files, run:</p> <pre>\$ terraform init</pre>	
Preview changes.	<p>To preview the changes that Terraform will make to the infrastructure, run the command:</p> <pre>\$ terraform plan</pre> <p>This command evaluates the Terraform configuration to determine the desired state of the resources that have been declared. It also compares the desired state with the actual infrastructure to provision within the workspace.</p>	DevOps engineer

Task	Description	Skills required
Apply changes.	<p>Run the following command to implement the changes that you made to the <code>variables.tf</code> files:</p> <pre>\$ terraform apply</pre>	DevOps engineer

## Validate resources

Task	Description	Skills required
Validate the creation of SSM documents.	<ol style="list-style-type: none"> <li>On the <a href="#">Systems Manager console</a>, in the left navigation pane, choose <b>Documents</b>.</li> <li>Choose the <b>Owned by me</b> tab.</li> </ol> <p>You should see the <code>DistributeSoftwarePackage</code> and <code>AddSoftwarePackageToDistributor</code> packages.</p>	DevOps engineer
Validate the successful deployment of automations.	<ol style="list-style-type: none"> <li>On the Systems Manager console, in the left navigation pane, choose <b>Automation</b>.</li> <li>In the <b>Automation executions</b> list, you should see the most recent <code>DistributeSoftwarePackage</code> and <code>AddSoftware</code></li> </ol>	DevOps engineer

Task	Description	Skills required
	<p>rePackageToDistributor deployments.</p> <p>3. Choose <b>Execution ID</b> to validate that they completed successfully.</p>	
<p>Validate that the package deployed to the targeted member account instances.</p>	<ol style="list-style-type: none"> <li>1. On the Systems Manager console, in the navigation pane, choose <b>Run Command</b>.</li> <li>2. In <b>Command history</b>, you will see each invocation and its status.</li> <li>3. Choose any <b>Command ID</b> to see the deployment history for each target instance.</li> <li>4. Choose the <b>Instance ID</b> and check the <b>Output</b> section for the distribution.</li> </ol>	<p>DevOps engineer</p>

## Troubleshooting

Issue	Solution
<p>The State Manager association failed or is stuck in pending status.</p>	<p>See the <a href="#">troubleshooting information</a> in the AWS Knowledge Center.</p>
<p>A scheduled association failed to run.</p>	<p>Your schedule specification might be invalid. State Manager doesn't currently support specifying months in cron expressions for associations. Use <a href="#">cron or rate expressions</a> to confirm the schedule.</p>

## Related resources

- [Centralized package distribution](#) (GitHub repository)
- [Account Factory for Terraform \(AFT\)](#)
- [Use cases and best practices](#) (AWS Systems Manager documentation)

# Configure VPC Flow Logs for centralization across AWS accounts

Created by Benjamin Morris (AWS) and Aman Kaur Gandhi (AWS)

**Environment:** Production

**Technologies:** Management & governance

**AWS services:** Amazon S3; Amazon VPC

## Summary

In an Amazon Web Services (AWS) virtual private cloud (VPC), the VPC Flow Logs feature can provide useful data for operational and security troubleshooting. However, there are limitations on using VPC Flow Logs in a multi-account environment. Specifically, cross-account flow logs from Amazon CloudWatch Logs are not supported. Instead, you can centralize the logs by configuring an Amazon Simple Storage Service (Amazon S3) bucket with the appropriate bucket policy.

**Note:** This pattern discusses the requirements for sending flow logs to a centralized location. However, if you also want logs to be available locally in member accounts, you can create multiple flow logs for each VPC. Users without access to the Log Archive account can see traffic logs for troubleshooting. Alternatively, you can configure a single flow log for each VPC that sends logs to CloudWatch Logs. You can then use an Amazon Data Firehose subscription filter to forward the logs to an S3 bucket. For more information, see the [Related resources](#) section.

## Prerequisites and limitations

### Prerequisites

- An active AWS account
- An AWS Organizations organization with an account that is used to centralize logs (for example, Log Archive)

### Limitations

If you use the AWS Key Management Service (AWS KMS) managed key `aws/s3` to encrypt your central bucket, it won't receive logs from a different account. Instead, you will see an error that looks like the following.

```
"Unsuccessful": [  
  {  
    "Error": {  
      "Code": "400",  
      "Message": "LogDestination: <bucketName> is undeliverable"  
    },  
    "ResourceId": "vpc-1234567890123456"  
  }  
]
```

This is because an account's AWS managed keys can't be shared across accounts.

The solution is to use either Amazon S3 managed encryption (SSE-S3) or an AWS KMS customer managed key that you can share with member accounts.

## Architecture

### Target technology stack

In the following diagram, two flow logs are deployed for each VPC. One sends logs to a local CloudWatch Logs group. The other sends logs to an S3 bucket in a centralized logging account. The bucket policy permits the log delivery service to write logs to the bucket.

**Note:** As of November 2023, AWS now supports the [aws:SourceOrgID condition key](#). This condition allows you to deny writing to the centralized bucket for accounts outside of your AWS Organizations organization.

### Target architecture



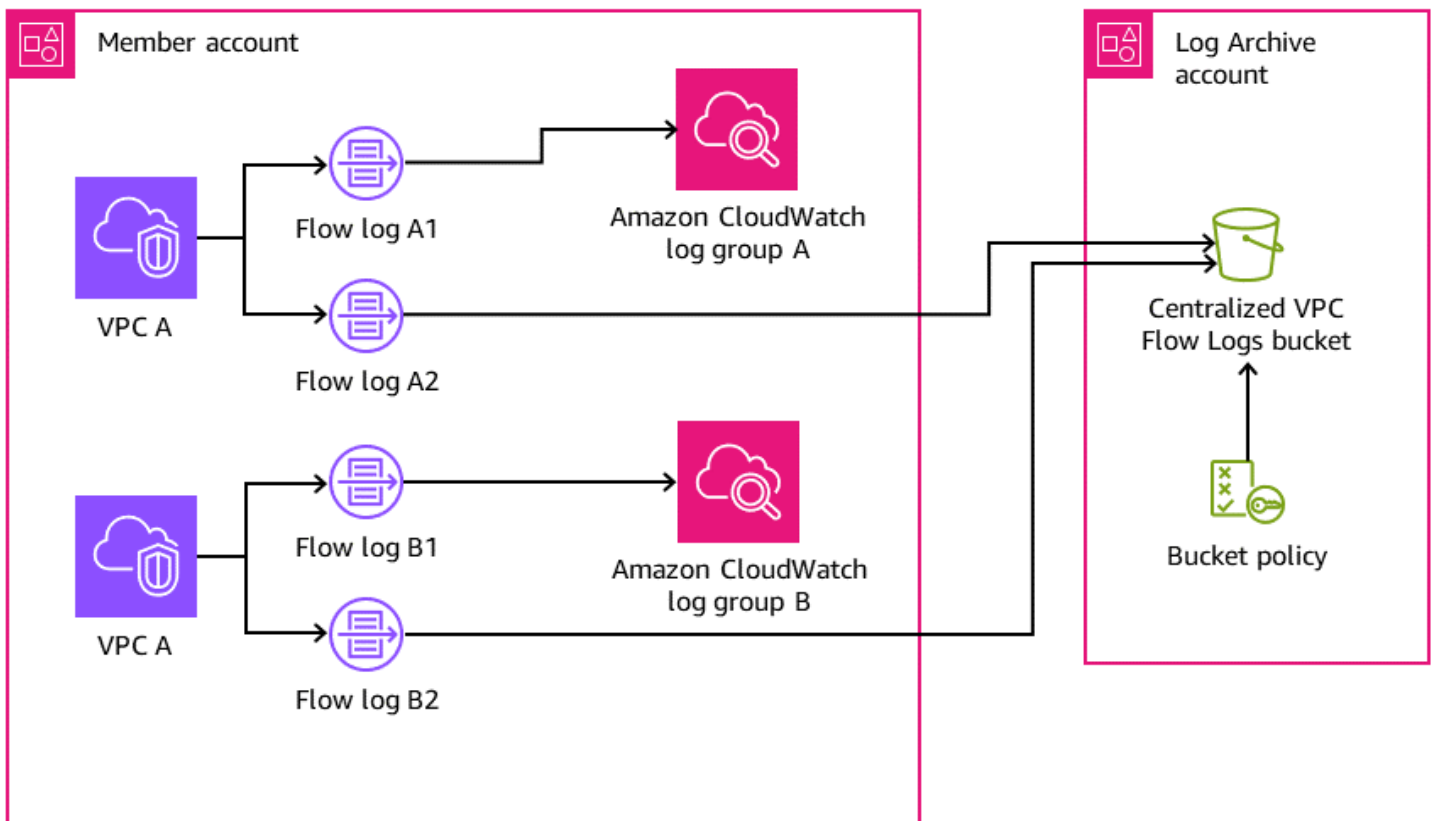

## Automation and scale

Each VPC is configured to send logs to the S3 bucket in the central logging account. Use one of the following automation solutions to help ensure that flow logs are configured appropriately:

- [AWS CloudFormation StackSets](#)
- [AWS Control Tower Account Factory for Terraform \(AFT\)](#)
- [An AWS Config rule with remediation](#)

## Tools

### Tools

- [Amazon CloudWatch Logs](#) helps you centralize the logs from all your systems, applications, and AWS services so you can monitor them and archive them securely.
- [Amazon Simple Storage Service \(Amazon S3\)](#) is a cloud-based object storage service that helps you store, protect, and retrieve any amount of data.

- [Amazon Virtual Private Cloud \(Amazon VPC\)](#) helps you launch AWS resources into a virtual network that you've defined. This virtual network resembles a traditional network that you'd operate in your own data center, with the benefits of using the scalable infrastructure of AWS. This pattern uses the [VPC Flow Logs](#) feature to capture information about the IP traffic going to and from network interfaces in your VPC.

## Best practices

Using infrastructure as code (IaC) can greatly simplify the VPC Flow Logs deployment process. Abstracting your VPC deployment definitions to include a flow log resource construct will deploy your VPCs with flow logs automatically. This is demonstrated in the next section.

### Centralized flow logs

*Example syntax for adding centralized flow logs to a VPC module in HashiCorp Terraform*

This code creates a flow log that sends logs from a VPC to a centralized S3 bucket. Note that this pattern doesn't cover creation of the S3 bucket.

For recommended bucket policy statements, see the [Additional information](#) section.

```
variable "vpc_id" {
  type          = string
  description = "ID of the VPC for which you want to create a Flow Log"
}

locals {
  # For more details: https://docs.aws.amazon.com/vpc/latest/userguide/flow-logs.html#flow-logs-custom
  custom_log_format_v5 = "${version} ${account-id} ${interface-id} ${srcaddr} ${dstaddr} ${srcport} ${dstport} ${protocol} ${packets} ${bytes} ${start} ${end} ${action} ${log-status} ${vpc-id} ${subnet-id} ${instance-id} ${tcp-flags} ${type} ${pkt-srcaddr} ${pkt-dstaddr} ${region} ${az-id} ${sublocation-type} ${sublocation-id} ${pkt-src-aws-service} ${pkt-dst-aws-service} ${flow-direction} ${traffic-path}"
}

resource "aws_flow_log" "centralized" {
  log_destination          = "arn:aws:s3::centralized-vpc-flow-logs-
<log_archive_account_id>" # Optionally, a prefix can be added after the ARN.
  log_destination_type    = "s3"
  traffic_type            = "ALL"
```

```
vpc_id          = var.vpc_id
log_format      = local.custom_log_format_v5 # If you want fields from VPC Flow
Logs v3+, you will need to create a custom log format.
tags           = {
  Name = "centralized_flow_log"
}
}
```

## Local flow logs

*Example syntax for adding local flow logs to a VPC module in Terraform with required permissions*

This code creates a flow log that sends logs from a VPC to a local CloudWatch Logs group.

```
data "aws_region" "current" {}

variable "vpc_id" {
  type        = string
  description = "ID of the VPC for which you want to create a Flow Log"
}

resource "aws_iam_role" "local_flow_log_role" {
  name = "flow-logs-policy-${var.vpc_id}"

  assume_role_policy = <<EOF
{
  "Version": "2012-10-17",
  "Statement": [
    {
      "Sid": "",
      "Effect": "Allow",
      "Principal": {
        "Service": "vpc-flow-logs.amazonaws.com"
      },
      "Action": "sts:AssumeRole"
    }
  ]
}
EOF
}

resource "aws_iam_role_policy" "logs_permissions" {
  name = "flow-logs-policy-${var.vpc_id}"
}
```

```
role = aws_iam_role.local_flow_log_role.id

policy = <<EOF
{
  "Version": "2012-10-17",
  "Statement": [
    {
      "Action": [
        "logs:CreateLogGroup",
        "logs:CreateLogStream",
        "logs:PutLogEvents",
        "logs:DescribeLogGroups",
        "logs:DescribeLogStreams",
        "logs:CreateLogDelivery",
        "logs>DeleteLogDelivery"
      ],
      "Effect": "Allow",
      "Resource": "arn:aws:logs:${data.aws_region.current.name}:*:log-group:vpc-flow-logs*"
    }
  ]
}
EOF
}

resource "aws_cloudwatch_log_group" "local_flow_logs" {
  # checkov:skip=CKV_AWS_338:local retention is set to 30, centralized S3 bucket can
  # retain for long-term
  name           = "vpc-flow-logs/${var.vpc_id}"
  retention_in_days = 30
}

resource "aws_flow_log" "local" {
  iam_role_arn      = aws_iam_role.local_flow_log_role.arn
  log_destination   = aws_cloudwatch_log_group.local_flow_logs.arn
  traffic_type      = "ALL"
  vpc_id            = var.vpc_id
  tags              = {
    Name = "local_flow_log"
  }
}
}
```

## Epics

### Deploy VPC Flow Logs infrastructure

Task	Description	Skills required
Determine the encryption strategy and create the policy for the central S3 bucket.	The central bucket does not support the aws/s3 AWS KMS key, so you must use either SSE-S3 or an AWS KMS customer managed key. If you use an AWS KMS key, the key policy must allow member accounts to use the key.	Compliance
Create the central flow log bucket.	<p>Create the central bucket to which flow logs will be sent, and apply the encryption strategy that you chose in the previous step. This should be in a Log Archive or similarly purposed account.</p> <p>Obtain the bucket policy from the <a href="#">Additional information</a> section, and apply it to your central bucket after updating placeholders with your environment specific values.</p>	General AWS
Configure VPC Flow Logs to send logs to the central flow log bucket.	Add flow logs to each VPC that you want to gather data from. The most scalable way to do this is to use IaC tools such as AFT or AWS Cloud Development Kit (AWS CDK). For example, you can create	Network administrator

Task	Description	Skills required
	a Terraform module that deploys a VPC alongside a flow log. If necessary, you add the flow logs manually.	
Configure VPC Flow Logs to send to local CloudWatch Logs.	(Optional) If you want flow logs to be visible in the accounts where the logs are being generated, create another flow log to send data to CloudWatch Logs in the local account. Alternatively, you can send the data to an account-specific S3 bucket in the local account.	General AWS

## Related resources

- [How to Facilitate Data Analysis and Fulfill Security Requirements by Using Centralized Flow Log Data](#) (blog post)
- [How to enable VPC Flow Logs automatically using AWS Config rules](#) (blog post)

## Additional information

### Bucket policy

This example of a bucket policy can be applied to your central S3 bucket for flow logs, after you add values for placeholder names.

```
{
  "Version": "2012-10-17",
  "Statement": [
    {
      "Sid": "AWSLogDeliveryWrite",
      "Effect": "Allow",
      "Principal": {
```

```

        "Service": "delivery.logs.amazonaws.com"
    },
    "Action": "s3:PutObject",
    "Resource": "arn:aws:s3:::<BUCKET_NAME>/**",
    "Condition": {
        "StringEquals": {
            "s3:x-amz-acl": "bucket-owner-full-control",
            "aws:SourceOrgID": "<ORG_ID>"
        }
    }
},
{
    "Sid": "AWSLogDeliveryCheck",
    "Effect": "Allow",
    "Principal": {
        "Service": "delivery.logs.amazonaws.com"
    },
    "Action": "s3:GetBucketAcl",
    "Resource": "arn:aws:s3:::<BUCKET_NAME>",
    "Condition": {
        "StringEquals": {
            "aws:SourceOrgID": "<ORG_ID>"
        }
    }
},
{
    "Sid": "DenyUnencryptedTraffic",
    "Effect": "Deny",
    "Principal": {
        "AWS": "*"
    },
    "Action": "s3:*",
    "Resource": [
        "arn:aws:s3:::<BUCKET_NAME>/**",
        "arn:aws:s3:::<BUCKET_NAME>"
    ],
    "Condition": {
        "Bool": {
            "aws:SecureTransport": "false"
        }
    }
}
]

```

}



# Configure logging for .NET applications in Amazon CloudWatch Logs by using NLog

Created by Bibhuti Sahu (AWS) and Rob Hill (AWS) (AWS)

**Environment:** Production

**Technologies:** Management & governance; DevOps; Web & mobile apps

**Workload:** Microsoft

**AWS services:** Amazon CloudWatch Logs

## Summary

This pattern describes how to use the NLog open-source logging framework to log .NET application usage and events in [Amazon CloudWatch Logs](#). In the CloudWatch console, you can view the application's log messages in near real time. You can also set up [metrics](#) and configure [alarms](#) to notify you if a metric threshold is exceeded. Using CloudWatch Application Insights, you can view automated or custom dashboards that show potential problems for the monitored applications. CloudWatch Application Insights is designed to help you quickly isolate ongoing issues with your applications and infrastructure.

To write log messages to CloudWatch Logs, you add the AWS.Logger.NLog NuGet package to the .NET project. Then, you update the NLog.config file to use CloudWatch Logs as a target.

## Prerequisites and limitations

### Prerequisites

- An active AWS account.
- A .NET web or console application that:
  - Uses supported .NET Framework or .NET Core versions. For more information, see *Product versions*.
  - Uses NLog to send log data to Application Insights.
- Permissions to create an IAM role for an AWS service. For more information, see [Service role permissions](#).

- Permissions to pass a role to an AWS service. For more information, see [Granting a user permissions to pass a role to an AWS service](#).

## Product versions

- .NET Framework version 3.5 or later
- .NET Core versions 1.0.1, 2.0.0, or later

## Architecture

### Target technology stack

- NLog
- Amazon CloudWatch Logs

### Target architecture

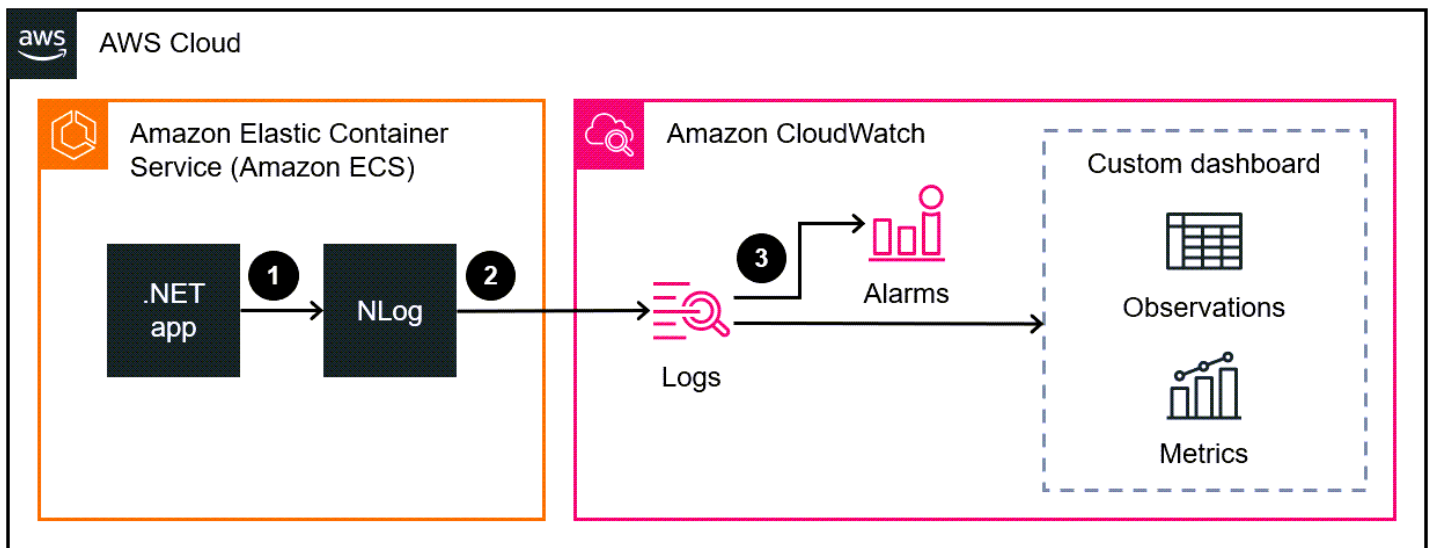

1. The .NET application writes log data to the NLog logging framework.
2. NLog writes the log data to CloudWatch Logs.
3. You use CloudWatch alarms and custom dashboards to monitor the .NET application.

# Tools

## AWS services

- [Amazon CloudWatch Application Insights](#) helps you observe the health of your applications and underlying AWS resources.
- [Amazon CloudWatch Logs](#) helps you centralize the logs from all your systems, applications, and AWS services so you can monitor them and archive them securely.
- [AWS Identity and Access Management \(IAM\)](#) helps you securely manage access to your AWS resources by controlling who is authenticated and authorized to use them.
- [AWS Tools for PowerShell](#) are a set of PowerShell modules that help you script operations on your AWS resources from the PowerShell command line.

## Other tools

- [Logger.NLog](#) is an NLog target that records log data to CloudWatch Logs.
- [NLog](#) is an open-source logging framework for .NET platforms that helps you write log data to targets, such as databases, log files, or consoles.
- [PowerShell](#) is a Microsoft automation and configuration management program that runs on Windows, Linux, and macOS.
- [Visual Studio](#) is an integrated development environment (IDE) that includes compilers, code completion tools, graphical designers, and other features that support software development.

## Best practices

- Set a [retention policy](#) for the target log group. This must be done outside of the NLog configuration. By default, log data is stored in CloudWatch Logs indefinitely.
- Adhere to the [Best practices for managing AWS access keys](#).

# Epics

## Set up access and tools

Task	Description	Skills required
Create an IAM policy.	<p>Follow the instructions in <a href="#">Creating policies using the JSON editor</a> in the IAM documentation. Enter the following JSON policy, which has the least-privilege permissions necessary to allow CloudWatch Logs to read and write logs.</p> <pre data-bbox="594 886 1029 1858">{   "Version":   "2012-10-17",   "Statement": [     {       "Effect":       "Allow",       "Action": [          "logs:CreateLogGroup",         "logs:CreateLogStream",         "logs:GetLogEvents",         "logs:PutLogEvents",         "logs:DescribeLogGroups",         "logs:DescribeLogStreams",</pre>	AWS administrator, AWS DevOps

Task	Description	Skills required
	<pre> "logs:PutRetention Policy"     ],     "Resource":     [         "*"     ] } ] } </pre>	
Create an IAM role.	<p>Follow the instructions in <a href="#">Creating a role to delegate permissions to an AWS service</a> in the IAM documentation. Select the policy that you created previously. This is the role CloudWatch Logs assumes to perform logging actions.</p>	AWS administrator, AWS DevOps
Set up AWS Tools for PowerShell.	<ol style="list-style-type: none"> <li>1. Follow the instructions for your operating system in <a href="#">Installing the AWS Tools for PowerShell</a>.</li> <li>2. Use the AWS Tools for PowerShell cmdlets to store your access key and secret key in a profile. For instructions, see <a href="#">Managing Profiles</a> in the AWS Tools for PowerShell documentation.</li> </ol>	General AWS

## Configure NLog

Task	Description	Skills required
Install the NuGet package.	<ol style="list-style-type: none"><li>1. In Visual Studio, choose <b>File</b>, and then choose <b>Open a project or solution</b>.</li><li>2. Choose the project where you want to install NLog.</li><li>3. In Visual Studio, choose <b>Tools, NuGet Package Manager, Package Manager Console</b>.</li><li>4. Install the <code>AWS.Logger.NLog</code> NuGet package by entering the following command.<div data-bbox="630 1052 1029 1213" style="border: 1px solid #ccc; border-radius: 10px; padding: 10px; margin: 10px 0;"><pre>Install-Package   AWS.Logger.NLog -   Version 3.1.0</pre></div></li></ol>	App developer
Configure the logging target.	<ol style="list-style-type: none"><li>1. Open the <code>NLog.config</code> file.</li><li>2. For the target type, enter <code>AWSTarget</code>.</li><li>3. For the target <code>logGroup</code>, enter the name of the <a href="#">log group</a> that you want to use. If the log group doesn't already exist, a new log group with the provided name is automatically created.</li></ol>	App developer

Task	Description	Skills required
	<p>4. For the target region, enter the AWS Region where CloudWatch Logs is configured.</p> <p>5. For the target profile, enter the name of the profile that you created previously to store the access key and secret key.</p> <p>6. Save and close the NLog.config file.</p> <p>For a sample configuration file, see the <a href="#">Additional information</a> section of this pattern. When you run your application, NLog will write the log messages and send them to CloudWatch Logs.</p>	

## Validate and monitor logs

Task	Description	Skills required
Validate logging.	<p>Follow the instructions in <a href="#">View log data sent to CloudWatch Logs</a> in the CloudWatch Logs documentation. Validate that log events are being recorded for the .NET application. If log events are not being</p>	General AWS

Task	Description	Skills required
	recorded, see the <a href="#">Troubleshooting</a> section in this pattern.	
Monitor the .NET application stack.	Configure monitoring in CloudWatch as needed for your use case. You can use <a href="#">CloudWatch Logs Insights</a> , <a href="#">CloudWatch Metrics Insights</a> , and <a href="#">CloudWatch Application Insights</a> to monitor your .NET workload. You can also configure <a href="#">alarms</a> so that you can receive alerts, and you can create a custom <a href="#">dashboard</a> for monitoring the workload from a single view.	General AWS

## Troubleshooting

Issue	Solution
Log data doesn't appear in CloudWatch Logs.	Make sure that the IAM policy is attached to the IAM role that CloudWatch Logs assumes. For instructions, see the <i>Set up access and tools</i> section in the <a href="#">Epics</a> section.

## Related resources

- [Working with log groups and log streams](#) (CloudWatch Logs documentation)
- [Amazon CloudWatch Logs and .NET Logging Frameworks](#) (AWS blog post)



## Additional information

The following is a sample NLog.config file.

```
<?xml version="1.0" encoding="utf-8" ?>
<configuration>
  <configSections>
    <section name="nlog" type="NLog.Config.ConfigSectionHandler, NLog" />
  </configSections>
  <startup>
    <supportedRuntime version="v4.0" sku=".NETFramework,Version=v4.7.2" />
  </startup>
  <nlog>
    <extensions>
      <add assembly="NLog.AWS.Logger" />
    </extensions>
    <targets>
      <target name="aws" type="AWSTarget" logGroup="NLog.TestGroup" region="us-east-1"
profile="demo"/>
    </targets>
    <rules>
      <logger name="*" minlevel="Info" writeTo="aws" />
    </rules>
  </nlog>
</configuration>
```

# Copy AWS Service Catalog products across different AWS accounts and AWS Regions

Created by Sachin Vighe (AWS) and Santosh Kale (AWS)

**Environment:** Production

**Technologies:** Management & governance; Serverless

**Workload:** All other workloads

**AWS services:** AWS Service Catalog; AWS Lambda

## Summary

AWS Service Catalog is a Regional service and this means that AWS Service Catalog [portfolios and products](#) are only visible in the AWS Region where they are created. If you set up an [AWS Service Catalog hub](#) in a new Region, you must recreate your existing products and this can be a time-consuming process.

This pattern's approach helps simplify this process by describing how to copy products from an AWS Service Catalog hub in a source AWS account or Region to a new hub in a destination account or Region. For more information about the AWS Service Catalog hub and spoke model, see [AWS Service Catalog hub and spoke model: How to automate the deployment and management of AWS Service Catalog to many accounts](#) on the AWS Management and Governance Blog.

The pattern also provides the separate code packages required to copy AWS Service Catalog products across accounts or to other Regions. By using this pattern, your organization can save time, make existing and previous product versions available in a new AWS Service Catalog hub, minimize the risk of manual errors, and scale the approach across multiple accounts or Regions.

**Note:** This pattern's *Epics* section provides two options for copying products. You can use Option 1 to copy products across accounts or choose Option 2 to copy products across Regions.

## Prerequisites and limitations

### Prerequisites

- An active AWS account.

- Existing AWS Service Catalog products in a source account or Region.
- An existing AWS Service Catalog hub in a destination account or Region.
- If you want to copy products across accounts, you must share and then import the AWS Service Catalog portfolio containing the products into your destination account. For more information about this, see [Sharing and importing portfolios](#) in the AWS Service Catalog documentation.

## Limitations

- AWS Service Catalog products that you want to copy across Regions or accounts cannot belong to more than one portfolio.

## Architecture

The following diagram shows the copying of AWS Service Catalog products from a source account to a destination account.

The following diagram shows the copying of AWS Service Catalog products from a source Region to a destination Region.

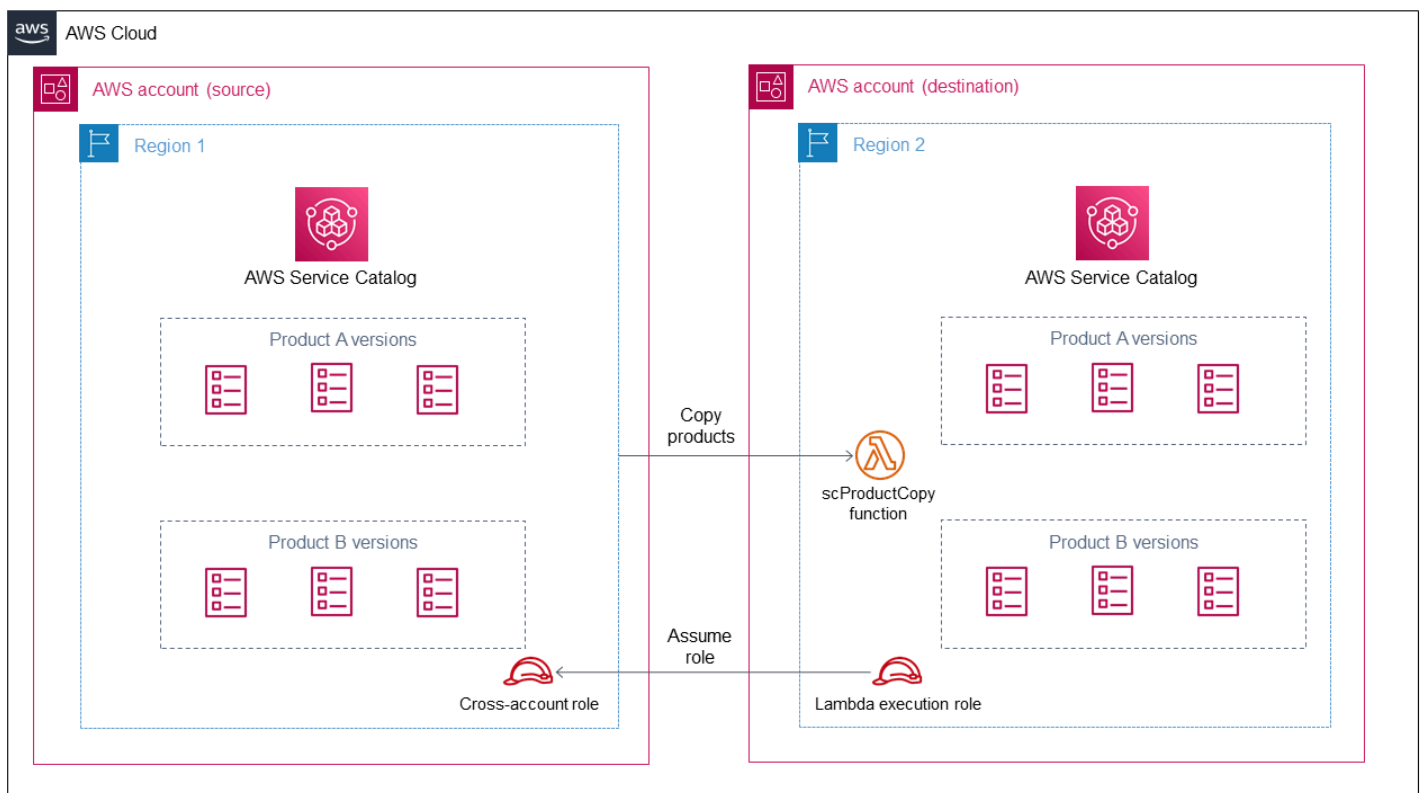

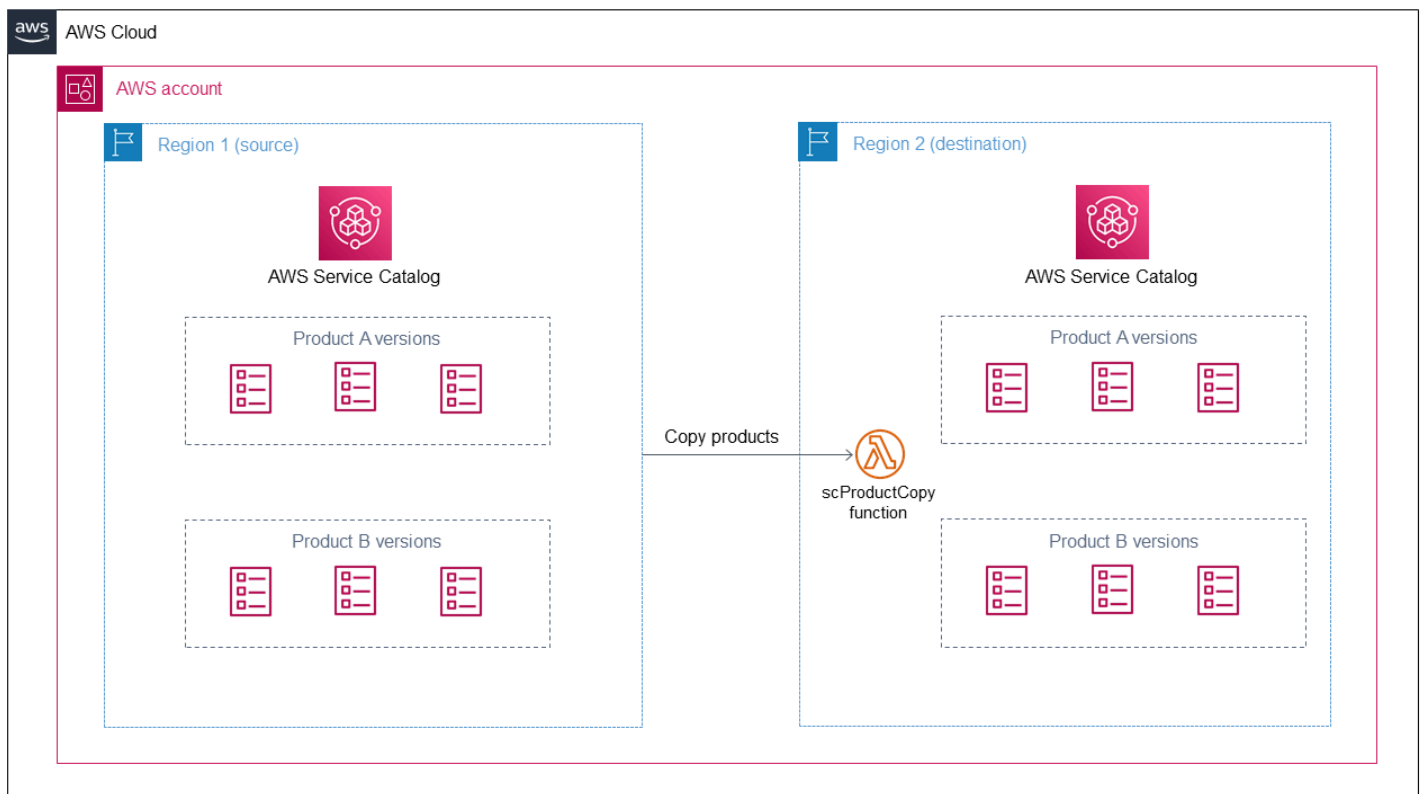

## Technology stack

- Amazon CloudWatch
- AWS Identity and Access Management (IAM)
- AWS Lambda
- AWS Service Catalog

## Automation and scale

You can scale this pattern's approach by using a Lambda function that can be scaled depending on the number of requests received or how many AWS Service Catalog products you need to copy. For more information about this, see [Lambda function scaling](#) in the AWS Lambda documentation.

## Tools

- [AWS Command Line Interface \(AWS CLI\)](#) is an open-source tool that helps you interact with AWS services through commands in your command-line shell.
- [AWS Identity and Access Management \(IAM\)](#) helps you securely manage access to your AWS resources by controlling who is authenticated and authorized to use them.

- [AWS Lambda](#) is a compute service that helps you run code without needing to provision or manage servers. It runs your code only when needed and scales automatically, so you pay only for the compute time that you use.
- [AWS Service Catalog](#) helps you centrally manage catalogs of IT services that are approved for AWS. End users can quickly deploy only the approved IT services they need, following the constraints set by your organization.

## Code

You can use the `cross-account-copy` package (attached) to copy AWS Service Catalog products across accounts or the `cross-region-copy` package (attached) to copy products across Regions.

The `cross-account-copy` package contains the following files:

- `copyconf.properties` – The configuration file that contains the Region and AWS account ID parameters for copying products across accounts.
- `scProductCopyLambda.py` – The Python function for copying products across accounts.
- `createDestAccountRole.sh` – The script to create an IAM role in the destination account.
- `createSrcAccountRole.sh` – The script to create an IAM role in the source account.
- `copyProduct.sh` – The script to create and invoke the Lambda function for copying products across accounts.

The `cross-region-copy` package contains the following files:

- `copyconf.properties` – The configuration file that contains the Region and AWS account ID parameters for copying products across Regions.
- `scProductCopyLambda.py` – The Python function for copying products across Regions.
- `copyProduct.sh` – The script to create an IAM role and create and invoke the Lambda function for copying products across Regions.

## Epics

### Option 1 – Copy AWS Service Catalog products across accounts

Task	Description	Skills required
Update the configuration file.	<ol style="list-style-type: none"> <li>1. Download the <code>cross-account-copy</code> package (attached) to your local machine.</li> <li>2. Update the <code>copyconf.properties</code> configuration file with the following values: <ul style="list-style-type: none"> <li>• <code>srcRegion</code> – Provide the source Region that contains the products.</li> <li>• <code>destRegion</code> – Provide the destination Region for the products.</li> <li>• <code>sourceAccountId</code> – Provide the AWS account ID for your source account.</li> <li>• <code>destAccountId</code> – Provide the AWS account ID for your destination account.</li> </ul> </li> </ol>	AWS administrator, AWS systems administrator, Cloud administrator
Configure your credentials for AWS CLI in the destination account.	Configure your credentials to access AWS CLI in your destination account by running the <code>aws configure</code> command and providing the following values :	AWS administrator, AWS systems administrator, Cloud administrator

Task	Description	Skills required
	<pre data-bbox="597 226 1026 684">\$aws configure AWS Access Key ID [None]: &lt;your_access_key_id&gt; AWS Secret Access Key [None]: &lt;your_secret_access_key&gt; Default region name [None]: Region Default output format [None]:</pre> <p data-bbox="597 726 1013 898">For more information about this, see <a href="#">Configuration basics</a> in the AWS Command Line Interface documentation.</p>	

Task	Description	Skills required
<p>Configure your credentials for AWS CLI in the source account.</p>	<p>Configure your credentials to access AWS CLI in your source account by running the <code>aws configure</code> command and providing the following values:</p> <pre data-bbox="594 537 1029 1016">\$aws configure AWS Access Key ID [None]: &lt;your_access_key_id&gt; AWS Secret Access Key [None]: &lt;your_secret_access_key&gt; Default region name [None]: Region Default output format [None]:</pre> <p>For more information about this, see <a href="#">Configuration basics</a> in the AWS Command Line Interface documentation.</p>	<p>AWS administrator, AWS systems administrator, Cloud administrator</p>
<p>Create a Lambda execution role in your destination account.</p>	<p>Run the <code>createDestinationAccountRole.sh</code> script in your destination account. The script implements the following actions:</p> <ul style="list-style-type: none"><li>• Creates a Lambda execution role in your destination account</li><li>• Creates and attaches the IAM policy for the Lambda execution role</li></ul>	<p>AWS administrator, AWS systems administrator, Cloud administrator</p>



Task	Description	Skills required
Create the cross-account IAM role in your source account.	<p>Run the <code>createSrcAccountRole.sh</code> script in your source account. The script implements the following actions:</p> <ul style="list-style-type: none"><li>• Creates a cross-account IAM role in your source account that is assumed by the Lambda execution role in the destination account to copy products</li><li>• Creates and attaches an IAM policy for the cross-account role in your source account</li></ul>	AWS administrator, AWS systems administrator, Cloud administrator
Run the <code>copyProduct</code> script in the destination account.	<p>Run the <code>copyProduct.sh</code> script in your destination account. The script implements the following actions:</p> <ul style="list-style-type: none"><li>• Creates and invokes the Lambda function to copy products from the source account to the destination account</li></ul>	AWS administrator, AWS systems administrator, Cloud administrator

## Option 2 – Copy AWS Service Catalog products from a source Region to a destination Region

Task	Description	Skills required
Update the configuration file.	<ol style="list-style-type: none"> <li>Download the cross-region-copy package (attached) to your local machine.</li> <li>Update the copyconf.properties configuration file with the following values: <ul style="list-style-type: none"> <li>srcRegion – Provide the source Region that contains the products.</li> <li>destRegion – Provide the destination Region for the products.</li> <li>accountId – Provide your AWS account ID.</li> </ul> </li> </ol>	AWS systems administrator, Cloud administrator, AWS administrator
Configure your credentials for AWS CLI.	<p>Configure your credentials to access AWS CLI in your environment by running the <code>aws configure</code> command and providing the following values:</p> <pre> \$aws configure AWS Access Key ID [None]: &lt;your_access_key_id&gt; AWS Secret Access Key [None]: &lt;your_secret_access_key&gt; Default region name [None]: Region </pre>	AWS administrator, AWS systems administrator, Cloud administrator

Task	Description	Skills required
	<p>Default output format [None]:</p> <p>For more information about this, see <a href="#">Configuration basics</a> in the AWS Command Line Interface documentation.</p>	
Run the copyProduct script.	<p>Run the copyProduct .sh script in your destination Region. The script implements the following actions:</p> <ul style="list-style-type: none"> <li>• Creates a Lambda execution role</li> <li>• Creates and attaches the IAM policy for the Lambda execution role</li> <li>• Creates and invokes the Lambda function to copy products from the source Region to the destination Region</li> </ul>	AWS administrator, AWS systems administrator, Cloud administrator

## Related resources

- [Create a Lambda execution role](#) (AWS Lambda documentation)
- [Create a Lambda function](#) (AWS Lambda documentation)
- [AWS Service Catalog API reference](#)
- [AWS Service Catalog documentation](#)

## Attachments

To access additional content that is associated with this document, unzip the following file:

[attachment.zip](#)

# Create alarms for custom metrics using Amazon CloudWatch anomaly detection

Created by Ram Kandaswamy (AWS) and Raheem Jiwani (AWS)

**Environment:** Production

**Technologies:** Management & governance; DevOps; Operations; CloudNative

**AWS services:** Amazon CloudWatch

## Summary

On the Amazon Web Services (AWS) Cloud, you can use Amazon CloudWatch to create alarms that monitor metrics and send notifications or automatically make changes if a threshold is breached.

To avoid being limited by [static thresholds](#), you can create alarms based on past patterns and that notify you if specific metrics are outside the normal operating window. For example, you could monitor your API's response times from Amazon API Gateway and receive notifications about anomalies that prevent you from meeting a service-level agreement (SLA).

This pattern describes how to use CloudWatch anomaly detection for custom metrics. The pattern shows you how to create a custom metric in Amazon CloudWatch Logs Insights or publish a custom metric with an AWS Lambda function, and then set up anomaly detection and create notifications using Amazon Simple Notification Service (Amazon SNS).

## Prerequisites and limitations

### Prerequisites

- An active AWS account.
- An existing SNS topic, configured to send email notifications. For more information about this, see [Getting started with Amazon SNS](#) in the Amazon SNS documentation.
- An existing application, configured with [CloudWatch Logs](#).

### Limitations

- CloudWatch metrics don't support millisecond time intervals. For more information about the granularity of regular and custom metrics, see the [Amazon CloudWatch FAQs](#).

## Architecture

The diagram shows the following workflow:

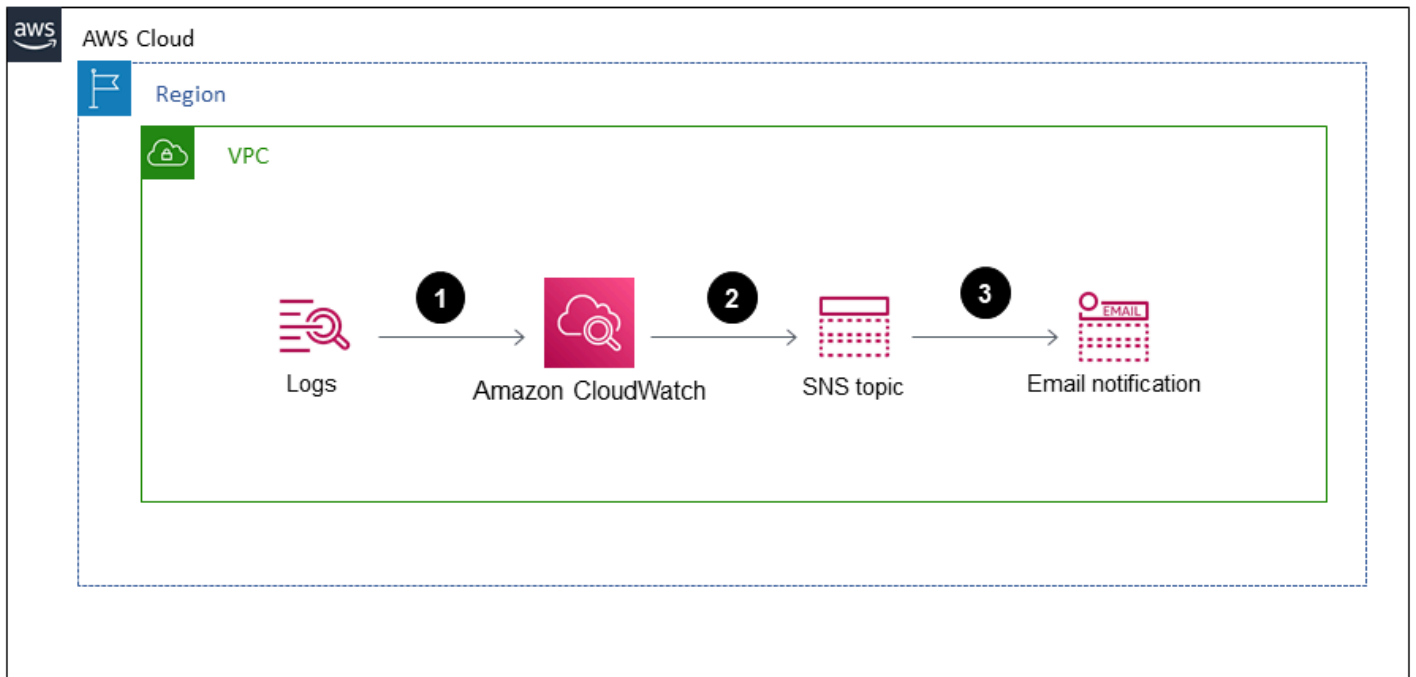

1. Logs that use metrics created and updated by CloudWatch Logs are streamed to CloudWatch.
2. An alarm initiates based on thresholds and sends an alert to an SNS topic.
3. Amazon SNS sends you an email notification.

### Technology stack

- CloudWatch
- AWS Lambda
- Amazon SNS

## Tools

- [Amazon CloudWatch](#) provides a reliable, scalable, and flexible monitoring solution.

- [AWS Lambda](#) is a compute service that helps you run code without provisioning or managing servers.
- [Amazon Simple Notification Service \(Amazon SNS\)](#) is a managed service that provides message delivery from publishers to subscribers.

## Epics

### Set up anomaly detection for a custom metric

Task	Description	Skills required
Option 1 - Create a custom metric with a Lambda function.	<p>Download the <code>lambda_function.py</code> file (attached ) and then replace the sample <code>lambda_function.py</code> file in the <a href="#">aws-lambda-developer-guide</a> repository on the AWS Documentation GitHub. This provides you with a sample Lambda function that sends custom metrics to CloudWatch Logs. The Lambda function uses the Boto3 API to integrate with CloudWatch.</p> <p>After you run the Lambda function, you can sign in to the AWS Management Console, open the CloudWatch console, and the published metric is available under your published namespace.</p>	DevOps engineer, AWS DevOps
Option 2 – Create custom metrics from CloudWatch log groups.	Sign in to the AWS Management Console, open the CloudWatch console, and	DevOps engineer, AWS DevOps

Task	Description	Skills required
	<p>then choose <b>Log groups</b>. Choose the log group that you want to create a metric for.</p> <p>Choose <b>Actions</b> and then choose <b>Create metric filter</b>. For <b>Filter pattern</b>, enter the filter pattern that you want to use. For more information, see <a href="#">Filter and pattern syntax</a> in the CloudWatch documentation.</p> <p>To test your filter pattern, enter one or more log events under <b>Test Pattern</b>. Each log event must be within one line, because line breaks are used to separate log events in the <b>Log event</b> messages box. After you test the pattern, you can enter a name and value for your metric under <b>Metric details</b>.</p> <p>For more information and steps to create a custom metric, see <a href="#">Create a metric filter for a log group</a> in the CloudWatch documentation.</p>	



Task	Description	Skills required
Create an alarm for your custom metric.	<p>On the CloudWatch console, choose <b>Alarms</b> and then choose <b>Create Alarm</b>. Choose <b>Select metric</b> and enter the name of the metric that you created earlier into the search box. Choose the <b>Graphed metrics</b> tab and configure the options according to your requirements.</p> <p>Under <b>Conditions</b>, choose <b>Anomaly detection</b> instead of <b>Static thresholds</b>. This shows you a band based on two standard default deviations. You can set up thresholds and adjust them according to your requirements.</p> <p>Choose <b>Next</b>.</p> <p><b>Note:</b> The band is dynamic and depends on the quality of the datapoints. When you begin aggregating more data, the band and thresholds are automatically updated.</p>	DevOps engineer, AWS DevOps

Task	Description	Skills required
Set up SNS notifications.	<p>Under <b>Notification</b>, choose the SNS topic to notify when the alarm is in ALARM state, OK state, or INSUFFICIENT_DATA state.</p> <p>To have the alarm send multiple notifications for the same alarm state or for different alarm states, choose <b>Add notification</b>. Choose <b>Next</b>. Enter a name and description for the alarm. The name must only contain ASCII characters. Then choose <b>Next</b>.</p> <p>Under <b>Preview and create</b>, confirm that the information and conditions are correct, and then choose <b>Create alarm</b>.</p>	DevOps engineer, AWS DevOps

## Related resources

- [Publishing custom metrics to CloudWatch](#)
- [Using CloudWatch anomaly detection](#)
- [Alarm events and Amazon EventBridge](#)
- [What are the best practices to follow while pushing custom metrics to Cloud Watch? \(video\)](#)
- [Introduction to CloudWatch Application Insights \(video\)](#)
- [Detect anomalies with CloudWatch \(video\)](#)

## Attachments

To access additional content that is associated with this document, unzip the following file:

[attachment.zip](#)

# Create an AWS Cloud9 IDE that uses Amazon EBS volumes with default encryption

Created by Janardhan Malyala (AWS) and Dhruvajyoti Mukherjee (AWS)

**Environment:** Production

**Technologies:** Management & governance

**Workload:** All other workloads

**AWS services:** AWS Cloud9; AWS KMS

## Summary

You can use [encryption by default](#) to enforce the encryption of your Amazon Elastic Block Store (Amazon EBS) volumes and snapshot copies on the Amazon Web Services (AWS) Cloud.

You can create an AWS Cloud9 integrated development environment (IDE) that uses EBS volumes encrypted by default. However, the AWS Identity and Access Management (IAM) [service-linked role](#) for AWS Cloud9 requires access to the AWS Key Management Service (AWS KMS) key for these EBS volumes. If access is not provided, the AWS Cloud9 IDE might fail to launch and debugging might be difficult.

This pattern provides the steps to add the service-linked role for AWS Cloud9 to the AWS KMS key that is used by your EBS volumes. The setup described by this pattern helps you successfully create and launch an IDE that uses EBS volumes with encryption by default.

## Prerequisites and limitations

### Prerequisites

- An active AWS account.
- Default encryption turned on for EBS volumes. For more information about encryption by default, see [Amazon EBS encryption](#) in the Amazon Elastic Compute Cloud (Amazon EC2) documentation.
- An existing [customer managed KMS key](#) for encrypting your EBS volumes.

**Note:** You don't need to create the service-linked role for AWS Cloud9. When you create an AWS Cloud9 development environment, AWS Cloud9 creates the service-linked role for you.

## Architecture

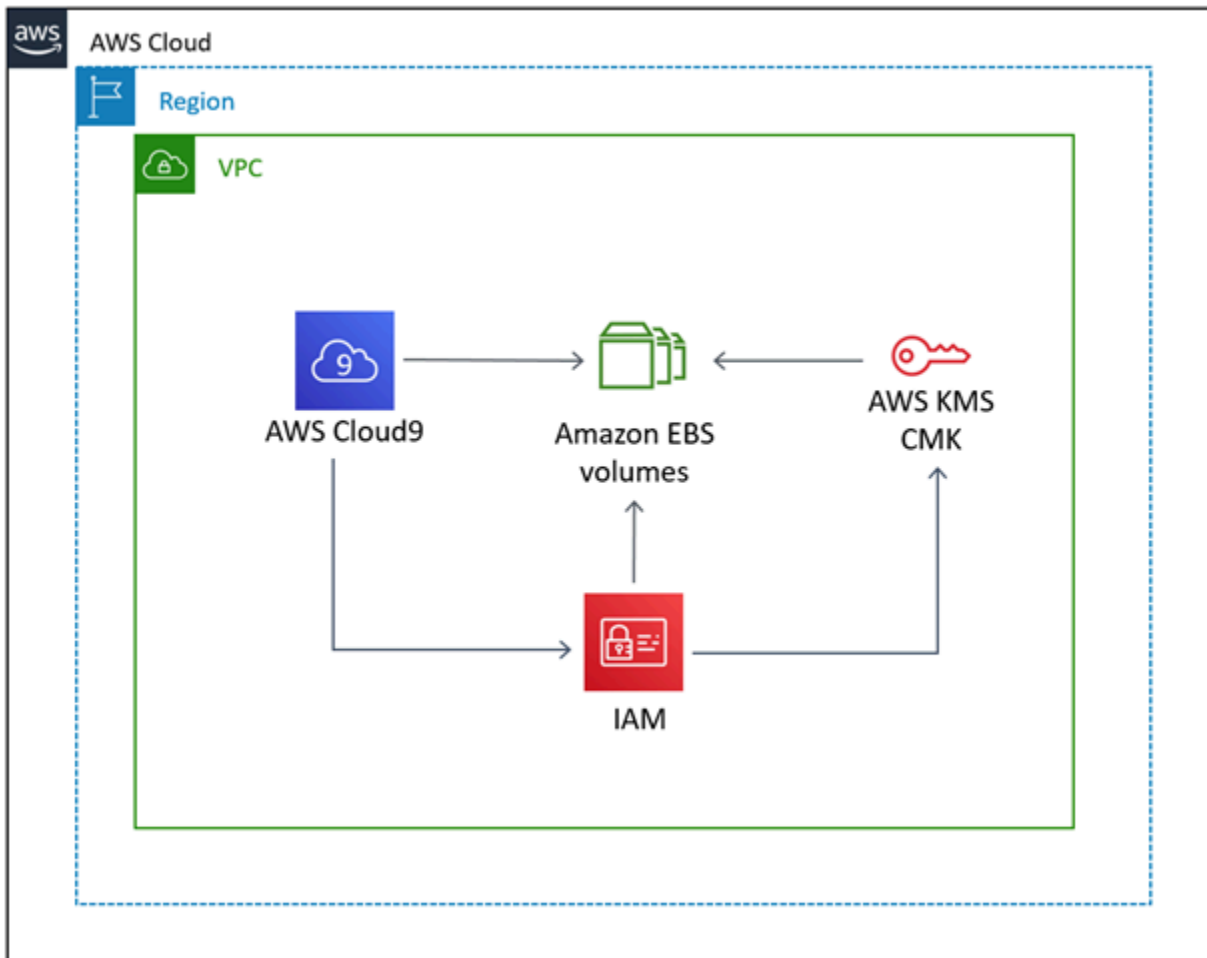

### Technology stack

- AWS Cloud9
- IAM
- AWS KMS

## Tools

- [AWS Cloud9](#) is an integrated development environment (IDE) that helps you code, build, run, test, and debug software. It also helps you release software to the AWS Cloud.
- [Amazon Elastic Block Store \(Amazon EBS\)](#) provides block-level storage volumes for use with Amazon Elastic Compute Cloud (Amazon EC2) instances.
- [AWS Identity and Access Management \(IAM\)](#) helps you securely manage access to your AWS resources by controlling who is authenticated and authorized to use them.
- [AWS Key Management Service \(AWS KMS\)](#) helps you create and control cryptographic keys to help protect your data.

## Epics

### Find the default encryption key value

Task	Description	Skills required
Record the default encryption key value for the EBS volumes.	Sign in to the AWS Management Console and open the Amazon EC2 console. Choose <b>EC2 dashboard</b> , and then choose <b>Data protection and security</b> in <b>Account attributes</b> . In <b>EBS encryption</b> section, copy and record the value in <b>Default encryption key</b> .	Cloud architect, DevOps engineer

### Provide access to the AWS KMS key

Task	Description	Skills required
Provide AWS Cloud9 with access to the KMS key for EBS volumes.	1. Open the AWS KMS console, and then choose <b>Customer managed</b>	Cloud architect, DevOps engineer

Task	Description	Skills required
	<p><b>keys</b>. Select the AWS KMS key used for Amazon EBS encryption, and then choose <b>View key</b>.</p> <ol style="list-style-type: none"><li>2. On the <b>Key policy</b> tab, confirm that you can see the text form of the key policy. If you cannot see the text form, choose <b>Switch to policy view</b>.</li><li>3. Choose <b>Edit</b>. Add the code in the <a href="#">Additional information</a> section to the policy, and then choose <b>Save changes</b>. The policy changes permit the service-linked role for AWS Cloud9, <code>AWSServiceRoleForAWSCloud9</code>, to access the key.</li></ol> <p>For more information about updating a key policy, see <a href="#">How to change a key policy</a> (AWS KMS documentation).</p> <p><b>Important:</b> The service-linked role for AWS Cloud9 is automatically created when you launch your first IDE. For more information, see <a href="#">Creating a service-linked role</a> in the AWS Cloud9 documentation.</p>	

## Create and launch the IDE

Task	Description	Skills required
Create and launch the AWS Cloud9 IDE.	Open the AWS Cloud9 console and choose <b>Create environment</b> . Configure IDE according to your requirements by following the steps from <a href="#">Creating an EC2 environment</a> in the AWS Cloud9 documentation.	Cloud architect, DevOps engineer

## Related resources

- [Encrypt EBS volumes used by AWS Cloud9](#)
- [Create a service-linked role for AWS Cloud9](#)
- [Create an EC2 environment in AWS Cloud9](#)

## Additional information

### AWS KMS key policy updates

Replace <aws\_accountid> with your AWS account ID.

```
{
  "Sid": "Allow use of the key",
  "Effect": "Allow",
  "Principal": {
    "AWS": "arn:aws:iam::<aws_accountid>:role/aws-service-role/cloud9.amazonaws.com/AWSServiceRoleForAWSCloud9"
  },
  "Action": [
    "kms:Encrypt",
    "kms:Decrypt",
    "kms:ReEncrypt*",
    "kms:GenerateDataKey*",
    "kms:DescribeKey"
  ]
}
```



```

    ],
    "Resource": "*"
  },
  {
    "Sid": "Allow attachment of persistent resources",
    "Effect": "Allow",
    "Principal": {
      "AWS": "arn:aws:iam::<aws_accountid>:role/aws-service-role/
cloud9.amazonaws.com/AWSServiceRoleForAWSCloud9"
    },
    "Action": [
      "kms:CreateGrant",
      "kms:ListGrants",
      "kms:RevokeGrant"
    ],
    "Resource": "*",
    "Condition": {
      "Bool": {
        "kms:GrantIsForAWSResource": "true"
      }
    }
  }
}

```

## Using a cross-account key

If you want to use a cross-account KMS key, you must use a grant in combination with the KMS key policy. This enables cross-account access to the key. In the same account that you used to create the Cloud9 environment, run the following command in the terminal.

```

aws kms create-grant \
  --region <Region where Cloud9 environment is created> \
  --key-id <The cross-account KMS key ARN> \
  --grantee-principal arn:aws:iam::<The account where Cloud9 environment is
created>:role/aws-service-role/cloud9.amazonaws.com/AWSServiceRoleForAWSCloud9 \
  --operations "Encrypt" "Decrypt" "ReEncryptFrom" "ReEncryptTo" "GenerateDataKey"
"GenerateDataKeyWithoutPlaintext" "DescribeKey" "CreateGrant"

```

After you run this command, you can create Cloud9 environments by using EBS encryption with a key in a different account.

# Document your AWS landing zone design

Created by Michael Daehnert (AWS), Florian Langer (AWS), and Michael Lodemann (AWS)

**Environment:** Production

**Technologies:** Management & governance; Infrastructure; Security, identity, compliance

**AWS services:** AWS Control Tower

## Summary

A *landing zone* is a well-architected, multi-account environment that's based on security and compliance best practices. It is the enterprise-wide container that holds all of your organizational units (OUs), AWS accounts, users, and other resources. A landing zone can scale to fit the needs of an enterprise of any size. AWS has two options for creating your landing zone: a service-based landing zone using [AWS Control Tower](#) or a customized landing zone that you build. Each option requires a different level of AWS knowledge.

AWS created AWS Control Tower to help you save time by automating the setup of a landing zone. AWS Control Tower is managed by AWS and uses best practices and guidelines to help you create your foundational environment. AWS Control Tower uses integrated services, such as [AWS Service Catalog](#) and [AWS Organizations](#), to provision accounts in your landing zone and manage access to those accounts.

AWS landing zone projects vary in requirements, implementation details, and operational action items. There are customization aspects that need to be handled with every landing zone implementation. This includes (but is not limited to) how access management is handled, which technology stack is used, and what the monitoring requirements are for operational excellence. This pattern provides a template that helps you document your landing zone project. By using the template, you can document your project more quickly and help your development and operations teams understand your landing zone.

## Prerequisites and limitations

### Limitations

This pattern does not describe what a landing zone is or how to implement one. For more information about these topics, see the [Related resources](#) section.

# Epics

## Create the design document

Task	Description	Skills required
Identify key stakeholders.	Identify key service and team managers that are linked to your landing zone.	Project manager
Customize the template.	<p>Download the template in the <a href="#">Attachments</a> section, and then update the template as follows:</p> <ol style="list-style-type: none"><li>1. Remove any sections that don't apply to your organization's landing zone or processes.</li><li>2. Add any sections that are unique to your organization.</li></ol>	Project manager
Complete the template.	<p>In meetings with the stakeholders or by using a write-and-review process, complete the template as follows:</p> <ol style="list-style-type: none"><li>1. Use the guidance and information in the blue boxes to complete each section.</li><li>2. Replace or remove any yellow fields with custom values for your organization.</li></ol>	Project manager

Task	Description	Skills required
	<ol style="list-style-type: none"><li>3. Replace or remove any image fields with your custom architecture or flow diagrams.</li><li>4. Complete the <i>Revision history</i> and <i>Contributors</i> section of the template.</li></ol>	
Share the design document.	When your landing zone design documentation is complete, save it in a shared repository or central location where all stakeholders can access it. We recommend that you use standard document control processes to record and approve revisions to the design document.	Project manager

## Related resources

- [AWS Control Tower documentation](#)
- [Plan your AWS Control Tower landing zone](#)
- [AWS multi-account strategy for your AWS Control Tower landing zone](#)
- [Administrative tips for landing zone setup](#)
- [Expectations for landing zone configuration](#)
- [Customizations for AWS Control Tower](#) (AWS Solutions Library)
- [Setting up a secure and scalable multi-account AWS environment](#) (AWS Prescriptive Guidance)

## Attachments

To access additional content that is associated with this document, unzip the following file:  
[attachment.zip](#)

# Improve operational performance by enabling Amazon DevOps Guru across multiple AWS Regions, accounts, and OUs with the AWS CDK

Created by Dr. Rahul Sharad Gaikwad (AWS)

**Code repository:** [Amazon DevOps Guru sample code](#)

**Environment:** PoC or pilot

**Technologies:** Management & governance; CloudNative; DevOps; Operations; Security, identity, compliance; Serverless

**AWS services:** Amazon API Gateway; AWS CDK; Amazon DevOps Guru; Amazon DynamoDB; AWS Organizations

## Summary

This pattern demonstrates the steps to enable the Amazon DevOps Guru service across multiple Amazon Web Services (AWS) Regions, accounts, and organizational units (OUs) by using the AWS Cloud Development Kit (AWS CDK) in TypeScript. You can use AWS CDK stacks to deploy AWS CloudFormation StackSets from the administrator (primary) AWS account to enable Amazon DevOps Guru across multiple accounts, instead of logging into each account and enabling DevOps Guru individually for each account.

Amazon DevOps Guru provides artificial intelligence operations (AIOps) features to help you improve the availability of your applications and resolve operational issues faster. DevOps Guru reduces your manual effort by applying machine learning (ML) powered recommendations, without requiring any ML expertise. DevOps Guru analyzes your resources and operational data. If it detects any anomalies, it provides metrics, events, and recommendations to help you address the issue.

This pattern describes three deployment options for enabling Amazon DevOps Guru:

- For all stack resources across multiple accounts and Regions

- For all stack resources across OUs
- For specific stack resources across multiple accounts and Regions

## Prerequisites and limitations

### Prerequisites

- An active AWS account.
- AWS Command Line Interface (AWS CLI), installed and configured. (See [Installing, updating, and uninstalling the AWS CLI](#) in the AWS CLI documentation.)
- AWS CDK Toolkit, installed and configured. (See [AWS CDK Toolkit](#) in the AWS CDK documentation.)
- Node Package Manager (npm), installed and configured for the AWS CDK in TypeScript. (See [Downloading and installing Node.js and npm](#) in the npm documentation.)
- Python3 installed and configured, for running a Python script to inject traffic into the sample serverless application. (See [Python Setup and Usage](#) in the Python documentation.)
- Pip, installed and configured to install the Python requests library. (See the [pip installation instructions](#) on the PyPI website.)

### Product versions

- AWS CDK Toolkit version 1.107.0 or later
- npm version 7.9.0 or later
- Node.js version 15.3.0 or later

## Architecture

### Technologies

The architecture for this pattern includes the following services:

- [Amazon DevOps Guru](#)
- [AWS CloudFormation](#)
- [Amazon API Gateway](#)

- [AWS Lambda](#)
- [Amazon DynamoDB](#)
- [Amazon CloudWatch](#)
- [AWS CloudTrail](#)

## AWS CDK stacks

The pattern uses the following AWS CDK stacks:

- `CdkStackSetAdminRole` – Creates an AWS Identity and Access management (IAM) administrator role to establish a trust relationship between the administrator and target accounts.
- `CdkStackSetExecRole` – Creates an IAM role to trust the administrator account.
- `CdkDevopsGuruStackMultiAccReg` – Enables DevOps Guru across multiple AWS Regions and accounts for all stacks, and sets up Amazon Simple Notification Service (Amazon SNS) notifications.
- `CdkDevopsGuruStackMultiAccRegSpecStacks` – Enables DevOps Guru across multiple AWS Regions and accounts for specific stacks, and sets up Amazon SNS notifications.
- `CdkDevopsguruStackOrgUnit` – Enables DevOps Guru across OUs, and sets up Amazon SNS notifications.
- `CdkInfrastructureStack` – Deploys sample serverless application components such as API Gateway, Lambda, and DynamoDB in the administrator account to demonstrate fault injection and insights generation.

## Sample application architecture

The following diagram illustrates the architecture of a sample serverless application that has been deployed across multiple accounts and Regions. The pattern uses the administrator account to deploy all the AWS CDK stacks. It also uses the administrator account as one of the target accounts for setting up DevOps Guru.

1. When DevOps Guru is enabled, it first baselines each resource's behavior and then ingests operational data from CloudWatch vended metrics.
2. If it detects an anomaly, it correlates it with the events from CloudTrail, and generates an insight.

- The insight provides a correlated sequence of events along with prescribed recommendations to enable the operator to identify the culprit resource.
- Amazon SNS sends notification messages to the operator.

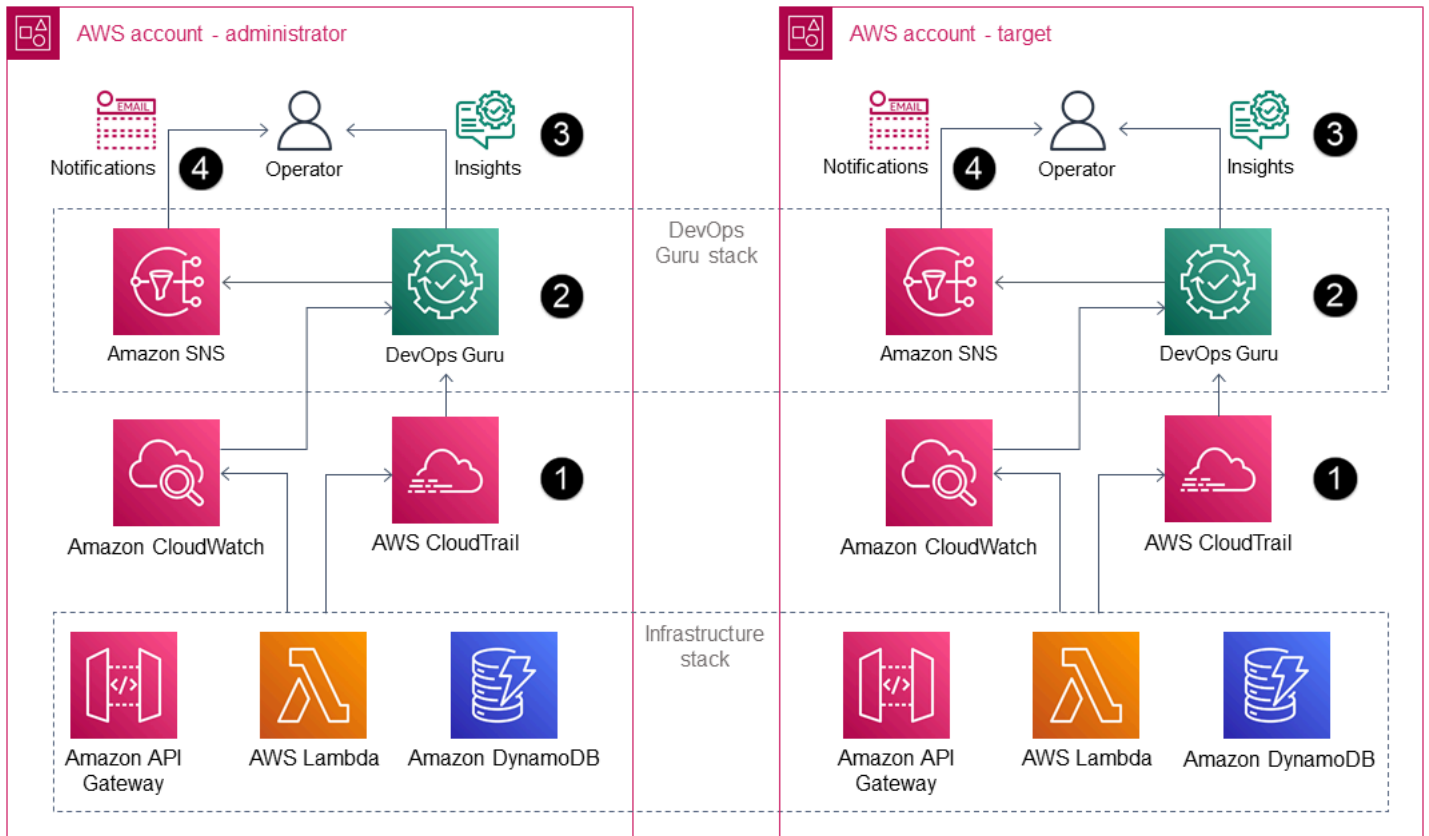

## Automation and scale

The [GitHub repository](#) provided with this pattern uses the AWS CDK as an infrastructure as code (IaC) tool to create the configuration for this architecture. AWS CDK helps you orchestrate resources and enable DevOps Guru across multiple AWS accounts, Regions, and OUs.

## Tools

### AWS services

- [AWS CDK](#) – AWS Cloud Development Kit (AWS CDK) helps you define your cloud infrastructure as code in one of five supported programming languages: TypeScript, JavaScript, Python, Java, and C#.



- [AWS CLI](#) – AWS Command Line Interface (AWS CLI) is a unified tool that provides a consistent command-line interface for interacting with AWS services and resources.

## Code

The source code for this pattern is available on GitHub, in the [Amazon DevOps Guru CDK Samples](#) repository. The AWS CDK code is written in TypeScript. To clone and use the repository, follow the instructions in the next section.

**Important:** Some of the stories in this pattern include AWS CDK and AWS CLI command examples that are formatted for Unix, Linux, and macOS. For Windows, replace the backslash (\) continuation character at the end of each line with a caret (^).

## Epics

### Prepare the AWS resources for deployment

Task	Description	Skills required
Configure AWS named profiles.	<p>Set up your AWS named profiles as follows to deploy stacks in a multi-account environment.</p> <p>For the administrator account:</p> <pre>\$aws configure --profile administrator AWS Access Key ID [****]: &lt;your-administrator-access-key-ID&gt; AWS Secret Access Key [****]: &lt;your-administrator-secret-access-key&gt; Default region name [None]: &lt;your-administrator-region&gt;</pre>	DevOps engineer

Task	Description	Skills required
	<p>Default output format [None]: json</p> <p>For the target account:</p> <pre>\$aws configure --profile target AWS Access Key ID [****]: &lt;your-target- access-key-ID&gt; AWS Secret Access Key [****]: &lt;your-target- secret-access-key&gt; Default region name [None]: &lt;your-target- region&gt; Default output format [None]: json</pre> <p>For more information, see <a href="#">Using named profiles</a> in the AWS CLI documentation.</p>	
Verify AWS profile configurations.	(Optional) You can verify your AWS profile configurations in the <code>credentials</code> and <code>config</code> files by following the instructions in <a href="#">Set and view configuration settings</a> in the AWS CLI documentation.	DevOps engineer

Task	Description	Skills required
Verify the AWS CDK version.	<p>Verify the version of the AWS CDK Toolkit by running the following command:</p> <pre data-bbox="594 394 1026 474">\$cdk --version</pre> <p>This pattern requires version 1.107.0 or later. If you have an earlier version of the AWS CDK, follow the instructions in the <a href="#">AWS CDK documentation</a> to update it.</p>	DevOps engineer
Clone the project code.	<p>Clone the GitHub repository for this pattern by using the command:</p> <pre data-bbox="594 999 1026 1192">\$git clone https://github.com/aws-samples/amazon-devops-guru-cdk-samples.git</pre>	DevOps engineer

Task	Description	Skills required
Install package dependencies and compile the TypeScript files.	<p>Install the package dependencies and compile the TypeScript files by running the following commands:</p> <pre data-bbox="594 489 1027 688">\$cd amazon-devopsguru-cdk-samples \$npm install \$npm fund</pre> <p>These commands install all the packages from the sample repository.</p> <p><b>Important:</b> If you get any errors about missing packages, use one of the following commands:</p> <pre data-bbox="594 1115 1027 1192">\$npm ci</pre> <p>—or—</p> <pre data-bbox="594 1304 1027 1423">\$npm install -g @aws-cdk/&lt;package-name&gt;</pre> <p>You can find the list of package names and versions in the <code>Dependencies</code> section of the <code>/amazon-devopsguru-cdk-samples/package.json</code> file. For more information, see</p>	DevOps engineer

Task	Description	Skills required
	<a href="#">npm ci</a> and <a href="#">npm install</a> in the npm documentation.	

### Build (synthesize) the AWS CDK stacks

Task	Description	Skills required
Configure an email address for Amazon SNS notifications.	<p>Follow these steps to provide an email address for Amazon SNS notifications:</p> <ol style="list-style-type: none"> <li>1. Edit the files <code>/amazon-devopsguru-cdk-samples/lib/cdk-devopsguru-multi-account-reg-stack.ts</code> and <code>/amazon-devopsguru-cdk-samples/lib/cdk-devopsguru-org-unit-stack.ts</code>.</li> <li>2. In the <code>DevOpsGuruTopic</code>, <code>Subscription</code> section, update the <code>Endpoint</code> parameter with your email address.</li> <li>3. Save and close the files.</li> </ol>	DevOps engineer
Build the project code.	<p>Build the project code and synthesize the stacks by running the command:</p> <pre>npm run build &amp;&amp; cdk synth</pre>	DevOps engineer

Task	Description	Skills required
	<p>You should see output similar to the following:</p> <pre data-bbox="597 331 1026 1201">\$npm run build &amp;&amp; cdk synth &gt; cdk-devopsguru@0.1.0 build &gt; tsc Successfully synthesized to ~/amazon-devopsguru-cdk-samples/cdk.out Supply a stack id (CdkDevopsGuruStackMultiAccReg, CdkDevopsGuruStackMultiAccRegSpecStacks, CdkDevopsguruStackOrgUnit, CdkInfrastructureStack, CdkStackSetAdminRole, CdkStackSetExecRole) to display its template.</pre> <p>For more information and steps, see <a href="#">Your first AWS CDK app</a> in the AWS CDK documentation.</p>	

Task	Description	Skills required
List the AWS CDK stacks.	<p>Run the following command to list all AWS CDK stacks:</p> <pre>\$cdk list</pre> <p>The command displays the following list:</p> <pre>CdkDevopsGuruStack MultiAccReg CdkDevopsGuruStack ackMultiAccRegSpec Stacks CdkDevopsguruStackOr gUnit CdkInfrastructureStack CdkStackSetAdminRole CdkStackSetExecRole</pre>	DevOps engineer

### Option 1 - Enable DevOps Guru for all stack resources across multiple accounts

Task	Description	Skills required
Deploy the AWS CDK stacks for creating IAM roles.	<p>This pattern uses <a href="#">AWS CloudFormation StackSets</a> to perform stack operations across multiple accounts. If you are creating your first stack set, you must create the following IAM roles to get the required permissions set up in your AWS accounts:</p>	DevOps engineer

Task	Description	Skills required
	<ul style="list-style-type: none"><li>• <code>AWSCloudFormationStackSetAdministrationRole</code></li><li>• <code>AWSCloudFormationStackSetExecutionRole</code></li></ul> <p><b>Note:</b> The roles must have these exact names.</p> <ol style="list-style-type: none"><li>1. Create the IAM <code>AWSCloudFormationStackSetAdministrationRole</code> role in the administrator (primary) account by running the following CLI command: <pre>\$cdk deploy CdkStackSetAdminRole --profile administrator</pre></li><li>2. Create the IAM <code>AWSCloudFormationStackSetExecutionRole</code> role in all target accounts where you want to run the stack instances. To create this role, run these CLI commands: <pre>\$cdk deploy CdkStackSetExecRole \ --parameters AdministratorAccou</pre></li></ol>	



Task	Description	Skills required
	<pre>ntId=&lt;administrato r-account-ID&gt; \   --profile administr ator  \$cdk deploy CdkStackS etExecRole \   --parameters AdministratorAccou ntId=&lt;administrato r-account-ID&gt; \   --profile target</pre> <p>For more information, see <a href="#">Grant self-managed permissions</a> in the AWS CloudFormation documentation.</p>	

Task	Description	Skills required
Deploy the AWS CDK stack for enabling DevOps Guru across multiple accounts.	<p>The AWS CDK <code>CdkDevopsGuruStackMultiAccReg</code> stack creates stack sets to deploy stack instances across multiple accounts and Regions. To deploy the stack, run the following CLI command with the specified parameters:</p> <pre data-bbox="597 684 1027 1318">\$cdk deploy CdkDevopsGuruStackMultiAccReg \   --profile administrator \   --parameters AdministratorAccountId=&lt;administrator-account-ID&gt; \   --parameters TargetAccountId=&lt;target-account-ID&gt; \   --parameters RegionIds="&lt;region-1&gt;,&lt;region-2&gt;"</pre> <p>Currently Amazon DevOps Guru is available in the AWS Regions listed in the <a href="#">DevOps Guru FAQ</a>.</p>	DevOps engineer

## Option 2 - Enable DevOps Guru for all stack resources across OUs

Task	Description	Skills required
Extract OU IDs.	On the <a href="#">AWS Organizations</a> console, identify the IDs of the organizational units where you want to enable DevOps Guru.	DevOps engineer
Enable service-managed permissions for OUs.	If you're using AWS Organizations for account management, you must grant service-managed permissions to enable DevOps Guru. Instead of creating the IAM roles manually, use <a href="#">organization-based trusted access and service-linked roles (SLRs)</a> .	DevOps engineer
Deploy the AWS CDK stack for enabling DevOps Guru across OUs.	<p>The AWS CDK <code>CdkDevops guruStackOrgUnit</code> stack enables DevOps Guru service across OUs. To deploy the stack, run the following command with the specified parameters:</p> <pre>\$cdk deploy CdkDevops guruStackOrgUnit \   --profile administrator \   --parameters   RegionIds="&lt;region-1&gt;,&lt;region-2&gt;" \   --parameters   OrganizationalUnit   Ids="&lt;OU-1&gt;,&lt;OU-2&gt;"</pre>	DevOps engineer

### Option 3 - Enable DevOps Guru for specific stack resources across multiple accounts

Task	Description	Skills required
Deploy the AWS CDK stacks for creating IAM roles.	<p>If you haven't already created the required IAM roles shown in the first option, do that first:</p> <ol style="list-style-type: none"><li>1. Create the IAM <code>AWSCloudFormationStackSetAdministrationRole</code> role in the administrator (primary) account by running the following CLI command: <pre>\$cdk deploy CdkStackSetAdminRole --profile administrator</pre></li><li>2. Create the IAM <code>AWSCloudFormationStackSetExecutionRole</code> role in all target accounts where you want to run the stack instances. To create this role, run the CLI commands: <pre>\$cdk deploy CdkStackSetExecRole \   --parameters AdministratorAccountId=&lt;administrator-account-ID&gt; \   --profile administrator</pre></li></ol>	DevOps engineer

Task	Description	Skills required
	<pre data-bbox="630 205 1026 506">\$cdk deploy CdkStackSetExecRole \   --parameters   AdministratorAccountId=&lt;administrator-account-ID&gt; \   --profile target</pre> <p data-bbox="591 575 1026 751">For more information, see <a href="#">Grant self-managed permissions</a> in the AWS CloudFormation documentation.</p>	
Delete existing stacks.	<p data-bbox="591 800 1026 1073">If you already used the first option to enable DevOps Guru for all stack resources, you can delete the old stack by using the following command:</p> <pre data-bbox="597 1108 1026 1308">\$cdk destroy CdkDevopsGuruStackMultiAccReg --profile administrator</pre> <p data-bbox="591 1346 1026 1570">Or, you can change the <code>RegionIds</code> parameter when you redeploy the stack to avoid a <i>Stacks already exist</i> error.</p>	DevOps engineer

Task	Description	Skills required
Update the AWS CDK stack with a stack list.	<ol style="list-style-type: none"><li data-bbox="594 226 1026 457">1. Edit the file <code>/amazon-devopsguru-cdk-samples/lib/cdk-devopsguru-multi-acc-reg-spec-stack.ts</code> .</li><li data-bbox="594 478 1026 1045">2. Under <code>Resources</code> , <code>CloudFormation</code> , <code>StackNames</code> , list the stacks for which you want to enable DevOps Guru. For demonstration purposes, the parameter specifies the <code>CdkInfrastructureStack</code> stack, but you can edit this entry based on your requirements.</li><li data-bbox="594 1066 1026 1108">3. Save and close the file.</li><li data-bbox="594 1129 1026 1213">4. To synthesize and update the stack template, run: <div data-bbox="630 1239 1026 1318" style="border: 1px solid #ccc; border-radius: 10px; padding: 5px; text-align: center;"><code>\$cdk synth</code></div></li></ol>	Data engineer

Task	Description	Skills required
Deploy the AWS CDK stack for enabling DevOps Guru for specific stack resources across multiple accounts.	<p>The AWS CDK <code>CdkDevopsGuruStackMultiAccRegSpecStacks</code> stack enables DevOps Guru for specific stack resources across multiple accounts. To deploy the stack, run the following command:</p> <pre data-bbox="597 636 1027 1270">\$cdk deploy CdkDevopsGuruStackMultiAccRegSpecStacks \   --profile administrator \   --parameters AdministratorAccountId=&lt;administrator-account-ID&gt; \   --parameters TargetAccountId=&lt;target-account-ID&gt; \   --parameters RegionIds="&lt;region-1&gt;,&lt;region-2&gt;"</pre> <p><b>Note:</b> If you previously deployed this stack for option 1, change the <code>RegionIds</code> parameter (making sure to choose from <a href="#">available Regions</a>) to avoid a <i>Stacks already exist</i> error.</p>	DevOps engineer

## Deploy the AWS CDK infrastructure stack

Task	Description	Skills required
Deploy the sample serverless infrastructure stack.	<p>The AWS CDK <code>CdkInfrastructureStack</code> stack deploys serverless components such as API Gateway, Lambda, and a DynamoDB table to demonstrate DevOps Guru insights. To deploy the stack, run the following command:</p> <pre data-bbox="594 785 1027 947">\$cdk deploy CdkInfrastructureStack --profile administrator</pre>	DevOps engineer
Insert sample records in DynamoDB.	<p>Run the following command to populate the DynamoDB table with sample records. Provide the correct path for the <code>populate-shops-dynamodb-table.json</code> script.</p> <pre data-bbox="594 1346 1027 1703">\$aws dynamodb batch-write-item \   --request-items   file://scripts/populate-shops-dynamodb-table.json \   --profile administrator</pre> <p>The command displays the following output:</p>	DevOps engineer



Task	Description	Skills required
	<pre data-bbox="594 214 1026 411">{   "UnprocessedItems" : {} }</pre>	

Task	Description	Skills required
Verify inserted records in DynamoDB.	<p>To verify that the DynamoDB table includes the sample records from the <code>populate-shops-dynamodb-table.json</code> file, access the URL for the <code>ListRestApiEndpointMonitorOperator</code> API, which is published as an output of the AWS CDK stack. You can also find this URL in the <b>Outputs</b> tab of the AWS CloudFormation console for the <code>CdkInfrastructureStack</code> stack. The AWS CDK output would look similar to the following:</p> <pre data-bbox="594 1066 1029 1780">CdkInfrastructureStack.CreateRestApiMonitorOperatorEndpointD1D00045 =   https://oure17c5vob.execute-api.&lt;your-region&gt;.amazonaws.com/prod/  CdkInfrastructureStack.ListRestApiMonitorOperatorEndpointABBDB8D8 =   https://cdff8icfrn4.execute-api.&lt;your-region&gt;.amazonaws.com/prod/</pre>	DevOps engineer

Task	Description	Skills required
Wait for resources to complete baselining.	This serverless stack has a few resources. We recommend that you wait for 2 hours before you carry out the next steps. If you deployed this stack in a production environment, it might take up to 24 hours to complete baselining, depending on the number of resources you selected to monitor in DevOps Guru.	DevOps engineer

## Generate DevOps Guru insights

Task	Description	Skills required
Update the AWS CDK infrastructure stack.	<p>To try out DevOps Guru insights, you can make some configuration changes to reproduce a typical operational issue.</p> <ol style="list-style-type: none"><li>1. Edit the file <code>/amazon-devopsguru-cdk-samples/lib/infrastructure-stack.ts</code>.</li><li>2. In the <code>DDB Table</code> section, change the read capacity for the DynamoDB table from 5 to 1.</li><li>3. Save and close the file.</li><li>4. Run the following commands to synthesize</li></ol>	DevOps engineer

Task	Description	Skills required
	<p>and deploy the updated AWS CDK infrastructure stack:</p> <pre data-bbox="630 380 1029 575">\$cdk synth \$cdk deploy CdkInfrastructureStack -- profile administrator</pre>	

Task	Description	Skills required
Inject HTTP requests on the API.	<p>Inject ingress traffic in the form of HTTP requests on the <code>ListRestApiMonitorOperatorEndpointxx</code> API:</p> <ol style="list-style-type: none"><li>1. Edit the Python script <code>/amazon-devopsguru-cdk-samples/scripts/sendAPIRequest.py</code>.</li><li>2. Update the <code>url</code> variable with the API link for <code>ListRestApiMonitorOperatorEndpointxx</code>. You can find this URL in the output of the AWS CDK <b>deploy</b> command or on the AWS Cloudformation console, in the <b>Outputs</b> tab for the stack.</li><li>3. Save and close the file.</li><li>4. Run the Python script by using the command: <pre>\$python sendAPIRequest.py</pre></li><li>5. Make sure that you get a 200 status code.</li><li>6. You might need to run the script through multiple (preferably four) terminals</li></ol>	DevOps engineer

Task	Description	Skills required
	<p>to inject traffic at a high rate.</p> <p>7. After the script runs approximately 10 minutes in a loop, you can see an operational insight on the <a href="#">DevOps Guru console</a>.</p>	
Review DevOps Guru insights.	<p>Under standard conditions, the DevOps Guru dashboard displays zero in the ongoing insights counter. If it detects an anomaly, it raises an alert in the form of an insight. In the navigation pane, choose <b>Insights</b> to see the details of the anomaly, including an overview, aggregated metrics, relevant events, and recommendations. For more information about reviewing insights, see the <a href="#">Gaining operational insights with AIOps using Amazon DevOps Guru</a> blog post.</p>	DevOps engineer

## Clean up

Task	Description	Skills required
Clean up and delete resources .	After you walk through this pattern, you should remove the resources you created to avoid incurring any	DevOps engineer

Task	Description	Skills required
	<p>further charges. Run these commands:</p> <pre data-bbox="597 331 1026 1285">\$cdk destroy CdkDevops GuruStackMultiAccR eg --profile administr ator \$cdk destroy CdkDevops guruStackOrgUnit -- profile administrator \$cdk destroy CdkDevops GuruStackMultiAccR egSpecStacks --profile administrator \$cdk destroy CdkInfras tructureStack -- profile administrator \$cdk destroy CdkStackS etAdminRole --profile administrator \$cdk destroy CdkStackS etExecRole --profile administrator \$cdk destroy CdkStackS etExecRole --profile target</pre>	

## Related resources

- [Gaining operational insights with AIOps using Amazon DevOps Guru](#)
- [Easily configure Amazon DevOps Guru across multiple accounts and Regions using AWS CloudFormation StackSets](#)
- [DevOps Guru Workshop](#)

# Implement Account Factory for Terraform (AFT) by using a bootstrap pipeline

Created by Vinicius Elias (AWS) and Edgar Costa Filho (AWS)

<b>Code repository:</b> <a href="#">aft-boots-trap-pipeline</a>	<b>Environment:</b> Production	<b>Technologies:</b> Management & governance; Infrastructure
<b>Workload:</b> Open-source	<b>AWS services:</b> AWS CodeBuild; AWS CodeCommit; AWS CodePipeline; AWS Control Tower; AWS Organizations	

## Summary

This pattern provides a simple and secure method for deploying AWS Control Tower Account Factory for Terraform (AFT) from the management account of AWS Organizations. The core of the solution is an AWS CloudFormation template that automates the AFT configuration by creating a Terraform pipeline, which is structured to be easily adaptable for initial deployment or subsequent updates.

Security and data integrity are top priorities at AWS, so the Terraform state file, which is a critical component that tracks the state of the managed infrastructure and configurations, is securely stored in an Amazon Simple Storage Service (Amazon S3) bucket. This bucket is configured with several security measures, including server-side encryption and policies to block public access, to help ensure that your Terraform state is safeguarded against unauthorized access and data breaches.

The management account orchestrates and oversees the entire environment, so it is a critical resource in AWS Control Tower. This pattern follows AWS best practices and ensures that the deployment process is not only efficient but also aligns with security and governance standards, to offer a comprehensive, secure, and efficient way to deploy AFT in your AWS environment.

For more information about AFT, see the [AWS Control Tower documentation](#).



# Prerequisites and limitations

## Prerequisites

- A basic AWS multi-account environment with the following accounts at the minimum: management account, Log Archive account, Audit account, and one additional account for AFT management.
- An established AWS Control Tower environment. The management account should be properly configured, because the CloudFormation template will be deployed within it.
- The necessary permissions in the AWS management account. You'll need sufficient permissions to create and manage resources such as S3 buckets, AWS Lambda functions, AWS Identity and Access Management (IAM) roles, and AWS CodePipeline projects.
- Familiarity with Terraform. Understanding Terraform's core concepts and workflow is important because the deployment involves generating and managing Terraform configurations.

## Limitations

- Be aware of the [AWS resource quotas](#) in your account. The deployment might create multiple resources, and encountering service quotas could impede the deployment process.
- The template is designed for specific versions of Terraform and AWS services. Upgrading or changing versions might require template modifications.

## Product versions

- Terraform version 1.5.7 or later
- AFT version 1.11.1 or later

## Architecture

### Target technology stack

- AWS CloudFormation
- AWS CodeBuild
- AWS CodeCommit
- AWS CodePipeline

- Amazon EventBridge
- IAM
- AWS Lambda
- Amazon S3

## Target architecture

The following diagram illustrates the implementation discussed in this pattern.

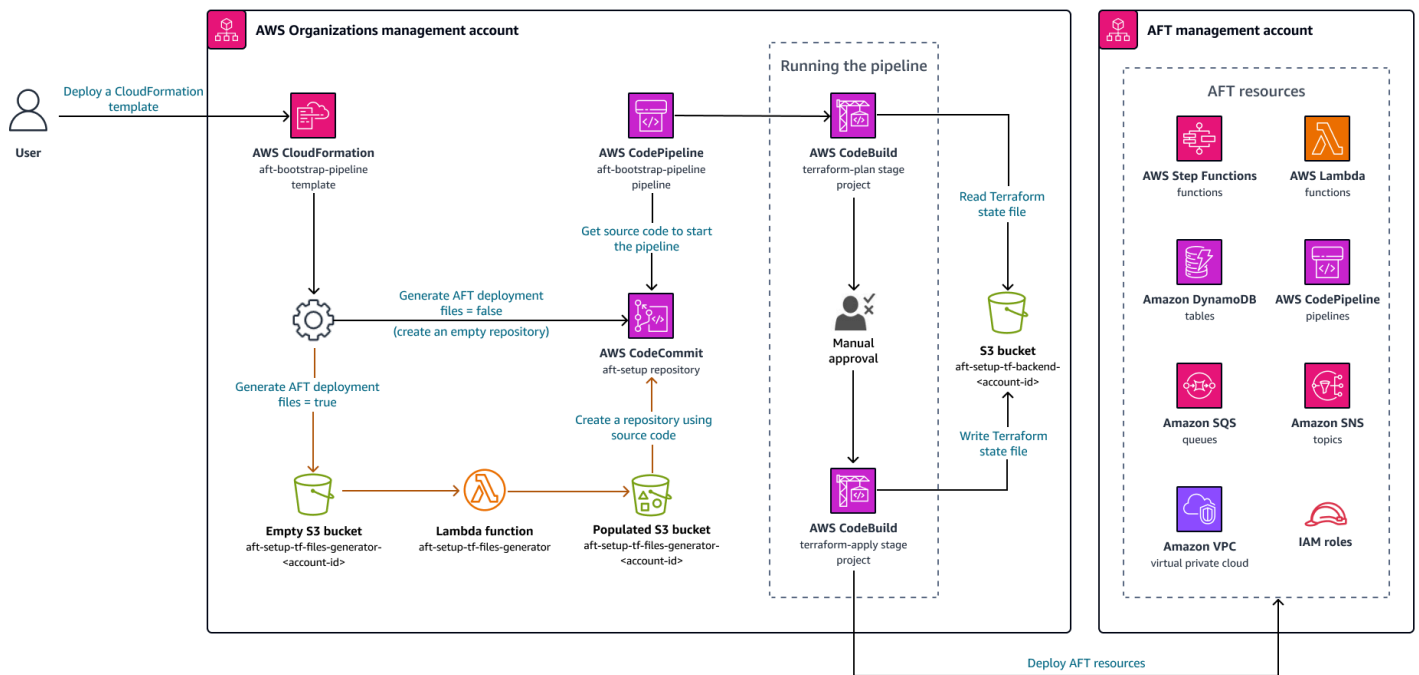

The workflow consists of three main tasks: creating the resources, generating the content, and running the pipeline.

### Creating the resources

The [CloudFormation template that's provided with this pattern](#) creates and sets up all required resources, depending on the parameters you select when you deploy the template. At the minimum, the template creates the following resources:

- A CodeCommit repository to store the AFT Terraform bootstrap code
- An S3 bucket to store the Terraform state file that's associated with the AFT implementation
- A CodePipeline pipeline

- Two CodeBuild projects to implement the Terraform plan and apply commands in different stages of the pipeline
- IAM roles for CodeBuild and CodePipeline services
- A second S3 bucket to store pipeline runtime artifacts
- An EventBridge rule to capture CodeCommit repository changes on the main branch
- Another IAM role for the EventBridge rule

Additionally, if you set the `Generate AFT Files` parameter in the CloudFormation template to `true`, the template creates these additional resources to generate the content:

- An S3 bucket to store the generated content and to be used as the source of the CodeCommit repository
- A Lambda function to process the given parameters and generate the appropriate content
- An IAM function to run the Lambda function
- A CloudFormation custom resource that runs the Lambda function when the template is deployed

### *Generating the content*

To generate the AFT bootstrap files and their content, the solution uses a Lambda function and an S3 bucket. The function creates a folder in the bucket, and then creates two files inside the folder: `main.tf` and `backend.tf`. The function also processes the provided CloudFormation parameters and populates these files with predefined code, replacing the respective parameter values.

To view the code that's used as a template to generate the files, see the solution's [GitHub repository](#). Basically, the files are generated as follows.

#### **main.tf**

```
module "aft" {
  source = "github.com/aws-ia/terraform-aws-control_tower_account_factory?
ref=<aft_version>"

  # Required variables
  ct_management_account_id = "<ct_management_account_id>"
  log_archive_account_id   = "<log_archive_account_id>"
  audit_account_id         = "<audit_account_id>"
  aft_management_account_id = "<aft_management_account_id>"
```

```
ct_home_region          = "<ct_home_region>"

# Optional variables
tf_backend_secondary_region = "<tf_backend_secondary_region>"
aft_metrics_reporting      = "<false|true>"

# AFT Feature flags
aft_feature_cloudtrail_data_events      = "<false|true>"
aft_feature_enterprise_support          = "<false|true>"
aft_feature_delete_default_vpcs_enabled = "<false|true>"

# Terraform variables
terraform_version      = "<terraform_version>"
terraform_distribution = "<terraform_distribution>"

}
```

## backend.tf

```
terraform {
  backend "s3" {
    region = "<aft-main-region>"
    bucket = "<s3-bucket-name>"
    key    = "aft-setup.tfstate"
  }
}
```

During the CodeCommit repository creation, if you set the `Generate AFT Files` parameter to `true`, the template uses the S3 bucket with the generated content as the source of the main branch to automatically populate the repository.

### *Running the pipeline*

After the resources have been created and the bootstrap files have been configured, the pipeline runs. The first stage (*Source*) fetches the source code from the main branch of the repository, and the second stage (*Build*) runs the Terraform plan command and generates the results to be reviewed. In the third stage (*Approval*), the pipeline waits for a manual action to approve or reject the last stage (*Deploy*). At the last stage, the pipeline runs the Terraform apply command by using the result of the previous Terraform plan command as input. Finally, a cross-account role and the permissions in the management account are used to create the AFT resources in the AFT management account.

# Tools

## AWS services

- [AWS CloudFormation](#) helps you set up AWS resources, provision them quickly and consistently, and manage them throughout their lifecycle across AWS accounts and Regions.
- [AWS CodeBuild](#) is a fully managed build service that helps you compile source code, run unit tests, and produce artifacts that are ready to deploy.
- [AWS CodeCommit](#) is a version control service that helps you privately store and manage Git repositories without needing to manage your own source control system.
- [AWS CodePipeline](#) helps you quickly model and configure the different stages of a software release and automate the steps required to release software changes continuously.
- [AWS Lambda](#) is a compute service that runs your code in response to events and automatically manages compute resources, providing a fast way to create a modern, serverless application for production.
- [AWS SDK for Python \(Boto3\)](#) is a software development kit that helps you integrate your Python application, library, or script with AWS services.

## Other tools

- [Terraform](#) is an infrastructure as code (IaC) tool that lets you build, change, and version infrastructure safely and efficiently. This includes low-level components such as compute instances, storage, and networking; and high-level components such as DNS entries and SaaS features.
- [Python](#) is an easy to learn, powerful programming language. It has efficient high-level data structures and provides a simple but effective approach to object-oriented programming.

## Code repository

The code for this pattern is available in the GitHub [AFT bootstrap pipeline repository](#).

For the official AFT repository, see [AWS Control Tower Account Factory for Terraform](#) in GitHub.

## Best practices

When you deploy AFT by using the provided CloudFormation template, we recommend that you follow best practices to help ensure a secure, efficient, and successful implementation. Key guidelines and recommendations for implementing and operating the AFT include the following.

- **Thorough review of parameters:** Carefully review and understand each parameter in the CloudFormation template. Accurate parameter configuration is crucial for the correct setup and functioning of AFT.
- **Regular template updates:** Keep the template updated with the latest AWS features and Terraform versions. Regular updates help you take advantage of new functionality and maintain security.
- **Versioning:** Pin your AFT module version and use a separate AFT deployment for testing if possible.
- **Scope:** Use AFT only to deploy infrastructure guardrails and customizations. Do not use it to deploy your application.
- **Linting and validation:** The AFT pipeline requires a linted and validated Terraform configuration. Run lint, validate, and test before pushing the configuration to AFT repositories.
- **Terraform modules:** Build reusable Terraform code as modules, and always specify the Terraform and AWS provider versions to match your organization's requirements.

## Epics

### Set up and configure the AWS environment

Task	Description	Skills required
Prepare the AWS Control Tower environment.	Set up and configure AWS Control Tower in your AWS environment to ensure centralized management and governance for your AWS accounts. For more information, see <a href="#">Getting started with AWS Control</a>	Cloud administrator

Task	Description	Skills required
	<a href="#">Tower</a> in the AWS Control Tower documentation.	
Launch the AFT management account.	Use the AWS Control Tower Account Factory to launch a new AWS account to serve as your AFT management account. For more information, see <a href="#">Provision accounts with AWS Service Catalog Account Factory</a> in the AWS Control Tower documentation.	Cloud administrator

## Deploy the CloudFormation template in the management account

Task	Description	Skills required
Launch the CloudFormation template.	<p>In this epic, you deploy the CloudFormation template provided with this solution to set up the AFT bootstrap pipeline in your AWS management account. The pipeline deploys the AFT solution in the AFT management account that you set up in the previous epic.</p> <p><b>Step 1: Open the AWS CloudFormation console</b></p> <ul style="list-style-type: none"> <li>Sign in to the AWS Management Console and</li> </ul>	Cloud administrator

Task	Description	Skills required
	<p>open the <a href="#">AWS CloudFormation console</a>. Make sure that you are operating within the correct AWS Control Tower main Region.</p> <p><b>Step 2: Create a new stack</b></p> <ol style="list-style-type: none"><li>1. Choose to create a new stack.</li><li>2. Select the option to upload a template file, and upload the <a href="#">CloudFormation template</a> that's provided with this pattern.</li></ol> <p><b>Step 3: Configure stack parameters</b></p> <ul style="list-style-type: none"><li>• Repository Name : Specify the repository name for storing the AFT bootstrap module.</li><li>• Branch Name: Specify the source repository branch.</li><li>• CodeBuild Docker Image: Choose the file to use as the CodeBuild Docker base image.</li></ul> <p><b>Step 4: Decide on file generation</b></p>	



Task	Description	Skills required
	<ul style="list-style-type: none"><li>• The <code>Generate AFT Files</code> parameter controls whether to generate default AFT deployment files. Set this parameter to:<ul style="list-style-type: none"><li>• <code>true</code> to automatically create and store AFT deployment files in the specified repository.</li><li>• <code>false</code> if you want to manually handle the file creation or already have the files in place.</li></ul></li></ul> <p>If you selected <code>false</code>, go to step 8; otherwise, follow steps 5–7 first.</p> <p><b>Step 5: Fill in AWS Control Tower and AFT account details</b></p> <ul style="list-style-type: none"><li>• Input AWS Control Tower and AFT account-specific information:<ul style="list-style-type: none"><li>• <code>Log Archive Account ID</code>: The ID of the Log Archive account ID in AWS Control Tower.</li><li>• <code>Audit Account ID</code>: The ID of the Audit account in AWS Control Tower.</li></ul></li></ul>	

Task	Description	Skills required
	<ul style="list-style-type: none"><li>• AFT Management Account ID: The ID of the AFT management account that you created in the first epic.</li><li>• AFT Main Region and AFT Secondary Region: The main and secondary AWS Regions for AFT deployment.</li></ul> <p><b>Step 6: Configure AFT options</b></p> <ul style="list-style-type: none"><li>• Set up metrics reporting:<ul style="list-style-type: none"><li>• AFT Enable Metrics Reporting : Enable or disable AFT metrics reporting. For more information, see <a href="#">Operational metrics</a> in the AWS Control Tower documentation.</li></ul></li><li>• Set AFT feature options:<ul style="list-style-type: none"><li>• Enable AFT CloudTrail Data Events: Enable CloudTrail data events in all AFT managed accounts. For more information, see <a href="#">AWS CloudTrail data events</a> in</li></ul></li></ul>	

Task	Description	Skills required
	<p>the AWS Control Tower documentation.</p> <ul style="list-style-type: none"> <li>• Enable AFT Enterprise Support : Enable Enterprise Support in all AFT managed accounts. For more information, see <a href="#">AWS Enterprise Support plan</a> in the AWS Control Tower documentation.</li> <li>• Enable AFT Delete Default VPC: Delete all VPCs in the AFT management account only. For more information, see <a href="#">Delete the AWS default VPC</a> in the AWS Control Tower documentation.</li> </ul> <p><b>Step 7: Specify versions</b></p> <ul style="list-style-type: none"> <li>• AFT Terraform Version: Choose the version of Terraform to use in AFT pipelines.</li> <li>• AFT Version: Define the AFT version for deployment. Keep the default setting (latest) to use the most current AFT version.</li> </ul>	

Task	Description	Skills required
	<p><b>Step 8: Review and create the stack</b></p> <ul style="list-style-type: none"><li>Review all the parameters and settings. If everything is in order, proceed to create the stack.</li></ul> <p><b>Step 9: Monitor stack creation</b></p> <ul style="list-style-type: none"><li>AWS CloudFormation provisions and configures the resources you defined. Monitor the stack creation process on the CloudFormation console. This process might take several minutes.</li></ul> <p><b>Step 10: Verify the deployment</b></p> <ul style="list-style-type: none"><li>When the stack status shows <b>CREATE_COMPLETE</b>, verify that all resources have been correctly created.</li><li>In the <b>Outputs</b> section, note the Terraform BackendBucketName value.</li></ul>	

## Populate and validate the AFT bootstrap repository and pipeline

Task	Description	Skills required
Populate the AFT bootstrap repository.	<p>(Optional) After you deploy the CloudFormation template, you can populate or validate the content in the newly created AFT bootstrap repository, and test whether the pipeline has run successfully.</p> <p>If you set the <code>Generate AFT Files</code> parameter to <code>true</code>, skip to the next story (validating the pipeline).</p> <p><b>Step 1: Populate the repository</b></p> <ol style="list-style-type: none"><li>1. Open the <a href="#">AWS CodeCommit console</a> and select the newly created repository. If you kept the default name, the repository will be called <code>aft-setup</code>.</li><li>2. Clone the repository to your local machine by using SSH, HTTPS, or HTTPS (GRC), and open it in an editor.</li><li>3. Create a folder called <code>terraform</code> and two empty files inside it: <code>backend.tf</code> and <code>main.tf</code>.</li></ol>	Cloud administrator

Task	Description	Skills required
	<p>4. Open the backend.tf file and add this code snippet:</p> <pre data-bbox="630 380 1029 816">terraform {   backend "s3" {     region = "&lt;aft-main-region&gt;"     bucket = "&lt;s3-bucket-name&gt;"     key    = "aft-setup"   } }</pre> <p>In the file:</p> <ul style="list-style-type: none"><li>• Replace &lt;aft-main-region&gt; with the main AFT Region. This should match the AWS Control Tower main Region.</li><li>• Replace &lt;s3-bucket-name&gt; with the name of the Terraform backend bucket. You can find this in the Terraform BackendBucketName output generated by the CloudFormation template you deployed earlier.</li></ul> <p>5. Open the main.tf file and use one of the examples available in the <a href="#">AFT repository</a> to deploy AFT. For example, you can</p>	

Task	Description	Skills required
	<p>work with your preferred version control system (VCS) provider (CodeCommit, GitHub, or Bitbucket) or customize the AFT VPC. For more AFT input options, see the <a href="#">README file</a> in the AFT repository.</p> <p><b>Step 2: Commit and push your changes</b></p> <ul style="list-style-type: none"><li>• After you have created and populated the folder and files, confirm your changes, and upload the code to the repository. The pipeline starts automatically, runs through the Source and Build stages, and then waits for an Approval action before the Deploy stage.</li></ul>	

Task	Description	Skills required
Validate the AFT bootstrap pipeline.	<p><b>Step 1: View the pipeline</b></p> <ul style="list-style-type: none"><li>• Open the <a href="#">CodePipeline console</a> and check whether the <code>aft-bootstrap-pipeline</code> pipeline was started successfully. It should be running a Terraform plan or waiting for a manual approval action.</li></ul> <p><b>Step 2: Approve the Terraform plan results</b></p> <ul style="list-style-type: none"><li>• You can review the results of the Terraform plan by looking at the execution logs of the Build stage, and then approve or reject the execution on the Approval stage. If you approve, the pipeline starts deploying AFT resources in the provided AFT management account.</li></ul> <p><b>Step 3: Wait for the deployment</b></p> <ul style="list-style-type: none"><li>• Wait for the pipeline to run successfully. This should take around 30 minutes. Any failures you might encounter are often caused</li></ul>	Cloud administrator



Task	Description	Skills required
	<p>by API quotas. In these cases, you can rerun the pipeline to continue the deployment.</p> <p><b>Step 4: Check created resources</b></p> <ul style="list-style-type: none"> <li>• Access the AFT management account and confirm that the resources have been created.</li> </ul>	

## Troubleshooting

Issue	Solution
<p>The custom Lambda function included in the CloudFormation template fails during deployment.</p>	<p>Check the Amazon CloudWatch logs for the Lambda function to identify the error. The logs provide detailed information and can help pinpoint the specific issue. Confirm that the Lambda function has the necessary permissions and that the environment variables have been set correctly.</p>
<p>You encounter failures in resource creation or management caused by inadequate permissions.</p>	<p>Review the IAM roles and policies that are attached to the Lambda function, CodeBuild, and other services involved in the deployment. Confirm that they have the necessary permissions. If there are permission issues, adjust the IAM policies to grant the required access.</p>

Issue	Solution
You're using an outdated version of the CloudFormation template with newer AWS services or Terraform versions.	Regularly update the CloudFormation template to be compatible with the latest AWS and Terraform releases. Check the release notes or documentation for any version-specific changes or requirements.
You reach AWS service quotas during deployment.	Before you deploy the pipeline, check AWS service quotas for resources such as S3 buckets, IAM roles, and Lambda functions . Request increases if necessary. For more information, see <a href="#">AWS service quotas</a> on the AWS website.
You encounter errors due to incorrect input parameters in the CloudFormation template.	Double-check all input parameters for typos or incorrect values. Confirm that resource identifiers, such as account IDs and Region names, are accurate.

## Related resources

To implement this pattern successfully, review the following resources. These resources provide additional information and guidance that can be invaluable in setting up and managing AFT by using AWS CloudFormation.

### AWS documentation:

- [AWS Control Tower User Guide](#) offers detailed information on setting up and managing AWS Control Tower.
- [AWS CloudFormation documentation](#) provides insights into CloudFormation templates, stacks, and resource management.

### IAM policies and best practices:

- [Security best practices in IAM](#) explains how to help secure AWS resources by using IAM roles and policies.

**Terraform on AWS:**

- [Terraform AWS Provider documentation](#) provides comprehensive information about using Terraform with AWS.

**AWS service quotas:**

- [AWS service quotas](#) provides information about how to view AWS service quotas and how to request increases.

# Manage AWS Service Catalog products in multiple AWS accounts and AWS Regions

Created by Ram Kandaswamy (AWS)

**Environment:** Production

**Technologies:** Management & governance; Infrastructure; Modernization

**Workload:** All other workloads

**AWS services:** AWS Service Catalog; AWS CloudFormation

## Summary

Amazon Web Services (AWS) Service Catalog simplifies and accelerates the governance and distribution of infrastructure as code (IaC) templates for enterprises. You use AWS CloudFormation templates to define a collection of AWS resources (*stacks*) required for a product. AWS CloudFormation StackSets extends this functionality by enabling you to create, update, or delete stacks across multiple accounts and AWS Regions with a single operation.

AWS Service Catalog administrators create products by using CloudFormation templates that are authored by developers, and publish them. These products are then associated with a portfolio, and constraints are applied for governance. To make your products available to users in other AWS accounts or organizational units (OUs), you typically [share your portfolio](#) with them. This pattern describes an alternative approach for managing AWS Service Catalog product offerings that is based on AWS CloudFormation StackSets. Instead of sharing portfolios, you use stack set constraints to set AWS Regions and accounts where your product can be deployed and used. By using this approach, you can provision your AWS Service Catalog products in multiple accounts, OUs, and AWS Regions, and manage them from a central location, while meeting your governance requirements.

Benefits of this approach:

- The product is provisioned and managed from the primary account, and not shared with other accounts.

- This approach provides a consolidated view of all provisioned products (stacks) that are based on a specific product.
- Configuration with AWS Service Management Connector is easier, because it targets only one account.
- It's easier to query and use products from AWS Service Catalog.

## Prerequisites and limitations

### Prerequisites

- AWS CloudFormation templates for IaC and versioning
- Multi-account setup and AWS Service Catalog for provisioning and managing AWS resources

### Limitations

- This approach uses AWS CloudFormation StackSets, and the limitations of StackSets apply:
  - StackSets doesn't support CloudFormation template deployment through macros. If you're using a macro to preprocess the template, you won't be able to use a StackSets-based deployment.
  - StackSets provides the ability to disassociate a stack from the stack set, so you can target a specific stack to fix an issue. However, a disassociated stack cannot be re-associated with the stack set.
- AWS Service Catalog autogenerated StackSet names. Customization isn't currently supported.

## Architecture

### Target architecture

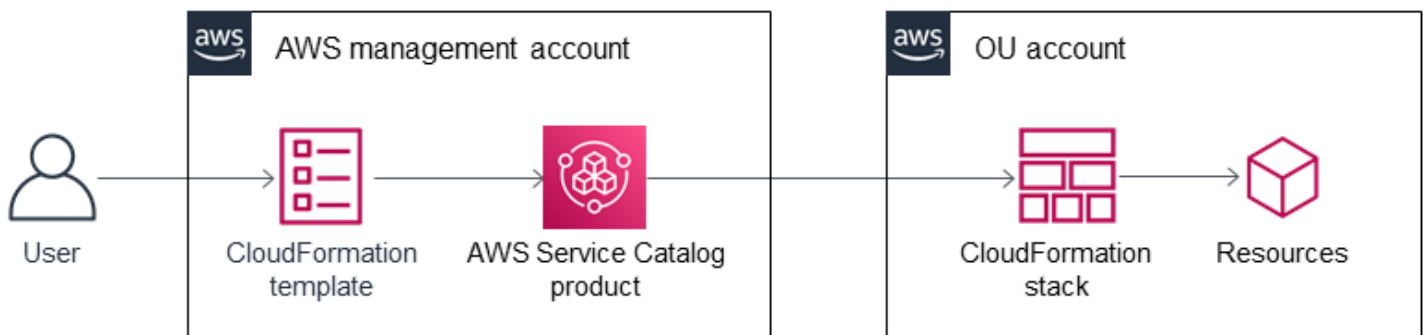

1. The user creates an AWS CloudFormation template to provision AWS resources, in JSON or YAML format.
2. The CloudFormation template creates a product in AWS Service Catalog, which is added to a portfolio.
3. The user creates a provisioned product, which creates CloudFormation stacks in the target accounts.
4. Each stack provisions the resources specified in the CloudFormation templates.

## Tools

### AWS services

- [AWS CloudFormation](#) helps you set up AWS resources, provision them quickly and consistently, and manage them throughout their lifecycle across AWS accounts and Regions.
- [AWS Command Line Interface \(AWS CLI\)](#) is an open-source tool that helps you interact with AWS services through commands in your command-line shell.
- [AWS Identity and Access Management \(IAM\)](#) helps you securely manage access to your AWS resources by controlling who is authenticated and authorized to use them.
- [AWS Service Catalog](#) helps you centrally manage catalogs of IT services that are approved for AWS. End users can quickly deploy only the approved IT services they need, following the constraints set by your organization.

## Epics

### Provision products across accounts

Task	Description	Skills required
Create a portfolio.	A portfolio is a container that includes one or more products that are grouped together based on specific criteria. Using a portfolio for your products helps you apply	AWS Service Catalog, IAM

Task	Description	Skills required
	<p>common constraints across your product set.</p> <p>To create a portfolio, follow the instructions in the <a href="#">AWS Service Catalog documentation</a>. If you're using the AWS CLI, here's an example command:</p> <pre>aws servicecatalog   create-portfolio --   provider-name my-provid   er --display-name my-   portfolio</pre> <p>For more information, see the <a href="#">AWS CLI documentation</a>.</p>	
Create a CloudFormation template.	Create a CloudFormation template that describes the resources. Resource property values should be parameterized where applicable.	AWS CloudFormation, JSON/YAML

Task	Description	Skills required
Create a product with version information.	<p>The CloudFormation template becomes a product when you publish it in the AWS Service Catalog. Provide values for the optional version detail parameters, such as version title and description; this will be helpful for querying for the product later.</p> <p>To create a product, follow the instructions in the <a href="#">AWS Service Catalog documentation</a>. If you're using the AWS CLI, an example command is:</p> <pre>aws servicecatalog   create-product --cli-   input-json file://cr   eate-product-input   .json</pre> <p>where <code>create-product-input.json</code> is the file that passes the parameters for the product. For an example of this file, see the <i>Additional information</i> section. For more information, see the <a href="#">AWS CLI documentation</a>.</p>	AWS Service Catalog



Task	Description	Skills required
Apply constraints.	Apply stack set constraints to the portfolio, to configure product deployment options such as multiple AWS accounts, Regions, and permissions. For instructions, see the <a href="#">AWS Service Catalog documentation</a> .	AWS Service Catalog
Add permissions.	<p>Provide permissions to users so that they can launch the products in the portfolio . For console instructions, see the <a href="#">AWS Service Catalog documentation</a>. If you're using the AWS CLI, here's an example command:</p> <pre data-bbox="594 1045 1029 1486">aws servicecatalog   associate-principal-   with-portfolio \     --portfolio-id     port-2s6abcdefwdh4 \     --principal-arn     arn:aws:iam::44445     5556666:role/Admin \     --principal-type     IAM</pre> <p>For more information, see the <a href="#">AWS CLI documentation</a>.</p>	AWS Service Catalog, IAM

Task	Description	Skills required
Provision the product.	<p>A provisioned product is a resourced instance of a product. Provisioning a product based on a CloudFormation template launches a CloudFormation stack and its underlying resources.</p> <p>Provision the product by targeting the applicable AWS Regions and accounts, based on stack set constraints. In the AWS CLI, here's an example command:</p> <pre data-bbox="597 951 1027 1388">aws servicecatalog   provision-product \     --product-id prod-   abcdfz3syn2rg \     --provisioning-   artifact-id pa-abc347   pcscfm \     --provisioned-prod   uct-name "mytestpp   name3"</pre> <p>For more information, see the <a href="#">AWS CLI documentation</a>.</p>	AWS Service Catalog

## Related resources

### References

- [Overview of AWS Service Catalog](#)
- [Using AWS CloudFormation StackSets](#)

## Tutorials and videos

- [AWS re:Invent 2019: Automate everything: Options and best practices](#) (video)

## Additional information

When you use the `create-product` command, the `cli-input-json` parameter points to a file that specifies information such as product owner, support email, and CloudFormation template details. Here's an example of such a file:

```
{
  "Owner": "Test admin",
  "SupportDescription": "Testing",
  "Name": "SNS",
  "SupportEmail": "example@example.com",
  "ProductType": "CLOUD_FORMATION_TEMPLATE",
  "AcceptLanguage": "en",
  "ProvisioningArtifactParameters": {
    "Description": "SNS product",
    "DisableTemplateValidation": true,
    "Info": {
      "LoadTemplateFromURL": "<url>"
    }
  },
  "Name": "version 1"
}
```

# Migrate an AWS member account from AWS Organizations to AWS Control Tower

Created by Rodolfo Jr. Cerrada (AWS)

**Environment:** Production

**Technologies:** Management & governance; Modernization

**AWS services:** AWS Organizations; AWS Control Tower

## Summary

This pattern describes how to migrate an Amazon Web Services (AWS) account from AWS Organizations, where it is a member account that's governed by a management account, to AWS Control Tower. By enrolling the account in AWS Control Tower, you can take advantage of preventive and detective guardrails and features that streamline your account governance. You might also want to migrate your member account if your AWS Organizations management account has been compromised, and you want to move member accounts to a new organization that is governed by AWS Control Tower.

AWS Control Tower provides a framework that combines and integrates the capabilities of several other AWS services, including AWS Organizations, and ensures consistent compliance and governance across your multi-account environment. With AWS Control Tower, you can follow a set of prescribed rules and definitions that extend the capabilities of AWS Organizations. For example, you can use guardrails to ensure that security logs and necessary cross-account access permissions are created, and not altered.

## Prerequisites and limitations

### Prerequisites

- An active AWS account
- AWS Control Tower set up in your target organization in AWS Organizations (for instructions, see [Setting up](#) in the AWS Control Tower documentation)
- Administrator credentials for AWS Control Tower (member of the **AWSControlTowerAdmins** group)

- Administrator credentials for the source AWS account

## Limitations

- The source management account in AWS Organizations must be different from the target management account in AWS Control Tower.

## Product versions

- AWS Control Tower version 2.3 (February 2020) or later (see [release notes](#))

## Architecture

The following diagram illustrates the migration process and reference architecture. This pattern migrates the AWS account from the source organization to a target organization that is governed by AWS Control Tower.

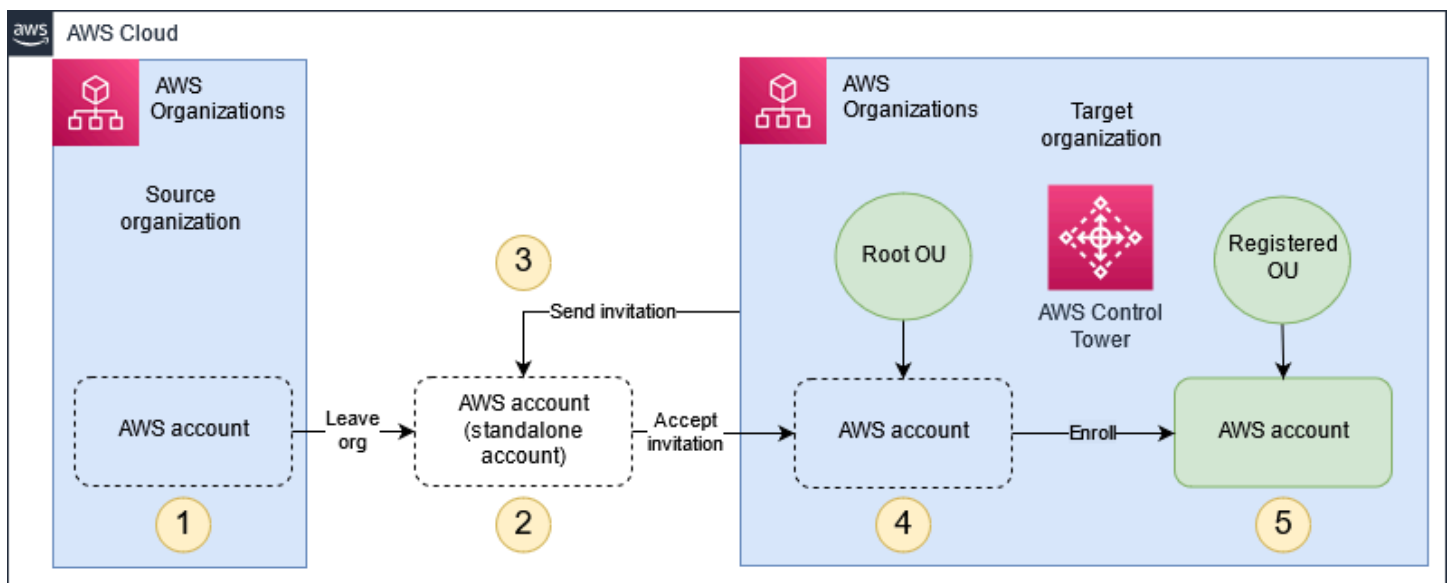

The enrollment process consists of these steps:

1. The account leaves the source organization in AWS Organizations.
2. The account becomes a standalone account. This means that it doesn't belong to any organization, so governance and billing are managed independently by account administrators.
3. The target organization sends an invitation for the account to join the organization.

4. The standalone account accepts the invitation and becomes a member of the target organization.
5. The account is enrolled in AWS Control Tower and moved to a registered organizational unit (OU). (We recommend that you check the AWS Control Tower dashboard to confirm the enrollment.) At this point, all guardrails that are enabled in the registered OU take effect.

## Tools

### AWS services

- [AWS Organizations](#) is an account management service that enables you to consolidate multiple AWS accounts into a single entity (an *organization*) that you create and centrally manage.
- [AWS Control Tower](#) integrates the capabilities of other services, including AWS Organizations, AWS IAM Identity Center (successor to AWS Single Sign-On), and AWS Service Catalog, to help you enforce and manage governance rules for security, operations, and compliance at scale across all your organizations and accounts in the AWS Cloud.

## Epics

### Remove the member account from the source organization

Task	Description	Skills required
Verify that the member account can run as a standalone account.	Confirm that the member account that will leave the source organization has the information that is required for it to operate as a standalone account. For example, if the member account doesn't have billing information, it can't operate as a standalone account, because AWS uses the payment information to charge for any billable AWS	Account administrator

Task	Description	Skills required
	<p>activity that occurs while the account isn't attached to an organization.</p> <p>Typically, if you created the member account by using the AWS Organizations console, API, or AWS Command Line Interface (CLI) commands, the information required of standalone accounts isn't automatically collected. To add this information, sign in to the account, and specify a support plan, contact information, and a payment method.</p> <p>For more information about what you need to know before removing an account from an organization, see <a href="#">Before removing an account from organization</a> in the AWS Organizations documentation.</p>	

Task	Description	Skills required
Remove the member account from its source organization.	<p>Follow the instructions in the AWS Organizations documentation to remove a member account from an organization. You can sign in to the organization's management account and <a href="#">remove the member account</a>, or sign in to the member account and <a href="#">leave the organization</a>.</p> <p>If you don't have administrator-level credentials to remove or leave the account, ask for assistance from your organization's administrator.</p> <p>If the member account is missing a support plan, contact information, or payment information, you will be prompted to provide and verify that information.</p> <p>When you leave the organization, you are redirected to the <b>Getting Started</b> page of the AWS Organizations console, where you can view invitations for your account to join other organizations.</p> <p><b>Important:</b> At this point, your account is a standalone account. If you are running</p>	Management account administrator or account administrator



Task	Description	Skills required
	workloads that aren't covered by AWS Free Tier, you will be charged according to the payment and billing information you provided for the account.	
Verify that the member account is no longer part of the source organization.	In the AWS Organizations console, you should no longer see the <b>Leave organization</b> button. Instead, you should see pending invitations, if any, from other organizations.	Account administrator

Task	Description	Skills required
Remove the IAM roles that grant access to your account from the organization you left.	<p>When you remove the account from the source organization, AWS Identity and Access Management (IAM) roles created by AWS Organizations or by administrators aren't automatically deleted. To terminate access from the source organization's management account, you must manually delete the IAM roles. For more information, see <a href="#">Deleting roles or instance profiles</a> in the IAM documentation.</p> <p>When a member account leaves an organization, all tags that were attached to the account are deleted. Standalone accounts do not support tags.</p>	Account administrator

### Invite the account to join the new organization with AWS Control Tower

Task	Description	Skills required
Sign in to AWS Control Tower.	<p>Sign in to the AWS Control Tower console as an administrator.</p> <p>Currently, there is no direct way to move an AWS account from a source organization to an organization in an</p>	AWS Control Tower administrator

Task	Description	Skills required
	<p>OU that's governed by AWS Control Tower. However, you can extend AWS Control Tower governance to an existing AWS account when you enroll it into an OU that's already governed by AWS Control Tower. That's why you have to log in to AWS Control Tower for this step.</p>	

Task	Description	Skills required
Invite the member account.	<ol style="list-style-type: none"><li data-bbox="591 226 1027 405">1. Sign in to the AWS Organizations console, and navigate to the <b>AWS Accounts</b> page.</li><li data-bbox="591 426 1027 604">2. On the <b>Add an AWS account</b> page, choose <b>Invite an existing AWS account</b>.</li><li data-bbox="591 625 1027 951">3. Complete the account information, including the 12-digit account number (without dashes) and the optional description and tags, and then choose <b>Send invitation</b>.</li></ol> <p data-bbox="591 1024 1027 1203"><b>Important:</b> Verify that no applications or network connectivity will be affected by the account transfer.</p> <p data-bbox="591 1245 1027 1854">This action sends an invitation email with a link to the member account. When the account administrator follows the link and accepts the invitation, the member account appears in the <b>AWS accounts</b> page. For more information, see <a href="#">Inviting an AWS account to join your organization</a> in the AWS Organizations documentation.</p>	AWS Control Tower administrator

Task	Description	Skills required
Test applications and connectivity.	<p>When the member account has been registered into the new organization, it appears in the OU within a root. It also appears in the AWS Control Tower console, flagged as not enrolled in accounts, because it hasn't yet been enrolled in the AWS Control Tower registered OU.</p> <p>Verify the following:</p> <ul style="list-style-type: none"><li>• Check the AWS Control Tower dashboard to see if there are any guardrail violations.</li><li>• Check network connectivity (VPN or AWS Direct Connect) to make sure it wasn't affected by the transfer.</li><li>• (Application owners) Test the applications that are associated with this account to verify that they run as expected, and that dependencies weren't affected by the account transfer.</li></ul>	AWS Control Tower administrator, Member account administrator, Application owners

## Prepare the account for enrollment

Task	Description	Skills required
Review guardrails and fix any violations.	<p>Review the guardrails that are defined in the target OU, especially the preventive guardrails, and fix any violations.</p> <p>A number of <a href="#">mandatory, preventive guardrails</a> are enabled by default when you set up your AWS Control Tower landing zone. These can't be disabled. You must review these mandatory guardrails and fix the member account (manually or by using a script) before you enroll the account.</p> <p><b>Note:</b> Preventive guardrails keep AWS Control Tower registered accounts compliant and prevent policy violations. Any violation of preventive guardrails might affect enrollment. Detective guardrail violations appear in the AWS Control Tower dashboard, if detected, after successful enrollment. They do not affect the enrollment process. For more information, see <a href="#">Guardrails in AWS</a></p>	AWS Control Tower administrator, Member account administrator

Task	Description	Skills required
	<a href="#">Control Tower</a> in the AWS documentation.	
Check for connectivity issues after fixing guardrail violations.	In some cases, you might have to close specific ports or disable services to fix guardrail violations. Make sure that applications that use those ports and services are remediated before you enroll the account.	Application owner

## Enroll the account into AWS Control Tower

Task	Description	Skills required
Sign in to the AWS Control Tower console.	Use sign-in credentials that have administrative permissions for AWS Control Tower. Do not use the root user (management account) credentials to enroll an AWS Organizations account. This will display an error message.	AWS Control Tower administrator
Enroll the account.	<ol style="list-style-type: none"> <li>From the Account Factory page in AWS Control Tower, choose <b>Enroll account</b>.</li> <li>Fill in the details, including the email address associated with the account you want to enroll, the display name that will appear in AWS Control Tower,</li> </ol>	AWS Control Tower administrator

Task	Description	Skills required
	<p>the IAM Identity Center email address, the first and last name of the account owner, and the OU in which you would like to enroll the account. The IAM Identity Center email address is your preferred user email address. You can use the same email address as the account email.</p> <p>3. Choose <b>Enroll account</b>.</p> <p>For more information, see <a href="#">Enroll an existing account</a> in the AWS Control Tower documentation.</p>	

## Verify the account after enrollment

Task	Description	Skills required
Verify the account.	<p>From AWS Control Tower, choose <b>Accounts</b>. The account that you just enrolled has an initial state of <b>Enrolling</b>. When enrollment is complete, its state changes to <b>Enrolled</b>.</p>	AWS Control Tower administrator, Member account administrator
Check for guardrail violations.	<p>Guardrails defined in the OU will automatically apply to the enrolled member account. Monitor the AWS Control Tower dashboard for violation</p>	AWS Control Tower administrator, Member account administrator



Task	Description	Skills required
	s and fix them accordingly. For more information, see <a href="#">Guardrails in AWS Control Tower</a> in the AWS documentation.	

## Troubleshooting

Issue	Solution
You receive the error message: <b>An unknown error occurred. Try again later, or contact AWS Support.</b>	This error occurs when you use root user credentials (management account) in AWS Control Tower to enroll a new account. AWS Service Catalog can't map the Account Factory Portfolio or product to the root user, which results in the error message. To remediate this error, use non-root, full-access user (administrator) credentials to enroll the new account. For more information about how to assign administrative access to an administrative user, see <a href="#">Getting started</a> in the AWS IAM Identity Center (successor to AWS Single Sign-On) documentation.
The AWS Control Tower <b>Activities</b> page displays a <b>Get Catastrophic Drift</b> action.	This action reflects a drift check of the service and does not indicate any issues with the AWS Control Tower setup. No action is required.

## Related resources

### Documentation

- [AWS Organizations terminology and concepts](#) (AWS Organizations documentation)
- [What is AWS Control Tower?](#) (AWS Control Tower documentation)

- [Removing a member account from your organization](#) (AWS Organizations documentation)
- [Creating an administrator account in AWS Control Tower](#) (AWS Control Tower documentation)

## Tutorials and videos

- [AWS Control Tower Workshop](#) (self-paced workshop)
- [What is AWS Control Tower?](#) (video)
- [Provisioning Users in AWS Control Tower](#) (video)
- [Enable AWS Control Tower for Existing Organization](#) (video)

# Monitor use of a shared Amazon Machine Image across multiple AWS accounts

Created by Naveen Suthar (AWS) and Sandeep Gawande (AWS)

**Code repository:** [cross-account-ami-auditing-terraform-samples](#)

**Environment:** PoC or pilot

**Technologies:** Management & governance; DevOps; Serverless; Operations

**AWS services:** Amazon DynamoDB; AWS Lambda; Amazon EventBridge

## Summary

[Amazon Machine Images \(AMIs\)](#) are used to create Amazon Elastic Compute Cloud (Amazon EC2) instances in your Amazon Web Services (AWS) environment. You can create AMIs in a separate, centralized AWS account, which is called a *creator account* in this pattern. You can then share the AMI across multiple AWS accounts that are in the same AWS Region, which are called *consumer accounts* in this pattern. Managing AMIs from a single account provides scalability and simplifies governance. In the consumer accounts, you can reference the shared AMI in Amazon EC2 Auto Scaling [launch templates](#) and Amazon Elastic Kubernetes Service (Amazon EKS) [node groups](#).

When a shared AMI is [deprecated](#), [deregistered](#), or [unshared](#), AWS services that refer to the AMI in the consumer accounts cannot use this AMI to launch new instances. Any auto scaling event or relaunch of the same instance fails. This can lead to issues in the production environment, such as application downtime or performance degradation. When AMI sharing and usage events occur in multiple AWS accounts, it can be difficult to monitor this activity.

This pattern helps you monitor shared AMI usage and status across accounts in the same Region. It uses serverless AWS services, such as Amazon EventBridge, Amazon DynamoDB, AWS Lambda, and Amazon Simple Email Service (Amazon SES). You provision the infrastructure as code (IaC) by using HashiCorp Terraform. This solution provides alerts when a service in a consumer account references a deregistered or unshared AMI.

## Prerequisites and limitations

### Prerequisites

- Two or more active AWS accounts: one creator account and one or more consumer accounts
- One or more AMIs that are shared from the creator account to a consumer account
- Terraform CLI, [installed](#) (Terraform documentation)
- Terraform AWS Provider, [configured](#) (Terraform documentation)
- (Optional, but recommended) Terraform backend, [configured](#) (Terraform documentation)
- Git, [installed](#)

### Limitations

- This pattern monitors AMIs that have been shared to specific accounts by using the account ID. This pattern does not monitor AMIs that have been shared to an organization by using the organization ID.
- AMIs can only be shared to accounts that are within the same AWS Region. This pattern monitors AMIs within a single, target Region. To monitor use of AMIs in multiple Regions, you deploy this solution in each Region.
- This pattern doesn't monitor any AMIs that were shared before this solution was deployed. If you want to monitor previously shared AMIs, you can unshare the AMI and then reshare it with the consumer accounts.

### Product versions

- Terraform version 1.2.0 or later
- Terraform AWS Provider version 4.20 or later

## Architecture

### Target technology stack

The following resources are provisioned as IaC through Terraform:

- Amazon DynamoDB tables

- Amazon EventBridge rules
- AWS Identity and Access Management (IAM) role
- AWS Lambda functions
- Amazon SES

## Target architecture

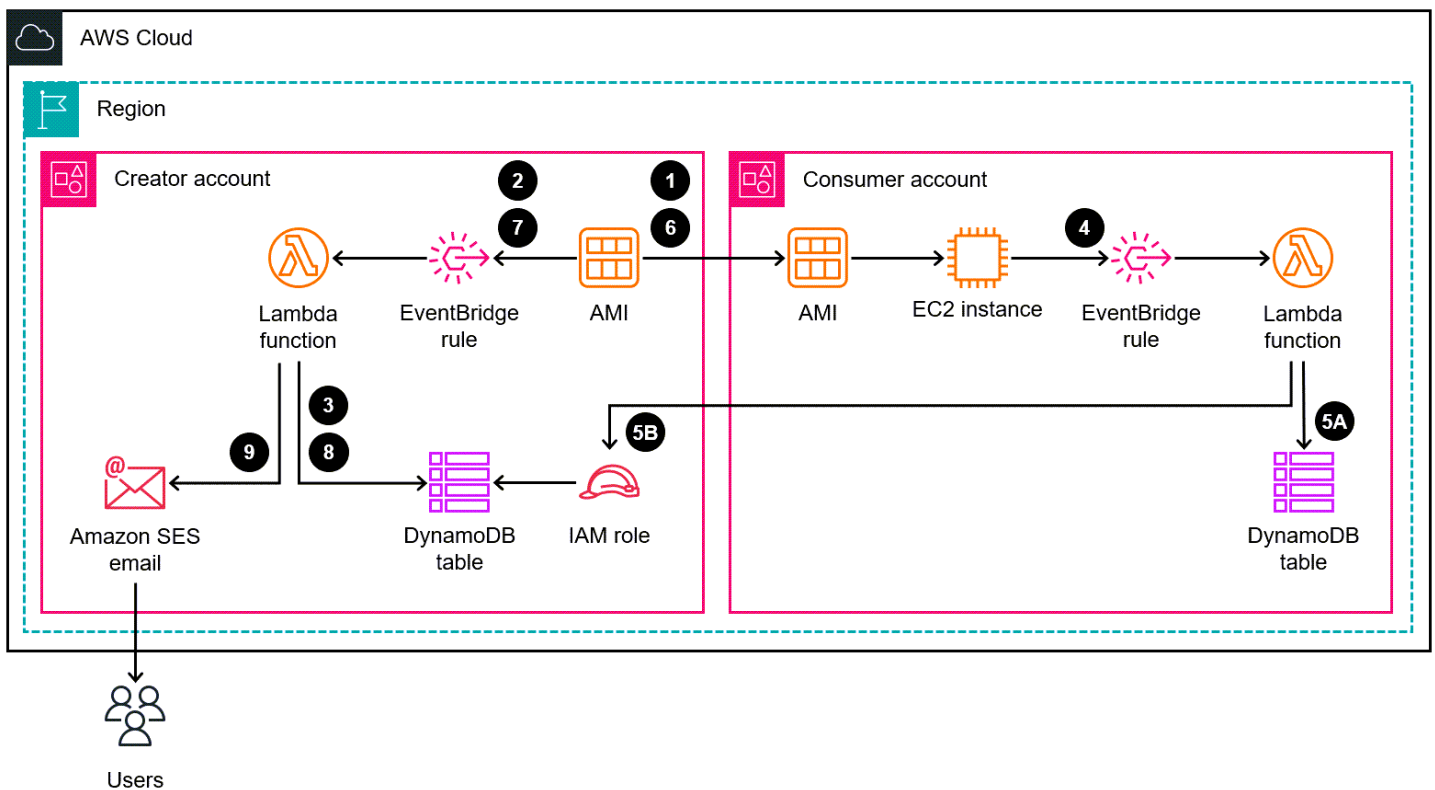

The diagram shows the following workflow:

1. An AMI in the creator account is shared with a consumer account in the same AWS Region.
2. When the AMI is shared, an Amazon EventBridge rule in the creator account captures the `ModifyImageAttribute` event and initiates a Lambda function in the creator account.
3. The Lambda function stores data related to the AMI in a DynamoDB table in the creator account.
4. When an AWS service in the consumer account uses the shared AMI to launch an Amazon EC2 instance or when the shared AMI is associated with a launch template, an EventBridge rule in the consumer account captures use of the shared AMI.
5. The EventBridge rule initiates a Lambda function in the consumer account. The Lambda function does the following:
  - 5A Interacts with a DynamoDB table in the creator account.
  - 5B Interacts with the IAM role in the creator account.
9. The Lambda function in the creator account sends an email via Amazon SES to Users.

- a. The Lambda function updates the AMI-related data in a DynamoDB table in the consumer account.
  - b. The Lambda function assumes an IAM role in the creator account and updates the DynamoDB table in the creator account. In the Mapping table, it creates an item that maps the instance ID or launch template ID to its respective AMI ID.
6. The AMI that is centrally managed in the creator account is deprecated, deregistered, or unshared.
  7. The EventBridge rule in the creator account captures the `ModifyImageAttribute` or `DeregisterImage` event with the `remove` action and initiates the Lambda function.
  8. The Lambda function checks the DynamoDB table to determine whether the AMI is used in any of the consumer accounts. If there are no instance IDs or launch template IDs associated with the AMI in the Mapping table, then the process is complete.
  9. If any instance IDs or launch template IDs are associated with the AMI in the Mapping table, then the Lambda function uses Amazon SES to send an email notification to the configured subscribers.

## Tools

### AWS services

- [Amazon DynamoDB](#) is a fully managed NoSQL database service that provides fast, predictable, and scalable performance.
- [Amazon EventBridge](#) is a serverless event bus service that helps you connect your applications with real-time data from a variety of sources. For example, AWS Lambda functions, HTTP invocation endpoints using API destinations, or event buses in other AWS accounts.
- [AWS Identity and Access Management \(IAM\)](#) helps you securely manage access to your AWS resources by controlling who is authenticated and authorized to use them.
- [AWS Lambda](#) is a compute service that helps you run code without needing to provision or manage servers. It runs your code only when needed and scales automatically, so you pay only for the compute time that you use.
- [Amazon Simple Email Service \(Amazon SES\)](#) helps you send and receive emails by using your own email addresses and domains.

### Other tools

- [HashiCorp Terraform](#) is an open-source infrastructure as code (IaC) tool that helps you use code to provision and manage cloud infrastructure and resources.
- [Python](#) is a general-purpose computer programming language.

## Code repository

The code for this pattern is available in the GitHub [cross-account-ami-monitoring-terraform-samples](#) repository.

## Best practices

- Follow the [Best practices for working with AWS Lambda functions](#).
- Follow the [Best practices for building AMIs](#).
- When creating the IAM role, follow the principle of least privilege and grant the minimum permissions required to perform a task. For more information, see [Grant least privilege](#) and [Security best practices](#) in the IAM documentation.
- Set up monitoring and alerting for the AWS Lambda functions. For more information, see [Monitoring and troubleshooting Lambda functions](#).

## Epics

### Customize the Terraform configuration files

Task	Description	Skills required
Create the AWS CLI named profiles.	For the creator account and each consumer account, create an AWS Command Line Interface (AWS CLI) named profile. For instructions, see <a href="#">Set Up the AWS CLI</a> in the AWS Getting Started Resources Center.	DevOps engineer
Clone the repository.	Enter the following command. This clones	DevOps engineer

Task	Description	Skills required
	<p>the <a href="#">cross-account-ami-monitoring-terraform-sample</a> repository from GitHub by using SSH.</p> <pre data-bbox="597 426 1026 665">git clone git@github.com:aws-samples/cross-account-ami-monitoring-terraform-samples.git</pre>	



Task	Description	Skills required
Update the provider.tf file.	<ol style="list-style-type: none"><li data-bbox="592 226 1027 405">1. Enter the following command to navigate into the terraform folder in the cloned repository. <pre data-bbox="630 443 1027 604">cd cross-account-ami-monitoring/terrafo rm</pre></li><li data-bbox="592 621 1027 695">2. Open the provider.tf file.</li><li data-bbox="592 722 1027 1499">3. Update the Terraform AWS Provider configurations for the creator account and consumer account as follows:<ul style="list-style-type: none"><li data-bbox="630 974 1027 1100">• For <code>alias</code>, enter a name for the provider configuration.</li><li data-bbox="630 1127 1027 1299">• For <code>region</code>, enter the target AWS Region where you want to deploy this solution.</li><li data-bbox="630 1327 1027 1499">• For <code>profile</code>, enter the AWS CLI named profile for accessing the account.</li></ul></li><li data-bbox="592 1526 1027 1749">4. If you are configuring more than one consumer account, create a profile for each additional consumer account.</li><li data-bbox="592 1776 1027 1850">5. Save and close the provider.tf file.</li></ol>	DevOps engineer

Task	Description	Skills required
	<p>For more information about configuring the providers, see <a href="#">Multiple provider configurations</a> in the Terraform documentation.</p>	
Update the terraform.tfvars file.	<ol style="list-style-type: none"><li>1. Open the terraform.tfvars file.</li><li>2. In the account_email_mapping parameter, configure alerts for the creator account and consumer account as follows:<ul style="list-style-type: none"><li>• For account, enter the account ID.</li><li>• For email, enter the email address where you want to send alerts. You can enter only one email address for each account.</li></ul></li><li>3. If you are configuring more than one consumer account, enter an account and email address for each additional consumer account.</li><li>4. Save and close the terraform.tfvars file.</li></ol>	DevOps engineer

Task	Description	Skills required
Update the main.tf file.	<p>Complete these steps only if you are deploying this solution to more than one consumer account. If you are deploying this solution to only one consumer account, no modification of this file is necessary.</p> <ol style="list-style-type: none"><li>1. Open the <code>main.tf</code> file.</li><li>2. For each additional consumer account, create a new module that is based off the <code>consumer_account_A</code> module in the template. For each consumer account, for <code>provider</code>, the value should match the alias you entered in the <code>provider.tf</code> file.</li><li>3. Save and close the <code>main.tf</code> file.</li></ol>	DevOps engineer

## Deploy the solution by using Terraform

Task	Description	Skills required
Deploy the solution.	In the Terraform CLI, enter the following commands to deploy the AWS resources in the creator and consumer accounts:	DevOps engineer

Task	Description	Skills required
	<ol style="list-style-type: none"><li data-bbox="592 212 943 338">1. Enter the following command to initialize Terraform. <pre data-bbox="634 380 1029 457">terraform init</pre></li><li data-bbox="592 474 1000 600">2. Enter the following command to validate the Terraform configurations. <pre data-bbox="634 642 1029 720">terraform validate</pre></li><li data-bbox="592 737 1000 863">3. Enter the following command to create a Terraform execution plan. <pre data-bbox="634 905 1029 982">terraform plan</pre></li><li data-bbox="592 999 1000 1220">4. Review the configuration changes in the Terraform plan and confirm that you want to implement these changes.</li><li data-bbox="592 1245 976 1371">5. Enter the following command to deploy the resources. <pre data-bbox="634 1413 1029 1491">terraform apply</pre></li></ol>	

Task	Description	Skills required
Verify the email address identity.	When you deployed the Terraform plan, Terraform created an email address identity for each consumer account in Amazon SES. Before notifications can be sent to that email address, you must verify the email address. For instructions, see <a href="#">Verifying an email address identity</a> in the Amazon SES documentation.	General AWS

## Validate resource deployment

Task	Description	Skills required
Validate deployment in the creator account.	<ol style="list-style-type: none"><li>1. Sign in to the creator account.</li><li>2. In the navigation bar, confirm that you are viewing the target Region. If you're in a different Region, choose the name of the currently displayed Region, and then choose the target Region.</li><li>3. Open the DynamoDB console at <a href="https://console.aws.amazon.com/dynamodb/">https://console.aws.amazon.com/dynamodb/</a>.</li><li>4. In the navigation pane, choose <b>Tables</b>.</li></ol>	DevOps engineer

Task	Description	Skills required
	<p>5. In the list of tables, validate that the AmiShare table is present.</p> <p>6. Open the Lambda console at <a href="https://console.aws.amazon.com/lambda">https://console.aws.amazon.com/lambda</a>.</p> <p>7. In the navigation pane, choose <b>Functions</b>.</p> <p>8. In the list of functions, validate that the ami-share function is present.</p> <p>9. Open the IAM console at <a href="https://console.aws.amazon.com/iamv2/">https://console.aws.amazon.com/iamv2/</a>.</p> <p>10. In the navigation pane, choose <b>Roles</b>.</p> <p>11. In the list of roles, validate that the external-ddb-role role is present.</p> <p>12. Open the EventBridge console at <a href="https://console.aws.amazon.com/events/">https://console.aws.amazon.com/events/</a>.</p> <p>13. In the navigation pane, choose <b>Rules</b>.</p> <p>14. In the list of rules, validate that the modify_image_attribute_event rule is present.</p> <p>15. Open the Amazon SES console at <a href="https://console.aws.amazon.com/SES/">https://console.aws.amazon.com/SES/</a>.</p>	

Task	Description	Skills required
	<p><a href="https://console.aws.amazon.com/iam/home?#/verified-identities">console.aws.amazon.com/iam/home?#/verified-identities/</a>.</p> <p>16 In the navigation pane, choose <b>Verified Identities</b>.</p> <p>17 In the list of identities, validate that an email address identity has been registered and verified for each consumer account.</p>	

Task	Description	Skills required
Validate deployment in the consumer account.	<ol style="list-style-type: none"><li>1. Sign in to the consumer account.</li><li>2. In the navigation bar, confirm that are viewing the target Region. If you're in a different Region, choose the name of the currently displayed Region, and then choose the target Region.</li><li>3. Open the DynamoDB console at <a href="https://console.aws.amazon.com/dynamodb/">https://console.aws.amazon.com/dynamodb/</a>.</li><li>4. In the navigation pane, choose <b>Tables</b>.</li><li>5. In the list of tables, validate that the Mapping table is present.</li><li>6. Open the Lambda console at <a href="https://console.aws.amazon.com/lambda">https://console.aws.amazon.com/lambda</a>.</li><li>7. In the navigation pane, choose <b>Functions</b>.</li><li>8. In the list of functions , validate that the ami-usage-function and ami-deregister-function functions are present.</li><li>9. Open the EventBridge console at <a href="https://">https://</a></li></ol>	DevOps engineer



Task	Description	Skills required
	<p><a href="https://console.aws.amazon.com/events/">console.aws.amazon.com/events/</a>.</p> <p>10 In the navigation pane, choose <b>Rules</b>.</p> <p>11 In the list of rules, validate that the <code>ami_usage_events</code> and <code>ami_deregister_events</code> rules are present.</p>	

## Validate monitoring

Task	Description	Skills required
Create an AMI in the creator account.	<ol style="list-style-type: none"> <li>1. In the creator account, create a private AMI. For instructions, see <a href="#">Create an AMI from an Amazon EC2 Instance</a>.</li> <li>2. Share the new AMI with one of the consumer accounts. For instructions, see <a href="#">Share an AMI with specific AWS accounts</a>.</li> </ol>	DevOps engineer
Use the AMI in the consumer account.	In the consumer account, use the shared AMI to create an EC2 instance or launch template. For instructions, see <a href="#">How do I launch an EC2 instance from a custom AMI</a> (AWS re:Post Knowledge Center) or How to create	DevOps engineer

Task	Description	Skills required
	launch template (Amazon EC2 Auto Scaling documentation).	
Validate monitoring and alerting.	<ol style="list-style-type: none"> <li>1. Sign in to the creator account.</li> <li>2. Open the Amazon EC2 console at <a href="https://console.aws.amazon.com/ec2/">https://console.aws.amazon.com/ec2/</a>.</li> <li>3. In the navigation pane, choose <b>AMIs</b>.</li> <li>4. Select the AMI in the list, and then choose <b>Actions</b>, <b>Edit AMI permissions</b>.</li> <li>5. In the <b>Shared accounts</b> section, select the consumer account, and then choose <b>Remove selected</b>.</li> <li>6. Choose <b>Save changes</b>.</li> <li>7. Validate that the target email address you defined for the consumer account receives a notification that the sharing was canceled for the AMI.</li> </ol>	DevOps engineer

### (Optional) Stop monitoring shared AMIs

Task	Description	Skills required
Delete the resources.	<ol style="list-style-type: none"> <li>1. Enter the following command to remove the</li> </ol>	DevOps engineer

Task	Description	Skills required
	<p>resources deployed by this pattern and stop monitoring shared AMIs.</p> <div style="border: 1px solid #ccc; border-radius: 10px; padding: 5px; width: fit-content; margin: 10px auto;"> <code>terraform destroy</code> </div> <p>2. Confirm the destroy command by entering yes.</p>	

## Troubleshooting

Issue	Solution
I did not receive an email alert.	<p>There could be multiple reasons why the Amazon SES email was not sent. Check the following:</p> <ol style="list-style-type: none"> <li>1. In the <a href="#">Epics</a> section, use the <i>Validate resource deployment</i> epic to confirm that the infrastructure was provisioned properly in all AWS accounts.</li> <li>2. Validate the Lambda function events in Amazon CloudWatch Logs. For instructions, see <a href="#">Using the CloudWatch console</a> in the Lambda documentation. Confirm that there are no permissions issues, such as an explicit deny in any identity-based or resource-based policies. For more information, see <a href="#">Policy evaluation logic</a> in the IAM documentation.</li> <li>3. In Amazon SES, validate that the status of the email address identity is <b>Verified</b>. For more information, see <a href="#">Verifying an email address identity</a>.</li> </ol>

## Related resources

### AWS documentation

- [Building Lambda functions with Python](#) (Lambda documentation)
- [Create an AMI](#) (Amazon EC2 documentation)
- [Share an AMI with specific AWS accounts](#) (Amazon EC2 documentation)
- [Deregister your AMI](#) (Amazon EC2 documentation)

### Terraform documentation

- [Install Terraform](#)
- [Terraform Backend Configuration](#)
- [Terraform AWS Provider](#)
- [Terraform binary download](#)

# Set up alerts for programmatic account closures in AWS Organizations

Created by Richard Milner-Watts (AWS), Debojit Bhadra (AWS), and Manav Yadav (AWS)

**Code repository:** [AWS Account Closure Notifier](#)

**Environment:** Production

**Technologies:** Management & governance

**AWS services:** AWS CloudTrail; Amazon EventBridge; AWS Lambda; AWS Organizations; Amazon SNS

## Summary

The [CloseAccount API](#) for [AWS Organizations](#) enables you to close member accounts within an organization programmatically, without having to log in to the account with root credentials. The [RemoveAccountFromOrganization API](#) pulls an account out from an organization in AWS Organizations, so it becomes a standalone account.

These APIs potentially increase the number of operators who can close or remove an AWS account. All users who have access to the organization through AWS Identity and Access Management (IAM) in the AWS Organizations management account can call these APIs, so access isn't limited to the owner of the account's root email with any associated multi-factor authentication (MFA) device.

This pattern implements alerts when the `CloseAccount` and `RemoveAccountFromOrganization` APIs are called, so you can monitor these activities. For alerts, it uses an [Amazon Simple Notification Service](#) (Amazon SNS) topic. You can also set up Slack notifications through a [webhook](#).

## Prerequisites and limitations

### Prerequisites

- An active AWS account
- An organization in AWS Organizations

- Access to the organization management account, under the organization's root, to create the required resources

## Limitations

- As described in the [AWS Organizations API reference](#), the `CloseAccount` API allows only 10 percent of active member accounts to be closed within a rolling 30-day period.
- When an AWS account is closed, its status is changed to `SUSPENDED`. For 90 days after this status transition, AWS Support can reopen the account. After 90 days the account is permanently deleted.
- Users who have access to the AWS Organizations management account and APIs might also have permissions to disable these alerts. If the primary concern is malicious behavior instead of accidental deletion, consider protecting the resources created by this pattern with an [IAM permissions boundary](#).
- The API calls for `CloseAccount` and `RemoveAccountFromOrganization` are processed in the US East (N. Virginia) Region (`us-east-1`). Therefore, you must deploy this solution in `us-east-1` in order to observe the events.

## Architecture

### Target technology stack

- AWS Organizations
- AWS CloudTrail
- Amazon EventBridge
- AWS Lambda
- Amazon SNS

### Target architecture

The following diagram shows the solution architecture for this pattern.

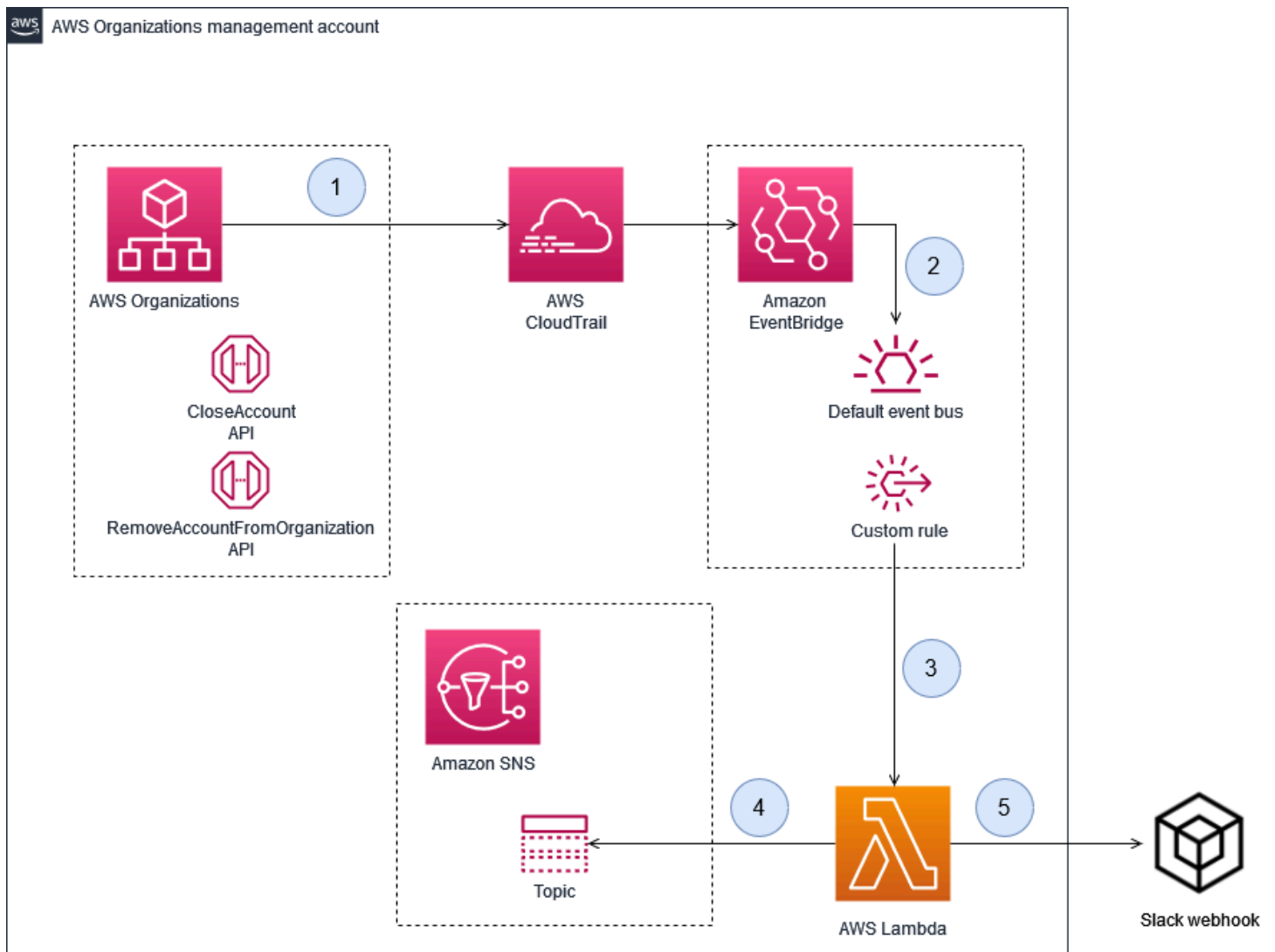

1. AWS Organizations processes a `CloseAccount` or `RemoveAccountFromOrganization` request.
2. Amazon EventBridge is integrated with AWS CloudTrail to deliver these events to the default event bus.
3. A custom Amazon EventBridge rule matches the AWS Organizations requests and calls an AWS Lambda function.
4. The Lambda function delivers a message to an SNS topic, which users can subscribe to for email alerts or further processing.
5. If Slack notifications are enabled, the Lambda function delivers a message to a Slack webhook.

# Tools

## AWS services

- [AWS CloudFormation](#) provides a way to model a collection of related AWS and third-party resources, provision them quickly and consistently, and manage them throughout their lifecycles, by treating infrastructure as code.
- [Amazon EventBridge](#) is a serverless event bus service that you can use to connect your applications with data from a variety of sources. EventBridge receives an event, an indicator of a change in environment, and applies a rule to route the event to a target. Rules match events to targets based on either the structure of the event, called an *event pattern*, or on a schedule.
- [AWS Lambda](#) is a compute service that supports running code without provisioning or managing servers. Lambda runs your code only when needed and scales automatically, from a few requests each day to thousands each second. You pay only for the compute time that you consume. There is no charge when your code is not running.
- [AWS Organizations](#) helps you centrally manage and govern your environment as you grow and scale your AWS resources. Using AWS Organizations, you can programmatically create new AWS accounts and allocate resources, group accounts to organize your workflows, apply policies to accounts or groups for governance, and simplify billing by using a single payment method for all your accounts.
- [AWS CloudTrail](#) monitors and records account activity across your AWS infrastructure, and gives you control over storage, analysis, and remediation actions.
- [Amazon Simple Notification Service \(Amazon SNS\)](#) is a fully managed messaging service for both application-to-application (A2A) and application-to-person (A2P) communication.

## Other tools

- [AWS Lambda Powertools for Python library](#) is a set of utilities that provide tracing, logging, metrics, and event handling features for Lambda functions.

## Code

The code for this pattern is located in the GitHub [AWS Account Closer Notifier](#) repository.

The solution includes a CloudFormation template that deploys the architecture for this pattern. It uses the [AWS Lambda Powertools for Python library](#) to provide logging and tracing.



# Epics

## Deploy the architecture

Task	Description	Skills required
Launch the CloudFormation template for the solution stack.	<p>The CloudFormation template for this pattern is in the main branch of the <a href="#">GitHub repository</a>. It deploys the IAM roles, EventBridge rules, Lambda functions, and the SNS topic.</p> <p>To launch the template:</p> <ol style="list-style-type: none"><li>1. Clone the <a href="#">GitHub repository</a> to obtain a copy of the solution code.</li><li>2. Open the AWS Management Console for the AWS Organizations management account.</li><li>3. Choose the US East (N. Virginia) Region (us-east-1), and then open the <a href="#">CloudFormation console</a>.</li><li>4. Create the stack by using the <code>account-closure-notifier.yml</code> template and specifying the following values:<ul style="list-style-type: none"><li>• Stack name: <code>aws-account-closure-notifier-stack</code></li></ul></li></ol>	AWS administrator

Task	Description	Skills required
	<ul style="list-style-type: none"><li>• ResourcePrefix parameter: aws-account-closure-notifier</li><li>• SlackNotification parameter: If Slack notifications are required, change this setting to true.</li><li>• SlackWebhookEndpoint parameter: If Slack notifications are required, specify the webhook URL.</li></ul> <p>For more information about launching a CloudFormation stack, see the <a href="#">AWS documentation</a>.</p>	
Verify that the solution has launched successfully.	<ol style="list-style-type: none"><li>1. Wait for the CloudFormation stack to reach a status of CREATE_COMPLETE.</li><li>2. Open the <a href="#">EventBridge console</a> in us-east-1 .</li><li>3. Verify that a new rule has been created with the name aws-account-closure-notifier-event-rule .</li></ol>	AWS administrator

Task	Description	Skills required
Subscribe to the SNS topic.	<p>(Optional) If you want to subscribe to the SNS topic:</p> <ol style="list-style-type: none"><li>1. Open the <a href="#">Amazon SNS console</a> in us-east-1 , and find the topic named aws-account-closure-notifier-sns-topic .</li><li>2. Choose the topic name, and then choose <b>Create subscription</b>.</li><li>3. For <b>Protocol</b>, choose <b>Email</b>.</li><li>4. For <b>Endpoint</b>, specify the email address that should receive the notification, and then choose <b>Create subscription</b>.</li><li>5. Check your email inbox for a message from AWS Notifications. Use the link in this email to confirm the subscription.</li></ol> <p>For more information about setting up SNS notifications, see the <a href="#">Amazon SNS documentation</a>.</p>	AWS administrator

## Verify the solution

Task	Description	Skills required
Send a test event to the default event bus.	<p>The <a href="#">GitHub repository</a> provides a sample event that you can send to the EventBridge default event bus for testing. The EventBridge rule also reacts to events that use the custom event source <code>account.closure.notifier</code>.</p> <p><b>Note:</b> You can't use the CloudTrail event source to send this event, because it's not possible to send an event as an AWS service.</p> <p>To send a test event:</p> <ol style="list-style-type: none"><li>1. Open the <a href="#">EventBridge console</a> in <code>us-east-1</code>.</li><li>2. In the navigation pane, under <b>Buses</b>, choose <b>Event buses</b>, and then select the default event bus.</li><li>3. Choose <b>Send events</b>.</li><li>4. For <b>Event source</b>, enter <code>account.closure.notifier</code>.</li><li>5. For <b>Detail type</b>, enter <code>AWS API Call via CloudTrail</code>.</li><li>6. For <b>Event detail</b>, copy and paste the contents of</li></ol>	AWS administrator

Task	Description	Skills required
	<p>tests/dummy-event.json from the GitHub repository into the text box.</p> <p>7. Choose <b>Send</b> to initiate the notification workflow.</p>	
Verify that the email notification was received.	Check the mailbox that subscribed to the SNS topic for notifications. You should receive an email with details of the account that was closed and the principal that performed the API call.	AWS administrator
Verify that the Slack notification was received.	(Optional) If you specified a webhook URL for the <code>SlackWebhookEndpoint</code> parameter when you deployed the CloudFormation template, check the Slack channel that is mapped to the webhook. It should display a message with details of the account that was closed and the principal that performed the API call.	AWS administrator

## Related resources

- [CloseAccount action](#) (AWS Organizations API reference)
- [RemoveAccountFromOrganization action](#) (AWS Organizations API reference)
- [AWS Lambda Powertools for Python](#)

## More patterns

- [Automate AWS resource assessment](#)
- [Automate AWS Service Catalog portfolio and product deployment by using AWS CDK](#)
- [Automate security scans for cross-account workloads using Amazon Inspector and AWS Security Hub](#)
- [Automatically attach an AWS managed policy for Systems Manager to EC2 instance profiles using Cloud Custodian and AWS CDK](#)
- [Automatically encrypt existing and new Amazon EBS volumes](#)
- [Centralize monitoring by using Amazon CloudWatch Observability Access Manager](#)
- [Centralized logging and multiple-account security guardrails](#)
- [Check EC2 instances for mandatory tags at launch](#)
- [Create a RACI or RASCI matrix for a cloud operating model](#)
- [Create an Amazon ECS task definition and mount a file system on EC2 instances using Amazon EFS](#)
- [Create AWS Config custom rules by using AWS CloudFormation Guard policies](#)
- [Create tag-based Amazon CloudWatch dashboards automatically](#)
- [Delete unused Amazon Elastic Block Store \(Amazon EBS\) volumes by using AWS Config and AWS Systems Manager](#)
- [Deploy and manage AWS Control Tower controls by using AWS CDK and AWS CloudFormation](#)
- [Deploy and manage AWS Control Tower controls by using Terraform](#)
- [Deploy code in multiple AWS Regions using AWS CodePipeline, AWS CodeCommit, and AWS CodeBuild](#)
- [Export a report of AWS IAM Identity Center identities and their assignments by using PowerShell](#)
- [Generate an AWS CloudFormation template containing AWS Config managed rules using Troposphere](#)
- [Give SageMaker notebook instances temporary access to a CodeCommit repository in another AWS account](#)
- [Launch a CodeBuild project across AWS accounts using Step Functions and a Lambda proxy function](#)
- [Migrate Windows SSL certificates to an Application Load Balancer using ACM](#)
- [Monitor IAM root user activity](#)

- [Perform custom actions from AWS CodeCommit events](#)
- [Preserve routable IP space in multi-account VPC designs for non-workload subnets](#)
- [Register multiple AWS accounts with a single email address by using Amazon SES](#)
- [Remove Amazon EC2 entries in the same AWS account from AWS Managed Microsoft AD by using AWS Lambda automation](#)
- [Rotate database credentials without restarting containers](#)
- [Send notifications for an Amazon RDS for SQL Server database instance by using an on-premises SMTP server and Database Mail](#)
- [Set up a Grafana monitoring dashboard for AWS ParallelCluster](#)
- [Tag Transit Gateway attachments automatically using AWS Organizations](#)
- [Use BMC Discovery queries to extract migration data for migration planning](#)
- [Visualize IAM credential reports for all AWS accounts using Amazon QuickSight](#)

# Messaging & communications

## Topics

- [Automate RabbitMQ configuration in Amazon MQ](#)
- [Improve call quality on agent workstations in Amazon Connect contact centers](#)
- [More patterns](#)



# Automate RabbitMQ configuration in Amazon MQ

Created by Yogesh Bhatia (AWS) and Afroz Khan (AWS)

**Environment:** PoC or pilot

**Technologies:** Messaging & communications; DevOps; Infrastructure

**AWS services:** Amazon MQ; AWS CloudFormation

## Summary

[Amazon MQ](#) is a managed message broker service that provides compatibility with many popular message brokers. Using Amazon MQ with RabbitMQ provides a robust RabbitMQ cluster managed in the Amazon Web Services (AWS) Cloud with multiple brokers and configuration options. Amazon MQ provides a highly available, secure, and scalable infrastructure, and can process a large number of messages per second with ease. Multiple applications can use the infrastructure with different virtual hosts, queues, and exchanges. However, managing these configuration options or creating the infrastructure manually can require time and effort. This pattern describes a way to manage configurations for RabbitMQ in one step, through a single file. You can embed the code provided with this pattern within any continuous integration (CI) tool such as Jenkins or Bamboo.

You can use this pattern to configure any RabbitMQ cluster. All it requires is connectivity to the cluster. Although there are many other ways to manage RabbitMQ configurations, this solution creates entire application configurations in one step, so you can manage queues and other details easily.

## Prerequisites and limitations

### Prerequisites

- AWS Command Line Interface (AWS CLI) installed and configured to point to your AWS account (for instructions, see [AWS CLI documentation](#))
- Ansible installed, so you can run playbooks to create the configuration
- `rabbitmqadmin` installed (for instructions, see the [RabbitMQ documentation](#))
- A RabbitMQ cluster in Amazon MQ, created with healthy Amazon CloudWatch metrics

### Additional requirements

- Make sure to create the configurations for virtual hosts and users separately and not as part of JSON.
- Make sure that the configuration JSON is part of the repository and is version-controlled.
- The version of the **rabbitmqadmin** CLI must be the same as the version of the RabbitMQ server, so the best option is to download the CLI from the RabbitMQ console.
- As part of the pipeline, make sure that JSON syntax is validated before each run.

### Product versions

- AWS CLI version 2.0
- Ansible version 2.9.13
- **rabbitmqadmin** version 3.9.13 (must be the same as the RabbitMQ server version)

## Architecture

### Source technology stack

- An RabbitMQ cluster running on an existing on-premises virtual machine (VM) or a Kubernetes cluster (on premises or in the cloud)

### Target technology stack

- Automated RabbitMQ configurations on Amazon MQ for RabbitMQ

### Target architecture

There are many ways to configure RabbitMQ. This pattern uses the import configuration functionality, where a single JSON file contains all the configurations. This file applies all settings and can be managed by a version-control system such as Bitbucket or Git. This pattern uses Ansible to implement the configuration through the **rabbitmqadmin** CLI.

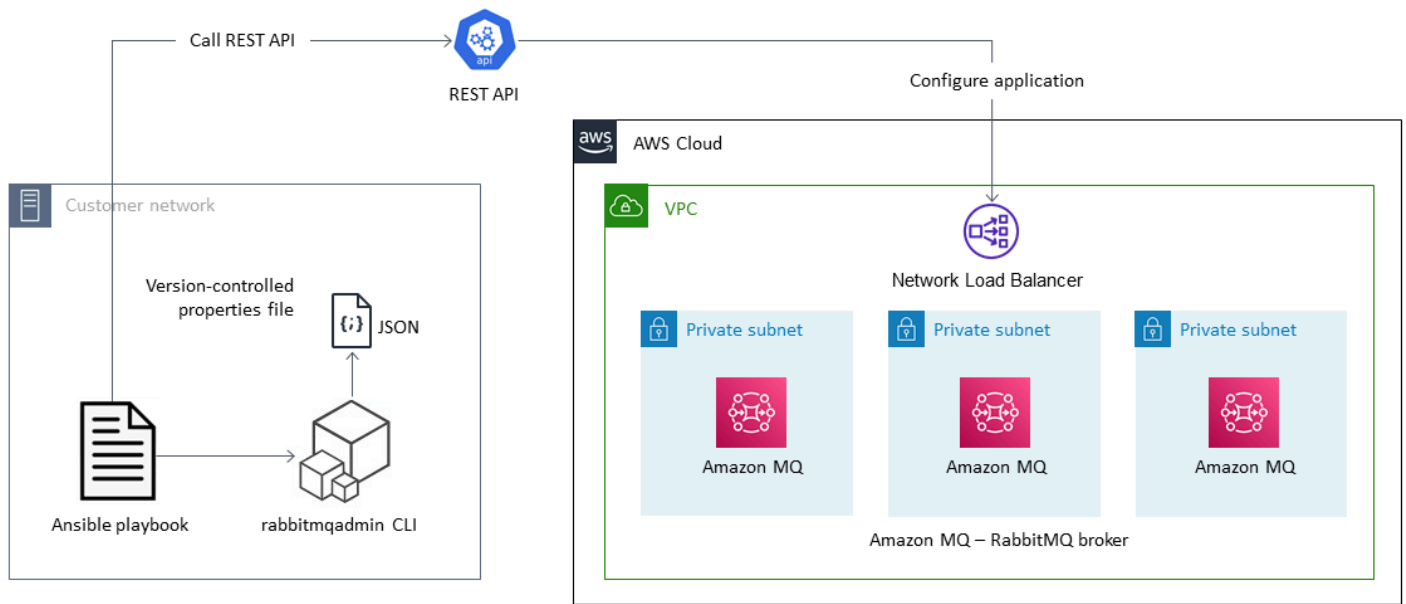

## Tools

### Tools

- [rabbitmqadmin](#) is a command-line tool for the RabbitMQ HTTP-based API. It is used to manage and monitor RabbitMQ nodes and clusters.
- [Ansible](#) is an open-source tool for automating applications and IT infrastructure.
- [AWS CLI](#) enables you to interact with AWS services by using commands in a command-line shell.

### AWS services

- [Amazon MQ](#) is a managed message broker service that makes it easy to set up and operate message brokers in the cloud.
- [AWS CloudFormation](#) helps you set up your AWS infrastructure and speed up cloud provisioning with infrastructure as code.

### Code

The JSON configuration file used in this pattern and a sample Ansible playbook are provided in the attachment.

# Epics

## Create your AWS infrastructure

Task	Description	Skills required
Create a RabbitMQ cluster on AWS.	If you don't already have a RabbitMQ cluster, you can use <a href="#">AWS CloudFormation</a> to create the stack on AWS. Or, you can use the <a href="#">Cloudformation module in Ansible</a> to create the stack. With the latter approach, you can use Ansible for both tasks: to create the RabbitMQ infrastructure and to manage configurations.	AWS CloudFormation, Ansible

## Create the Amazon MQ for RabbitMQ configuration

Task	Description	Skills required
Create a properties file.	Download the JSON configuration file ( <code>rabbitmqconfig.json</code> ) in the attachment, or export it from the RabbitMQ console. Modify it to configure queues, exchanges, and bindings. This configuration file demonstrates the following:  - Creates two queues: <code>sample-queue1</code> and <code>sample-queue2</code>	JSON

Task	Description	Skills required
	<ul style="list-style-type: none"><li>- Creates two exchanges: <code>sample-exchange1</code> and <code>sample-exchange2</code></li><li>- Implements the binding between the queues and exchanges</li></ul> <p>These configurations are performed under the root (/) virtual host, as required by <b>rabbitmqadmin</b>.</p>	

Task	Description	Skills required
Retrieve the details of the Amazon MQ for RabbitMQ infrastructure.	<p>Retrieve the following details for the RabbitMQ infrastructure on AWS:</p> <ul style="list-style-type: none"><li>• Broker name</li><li>• RabbitMQ host</li><li>• RabbitMQ user name (the administrator user created during cluster creation)</li><li>• RabbitMQ password</li></ul> <p>You can use the AWS Management Console or the AWS CLI to retrieve this information. These details enable the Ansible playbook to connect to your AWS account and use the RabbitMQ cluster to run commands.</p> <p><b>Important:</b> The computer that runs the Ansible playbook must be able to access your AWS account, and AWS CLI must already be configured, as described in the <i>Prerequisites</i> section.</p>	AWS CLI, Amazon MQ

Task	Description	Skills required
Create the <code>hosts_var</code> file.	<p>Create the <code>hosts_var</code> file for Ansible and make sure that all the variables are defined in the file. Consider using Ansible Vault to store the password. You can configure the <code>hosts_var</code> file as follows (replace the asterisks with your information):</p> <pre data-bbox="594 730 1026 1087">RABBITMQ_HOST:   "*****.mq.us-east-2.amazonaws.com" RABBITMQ_VHOST: "/" RABBITMQ_USERNAME:   "admin" RABBITMQ_PASSWORD:   "*****"</pre>	Ansible

Task	Description	Skills required
Create an Ansible playbook.	<p>For a sample playbook, see <code>ansible-rabbit-config.yaml</code> in the attachment. Download and save this file. The Ansible playbook imports and manages all RabbitMQ configurations, such as queues, exchanges, and bindings, that applications require.</p> <p>Follow best practices for Ansible playbooks, such as securing passwords. Use Ansible Vault for password encryption, and retrieve the RabbitMQ password from the encrypted file.</p>	Ansible

## Deploy the configuration

Task	Description	Skills required
Run the playbook.	<p>Run the Ansible playbook that you created in the previous epic.</p> <pre>ansible-playbook   ansible-rabbit-config.yaml</pre> <p>You can verify the new configurations on the RabbitMQ console.</p>	RabbitMQ, Amazon MQ, Ansible



## Related resources

- [Migrating from RabbitMQ to Amazon MQ](#) (AWS blog post)
- [Management Command Line Tool](#) (RabbitMQ documentation)
- [Create or delete an AWS CloudFormation stack](#) (Ansible documentation)
- [Migrating message driven applications to Amazon MQ for RabbitMQ](#) (AWS blog post)

## Attachments

To access additional content that is associated with this document, unzip the following file:

[attachment.zip](#)

# Improve call quality on agent workstations in Amazon Connect contact centers

*Created by Ernest Ozdoba (AWS)*

**Environment:** Production

**Technologies:** Messaging & communications; End-user computing

**AWS services:** Amazon Connect

## Summary

Call quality issues are some of the most difficult problems to troubleshoot in contact centers. To avoid voice quality issues and complex troubleshooting procedures, you must optimize your agents' work environment and workstation settings. This pattern describes voice quality optimization techniques for agent workstations in Amazon Connect contact centers. It provides recommendations in the following areas:

- Work environment adjustments. Agents' surroundings don't affect how voice is transmitted over the network, but they do have an effect on call quality.
- Agent workstation settings. Hardware and network configurations for contact center workstations have significant effects on call quality.
- Browser settings. Agents use a web browser to access the Amazon Connect Contact Control Panel (CCP) website and communicate with customers, so browser settings can affect call quality.

The following components can also affect call quality, but they fall outside the scope of the workstation and aren't covered in this pattern:

- Traffic flows to the Amazon Web Services (AWS) Cloud over AWS Direct Connect, a full-tunnel VPN, or a split-tunnel VPN
- Network conditions when working in or outside the corporate office
- Public switched telephone network (PSTN) connectivity
- The customer's device and telephony carrier
- Virtual desktop infrastructure (VDI) setup

For more information relating to these areas, see [Common Contact Control Panel \(CCP\) Issues](#) and [Use the Endpoint Test Utility](#) in the Amazon Connect documentation.

## Prerequisites and limitations

### Prerequisites

- Headsets and workstations must comply with the requirements specified in the [Amazon Connect Administrator Guide](#).

### Limitations

- The optimization techniques in this pattern apply to soft phone voice quality. They do not apply when you configure the Amazon Connect CCP in desk phone mode. However, you can use desk phone mode if your soft phone setup doesn't provide acceptable voice quality for the call.

### Product versions

- For supported browsers and versions, see the [Amazon Connect Administrator Guide](#).

## Architecture

This pattern is architecture-agnostic because it targets agent workstation settings. As the following diagram shows, the voice path from the agent to the customer is affected by the agent's headset, browser, operating system, workstation hardware, and network.

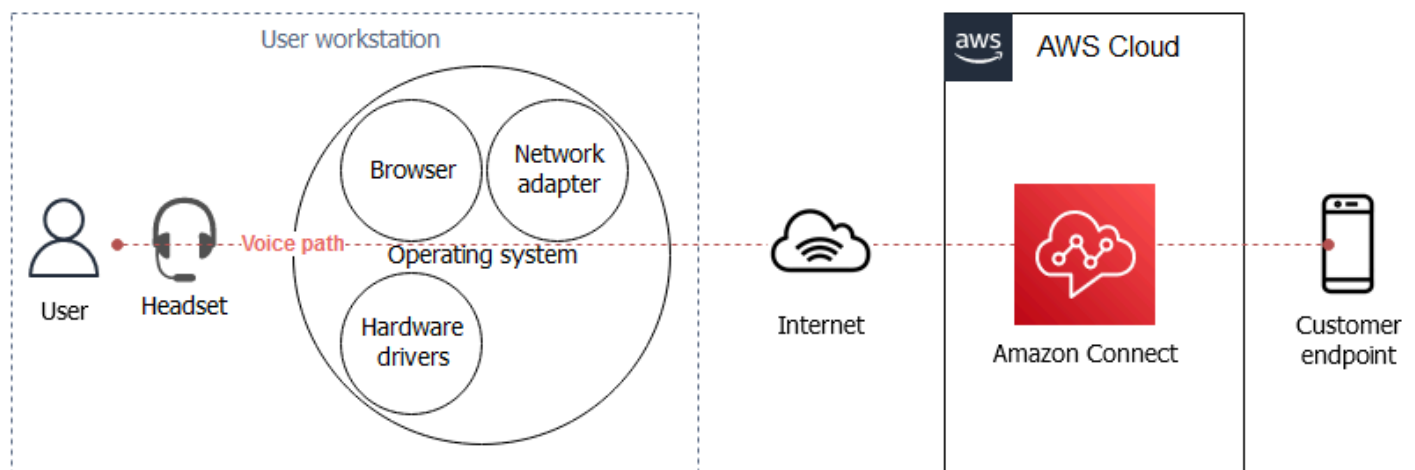

In Amazon Connect contact centers, the user's audio connectivity is established with WebRTC. Voice is encoded with the [Opus interactive audio codec](#) and encrypted with the Secure Real-time Transport Protocol (SRTP) in transit. Other network architectures are possible, including VPN, private WAN/LAN, and ISP networks.

## Tools

- [Amazon Connect Endpoint Test Utility](#) – This utility checks network connectivity and browser settings.
- Browser configuration editors for WebRTC settings:
  - For Firefox: **about:config**
  - For Chrome: **chrome://flags**
- [CCP Log Parser](#) – This tool helps you analyze CCP logs for troubleshooting purposes.

## Epics

### Adjust the work environment

Task	Description	Skills required
Reduce background noise.	<p>Avoid noisy environments. If this is not possible, optimize the environment with these soundproofing tips:</p> <ul style="list-style-type: none"> <li>• Absorb noise by using sound-dissipating surfaces such as curtains, carpets, and soft furnishings.</li> <li>• Block noise by putting barriers between desks.</li> <li>• Consider an active noise cancellation (ANC) solution such as a white noise generator to help concentration and ensure privacy,</li> </ul>	Agent, Manager

Task	Description	Skills required
	<p>or use noise-canceling headsets.</p> <ul style="list-style-type: none"> <li>Prevent echo on your calls. Big, empty spaces might create echo effects or amplify noises. Covering surfaces that can bounce sounds will help reduce echoes.</li> </ul>	

### Optimize agent workstation settings

Task	Description	Skills required
Choose the right headset.	<ul style="list-style-type: none"> <li>If the environment is noisy, choose a stereo headset. Directing sound to both ears helps agents focus and hear the customer better, and reduces the overall noise by making it less likely for agents to raise their voices.</li> <li>Avoid using loud speakers or built-in computer audio. For best quality, use a wired headset that's dedicated to contact center use. Wireless headsets are convenient, but they might be a source of additional audio delay and reduced audio quality</li> </ul>	Agent, Manager

Task	Description	Skills required
	because of radio interference and transcoding.	

Task	Description	Skills required
Use the headset as intended.	<ul style="list-style-type: none"><li>• Enable the active noise canceling and speech enhancement features of your headset if they are available. Look for settings such as ANC or ANR. For instructions on activating these settings, see the user manual for your headset.</li><li>• Adjust your microphone so you can speak directly into it. The best position for your microphone is just below your chin. Correct placement can make a difference of 10 decibels (dB) in the sound level. Most headsets allow you to rotate or bend the microphone arm (boom), so it is important to keep it in the right place when you are talking.</li><li>• Some headsets are equipped with multiple microphones and advanced features such as voice beamforming, which helps capture speech without a boom. To make sure that you're using the main microphone as intended by the manufacturer, see</li></ul>	Agent

Task	Description	Skills required
	the user manual for your device.	
Check workstation resources.	Make sure that your agents' computers are performing. If they use third-party applications that consume resources, their computers might not meet the minimum <a href="#">hardware requirements</a> to run CCP. If agents experience call quality issues, make sure that they have enough processing power (CPU), disk space, network bandwidth, and memory available for CCP. Agents should close any unnecessary applications and tabs to improve CCP performance and call quality.	Administrator



Task	Description	Skills required
Configure the operating system's sound settings.	<p>The default settings for microphone level and boost usually work fine. If you find that outbound voice is quiet or the microphone is picking up too much, it might help to adjust these settings. Microphone settings can be found in your computer's system sound configuration (<b>Sound, Input</b> on <a href="#">MacOS</a>, <b>Microphone Properties</b> in <a href="#">Windows</a>). You can access advanced settings that might affect voice quality through system tools or third-party applications. Here are some of the settings you can check:</p> <ul style="list-style-type: none"><li>• <b>Sample rate</b> – This value determines how many times the sound is probed per second. The default setting is usually 44 or 48 kilohertz (kHz). The optimal value for Amazon Connect is 48 kHz. You can use your browser settings to override the default value. For more information, see the <a href="#">troubleshooting section</a> of the <i>Amazon Connect Administrator Guide</i>.</li><li>• <b>Gain</b> – This value determines how much the microphone</li></ul>	Agent, Administrator

Task	Description	Skills required
	<p>e amplifies the sound. If you turn the gain up, your microphone might pick up more background noise.</p> <ul style="list-style-type: none"><li>• Bit depth – This digital resolution value describes how many levels of sound amplitude are being recognized. The higher the bit depth, the smoother the voice sounds. However, many traditional telephony networks use the pulse-code modulation (PCM) standard, which supports only 8-bit resolution.</li><li>• Open threshold – This is the minimal sound amplitude that a microphone picks up.</li></ul> <p>If you're experiencing voice quality issues, try restoring these values to their default settings before investigating further.</p> <p>For more information about these and other adjustable settings, see your device manual.</p>	

Task	Description	Skills required
Use a wired network.	<p>Typically, wired ethernet has lower latency, so it is easier to provide the consistent transmission quality required for voice data transmission. We recommend 100 KB bandwidth per call at the minimum.</p> <ul style="list-style-type: none"><li>• If agents are working from home, we recommend wired over wireless connections. It shouldn't take more than 150 milliseconds to hear the customer. You can access Amazon Connect's latency test from the <a href="#">Amazon Connect Endpoint Test Utility</a>. However, this utility measures the delay from the browser to Amazon Connect Regions, not to customers. The 150-millisecond one-way delay recommendation prevents the agent and customer from talking over each other. The value is measured from end to end, and each element adds a delay, including the part of the call between the Amazon Connect Region and the customer.</li></ul>	Network administrator, Agent

Task	Description	Skills required
	<ul style="list-style-type: none"><li>If agents are working from the office, corporate Wi-Fi is acceptable as long as parameters are in the recommended range, and Real-time Transport Protocol (RTP) traffic is prioritized.</li></ul>	
Update hardware drivers.	<p>When you use a USB or other type of headset that has its own firmware, we recommend that you keep it updated with the latest version. Simple headsets that use an auxiliary port use the computer's built-in audio device, so make sure that the operating system hardware driver is up to date. In rare cases, an audio driver update can cause audio issues, and you might need to roll it back. For more information about changing firmware and driver versions, see your device manual.</p>	Administrator

Task	Description	Skills required
Avoid USB hubs and dongles.	<p>When you connect your headset, avoid additional devices such as dongles, port type converters, hubs, and extension cables.</p> <p>These devices might affect call quality. Connect your device directly to the port in your computer instead.</p>	Agent

Task	Description	Skills required
Check CCP logs.	<p>The CCP Log Parser provides an easy way to check application logs.</p> <ol style="list-style-type: none"><li>1. <a href="#">Download the CCP logs</a> after a call.</li><li>2. Open the <a href="#">CCP Log Parser</a>.</li><li>3. Drag and drop the log file to upload the log for analysis.</li><li>4. When the log has been analyzed, the <b>Snapshots &amp; Logs</b> tab will be selected by default. Choose the <b>Metrics</b> tab next to it to check insights.</li><li>5. In the <b>WebRTC Metrics - audio_input</b> section, check the following:<ul style="list-style-type: none"><li>• The <b>Audio Level</b> graph, to see if your received audio level is above 0. This indicates that audio was received from your caller.</li><li>• The <b>Packets</b> graph for any lost packets. If this chart shows significant increases, contact your IT support team.</li></ul></li><li>6. In the <b>WebRTC Metrics - audio_output</b> section, check the following:</li></ol>	Agent (advanced skills)

Task	Description	Skills required
	<ul style="list-style-type: none"> <li>• The <b>Audio Level</b> graph, to confirm that audio was sent out from your device.</li> <li>• The <b>Packets</b> graph. If you see a packet loss spike, report it to your IT support team.</li> <li>• The <b>Jitter Buffer &amp; RTT</b> graph. Round trip time (RTT) values above 300 will affect the call experience. Report these to your IT support team.</li> </ul>	

## Optimize browser settings

Task	Description	Skills required
Restore default WebRTC settings.	<p>WebRTC has to be enabled to make soft phone calls with CCP. We recommend that you keep the default settings for WebRTC-related features.</p> <ul style="list-style-type: none"> <li>• In Chrome, you can set flags by navigating to the URL <b>chrome://flags</b>. Type <b>WebRTC</b> in the search box to find settings that can interfere with CCP, and set these to <b>Default</b>.</li> <li>• In Firefox, type <b>about:config</b> in the address bar, and</li> </ul>	Administrator

Task	Description	Skills required
	then type <b>WebRTC</b> in the search box on the configuration page. Non-default settings appear in bold text and can be changed to <b>Default</b> .	
Disable browser extensions when troubleshooting.	Some browser extensions might affect call quality or even prevent calls from connecting properly. Use the incognito window or private mode in your browser, and disable all extensions. If that solves the problem, review your browser extensions and look for suspicious add-ons, or disable them individually.	Agent, Administrator
Check the browser sample rate.	Confirm that your microphone input is set to the optimal 48 kHz sample rate. For instructions, see the <a href="#">Amazon Connect Administrator Guide</a> .	Agent, Administrator

## Related resources

If you've followed the steps in this pattern but you're still encountering problems with call quality, see the following resources for troubleshooting tips.

- Review [common Contact Control Panel \(CCP\) issues](#).
- Check the connection with the [Endpoint Test Utility](#).
- Follow the [troubleshooting guide](#) for any other issues.



If your troubleshooting and adjustments don't solve the call quality issue, the root cause might be external to your workstation. For further troubleshooting, contact your IT support team.

## More patterns

- [Decompose monoliths into microservices by using CQRS and event sourcing](#)
- [Deploy a ChatOps solution to manage SAST scan results by using AWS Chatbot custom actions and AWS CloudFormation](#)
- [Integrate Amazon API Gateway with Amazon SQS to handle asynchronous REST APIs](#)
- [Register multiple AWS accounts with a single email address by using Amazon SES](#)
- [Run message-driven workloads at scale by using AWS Fargate](#)

# Migration

## Topics

- [Automate migration strategy identification and planning using AppScore](#)
- [Create AWS CloudFormation templates for AWS DMS tasks using Microsoft Excel and Python](#)
- [Get started with automated portfolio discovery](#)
- [Migrate on-premises Cloudera workloads to Cloudera Data Platform on AWS](#)
- [Restart the AWS Replication Agent automatically without disabling SELinux after rebooting a RHEL source server](#)
- [Re-architect](#)
- [Rehost](#)
- [Relocate](#)
- [Replatform](#)
- [Migration patterns by workload](#)
- [More patterns](#)

# Automate migration strategy identification and planning using AppScore

Created by Lech Migdal (AWS) and Geoff Davies (Partner)

<b>Environment:</b> Production	<b>Source:</b> All workloads	<b>Target:</b> AWS Cloud
<b>R Type:</b> N/A	<b>Workload:</b> All other workloads	<b>Technologies:</b> Migration; Modernization; Web & mobile apps; SaaS
<b>AWS services:</b> AWS Application Discovery Service; AWS Migration Hub		

## Summary

On-premises applications require a transformative approach to help unlock the benefits of the Amazon Web Services (AWS) Cloud. The [seven common migration strategies \(7 Rs\)](#) provide you with transformation options, which vary from making technology changes in on-premises database servers to rebuilding an application by using a cloud-native microservices architecture.

Choosing to use the full 7 Rs model means that you operate at the application and business level instead of only evaluating and preparing the servers for migration. Although you can obtain server data by using tools such as [AWS Migration Evaluator](#), other application information is often not recorded (for example, roadmap status, required recovery time objective (RTO) and recovery point objective (RPO), or data privacy requirements).

This pattern describes how to use [AppScore](#) to avoid these challenges by using an application-centric view of your portfolio. This includes a recommended transformation route to the AWS Cloud for each application against the full 7 Rs model. AppScore helps you capture application information, determine the ideal transformation route, identify the risk, complexity and benefits of cloud adoption, and quickly define the migration scopes, move groups, and schedules.

This pattern was created by AWS and [AppScore Technology Limited](#), an AWS Partner.

## Prerequisites and limitations

### Prerequisites

- Existing applications that you want to migrate to the AWS Cloud.
- Existing server inventory information from a tool such as [AWS Migration Evaluator](#). You can also import this data at a later stage in your migration.
- An existing AppScore account with **Power User** privileges. For more information about AppScore user accounts, see [How do I assign role-based access control \(RBAC\) to users?](#) in the AppScore documentation
- An understanding of how to assign RBAC roles in AppScore. AppScore provides three subject matter expert (SME) roles that align to the questions asked in the **Scoring** stage. This means that an SME only answers questions relevant to their expertise and role. For more information about this, see [How do I assign role-based access control \(RBAC\) to users?](#) in the AppScore documentation.
- An understanding of AppScore's recommendations, which are based on the following three categories of application attributes:
  - **Risk** – The business criticality of the application, whether it contains confidential data, data sovereignty requirements, and the number of application users or interfaces
  - **Complexity** – The application's development language (for example, COBOL has a higher score than .NET or PHP), age, UI, or number of interfaces
  - **Benefit** – The batch processing demand, application profile, disaster recovery model, development and test environment use
- An understanding of AppScore's four phases of iterative data capture:
  - **Signposting** – Questions that are combined with server data to produce the 7 Rs assessments. For more information, see [How to signpost and score applications](#) in the AppScore documentation.
  - **Scoring** – Questions that produce scores for risk, benefit, and complexity.
  - **Current State Assessment** – Questions that provide a current state assessment of the application.
  - **Transformation** – Questions that comprehensively evaluate the application for future state design.

**Important:** Only the *Signposting* and *Scoring* stages are required to receive application scores, 7 Rs assessments, and enable group planning. After you group applications and form scopes, you can complete the *Current State Assessment* and *Transformation* stages to build a more detailed overview of your application.

## Architecture

The following diagram shows the AppScore workflow that uses application and server data to create a recommendation for your migration strategy and transformation plan .

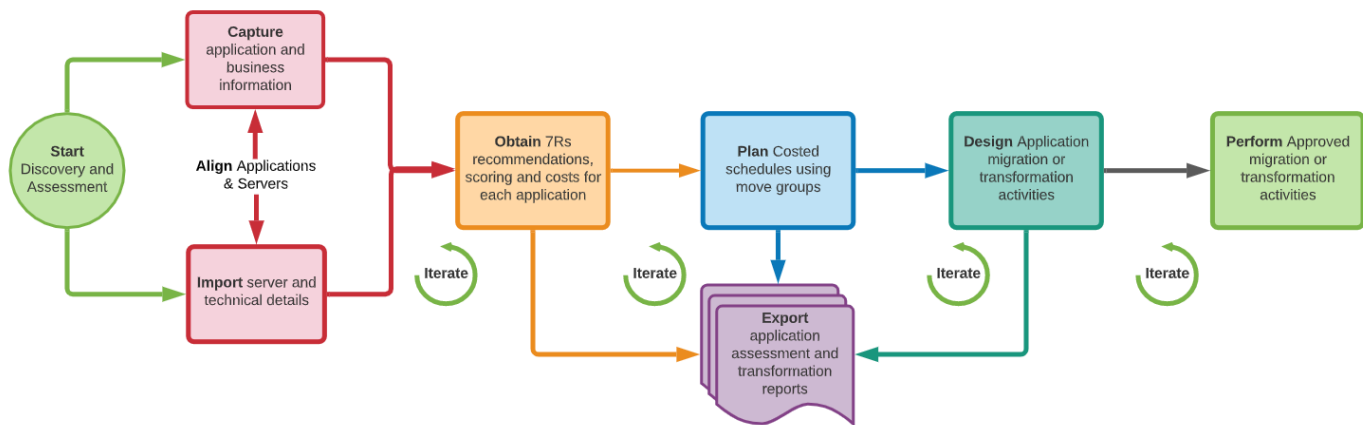

## Tools

- [AppScore](#) – AppScore helps you bridge the gap between discovery and migration implementation by providing an application-centric view of your portfolio with a recommended route to the cloud for each application against the full 7 Rs model.
- [AWS Migration Evaluator](#) – AWS Migration Evaluator is a migration assessment service that helps you create a directional business case for planning and migration.

## Epics

### Create and load the initial application list

Task	Description	Skills required
Prepare the list of applications.	Log in to the AppScore portal with your user credentials.	Migration engineer

Task	Description	Skills required
	<p>ls. Download the Import Template from the <b>Application</b> page and then update the Import Template with your application's non-technical attributes (for example, data classification or a list of attributes that can be customized).</p> <p>For more information about this, see <a href="#">How do I alter the AppScore application and business questionnaires</a> in the AppScore documentation.</p> <p><b>Note:</b> You can also manually add an application by choosing <b>New Application</b> on the <b>Application</b> page. You can then enter the non-technical attributes of the application.</p>	
Import the application data.	On the <b>Application</b> page, choose <b>Import Applications</b> to import your application data.	Migration engineer

### Capture the application and business data

Task	Description	Skills required
Review and answer Signposting and Scoring questions.	Open the <b>Servers</b> page and choose <b>Import Servers</b> .	App owner

Task	Description	Skills required
	<p>Choose the .csv file that contains your server data.</p> <p>The file can include attributes such as name, data center, operating system, virtual or physical, application name, role, database technology, environment, CPU core count and utilization, RAM size and utilization, disk size and utilization, matched machine type, and current and projected monthly costs.</p> <p>Confirm column mapping and choose <b>Confirm and Import</b>. Missing information in the imported data is highlighted on the <b>Server</b> page. You can resolve these gaps on this page or by using the <b>Bulk Edit</b> option. Servers are associated with the relevant application. However, if applications don't exist in AppScore, they are automatically created and the servers are then associated.</p> <p>You can also use an API connection to retrieve the data with AWS Migration Hub. For more information about this, see <a href="#">How do I import servers from AWS Migration</a></p>	



Task	Description	Skills required
	<p><a href="#">Hub via API?</a> In the AppScore documentation.</p> <p><b>Note:</b> If you used a discovery tool (for example, AWS Migration Evaluator) to capture performance over time, you must load an early extract of the server data as soon as possible and refresh the data when performance metrics are fully captured. AppScore uses the server names, operating system and database versions, data centers, and environments to provide scores and 7 Rs recommendations.</p>	
Check the application scores.	Open the <b>Applications</b> page to see the score and 7 Rs assessment for your applications. Your current run costs are also calculated. These calculations are updated when new information is imported to the <b>Applications</b> or <b>Servers</b> pages.	App owner

Task	Description	Skills required
Analyze individual applications.	Choose an application on the <b>Applications</b> page to review detailed recommendations. You can choose <b>Application Assessment Report</b> to generate a .pdf or .docx file with the detailed assessment data for specific applications.	App owner

### Create the migration schedule

Task	Description	Skills required
Choose the applications for the move group.	Open the <b>Planning</b> page, choose <b>Group Builder</b> , and then create application move groups according to your requirements.  You can add or remove attributes from the application list in the <b>Columns</b> section. You can also use application attributes in the <b>Filters</b> section to choose specific applications, which includes filtering out all applications that are already part of existing move groups.	Migration engineer
Create the move group.	Choose <b>Group Selected</b> , enter a name for your move group, choose the applications that you want to include in your	Migration engineer

Task	Description	Skills required
	move group, and then choose <b>Add to Group</b> .	
Schedule the migration.	<p>On the <b>Transformation Schedules</b> page, AppScore provides an estimated transformation duration, effort, and cost for your move group. The move group is automatically added into the overall transformation schedule.</p> <p><b>Note:</b> You can customize the assumptions behind the effort estimation in the <b>Planning Settings</b> page. This helps align them with your organization's requirements. For more information about this, see <a href="#">How do I configure the planning settings</a> in the AppScore documentation.</p>	Migration engineer

Task	Description	Skills required
Generate the complete transformation report.	<p>Open the <b>Group Manager</b> page and choose <b>Create Application Transformation Report Doc</b>. Choose the move groups and then choose <b>Export</b>. This generates a .docx file that summarizes the transformation, including the details for each move group.</p> <p>For a sample application transformation report, see <a href="#">Sample application transformation report</a> from the AppScore website.</p>	Migration engineer

## Related resources

- [What are the 7 Rs of an application migration?](#)
- [A closer look at AppScore](#)
- [AppScore in the AWS Marketplace](#)

# Create AWS CloudFormation templates for AWS DMS tasks using Microsoft Excel and Python

Created by Venkata Naveen Koppula (AWS)

<b>Environment:</b> PoC or pilot	<b>Source:</b> Automation	<b>Target:</b> Database in AWS Cloud
<b>R Type:</b> N/A	<b>Workload:</b> Microsoft	<b>Technologies:</b> Migration; Databases

## Summary

This pattern outlines steps for automatically creating AWS CloudFormation templates for [AWS Database Migration Service](#) (AWS DMS) using Microsoft Excel and Python.

Migrating databases using AWS DMS often involves creation of AWS CloudFormation templates to provision AWS DMS tasks. Previously, creating AWS CloudFormation templates required knowledge of the JSON or YAML programming language. With this tool, you only need basic knowledge of Excel and how to run a Python script using a terminal or command window.

As input, the tool takes an Excel workbook that includes the names of the tables to be migrated, Amazon Resource Names (ARNs) of AWS DMS endpoints, and AWS DMS replication instances. The tool then generates AWS CloudFormation templates for the required AWS DMS tasks.

For detailed steps and background information, see the blog post [Create AWS CloudFormation templates for AWS DMS tasks using Microsoft Excel](#) in the AWS Database blog.

## Prerequisites and limitations

### Prerequisites

- An active AWS account
- Microsoft Excel version 2016 or later
- Python version 2.7 or later
- The **xlrd** Python module (installed at a command prompt with the command: **pip install xlrd**)
- AWS DMS source and target endpoints and AWS DMS replication instance

## Limitations

- The names of schemas, tables, and associated columns are transformed into lowercase characters at the destination endpoints.
- This tool doesn't address the creation of AWS DMS endpoints and replication instances.
- Currently, the tool supports only one schema for each AWS DMS task.

## Architecture

### Source technology stack

- An on-premises database
- Microsoft Excel

### Target technology stack

- AWS CloudFormation templates
- A database in the AWS Cloud

### Architecture

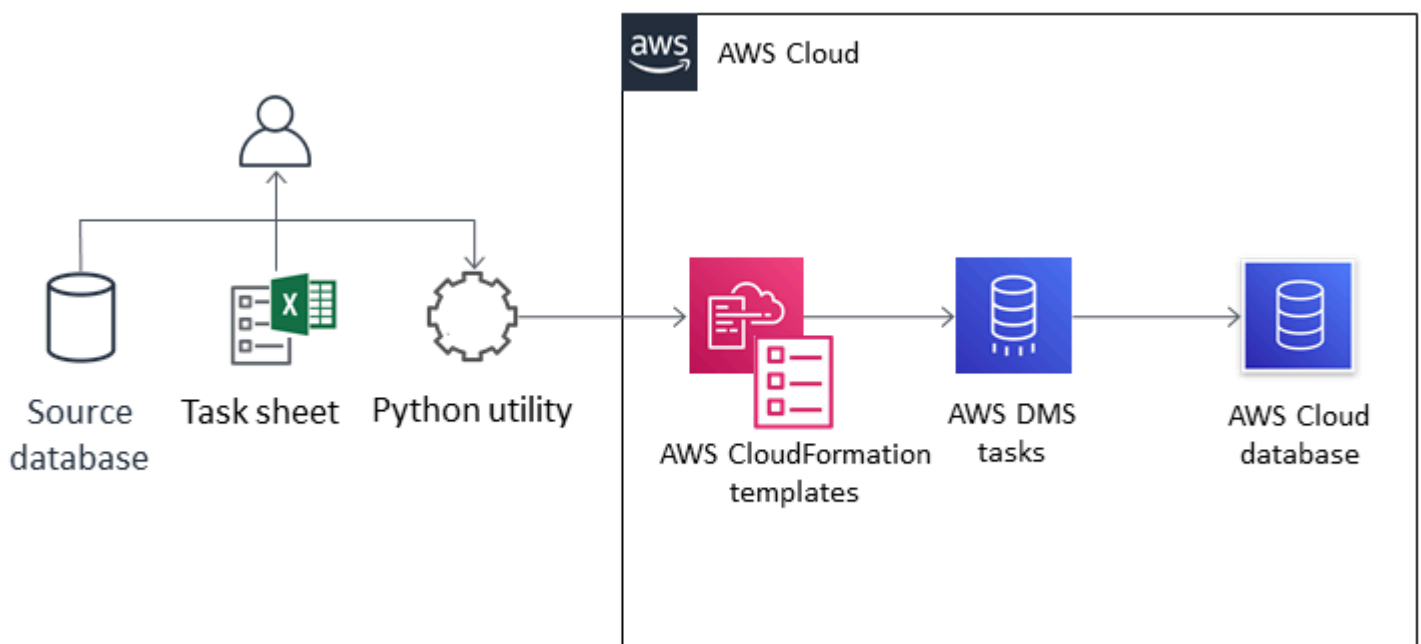

## Tools

- [Pycharm IDE](#), or any integrated development environment (IDE) that supports Python version 3.6
- Microsoft Office 2016 (for Microsoft Excel)

## Epics

### Configure the network, AWS DMS replication instance, and endpoints

Task	Description	Skills required
If necessary, request a service quota increase.	Request a service quota increase for the AWS DMS tasks if needed.	General AWS
Configure the AWS Region, virtual private clouds (VPCs), CIDR ranges, Availability Zones, and subnets.		General AWS
Configure the AWS DMS replication instance.	The AWS DMS replication instance can connect to both on-premises and AWS databases.	General AWS
Configure AWS DMS endpoints.	Configure endpoints for both the source and target databases.	General AWS

### Prepare the worksheets for AWS DMS tasks and tags

Task	Description	Skills required
Configure the tables list.	List all tables involved in the migration.	Database

Task	Description	Skills required
Prepare the tasks worksheet.	Prepare the Excel worksheet using the tables list you configured.	General AWS, Microsoft Excel
Prepare the tags worksheet.	Detail the AWS resource tags to attach to the AWS DMS tasks.	General AWS, Microsoft Excel

## Download and run the tool

Task	Description	Skills required
Download and extract the template generation tool from the GitHub repository.	GitHub repository: <a href="https://github.com/aws-samples/dms-cloudformation-templates-generator/">https://github.com/aws-samples/dms-cloudformation-templates-generator/</a>	
Run the tool.	Follow the detailed instructions in the blog post listed under "References and help."	

## Related resources

- [Create AWS CloudFormation templates for AWS DMS tasks using Microsoft Excel \(blog post\)](#)
- [DMS CloudFormation Templates Generator \(GitHub repository\)](#)
- [Python documentation](#)
- [xlrd description and download](#)
- [AWS DMS documentation](#)
- [AWS CloudFormation documentation](#)



# Get started with automated portfolio discovery

Created by Pratik Chunawala (AWS) and Rodolfo Jr. Cerrada (AWS)

<b>Environment:</b> Production	<b>Source:</b> On-premises	<b>Target:</b> On-premises
<b>R Type:</b> N/A	<b>Workload:</b> All other workloads	<b>Technologies:</b> Migration

## Summary

Assessing the portfolio and collecting metadata is a critical challenge when migrating applications and servers to the Amazon Web Services (AWS) Cloud, especially for large migrations that have more than 300 servers. Using an automated portfolio discovery tool can help you collect information about your applications, such as the number of users, frequency of use, dependencies, and information about the application's infrastructure. This information is essential when planning migration waves so that you can properly prioritize and group applications with similar traits. Using a discovery tool streamlines communication between the portfolio team and the application owners because the portfolio team can validate the results of the discovery tool rather than manually collecting the metadata. This pattern discusses key considerations for selecting an automated discovery tool and information about how to deploy and test one in your environment.

This pattern includes a template, which is a starting point for building your own checklist of high-level activities. Next to the checklist is template for a responsible, accountable, consulted, informed (RACI) matrix. You can use this RACI matrix to determine who is responsible for each task in your checklist.

## Epics

### Select a discovery tool

Task	Description	Skills required
Determine whether a discovery tool is appropriate for your use case.	A discovery tool might not be the best solution for your use case. Consider the	Migration lead, Migration engineer

Task	Description	Skills required
	<p>amount of time required to select, procure, prepare, and deploy a discovery tool. It can take 4–8 weeks to set up the scanning appliance for an agentless discovery tool in your environment or to install agents to all in-scope workloads. Once deployed, you must allow 4–12 weeks for the discovery tool to collect metadata by scanning the application workloads and performing application stack analysis. If you are migrating fewer than 100 servers, you might be able to manually collect the metadata and analyze dependencies faster than the time required to deploy and collect metadata with an automated discovery tool.</p>	

Task	Description	Skills required
Select a discovery tool.	Review the <b>Considerations for selecting an automated discovery tool</b> in the <a href="#">Additional information</a> section. Determine the appropriate criteria for selecting a discovery tool for your use case, and then evaluate each tool against those criteria. For a comprehensive list of automated discovery tools, see <a href="#">Discovery, Planning, and Recommendation migration tools</a> .	Migration lead, Migration engineer

## Prepare for installation

Task	Description	Skills required
Prepare the pre-deployment checklist.	Create a checklist of the tasks you must complete before deploying the tool. For an example, see <a href="#">Predeployment Checklist</a> on the Flexera documentation website.	Build lead, Migration engineer, Migration lead, Network administrator
Prepare the network requirements.	Provision the ports, protocols, IP addresses, and routing necessary for the tool to run and access the target servers. For more information, see the installation guide for your discovery tool. For an	Migration engineer, Network administrator, Cloud architect

Task	Description	Skills required
	example, see <a href="#">Deployment Requirements</a> on the Flexera documentation website.	
Prepare the account and credential requirements.	Identify the credentials you need to access the target servers and to install all of the tool's components.	Cloud administrator, General AWS, Migration engineer, Migration lead, Network administrator, AWS administrator
Prepare the appliances on which you will install the tool.	Ensure that the appliances on which you will install the tool components meet the specifications and platform requirements for the tool.	Migration engineer, Migration lead, Network administrator
Prepare the change orders.	According to the change management process in your organization, prepare the any change orders needed, and ensure these change orders are approved.	Build lead, Migration lead
Send requirements to stakeholders.	Send the pre-deployment checklist and network requirements to the stakeholders. Stakeholders should review, evaluate, and prepare the necessary requirements before proceeding with the deployment.	Build lead, Migration lead

## Deploy the tool

Task	Description	Skills required
Download the installer.	Download the installer or the virtual machine image. Virtual machine images typically come in Open Virtualization Format (OVF).	Build lead, Migration lead
Extract the files.	If you are using an installer, you must download and run the installer on an on-premises server.	Build lead, Migration lead
Deploy the tool on the servers.	<p>Deploy the discovery tool on the target, on-premises servers as follows:</p> <ul style="list-style-type: none"> <li>• If your source file is a virtual machine image, deploy it into your virtual machine environment, such as VMware.</li> <li>• If your source file is an installer, run the installer to install and set up the tool.</li> </ul>	Build lead, Migration lead, Network administrator
Log in to the discovery tool.	Follow the on-screen prompts, and log in to get started with the tool.	Migration lead, Build lead
Activate the product.	Enter your license key.	Build lead, Migration lead
Configure the tool.	Enter any credentials necessary to access the target servers, such as credentials for Windows, VMware,	Build lead, Migration lead

Task	Description	Skills required
	Simple Network Management Protocol (SNMP), and Secure Shell Protocol (SSH), or databases.	

## Test the tool

Task	Description	Skills required
Select test servers.	Identify a small set of non-production subnets or IP addresses that you can use to test the discovery tool. This helps you validate the scans quickly, identify and troubleshoot any errors quickly, and isolate your tests from production environments.	Build lead, Migration lead, Network administrator
Start scanning the selected test servers.	<p>For an agentless discovery tool, enter the subnets or IP addresses for the selected test servers in the discovery tool console, and start the scan.</p> <p>For an agent-based discovery tool, install the agent on the selected test servers.</p>	Build lead, Migration lead, Network administrator
Review the scan results.	Review the scan results for the test servers. If any errors are found, troubleshoot and fix the errors. Document the	Build lead, Migration lead, Network administrator

Task	Description	Skills required
	errors and solutions. You reference this information in the future, and you can add this information to your portfolio runbook.	
Rescan the test servers.	Once the rescan is complete, repeat the scan until there are no errors.	Build lead, Migration lead, Network administrator

## Related resources

### AWS resources

- [Application portfolio assessment guide for AWS Cloud migration](#)
- [Discovery, Planning, and Recommendation migration tools](#)

### Deployment guides for commonly selected discovery tools

- [Deploy the RN150 virtual appliance](#) (Flexera documentation)
- [Gatherer Installation](#) (modelizeIT documentation)
- [On-Prem Analysis Server Installation](#) (modelizeIT documentation)

## Additional information

### Considerations for selecting an automated discovery tool

Each discovery tool has benefits and limitations. When selecting the appropriate tool for your use case, consider the following:

- Select a discovery tool that can collect most, if not all, of the metadata you need to achieve your portfolio assessment goal.
- Identify any metadata you need to gather manually because the tool doesn't support it.

- Provide the discovery tool requirements to stakeholders so they can review and assess the tool based on their internal security and compliance requirements, such as server, network, and credential requirements.
  - Does the tool require that you install an agent in the in-scope workload?
  - Does the tool require that you set up a virtual appliance in your environment?
- Determine your data residency requirements. Some organizations don't want to store their data outside of their environment. To address this, you might need to install some components of the tool in the on-premises environment.
- Make sure the tool supports the operating system (OS) and OS version of the in-scope workload.
- Determine whether your portfolio includes mainframe, mid-range, and legacy servers. Most of the discovery tools can detect these workloads as dependencies, but some tools might not be able to get device details, such as utilization and server dependencies. Device42 and modernizeIT discovery tools both support mainframe and mid-range servers.

## Attachments

To access additional content that is associated with this document, unzip the following file:

[attachment.zip](#)



# Migrate on-premises Cloudera workloads to Cloudera Data Platform on AWS

Created by Battulga Purevragchaa (AWS), Nijjwol Lamsal (Partner), and Nidhi Gupta (AWS)

<b>Environment:</b> PoC or pilot	<b>Source:</b> Cloudera workloads	<b>Target:</b> Cloudera Data Platform (CDP) Public Cloud
<b>R Type:</b> N/A	<b>Workload:</b> All other workloads	<b>Technologies:</b> Migration; Big data; Databases; Analytics
<b>AWS services:</b> Amazon EC2; Amazon EKS; AWS Identity and Access Management; Amazon S3; Amazon RDS		

## Summary

This pattern describes the high-level steps for migrating your on-premises Cloudera Distributed Hadoop (CDH), Hortonworks Data Platform (HDP), and Cloudera Data Platform (CDP) workloads to CDP Public Cloud on AWS. We recommend that you partner with Cloudera Professional Services and a systems integrator (SI) to implement these steps.

There are many reasons Cloudera customers want to move their on-premises CDH, HDP, and CDP workloads to the cloud. Some typical reasons include:

- Streamline adoption of new data platform paradigms such as data lakehouse or data mesh
- Increase business agility, democratize access and inference on existing data assets
- Lower the total cost of ownership (TCO)
- Enhance workload elasticity
- Enable greater scalability; drastically reduce time to provision data services compared with legacy, on-premises install base
- Retire legacy hardware; significantly reduce hardware refresh cycles
- Take advantage of pay-as-you-go pricing, which is extended to Cloudera workloads on AWS with the Cloudera licensing model (CCU)

- Take advantage of faster deployment and improved integration with continuous integration and continuous delivery (CI/CD) platforms
- Use a single unified platform (CDP) for multiple workloads

Cloudera supports all major workloads, including Machine Learning, Data Engineering, Data Warehouse, Operational Database, Stream Processing (CSP), and data security and governance. Cloudera has offered these workloads for many years on premises, and you can migrate these workloads to the AWS Cloud by using CDP Public Cloud with Workload Manager and Replication Manager.

Cloudera Shared Data Experience (SDX) provides a shared metadata catalog across these workloads to facilitate consistent data management and operations. SDX also includes comprehensive, granular security to protect against threats, and unified governance for audit and search capabilities for compliance with standards such as Payment Card Industry Data Security Standard (PCI DSS) and GDPR.

### CDP migration at a glance

	Source workload	CDH, HDP, and CDP Private Cloud
	Source environment	<ul style="list-style-type: none"> <li>• Windows, Linux</li> <li>• On-premises, colocation, or any non-AWS environment</li> </ul>
<b>Workload</b>	Destination workload	CDP Public Cloud on AWS
	Destination environment	<ul style="list-style-type: none"> <li>• Deployment model: customer account</li> <li>• Operating model: customer/Cloudera control plane</li> </ul>
	Migration strategy (7Rs)	Rehost, replatform, or refactor
<b>Migration</b>	Is this an upgrade in the workload version?	Yes

## Migration duration

- **Deployment:** About 1 week to create customer account, virtual private cloud (VPC), and CDP Public Cloud customer-managed environment.
- **Migration duration:** 1-4 months, depending on the complexity and size of the workload.

**Cost**

## Cost of running the workload on AWS

- At a high level, the cost of a CDH workload migration to AWS assumes that you will establish a new environment on AWS. It includes accounting for personnel time and effort as well as provisioning computing resources and licensing software for the new environment.
- The Cloudera cloud consumption-based pricing model gives you the flexibility to take advantage of bursting and automatic scaling capabilities. For more information, see [CDP Public Cloud service rates](#) on the Cloudera website.
- Cloudera Enterprise [Data Hub](#) is based on Amazon Elastic Compute Cloud (Amazon EC2) and closely models traditional clusters. Data Hub can be [customized](#), but this will affect costs.
- [CDP Public Cloud Data Warehouse](#), [Cloudera Machine Learning](#), and [Cloudera Data Engineering \(CDE\)](#) are container-based and can be configured to scale automatically.

	System requirements	See the <a href="#">Prerequisites</a> section.
<b>Infrastructure agreements and framework</b>	SLA	See <a href="#">Cloudera Service Level Agreement for CDP Public Cloud</a> .
	DR	See <a href="#">Disaster Recovery</a> in the Cloudera documentation.
	Licensing and operating model (for target AWS account)	Bring Your Own License (BYOL) model
<b>Compliance</b>	Security requirements	See <a href="#">Cloudera Security Overview</a> in the Cloudera documentation.
	Other <a href="#">compliance certifications</a>	See the information on the Cloudera website about <a href="#">General Data Protection Regulation (GDPR)</a> compliance and the <a href="#">CDP Trust Center</a> .

## Prerequisites and limitations

### Prerequisites

- [AWS account requirements](#), including accounts, resources, services, and permissions, such as AWS Identity and Access Management (IAM) roles and policies setup
- [Prerequisites for deploying CDP](#) from the Cloudera website

The migration requires the following roles and expertise:

Role	Skills and responsibilities
Migration lead	Ensures executive support, team collaboration, planning, implementation, and assessment

Cloudera SME	Expert skills in CDH, HDP, and CDP administration, system administration, and architecture
AWS architect	Skills in AWS services, networking, security, and architectures

## Architecture

Building to the appropriate architecture is a critical step to ensure that migration and performance meet your expectations. For your migration effort to meet this playbook's assumptions, your target data environment in the AWS Cloud, either on virtual private cloud (VPC) hosted instances or CDP, must be an equivalent match to your source environment in terms of operating system and software versions as well as major machine specifications.

The following diagram (reproduced with permission from the [Cloudera Shared Data Experience data sheet](#)) shows the infrastructure components for the CDP environment and how the tiers or infrastructure components interact.

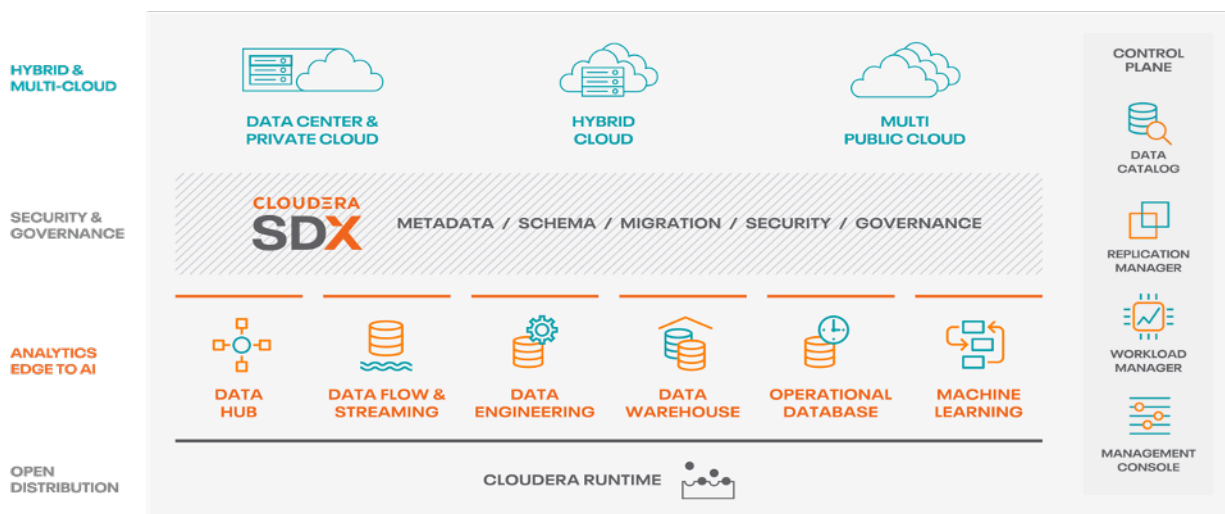

The architecture includes the following CDP components:

- Data Hub is a service for launching and managing workload clusters powered by Cloudera Runtime. You can use the cluster definitions in Data Hub to provision and access workload clusters for custom use cases and define custom cluster configurations. For more information, see the [Cloudera website](#).

- Data Flow and Streaming addresses the key challenges enterprises face with data in motion. It manages the following:
  - Processing real-time data streaming at high volume and high scale
  - Tracking data provenance and lineage of streaming data
  - Managing and monitoring edge applications and streaming sources

For more information, see [Cloudera DataFlow](#) and [CSP](#) on the Cloudera website.

- Data Engineering includes data integration, data quality, and data governance, which help organizations build and maintain data pipelines and workflows. For more information, see the [Cloudera website](#). Learn about [support for spot instances to facilitate cost savings on AWS](#) for Cloudera Data Engineering workloads.
- Data Warehouse enables you to create independent data warehouses and data marts that automatically scale to meet workload demands. This service provides isolated compute instances and automated optimization for each data warehouse and data mart, and helps you save costs while meeting SLAs. For more information, see the [Cloudera website](#). Learn about [managing costs](#) and [auto-scaling](#) for Cloudera Data Warehouse on AWS.
- Operational Database in CDP provides a reliable and flexible foundation for scalable, high-performance applications. It delivers a real-time, always available, scalable database that serves traditional structured data alongside new, unstructured data within a unified operational and warehousing platform. For more information, see the [Cloudera website](#).
- Machine Learning is a cloud-native machine learning platform that merges self-service data science and data engineering capabilities into a single, portable service within an enterprise data cloud. It enables scalable deployment of machine learning and artificial intelligence (AI) on data anywhere. For more information, see the [Cloudera website](#).

## CDP on AWS

The following diagram (adapted with permission from the Cloudera website) shows the high-level architecture of CDP on AWS. CDP implements its [own security model](#) to manage both accounts and data flow. These are integrated with [IAM](#) through the use of [cross-account roles](#).

# CDP on AWS

## High-level architecture

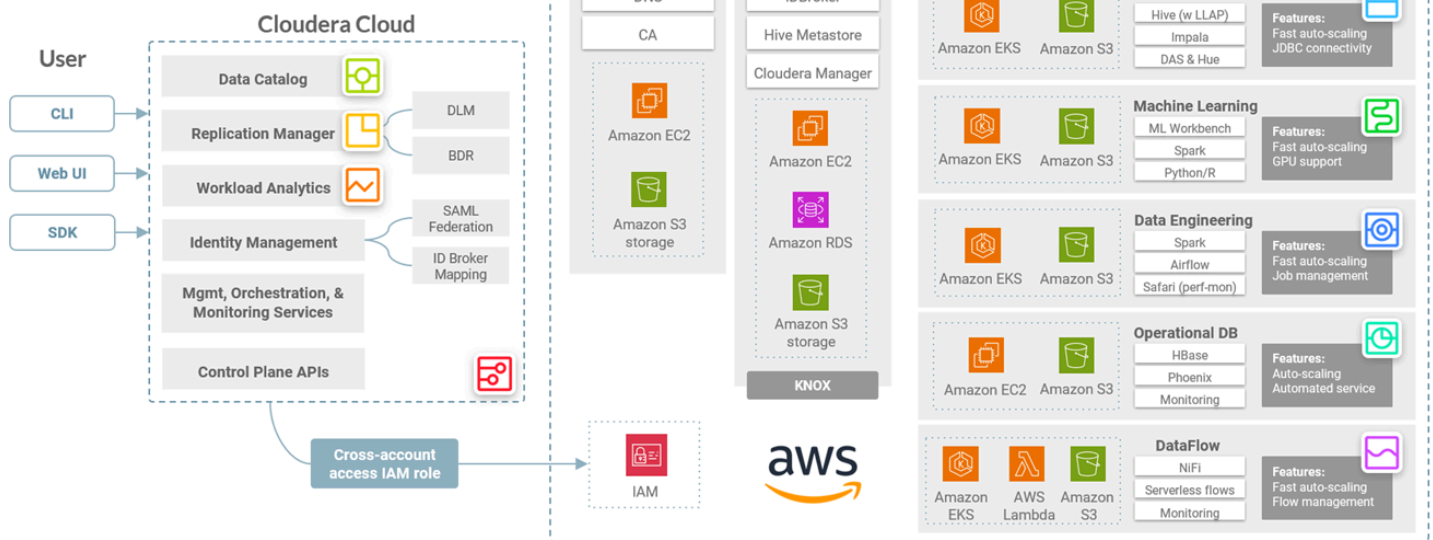

The CDP control plane resides in a Cloudera master account in its own VPC. Each customer account has its own sub-account and unique VPC. Cross-account IAM roles and SSL technologies route management traffic to and from the control plane to customer services that reside on internet-routable public subnets within each customer VPC. On the customer's VPC, the Cloudera Shared Data Experience (SDX) provides enterprise-strength security with unified governance and compliance so you can get insights from your data faster. SDX is a design philosophy incorporated into all Cloudera products. For more information about [SDX](#) and the [CDP Public Cloud network architecture for AWS](#), see the Cloudera documentation.

## Tools

### AWS services

- [Amazon Elastic Compute Cloud \(Amazon EC2\)](#) provides scalable computing capacity in the AWS Cloud. You can launch as many virtual servers as you need and quickly scale them up or down.
- [Amazon Elastic Kubernetes Service \(Amazon EKS\)](#) helps you run Kubernetes on AWS without needing to install or maintain your own Kubernetes control plane or nodes.
- [AWS Identity and Access Management \(IAM\)](#) helps you securely manage access to your AWS resources by controlling who is authenticated and authorized to use them.



- [Amazon Relational Database Service \(Amazon RDS\)](#) helps you set up, operate, and scale a relational database in the AWS Cloud.
- [Amazon Simple Storage Service \(Amazon S3\)](#) is a cloud-based object storage service that helps you store, protect, and retrieve any amount of data.

## Automation and tooling

- For additional tooling, you can use [Cloudera Backup Data Recovery \(BDR\)](#), [AWS Snowball](#), and [AWS Snowmobile](#) to help migrate data from on-premises CDH, HDP, and CDP to AWS-hosted CDP.
- For new deployments, we recommend that you use the [AWS Partner Solution for CDP](#).

## Epics

### Prepare for migration

Task	Description	Skills required
Engage the Cloudera team.	<p>Cloudera pursues a standardized engagement model with its customers and can work with your systems integrator (SI) to promote the same approach. Contact the Cloudera customer team so they can provide guidance and the necessary technical resources to get the project started. Contacting the Cloudera team ensures that all necessary teams can prepare for the migration as its date approaches.</p> <p>You can contact Cloudera Professio</p>	Migration lead

Task	Description	Skills required
	nal Services to move your Cloudera deployment from pilot to production quickly, at lower cost, and with peak performance. For a complete list of offerings, see the <a href="#">Cloudera website</a> .	
Create a CDP Public Cloud environment on AWS for your VPC.	Work with Cloudera Professional Services or your SI to plan and deploy CDP Public Cloud into a VPC on AWS.	Cloud architect, Cloudera SME

Task	Description	Skills required
Prioritize and assess workloads for migration.	<p>Evaluate all your on-premises workloads to determine the workloads that are the easiest to migrate. Applications that aren't mission-critical are the best to move first, because they will have minimal impact on your customers. Save the mission-critical workloads for last, after you successfully migrate other workloads.</p> <p><b>Note:</b> Transient (CDP Data Engineering) workloads are easier to migrate than persistent (CDP Data Warehouse) workloads. It's also important to consider data volume and locations when migrating. Challenges can include replicating data continuously from an on-premises environment to the cloud, and changing the data ingestion pipelines to import data directly to the cloud.</p>	Migration lead

Task	Description	Skills required
Discuss CDH, HDP, CDP, and legacy application migration activities.	<p>Consider and start planning for the following activities with Cloudera Workload Manager:</p> <ul style="list-style-type: none"><li>• Data and workloads to copy to your AWS environment</li><li>• Cloud-ready data</li><li>• Noisy neighbors, which use up resources and create issues for other tenants</li><li>• Elastic workloads</li><li>• Small clusters with high operational overhead</li></ul>	Migration lead

Task	Description	Skills required
Complete the Cloudera Replication Manager requirements and recommendations.	<p>Work with Cloudera Professional Services and your SI to prepare to migrate workloads to your CDP Public Cloud environment on AWS. Understanding the following requirements and recommendations can help you avoid common issues during and after you install the Replication Manager service.</p> <ul style="list-style-type: none"><li>• Review Replication Manager supporting documents to confirm that you meet the environment and system requirements. For more information, see <a href="#">Support matrix for CDP Public Cloud Replication Manager</a> on the Cloudera website.</li><li>• You don't need root access to the nodes on which the Replication Manager App and Data Lifecycle Manager (DLM) engine will be installed.</li><li>• Install Apache Hive during the initial installation of Replication Manager, unless you are certain that you won't use Hive replication</li></ul>	Migration lead

Task	Description	Skills required
	<p>in the future. If you decide to install Hive after creating HDFS replication policies in Replication Manager, you have to delete and then recreate all HDFS replication policies after you add Hive.</p> <ul style="list-style-type: none"><li>• Clusters used in Replication Manager must have symmetrical configurations. Each cluster in a replication relationship must be configured exactly the same for security (Kerberos), user management (LDAP/AD), and Knox Proxy. Cluster services such as Hadoop Distributed File System (HDFS), Apache Hive, Apache Knox, Apache Ranger, and Apache Atlas can have different configurations for high availability (HA). For example, source and target clusters might have separate HA and non-HA configurations.</li></ul>	

## Migrate CDP to AWS

Task	Description	Skills required
Migrate the first workload for dev/test environments by using Cloudera Workload Manager.	Your SI can help you migrate your first workload to the AWS Cloud. This should be an application that isn't customer-facing or mission-critical. Ideal candidates for dev/test migration are applications that have data that the cloud can easily ingest, such as CDP Data Engineering workloads. This is a transient workload that usually has fewer users accessing it, compared with a persistent workload such as a CDP Data Warehouse workload that could have many users who need uninterrupted access. Data Engineering workloads aren't persistent, which minimizes the business impact if something goes wrong. However, these jobs could be critical for production reporting, so prioritize low-impact Data Engineering workloads first.	Migration lead
Repeat migration steps as necessary.	Cloudera Workload Manager helps identify workloads that are best suited for the cloud. It provides metrics	Cloudera SME

Task	Description	Skills required
	<p>such as cloud performance ratings, sizing/capacity plans for the target environment, and replication plans. The best candidates for migration are seasonal workloads, ad hoc reporting, and intermittent jobs that don't consume many resources.</p> <p>Cloudera Replication Manager moves data from on premises to the cloud, and from the cloud to on premises.</p> <p>Proactively optimize workloads, applications, performance, and infrastructure capacity for data warehousing, data engineering, and machine learning by using Workload Manager. For a complete guide on how to modernize a data warehouse, see the <a href="#">Cloudera website</a>.</p>	

## Related resources

Cloudera documentation:

- [Registering classic clusters with CDP, Cloudera Manager, and Replication Manager:](#)
  - [Management Console](#)
  - [Replication Manager hive replication](#)
- [Sentry replication](#)



- [Sentry permissions](#)
- [Data Hub cluster planning checklist](#)
- [Workload Manager architecture](#)
- [Replication Manager requirements](#)
- [Cloudera Data Platform Observability](#)
- [AWS requirements](#)

AWS documentation:

- [Cloud Data Migration](#)

# Restart the AWS Replication Agent automatically without disabling SELinux after rebooting a RHEL source server

Created by Anil Kunapareddy (AWS), Shanmugam Shanker (AWS), and Venkatramana Chintha (AWS)

**Environment:** Production

**Technologies:** Migration;  
Operating systems

**Workload:** Open-source

**AWS services:** AWS MGN

## Summary

AWS Application Migration Service helps simplify, expedite, and automate the migration of your Red Hat Enterprise Linux (RHEL) workload to the Amazon Web Services (AWS) Cloud. To add source servers to Application Migration Service, you install the AWS Replication Agent on the servers.

Application Migration Service provides real-time, asynchronous, block-level replication. This means that you can continue normal IT operations during the entire replication process. These IT operations might require that you reboot or restart your RHEL source server during the migration. If this happens, the AWS Replication Agent will not restart automatically, and your data replication will stop. Typically, you can set Security-Enhanced Linux (SELinux) to **disabled** or **permissive** mode to automatically restart AWS Replication Agent. However, your organization's security policies might prohibit disabling SELinux, and you might also have to [relabel your files](#).

This pattern describes how to automatically restart the AWS Replication Agent without turning off SELinux when your RHEL source server reboots or restarts during a migration.

## Prerequisites and limitations

### Prerequisites

- An active AWS account.
- An on-premises RHEL workload that you want to migrate to the AWS Cloud.
- Application Migration Service initialized from the Application Migration Service console. Initialization is required only the first time you use this service. For instructions, see the [Application Migration Service documentation](#).

- An existing [AWS Identity and Access Management \(IAM\) policy](#) for Application Migration Service. For more information, see the [Application Migration Service documentation](#).

## Versions

- RHEL version 7 or later

## Tools

### AWS services

- [AWS Application Migration Service](#) is a highly automated lift-and-shift (rehost) solution that simplifies, expedites, and reduces the cost of migrating applications to AWS.

### Linux commands

The following table provides a list of Linux commands that you will run on your RHEL source server. These are also described in the epics and stories for this pattern.

Command	Description
<code>#systemctl -version</code>	Identifies the system version.
<code>#systemctl list-units --type=service</code>	Lists all active services that are available on the RHEL server.
<code>#systemctl list-units --type=service   grep running</code>	Lists all services that are currently running on the RHEL server.
<code>#systemctl list-units --type=service   grep failed</code>	Lists all services that failed to load after the RHEL server rebooted or restarted.
<code>restorecon -Rv /etc/rc.d/init.d/aws-replication-service</code>	Changes the context to <code>aws-replication-service</code> .
<code>yum install policycoreutils*</code>	Installs the policy core utilities that are required for the operation of the SELinux system.

<code>ausearch -c "insmod" --raw   audit2allow -M my-modprobe</code>	Searches the audit log and creates a module for policies.
<code>semodule -i my-modprobe.pp</code>	Activates the policy.
<code>cat my-modprobe.te</code>	Displays the contents of the <code>my-modprobe.te</code> file.
<code>semodule -l   grep my-modprobe</code>	Checks whether the policy has been loaded to the SELinux module.

## Epics

### Install the AWS Replication Agent and reboot the RHEL source server

Task	Description	Skills required
Create an Application Migration Service user with an access key and a secret access key.	To install the AWS Replication Agent, you must create an Application Migration Service user with the required AWS credentials. For instructions, see the <a href="#">Application Migration Service documentation</a> .	Migration engineer
Install the AWS Replication Agent.	<ol style="list-style-type: none"> <li>1. Sign in to the AWS Management Console and open the AWS Migration Service console at <a href="https://console.aws.amazon.com/mgn/home">https://console.aws.amazon.com/mgn/home</a>.</li> <li>2. Configure replication settings by following the instructions in the <a href="#">Application Migration Service documentation</a>.</li> </ol>	Migration engineer

Task	Description	Skills required
	<p>3. Install the AWS Replication Agent by following the instructions in the <a href="#">Application Migration Service documentation</a>.</p> <p>4. On the <b>Source Servers</b> page, choose the RHEL source server, and then choose <b>Replication</b> to start the initial replication. For more information, see the <a href="#">Application Migration Service documentation</a>.</p>	
Restart or reboot the RHEL source server.	Restart or reboot your RHEL source server when its <b>Data replication status</b> displays <b>Healthy</b> on the <a href="#">Migration dashboard</a> .	Migration engineer
Check data replication status.	Wait for one hour and then check the <b>Data replication status</b> again on the Migration dashboard. It should be in the <b>Stalled</b> state.	Migration engineer

### Check AWS Replication Agent status on the RHEL source server

Task	Description	Skills required
Identify the system version.	Open the command line interface for your RHEL source server and run the following command to identify the system version:	Migration engineer

Task	Description	Skills required
	<pre>#systemctl -version</pre>	
List all active services.	To list all active services available on the RHEL server, run the command:  <pre>#systemctl list-units --type=service</pre>	Migration engineer
List all running services.	To list all services that are currently running on the RHEL server, use the command:  <pre>#systemctl list-units --type=service   grep running</pre>	Migration engineer
List all services that failed to load.	To list all services that failed to load after the RHEL server rebooted or restarted, run the command:  <pre>#systemctl list-units --type=service   grep failed</pre>	Migration engineer

## Create and run the SELinux module

Task	Description	Skills required
Change the security context.	In the command line interface for your RHEL source server, run the following command to change the security	Migration engineer

Task	Description	Skills required
	<p>context to the AWS replication service:</p> <pre>restorecon -Rv /etc/rc.d/init.d/aws-replication-service</pre>	
Install core utilities.	<p>To install the core utilities required for the operation of the SELinux system and its policies, run the command:</p> <pre>yum install policycoreutils*</pre>	Migration engineer
Search the audit log and create a module for policies.	<p>Run the command:</p> <pre>ausearch -c "insmod" --raw   audit2allow -M my-modprobe</pre>	Migration engineer
Display the contents of the my-modprobe-te file.	<p>The my-modprobe.te file is generated by the <b>audit2allow</b> command. It includes the SELinux domains, policy source directory, and subdirectories, and specifies the access vector rules and transitions associated with the domains. To display the contents of the file, run the command:</p> <pre>cat my modprobe.te</pre>	Migration engineer

Task	Description	Skills required
Activate the policy.	<p>To insert the module and make the policy package active, run the command:</p> <pre>semodule -i my-modprobe.pp</pre>	Migration engineer
Check whether the module has been loaded.	<p>Run the command:</p> <pre>semodule -l   grep my-modprobe</pre> <p>After the SELinux module is loaded, you will no longer have to set SELinux to <b>disabled</b> or <b>permissive</b> mode during your migration.</p>	Migration engineer
Reboot or restart the RHEL source server and verify the data replication status.	<p>Open the AWS Migration Service console, navigate to <b>Data replication progress</b>, and then reboot or restart your RHEL source server. Data replication should now resume automatically after the RHEL source server reboots.</p>	Migration engineer

## Related resources

- [Application Migration service documentation](#)
- [Technical training materials](#)
- [Troubleshooting AWS Replication Agent issues](#)
- [Application Migration Service policies](#)





# Re-architect

## Topics

- [Convert VARCHAR2\(1\) data type for Oracle to Boolean data type for Amazon Aurora PostgreSQL](#)
- [Create application users and roles in Aurora PostgreSQL-Compatible](#)
- [Emulate Oracle DR by using a PostgreSQL-compatible Aurora global database](#)
- [Incrementally migrate from Amazon RDS for Oracle to Amazon RDS for PostgreSQL using Oracle SQL Developer and AWS SCT](#)
- [Load BLOB files into TEXT by using file encoding in Aurora PostgreSQL-Compatible](#)
- [Migrate Amazon RDS for Oracle to Amazon RDS for PostgreSQL in SSL mode by using AWS DMS](#)
- [Migrate Amazon RDS for Oracle to Amazon RDS for PostgreSQL with AWS SCT and AWS DMS using AWS CLI and AWS CloudFormation](#)
- [Migrate Oracle SERIALLY\\_REUSABLE pragma packages into PostgreSQL](#)
- [Migrate Oracle external tables to Amazon Aurora PostgreSQL-Compatible](#)
- [Migrate function-based indexes from Oracle to PostgreSQL](#)
- [Migrate Oracle native functions to PostgreSQL using extensions](#)
- [Migrate a Db2 database from Amazon EC2 to Aurora MySQL-Compatible by using AWS DMS](#)
- [Migrate a Microsoft SQL Server database from Amazon EC2 to Amazon DocumentDB by using AWS DMS](#)
- [Migrate an on-premises ThoughtSpot Falcon database to Amazon Redshift](#)
- [Migrate an Oracle database to Amazon DynamoDB using AWS DMS](#)
- [Migrate an Oracle partitioned table to PostgreSQL by using AWS DMS](#)
- [Migrate from Amazon RDS for Oracle to Amazon RDS for MySQL](#)
- [Migrate from IBM Db2 on Amazon EC2 to Aurora PostgreSQL-Compatible using AWS DMS and AWS SCT](#)
- [Migrate from Oracle 8i or 9i to Amazon RDS for PostgreSQL using SharePlex and AWS DMS](#)
- [Migrate from Oracle 8i or 9i to Amazon RDS for PostgreSQL using materialized views and AWS DMS](#)
- [Migrate from Oracle on Amazon EC2 to Amazon RDS for MySQL using AWS DMS and AWS SCT](#)
- [Migrate from Oracle to Amazon DocumentDB using AWS DMS](#)
- [Migrate an Oracle database from Amazon EC2 to Amazon RDS for MariaDB using AWS DMS and AWS SCT](#)

- [Migrate an on-premises Oracle database to Amazon RDS for MySQL using AWS DMS and AWS SCT](#)
- [Migrate an on-premises Oracle database to Amazon RDS for PostgreSQL by using an Oracle bystander and AWS DMS](#)
- [Migrate from Oracle Database to Amazon RDS for PostgreSQL by using Oracle GoldenGate](#)
- [Migrate an Oracle Database to Amazon Redshift using AWS DMS and AWS SCT](#)
- [Migrate an Oracle database to Aurora PostgreSQL using AWS DMS and AWS SCT](#)
- [Migrate data from an on-premises Oracle database to Aurora PostgreSQL](#)
- [Migrate from SAP ASE to Amazon RDS for SQL Server using AWS DMS](#)
- [Migrate an on-premises Microsoft SQL Server database to Amazon Redshift using AWS DMS](#)
- [Migrate an on-premises Microsoft SQL Server database to Amazon Redshift using AWS SCT data extraction agents](#)
- [Migrate a Teradata database to Amazon Redshift using AWS SCT data extraction agents](#)
- [Migrate an on-premises Vertica database to Amazon Redshift using AWS SCT data extraction agents](#)
- [Migrate legacy applications from Oracle Pro\\*C to ECPG](#)
- [Migrate virtual generated columns from Oracle to PostgreSQL](#)
- [Set up Oracle UTL\\_FILE functionality on Aurora PostgreSQL-Compatible](#)
- [Validate database objects after migrating from Oracle to Amazon Aurora PostgreSQL](#)

# Convert VARCHAR2(1) data type for Oracle to Boolean data type for Amazon Aurora PostgreSQL

Created by Naresh Damera (AWS)

<b>Environment:</b> PoC or pilot	<b>Source:</b> Oracle	<b>Target:</b> Amazon Aurora PostgreSQL
<b>R Type:</b> Re-architect	<b>Workload:</b> Oracle	<b>Technologies:</b> Migration ; DevelopmentAndTesting; Storage & backup; Databases
<b>AWS services:</b> Amazon Aurora; AWS DMS; Amazon RDS; AWS SCT		

## Summary

During a migration from Amazon Relational Database Service (Amazon RDS) for Oracle to Amazon Aurora PostgreSQL-Compatible Edition, you might encounter a data mismatch when validating the migration in Amazon Web Services (AWS) Database Migration Service (AWS DMS). To prevent this mismatch, you can convert VARCHAR2(1) data type to Boolean data type.

VARCHAR2 data type stores variable-length text strings, and VARCHAR2(1) indicates that the string is 1 character in length or 1 byte. For more information about VARCHAR2, see [Oracle built-in data types](#) (Oracle documentation).

In this pattern, in the sample source data table column, the VARCHAR2(1) data is either a **Y**, for *Yes*, or **N**, for *No*. This pattern includes instructions for using AWS DMS and AWS Schema Conversion Tool (AWS SCT) to convert this data type from the **Y** and **N** values in VARCHAR2(1) to **true** or **false** values in Boolean.

## Target audience

This pattern is recommended for those who have experience migrating Oracle databases to Aurora PostgreSQL-Compatible by using AWS DMS. As you complete the migration, adhere to the recommendations in [Converting Oracle to Amazon RDS for PostgreSQL or Amazon Aurora PostgreSQL](#) (AWS SCT documentation).

## Prerequisites and limitations

### Prerequisites

- An active AWS account.
- Confirm that your environment is prepared for Aurora, including setting up credentials, permissions, and a security group. For more information, see [Setting up your environment for Amazon Aurora](#) (Aurora documentation).
- A source Amazon RDS for Oracle database that contains a table column with VARCHAR2(1) data.
- A target Amazon Aurora PostgreSQL-Compatible database instance. For more information, see [Creating a database cluster and connecting to a database on an Aurora PostgreSQL database cluster](#) (Aurora documentation).

### Product versions

- Amazon RDS for Oracle version 12.1.0.2 or later.
- AWS DMS version 3.1.4 or later. For more information, see [Using an Oracle database as a source for AWS DMS](#) and [Using a PostgreSQL database as a target for AWS DMS](#) (AWS DMS documentation). We recommend that you use the latest version of AWS DMS for the most comprehensive version and feature support.
- AWS Schema Conversion Tool (AWS SCT) version 1.0.632 or later. We recommend that you use the latest version of AWS SCT for the most comprehensive version and feature support.
- Aurora supports the PostgreSQL versions listed in [Database Engine Versions for Aurora PostgreSQL-Compatible](#) (Aurora documentation).

## Architecture

### Source technology stack

Amazon RDS for Oracle database instance

### Target technology stack

Amazon Aurora PostgreSQL-Compatible database instance

### Source and target architecture

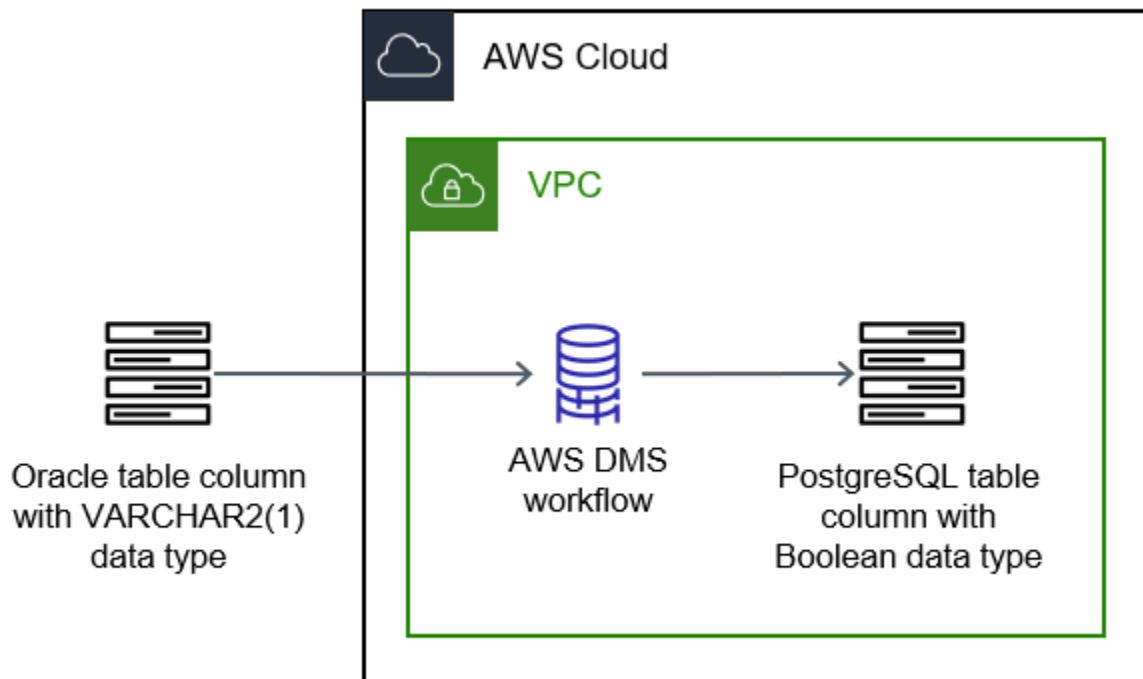

## Tools

### AWS services

- [Amazon Aurora PostgreSQL-Compatible Edition](#) is a fully managed, ACID-compliant relational database engine that helps you set up, operate, and scale PostgreSQL deployments.
- [AWS Database Migration Service \(AWS DMS\)](#) helps you migrate data stores into the AWS Cloud or between combinations of cloud and on-premises setups.
- [Amazon Relational Database Service \(Amazon RDS\) for Oracle](#) helps you set up, operate, and scale an Oracle relational database in the AWS Cloud.
- [AWS Schema Conversion Tool \(AWS SCT\)](#) supports heterogeneous database migrations by automatically converting the source database schema and a majority of the custom code to a format compatible with the target database.

### Other services

- [Oracle SQL Developer](#) is an integrated development environment that simplifies the development and management of Oracle databases in both traditional and cloud-based deployments.. In this pattern, you use this tool to connect to the Amazon RDS for Oracle database instance and query the data.

- [pgAdmin](#) is an open-source management tool for PostgreSQL. It provides a graphical interface that helps you create, maintain, and use database objects. In this pattern, you use this tool to connect to the Aurora database instance and query the data.

## Epics

### Prepare for the migration

Task	Description	Skills required
Create database migration report.	<ol style="list-style-type: none"> <li>1. In AWS SCT, create a database migration assessment report. For more information, see <a href="#">Creating migration assessment reports</a>.</li> <li>2. Review and perform the action items in the migration assessment report. For more information, see <a href="#">Assessment report action items</a>.</li> </ol>	DBA, Developer
Disable foreign key constraints on the target database.	<p>In PostgreSQL, foreign keys are implemented by using triggers. During the full load phase, AWS DMS loads each table one at a time. We strongly recommend that you disable foreign key constraints during a full load by using one of the following methods:</p> <ul style="list-style-type: none"> <li>• Temporarily disable all triggers from the instance, and finish the full load.</li> </ul>	DBA, Developer

Task	Description	Skills required
	<ul style="list-style-type: none"> <li>Use the <code>session_replication_role</code> parameter in PostgreSQL.</li> </ul> <p>If disabling foreign key constraints is not feasible, create an AWS DMS migration task for the primary data that is specific to the parent table and child table.</p>	
<p>Disable the primary keys and unique keys on the target database.</p>	<p>Using the following commands, disable the primary keys and constraints on the target database. This helps improve the performance of the initial load task.</p> <pre>ALTER TABLE &lt;table&gt; DISABLE PRIMARY KEY;</pre> <pre>ALTER TABLE &lt;table&gt; DISABLE CONSTRAINT &lt;constraint_name&gt;;</pre>	<p>DBA, Developer</p>
<p>Create the initial load task.</p>	<p>In AWS DMS, create the migration task for the initial load. For instructions, see <a href="#">Creating a task</a>. For the migration method, choose <b>Migrate existing data</b>. This migration method is called <code>Full Load</code> in the API. Do not start this task yet.</p>	<p>DBA, Developer</p>



Task	Description	Skills required
Edit task settings for the initial load task.	<p>Edit the task settings to add data validation. These validation settings must be created in a JSON file. For instructions and examples, see <a href="#">Specifying task settings</a>. Add the following validations:</p> <ul style="list-style-type: none"><li>• To validate that the VARCHAR2(1) data is accurately converted to Boolean in the target database, add the code in <i>Data validation script</i> in the <a href="#">Additional information</a> section of this pattern. The validation script converts the Boolean values of <b>1</b> to <b>Y</b> and <b>0</b> to <b>N</b> in the target table, and then it compares the values in the target table to the source table.</li></ul> <p>To validate the rest of the data migration, enable data validation in the task. For more information, see <a href="#">Data validation task settings</a>.</p>	AWS administrator, DBA

Task	Description	Skills required
Create the ongoing replication task.	In AWS DMS, create the migration task that keeps the target database in sync with the source database. For instructions, see <a href="#">Creating a task</a> . For the migration method, choose <b>Replicate data changes only</b> . Do not start this task yet.	DBA

## Test the migration tasks

Task	Description	Skills required
Create sample data for testing.	In the source database, create a sample table with data for testing purposes.	Developer
Confirm there are no conflicting activities.	Use the <code>pg_stat_activity</code> to check for any activity on the server that might affect the migration. For more information, see <a href="#">The Statistics Collector</a> (PostgreSQL documentation).	AWS administrator
Start the AWS DMS migration tasks.	In the AWS DMS console, on the <b>Dashboard</b> page, start the initial load and ongoing replication tasks that you created in the previous epic.	AWS administrator
Monitor the tasks and table load states.	During the migration, monitor the <a href="#">task status</a> and the <a href="#">table states</a> . When the initial load	AWS administrator

Task	Description	Skills required
	<p>task is complete, on the <b>Table statistics</b> tab:</p> <ul style="list-style-type: none"> <li>The <b>Load state</b> should be <b>Table completed</b>.</li> <li>The <b>Validation state</b> should be <b>Validated</b>.</li> </ul>	
Verify the migration results.	Using pgAdmin, query the table on target database. A successful query indicates that the data was migrated successfully.	Developer
Add primary keys and foreign keys on the target database.	Create the primary key and foreign key on the target database. For more information, see <a href="#">ALTER TABLE</a> (PostgreSQL website).	DBA
Clean up the test data.	On the source and target databases, clean up data that was created for unit testing.	Developer

## Cut over

Task	Description	Skills required
Complete the migration.	Repeat the previous epic, <i>Test the migration tasks</i> , using the real source data. This migrates the data from the source to the target database.	Developer
Validate that the source and target databases are in sync.	Validate that the source and target databases are in sync.	Developer

Task	Description	Skills required
	For more information and instructions, see <a href="#">AWS DMS data validation</a> .	
Stop the source database.	Stop the Amazon RDS for Oracle database. For instructions, see <a href="#">Stopping an Amazon RDS DB instance temporarily</a> . When you stop the source database, the initial load and ongoing replication tasks in AWS DMS are automatically stopped. No additional action is required to stop these tasks.	Developer

## Related resources

### AWS references

- [Migrate an Oracle database to Aurora PostgreSQL using AWS DMS and AWS SCT](#) (AWS Prescriptive Guidance)
- [Converting Oracle to Amazon RDS for PostgreSQL or Amazon Aurora PostgreSQL](#) (AWS SCT documentation)
- [How AWS DMS Works](#) (AWS DMS documentation)

### Other references

- [Boolean data type](#) (PostgreSQL documentation)
- [Oracle built-in data types](#) (Oracle documentation)
- [pgAdmin](#) (pgAdmin website)
- [SQL Developer](#) (Oracle website)

### Tutorial and videos

- [Getting Started with AWS DMS](#)
- [Getting Started With Amazon RDS](#)
- [Introduction to AWS DMS](#) (Video)
- [Understanding Amazon RDS](#) (Video)

## Additional information

### Data validation script

The following data validation script converts **1** to **Y** and **0** to **N**. This helps the AWS DMS task successfully complete and pass the table validation.

```
{
  "rule-type": "validation",
  "rule-id": "5",
  "rule-name": "5",
  "rule-target": "column",
  "object-locator": {
    "schema-name": "ADMIN",
    "table-name": "TEMP_CHRA_BOOL",
    "column-name": "GRADE"
  },
  "rule-action": "override-validation-function",
  "target-function": "case grade when '1' then 'Y' else 'N' end"
}
```

The case statement in the script performs the validation. If validation fails, AWS DMS inserts a record in the **public.awsdms\_validation\_failures\_v1** table on the target database instance. This record includes the table name, error time, and details about the mismatched values in the source and target tables.

If you do not add this data validation script to the AWS DMS task and the data is inserted in the target table, the AWS DMS task shows validation state as **Mismatched Records**.

During AWS SCT conversion, the AWS DMS migration task changes the data type of VARCHAR2(1) data type to Boolean and adds a primary key constraint on the "NO" column.

# Create application users and roles in Aurora PostgreSQL-Compatible

Created by Abhishek Verma (AWS)

<b>Environment:</b> PoC or pilot	<b>Source:</b> Any database	<b>Target:</b> PostgreSQL database
<b>R Type:</b> Re-architect	<b>Workload:</b> Open-source	<b>Technologies:</b> Migration; Databases
<b>AWS services:</b> Amazon RDS; Amazon Aurora		

## Summary

When you migrate to Amazon Aurora PostgreSQL-Compatible Edition, the database users and roles that exist on the source database must be created in the Aurora PostgreSQL-Compatible database. You can create the users and roles in Aurora PostgreSQL-Compatible by using two different approaches:

- Use similar users and roles in the target as in the source database. In this approach, the data definition languages (DDLs) are extracted for users and roles from the source database. Then they are transformed and applied to the target Aurora PostgreSQL-Compatible database. For example, the blog post [Use SQL to map users, roles, and grants from Oracle to PostgreSQL](#) covers using extraction from an Oracle source database engine.
- Use standardized users and roles that are commonly used during development, administration, and for performing other related operations in the database. This includes read-only, read/write, development, administration, and deployment operations performed by the respective users.

This pattern contains the grants required for users and roles creation in Aurora PostgreSQL-Compatible required for the standardized users and roles approach. The user and role creation steps are aligned to the security policy of granting least privilege to the database users. The following table lists the users, their corresponding roles, and their details on the database.

Users	Roles	Purpose
-------	-------	---------

APP_read	APP_RO	Used for read-only access on the schema APP
APP_WRITE	APP_RW	Used for the write and read operations on the schema APP
APP_dev_user	APP_DEV	Used for the development purpose on the schema APP_DEV, with read-only access on the schema APP
Admin_User	rds_superuser	Used for performing administrator operations on the database
APP	APP_DEP	Used for creating the objects under the APP schema and for deployment of objects in the APP schema

## Prerequisites and limitations

### Prerequisites

- An active Amazon Web Services (AWS) account
- A PostgreSQL database, Amazon Aurora PostgreSQL-Compatible Edition database, or Amazon Relational Database Service (Amazon RDS) for PostgreSQL database

### Product versions

- All versions of PostgreSQL

## Architecture

### Source technology stack

- Any database

## Target technology stack

- Amazon Aurora PostgreSQL-Compatible

## Target architecture

The following diagram shows user roles and the schema architecture in the Aurora PostgreSQL-Compatible database.

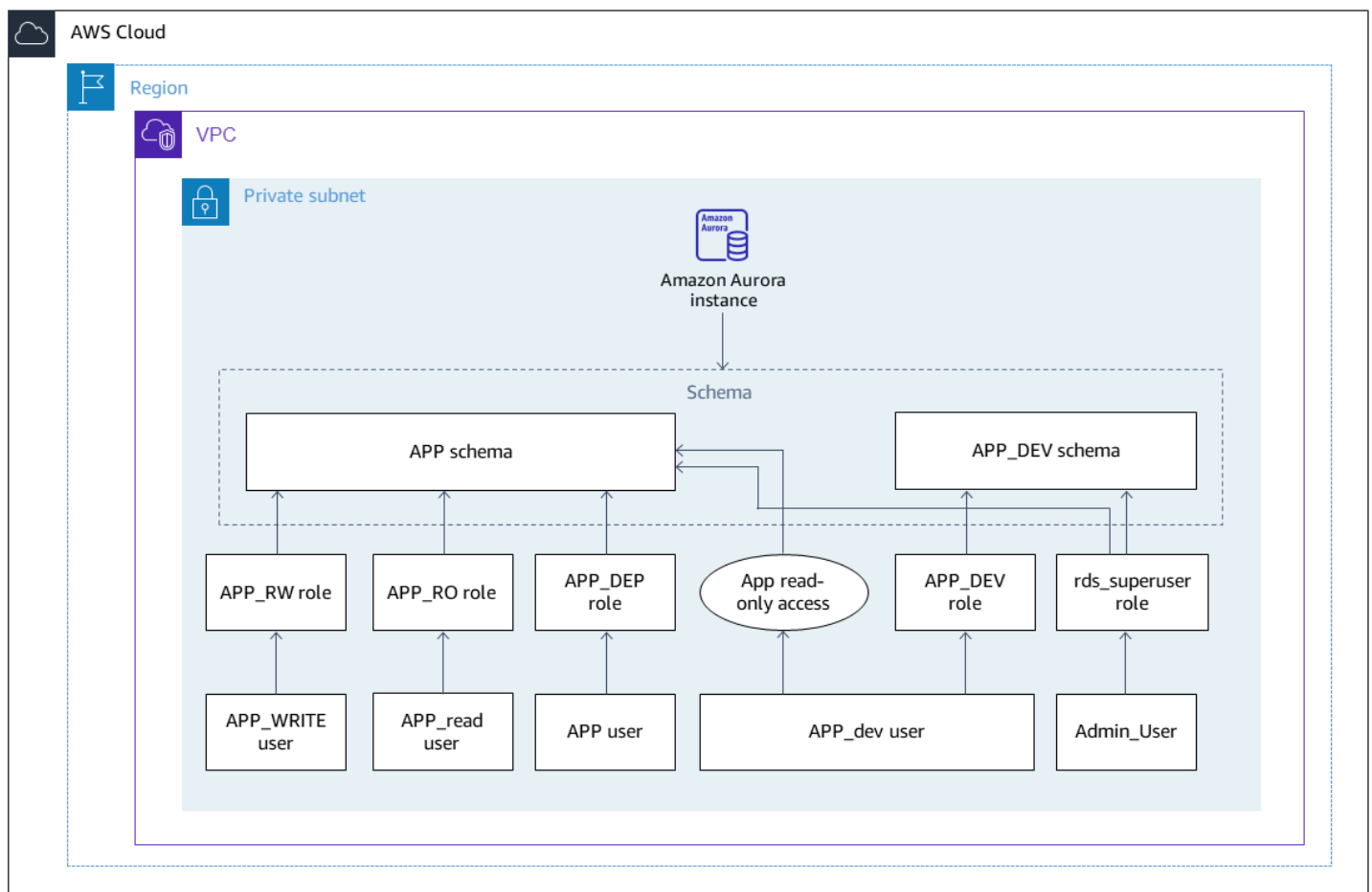

## Automation and scale

This pattern contains the users, roles, and schema creation script, which you can run multiple times without any impact to existing users of the source or target database.



## Tools

### AWS services

- [Amazon Aurora PostgreSQL-Compatible Edition](#) is a fully managed, ACID-compliant relational database engine that helps you set up, operate, and scale PostgreSQL deployments.

### Other services

- [psql](#) is a terminal-based front-end tool that is installed with every PostgreSQL Database installation. It has a command line interface for running SQL, PL-PGSQL, and operating system commands.
- [pgAdmin](#) is an open-source management tool for PostgreSQL. It provides a graphical interface that helps you create, maintain, and use database objects.

## Epics

### Create the users and roles

Task	Description	Skills required
Create the deployment user.	<p>The deployment user APP will be used to create and modify the database objects during deployments. Use the following scripts to create the deployment user role APP_DEP in the schema APP. Validate access rights to make sure this user has only the privilege to create objects in the required schema APP.</p> <ol style="list-style-type: none"><li>1. Connect to the admin user, and create the schema.</li></ol> <pre>CREATE SCHEMA APP;</pre>	DBA

Task	Description	Skills required
	<p>2. Create the user.</p> <pre>CREATE USER APP WITH PASSWORD &lt;password &gt; ;</pre> <p>3. Create the role.</p> <pre>CREATE ROLE APP_DEP ; GRANT all on schema APP to APP_DEP ; GRANT USAGE ON SCHEMA APP to APP_DEP ; GRANT connect on database &lt;db_name&gt; to APP_DEP ; GRANT APP_DEP to APP;</pre> <p>4. To test the privileges, connect to APP and create the tables.</p> <pre>set search_path to APP; SET CREATE TABLE test(id integer ) ; CREATE TABLE</pre> <p>5. Check the privileges.</p> <pre>select schemaname , tablename , tableowner r from pg_tables where tablename like 'test' ; schemaname   tablename   tableowner</pre>	

Task	Description	Skills required
	<pre>APP   test   APP</pre>	

Task	Description	Skills required
Create the read-only user.	<p>The read-only user APP_read will be used for performing the read-only operation in the schema APP. Use the following scripts to create the read-only user. Validate access rights to make sure that this user has privilege only to read the objects in the schema APP and for automatically granting read access for any new objects created in the schema APP.</p> <ol style="list-style-type: none"><li>1. Create the user APP_read.</li></ol> <pre data-bbox="634 953 1029 1150">create user APP_read ; alter user APP_read with password 'your_password' ;</pre> <ol style="list-style-type: none"><li>2. Create the role.</li></ol> <pre data-bbox="634 1241 1029 1717">CREATE ROLE APP_ro ; GRANT SELECT ON ALL TABLES IN SCHEMA APP TO APP_RO ; GRANT USAGE ON SCHEMA APP TO APP_RO GRANT CONNECT ON DATABASE testdb TO APP_RO ; GRANT APP_RO TO APP_read;</pre> <ol style="list-style-type: none"><li>3. To test the privileges, log in using the APP_read user.</li></ol>	DBA

Task	Description	Skills required
	<pre>set search_path to APP ; create table test1( id integer) ; ERROR: permission denied for schema APP LINE 1: create table test1( id integer) ; insert into test values (34) ; ERROR: permission denied for table test SQL state: 42501 select from test no rows selected</pre>	

Task	Description	Skills required
Create the read/write user.	<p>The read/write user <code>APP_WRITE</code> will be used to perform read and write operations on the schema <code>APP</code>. Use the following scripts to create the read/write user and grant it the <code>APP_RW</code> role. Validate access rights to make sure that this user has read and write privileges only on the objects in the schema <code>APP</code> and for automatically granting read and write access for any new object created in schema <code>APP</code>.</p> <ol style="list-style-type: none"><li>1. Create the user.</li></ol> <pre data-bbox="630 1045 1029 1289">CREATE USER APP_WRITE ; alter user APP_WRITE with password 'your_password' ;</pre> <ol style="list-style-type: none"><li>2. Create the role.</li></ol> <pre data-bbox="630 1373 1029 1787">CREATE ROLE APP_RW; GRANT SELECT, INSERT, UPDATE, DELETE ON ALL TABLES IN SCHEMA APP TO APP_RW ; GRANT CONNECT ON DATABASE postgres to APP_RW ; GRANT USAGE ON SCHEMA APP to APP_RW ;</pre>	

Task	Description	Skills required
	<pre>ALTER DEFAULT PRIVILEGES IN SCHEMA APP GRANT SELECT, INSERT, UPDATE, DELETE ON TABLES TO APP_RW ; GRANT APP_RW to APP_WRITE</pre> <p data-bbox="591 558 993 688">3. To test the privileges, log in using the APP_WRITE user.</p> <pre>SET SEARCH_PATH to APP; CREATE TABLE test1( id integer) ; ERROR: permission denied for schema APP LINE 1: create table test1( id integer) ; SELECT * FROM test ; id ---- 12 INSERT INTO test values (31) ; INSERT 0 1</pre>	

Task	Description	Skills required
Create the admin user.	<p>The admin user <code>Admin_User</code> will be used to perform admin operations on the database. Examples of these operations are <code>CREATE ROLE</code> and <code>CREATE DATABASE</code>. <code>Admin_User</code> uses the built-in role <code>rds_superuser</code> to perform admin operations on the database. Use the following scripts to create and test the privilege for the admin user <code>Admin_User</code> in the database.</p> <ol style="list-style-type: none"><li>1. Create the user and grant the role.</li></ol> <pre data-bbox="634 1052 1029 1367">create user Admin_User WITH PASSWORD 'Your password' ALTER user Admin_user CREATEDB; ALTER user Admin_user CREATEROLE;</pre> <ol style="list-style-type: none"><li>2. To test the privilege, log in from the <code>Admin_User</code> user.</li></ol> <pre data-bbox="634 1556 1029 1803">SELECT * FROM APP.test ; id ---- 31 CREATE ROLE TEST ;</pre>	DBA



Task	Description	Skills required
	<pre>CREATE DATABASE test123 ;</pre>	

Task	Description	Skills required
Create the development user.	<p>The development user <code>APP_dev_user</code> will have rights to create the objects in its local schema <code>APP_DEV</code> and read access in the schema <code>APP</code>. Use the following scripts to create and test the privileges of the user <code>APP_dev_user</code> in the database.</p> <ol style="list-style-type: none"><li>1. Create the user.</li></ol> <pre data-bbox="630 810 1029 968">CREATE USER APP1_dev_user with password 'your password';</pre> <ol style="list-style-type: none"><li>2. Create the <code>APP_DEV</code> schema for the <code>App_dev_user</code>.</li></ol> <pre data-bbox="630 1157 1029 1272">CREATE SCHEMA APP1_DEV ;</pre> <ol style="list-style-type: none"><li>3. Create the <code>APP_DEV</code> role.</li></ol> <pre data-bbox="630 1367 1029 1873">CREATE ROLE APP1_DEV ; GRANT APP1_R0 to APP1_DEV ; GRANT SELECT ON ALL TABLES IN SCHEMA APP1_DEV to APP1_dev_user GRANT USAGE, CREATE ON SCHEMA APP1_DEV to APP1_DEV_USER GRANT APP1_DEV to APP1_DEV_USER ;</pre>	DBA

Task	Description	Skills required
	<p>4. To test the privileges, log in from APP_dev_user .</p> <pre data-bbox="630 331 1029 968">CREATE TABLE APP1_dev.test1( id integer ); CREATE TABLE INSERT into APP1_dev.test1 ( select * from APP1.test ); INSERT 0 1 CREATE TABLE APP1.test4 ( id int) ; ERROR:  permission denied for schema APP1 LINE 1: create table APP1.test4 ( id int) ;</pre>	

## Related resources

### PostgreSQL documentation

- [CREATE ROLE](#)
- [CREATE USER](#)
- [Predefined Roles](#)

## Additional information

### PostgreSQL 14 enhancement

PostgreSQL 14 provides a set of predefined roles that give access to certain commonly needed, privileged capabilities and information. Administrators (including roles that have the CREATE ROLE privilege) can grant these roles or other roles in their environment to users, providing them with access to the specified capabilities and information.

Administrators can grant users access to these roles using the GRANT command. For example, to grant the `pg_signal_backend` role to `Admin_User1`, you can run the following command.

```
GRANT pg_signal_backend TO Admin_User1;
```

The `pg_signal_backend` role is intended to allow administrators to enable trusted, non-superuser roles to send signals to other backends. For more information, see [PostgreSQL 14 enhancement](#).

### **Fine-tuning access**

In some cases, it might be necessary to provide more granular access to the users (for example, table-based access or column-based access). In such cases, additional roles can be created to grant those privileges to the users. For more information, see [PostgreSQL Grants](#).

# Emulate Oracle DR by using a PostgreSQL-compatible Aurora global database

Created by HariKrishna Boorgadda (AWS)

<b>Environment:</b> PoC or pilot	<b>Source:</b> Oracle	<b>Target:</b> Aurora PostgreSQL
<b>R Type:</b> Re-architect	<b>Workload:</b> Oracle	<b>Technologies:</b> Migration; Modernization; Databases
<b>AWS services:</b> Amazon Aurora		

## Summary

Best practices for Enterprise disaster recovery (DR) basically consist of designing and implementing fault-tolerant hardware and software systems that can survive a disaster (*business continuance*) and resume normal operations (*business resumption*), with minimal intervention and, ideally, with no data loss. Building fault-tolerant environments to satisfy Enterprise DR objectives can be expensive and time consuming and requires a strong commitment by the business.

Oracle Database provides three different approaches to DR that provide the highest level of data protection and availability compared to any other approach for protecting Oracle data.

- Oracle Zero Data Loss Recovery Appliance
- Oracle Active Data Guard
- Oracle GoldenGate

This pattern provides a way to emulate the Oracle GoldenGate DR by using an Amazon Aurora global database. The reference architecture uses Oracle GoldenGate for DR across three AWS Regions. The pattern walks through the replatforming of the source architecture to the cloud-native Aurora global database based on Amazon Aurora PostgreSQL-Compatible Edition.

Aurora global databases are designed for applications with a global footprint. A single Aurora database spans multiple AWS Regions with as many as five secondary Regions. Aurora global databases provide the following features:

- Physical storage-level replication
- Low-latency global reads
- Fast disaster recovery from Region-wide outages
- Fast cross-Region migrations
- Low replication lag across Regions
- Little-to-no performance impact on your database

For more information about Aurora global database features and advantages, see [Using Amazon Aurora global databases](#). For more information about unplanned and managed failovers, see [Using failover in an Amazon Aurora global database](#).

## Prerequisites and limitations

### Prerequisites

- An active AWS account
- A Java Database Connectivity (JDBC) PostgreSQL driver for application connectivity
- An Aurora global database based on Amazon Aurora PostgreSQL-Compatible Edition
- An Oracle Real Application Clusters (RAC) database migrated to the Aurora global database based on Aurora PostgreSQL-Compatible

### Limitations of Aurora global databases

- Aurora global databases aren't available in all AWS Regions. For a list of supported Regions, see [Aurora global databases with Aurora PostgreSQL](#).
- For information about features that aren't supported and other limitations of Aurora global databases, see the [Limitations of Amazon Aurora global databases](#).

### Product versions

- Amazon Aurora PostgreSQL-Compatible Edition version 10.14 or later

## Architecture

### Source technology stack

- Oracle RAC four-node database
- Oracle GoldenGate

## Source architecture

The following diagram shows three clusters with four-node Oracle RAC in different AWS Regions replicated using Oracle GoldenGate.

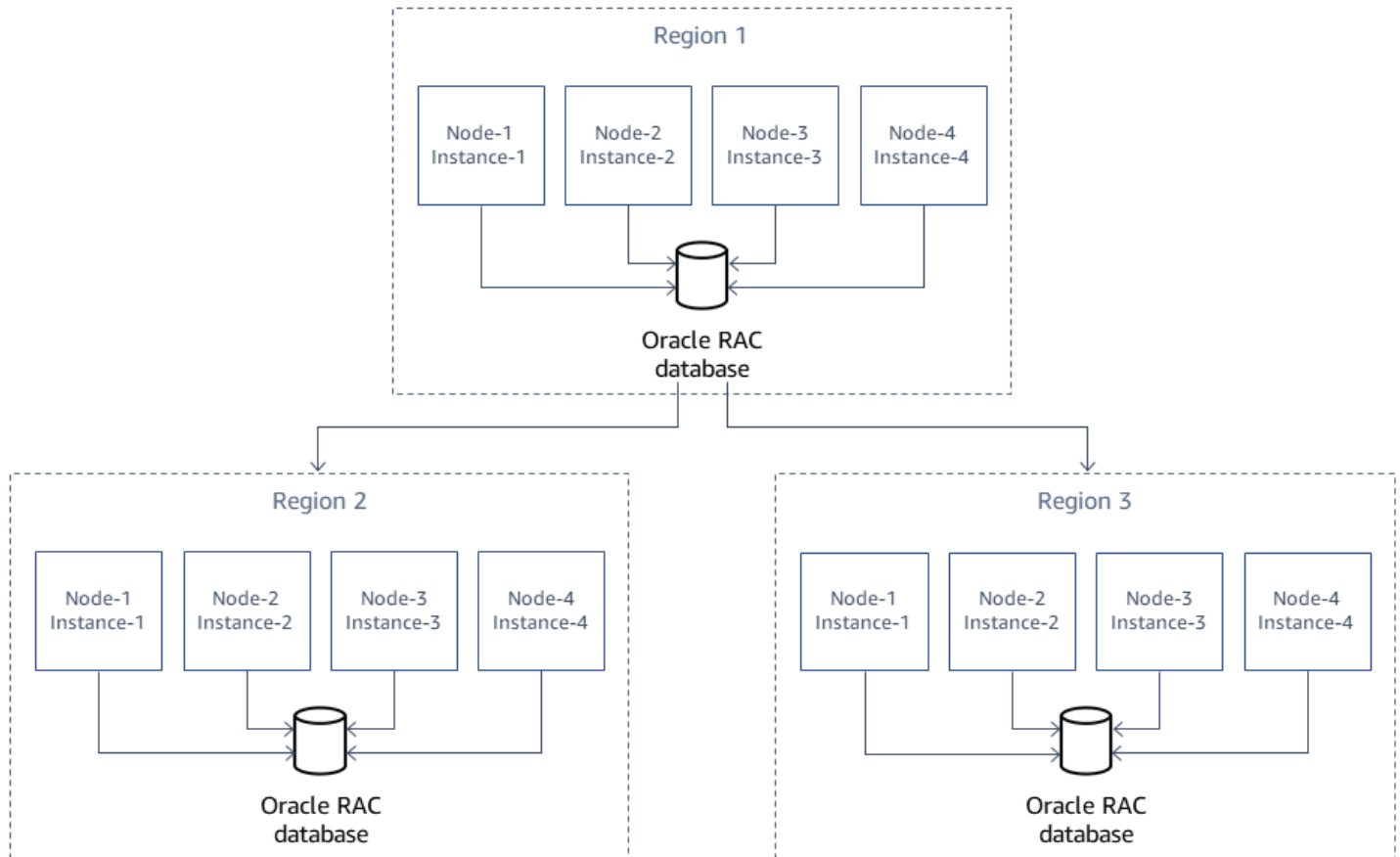

## Target technology stack

- A three-cluster Amazon Aurora global database based on Aurora PostgreSQL–Compatible, with one cluster in the primary Region, two clusters in different secondary Regions

## Target architecture

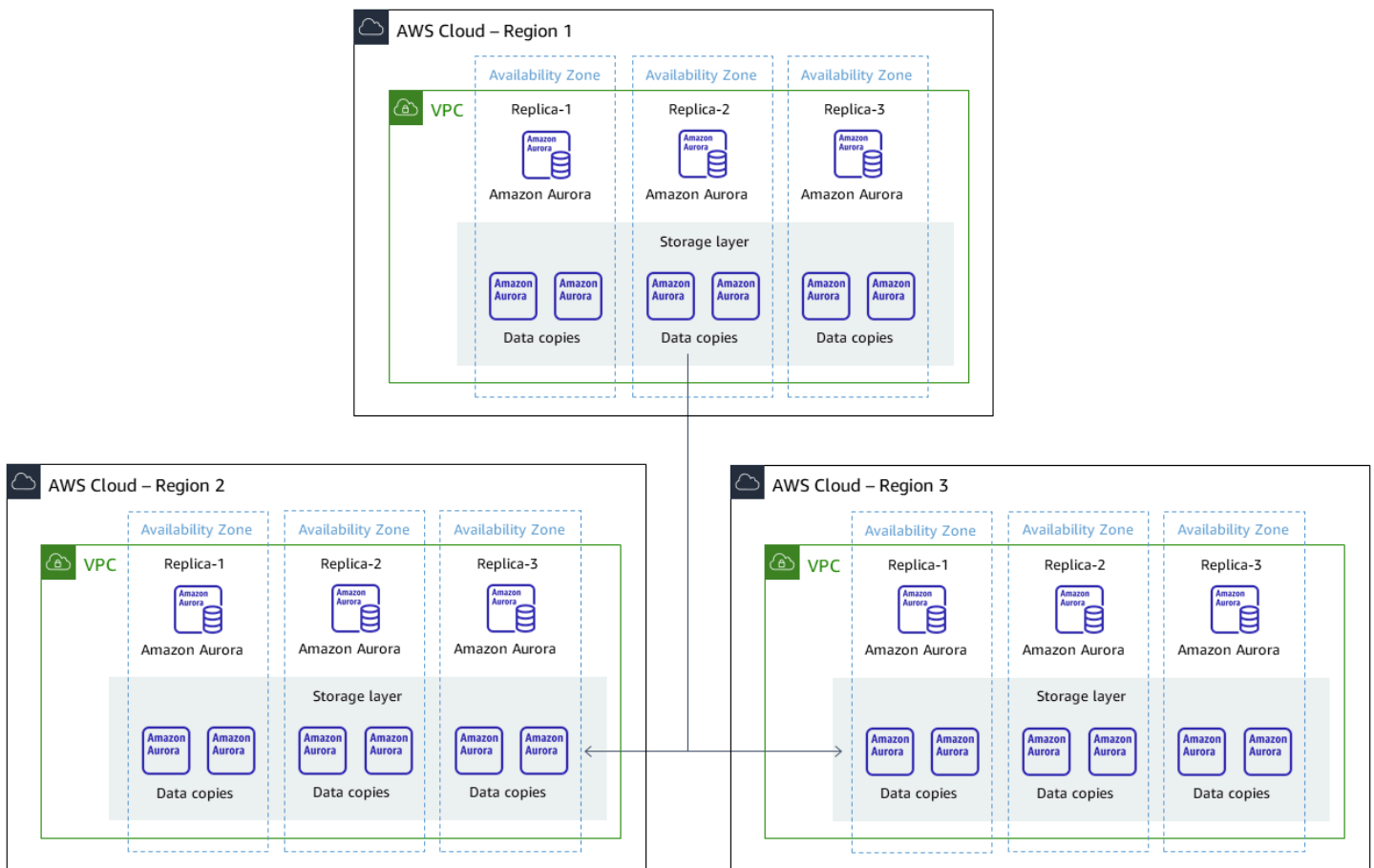

## Tools

### AWS services

- [Amazon Aurora PostgreSQL-Compatible Edition](#) is a fully managed, ACID-compliant relational database engine that helps you set up, operate, and scale PostgreSQL deployments.
- [Amazon Aurora global databases](#) span multiple AWS Regions, providing low latency global reads and fast recovery from the rare outage that might affect an entire AWS Region.

## Epics

### Add Regions with reader DB instances

Task	Description	Skills required
Attach one or more secondary Aurora clusters.	On the AWS Management Console, choose Amazon	DBA



Task	Description	Skills required
	Aurora. Select the primary cluster, choose <b>Actions</b> , and choose <b>Add region</b> from the dropdown list.	
Select the instance class.	You can change the instance class of the secondary cluster. However, we recommend keeping it the same as the primary cluster instance class.	DBA
Add the third Region.	Repeat the steps in this epic to add a cluster in the third Region.	DBA

## Fail over the Aurora global database

Task	Description	Skills required
Remove the primary cluster from the Aurora global database.	<ol style="list-style-type: none"> <li>On the Databases page, choose the primary cluster.</li> <li>Choose <b>Remove from Global</b> to fail over to a secondary cluster.</li> </ol>	DBA
Reconfigure your application to divert write traffic to the newly promoted cluster.	Modify the endpoint in the application with that of the newly promoted cluster.	DBA
Stop issuing any write operations to the unavailable cluster.	Stop the application and any data manipulation language (DML) activity to the cluster that you removed.	DBA
Create a new Aurora global database.	Now you can create an Aurora global database with the	DBA

Task	Description	Skills required
	newly promoted cluster as the primary cluster.	

## Start the primary cluster

Task	Description	Skills required
Select the primary cluster to be started from the global database.	On the Amazon Aurora console, in the Global Database setup, choose the primary cluster.	DBA
Start the cluster.	On the <b>Actions</b> dropdown list, choose <b>Start</b> . This process might take some time. Refresh the screen to see the status, or check the <b>Status</b> column for the current state of the cluster after the operation is completed.	DBA

## Clean up the resources

Task	Description	Skills required
Delete the remaining secondary clusters.	After the failover pilot is completed, remove the secondary clusters from the global database.	DBA
Delete the primary cluster.	Remove the cluster.	DBA

## Related resources

- [Using Amazon Aurora global databases](#)
- [Aurora PostgreSQL Disaster Recovery solutions using Amazon Aurora Global Database \(blog post\)](#)

# Incrementally migrate from Amazon RDS for Oracle to Amazon RDS for PostgreSQL using Oracle SQL Developer and AWS SCT

*Created by Pinesh Singal (AWS)*

<b>Environment:</b> PoC or pilot	<b>Source:</b> Amazon RDS for Oracle	<b>Target:</b> Amazon RDS for PostgreSQL
<b>R Type:</b> Re-architect	<b>Workload:</b> Oracle	<b>Technologies:</b> Migration; Databases; Modernization
<b>AWS services:</b> Amazon EC2; Amazon RDS		

## Summary

Many migration strategies and approaches run in multiple phases that can last from a few weeks to several months. During this time, you can experience delays because of patching or upgrades in the source Oracle DB instances that you want to migrate to PostgreSQL DB instances. To avoid this situation, we recommend that you incrementally migrate the remaining Oracle database code to PostgreSQL database code.

This pattern provides an incremental migration strategy with no downtime for a multi-terabyte Oracle DB instance that has a high number of transactions performed after your initial migration and that must be migrated to a PostgreSQL database. You can use this pattern's step-by-step approach to incrementally migrate an Amazon Relational Database Service (Amazon RDS) for Oracle DB instance to an Amazon RDS for PostgreSQL DB instance without signing in to the Amazon Web Services (AWS) Management Console.

The pattern uses [Oracle SQL Developer](#) to find the differences between two schemas in the source Oracle database. You then use AWS Schema Conversion Tool (AWS SCT) to convert the Amazon RDS for Oracle database schema objects to Amazon RDS for PostgreSQL database schema objects. You can then run a Python script in the Windows Command Prompt to create AWS SCT objects for the incremental changes to the source database objects.

**Note:** Before you migrate your production workloads, we recommend that you run a proof of concept (PoC) for this pattern's approach in a testing or non-production environment.

## Prerequisites and limitations

### Prerequisites

- An active AWS account.
- An existing Amazon RDS for Oracle DB instance.
- An existing Amazon RDS for PostgreSQL DB instance.
- AWS SCT, installed and configured with JDBC drivers for Oracle and PostgreSQL database engines. For more information about this, see [Installing AWS SCT](#) and [Installing the required database drivers](#) in the AWS SCT documentation.
- Oracle SQL Developer, installed and configured. For more information about this, see the [Oracle SQL Developer](#) documentation.
- The `incremental-migration-sct-sql.zip` file (attached), downloaded to your local computer.

### Limitations

- The minimum requirements for your source Amazon RDS for Oracle DB instance are:
  - Oracle versions 10.2 and later (for versions 10.x), 11g (versions 11.2.0.3.v1 and later) and up to 12.2, and 18c for the Enterprise, Standard, Standard One, and Standard Two editions
- The minimum requirements for your target Amazon RDS for PostgreSQL DB instance are:
  - PostgreSQL versions 9.4 and later (for versions 9.x), 10.x, and 11.x
- This pattern uses Oracle SQL Developer. Your results might vary if you use other tools to find and export schema differences.
- The [SQL scripts](#) generated by Oracle SQL Developer can raise transformation errors, which means that you need to perform a manual migration.
- If the AWS SCT source and target test connections fail, make sure that you configure the JDBC driver versions and inbound rules for the virtual private cloud (VPC) security group to accept incoming traffic.

### Product versions

- Amazon RDS for Oracle DB instance version 12.1.0.2 (version 10.2 and later)
- Amazon RDS for PostgreSQL DB instance version 11.5 (version 9.4 and later)

- Oracle SQL Developer version 19.1 and later
- AWS SCT version 1.0.632 and later

## Architecture

### Source technology stack

- Amazon RDS for Oracle DB instance

### Target technology stack

- Amazon RDS for PostgreSQL DB instance

### Source and target architecture

The following diagram shows the migration of an Amazon RDS for Oracle DB instance to an Amazon RDS for PostgreSQL DB instance.

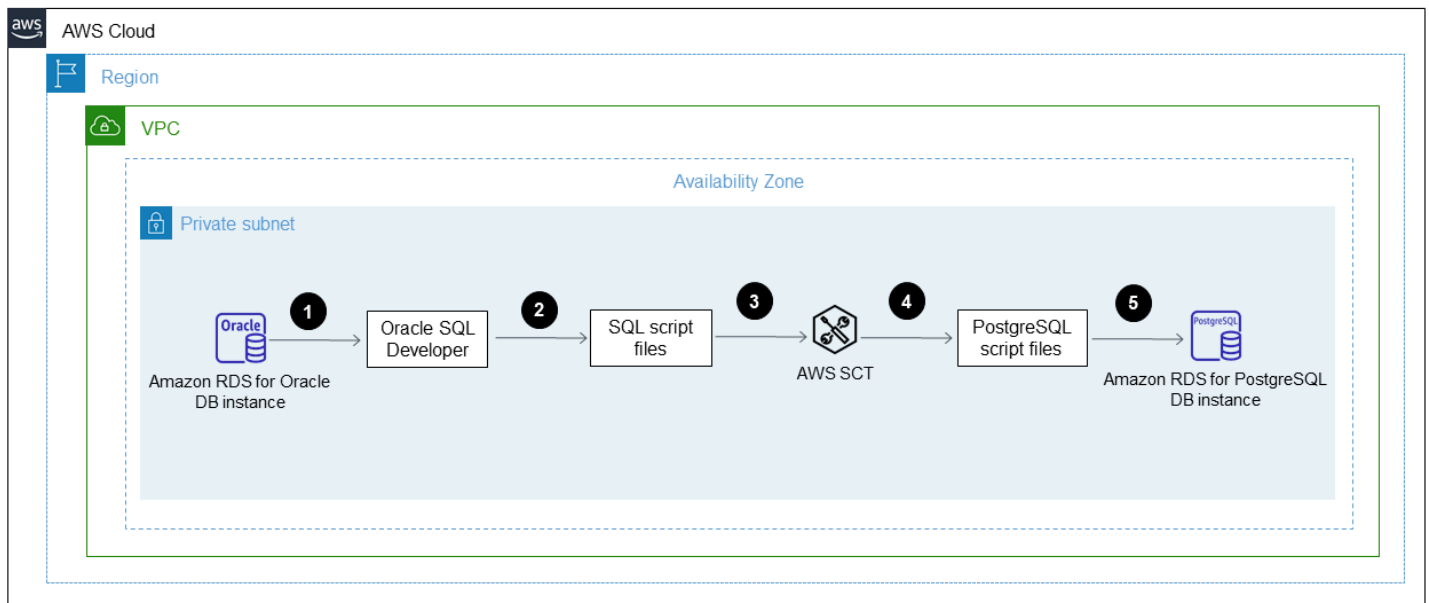

The diagram shows the following migration workflow:

1. Open Oracle SQL Developer and connect to the source and target databases.
2. Generate a [diff report](#) and then generate the SQL scripts file for the schema difference objects. For more information about diff reports, see [Detailed diff reports](#) in the Oracle documentation.

3. Configure AWS SCT and run the Python code.
4. The SQL scripts file converts from Oracle to PostgreSQL.
5. Run the SQL scripts file on the target PostgreSQL DB instance.

## Automation and scale

You can automate this migration by adding additional parameters and security-related changes for multiple functionalities in a single program to your Python script.

## Tools

- [AWS SCT](#) – AWS Schema Conversion Tool (AWS SCT) converts your existing database schema from one database engine to another.
- [Oracle SQL Developer](#) – Oracle SQL Developer is an integrated development environment (IDE) that simplifies the development and management of Oracle databases in both traditional and cloud-based deployments.

## Code

The `incremental-migration-sct-sql.zip` file (attached) contains the complete source code for this pattern.

## Epics

### Create the SQL scripts file for the source database schema differences

Task	Description	Skills required
Run Database Diff in Oracle SQL Developer.	<ol style="list-style-type: none"><li>1. Sign in to your source Oracle DB instance, choose <b>Tools</b>, and then choose <b>Database Diff</b>.</li><li>2. Choose your source database in <b>Source Connection</b>.</li></ol>	DBA

Task	Description	Skills required
	<ol style="list-style-type: none"> <li>Choose the updated or patched source database in <b>Destination Connection</b>.</li> <li>Configure the remaining options according to your requirements, choose <b>Next</b>, and then choose <b>Finish</b> to generate the diff report.</li> </ol>	
Generate the SQL scripts file.	<p>Choose <b>Generate Script</b> to generate the differences in the SQL files.</p> <p>This generates the SQL scripts file that AWS SCT uses to convert your database from Oracle to PostgreSQL.</p>	DBA

### Use the Python script to create the target DB objects in AWS SCT

Task	Description	Skills required
Configure AWS SCT with the Windows Command Prompt.	<ol style="list-style-type: none"> <li>Copy the <code>AWSSchemaConversionToolBatch.jar</code> file from your pre-installed AWS SCT folder and paste it into your working directory.</li> <li>Deploy the Python code from the <code>run_aws_sct_sql.py</code> file from the <code>incremental-migration-sct-sql.zip</code> folder (attached</li> </ol>	DBA



Task	Description	Skills required
	<p>           ). This creates .xml files and .sct files in the projects directory with your source and target database environment configuration details. It also reads the SQL scripts file that you generated in Oracle SQL Developer . Finally, it creates .sql file objects in the output directory.         </p> <p>           3. Configure the source and target environment configuration details in the database_migration .txt file by using the following format:         </p> <pre data-bbox="609 1144 1031 1871"> #source_vendor,source_hostname,source_dbname,source_user,source_pwd,source_schema,source_port,source_sid,target_vendor,target_hostname,target_user,target_pwd,target_dbname,target_port  ORACLE,myoracledb.cokmvis0v46q.us-east-1.rds.amazonaws.com,ORCL,orcl,orcl1234,orcl,1521,ORCL,POSTGRESQL,mypgdbinstance.cokmvis0v46 </pre>	

Task	Description	Skills required
	<pre>q.us-east-1.rds.amazonaws.com,pguser,pgpassword,pgdb,5432</pre> <p>4. Modify the AWS SCT configuration parameters according to your requirements and then copy the SQL scripts file into your working directory in the input subdirectory.</p>	
Run the Python script.	<ol style="list-style-type: none"> <li>1. Run the Python script by using the following command: <code>\$ python run_aws_sct_sql.py database_migration.txt</code></li> <li>2. This creates the DB objects SQL file. Non-converted codes with transformation errors can be manually converted.</li> </ol>	DBA
Create the objects in Amazon RDS for PostgreSQL	Run the SQL files and create objects in your Amazon RDS for PostgreSQL DB instance.	DBA

## Related resources

- [Oracle on Amazon RDS](#)
- [PostgreSQL on Amazon RDS](#)
- [Using the AWS SCT user interface](#)
- [Using Oracle as a source for AWS SCT](#)

## Attachments

To access additional content that is associated with this document, unzip the following file:  
[attachment.zip](#)

# Load BLOB files into TEXT by using file encoding in Aurora PostgreSQL-Compatible

Created by *Bhanu Ganesh Gudivada (AWS)* and *Jeevan Shetty (AWS)*

<b>Environment:</b> Production	<b>Source:</b> On-premises Oracle Database	<b>Target:</b> Aurora PostgreSQL-Compatible
<b>R Type:</b> Re-architect	<b>Workload:</b> Oracle; Open-source	<b>Technologies:</b> Migration; Databases

**AWS services:** Amazon Aurora

## Summary

Often during migration, there are cases where you have to process unstructured and structured data that is loaded from files on a local file system. The data might also be in a character set that differs from the database character set.

These files hold the following types of data:

- **Metadata** – This data describes the file structure.
- **Semi-structured data** – These are textual strings in a specific format, such as JSON or XML. You might be able to make assertions about such data, such as "will always start with '<' " or "does not contain any newline characters."
- **Full text** – This data usually contains all types of characters, including newline and quote characters. It might also consist of multibyte characters in UTF-8.
- **Binary data** – This data might contain bytes or combinations of bytes including, nulls and end-of-file markers.

Loading a mixture of these types of data can be a challenge.

The pattern can be used with on-premises Oracle databases , Oracle databases that are on Amazon Elastic Compute Cloud (Amazon EC2) instances on the Amazon Web Services (AWS) Cloud, and

Amazon Relational Database Service (Amazon RDS) for Oracle databases. As an example, this pattern is using Amazon Aurora PostgreSQL-Compatible Edition.

In Oracle Database, with the help of a BFILE (binary file) pointer, the DBMS\_LOB package, and Oracle system functions, you can load from file and convert to CLOB with character encoding. Because PostgreSQL does not support the BLOB data type when migrating to an Amazon Aurora PostgreSQL-Compatible Edition database, these functions must be converted to PostgreSQL-compatible scripts.

This pattern provides two approaches for loading a file into a single database column in an Amazon Aurora PostgreSQL-Compatible database:

- Approach 1 – You import data from your Amazon Simple Storage Service (Amazon S3) bucket by using the `table_import_from_s3` function of the `aws_s3` extension with the `encode` option.
- Approach 2 – You encode to hexadecimal outside of the database, and then you decode to view TEXT inside the database.

We recommend using Approach 1 because Aurora PostgreSQL-Compatible has direct integration with the `aws_s3` extension.

This pattern uses the example of loading a flat file that contains an email template, which has multibyte characters and distinct formatting, into an Amazon Aurora PostgreSQL-Compatible database.

## Prerequisites and limitations

### Prerequisites

- An active AWS account
- An Amazon RDS instance or an Aurora PostgreSQL-Compatible instance
- A basic understanding of SQL and Relational Database Management System (RDBMS)
- An Amazon Simple Storage Service (Amazon S3) bucket.
- Knowledge of system functions in Oracle and PostgreSQL
- RPM Package HexDump-XXD-0.1.1 (included with Amazon Linux 2)

**Note:** Amazon Linux 2 is nearing end of support. For more information, see the [Amazon Linux 2 FAQs](#).

## Limitations

- For the TEXT data type, the longest possible character string that can be stored is about 1 GB.

## Product versions

- Aurora supports the PostgreSQL versions listed in [Amazon Aurora PostgreSQL updates](#).

## Architecture

### Target technology stack

- Aurora PostgreSQL-Compatible

### Target architecture

#### Approach 1 – Using `aws_s3.table_import_from_s3`

From an on-premises server, a file containing an email template with multibyte characters and custom formatting is transferred to Amazon S3. The custom database function provided by this pattern uses the `aws_s3.table_import_from_s3` function with `file_encoding` to load files into the database and return query results as the TEXT data type.

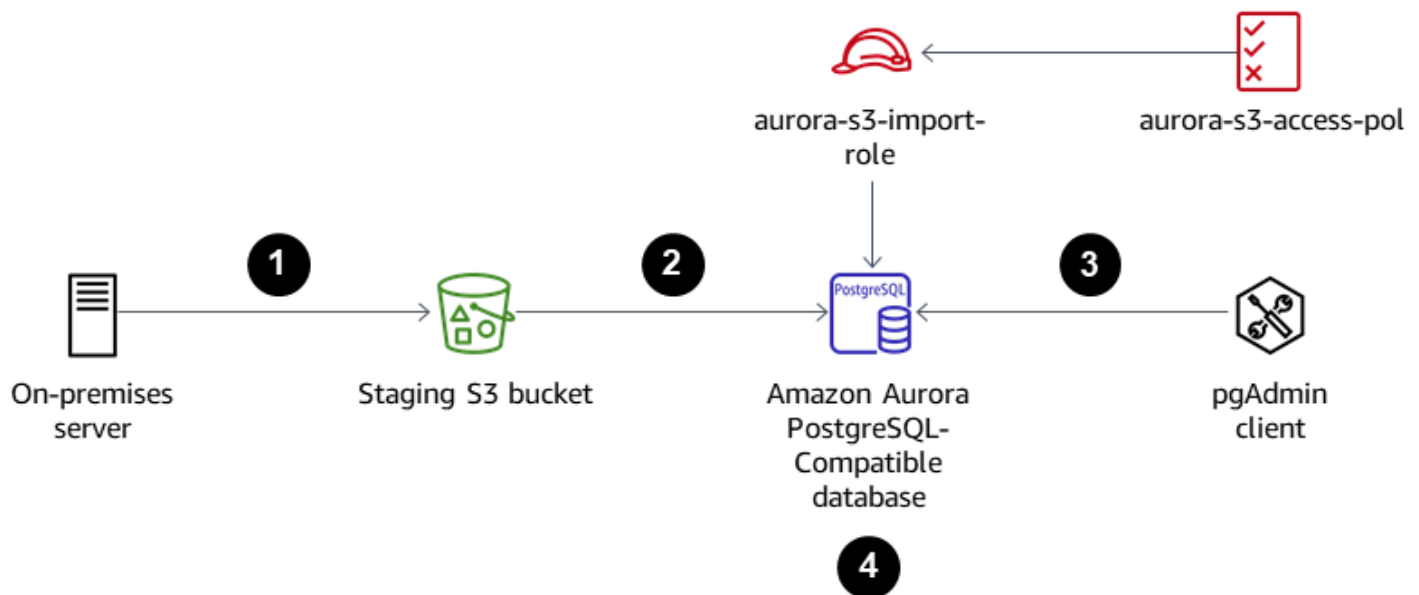

- Files are transferred to the staging S3 bucket.

- Files are uploaded to the Amazon Aurora PostgreSQL-Compatible database.
- Using the pgAdmin client, the custom function `load_file_into_clob` is deployed to the Aurora database.
- The custom function internally uses `table_import_from_s3` with `file_encoding`. The output from the function is obtained by using `array_to_string` and `array_agg` as TEXT output.

### *Approach 2 – Encoding to hexadecimal outside of the database and decoding to view TEXT inside the database*

A file from an on-premises server or a local file system is converted into a hex dump. Then the file is imported into PostgreSQL as a TEXT field.

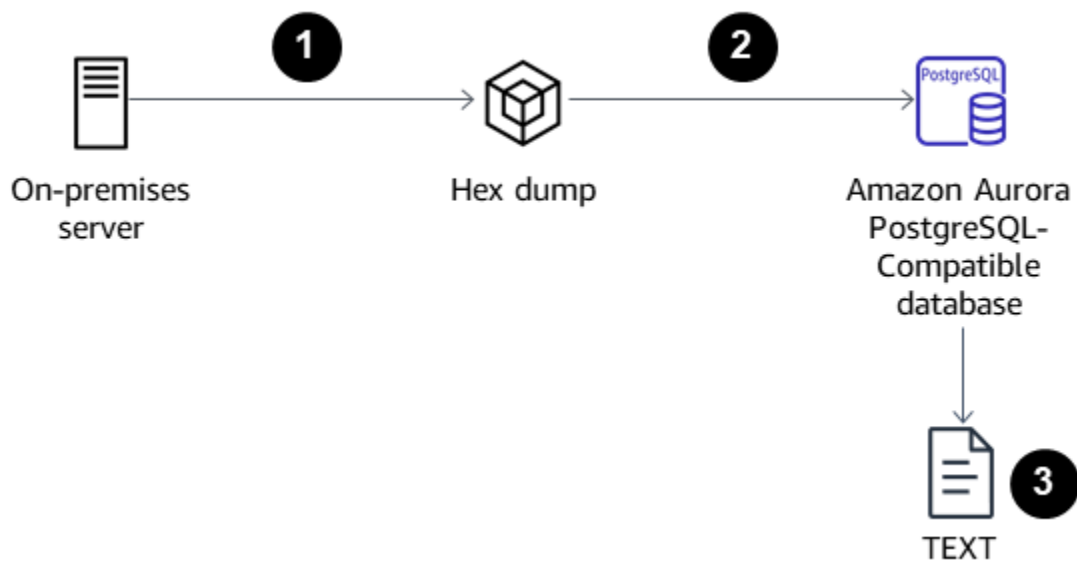

- Convert the file to a hex dump in the command line by using the `xxd -p` option.
- Upload the hex dump files into Aurora PostgreSQL-Compatible by using the `\copy` option, and then decode the hex dump files to binary.
- Encode the binary data to return as TEXT.

## Tools

### AWS services

- [Amazon Aurora PostgreSQL-Compatible Edition](#) is a fully managed, ACID-compliant relational database engine that helps you set up, operate, and scale PostgreSQL deployments.

- [AWS Command Line Interface \(AWS CLI\)](#) is an open-source tool that helps you interact with AWS services through commands in your command-line shell.

## Other tools

- [pgAdmin4](#) is an open source administration and development platform for PostgreSQL. pgAdmin4 can be used on Linux, Unix, mac OS, and Windows to manage PostgreSQL.

## Epics

### Approach 1: Import data from Amazon S3 to Aurora PostgreSQL-Compatible

Task	Description	Skills required
Launch an EC2 instance.	For instructions on launching an instance, see <a href="#">Launch your instance</a> .	DBA
Install the PostgreSQL client pgAdmin tool.	Download and install <a href="#">pgAdmin</a> .	DBA
Create an IAM policy.	<p>Create an AWS Identity and Access Management (IAM) policy named <code>aurora-s3-access-pol</code> that grants access to the S3 bucket where the files will be stored. Use the following code, replacing <code>&lt;bucket-name&gt;</code> with the name of your S3 bucket.</p> <pre> {   "Version":   "2012-10-17",   "Statement": [     {       "Effect":       "Allow", </pre>	DBA



Task	Description	Skills required
	<pre>                 "Action": [                     "s3:GetObject",                     "s3:AbortMultipart Upload",                     "s3&gt;DeleteObject",                     "s3:ListMultipartU ploadParts",                     "s3:PutObject",                     "s3:ListBucket"                 ],                 "Resource":                 [                     "arn:aws:s3:::&lt;buc ket-name&gt;/*",                     "arn:aws:s3:::&lt;buc ket-name&gt;"                 ]             ]         }     ] } </pre>	

Task	Description	Skills required
Create an IAM role for object import from Amazon S3 to Aurora PostgreSQL-Compatible.	<p>Use the following code to create an IAM role named <code>aurora-s3-import-role</code> with the <a href="#">AssumeRole</a> trust relationship. <code>AssumeRole</code> allows Aurora to access other AWS services on your behalf.</p> <pre data-bbox="597 636 1027 1272">{   "Version": "2012-10-17",   "Statement": [     {       "Effect":       "Allow", "Principal":       {         "Service":         "rds.amazonaws.com"       }, "Action":       "sts:AssumeRole"     }   ] }</pre>	DBA

Task	Description	Skills required
Associate the IAM role to the cluster.	<p>To associate the IAM role with the Aurora PostgreSQL-Compatible database cluster, run the following AWS CLI command. Change <code>&lt;Account-ID&gt;</code> to the ID of the AWS account that hosts the Aurora PostgreSQL-Compatible database. This enables the Aurora PostgreSQL-Compatible database to access the S3 bucket.</p> <pre data-bbox="594 825 1027 1220">aws rds add-role-to-db-cluster --db-cluster-identifier aurora-postgres-cl --feature-name s3Import --role-arn arn:aws:iam::&lt;Account-ID&gt;:role/aurora-s3-import-role</pre>	DBA
Upload the example to Amazon S3.	<ol style="list-style-type: none"> <li>In the <i>Additional information</i> section of this pattern, copy the email template code into a file named <code>salary.event.notification.email.vm</code>.</li> <li>Upload the file to the S3 bucket.</li> </ol>	DBA, App owner

Task	Description	Skills required
Deploy the custom function.	<ol style="list-style-type: none"><li data-bbox="594 226 1026 499">1. From the <i>Additional information</i> section, copy the custom function <code>load_file_into_clob</code> SQL file content into a temporary table.</li><li data-bbox="594 525 1026 751">2. Log in to the Aurora PostgreSQL-Compatible database and deploy it into the database schema by using the pgAdmin client.</li></ol>	App owner, DBA

Task	Description	Skills required
Run the custom function for importing the data into the database.	<p>Run the following SQL command, replacing the items in angle brackets with the appropriate values.</p> <pre data-bbox="597 443 1027 758">select load_file _into_clob('aws-s3 -import-test'::text, 'us-west-1'::text, 'employee.salary .event.notification .email.vm'::text);</pre> <p>Replace the items in angle brackets with the appropriate values, as shown in the following example, before running the command.</p> <pre data-bbox="597 1062 1027 1377">Select load_file _into_clob('aws-s3 -import-test'::text, 'us-west-1'::text, 'employee.salary .event.notification .email.vm'::text);</pre> <p>The command loads the file from Amazon S3 and returns the output as TEXT.</p>	App owner, DBA

## Approach 2: Convert the template file into a hex dump in a local Linux system

Task	Description	Skills required
Convert the template file into a hex dump.	<p>The Hexdump utility displays the contents of binary files in hexadecimal, decimal, octal, or ASCII. The hexdump command is part of the <code>util-linux</code> package and comes pre-installed in Linux distributions. The Hexdump RPM package is part of Amazon Linux 2 as well. <b>(Note:</b> Amazon Linux 2 is nearing end of support. For more information, see the <a href="#">Amazon Linux 2 FAQs</a>.)</p> <p>To convert the file contents into a hex dump, run the following shell command.</p> <pre>xxd -p &lt;/path/file.vm&gt;   tr -d '\n' &gt; &lt;/path/ file.hex&gt;</pre> <p>Replace the path and file with the appropriate values, as shown in the following example.</p> <pre>xxd -p employee. salary.event.notif ication.email.vm   tr -d '\n' &gt; employee.</pre>	DBA

Task	Description	Skills required
	<code>salary.event.notification.email.vm.hex</code>	

Task	Description	Skills required
Load the hexdump file into the database schema.	<p>Use the following commands to load the hexdump file into the Aurora PostgreSQL-Compatible database.</p> <ol style="list-style-type: none"><li>1. Log in to Aurora PostgreSQL database, and create a new table called <code>email_template_hex</code> .</li></ol> <pre>CREATE TABLE email_template_hex(hex_data TEXT);</pre> <ol style="list-style-type: none"><li>2. Load the files from the local file system into the DB schema by using the following command.</li></ol> <pre>\copy email_template_hex FROM '/path/file.hex';</pre> <p>Replace the path with the location on your local file system.</p> <pre>\copy email_template_hex FROM '/tmp/employee.salary.event.notification.email.vm.hex';</pre> <ol style="list-style-type: none"><li>3. Create one more table called <code>email_template_bytea</code> .</li></ol>	DBA



Task	Description	Skills required
	<pre data-bbox="634 212 1027 365">CREATE TABLE email_template_bytea(hex_data bytea);</pre> <p data-bbox="592 384 976 562">4. Insert the data from <code>email_template_hex</code> into <code>email_template_bytea</code> .</p> <pre data-bbox="634 600 1027 953">INSERT INTO email_template_bytea (hex_data) (SELECT decode(hex_data, 'hex') FROM email_template_hex limit 1);</pre> <p data-bbox="592 972 976 1104">5. To return hex bytea code as TEXT data, run the following command.</p> <pre data-bbox="634 1142 1027 1377">SELECT encode(hex_data::bytea, 'escape') FROM email_template_bytea;</pre>	

## Related resources

### References

- [Using a PostgreSQL database as a target for AWS Database Migration Service](#)
- [Oracle Database 19c to Amazon Aurora with PostgreSQL Compatibility \(12.4\) Migration Playbook](#)
- [Creating IAM policies](#)

- [Associating an IAM role with an Amazon Aurora MySQL DB cluster](#)
- [pgAdmin](#)

## Tutorials

- [Getting Started with Amazon RDS](#)
- [Migrate from Oracle to Amazon Aurora](#)

## Additional information

### load\_file\_into\_clob custom function

```
CREATE OR REPLACE FUNCTION load_file_into_clob(
    s3_bucket_name text,
    s3_bucket_region text,
    file_name text,
    file_delimiter character DEFAULT '& '::bpchar,
    file_encoding text DEFAULT 'UTF8'::text)
    RETURNS text
    LANGUAGE 'plpgsql'
    COST 100
    VOLATILE PARALLEL UNSAFE
AS $BODY$
DECLARE
    blob_data BYTEA;
    clob_data TEXT;
    l_table_name CHARACTER VARYING(50) := 'file_upload_hex';
    l_column_name CHARACTER VARYING(50) := 'template';
    l_return_text TEXT;
    l_option_text CHARACTER VARYING(150);
    l_sql_stmt CHARACTER VARYING(500);

BEGIN

    EXECUTE format ('CREATE TEMPORARY TABLE %I (%I text, id_serial serial)',
l_table_name, l_column_name);

    l_sql_stmt := 'select ''(format text, delimiter '''' || file_delimiter || '''' ,
encoding '''' || file_encoding || '''' )'' ';

    EXECUTE FORMAT(l_sql_stmt)
```

```

    INTO l_option_text;

    EXECUTE FORMAT('SELECT aws_s3.table_import_from_s3($1,$2,$6,
aws_commons.create_s3_uri($3,$4,$5))')
    INTO l_return_text
    USING l_table_name, l_column_name, s3_bucket_name,
file_name,s3_bucket_region,l_option_text;

    EXECUTE format('select array_to_string(array_agg(%I order by id_serial),E''\n'')
from %I', l_column_name, l_table_name)
    INTO clob_data;

    drop table file_upload_hex;

    RETURN clob_data;
END;
$BODY$;

```

## Email template

```

#####
##
##
##   johndoe Template Type: email
##
##   File: johndoe.salary.event.notification.email.vm
##
##   Author: Aimée Étienne   Date 1/10/2021
##
## Purpose: Email template used by EmplmanagerEJB to inform a johndoe they   ##
##         have been given access to a salary event
##
##   Template Attributes:
##
##         invitedUser - PersonDetails object for the invited user
##
##         salaryEvent - OfferDetails object for the event the user was given access
##
##         buyercollege - CompDetails object for the college owning the salary event
##
##         salaryCoordinator - PersonDetails of the salary coordinator for the event
##

```

```
##      idp - Identity Provider of the email recipient
##
##      httpWebRoot - HTTP address of the server
##
##
##
#####

$!invitedUser.firstname $!invitedUser.lastname,

Ce courriel confirme que vous avez ete invite par $!salaryCoordinator.firstname $!
salaryCoordinator.lastname de $buyercollege.collegeName a participer a l'evenement
"$salaryEvent.offeringtitle" sur johndoeMaster Sourcing Intelligence.

Votre nom d'utilisateur est $!invitedUser.username

Veuillez suivre le lien ci-dessous pour acceder a l'evenement.

${httpWebRoot}/myDashboard.do?idp=${idp}

Si vous avez oublie votre mot de passe, utilisez le lien "Mot de passe oublie" situe
sur l'ecran de connexion et entrez votre nom d'utilisateur ci-dessus.

Si vous avez des questions ou des preoccupations, nous vous invitons a
communiquer avec le coordonnateur de l'evenement $!salaryCoordinator.firstname $!
salaryCoordinator.lastname au ${salaryCoordinator.workphone}.

*****

johndoeMaster Sourcing Intelligence est une plateforme de soumission en ligne pour les
equipements, les materiaux et les services.

Si vous avez des difficultes ou des questions, envoyez un courriel a
support@johndoeMaster.com pour obtenir de l'aide.
```

# Migrate Amazon RDS for Oracle to Amazon RDS for PostgreSQL in SSL mode by using AWS DMS

Created by Pinesh Singal (AWS)

<b>Environment:</b> PoC or pilot	<b>Source:</b> Amazon RDS for Oracle	<b>Target:</b> Amazon RDS PostgreSQL
<b>R Type:</b> Re-architect	<b>Workload:</b> Oracle; Open-source	<b>Technologies:</b> Migration; Security, identity, compliance; Databases; Analytics; Data lakes
<b>AWS services:</b> AWS DMS; Amazon RDS; AWS SCT; AWS Management Console; Amazon Connect; Amazon CloudWatch Logs; Amazon CloudWatch		

## Summary

This pattern provides guidance for migrating an Amazon Relational Database Service (Amazon RDS) for Oracle database instance to an Amazon RDS for PostgreSQL database on the Amazon Web Services (AWS) Cloud. To encrypt connections between the databases, the pattern uses certificate authority (CA) and SSL mode in Amazon RDS and AWS Database Migration Service (AWS DMS).

The pattern describes an online migration strategy with little or no downtime for a multi-terabyte Oracle source database with a high number of transactions. For data security, the pattern uses SSL when transferring the data.

This pattern uses AWS Schema Conversion Tool (AWS SCT) to convert the Amazon RDS for Oracle database schema to an Amazon RDS for PostgreSQL schema. Then the pattern uses AWS DMS to migrate data from the Amazon RDS for Oracle database to the Amazon RDS for PostgreSQL database.

## Prerequisites and limitations

### Prerequisites

- An active AWS account
- Amazon RDS database certificate authority (CA) configured with *rds-ca-rsa2048-g1* only
  - The rds-ca-2019 certificate is set to expire in August 2024
  - The rds-ca-2015 certificate expired on March 5, 2020
- AWS SCT
- AWS DMS
- pgAdmin
- SQL tools (for example, SQL Developer or SQL\*Plus)

### Limitations

- Amazon RDS for Oracle database – The minimum requirement is for Oracle versions 19c for the Enterprise and Standard Two editions.
- Amazon RDS for PostgreSQL database – The minimum requirement is for PostgreSQL version 12 and later (for versions 9.x and later).

### Product versions

- Amazon RDS for Oracle database version 12.1.0.2 instance
- Amazon RDS for PostgreSQL database version 11.5 instance

## Architecture

### Source technology stack

- An Amazon RDS for Oracle database instance with version 12.1.0.2.v18.

### Target technology stack

- AWS DMS
- An Amazon RDS for PostgreSQL database instance with version 11.5.

## Target architecture

The following diagram shows the architecture for data migration architecture between Oracle (source) and PostgreSQL (target) databases. The architecture includes the following:

- A virtual private cloud (VPC)
- An Availability Zone
- A private subnet
- An Amazon RDS for Oracle database
- An AWS DMS replication instance
- An RDS for PostgreSQL database

To encrypt connections for source and target databases, CA and SSL mode must be enabled in Amazon RDS and AWS DMS.

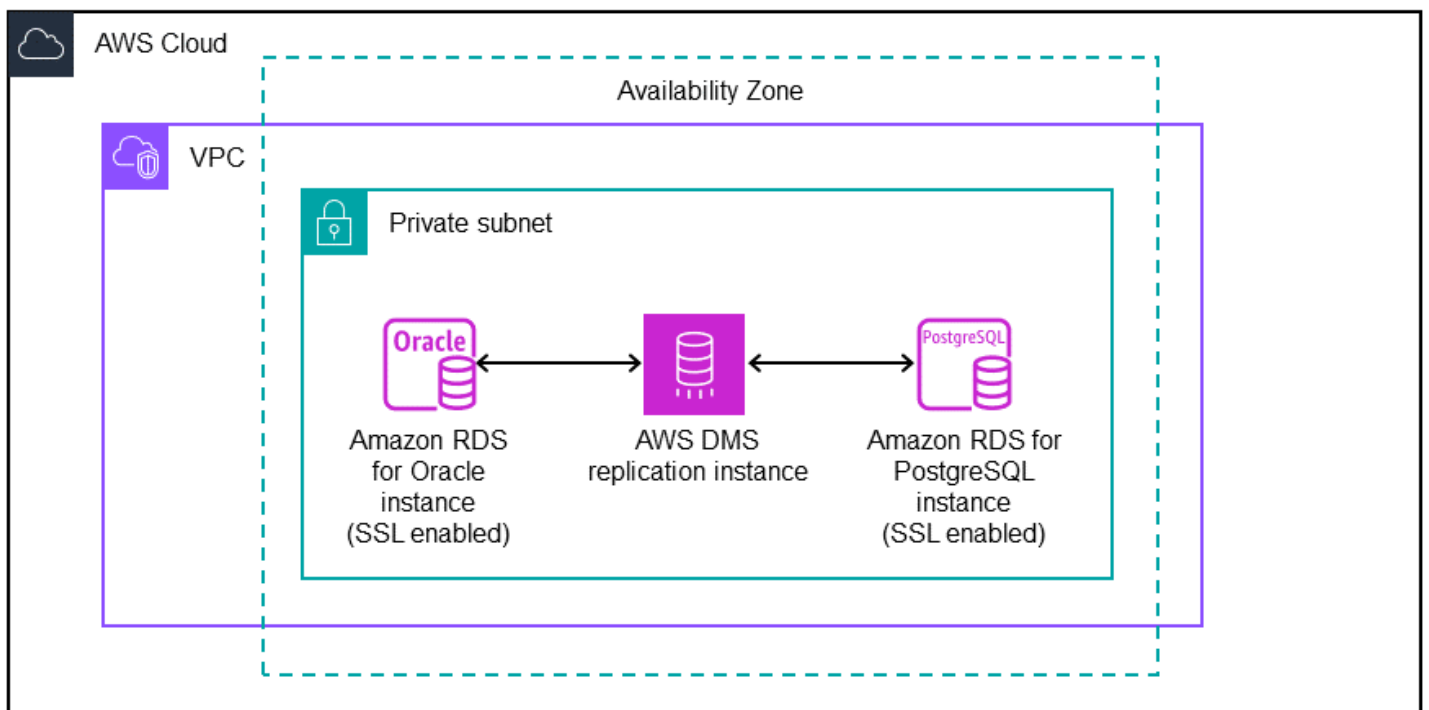

## Tools

### AWS services

- [AWS Database Migration Service \(AWS DMS\)](#) helps you migrate data stores into the AWS Cloud or between combinations of cloud and on-premises setups.

- [Amazon Relational Database Service \(Amazon RDS\) for Oracle](#) helps you set up, operate, and scale an Oracle relational database in the AWS Cloud.
- [Amazon Relational Database Service \(Amazon RDS\) for PostgreSQL](#) helps you set up, operate, and scale a PostgreSQL relational database in the AWS Cloud.
- [AWS Schema Conversion Tool \(AWS SCT\)](#) supports heterogeneous database migrations by automatically converting the source database schema and a majority of the custom code to a format that's compatible with the target database.

## Other services

- [pgAdmin](#) is an open source management tool for PostgreSQL. It provides a graphical interface that helps you create, maintain, and use database objects.

## Best practices

Amazon RDS provides new CA certificates as an AWS security best practice. For information about the new certificates and the supported AWS Regions, see [Using SSL/TLS to encrypt a connection to a DB instance or cluster](#).

If your RDS instance is currently on CA certificate `rds-ca-2019`, and you want to upgrade to `rds-ca-rsa2048-g1`, follow the instructions in [Updating your CA certificate by modifying your DB instance or cluster](#) or [Updating your CA certificate by applying maintenance](#).

## Epics

### Configure the Amazon RDS for Oracle instance

Task	Description	Skills required
Create the Oracle database instance.	Sign in to your AWS account, open the AWS Management Console, and navigate to the Amazon RDS console. On the console, choose <b>Create database</b> , and then choose <b>Oracle</b> .	General AWS, DBA



Task	Description	Skills required
Configure security groups.	Configure inbound and outbound security groups.	General AWS
Create an option group.	Create an option group in the same VPC and security group as the Amazon RDS for Oracle database. For <b>Option</b> , choose <b>SSL</b> . For <b>Port</b> , choose <b>2484</b> (for SSL connections).	General AWS
Configure the option settings.	Use the following settings: <ul style="list-style-type: none"> <li>• <code>SQLNET.CIPHER_SUITE : SSL_RSA_WITH_AES_256_CBC_SHA</code></li> <li>• <code>SQLNET.SSL_VERSION : 1.2 or 1.0</code></li> </ul>	General AWS
Modify the RDS for Oracle DB instance.	Set the CA certificate as <b>rds-ca-rsa2048-g1</b> .  Under <b>Option group</b> , attach the previously created option group.	DBA, General AWS

Task	Description	Skills required
Confirm that the RDS for Oracle DB instance is available.	<p>Make sure that the Amazon RDS for Oracle database instance is up and running and that the database schema is accessible.</p> <p>To connect to the RDS for Oracle DB, use the <code>sqlplus</code> command from the command line.</p> <pre data-bbox="597 716 1026 1787">\$ sqlplus orcl/**** @myoracledb.cokmvi s0v46q.us-east-1.r ds.amazonaws.com:1 521/ORCL SQL*Plus: Release 12.1.0.2.0 Production on Tue Oct 15 18:11:07 2019 Copyright (c) 1982, 2016, Oracle. All rights reserved. Last Successful login time: Mon Dec 16 2019 23:17:31 +05:30 Connected to: Oracle Database 12c Enterprise Edition Release 12.1.0.2.0 - 64bit Production With the Partition ing, OLAP, Advanced Analytics and Real Application Testing options SQL&gt;</pre>	DBA

Task	Description	Skills required
Create objects and data in the RDS for Oracle database.	Create objects and insert data in the schema.	DBA

## Configure the Amazon RDS for PostgreSQL instance

Task	Description	Skills required
Create the RDS for PostgreSQL database.	On the Amazon RDS console <b>Create database</b> page, choose <b>PostgreSQL</b> to create an Amazon RDS for PostgreSQL database instance.	DBA, General AWS
Configure security groups.	Configure inbound and outbound security groups.	General AWS
Create a parameter group.	If you are using PostgreSQL version 11.x, create a parameter group to set SSL parameters. In PostgreSQL version 12, the SSL parameter group is enabled by default.	General AWS
Edit parameters.	Change the <code>rds.force_ssl</code> parameter to 1 (on).  By default, the <code>ssl</code> parameter is 1 (on). By setting the <code>rds.force_ssl</code> parameter to 1, you force all connections to connect through SSL mode only.	General AWS

Task	Description	Skills required
Modify the RDS for PostgreSQL DB instance.	<p>Set the CA certificate as <b>rds-ca-rsa2048-g1</b>.</p> <p>Attach the default parameter group or the previously created parameter group, depending on your PostgreSQL version.</p>	DBA, General AWS

Task	Description	Skills required
Confirm that the RDS for PostgreSQL DB instance is available.	<p>Make sure that the Amazon RDS for PostgreSQL database is up and running.</p> <p>The <code>psql</code> command establishes an SSL connection with <code>sslmode</code> set from the command line.</p> <p>One option is to set <code>sslmode=1</code> in the parameter group and use a <code>psql</code> connection without including the <code>sslmode</code> parameter in the command.</p> <p>The following output shows that the SSL connection is established.</p> <pre data-bbox="602 1115 1027 1856">\$ psql -h mypgdbinstance.cokmvis0v46q.us-east-1.rds.amazonaws.com -p 5432 "dbname=pgdb user=pguser" Password for user pguser: psql (11.3, server 11.5) SSL connection (protocol: TLSv1.2, cipher: ECDHE-RSA-AES256-GCM-SHA384, bits: 256, compression: off) Type "help" for help. pgdb=&gt;</pre>	DBA

Task	Description	Skills required
	<p>A second option is to set <code>sslmode=1</code> in the parameter group and to include the <code>sslmode</code> parameter in the <code>psql</code> command.</p> <p>The following output shows that the SSL connection is established.</p> <pre data-bbox="602 695 1027 1413"> \$ psql -h mypgdbins tance.cokmvis0v46q .us-east-1.rds.ama zonaws.com -p 5432 "dbname=pgdb user=pgus er sslmode=require" Password for user pguser: psql (11.3, server 11.5) SSL connection (protocol: TLSv1.2, cipher: ECDHE-RSA- AES256-GCM-SHA384, bits: 256, compressi on: off) Type "help" for help. pgdb=&gt;</pre>	

## Configure and run AWS SCT

Task	Description	Skills required
Install AWS SCT.	Install the latest version of the AWS SCT application.	General AWS

Task	Description	Skills required
Configure AWS SCT with JDBC drivers.	<p>Download the Java Database Connectivity (JDBC) drivers for Oracle (<a href="#">ojdbc8.jar</a>) and PostgreSQL (<a href="#">postgresql-42.2.5.jar</a>).</p> <p>To configure the drivers in AWS SCT, choose <b>Settings, Global settings, Drivers</b>.</p>	General AWS

Task	Description	Skills required
Create the AWS SCT project.	<p>Create the AWS SCT project and report, using Oracle as the source DB engine and Amazon RDS for PostgreSQL as the target DB engine:</p> <ol style="list-style-type: none"><li>1. Test connections to the source Oracle database and target Amazon RDS for PostgreSQL database by providing connection details.</li></ol> <p>For the source Oracle database, the following permissions or privileges are required:</p> <ul style="list-style-type: none"><li>• CONNECT</li><li>• SELECT_CATALOG_ROLE</li><li>• SELECT ANY DICTIONARY</li><li>• SELECT on SYS.USER\$ TO &lt;sct_user&gt;</li></ul> <p>For more information, see <a href="#">Using Oracle Database as a source for AWS SCT</a>.</p> <p>Both source and target connections must be successful before AWS SCT can start the migration report.</p>	General AWS



Task	Description	Skills required
	<ol style="list-style-type: none"> <li>After the report, enter the schema to be converted, and choose <b>Finish</b>.</li> </ol>	
Validate database objects.	<ol style="list-style-type: none"> <li>Choose <b>Load schema</b>.  AWS SCT displays the source and the converted target objects, including objects that have errors. Update any incorrect objects on the target database.</li> <li>Review the errors, and clear them by using manual intervention.</li> <li>After all errors are cleared, choose <b>Load schema</b> again.</li> <li>Choose <b>Apply to database</b>.</li> <li>Connect to pgAdmin, or any tool that supports a PostgreSQL DB connection, and check the schema and objects.</li> </ol>	DBA, General AWS

## Configure and run AWS DMS

Task	Description	Skills required
Create a replication instance.	<ol style="list-style-type: none"> <li>Sign in to your account, open the AWS Management Console, and navigate to the AWS DMS console.</li> </ol>	General AWS

Task	Description	Skills required
	2. Create a replication instance with valid settings for the VPC, security group, Availability Zone, and extra connection attributes.	
Import the certificate.	<p>Download the <a href="#">certificate bundle (PEM)</a> for your AWS Region.</p> <p>The bundle contains both the <code>rds-ca-2019</code> intermediate and root certificates. The bundle also contains the <code>rds-ca-rsa2048-g1</code>, <code>rds-ca-rsa4096-g1</code>, and <code>rds-ca-ecc384-g1</code> root CA certificates. Your application trust store needs to register only the root CA certificate.</p>	General AWS

Task	Description	Skills required
Create the source endpoint.	<ol style="list-style-type: none"><li data-bbox="592 226 1027 688">1. Create a source endpoint for Amazon RDS for Oracle by choosing <b>Select RDS DB instance</b> and then selecting the RDS for Oracle DB instance that you created. The endpoint configuration details will be automatically populated .</li><li data-bbox="592 716 1027 888">2. Choose <b>Provide access information manually</b>. For <b>Port</b>, make sure that you enter <b>2484</b>.</li><li data-bbox="592 915 1027 1188">3. Under <b>Secure Socket Layer (SSL) mode</b>, choose <code>verify-ca</code> , and then choose the CA certificate that you created previously.</li><li data-bbox="592 1215 1027 1488">4. Under <b>Endpoint settings</b>, add the extra connection attribute <code>NumberDataTypesScale=-2</code> to support the NUMBER data type with no size.</li></ol> <p data-bbox="592 1562 1027 1734">For more information, see <a href="#">Using an Oracle database as a source for AWS Database Migration Service</a>.</p>	General AWS

Task	Description	Skills required
Create the target endpoint.	<ol style="list-style-type: none"><li>1. Create a target endpoint for Amazon RDS for PostgreSQL by choosing <b>Select RDS DB instance</b> and then selecting your RDS for PostgreSQL DB instance. The endpoint configuration details will be automatically populated .</li><li>2. Choose <b>Provide access information manually</b>. For <b>Port</b>, make sure that you enter <b>2484</b>.</li></ol> <p>For more information, see <a href="#">Using a PostgreSQL database as a target for AWS Database Migration Service</a>.</p>	General AWS
Test the endpoints.	<ol style="list-style-type: none"><li>1. Test the source and target endpoints to confirm that both are successful and available.</li><li>2. If a test fails, make sure that the security group inbound rules are valid.</li></ol>	General AWS

Task	Description	Skills required
Create migration tasks.	<p>To create a migration task for full load and change data capture (CDC) or for data validation, do the following:</p> <ol style="list-style-type: none"><li>1. To create a database migration task, choose the replication instance, source database endpoint, target database endpoint. Specify the migration type as one of the following:<ul style="list-style-type: none"><li>• <b>Migrate existing data</b> (full load)</li><li>• <b>Replicate data changes only (CDC)</b></li><li>• <b>Migrate existing data and replicate ongoing changes</b> (full load and CDC)</li></ul></li><li>2. Under <b>Table mappings</b>, you can configure selection rules and transformation rules in GUI or JSON formats:<ul style="list-style-type: none"><li>• Under <b>Selection rules</b>, select the schema, enter the table name, and select the action (Include or Exclude) to be configured; for example, Schema ORCL, Table name %, Action Include.</li></ul></li></ol>	General AWS

Task	Description	Skills required
	<ul style="list-style-type: none"><li>• Under <b>Transformation rules</b>, do one of the following:<ul style="list-style-type: none"><li>• Select the schema and choose the action (case, prefix, suffix); for example, Target Schema ORCL, Action Make lowercase.</li><li>• Select the schema, enter the table name, and choose the action (case, prefix, suffix); for example, Target Schema ORCL, Table %, Action Make lowercase.</li></ul></li></ul> <ol style="list-style-type: none"><li>3. Turn on Amazon CloudWatch Logs monitoring.</li><li>4. For the mapping rules, add the following JSON code.</li></ol> <pre data-bbox="634 1325 1029 1814">{   "rules": [     {       "rule-type": "transformation",       "rule-id": "1",       "rule-name": "1",       "rule-target": "table",</pre>	

Task	Description	Skills required
	<pre> "object-l ocator": {   "schema-name": "%",   "table-name": "%"   },   "rule- action": "convert- lowercase",   "value":   null,   "old-valu e": null   },   {     "rule- type": "transfor mation",     "rule-id" : "2",     "rule-nam e": "2",     "rule-tar get": "schema",     "object-l ocator": {       "schema-name":       "ORCL",       "table-name": "%"       },       "rule- action": "convert- lowercase",       "value":       null,       "old-valu e": null     },     { </pre>	

Task	Description	Skills required
	<pre>                     "rule-type": "selection",                     "rule-id": "3",                     "rule-name": "3",                     "object-locator": {                         "schema-name": "ORCL",                         "table-name": "DEPT"                     },                     "rule-action": "include",                     "filters": []                 }             ]         }             </pre>	
<p>Plan the production run.</p>	<p>Confirm downtime with stakeholders such as application owners to run AWS DMS in production systems.</p>	<p>Migration lead</p>



Task	Description	Skills required
Run the migration task.	<ol style="list-style-type: none"> <li>1. Start the AWS DMS task that has a status of <b>Ready</b>, and monitor the migration task logs in Amazon CloudWatch for any errors.  If you chose <b>Migrate existing data and replicate ongoing changes</b> as the migration type, and the status is <b>Load complete ongoing replication</b>, the full load with CDC data migration is completed and validation is ongoing.</li> <li>2. After you start the migration, you can obtain additional SSL-connection information in CloudWatch. For Oracle, CloudWatch shows the following connection string.   <pre>2019-12-17T09:15:11 [SOURCE_UNLOAD ]I: Connecting to Oracle: Beginning session (oracle_endpoint_connection.c:834)</pre> <p>The PostgreSQL connection string will be similar to the following example.</p> </li> </ol>	General AWS

Task	Description	Skills required
	<pre>2019-12-17T09:15:11 [TARGET_LOAD ]I: Going to connect to ODBC connection string: PROTOCOL=7.4-0;DRIVER={PostgreSQL};SERVER=mypgsqlinstance.cokmvis0v46q.us-east-1.rds.amazonaws.com;DATABASE=pgdb;PORT=5432;sslmode=require;UID=pguser; (odbc_endpoint_imp.c:2218)</pre>	
Validate the data.	<p>Review migration task results and data in the source Oracle and target PostgreSQL databases:</p> <ol style="list-style-type: none"> <li>1. Connect to pgAdmin and check the data in your PostgreSQL database with schema ORCL.</li> <li>2. For CDC, check the ongoing changes by inserting or updating data in the source Oracle database.</li> </ol>	DBA
Stop the migration task.	After you successfully complete the data validation, stop the migration task.	General AWS

## Clean up the resources

Task	Description	Skills required
Delete the AWS DMS tasks.	<ol style="list-style-type: none"><li>1. On the AWS DMS console, navigate to <b>Database migration tasks</b>, and stop any ongoing or running AWS DMS task.</li><li>2. Select the task or tasks, choose <b>Actions</b>, and choose <b>Delete</b>.</li></ol>	General AWS
Delete the AWS DMS endpoints.	Select the source and target endpoints that you created, choose <b>Actions</b> , and choose <b>Delete</b> .	General AWS
Delete the AWS DMS replication instance.	Choose the replication instance, choose <b>Actions</b> , and then choose <b>Delete</b> .	General AWS
Delete the PostgreSQL database.	<ol style="list-style-type: none"><li>1. On the Amazon RDS console, choose <b>Databases</b>.</li><li>2. Select the PostgreSQL database instance that you created, choose <b>Actions</b>, and then choose <b>Delete</b>.</li></ol>	General AWS
Delete the Oracle database.	On the Amazon RDS console, select the Oracle database instance, choose <b>Actions</b> , and then choose <b>Delete</b> .	General AWS

## Troubleshooting

Issue	Solution
AWS SCT source and target test connections are failing.	Configure JDBC driver versions and VPC security group inbound rules to accept the incoming traffic.
The Oracle source endpoint test run fails.	Check the endpoint settings and whether the replication instance is available.
The AWS DMS task full-load run fails.	Check whether the source and target databases have matching data types and sizes.
The AWS DMS validation migration task returns errors.	<ol style="list-style-type: none"><li>1. Check whether the table has a primary key. Tables without a primary key are not validated.</li><li>2. If the table has a primary key but returns errors, check the extra connection attribute in the source endpoint. The extra connection attribute must have <code>numberData typeScale=-2</code> to support the NUMBER data type with no size dynamically based on data available in table.</li></ol>

## Related resources

### Databases

- [Amazon RDS for Oracle](#)
- [Amazon RDS for PostgreSQL](#)

### SSL DB connection

- [Using SSL/TLS to encrypt a connection to a DB instance](#)
  - [Using SSL with an RDS for Oracle DB instance](#)
  - [Securing connections to RDS for PostgreSQL with SSL/TLS](#)

- [Download certificate bundles for specific AWS Regions](#)
  - [Download CA-2019 root certificate](#) (set to expire in August 2024)
- [Working with option groups](#)
  - [Adding options to Oracle DB instances](#)
  - [Oracle Secure Sockets Layer](#)
- [Working with parameter groups](#)
- [PostgreSQL sslmode connection parameter](#)
- [Using SSL from JDBC](#)
- [Rotating your SSL/TLS certificate](#)
  - [Updating your CA certificate by modifying your DB instance or cluster](#)
  - [Updating your CA certificate by applying maintenance](#)

## AWS SCT

- [AWS Schema Conversion Tool](#)
- [AWS Schema Conversion Tool User Guide](#)
- [Using the AWS SCT user interface](#)
- [Using Oracle Database as a source for AWS SCT](#)

## AWS DMS

- [AWS Database Migration Service](#)
- [AWS Database Migration Service User Guide](#)
  - [Using an Oracle database as a source for AWS DMS](#)
  - [Using a PostgreSQL database as a target for AWS DMS](#)
- [Using SSL with AWS Database Migration Service](#)
- [Migrating Applications Running Relational Databases to AWS](#)

## Additional information

Amazon RDS Certificate Authority certificates `rds-ca-2019` are set to expire in August 2024. If you use or plan to use SSL or TLS with certificate verification to connect to your RDS DB instances

or Multi-AZ DB clusters, consider using one of the new CA certificates: `rds-ca-rsa2048-g1`, `rds-ca-rsa4096-g1`, or `rds-ca-ecc384-g1`.

# Migrate Amazon RDS for Oracle to Amazon RDS for PostgreSQL with AWS SCT and AWS DMS using AWS CLI and AWS CloudFormation

Created by Pinesh Singal (AWS)

<b>Environment:</b> PoC or pilot	<b>Source:</b> Amazon RDS for Oracle	<b>Target:</b> Amazon RDS for PostgreSQL
<b>R Type:</b> Re-architect	<b>Workload:</b> Oracle; Open-source	<b>Technologies:</b> Migration; Databases
<b>AWS services:</b> AWS DMS; Amazon RDS; AWS SCT		

## Summary

This pattern shows how to migrate a multi-terabyte [Amazon Relational Database Service \(Amazon RDS\) for Oracle](#) DB instance to an [Amazon RDS for PostgreSQL](#) DB instance by using the AWS Command Line Interface (AWS CLI). The approach provides minimal downtime and doesn't require signing in to the AWS Management Console.

This pattern helps avoid manual configurations and individual migrations by using the AWS Schema Conversion Tool (AWS SCT) and AWS Database Migration Service (AWS DMS) consoles. The solution sets up a one-time configuration for multiple databases and performs the migrations by using AWS SCT and AWS DMS on the AWS CLI.

The pattern uses AWS SCT to convert database schema objects from Amazon RDS for Oracle to Amazon RDS for PostgreSQL and then uses AWS DMS to migrate the data. Using Python scripts in AWS CLI, you create AWS SCT objects and AWS DMS tasks with an AWS CloudFormation template.

## Prerequisites and limitations

### Prerequisites

- An active AWS account.
- An existing Amazon RDS for Oracle DB instance.
- An existing Amazon RDS for PostgreSQL DB instance.

- An Amazon EC2 instance or local machine with Windows or Linux OS for running scripts.
- An understanding of the following AWS DMS migration task types: full-load, cdc, full-load-and-cdc. For more information, see [Creating a task](#) in the AWS DMS documentation.
- AWS SCT, installed and configured with Java Database Connectivity (JDBC) drivers for Oracle and PostgreSQL database engines. For more information, see [Installing AWS SCT](#) and [Installing the required database drivers](#) in the AWS SCT documentation.
- The `AWSSchemaConversionToolBatch.jar` file from the installed AWS SCT folder, copied to your working directory.
- The `cli-sct-dms-cft.zip` file (attached), downloaded and extracted in your working directory.
- The most recent AWS DMS replication instance engine version. For more information, see [How do I create an AWS DMS replication instance](#) in the AWS Support documentation and [AWS DMS 3.4.4 release notes](#) in the AWS DMS documentation.
- AWS CLI version 2, installed and configured with your access key ID, secret access key, and default AWS Region name for the Amazon Elastic Compute Cloud (Amazon EC2) instance or operating system (OS) where the scripts are run. For more information, see [Installing, updating, and uninstalling the AWS CLI version 2](#) and [Configuring the AWS CLI](#) in the AWS CLI documentation.
- Familiarity with AWS CloudFormation templates. For more information, see [AWS CloudFormation concepts](#) in the AWS CloudFormation documentation.
- Python version 3, installed and configured on the Amazon EC2 instance or OS where the scripts are run. For more information, see the [Python documentation](#).

## Limitations

- The minimum requirements for your source Amazon RDS for Oracle DB instance are:
  - Oracle versions 12c (v12.1.0.2, v12.2.0.1), 18c (v18.0.0.0) and 19c (v19.0.0.0) for the Enterprise, Standard, Standard One, and Standard Two editions.
  - Although Amazon RDS supports Oracle 18c (v18.0.0.0), this version is on a deprecation path because Oracle no longer provide patches for 18c after the end-of-support date. For more information, see [Oracle on Amazon RDS](#) in the Amazon RDS documentation.
  - Amazon RDS for Oracle 11g is no longer supported.



- The minimum requirements for your target Amazon RDS for PostgreSQL DB instance are:
  - PostgreSQL versions 9 (versions 9.5 and 9.6), 10.x, 11.x, 12.x, and 13.x

### **Product versions**

- Amazon RDS for Oracle DB instance version 12.1.0.2 and later
- Amazon RDS for PostgreSQL DB instance version 11.5 and later
- AWS CLI version 2
- The latest version of AWS SCT
- The latest version of Python 3

### **Architecture**

#### **Source technology stack**

- Amazon RDS for Oracle

#### **Target technology stack**

- Amazon RDS for PostgreSQL

#### **Source and target architecture**

The following diagram shows the migration of an Amazon RDS for Oracle DB instance to an Amazon RDS for PostgreSQL DB instance using AWS DMS and Python scripts.

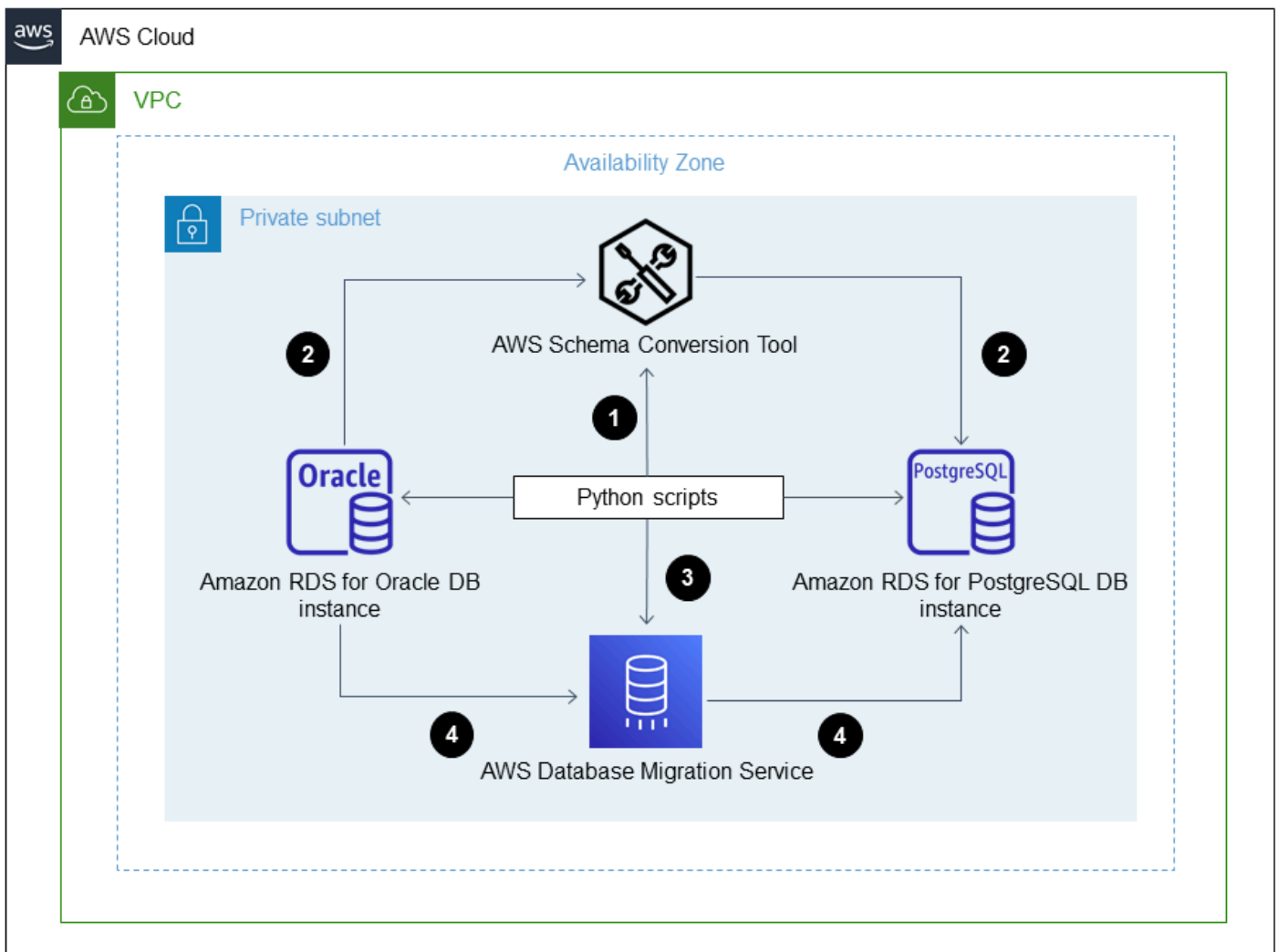

The diagram shows the following migration workflow:

1. The Python script uses AWS SCT to connect to the source and target DB instances.
2. The user starts AWS SCT with the Python script, converts the Oracle code to PostgreSQL code, and runs it on the target DB instance.
3. The Python script creates AWS DMS replication tasks for the source and target DB instances.
4. The user deploys Python scripts to start the AWS DMS tasks and then stops the tasks after the data migration is complete.

## Automation and scale

You can automate this migration by adding additional parameters and security-related changes for multiple functionalities in a single program to your Python script.

## Tools

- [AWS Command Line Interface \(AWS CLI\)](#) is an open-source tool that helps you interact with AWS services through commands in your command-line shell.
- [AWS CloudFormation](#) helps you set up AWS resources, provision them quickly and consistently, and manage them throughout their lifecycle across AWS accounts and Regions. This pattern converts the .csv input file to a .json input file using a Python script. The .json file is used in AWS CLI commands to create an AWS CloudFormation stack that creates multiple AWS DMS replication tasks with Amazon Resource Names (ARNs), migration types, task settings, and table mappings.
- [AWS Database Migration Service \(AWS DMS\)](#) helps you migrate data stores into the AWS Cloud or between combinations of cloud and on-premises setups. This pattern uses AWS DMS to create, start, and stop tasks with a Python script run over the command-line and create the AWS CloudFormation template.
- [AWS Schema Conversion Tool \(AWS SCT\)](#) supports heterogeneous database migrations by automatically converting the source database schema and a majority of the custom code to a format that's compatible with the target database. This pattern requires the `AWSSchemaConversionToolBatch.jar` file from the installed AWS SCT directory.

## Code

The `cli-sct-dms-cft.zip` file (attached) contains the complete source code for this pattern.

## Epics

### Configure AWS SCT and create database objects in AWS CLI

Task	Description	Skills required
Configure AWS SCT to run from the AWS CLI.	1. Configure the source and target environment configuration details in the <code>database_migration.txt</code> file by using the following format:	DBA

Task	Description	Skills required
	<pre data-bbox="609 226 1015 1081">#source_vendor, source_hostname, source_dbname, source_user, source_pwd, source_schema, source_port, source_sid, target_vendor, target_hostname, target_user, target_pwd, target_dbname, target_port ORACLE, myoracledb.cokmvis0v46q.us-east-1.rds.amazonaws.com, ORCL, orcl, orcl1234, orcl, 1521, ORCL, POSTGRESQL, mypgdbinstance.cokmvis0v46q.us-east-1.rds.amazonaws.com, pguser, pgpassword, pgdb, 5432</pre> <p data-bbox="592 1123 1031 1543">2. Modify the AWS SCT configuration parameters according to your requirements in the following files: project_settings.xml , Oracle_PG_Test_Batch.xml , and ORACLE-orcl-to-POSTGRESQL.xml .</p>	

Task	Description	Skills required
Run the run_aws_sct.py Python script.	<p>Run the run_aws_sct.py Python script by using the following command:</p> <pre>\$ python run_aws_sct.py database_migration.txt</pre> <p>The Python script converts the database objects from Oracle to PostgreSQL and creates SQL files in PostgreSQL format. The script also creates the Database migration assessment report .pdf file that provides you with detailed recommendations and conversion statistics for database objects.</p>	DBA
Create objects in Amazon RDS for PostgreSQL.	<ol style="list-style-type: none"> <li>1. Manually modify the SQL files generated by AWS SCT, if required.</li> <li>2. Run the SQL files and create objects in your Amazon RDS for PostgreSQL DB instance.</li> </ol>	DBA

### Configure and create AWS DMS tasks by using the AWS CLI and AWS CloudFormation

Task	Description	Skills required
Create an AWS DMS replication instance.	Sign in to the AWS Management Console, open the AWS DMS console, and	DBA

Task	Description	Skills required
	<p>create a replication instance that is configured according to your requirements.</p> <p>For more information, see <a href="#">Creating a replication instance</a> in the AWS DMS documentation and <a href="#">How do I create an AWS DMS replication instance</a> in the AWS Support documentation.</p>	
Create the source endpoint.	<p>On the AWS DMS console, choose <b>Endpoints</b> and then create a source endpoint for the Oracle database according to your requirements.</p> <p><b>Note:</b> The extra connection attribute must be <code>numberDataTypesScale</code> with a -2 value.</p> <p>For more information, see <a href="#">Creating source and target endpoints</a> in the AWS DMS documentation.</p>	DBA

Task	Description	Skills required
Create the target endpoint.	<p>On the AWS DMS console, choose <b>Endpoints</b> and then create a target endpoint for the PostgreSQL database according to your requirements.</p> <p>For more information, see <a href="#">Creating source and target endpoints</a> in the AWS DMS documentation.</p>	DevOps engineer
Configure the AWS DMS replication details to run from the AWS CLI.	<p>Configure the AWS DMS source and target endpoints and replication details in the <code>dms-arn-list.txt</code> file with the source endpoint ARN, target endpoint ARN, and the replication instance ARN by using following format:</p> <pre data-bbox="597 1226 1026 1860">#sourceARN,targetARN,repARN arn:aws:dms:us-east-1:123456789012: endpoint:EH7AINRUDZ5GOYIY6HVMXECMCQ arn:aws:dms:us-east-1:123456789012: endpoint:HHJVUV57N703CQF4PJZKGIOYY5 arn:aws:dms:us-east-1:123456789012: rep:LL57N77AQQAHHJF4PJFHNEZ5G</pre>	DBA

Task	Description	Skills required
Run the <code>dms-create-task.py</code> Python script to create the AWS DMS tasks.	<p>1. Run the <code>dms-create-task.py</code> Python script by using the following command:</p> <pre>\$ python dms-create-task.py database_migration.txt dms-arn-list.txt &lt;cft-stack-name&gt; &lt;migration-type&gt;</pre> <ul style="list-style-type: none"><li>• <code>database_migration.txt</code> is the database migration text file</li><li>• <code>dms-arn-list.txt</code> is the ARN list for AWS DMS</li><li>• <code>&lt;cft-stack-name&gt;</code> is the user-defined AWS CloudFormation stack name</li><li>• <code>&lt;migration-type&gt;</code> is the migration type (<b>full-load</b>, <b>cdc</b>, or <b>full-load-and-cdc</b>)</li></ul> <p>2. Depending on your migration type, you can use the following commands to create three types of AWS DMS tasks:</p> <ul style="list-style-type: none"><li>• <code>\$ python dms-create-task.py database_</code></li></ul>	DBA



Task	Description	Skills required
	<pre>migration.txt dms-arn-list.txt dms-cli-cft-stack full-load</pre> <ul style="list-style-type: none"> <li>• <code>\$ python dms-create-task.py database_migration.txt dms-arn-list.txt dms-cli-cft-stack cdc</code></li> <li>• <code>\$ python dms-create-task.py database_migration.txt dms-arn-list.txt dms-cli-cft-stack full-load-and-cdc</code></li> </ul> <p>3. The AWS CloudFormation stack and AWS DMS tasks are created</p>	
Check that AWS DMS tasks are ready.	In the AWS console, check that your AWS DMS tasks are in Ready status in the <b>Status</b> section.	DBA

### Start and stop the AWS DMS tasks by using the AWS CLI

Task	Description	Skills required
Start the AWS DMS tasks.	Run the <code>dms-start-task.py</code> Python script	DBA

Task	Description	Skills required
	<p>by using the following command:</p> <pre data-bbox="592 336 974 472">\$ python dms-start-task.py start '&lt;cdc-start-datetime&gt;'</pre> <p><b>Note:</b> The start date and time must be in the 'DD-MON-YYYY' or 'YYYY-MM-DDTHH:MI:SS' timestamp data type formats (for example, '01-Dec-2019' or '2018-03-08T12:12:12' )</p> <p>You can review the AWS DMS task status in the <b>Table statistics</b> tab of your migration tasks on the <b>Tasks</b> page of the AWS DMS console.</p>	

Task	Description	Skills required
Validate the data.	<ol style="list-style-type: none"><li data-bbox="592 226 1027 457">1. After the full-load migration is complete, the task is continuously kept running for continuous data change (CDC).</li><li data-bbox="592 478 1027 793">2. When CDC is complete or no more changes need to be migrated, review and validate the migration task results and data in your Oracle and PostgreSQL databases.</li><li data-bbox="592 814 1027 1423">3. You can validate your data by checking status and count columns (Validation state, Validation pending, Validation failed, Validation suspended, and Validation details) in the <b>Table statistics</b> tab of your database migration task on the <b>Tasks</b> page of the AWS DMS console.</li></ol> <p data-bbox="592 1507 1027 1633">For more information, see <a href="#">AWS DMS data validation</a> in the AWS DMS documentation.</p>	DBA

Task	Description	Skills required
Stop the AWS DMS tasks.	<p>Run the Python script by using the following command:</p> <pre>\$ python dms-start-task.py stop</pre> <p><b>Note:</b> AWS DMS tasks might stop with a <code>failedstatus</code>, depending on the validation status. For more information, see the troubleshooting table in the <i>Additional information</i> section.</p>	DBA

## Troubleshooting

Issue	Solution
AWS SCT source and target test connections fail	Configure the JDBC driver versions and VPC security group inbound rules to accept the incoming traffic.
Source or target endpoint test run fails	<p>Check if the endpoint settings and replication instance is in <code>Available</code> status. Check if the endpoint connection status is <code>Successful</code>.</p> <p>For more information, see <a href="#">How can I troubleshoot AWS DMS endpoint connectivity failures</a> in the AWS Support documentation.</p>
Full-load run fails	Check if the source and target databases have matching data types and sizes.

Issue	Solution
	<p>For more information, see <a href="#">Troubleshooting migration tasks in AWS DMS</a> in the AWS DMS documentation.</p>
Validation run errors	<p>Check if the table has a primary key because non-primary key tables are not validated.</p> <p>If the table has a primary key and errors, check that the extra connection attribute in the source endpoint has <code>numberDataTypeScale=-2</code>.</p> <p>For more information, see <a href="#">Extra connection attributes when using Oracle as a source for AWS DMS</a>, <a href="#">OracleSettings</a>, and <a href="#">Troubleshooting</a> in the AWS DMS documentation.</p>

## Related resources

- [Installing AWS SCT](#)
- [Introduction to AWS DMS \(video\)](#)
- [Using the AWS CLI in AWS CloudFormation](#)
- [Using the AWS SCT user interface](#)
- [Using an Oracle database as a source for AWS DMS](#)
- [Using Oracle as a source for AWS SCT](#)
- [Using a PostgreSQL database as a target for AWS DMS](#)
- [Sources for data migration in AWS DMS](#)
- [Targets for data migration in AWS DMS](#)
- [cloudformation](#) (AWS CLI documentation)
- [cloudformation create-stack](#) (AWS CLI documentation)
- [dms](#) (AWS CLI documentation)

## Attachments

To access additional content that is associated with this document, unzip the following file:  
[attachment.zip](#)

# Migrate Oracle `SERIALLY_REUSABLE` pragma packages into PostgreSQL

Created by Vinay Paladi (AWS)

<b>Environment:</b> PoC or pilot	<b>Source:</b> Oracle Database	<b>Target:</b> PostgreSQL
<b>R Type:</b> Re-architect	<b>Workload:</b> Oracle; Open-source	<b>Technologies:</b> Migration; Databases
<b>AWS services:</b> AWS SCT; Amazon Aurora		

## Summary

This pattern provides a step-by-step approach for migrating Oracle packages that are defined as `SERIALLY_REUSABLE` pragma to PostgreSQL on Amazon Web Services (AWS). This approach maintains the functionality of the `SERIALLY_REUSABLE` pragma.

PostgreSQL doesn't support the concept of packages and the `SERIALLY_REUSABLE` pragma. To get similar functionality in PostgreSQL, you can create schemas for packages and deploy all the related objects (such as functions, procedures, and types) inside the schemas. To achieve the functionality of the `SERIALLY_REUSABLE` pragma, the example wrapper function script that's provided in this pattern uses an [AWS Schema Conversion Tool \(AWS SCT\) extension pack](#).

For more information, see [SERIALLY\\_REUSABLE Pragma](#) in the Oracle documentation.

## Prerequisites and limitations

### Prerequisites

- An active AWS account
- The latest version of AWS SCT and the required drivers
- An Amazon Aurora PostgreSQL-Compatible Edition database or an Amazon Relational Database Service (Amazon RDS) for PostgreSQL database

### Product versions

- Oracle Database version 10g and later

## Architecture

### Source technology stack

- Oracle Database on premises

### Target technology stack

- [Aurora PostgreSQL-Compatible](#) or Amazon RDS for PostgreSQL
- AWS SCT

### Migration architecture

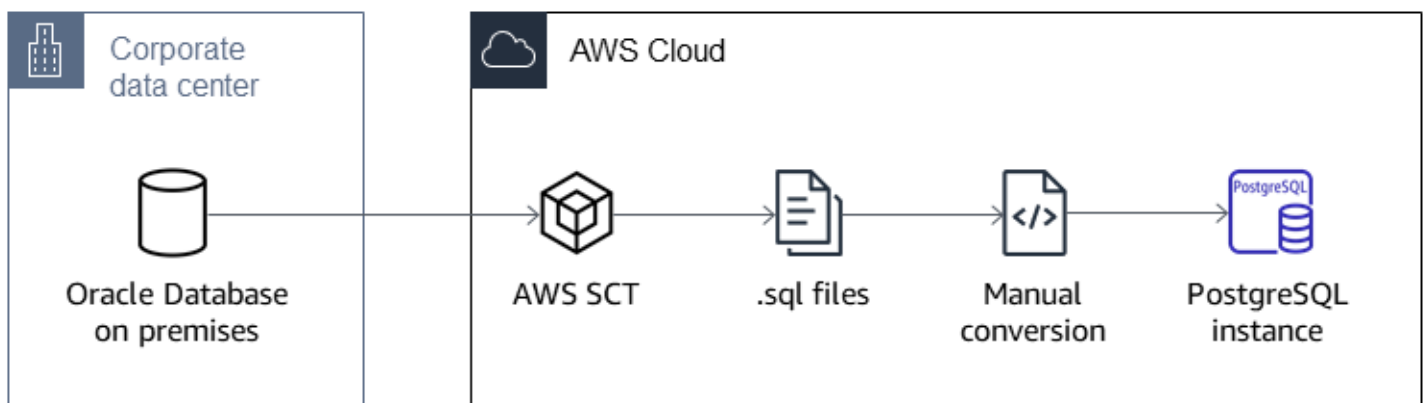

## Tools

### AWS services

- [AWS Schema Conversion Tool \(AWS SCT\)](#) supports heterogeneous database migrations by automatically converting the source database schema and a majority of the custom code to a format that's compatible with the target database.
- [Amazon Aurora PostgreSQL-Compatible Edition](#) is a fully managed, ACID-compliant relational database engine that helps you set up, operate, and scale PostgreSQL deployments.
- [Amazon Relational Database Service \(Amazon RDS\) for PostgreSQL](#) helps you set up, operate, and scale a PostgreSQL relational database in the AWS Cloud.



## Other tools

- [pgAdmin](#) is an open-source management tool for PostgreSQL. It provides a graphical interface that helps you create, maintain, and use database objects.

## Epics

### Migrate the Oracle package by using AWS SCT

Task	Description	Skills required
Set up AWS SCT.	Configure AWS SCT connectivity to the source database. For more information, see <a href="#">Using Oracle Database as a source for AWS SCT</a> .	DBA, Developer
Convert the script.	Use AWS SCT to convert the Oracle package by selecting the target database as Aurora PostgreSQL-Compatible.	DBA, Developer
Save the .sql files.	Before you save the .sql file, modify the <b>Project Settings</b> option in AWS SCT to <b>Single file per stage</b> . AWS SCT will separate the .sql file into multiple .sql files based on object type.	DBA, Developer
Change the code.	Open the <code>init</code> function generated by AWS SCT, and change it as shown in the example in the <i>Additional information</i> section. It will add a variable to achieve the	DBA, Developer

Task	Description	Skills required
	functionality <code>pg_serial</code> <code>ize = 0</code> .	
Test the conversion.	Deploy the <code>init</code> function to the Aurora PostgreSQL-Compatible database, and test the results.	DBA, Developer

## Related resources

- [AWS Schema Conversion Tool](#)
- [Amazon RDS](#)
- [Amazon Aurora features](#)
- [SERIALLY\\_REUSABLE Pragma](#)

## Additional information

Source Oracle Code:

```
CREATE OR REPLACE PACKAGE test_pkg_var
IS
PRAGMA SERIALLY_REUSABLE;
PROCEDURE function_1
(test_id number);
PROCEDURE function_2
(test_id number
);
END;

CREATE OR REPLACE PACKAGE BODY test_pkg_var
IS
PRAGMA SERIALLY_REUSABLE;
v_char VARCHAR2(20) := 'shared.airline';
v_num number := 123;

PROCEDURE function_1(test_id number)
IS
```

```
begin
dbms_output.put_line( 'v_char-'|| v_char);
dbms_output.put_line( 'v_num-'||v_num);
v_char:='test1';
function_2(0);
END;
```

```
PROCEDURE function_2(test_id number)
is
begin
dbms_output.put_line( 'v_char-'|| v_char);
dbms_output.put_line( 'v_num-'||v_num);
END;
END test_pkg_var;
```

Calling the above functions

```
set serveroutput on
```

```
EXEC test_pkg_var.function_1(1);
```

```
EXEC test_pkg_var.function_2(1);
```

Target Postgresql Code:

```
CREATE SCHEMA test_pkg_var;
```

```
CREATE OR REPLACE FUNCTION test_pkg_var.init(pg_serialize IN INTEGER DEFAULT 0)
```

```
RETURNS void
```

```
AS
```

```
$BODY$
```

```
DECLARE
```

```
BEGIN
```

```
if aws_oracle_ext.is_package_initialized( 'test_pkg_var' ) AND pg_serialize = 0
```

```
then
```

```
return;

end if;

PERFORM aws_oracle_ext.set_package_initialized( 'test_pkg_var' );

PERFORM aws_oracle_ext.set_package_variable( 'test_pkg_var', 'v_char',
'shared.airline.basecurrency'::CHARACTER

VARYING(100));

PERFORM aws_oracle_ext.set_package_variable('test_pkg_var', 'v_num', 123::integer);

END;

$BODY$

LANGUAGE plpgsql;

CREATE OR REPLACE FUNCTION test_pkg_var.function_1(pg_serialize int default 1)

RETURNS void
AS

$BODY$
DECLARE

BEGIN

PERFORM test_pkg_var.init(pg_serialize);

raise notice 'v_char%',aws_oracle_ext.get_package_variable( 'test_pkg_var', 'v_char');

raise notice 'v_num%',aws_oracle_ext.get_package_variable( 'test_pkg_var', 'v_num');

PERFORM aws_oracle_ext.set_package_variable( 'test_pkg_var', 'v_char',
'test1'::varchar);

PERFORM test_pkg_var.function_2(0);
END;

$BODY$
```

```
LANGUAGE plpgsql;

CREATE OR REPLACE FUNCTION test_pkg_var.function_2(IN pg_serialize integer default 1)

RETURNS void

AS

$BODY$

DECLARE

BEGIN

PERFORM test_pkg_var.init(pg_serialize);

raise notice 'v_char%',aws_oracle_ext.get_package_variable( 'test_pkg_var', 'v_char');

raise notice 'v_num%',aws_oracle_ext.get_package_variable( 'test_pkg_var', 'v_num');

END;
$BODY$
LANGUAGE plpgsql;
```

Calling the above functions

```
select test_pkg_var.function_1()

select test_pkg_var.function_2()
```

# Migrate Oracle external tables to Amazon Aurora PostgreSQL-Compatible

Created by anuradha chintha (AWS) and Rakesh Raghav (AWS)

<b>Environment:</b> PoC or pilot	<b>Source:</b> Oracle	<b>Target:</b> Aurora PostgreSQL
<b>R Type:</b> Re-architect	<b>Workload:</b> Open-source	<b>Technologies:</b> Migration; Databases; Modernization
<b>AWS services:</b> AWS Identity and Access Management; AWS Lambda; Amazon S3; Amazon SNS; Amazon Aurora		

## Summary

External tables give Oracle the ability to query data that is stored outside the database in flat files. You can use the ORACLE\_LOADER driver to access any data stored in any format that can be loaded by the SQL\*Loader utility. You can't use Data Manipulation Language (DML) on external tables, but you can use external tables for query, join, and sort operations.

Amazon Aurora PostgreSQL-Compatible Edition doesn't provide functionality similar to external tables in Oracle. Instead, you must use modernization to develop a scalable solution that meets functional requirements and is frugal.

This pattern provides steps for migrating different types of Oracle external tables to Aurora PostgreSQL-Compatible Edition on the Amazon Web Services (AWS) Cloud by using the `aws_s3` extension.

We recommend thoroughly testing this solution before implementing it in a production environment.

## Prerequisites and limitations

### Prerequisites

- An active AWS account
- AWS Command Line Interface (AWS CLI)
- An available Aurora PostgreSQL-Compatible database instance.
- An on-premises Oracle database with an external table
- pg.Client API
- Data files

## Limitations

- This pattern doesn't provide the functionality to act as a replacement for Oracle external tables. However, the steps and sample code can be enhanced further to achieve your database modernization goals.
- Files should not contain the character that is passing as a delimiter in `aws_s3` export and import functions.

## Product versions

- To import from Amazon S3 into RDS for PostgreSQL the database must be running PostgreSQL version 10.7 or later.

## Architecture

### Source technology stack

- Oracle

### Source architecture

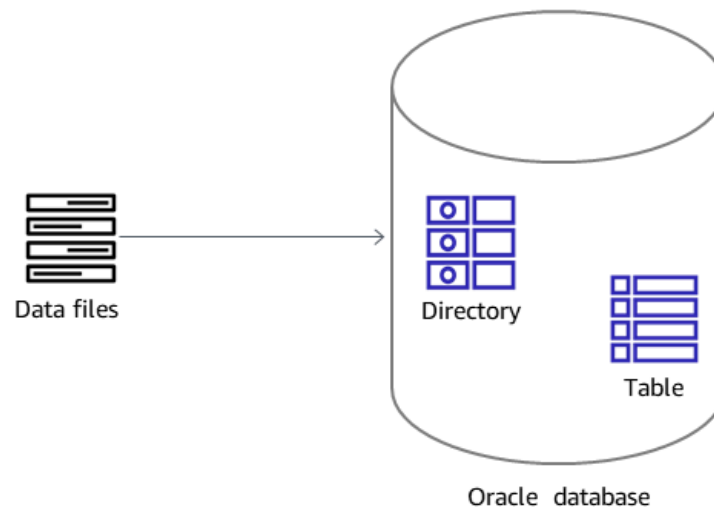

### Target technology stack

- Amazon Aurora PostgreSQL-Compatible
- Amazon CloudWatch
- AWS Lambda
- AWS Secrets Manager
- Amazon Simple Notification Service (Amazon SNS)
- Amazon Simple Storage Service (Amazon S3)

### Target architecture

The following diagram shows a high-level representation of the solution.



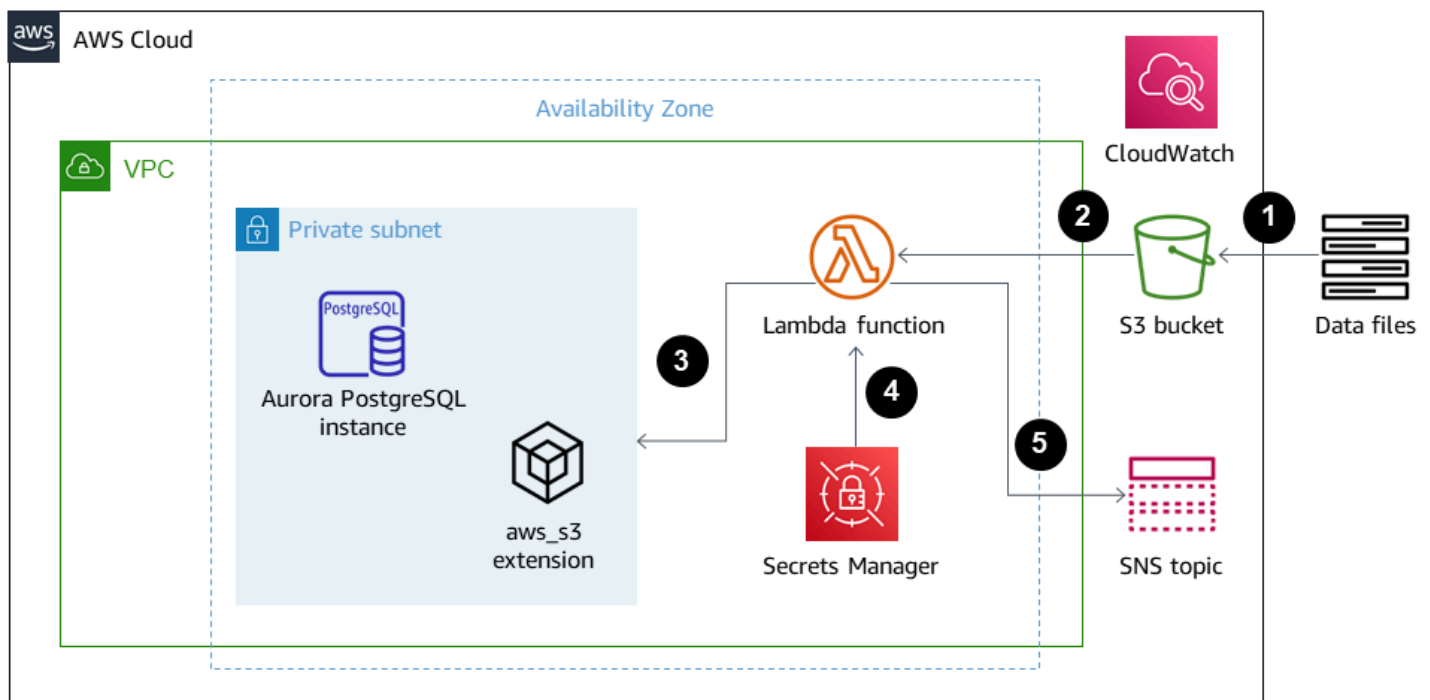

1. Files are uploaded to the S3 bucket.
2. The Lambda function is initiated.
3. The Lambda function initiates the DB function call.
4. Secrets Manager provides the credentials for database access.
5. Depending on the DB function, an SNS alarm is created.

## Automation and scale

Any additions or changes to the external tables can be handled with metadata maintenance.

## Tools

- [Amazon Aurora PostgreSQL-Compatible](#) – Amazon Aurora PostgreSQL-Compatible Edition is a fully managed, PostgreSQL-compatible, and ACID-compliant relational database engine that combines the speed and reliability of high-end commercial databases with the cost-effectiveness of open-source databases.
- [AWS CLI](#) – AWS Command Line Interface (AWS CLI) is a unified tool to manage your AWS services. With only one tool to download and configure, you can control multiple AWS services from the command line and automate them through scripts.
- [Amazon CloudWatch](#) – Amazon CloudWatch monitors Amazon S3 resources and utilization.

- [AWS Lambda](#) – AWS Lambda is a serverless compute service that supports running code without provisioning or managing servers, creating workload-aware cluster scaling logic, maintaining event integrations, or managing runtimes. In this pattern, Lambda runs the database function whenever a file is uploaded to Amazon S3.
- [AWS Secrets Manager](#) – AWS Secrets Manager is a service for credential storage and retrieval. Using Secrets Manager, you can replace hardcoded credentials in your code, including passwords, with an API call to Secrets Manager to retrieve the secret programmatically.
- [Amazon S3](#) – Amazon Simple Storage Service (Amazon S3) provides a storage layer to receive and store files for consumption and transmission to and from the Aurora PostgreSQL-Compatible cluster.
- [aws\\_s3](#) – The `aws_s3` extension integrates Amazon S3 and Aurora PostgreSQL-Compatible.
- [Amazon SNS](#) – Amazon Simple Notification Service (Amazon SNS) coordinates and manages the delivery or sending of messages between publishers and clients. In this pattern, Amazon SNS is used to send notifications.

## Code

Whenever a file is placed in the S3 bucket, a DB function must be created and called from the processing application or the Lambda function. For details, see the code (attached).

## Epics

### Create an external file

Task	Description	Skills required
Add an external file to the source database.	Create an external file, and move it to the <code>oracle</code> directory.	DBA

## Configure the target (Aurora PostgreSQL-Compatible)

Task	Description	Skills required
Create an Aurora PostgreSQL database.	Create a DB instance in your Amazon Aurora PostgreSQL-Compatible cluster.	DBA
Create a schema, <code>aws_s3</code> extension, and tables.	Use the code under <code>ext_tbl_scripts</code> in the <i>Additional information</i> section. The tables include actual tables, staging tables, error and log tables, and a metatable.	DBA, Developer
Create the DB function.	To create the DB function, use the code under <code>load_external_table_latest</code> function in the <i>Additional information</i> section.	DBA, Developer

## Create and configure the Lambda function

Task	Description	Skills required
Create a role.	Create a role with permissions to access Amazon S3 and Amazon Relational Database Service (Amazon RDS). This role will be assigned to Lambda for running the pattern.	DBA
Create the Lambda function.	Create a Lambda function that reads the file name from Amazon S3 (for example,	DBA

Task	Description	Skills required
	<p><code>file_key = info.get('object', {}).get('key') )</code> and calls the DB function (for example, <code>cursor.callproc("load_external_tables", [file_key])</code> ) with the file name as the input parameter.</p> <p>Depending on the function call result, an SNS notification will be initiated (for example, <code>client.publish(TopicArn='arn:', Message='fileloadsucces s', Subject='filelo adsuccess' )</code> ).</p> <p>Based on your business needs, you can create a Lambda function with extra code if required. For more information, see the <a href="#">Lambda documentation</a>.</p>	
Configure an S3 bucket event trigger.	Configure a mechanism to call the Lambda function for all object creation events in the S3 bucket.	DBA
Create a secret.	Create a secret name for the database credentials by using Secrets Manager. Pass the secret in the Lambda function.	DBA

Task	Description	Skills required
Upload the Lambda supporting files.	Upload a .zip file that contains the Lambda support packages and the attached Python script for connecting to Aurora PostgreSQL-Compatible. The Python code calls the function that you created in the database.	DBA
Create an SNS topic.	Create an SNS topic to send mail for the success or failure of the data load.	DBA

### Add integration with Amazon S3

Task	Description	Skills required
Create an S3 bucket.	On the Amazon S3 console, create an S3 bucket with a unique name that does not contain leading slashes. An S3 bucket name is globally unique, and the namespace is shared by all AWS accounts.	DBA
Create IAM policies.	To create the AWS Identity and Access Management (IAM) policies, use the code under <code>s3bucketpolicy_for_import</code> in the <i>Additional information</i> section.	DBA
Create roles.	Create two roles for Aurora PostgreSQL-Compatible,	DBA

Task	Description	Skills required
	one role for Import and one role for Export. Assign the corresponding policies to the roles.	
Attach the roles to the Aurora PostgreSQL-Compatible cluster.	Under <b>Manage roles</b> , attach the Import and Export roles to the Aurora PostgreSQL cluster.	DBA
Create supporting objects for Aurora PostgreSQL-Compatible.	<p>For the table scripts, use the code under <code>ext_tbl_scripts</code> in the <i>Additional information</i> section.</p> <p>For the custom function, use the code under <code>load_external_Table_latest</code> in the <i>Additional information</i> section.</p>	DBA

## Process a test file

Task	Description	Skills required
Upload a file into the S3 bucket.	<p>To upload a test file into the S3 bucket, use the console or the following command in AWS CLI.</p> <pre>aws s3 cp /Users/Desktop/ukpost/exttbl/"testing files"/aps s3://s3importtest/inputtext/aps</pre>	DBA

Task	Description	Skills required
	As soon as the file is uploaded, a bucket event initiates the Lambda function, which runs the Aurora PostgreSQL-Compatible function.	
Check the data and the log and error files.	The Aurora PostgreSQL-Compatible function loads the files into the main table, and it creates .log and .bad files in the S3 bucket.	DBA
Monitor the solution.	In the Amazon CloudWatch console, monitor the Lambda function.	DBA

## Related resources

- [Amazon S3 integration](#)
- [Amazon S3](#)
- [Working with Amazon Aurora PostgreSQL-Compatible Edition](#)
- [AWS Lambda](#)
- [Amazon CloudWatch](#)
- [AWS Secrets Manager](#)
- [Setting up Amazon SNS notifications](#)

## Additional information

### ext\_table\_scripts

```
CREATE EXTENSION aws_s3 CASCADE;
CREATE TABLE IF NOT EXISTS meta_EXTERNAL_TABLE
(
```

```
    table_name_stg character varying(100) ,
    table_name character varying(100) ,
    col_list character varying(1000) ,
    data_type character varying(100) ,
    col_order numeric,
    start_pos numeric,
    end_pos numeric,
    no_position character varying(100) ,
    date_mask character varying(100) ,
    delimiter character(1) ,
    directory character varying(100) ,
    file_name character varying(100) ,
    header_exist character varying(5)
);
CREATE TABLE IF NOT EXISTS ext_tbl_stg
(
    col1 text
);
CREATE TABLE IF NOT EXISTS error_table
(
    error_details text,
    file_name character varying(100),
    processed_time timestamp without time zone
);
CREATE TABLE IF NOT EXISTS log_table
(
    file_name character varying(50) COLLATE pg_catalog."default",
    processed_date timestamp without time zone,
    tot_rec_count numeric,
    proc_rec_count numeric,
    error_rec_count numeric
);
sample insert scripts of meta data:
INSERT INTO meta_EXTERNAL_TABLE (table_name_stg, table_name, col_list, data_type,
col_order, start_pos, end_pos, no_position, date_mask, delimiter, directory,
file_name, header_exist) VALUES ('F_EX_APS_TRANSACTIONSTG', 'F_EX_APS_TRANSACTIONSTG',
'source_filename', 'character varying', 2, 8, 27, NULL, NULL, NULL, 'databasedev',
'externalinterface/loadaddir/APS', 'NO');
INSERT INTO meta_EXTERNAL_TABLE (table_name_stg, table_name, col_list, data_type,
col_order, start_pos, end_pos, no_position, date_mask, delimiter, directory,
file_name, header_exist) VALUES ('F_EX_APS_TRANSACTIONSTG', 'F_EX_APS_TRANSACTIONSTG',
'record_type_identifier', 'character varying', 3, 28, 30, NULL, NULL, NULL,
'databasedev', 'externalinterface/loadaddir/APS', 'NO');
```



```

INSERT INTO meta_EXTERNAL_TABLE (table_name_stg, table_name, col_list, data_type,
col_order, start_pos, end_pos, no_position, date_mask, delimiter, directory,
file_name, header_exist) VALUES ('F_EX_APS_TRANSACTIONS_STG', 'F_EX_APS_TRANSACTIONS',
'fad_code', 'numeric', 4, 31, 36, NULL, NULL, NULL, 'databasedev', 'externalinterface/
loadir/APS', 'NO');
INSERT INTO meta_EXTERNAL_TABLE (table_name_stg, table_name, col_list, data_type,
col_order, start_pos, end_pos, no_position, date_mask, delimiter, directory,
file_name, header_exist) VALUES ('F_EX_APS_TRANSACTIONS_STG', 'F_EX_APS_TRANSACTIONS',
'session_sequence_number', 'numeric', 5, 37, 42, NULL, NULL, NULL, 'databasedev',
'externalinterface/loadir/APS', 'NO');
INSERT INTO meta_EXTERNAL_TABLE (table_name_stg, table_name, col_list, data_type,
col_order, start_pos, end_pos, no_position, date_mask, delimiter, directory,
file_name, header_exist) VALUES ('F_EX_APS_TRANSACTIONS_STG', 'F_EX_APS_TRANSACTIONS',
'transaction_sequence_number', 'numeric', 6, 43, 48, NULL, NULL, NULL, 'databasedev',
'externalinterface/loadir/APS', 'NO');

```

### s3bucketpolicy\_for import

```

---Import role policy
--Create an IAM policy to allow, Get, and list actions on S3 bucket
{
  "Version": "2012-10-17",
  "Statement": [
    {
      "Sid": "s3import",
      "Action": [
        "s3:GetObject",
        "s3:ListBucket"
      ],
      "Effect": "Allow",
      "Resource": [
        "arn:aws:s3:::s3importtest",
        "arn:aws:s3:::s3importtest/*"
      ]
    }
  ]
}
--Export Role policy
--Create an IAM policy to allow, put, and list actions on S3 bucket
{
  "Version": "2012-10-17",
  "Statement": [
    {

```

```

        "Sid": "s3export",
        "Action": [
            "S3:PutObject",
            "s3:ListBucket"
        ],
        "Effect": "Allow",
        "Resource": [
            "arn:aws:s3:::s3importtest/*"
        ]
    }
]
}

```

## Sample DB function load\_external\_tables\_latest

```

CREATE OR REPLACE FUNCTION public.load_external_tables(pi_filename text)
  RETURNS character varying
  LANGUAGE plpgsql
  AS $function$
/* Loading data from S3 bucket into a APG table */
DECLARE
  v_final_sql TEXT;
  pi_ext_table TEXT;
  r refCURSOR;
  v_sqlerrm text;
  v_chunk numeric;
  i integer;
  v_col_list TEXT;
  v_postion_list CHARACTER VARYING(1000);
  v_len integer;
  v_delim varchar;
  v_file_name CHARACTER VARYING(1000);
  v_directory CHARACTER VARYING(1000);
  v_table_name_stg CHARACTER VARYING(1000);
  v_sql_col TEXT;
  v_sql TEXT;
  v_sql1 TEXT;
  v_sql2 TEXT;
  v_sql3 TEXT;
  v_cnt integer;
  v_sql_dynamic TEXT;
  v_sql_ins TEXT;
  proc_rec_COUNT integer;

```

```
error_rec_COUNT integer;
tot_rec_COUNT integer;
v_rec_val integer;
rec record;
v_col_cnt integer;
kv record;
v_val text;
v_header text;
j integer;
ERCODE VARCHAR(5);
v_region text;
cr CURSOR FOR
SELECT distinct DELIMITER,
       FILE_NAME,
       DIRECTORY
FROM   meta_EXTERNAL_TABLE
WHERE  table_name = pi_ext_table
       AND DELIMITER IS NOT NULL;

cr1 CURSOR FOR
SELECT  col_list,
        data_type,
        start_pos,
        END_pos,
        concat_ws(' ',' ',TABLE_NAME_STG) as TABLE_NAME_STG,
        no_position,date_mask
FROM   meta_EXTERNAL_TABLE
WHERE  table_name = pi_ext_table
order by col_order asc;
cr2 cursor FOR
SELECT  distinct table_name,table_name_stg
FROM   meta_EXTERNAL_TABLE
WHERE  upper(file_name) = upper(pi_filename);

BEGIN
-- PERFORM utl_file_utility.init();
v_region := 'us-east-1';
/* find tab details from file name */

--DELETE FROM  ERROR_TABLE WHERE file_name= pi_filename;
-- DELETE FROM  log_table WHERE file_name= pi_filename;
```

```
BEGIN

    SELECT distinct table_name,table_name_stg INTO strict pi_ext_table,v_table_name_stg
    FROM meta_EXTERNAL_TABLE
    WHERE upper(file_name) = upper(pi_filename);
EXCEPTION
    WHEN NO_DATA_FOUND THEN
        raise notice 'error 1,%',sqlerrm;
        pi_ext_table := null;
        v_table_name_stg := null;
        RAISE USING errcode = 'NTFIP' ;
    when others then
        raise notice 'error others,%',sqlerrm;
END;
j :=1 ;

for rec in cr2
LOOP

    pi_ext_table      := rec.table_name;
    v_table_name_stg := rec.table_name_stg;
    v_col_list := null;

    IF pi_ext_table IS NOT NULL
    THEN
        --EXECUTE concat_ws('','truncate table  ',pi_ext_table) ;
        EXECUTE concat_ws('','truncate table  ',v_table_name_stg) ;

        SELECT distinct DELIMITER INTO STRICT v_delim
        FROM meta_EXTERNAL_TABLE
        WHERE table_name = pi_ext_table;

        IF v_delim IS NOT NULL THEN
```

```

SELECT distinct DELIMITER,
FILE_NAME,
DIRECTORY ,
concat_ws(' ',' ',table_name_stg),
case header_exist when 'YES' then 'CSV HEADER' else 'CSV' end as header_exist
INTO STRICT v_delim,v_file_name,v_directory,v_table_name_stg,v_header
FROM meta_EXTERNAL_TABLE
WHERE table_name = pi_ext_table
AND DELIMITER IS NOT NULL;

IF upper(v_delim) = 'CSV'
THEN
v_sql := concat_ws('','SELECT aws_s3.table_import_FROM_s3 ( ''',
v_table_name_stg,'','''',
'DELIMITER ''','''', CSV HEADER QUOTE ''''''''''', aws_commons.create_s3_uri
( ''',
v_directory,'','''',v_file_name,'','''',v_region,''''))');
ELSE
v_sql := concat_ws('','SELECT aws_s3.table_import_FROM_s3(''',
v_table_name_stg, ''','''', 'DELIMITER AS ''''^''''',''','',
aws_commons.create_s3_uri
( ''',v_directory, ''','''',
v_file_name, ''','',
''''',v_region,'''')
)');
raise notice 'v_sql , %',v_sql;
begin
EXECUTE v_sql;
EXCEPTION
WHEN OTHERS THEN
raise notice 'error 1';
RAISE USING errcode = 'S3IMP' ;
END;

select count(col_list) INTO v_col_cnt
from meta_EXTERNAL_TABLE where table_name = pi_ext_table;

```

```

-- raise notice 'v_sql 2, %',concat_ws('','update ',v_table_name_stg, ' set
coll = coll||''',v_delim, '');

execute concat_ws('','update ',v_table_name_stg, ' set coll =
coll||''',v_delim, '');

i :=1;
FOR rec in cr1
loop
v_sql1 := concat_ws('','v_sql1','split_part(coll,','',v_delim, '', i,')', ' as
',rec.col_list, ',');
v_sql2 := concat_ws('','v_sql2,rec.col_list, ',');
-- v_sql3 := concat_ws('','v_sql3, 'rec.',rec.col_list, '::',rec.data_type, ',');

case
WHEN upper(rec.data_type) = 'NUMERIC'
THEN v_sql3 := concat_ws('','v_sql3, ' case WHEN
length(trim(split_part(coll,','',v_delim, '', i,))) =0
THEN null
ELSE
coalesce((trim(split_part(coll,','',v_delim, '', i,)))::NUMERIC,0)::',rec.data_type, ' END as ',rec.col_list, ',') ;
WHEN UPPER(rec.data_type) = 'TIMESTAMP WITHOUT TIME ZONE' AND rec.date_mask =
'YYYYMMDD'
THEN v_sql3 := concat_ws('','v_sql3, ' case WHEN
length(trim(split_part(coll,','',v_delim, '', i,))) =0
THEN null
ELSE
to_date(coalesce((trim(split_part(coll,','',v_delim, '', i,))), '99990101'), 'YYYYMMDD')::',rec.data_type, ' END as ',rec.col_list, ',');
WHEN UPPER(rec.data_type) = 'TIMESTAMP WITHOUT TIME ZONE' AND rec.date_mask =
'MM/DD/YYYY hh24:mi:ss'
THEN v_sql3 := concat_ws('','v_sql3, ' case WHEN
length(trim(split_part(coll,','',v_delim, '', i,))) =0
THEN null
ELSE
to_date(coalesce((trim(split_part(coll,','',v_delim, '', i,))), '01/01/9999 0024:00:00'), 'MM/DD/YYYY hh24:mi:ss')::',rec.data_type, ' END as
',rec.col_list, ',');

```

```

        ELSE
            v_sql3 := concat_ws(' ',v_sql3,' case WHEN
length(trim(split_part(col1,' ',v_delim,' ', i,'))) =0
        THEN null
        ELSE
            coalesce((trim(split_part(col1,' ',v_delim,' ',',
i,'))),''')::',rec.data_type,' END as ',rec.col_list,',') ;
        END case;

i :=i+1;
end loop;

-- raise notice 'v_sql 3, %',v_sql3;

SELECT trim(trailing ' ' FROM v_sql1) INTO v_sql1;
SELECT trim(trailing ',' FROM v_sql1) INTO v_sql1;

SELECT trim(trailing ' ' FROM v_sql2) INTO v_sql2;
SELECT trim(trailing ',' FROM v_sql2) INTO v_sql2;

SELECT trim(trailing ' ' FROM v_sql3) INTO v_sql3;
SELECT trim(trailing ',' FROM v_sql3) INTO v_sql3;

END IF;
raise notice 'v_delim , %',v_delim;

EXECUTE concat_ws(' ','SELECT COUNT(*) FROM ',v_table_name_stg) INTO v_cnt;

raise notice 'stg cnt , %',v_cnt;

/* if upper(v_delim) = 'CSV' then
    v_sql_ins := concat_ws(' ', ' SELECT * from ' ,v_table_name_stg );
else
    -- v_sql_ins := concat_ws(' ',' SELECT ',v_sql1,' from (select col1 from
',v_table_name_stg , ')sub ');

```

```
        v_sql_ins := concat_ws('',' SELECT ',v_sql3,' from (select col1 from
',v_table_name_stg , ')sub ');
        END IF;*/

v_chunk := v_cnt/100;

for i in 1..101
loop
    BEGIN
        -- raise notice 'v_sql , %',v_sql;
        -- raise notice 'Chunk number , %',i;
        v_sql_ins := concat_ws('',' SELECT ',v_sql3,' from (select col1 from
',v_table_name_stg , ' offset ',v_chunk*(i-1), ' limit ',v_chunk,') sub ');

        v_sql := concat_ws('','insert into ', pi_ext_table , ' ', v_sql_ins);
        -- raise notice 'select statement , %',v_sql_ins;
        -- v_sql := null;
        -- EXECUTE concat_ws('','insert into ', pi_ext_table , ' ', v_sql_ins, 'offset
',v_chunk*(i-1), ' limit ',v_chunk );
        --v_sql := concat_ws('','insert into ', pi_ext_table , ' ', v_sql_ins );

        -- raise notice 'insert statement , %',v_sql;

        raise NOTICE 'CHUNK START %',v_chunk*(i-1);
        raise NOTICE 'CHUNK END %',v_chunk;

        EXECUTE v_sql;

    EXCEPTION
        WHEN OTHERS THEN
            -- v_sql_ins := concat_ws('',' SELECT ',v_sql1, ' from (select col1 from
',v_table_name_stg , ' )sub ');
            -- raise notice 'Chunk number for cursor , %',i;
```



```

    raise NOTICE 'Cursor - CHUNK START %',v_chunk*(i-1);
raise NOTICE 'Cursor -  CHUNK END %',v_chunk;
    v_sql_ins := concat_ws('',' SELECT ',v_sql3, ' from (select col1 from
',v_table_name_stg , ' )sub ');

    v_final_sql := REPLACE (v_sql_ins, ''':::text, ''''':::text);
-- raise notice 'v_final_sql %',v_final_sql;
    v_sql :=concat_ws('','do $$ declare  r refcursor;v_sql text; i
numeric;v_conname text;  v_typ  ',pi_ext_table,'[]; v_rec  ','record',';
    begin

        open r for execute 'select col1 from ',v_table_name_stg ,' offset
',v_chunk*(i-1), ' limit ',v_chunk,'';
        loop
        begin
        fetch r into v_rec;
        EXIT WHEN NOT FOUND;

        v_sql := concat_ws('','insert into ',pi_ext_table,' SELECT ',REPLACE
(v_sql3, ''':::text, ''''':::text) , ' from ( select ''''',v_rec.col1,''''' as
col1) v');
        execute v_sql;

        exception
        when others then
            v_sql := 'INSERT INTO  ERROR_TABLE VALUES (concat_ws('''''''',''''Error
Name: ''',$$''||SQLERRM||''$$, ''''Error State: ''', ''''''||
SQLSTATE||''''''', ''''record : ''',$$''||v_rec.col1||''$$), ''''''||
pi_filename||''''',now())''';

            execute v_sql;
            continue;
        end ;

```

```

        end loop;
        close r;
        exception
        when others then
        raise;
        end ; $$');
-- raise notice ' inside excp v_sql %',v_sql;
        execute v_sql;
-- raise notice 'v_sql %',v_sql;
    END;
END LOOP;
ELSE

SELECT distinct DELIMITER,FILE_NAME,DIRECTORY ,concat_ws(' ',' ',table_name_stg),
    case header_exist when 'YES' then 'CSV HEADER' else 'CSV' end as header_exist
    INTO STRICT v_delim,v_file_name,v_directory,v_table_name_stg,v_header
FROM meta_EXTERNAL_TABLE
WHERE table_name = pi_ext_table          ;
v_sql := concat_ws('','SELECT aws_s3.table_import_FROM_s3(''',
    v_table_name_stg, ''','''', ''DELIMITER AS ''''#'''' ',v_header,' ','',
aws_commons.create_s3_uri
    ( ''',v_directory, ''','''',
    v_file_name, ''','',
    ''',v_region, ''')
)');
    EXECUTE v_sql;

FOR rec in cr1
LOOP

    IF rec.start_pos IS NULL AND rec.END_pos IS NULL AND rec.no_position = 'recnum'
    THEN
        v_rec_val := 1;
    ELSE

        case
            WHEN upper(rec.data_type) = 'NUMERIC'
            THEN v_sql1 := concat_ws('',' case WHEN length(trim(substring(COL1,
',rec.start_pos ',' ', rec.END_pos, '- ',rec.start_pos ,'+1))) =0
                THEN null

```

```

        ELSE
            coalesce((trim(substring(COL1, ',rec.start_pos ',' ,
rec.END_pos, '-',rec.start_pos ,'+1))))::NUMERIC,0)::',rec.data_type,' END as
',rec.col_list,',') ;
            WHEN UPPER(rec.data_type) = 'TIMESTAMP WITHOUT TIME ZONE' AND rec.date_mask =
'YYYYMMDD'
            THEN v_sql1 := concat_ws('','case WHEN length(trim(substring(COL1,
',rec.start_pos ',' , rec.END_pos, '-',rec.start_pos ,'+1))) =0
            THEN null
            ELSE
                to_date(coalesce((trim(substring(COL1, ',rec.start_pos ',' ,
rec.END_pos, '-',rec.start_pos ,'+1))), '99990101'), 'YYYYMMDD')::',rec.data_type,'
END as ',rec.col_list,',');
            WHEN UPPER(rec.data_type) = 'TIMESTAMP WITHOUT TIME ZONE' AND rec.date_mask =
'YYYYMMDDHH24MISS'
            THEN v_sql1 := concat_ws('','case WHEN length(trim(substring(COL1,
',rec.start_pos ',' , rec.END_pos, '-',rec.start_pos ,'+1))) =0
            THEN null
            ELSE
                to_date(coalesce((trim(substring(COL1, ',rec.start_pos ',' ,
rec.END_pos, '-',rec.start_pos ,'+1))), '9999010100240000'), 'YYYYMMDDHH24MISS')::',rec.data_
END as ',rec.col_list,',');
            ELSE
                v_sql1 := concat_ws('',' case WHEN length(trim(substring(COL1,
',rec.start_pos ',' , rec.END_pos, '-',rec.start_pos ,'+1))) =0
            THEN null
            ELSE
                coalesce((trim(substring(COL1, ',rec.start_pos ',' ,
rec.END_pos, '-',rec.start_pos ,'+1))), '')::',rec.data_type,' END as
',rec.col_list,',') ;
            END case;

    END IF;
    v_col_list := concat_ws(' ',v_col_list ,v_sql1);
END LOOP;

SELECT trim(trailing ' ' FROM v_col_list) INTO v_col_list;
SELECT trim(trailing ',' FROM v_col_list) INTO v_col_list;

```

```

        v_sql_col := concat_ws(' ', trim(trailing ' ' FROM v_col_list) , ' FROM
        ', v_table_name_stg, ' WHERE col1 IS NOT NULL AND length(col1)>0 ');

        v_sql_dynamic := v_sql_col;

        EXECUTE concat_ws(' ', 'SELECT COUNT(*) FROM ', v_table_name_stg) INTO v_cnt;

        IF v_rec_val = 1 THEN
            v_sql_ins := concat_ws(' ', ' select row_number() over(order by ctid) as
            line_number ', ' ', v_sql_dynamic) ;

        ELSE
            v_sql_ins := concat_ws(' ', ' SELECT' , v_sql_dynamic) ;
        END IF;

        BEGIN
            EXECUTE concat_ws(' ', 'insert into ', pi_ext_table , ' ', v_sql_ins);
            EXCEPTION
                WHEN OTHERS THEN
                    IF v_rec_val = 1 THEN
                        v_final_sql := ' select row_number() over(order by ctid) as
                        line_number ,col1 from ' ;
                    ELSE
                        v_final_sql := ' SELECT col1 from';
                    END IF;
            v_sql := concat_ws(' ', 'do $$ declare r refcursor;v_rec_val numeric :=
            ', coalesce(v_rec_val, 0), ';line_number numeric; col1 text; v_typ ', pi_ext_table, '[';
            v_rec ', pi_ext_table, ';
            begin
                open r for execute ' ', v_final_sql, ' ', v_table_name_stg, ' WHERE col1 IS
            NOT NULL AND length(col1)>0 ' ' ;
            loop
                begin
                    if v_rec_val = 1 then
                        fetch r into line_number, col1;

```

```
        else
        fetch r into col1;
        end if;

EXIT WHEN NOT FOUND;
if v_rec_val = 1 then
select line_number,',trim(trailing ',' FROM v_col_list) ,' into v_rec;
else
    select ',trim(trailing ',' FROM v_col_list) ,' into v_rec;
end if;

insert into ',pi_ext_table,' select v_rec.*;
exception
when others then
    INSERT INTO ERROR_TABLE VALUES (concat_ws('','','Error Name:
'',SQLERRM,'Error State: ',SQLSTATE,'record : ',v_rec),'',pi_filename,'',now());
    continue;
end ;
end loop;
close r;
exception
when others then
raise;
end ; $$');
execute v_sql;

END;

END IF;

EXECUTE concat_ws('','SELECT COUNT(*) FROM ',pi_ext_table) INTO proc_rec_COUNT;

EXECUTE concat_ws('','SELECT COUNT(*) FROM error_table WHERE file_name
='',pi_filename,''' and processed_time::date = clock_timestamp()::date') INTO
error_rec_COUNT;

EXECUTE concat_ws('','SELECT COUNT(*) FROM ',v_table_name_stg) INTO tot_rec_COUNT;
```

```
INSERT INTO log_table values(pi_filename,now(),tot_rec_COUNT,proc_rec_COUNT,
error_rec_COUNT);

raise notice 'v_directory, %',v_directory;

raise notice 'pi_filename, %',pi_filename;

raise notice 'v_region, %',v_region;

perform aws_s3.query_export_to_s3('SELECT
replace(trim(substring(error_details,position('(' in
error_details)+1),'')'),',' ',';'),file_name,processed_time FROM error_table WHERE
file_name = ''||pi_filename||'',
aws_commons.create_s3_uri(v_directory, pi_filename||'.bad', v_region),
options :='FOrmat csv, header, delimiter $$,$$'
);

raise notice 'v_directory, %',v_directory;

raise notice 'pi_filename, %',pi_filename;

raise notice 'v_region, %',v_region;

perform aws_s3.query_export_to_s3('SELECT * FROM log_table WHERE file_name = ''||
pi_filename||'',
aws_commons.create_s3_uri(v_directory, pi_filename||'.log', v_region),
options :='FOrmat csv, header, delimiter $$,$$'
);

END IF;
j := j+1;
```

```
END LOOP;

        RETURN 'OK';
EXCEPTION
    WHEN OTHERS THEN
raise notice 'error %',sqlerrm;
    ERCODE=SQLSTATE;
    IF ERCODE = 'NTFIP' THEN
        v_sqlerrm := concat_ws(' ',sqlerrm,'No data for the filename');
    ELSIF ERCODE = 'S3IMP' THEN
        v_sqlerrm := concat_ws(' ',sqlerrm,'Error While exporting the file from S3');
    ELSE
        v_sqlerrm := sqlerrm;
    END IF;

select distinct directory into v_directory from meta_EXTERNAL_TABLE;

raise notice 'exc v_directory, %',v_directory;

    raise notice 'exc pi_filename, %',pi_filename;

    raise notice 'exc v_region, %',v_region;

    perform aws_s3.query_export_to_s3('SELECT * FROM error_table WHERE file_name = '''||
pi_filename||''''',
    aws_commons.create_s3_uri(v_directory, pi_filename||'.bad', v_region),
    options :='FOrmat csv, header, delimiter $$,$$'
    );
    RETURN null;
END;
$function$
```

# Migrate function-based indexes from Oracle to PostgreSQL

Created by Veeranjanyulu Grandhi (AWS) and Navakanth Talluri (AWS)

<b>Environment:</b> Production	<b>Source:</b> Oracle	<b>Target:</b> PostgreSQL
<b>R Type:</b> Re-architect	<b>Workload:</b> Oracle	<b>Technologies:</b> Migration; Databases

## Summary

Indexes are a common way to enhance database performance. An index allows the database server to find and retrieve specific rows much faster than it could without an index. But indexes also add overhead to the database system as a whole, so they should be used sensibly. Function-based indexes, which are based on a function or expression, can involve multiple columns and mathematical expressions. A function-based index improves the performance of queries that use the index expression.

Natively, PostgreSQL doesn't support creating function-based indexes using functions that have volatility defined as stable. However, you can create similar functions with volatility as IMMUTABLE and use them in index creation.

An IMMUTABLE function cannot modify the database, and it's guaranteed to return the same results given the same arguments forever. This category allows the optimizer to pre-evaluate the function when a query calls it with constant arguments.

This pattern helps in migrating the Oracle function-based indexes when used with functions such as `to_char`, `to_date`, and `to_number` to the PostgreSQL equivalent.

## Prerequisites and limitations

### Prerequisites

- An active Amazon Web Services (AWS) account
- A source Oracle database instance with the listener service set up and running
- Familiarity with PostgreSQL databases

### Limitations



- Database size limit is 64 TB.
- Functions used in index creation must be IMMUTABLE.

## Product versions

- All Oracle database editions for versions 11g (versions 11.2.0.3.v1 and later) and up to 12.2, and 18c
- PostgreSQL versions 9.6 and later

## Architecture

### Source technology stack

- An Oracle database on premises or on an Amazon Elastic Compute Cloud (Amazon EC2) instance, or an Amazon RDS for Oracle DB instance

### Target technology stack

- Any PostgreSQL engine

## Tools

- **pgAdmin 4** is an open source management tool for Postgres. The pgAdmin 4 tool provides a graphical interface for creating, maintaining, and using database objects.
- **Oracle SQL Developer** is an integrated development environment (IDE) for developing and managing Oracle Database in both traditional and cloud deployments.

## Epics

### Create a function-based index using a default function

Task	Description	Skills required
Create a function-based index on a column using the <code>to_char</code> function.	Use the following code to create the function-based index.	DBA, App developer

Task	Description	Skills required
	<pre> postgres=# create table funcindex( col1 timestamp without time zone); CREATE TABLE postgres=# insert into funcindex values (now()); INSERT 0 1 postgres=# select * from funcindex;           col1 ----- ----- 2022-08-09 16:00:57. 77414 (1 rows)  postgres=# create index funcindex_idx on funcindex(to_char( col1, 'DD-MM-YYYY HH24:MI:SS')); ERROR:  functions in index expression must be marked IMMUTABLE </pre> <p><b>Note:</b> PostgreSQL doesn't allow creating a function-based index without the IMMUTABLE clause.</p>	
Check the volatility of the function.	To check the function volatility, use the code in the <i>Additional information</i> section.	DBA

## Create function-based indexes using a wrapper function

Task	Description	Skills required
Create a wrapper function.	To create a wrapper function, use the code in the <i>Additional information section</i> .	PostgreSQL developer
Create an index by using the wrapper function.	<p>Use the code in the <i>Additional information section</i> to create a user-defined function with the keyword IMMUTABLE in the same schema as the application, and refer to it in the index-creation script.</p> <p>If a user-defined function is created in a common schema (from the previous example), update the <code>search_path</code> as shown.</p> <pre>ALTER ROLE &lt;ROLENAME&gt; set search_path=\$user, COMMON;</pre>	DBA, PostgreSQL developer

## Validate index creation

Task	Description	Skills required
Validate index creation.	Validate that the index needs to be created, based on query access patterns.	DBA
Validate that the index can be used.	To check whether the function-based index is picked up by the PostgreSQL	DBA

Task	Description	Skills required
	<p>L Optimizer, run an SQL statement using explain or explain analyze. Use the code in the <i>Additional information</i> section. If possible, gather the table statistics as well.</p> <p><b>Note:</b> If you notice the explain plan, PostgreSQL optimizer has chosen a function-based index because of the predicate condition.</p>	

## Related resources

- [Function-based indexes](#) (Oracle documentation)
- [Indexes on Expressions](#) (PostgreSQL documentation)
- [PostgreSQL volatility](#) (PostgreSQL documentation)
- [PostgreSQL search\\_path](#) (PostgreSQL documentation)
- [Oracle Database 19c to Amazon Aurora PostgreSQL Migration Playbook](#)

## Additional information

### Create a wrapper function

```
CREATE OR REPLACE FUNCTION myschema.to_char(var1 timestamp without time zone, var2
varchar) RETURNS varchar AS $BODY$ select to_char(var1, 'YYYYMMDD'); $BODY$ LANGUAGE
sql IMMUTABLE;
```

### Create an index by using the wrapper function

```
postgres=# create function common.to_char(var1 timestamp without time zone, var2
varchar) RETURNS varchar AS $BODY$ select to_char(var1, 'YYYYMMDD'); $BODY$ LANGUAGE
sql IMMUTABLE;
CREATE FUNCTION
```

```
postgres=# create index funcindex_idx on funcindex(common.to_char(col1,'DD-MM-YYYY
HH24:MI:SS'));
CREATE INDEX
```

## Check the volatility of the function

```
SELECT DISTINCT p.proname as "Name",p.provolatile as "volatility" FROM
pg_catalog.pg_proc p
LEFT JOIN pg_catalog.pg_namespace n ON n.oid = p.pronamespace
LEFT JOIN pg_catalog.pg_language l ON l.oid = p.prolang
WHERE n.nspname OPERATOR(pg_catalog.~) '^(pg_catalog)$' COLLATE pg_catalog.default AND
p.proname='to_char'GROUP BY p.proname,p.provolatile
ORDER BY 1;
```

## Validate that the index can be used

```
explain analyze <SQL>
```

```
postgres=# explain select col1 from funcindex where common.to_char(col1,'DD-MM-YYYY
HH24:MI:SS') = '09-08-2022 16:00:57';
```

QUERY PLAN

```
-----
Index Scan using funcindex_idx on funcindex (cost=0.42..8.44 rows=1 width=8)
  Index Cond: ((common.to_char(col1, 'DD-MM-YYYY HH24:MI:SS'::character
varying))::text = '09-08-2022 16:00:57'::text)
(2 rows)
```

# Migrate Oracle native functions to PostgreSQL using extensions

Created by Pinesh Singal (AWS)

<b>Environment:</b> PoC or pilot	<b>Source:</b> Databases: Relational	<b>Target:</b> Amazon RDS PostgreSQL
<b>R Type:</b> Re-architect	<b>Workload:</b> Oracle; Open-source	<b>Technologies:</b> Migration; Databases
<b>AWS services:</b> Amazon EC2; Amazon RDS		

## Summary

This migration pattern provides step-by-step guidance for migrating an Amazon Relational Database Service (Amazon RDS) for Oracle database instance to an Amazon RDS for PostgreSQL or Amazon Aurora PostgreSQL-Compatible Edition database by modifying the `aws_oracle_ext` and `orafce` extensions to PostgreSQL (`psql`) native built-in code. This will save processing time.

The pattern describes an offline manual migration strategy with no downtime for a multi-terabyte Oracle source database with a high number of transactions.

The migration process uses AWS Schema Conversion Tool (AWS SCT) with the `aws_oracle_ext` and `orafce` extensions to convert an Amazon RDS for Oracle database schema to an Amazon RDS for PostgreSQL or Aurora PostgreSQL-Compatible database schema. Then the code is manually changed to PostgreSQL supported native `psql` built-in code. This is because the extension calls impact code processing on the PostgreSQL database server, and not all the extension code is fully complaint or compatible with PostgreSQL code.

This pattern primarily focuses on manually migrating SQL codes using AWS SCT and the extensions `aws_oracle_ext` and `orafce`. You convert the already used extensions into native PostgreSQL (`psql`) built-ins. Then you remove all references to the extensions and convert the codes accordingly.

## Prerequisites and limitations

### Prerequisites

- An active AWS account
- Operating system (Windows or Mac) or Amazon EC2 instance (up and running)
- Orafce

## Limitations

Not all Oracle functions using `aws_oracle_ext` or `orafce` extensions can be converted to native PostgreSQL functions. It might need manual rework so as to compile it with PostgreSQL libraries.

One drawback of using AWS SCT extensions is its slow performance in running and fetching the results. Its cost can be understood from simple [PostgreSQL EXPLAIN plan](#) (execution plan of a statement) on the Oracle `SYSDATE` function migration to the PostgreSQL `NOW( )` function between all three codes (`aws_oracle_ext`, `orafce`, and `psql` default), as explained in the *Performance comparison check* section in the attached document.

## Product versions

- **Source:** Amazon RDS for Oracle database 10.2 and later (for 10.x), 11g (11.2.0.3.v1 and later) and up to 12.2, 18c, and 19c (and later) for Enterprise Edition, Standard Edition, Standard Edition 1, and Standard Edition 2
- **Target:** Amazon RDS for PostgreSQL or Aurora PostgreSQL-Compatible database 9.4 and later (for 9.x), 10.x, 11.x, 12.x, 13.x, and 14.x (and later)
- **AWS SCT:** Latest version (this pattern was tested with 1.0.632)
- **Orafce:** Latest version (this pattern was tested with 3.9.0)

## Architecture

### Source technology stack

- An Amazon RDS for Oracle database instance with version 12.1.0.2.v18

### Target technology stack

- An Amazon RDS for PostgreSQL or Aurora PostgreSQL-Compatible database instance with version 11.5

## Database migration architecture

The following diagram represents the database migration architecture between the source Oracle and target PostgreSQL databases. The architecture involves AWS Cloud, a virtual private cloud (VPC), Availability Zones, a private subnet, an Amazon RDS for Oracle database, AWS SCT, an Amazon RDS for PostgreSQL or Aurora PostgreSQL-Compatible database, extensions for Oracle (`aws_oracle_ext` and `orafce`), and structured query language (SQL) files.

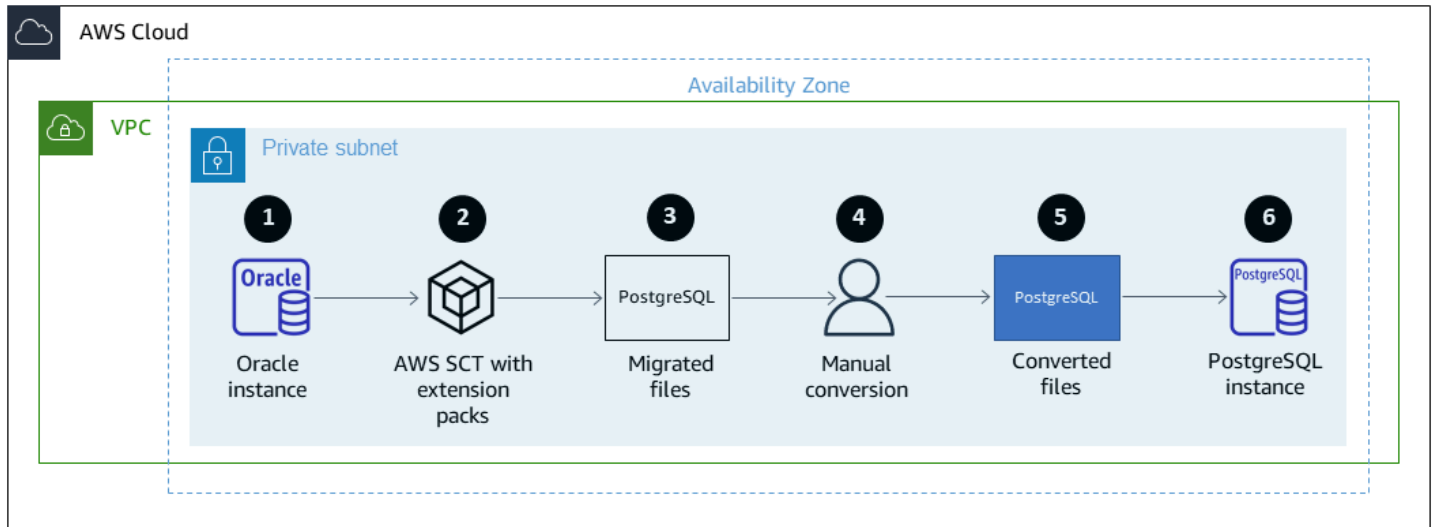

1. Launch Amazon RDS for Oracle DB instance (source DB).
2. Use AWS SCT with the `aws_oracle_ext` and `orafce` extension packs to convert the source code from Oracle to PostgreSQL.
3. The conversion produces PostgreSQL-supported migrated `.sql` files.
4. Manually convert the non-converted Oracle extension codes to PostgreSQL (`psql`) codes.
5. The manual conversion produces PostgreSQL-supported converted `.sql` files.
6. Run these `.sql` files on your Amazon RDS for PostgreSQL DB instance (target DB).

## Tools

### Tools

#### *AWS services*

- [AWS SCT](#) - AWS Schema Conversion Tool (AWS SCT) converts your existing database schema from one database engine to another. You can convert relational Online Transactional Processing (OLTP) schema, or data warehouse schema. Your converted schema is suitable for an Amazon RDS for MySQL DB instance, an Amazon Aurora DB cluster, an Amazon RDS for PostgreSQL DB



instance, or an Amazon Redshift cluster. The converted schema can also be used with a database on an Amazon EC2 instance or stored as data in an Amazon S3 bucket.

AWS SCT provides a project-based user interface to automatically convert the database schema of your source database into a format compatible with your target Amazon RDS instance.

You can use AWS SCT to do migration from an Oracle source database to any of the targets listed preceding. Using AWS SCT, you can export the source database object definitions such as schema, views, stored procedures, and functions.

You can use AWS SCT to convert data from Oracle to Amazon RDS for PostgreSQL or Amazon Aurora PostgreSQL-Compatible Edition.

In this pattern, you use AWS SCT to convert and migrate Oracle code into PostgreSQL using the extensions `aws_oracle_ext` and `orafce`, and manually migrating the extension codes into `psql` default or native built-in code.

- The [AWS SCT](#) extension pack is an add-on module that emulates functions present in the source database that are required when converting objects to the target database. Before you can install the AWS SCT extension pack, you need to convert your database schema.

When you convert your database or data warehouse schema, AWS SCT adds an additional schema to your target database. This schema implements SQL system functions of the source database that are required when writing your converted schema to your target database. This additional schema is called the extension pack schema.

The extension pack schema for OLTP databases is named according to the source database. For Oracle databases, the extension pack schema is `AWS_ORACLE_EXT`.

### *Other tools*

- [Orafce](#) – Orafce is a module that implements Oracle compatible functions, data types, and packages. It's an open-source tool with a Berkeley Source Distribution (BSD) license so that anyone can use it. The `orafce` module is useful for migrating from Oracle to PostgreSQL because it has many Oracle functions implemented in PostgreSQL.

## **Code**

For a list of all commonly used and migrated code from Oracle to PostgreSQL to avoid AWS SCT extension code usage, see the attached document.

## Epics

### Configure the Amazon RDS for Oracle source database

Task	Description	Skills required
Create the Oracle database instance.	Create an Amazon RDS for Oracle or Aurora PostgreSQL-Compatible database instance from the Amazon RDS console.	General AWS, DBA
Configure the security groups.	Configure inbound and outbound security groups.	General AWS
Create the database.	Create the Oracle database with needed users and schemas.	General AWS, DBA
Create the objects.	Create objects and insert data in schema.	DBA

### Configure the Amazon RDS for PostgreSQL target database

Task	Description	Skills required
Create the PostgreSQL database instance.	Create an Amazon RDS for PostgreSQL or Amazon Aurora PostgreSQL database instance from the Amazon RDS console.	General AWS, DBA
Configure the security groups.	Configure inbound and outbound security groups.	General AWS

Task	Description	Skills required
Create the database.	Create the PostgreSQL database with needed users and schemas.	General AWS, DBA
Validate the extensions.	Make sure that <code>aws_oracle_ext</code> and <code>orafce</code> are installed and configured correctly in the PostgreSQL database.	DBA
Verify that the PostgreSQL database is available.	Make sure that the PostgreSQL database is up and running.	DBA

### Migrate the Oracle schema into PostgreSQL using AWS SCT and the extensions

Task	Description	Skills required
Install AWS SCT.	Install the latest version of AWS SCT.	DBA
Configure AWS SCT.	Configure AWS SCT with Java Database Connectivity (JDBC) drivers for Oracle ( <code>ojdbc8.jar</code> ) and PostgreSQL ( <code>postgresql-42.2.5.jar</code> ).	DBA
Enable the AWS SCT extension pack or template.	Under AWS SCT <b>Project Settings</b> , enable built-in function implementation with the <code>aws_oracle_ext</code> and <code>orafce</code> extensions for the Oracle database schema.	DBA

Task	Description	Skills required
Convert the schema.	In AWS SCT, choose <b>Convert Schema</b> to convert the schema from Oracle to PostgreSQL and generate the .sql files.	DBA

## Convert AWS SCT extension code to psql code

Task	Description	Skills required
Manually convert the code.	Manually convert each line of extension-supported code into psql default built-in code, as detailed in the attached document. For example, change <code>AWS_ORACLE_EXT.SYSDATE()</code> or <code>ORACLE.SYSDATE()</code> to <code>NOW()</code> .	DBA
Validate the code	(Optional) Validate each line of code by temporarily running it in the PostgreSQL database.	DBA
Create objects in the PostgreSQL database.	To create objects in the PostgreSQL database, run the .sql files that were generated by AWS SCT and modified in the previous two steps.	DBA

## Related resources

- Database

- [Oracle on Amazon RDS](#)
- [PostgreSQL on Amazon RDS](#)
- [Working with Amazon Aurora PostgreSQL](#)
- [PostgreSQL EXPLAIN plan](#)
- AWS SCT
  - [AWS Schema Conversion Tool Overview](#)
  - [AWS SCT User Guide](#)
  - [Using the AWS SCT user interface](#)
  - [Using Oracle Database as a source for AWS SCT](#)
- Extensions for AWS SCT
  - [Using the AWS SCT extension pack](#)
  - [Oracle functionality \(en\)](#)
  - [PGXN orafce](#)
  - [GitHub orafce](#)

## Additional information

For more information, follow the detailed commands, with syntax and examples, for manually converting code in the attached document.

## Attachments

To access additional content that is associated with this document, unzip the following file:  
[attachment.zip](#)

# Migrate a Db2 database from Amazon EC2 to Aurora MySQL-Compatible by using AWS DMS

Created by Pinesh Singal (AWS)

<b>Environment:</b> PoC or pilot	<b>Source:</b> IBM Db2 on Amazon EC2	<b>Target:</b> Amazon Aurora MySQL-Compatible Edition
<b>R Type:</b> Re-architect	<b>Workload:</b> IBM	<b>Technologies:</b> Migration; Databases
<b>AWS services:</b> AWS DMS; Amazon EC2; AWS SCT; Amazon Aurora		

## Summary

After you migrate your [IBM Db2 for LUW database](#) to [Amazon Elastic Compute Cloud \(Amazon EC2\)](#), consider re-architecting the database by moving to an Amazon Web Services (AWS) cloud-native database. This pattern covers migrating an IBM [Db2](#) for LUW database running on an [Amazon EC2](#) instance to an [Amazon Aurora MySQL-Compatible Edition](#) database on AWS.

The pattern describes an online migration strategy with minimal downtime for a multi-terabyte Db2 source database with a high number of transactions.

This pattern uses [AWS Schema Conversion Tool \(AWS SCT\)](#) to convert the Db2 database schema to an Aurora MySQL-Compatible schema. Then the pattern uses [AWS Database Migration Service \(AWS DMS\)](#) to migrate data from the Db2 database to the Aurora MySQL-Compatible database. Manual conversions will be required for the code that isn't converted by AWS SCT.

## Prerequisites and limitations

### Prerequisites

- An active AWS account with a virtual private cloud (VPC)
- AWS SCT

- AWS DMS

## Product versions

- AWS SCT latest version
- Db2 for Linux version 11.1.4.4 and later

## Architecture

### Source technology stack

- DB2/Linux x86-64 bit mounted on an EC2 instance

### Target technology stack

- An Amazon Aurora MySQL-Compatible Edition database instance

### Source and target architecture

The following diagram shows the data migration architecture between the source Db2 and target Aurora MySQL-Compatible databases. The architecture on the AWS Cloud includes a virtual private cloud (VPC) (Virtual Private Cloud), an Availability Zone, a public subnet for the Db2 instance and the AWS DMS replication instance, and a private subnet for the Aurora MySQL-Compatible database.

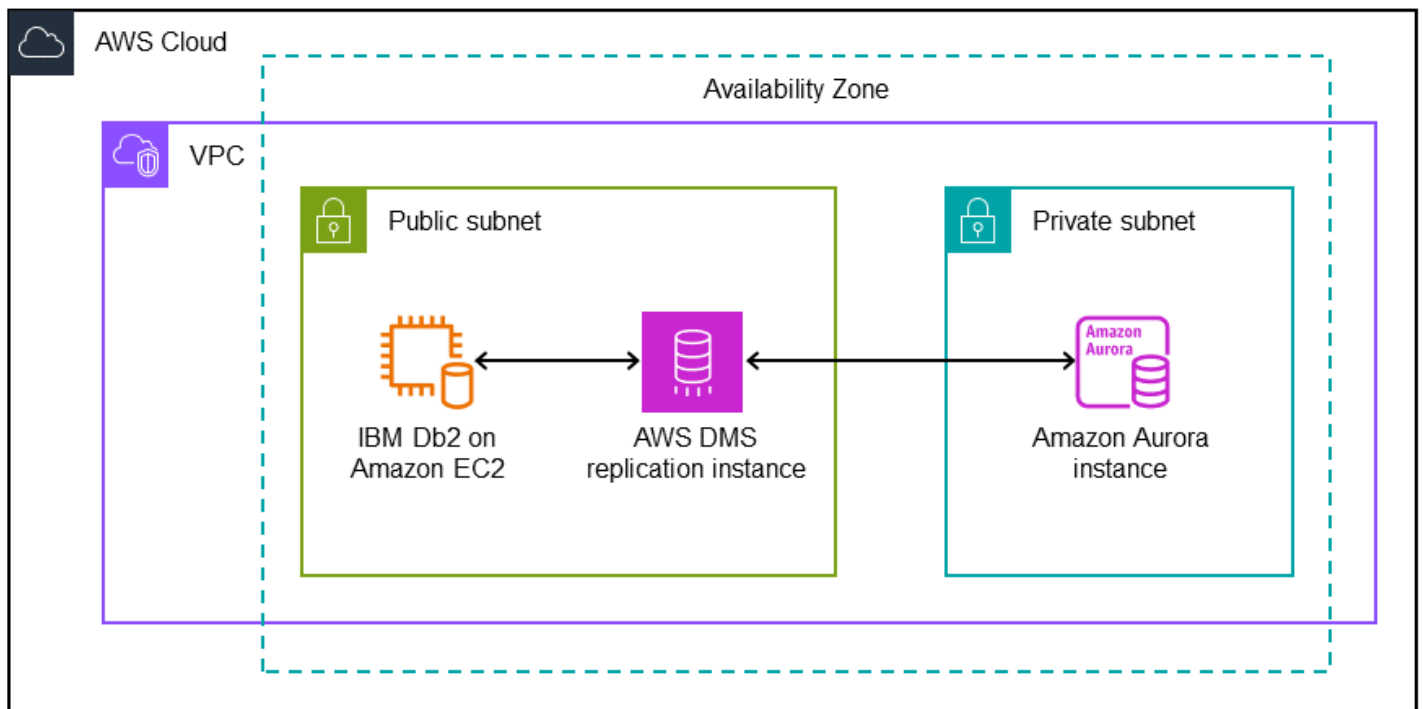

## Tools

### AWS services

- [Amazon Aurora](#) is a fully managed relational database engine that's built for the cloud and compatible with MySQL and PostgreSQL.
- [AWS Database Migration Service \(AWS DMS\)](#) helps you migrate data stores into the AWS Cloud or between combinations of cloud and on-premises setups.
- [Amazon Elastic Compute Cloud \(Amazon EC2\)](#) provides scalable computing capacity in the AWS Cloud. You can launch as many virtual servers as you need and quickly scale them up or down.
- [AWS Schema Conversion Tool \(AWS SCT\)](#) supports heterogeneous database migrations by automatically converting the source database schema and a majority of the custom code to a format that's compatible with the target database. AWS SCT supports as a source IBM Db2 for LUW versions 9.1, 9.5, 9.7, 10.1, 10.5, 11.1, and 11.5.

### Best practices

For best practices, see [Best practices for AWS Database Migration Service](#).



## Epics

### Configure the source IBM Db2 database

Task	Description	Skills required
Create the IBM Db2 database on Amazon EC2.	<p>You can create an IBM Db2 database on an EC2 instance by using an Amazon Machine Image (AMI) from AWS Marketplace or by installing Db2 software on an EC2 instance.</p> <p>Launch an EC2 instance by selecting an AMI for IBM Db2 (for example, <a href="#">IBM Db2 v11.5.7 RHEL 7.9</a>), which is similar to an on-premises database.</p>	DBA, General AWS
Configure security groups.	Configure the VPC security group inbound rules for SSH (Secure Shell) and TCP with port 22 and 50000, respectively.	General AWS
Create the database instance.	<p>Create a new instance (user) and database (schema), or use the default db2inst1 instance and sample database.</p> <ol style="list-style-type: none"><li>1. Connect to the EC2 instance by using the terminal to connect to the Db2 database. Alternatively, you can install any</li></ol>	DBA

Task	Description	Skills required
	<p>DB client software that will connect to the Db2 database.</p> <ol style="list-style-type: none"> <li>2. To set the password of the db2inst1 user, run the command <code>sudo passwd db2inst1</code>.</li> <li>3. To connect to the db2inst1 instance, run the command <code>sudo su - db2inst1</code>.</li> <li>4. To connect to the Db2 database, run the command <code>db2</code>.</li> <li>5. To connect to the sample database, use the command <code>connect to sample</code>. Alternatively, connect to the database that you created.</li> <li>6. After you connect to the database instance, create objects and insert data into these objects by using Db2 SQL statements.</li> </ol>	
<p>Confirm that the Db2 DB instance is available.</p>	<p>To confirm that the Db2 database instance is up and running, use the <code>Db2pd -</code> command.</p>	<p>DBA</p>

## Configure the target Aurora MySQL-Compatible database

Task	Description	Skills required
Create the Aurora MySQL-Compatible database.	<p>Create an Amazon Aurora with MySQL compatibility Database from AWS RDS service</p> <ul style="list-style-type: none"><li>• Create a database on Amazon Aurora with MySQL compatibility and version of your choice, e.g. Aurora (MySQL)–5.6.10a</li><li>• Install MySQL Workbench application or your preferred DB client software which allows you to connect to MySQL database</li></ul>	DBA, General AWS
Configure security groups.	Configure the VPC security group inbound rules for SSH and TCP connections.	General AWS
Confirm that the Aurora database is available.	<p>To make sure that the Aurora MySQL-Compatible database is up and running, do the following:</p> <ol style="list-style-type: none"><li>1. Connect to the EC2 instance through SSH.</li><li>2. Configure and connect to the Aurora MySQL-Compatible instance from MySQL Workbench . Use the endpoint as the</li></ol>	DBA

Task	Description	Skills required
	<p>hostname, as shown in the following example.</p> <pre>mysql-cluster-instance-1.cokmvis0v46q.us-east-1.rds.amazonaws.com</pre> <ol style="list-style-type: none"> <li>3. Create and connect to the new schema (for example, <code>mysql-sample-db2</code> ).</li> <li>4. Run the MySQL statements to check the schemas and objects in the database.</li> </ol>	

## Configure and run AWS SCT

Task	Description	Skills required
Install AWS SCT.	Download and install the latest version of <a href="#">AWS SCT</a> (the current latest version 1.0.628).	General AWS
Configure AWS SCT.	<ol style="list-style-type: none"> <li>1. Download the Java Database Connectivity (JDBC) drivers for IBM Db2 (4.22.X version) and MySQL (8.x).</li> <li>2. To configure the drivers in AWS SCT, choose <b>Settings, Global settings, Drivers</b>.</li> </ol>	General AWS
Create an AWS SCT project.	Create an AWS SCT project and report that uses Db2	General AWS

Task	Description	Skills required
	<p>for LUW as the source DB engine and Aurora MySQL-Compatible for the target DB engine.</p> <p>To identify the privileges needed to connect to a Db2 for LUW database, see <a href="#">Using Db2 LUW as a source for AWS SCT</a>.</p>	

Task	Description	Skills required
Validate the objects.	<p>Choose <b>Load schema</b>, validate the objects. Update any incorrect objects on the target database:</p> <ol style="list-style-type: none"><li>1. Connect to the Amazon Aurora MySQL-Compatible server by providing the connection details, and choose <b>Test connection</b>.</li></ol> <p>Both source and target connections must be successful before AWS SCT can start the migration report.</p> <ol style="list-style-type: none"><li>2. After the report is completed, enter the schema to be converted, and choose <b>Finish</b>.</li></ol> <p>AWS SCT lists any source and target objects that are converted and have errors.</p> <ol style="list-style-type: none"><li>3. Review the errors, and clear them manually.</li><li>4. After all errors are cleared, open the context (right-click) menu for the schema, and choose <b>Load schema</b>.</li><li>5. Choose <b>Apply to database</b>.</li><li>6. In MySQL Workbench , connect to the Aurora MySQL-Compatible</li></ol>	DBA, General AWS

Task	Description	Skills required
	database, and check the schema and objects.	

## Configure and run AWS DMS

Task	Description	Skills required
Create a replication instance.	Sign in to the AWS Management Console, navigate to the AWS DMS service, and create a replication instance with valid settings for the VPC security group that you configured for the source and target databases.	General AWS
Create endpoints.	<p>Create the source endpoint for the Db2 database, and create the target endpoint for the Aurora MySQL-Compatible database:</p> <ol style="list-style-type: none"> <li>1. Create an endpoint for IBM Db2 as the source by choosing <b>Select RDS DB instance</b> and then choosing the Db2 instance that you created. The endpoint configuration details will be automatically populated.</li> <li>2. In the endpoint-specific settings, add the following</li> </ol>	General AWS

Task	Description	Skills required
	<p>extra connection attributes.</p> <pre>CurrentLSN=&lt;scan&gt;; MaxKBytesPerRead=64; SetDataCaptureChanges=true</pre> <p>If you don't mention these attributes, the source endpoint test connection will not be successful. For more information, see <a href="#">Using IBM Db2 LUW as a source for AWS DMS</a>.</p> <p>3. Create an endpoint for Aurora MySQL-Compatible as the target by choosing <b>Select RDS DB instance</b> and then choosing the Aurora MySQL-Compatible instance that you created. The endpoint configuration details will be automatically populated. For more information, see <a href="#">Using a MySQL-compatible database as a target for AWS Database Migration Service</a>.</p> <p>4. Test the source and target endpoints. Confirm that both are successful and available</p>	



Task	Description	Skills required
	5. If the test fails, make sure that the security group inbound rules are valid.	

Task	Description	Skills required
Create migration tasks.	<p>Create a single migration task or multiple migration tasks for full load and CDC or Data validation:</p> <ol style="list-style-type: none"><li>1. To create a database migration task, choose the replication instance, source database endpoint, target database endpoint. Specify the migration type as <b>Migrate existing data</b> (full load), <b>Replicate data changes only (CDC)</b>, or <b>Migrate existing data and replicate ongoing changes</b> (full load and CDC).</li><li>2. Under <b>Table mappings</b>, you can configure selection rules and transformation rules in GUI or JSON formats.</li><li>3. Under <b>Selection rules</b>, select the schema, enter table name, and select Action (Include/Exclude) to be configured (for example, Schema: SAMPLE; Table name: %, Action: Include).</li><li>4. Under <b>Transformation rules</b>, select the target (Schema, Table, or Column). Select the schema name, and choose</li></ol>	General AWS

Task	Description	Skills required
	<p>the action (case, prefix, suffix); for example, Target: Schema; mysql-sample-db; Action: Make lowercase.</p> <p>5. Turn on Amazon CloudWatch Logs monitoring.</p>	
Plan the production run.	Confirm downtime with stakeholders such as application owners to run AWS DMS in production systems.	Migration lead
Run the migration tasks.	<ol style="list-style-type: none"><li>1. Start the AWS DMS task that has a status of <b>Ready</b>.</li><li>2. Monitor the migration task logs in Amazon CloudWatch Logs for any errors.</li></ol>	General AWS

Task	Description	Skills required
Validate the data.	<p>Review migration task results and data in the source Db2 and target MySQL databases:</p> <ol style="list-style-type: none"> <li>1. If the status is <b>Load complete ongoing replication</b>, the full load with CDC data migration is completed, and validation is ongoing.</li> <li>2. Connect to the Aurora MySQL-Compatible database, and check the data.</li> <li>3. Check the ongoing changes by inserting or updating data in the Db2 database.</li> </ol>	DBA
Stop migration tasks.	After data validation is successfully completed, stop the validation migration tasks.	General AWS

## Troubleshooting

Issue	Solution
AWS SCT source and target test connections are failing.	Configure JDBC driver versions and VPC security group inbound rules to accept the incoming traffic.
The Db2 source endpoint test run fails.	Configure the extra connection setting <code>CurrentLSN=&lt;scan&gt;</code> ; .

Issue	Solution
<p>The AWS DMS task fails to connect to the Db2 source, and the following error is returned.</p> <pre>database is recoverable if either or both of the database configura tion parameters LOGARCHMETH1 and LOGARCHMETH2 are set to ON</pre>	<p>To avoid the error, run the following commands:</p> <ol style="list-style-type: none"> <li>1. <code>\$ db2 update db cfg for sample using LOGARCHMETH1 DISK:/home/db2inst1/logs</code></li> <li>2. <code>\$ db2stop</code></li> <li>3. <code>\$ db2start</code></li> <li>4. <code>\$ db2 connect to sample</code> <div data-bbox="867 695 1507 894" style="border: 1px solid #ccc; border-radius: 10px; padding: 10px; margin: 10px 0;"> <pre>SQL1116N A connection to or activation of database "SAMPLE" cannot be made because of BACKUP PENDING.  SQLSTATE=57019</pre> </div> </li> <li>5. <code>\$ db2 backup database sample to ../logs</code> <div data-bbox="867 1031 1507 1150" style="border: 1px solid #ccc; border-radius: 10px; padding: 10px; margin: 10px 0;"> <pre>SQL2036N The path for the file or device "../logs" is not valid</pre> </div> </li> <li>6. <code>\$ cd</code></li> <li>7. <code>\$ pwd</code> <div data-bbox="867 1297 1507 1377" style="border: 1px solid #ccc; border-radius: 10px; padding: 10px; margin: 10px 0;"> <pre>/home/db2inst1</pre> </div> </li> <li>8. <code>\$ mkdir /tmp/backup</code></li> <li>9. <code>\$ db2 backup database sample to /tmp/backup</code> <div data-bbox="867 1570 1507 1730" style="border: 1px solid #ccc; border-radius: 10px; padding: 10px; margin: 10px 0;"> <pre>Backup successful. The timestamp for this backup image is : 201905300 84921</pre> </div> </li> <li>10. <code>\$ db2 connect to sample</code> <div data-bbox="867 1818 1507 1871" style="border: 1px solid #ccc; border-radius: 10px; padding: 10px; margin: 10px 0;"> <pre>Database Connection Information</pre> </div> </li> </ol>

Issue	Solution								
	<table><tr><td>Database server</td><td>= DB2/LINUX</td></tr><tr><td>9.7.1</td><td></td></tr><tr><td>SQL authorization ID</td><td>= DB2INST1</td></tr><tr><td>Local database alias</td><td>= SAMPLE</td></tr></table>	Database server	= DB2/LINUX	9.7.1		SQL authorization ID	= DB2INST1	Local database alias	= SAMPLE
Database server	= DB2/LINUX								
9.7.1									
SQL authorization ID	= DB2INST1								
Local database alias	= SAMPLE								

## Related resources

### Amazon EC2

- [Amazon EC2](#)
- [Amazon EC2 User Guides](#)

### Databases

- [IBM Db2 Database](#)
- [Amazon Aurora](#)
- [Working with Amazon Aurora MySQL](#)

### AWS SCT

- [AWS DMS Schema Conversion](#)
- [AWS Schema Conversion Tool User Guide](#)
- [Using the AWS SCT user interface](#)
- [Using IBM Db2 LUW as a source for AWS SCT](#)

### AWS DMS

- [AWS Database Migration Service](#)
- [AWS Database Migration Service User Guide](#)
- [Sources for data migration](#)
- [Targets for data migration](#)
- [AWS Database Migration Service and AWS Schema Conversion Tool now support IBM Db2 LUW as a source \(blog post\)](#)

- [Migrating Applications Running Relational Databases to AWS](#)

# Migrate a Microsoft SQL Server database from Amazon EC2 to Amazon DocumentDB by using AWS DMS

*Created by Umamaheswara Nooka (AWS)*

<b>Source:</b> Microsoft SQL Server on Amazon EC2	<b>Target:</b> Amazon DocumentDB	<b>R Type:</b> Re-architect
<b>Environment:</b> PoC or pilot	<b>Technologies:</b> CloudNative; Databases; Migration	<b>Workload:</b> Microsoft
<b>AWS services:</b> Amazon EC2; Amazon DocumentDB		

## Summary

This pattern describes how to use AWS Database Migration Service (AWS DMS) to migrate a Microsoft SQL Server database hosted on an Amazon Elastic Compute Cloud (Amazon EC2) instance to an Amazon DocumentDB (with MongoDB compatibility) database.

The AWS DMS replication task reads the table structure of the SQL Server database, creates the corresponding collection in Amazon DocumentDB, and performs a full-load migration.

You can also use this pattern to migrate an on-premises SQL Server or an Amazon Relational Database Service (Amazon RDS) for SQL Server DB instance to Amazon DocumentDB. For more information, see the guide [Migrating Microsoft SQL Server databases to the AWS Cloud](#) on the AWS Prescriptive Guidance website.

## Prerequisites and limitations

### Prerequisites

- An active AWS account.
- An existing SQL Server database on an EC2 instance.
- Fixed database (**db\_owner**) role assigned to AWS DMS in the SQL Server database. For more information, see [Database-level roles](#) in the SQL Server documentation.



- Familiarity with using the mongodump, mongorestore, mongoexport, and mongoimport utilities to [move data in and out of an Amazon DocumentDB cluster](#).
- [Microsoft SQL Server Management Studio](#), installed and configured.

## Limitations

- The cluster size limit in Amazon DocumentDB is 64 TB. For more information, see [Cluster limits](#) in the Amazon DocumentDB documentation.
- AWS DMS doesn't support the merging of multiple source tables into a single Amazon DocumentDB collection.
- If AWS DMS processes any changes from a source table without a primary key, it will ignore large object (LOB) columns in the source table.

## Architecture

### Source technology stack

- Amazon EC2

### Target architecture

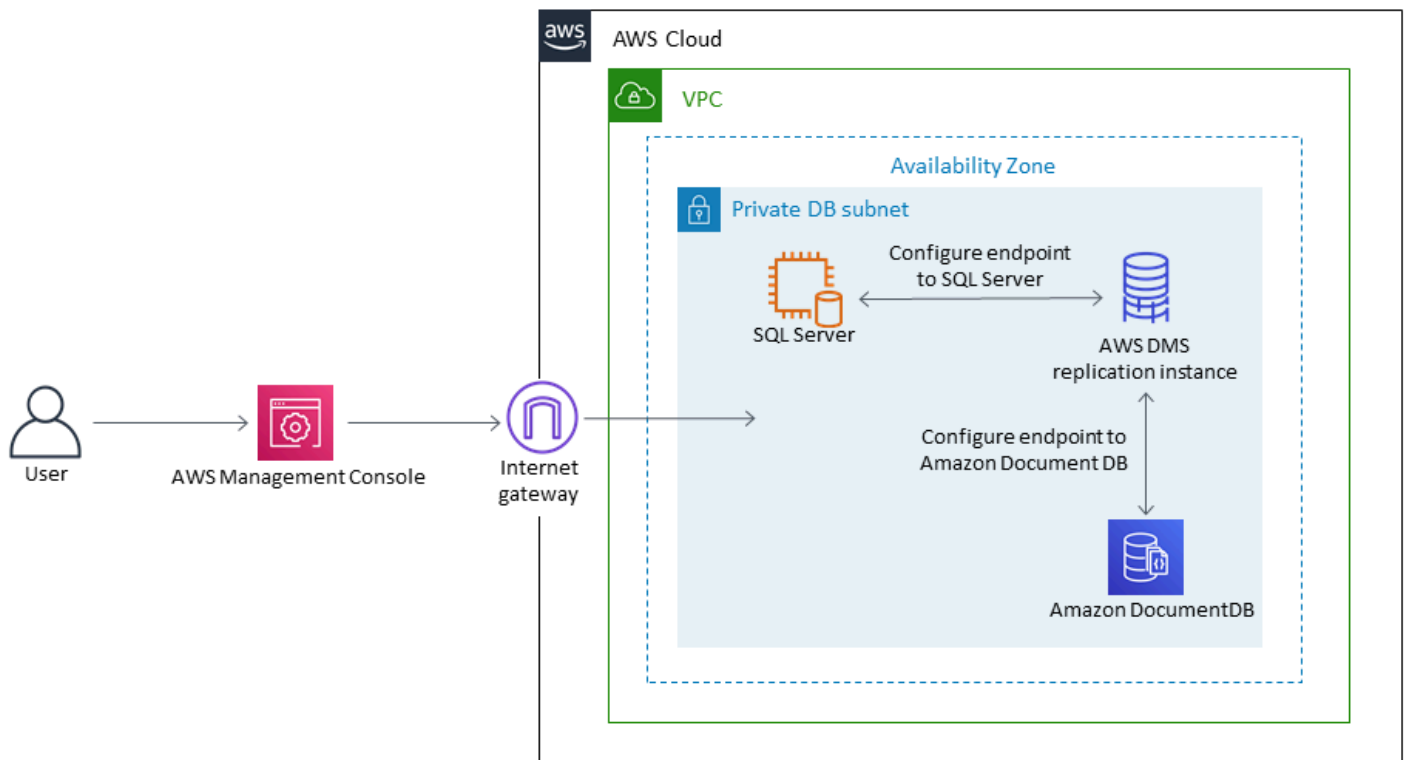

## Target technology stack

- Amazon DocumentDB

## Tools

- [AWS DMS](#) – AWS Database Migration Service (AWS DMS) helps you migrate databases easily and securely.
- [Amazon DocumentDB](#) – Amazon DocumentDB (with MongoDB compatibility) is a fast, reliable, and fully managed database service.
- [Amazon EC2](#) – Amazon Elastic Compute Cloud (Amazon EC2) provides scalable computing capacity in the AWS Cloud.
- [Microsoft SQL Server](#) – SQL Server is a relational database management system.
- [SQL Server Management Studio \(SSMS\)](#) – SSMS is a tool for managing SQL Server, including accessing, configuring, and administering SQL Server components.

## Epics

### Create and configure a VPC

Task	Description	Skills required
Create a VPC.	Sign in to the AWS Management Console and open the Amazon VPC console. Create a virtual private cloud (VPC) with an IPv4 CIDR block range.	System administrator
Create security groups and network ACLs.	On the Amazon VPC console, create security groups and network access control lists (network ACLs) for your VPC, according to your requirements. You can also use the default settings for these configurations. For more information about this and other stories, see the "Related resources" section.	System administrator

### Create and configure the Amazon DocumentDB cluster

Task	Description	Skills required
Create an Amazon DocumentDB cluster.	Open the Amazon DocumentDB console and choose "Clusters." Choose "Create," and create an Amazon DocumentDB cluster with one instance. Important : Make sure you configure	System administrator

Task	Description	Skills required
	this cluster with your VPC's security groups.	
Install the mongo shell.	The mongo shell is a command-line utility that you use to connect to and query your Amazon DocumentDB cluster. To install it, run the <code>"/etc/yum.repos.d/mongodb-org-3.6.repo"</code> command to create the repository file. Run the <code>"sudo yum install -y mongodb-org-shell"</code> command to install the mongo shell. To encrypt data in transit, download the public key for Amazon DocumentDB, and then connect to your Amazon DocumentDB instance. For more information about these steps, see the "Related resources" section.	System administrator
Create a database in the Amazon DocumentDB cluster.	Run the "use" command with the name of your database to create a database in your Amazon DocumentDB cluster.	System administrator

## Create and configure the AWS DMS replication instance

Task	Description	Skills required
Create the AWS DMS replication instance.	Open the AWS DMS console and choose "Create replicati	System administrator

Task	Description	Skills required
	<p>on instance.” Enter a name and description for your replication task. Choose the instance class, engine version, storage, VPC, Multi-AZ, and make it publicly accessible. Choose the “Advanced” tab to set the network and encryption settings. Specify the maintenance settings, and then choose “Create replication instance.”</p>	
<p>Configure the SQL Server database.</p>	<p>Log in to Microsoft SQL Server and add an inbound rule for communication between the source endpoint and the AWS DMS replication instance. Use the replication instance’s private IP address as the source. Important : The replication instance and target endpoint should be on the same VPC. Use an alternative source in the security group if the VPCs are different for the source and replication instances.</p>	<p>System administrator</p>

## Create and test the source and target endpoints in AWS DMS

Task	Description	Skills required
<p>Create the source and target database endpoints.</p>	<p>Open the AWS DMS console and choose “Connect</p>	<p>System administrator</p>

Task	Description	Skills required
	source and target database endpoints." Specify the connection information for the source and target databases. If required, choose the "Advanced" tab to set values for "Extra connection attributes." Download and use the certificate bundle in your endpoint configuration.	
Test the endpoint connection.	Choose "Run test" to test the connection. Troubleshoot any error messages by verifying the security group settings and the connections to the AWS DMS replication instance from both the source and target database instances.	System administrator

## Migrate data

Task	Description	Skills required
Create the AWS DMS migration task.	On the AWS DMS console, choose "Tasks," "Create task." Specify the task options, including the source and destination endpoint names, and replication instance names. Under "Migration type" choose "Migrate existing data," and "Replicat	System administrator

Task	Description	Skills required
	e data changes only." Choose "Start task."	
Run the AWS DMS migration task.	Under "Task settings," specify the settings for the table preparation mode, such as "Do nothing," "Drop tables on target," "Truncate," and "Include LOB columns in replication." Set a maximum LOB size that AWS DMS will accept and choose "Enable logging." Leave the "Advanced settings" at their default values and choose "Create task."	System administrator
Monitor the migration.	On the AWS DMS console, choose "Tasks" and choose your migration task. Choose "Task monitoring" to monitor your task. The task stops when the full-load migration is complete and cached changes are applied.	System administrator

## Test and verify the migration

Task	Description	Skills required
Connect to the Amazon DocumentDB cluster by using the mongo shell.	Open the Amazon DocumentDB console, choose your cluster under "Clusters." In the "Connectivity and Security" tab, choose	System administrator

Task	Description	Skills required
	"Connect to this cluster with the mongo shell."	
Verify the results of your migration.	Run the "use" command with the name of your database and then run the "show collections" command. Run the "db. .count();" command with the name of your database. If the results match your source database, then your migration was successful.	System administrator

## Related resources

### Create and configure a VPC

- [Create a security group for your VPC](#)
- [Create a network ACL](#)

### Create and configure the Amazon DocumentDB cluster

- [Create an Amazon DocumentDB cluster](#)
- [Install the mongo shell for Amazon DocumentDB](#)
- [Connect to your Amazon DocumentDB cluster](#)

### Create and configure the AWS DMS replication instance

- [Use public and private replication instances](#)



## Create and test the source and target endpoints in AWS DMS

- [Use Amazon DocumentDB as a target for AWS DMS](#)
- [Use a SQL Server database as a source for AWS DMS](#)
- [Use AWS DMS endpoints](#)

## Migrate data

- [Migrate to Amazon DocumentDB](#)

## Other resources

- [Limitations on using SQL Server as a source for AWS DMS](#)
- [How to use Amazon DocumentDB to build and manage applications at scale](#)

# Migrate an on-premises ThoughtSpot Falcon database to Amazon Redshift

Created by Battulga Purevragchaa (AWS) and Antony Prasad Thevaraj (AWS)

<b>Environment:</b> PoC or pilot	<b>Source:</b> On-premises ThoughtSpot Falcon database	<b>Target:</b> Amazon Redshift
<b>R Type:</b> Re-architect	<b>Workload:</b> All other workloads	<b>Technologies:</b> Migration; Databases
<b>AWS services:</b> AWS DMS; Amazon Redshift		

## Summary

On-premises data warehouses require significant administration time and resources, particularly for large datasets. The financial cost of building, maintaining, and growing these warehouses is also very high. To help manage costs, keep extract, transform, and load (ETL) complexity low, and deliver performance as your data grows, you must constantly choose which data to load and which data to archive.

By migrating your on-premises [ThoughtSpot Falcon databases](#) to the Amazon Web Services (AWS) Cloud, you can access cloud-based data lakes and data warehouses that increase your business agility, security, and application reliability, in addition to reducing your overall infrastructure costs. Amazon Redshift helps to significantly lower the cost and operational overhead of a data warehouse. You can also use Amazon Redshift Spectrum to analyze large amounts of data in its native format without data loading.

This pattern describes the steps and process for migrating a ThoughtSpot Falcon database from an on-premises data center to an Amazon Redshift database on the AWS Cloud.

## Prerequisites and limitations

### Prerequisites

- An active AWS account
- A ThoughtSpot Falcon database hosted in an on-premises data center

## Product versions

- ThoughtSpot version 7.0.1

## Architecture

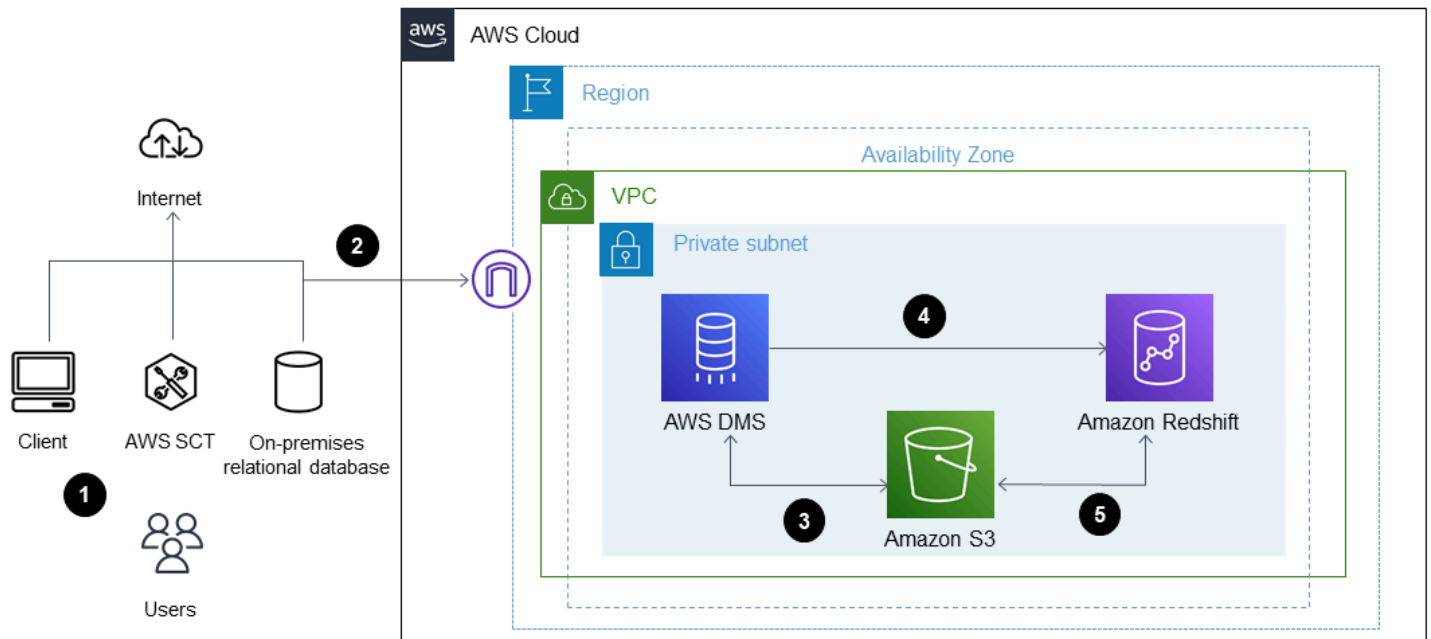

The diagram shows the following workflow:

1. Data is hosted in an on-premises relational database.
2. AWS Schema Conversion Tool (AWS SCT) converts the data definition language (DDL) that is compatible with Amazon Redshift.
3. After the tables are created, you can migrate the data by using AWS Database Migration Service (AWS DMS).
4. The data is loaded into Amazon Redshift.
5. The data is stored in Amazon Simple Storage Service (Amazon S3) if you use Redshift Spectrum or already host the data in Amazon S3.

## Tools

- [AWS DMS](#) – AWS Data Migration Service (AWS DMS) helps you quickly and securely migrate databases to AWS.

- [Amazon Redshift](#) – Amazon Redshift is a fast, fully managed, petabyte-scale data warehouse service that makes it simple and cost-effective to efficiently analyze all your data using your existing business intelligence tools.
- [AWS SCT](#) – AWS Schema Conversion Tool (AWS SCT) converts your existing database schema from one database engine to another.

## Epics

### Prepare for the migration

Task	Description	Skills required
Identify the appropriate Amazon Redshift configuration.	Identify the appropriate Amazon Redshift cluster configuration based on your requirements and data volume.  For more information, see <a href="#">Amazon Redshift clusters</a> in the Amazon Redshift documentation.	DBA
Research Amazon Redshift to evaluate if it meets your requirements.	Use the <a href="#">Amazon Redshift FAQs</a> to understand and evaluate whether Amazon Redshift meets your requirements.	DBA

### Prepare the target Amazon Redshift cluster

Task	Description	Skills required
Create an Amazon Redshift cluster.	Sign in to the AWS Management Console, open the Amazon Redshift console, and then create an Amazon	DBA

Task	Description	Skills required
	<p>Redshift cluster in a virtual private cloud (VPC).</p> <p>For more information, see <a href="#">Creating a cluster in a VPC</a> in the Amazon Redshift documentation.</p>	
Conduct a PoC for your Amazon Redshift database design.	<p>Follow Amazon Redshift best practices by conducting a proof of concept (PoC) for your database design.</p> <p>For more information, see <a href="#">Conducting a proof of concept for Amazon Redshift</a> in the Amazon Redshift documentation.</p>	DBA
Create database users.	<p>Create the users in your Amazon Redshift database and grant the appropriate roles for access to the schema and tables.</p> <p>For more information, see <a href="#">Grant access privileges for a user or user group</a> in the Amazon Redshift documentation.</p>	DBA

Task	Description	Skills required
Apply configuration settings to the target database.	<p>Apply configuration settings to the Amazon Redshift database according to your requirements.</p> <p>For more information about enabling database, session, and server-level parameters, see the <a href="#">Configuration reference</a> in the Amazon Redshift documentation.</p>	DBA

## Create objects in the Amazon Redshift cluster

Task	Description	Skills required
Manually create tables with DDL in Amazon Redshift.	(Optional) If you use AWS SCT, the tables are automatically created. However, if there are failures when replicating DDLs, you have to manually create the tables	DBA
Create external tables for Redshift Spectrum.	<p>Create an external table with an external schema for Amazon Redshift Spectrum. To create external tables, you must be the owner of the external schema or a <a href="#">database superuser</a>.</p> <p>For more information, see <a href="#">Creating external tables for Amazon Redshift Spectrum</a></p>	DBA

Task	Description	Skills required
	in the Amazon Redshift documentation.	

## Migrate data using AWS DMS

Task	Description	Skills required
Use AWS DMS to migrate the data.	<p>After you create the DDL of the tables in the Amazon Redshift database, migrate your data to Amazon Redshift by using AWS DMS.</p> <p>For detailed steps and instructions, see <a href="#">Using an Amazon Redshift database as a target for AWS DMS</a> in the AWS DMS documentation.</p>	DBA
Use the COPY command to load the data.	<p>Use the Amazon Redshift COPY command to load the data from Amazon S3 to Amazon Redshift.</p> <p>For more information, see <a href="#">Using the COPY command to load from Amazon S3</a> in the Amazon Redshift documentation.</p>	DBA

## Validate the Amazon Redshift cluster

Task	Description	Skills required
Validate the source and target records.	Validate the table count for the source and target records that were loaded from your source system.	DBA
Implement Amazon Redshift best practices for performance tuning.	<p>Implement Amazon Redshift best practices for table and database design.</p> <p>For more information, see the blog post <a href="#">Top 10 performance tuning techniques for Amazon Redshift</a>.</p>	DBA
Optimize query performance.	<p>Amazon Redshift uses SQL-based queries to interact with data and objects in the system. Data manipulation language (DML) is the subset of SQL that you can use to view, add, change, and delete data. DDL is the subset of SQL that you use to add, change, and delete database objects such as tables and views.</p> <p>For more information, see <a href="#">Tuning query performance</a> in the Amazon Redshift documentation.</p>	DBA
Implement WLM.	You can use workload management (WLM) to define multiple query queues and	DBA



Task	Description	Skills required
	<p>route queries to appropriate queues at runtime.</p> <p>For more information, see <a href="#">Implementing workload management</a> in the Amazon Redshift documentation.</p>	
Work with concurrency scaling.	<p>By using the Concurrency Scaling feature, you can support virtually unlimited concurrent users and concurrent queries, with consistently fast query performance.</p> <p>For more information, see <a href="#">Working with concurrency scaling</a> in the Amazon Redshift documentation.</p>	DBA
Use Amazon Redshift best practices for table design.	<p>When you plan your database, certain important table design decisions can strongly influence overall query performance.</p> <p>For more information about choosing the most appropriate table design option, see <a href="#">Amazon Redshift best practices for designing tables</a> in the Amazon Redshift documentation.</p>	DBA

Task	Description	Skills required
Create materialized views in Amazon Redshift.	<p>A materialized view contains a precomputed results set based on an SQL query over one or more base tables. You can issue SELECT statements to query a materialized view in the same way that you query other tables or views in the database.</p> <p>For more information, see <a href="#">Creating materialized views in Amazon Redshift</a> in the Amazon Redshift documentation.</p>	DBA
Define joins between the tables.	<p>To search more than one table at the same time in ThoughtSpot, you must define joins between the tables by specifying columns that contain matching data across two tables. These columns represent the primary key and foreign key of the join.</p> <p>You can define them by using the ALTER TABLE command in Amazon Redshift or ThoughtSpot. For more information, see <a href="#">ALTER TABLE</a> in the Amazon Redshift documentation.</p>	DBA

## Set up ThoughtSpot connection to Amazon Redshift

Task	Description	Skills required
Add an Amazon Redshift connection.	<p>Add an Amazon Redshift connection to your on-premises ThoughtSpot Falcon database.</p> <p>For more information, see <a href="#">Add an Amazon Redshift connection</a> in the ThoughtSpot documentation.</p>	DBA
Edit the Amazon Redshift connection.	<p>You can edit the Amazon Redshift connection to add tables and columns.</p> <p>For more information, see <a href="#">Edit an Amazon Redshift connection</a> in the ThoughtSpot documentation.</p>	DBA
Remap the Amazon Redshift connection.	<p>Modify the connection parameters by editing the source mapping .yaml file that was created when you added the Amazon Redshift connection.</p> <p>For example, you can remap the existing table or column to a different table or column in an existing database connection. ThoughtSpot recommends that you check the dependencies before and after you remap a table or</p>	DBA

Task	Description	Skills required
	<p>column in a connection to ensure that they display as required.</p> <p>For more information, see <a href="#">Remap an Amazon Redshift connection</a> in the ThoughtSpot documentation.</p>	
Delete a table from the Amazon Redshift connection.	<p>(Optional) If you attempt to remove a table in an Amazon Redshift connection, ThoughtSpot checks for dependencies and shows a list of dependent objects. You can choose the listed objects to delete them or remove the dependency. You can then remove the table.</p> <p>For more information, see <a href="#">Delete a table from an Amazon Redshift connection</a> in the ThoughtSpot documentation.</p>	DBA

Task	Description	Skills required
Delete a table with dependent objects from an Amazon Redshift connection.	<p>(Optional) If you try to delete a table with dependent objects, the operation is blocked. A Cannot delete window appears, with a list of links to dependent objects. When all the dependencies are removed, you can then delete the table</p> <p>For more information, see <a href="#">Delete a table with dependent objects from an Amazon Redshift connection</a> in the ThoughtSpot documentation.</p>	DBA
Delete an Amazon Redshift connection.	<p>(Optional) Because a connection can be used in multiple data sources or visualizations, you must delete all of the sources and tasks that use that connection before you can delete the Amazon Redshift connection.</p> <p>For more information, see <a href="#">Delete an Amazon Redshift connection</a> in the ThoughtSpot documentation.</p>	DBA

Task	Description	Skills required
Check connection reference for Amazon Redshift.	Make sure that you provide the required information for your Amazon Redshift connection by using the <a href="#">Connection reference</a> in the ThoughtSpot documentation.	DBA

## Additional information

- [AI-driven analytics at any scale with ThoughtSpot and Amazon Redshift](#)
- [Amazon Redshift pricing](#)
- [Getting started with AWS SCT](#)
- [Getting started with Amazon Redshift](#)
- [Using data extraction agents](#)
- [Chick-fil-A improves speed to insight with ThoughtSpot and AWS](#)

# Migrate an Oracle database to Amazon DynamoDB using AWS DMS

Created by Rambabu Karnena (AWS)

<b>Environment:</b> PoC or pilot	<b>Source:</b> Databases: Relational	<b>Target:</b> Amazon DynamoDB
<b>R Type:</b> Re-architect	<b>Workload:</b> Oracle	<b>Technologies:</b> Migration; Databases
<b>AWS services:</b> Amazon DynamoDB		

## Summary

This pattern walks you through the steps for migrating an Oracle database to [Amazon DynamoDB](#) using AWS Database Migration Service ([AWS DMS](#)). It covers three types of source databases:

- On-premises Oracle databases
- Oracle databases on Amazon Elastic Compute Cloud ([Amazon EC2](#))
- Amazon Relational Database Service ([Amazon RDS](#)) for Oracle DB instances

In this proof of concept, this pattern focuses on migrating from an Amazon RDS for Oracle DB instance.

## Prerequisites and limitations

### Prerequisites

- An active AWS account
- An application connecting to an Amazon RDS for Oracle database
- A table created in the source Amazon RDS for Oracle database with a primary key and sample data

### Limitations

- Oracle database objects, such as procedures, functions, packages, and triggers, are not considered for migration because Amazon DynamoDB does not support these database objects.

## Product versions

- This pattern applies to all editions and versions of Oracle databases that are supported by AWS DMS. For more information, see using an [Oracle database as a source for AWS DMS](#) and using an [Amazon DynamoDB database as a target for AWS DMS](#). We recommend that you use the latest versions of AWS DMS for the most comprehensive version and feature support.

## Architecture

### Source technology stack

- Amazon RDS for Oracle DB instances, Oracle on Amazon EC2, or on-premises Oracle databases

### Target technology stack

- Amazon DynamoDB

### AWS data migration architecture



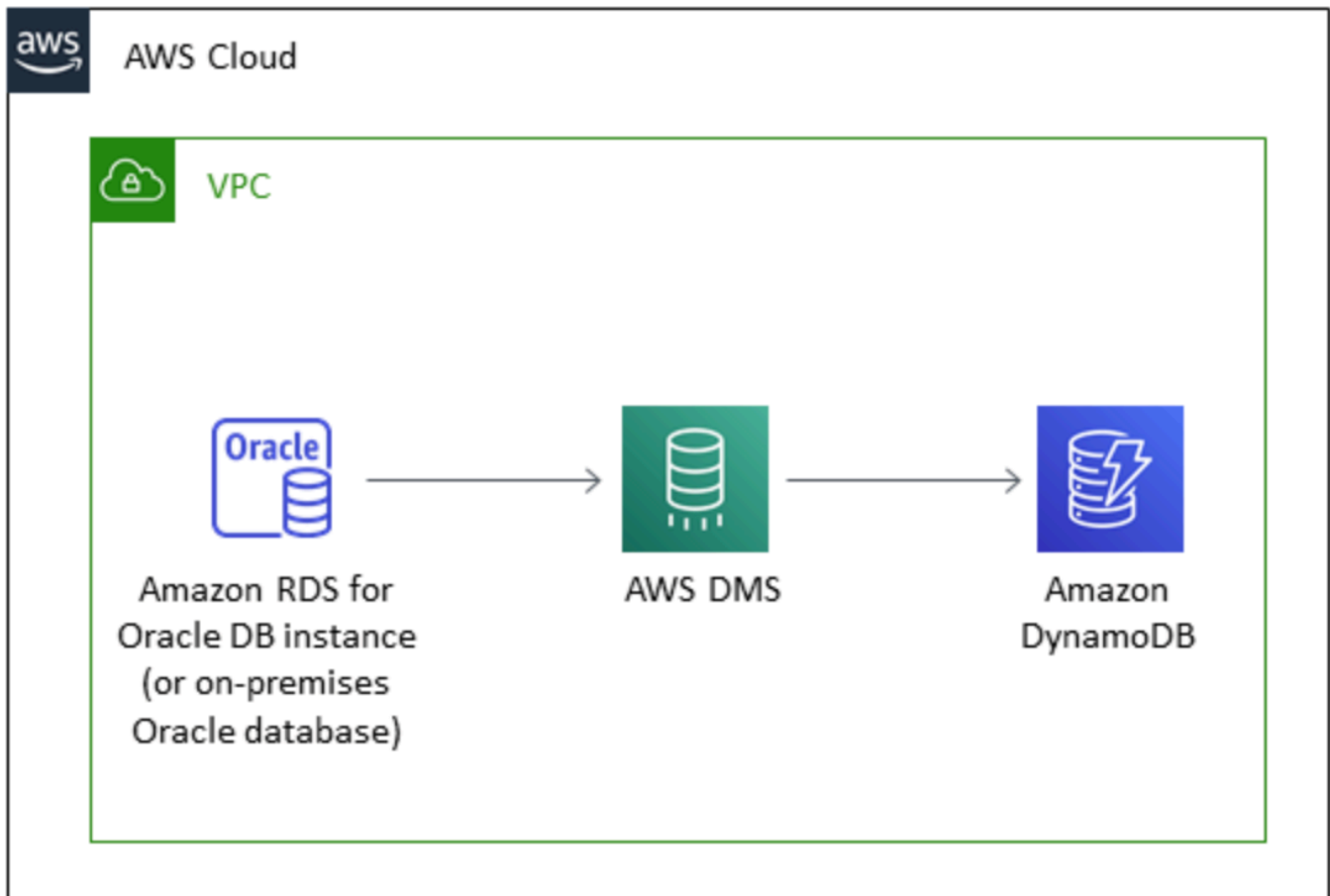

## Tools

- [AWS Database Migration Service \(AWS DMS\)](#) helps you migrate data stores into the AWS Cloud or between combinations of cloud and on-premises setups.
- [Amazon DynamoDB](#) is a fully managed NoSQL database service that provides fast, predictable, and scalable performance.
- [Amazon Relational Database Service \(Amazon RDS\)](#) helps you set up, operate, and scale a relational database in the AWS Cloud. This pattern uses Amazon RDS for Oracle.

## Epics

### Plan the migration

Task	Description	Skills required
Create a VPC.	In your AWS account, create a virtual private cloud (VPC) and a private subnet.	Systems administrator
Create security groups and network access control lists.	For more information, see the <a href="#">AWS documentation</a> .	Systems administrator
Configure and start the Amazon RDS for Oracle DB instance.	For more information, see the <a href="#">AWS documentation</a> .	DBA, Systems administrator

### Migrate data

Task	Description	Skills required
Create an IAM role to access DynamoDB.	In the AWS Identity and Access Management (IAM) console, create the role, attach the policy AmazonDynamoDBFullAccess to it, and select AWS DMS as the service.	Systems administrator
Create an AWS DMS replication instance for migration.	The replication instance should be in the same Availability Zone and VPC as the source database.	Systems administrator
Create source and target endpoints in AWS DMS.	To create the source database endpoint, you have two options:	Systems administrator

Task	Description	Skills required
	<ul style="list-style-type: none"> <li>On the Amazon RDS console, choose <b>Databases, DB identifier, Connectivity &amp; Security</b>, and choose the endpoint.</li> <li>On the AWS DMS console, choose <b>Select RDS DB instance</b>.</li> </ul> <p>To create the target database endpoint, choose the role Amazon Resource Name (ARN) from the previous task to access DynamoDB.</p>	
Create an AWS DMS task to load the source Oracle database tables to DynamoDB.	Choose the source and destination endpoint names and the replication instance from the previous steps. The type can be full load. Choose the Oracle schema and specify % to select all tables.	Systems administrator
Validate the tables in DynamoDB.	To view the migration results, choose <b>Tables</b> from the left navigation pane in the DynamoDB console.	DBA

## Migrate the application

Task	Description	Skills required
Modify the application code.	To connect to and retrieve data from DynamoDB, update the application code.	App owner, DBA, Systems administrator

## Cut over

Task	Description	Skills required
Switch the application clients to use DynamoDB.		DBA, App owner, Systems administrator

## Close the project

Task	Description	Skills required
Shut down AWS resources.	For example, the shut down the Amazon RDS for Oracle instance, DynamoDB, and the AWS DMS replication instance.	DBA, Systems administrator
Gather metrics.	Metrics include the time to migrate, the percentages of manual work and work performed by the tool, and cost savings.	DBA, App owner, Systems administrator

## Related resources

- [AWS Database Migration Service and Amazon DynamoDB: What You Need to Know](#) (blog post)
- [Using an Oracle Database as a source for AWS DMS](#)

- [Using an Amazon DynamoDB database as a target for AWS Database Migration Service](#)
- [Best Practices for Migrating from RDBMS to Amazon DynamoDB \(whitepaper\)](#)

# Migrate an Oracle partitioned table to PostgreSQL by using AWS DMS

Created by Saurav Mishra (AWS) and Eduardo Valentim (AWS)

<b>Environment:</b> PoC or pilot	<b>Source:</b> Oracle database	<b>Target:</b> PostgreSQL 9.0
<b>R Type:</b> Re-architect	<b>Workload:</b> Oracle	<b>Technologies:</b> Migration; Databases; Storage & backup
<b>AWS services:</b> AWS DMS		

## Summary

This pattern describes how to speed up loading a partitioned table from Oracle to PostgreSQL by using AWS Database Migration Service (AWS DMS), which doesn't support native partitioning. The target PostgreSQL database can be installed on Amazon Elastic Compute Cloud (Amazon EC2), or it can be an Amazon Relational Database Service (Amazon RDS) for PostgreSQL or Amazon Aurora PostgreSQL-Compatible Edition DB instance.

Uploading a partitioned table includes the following steps:

1. Create a parent table similar to the Oracle partition table, but don't include any partition.
2. Create child tables that will inherit from the parent table that you created in step 1.
3. Create a procedure function and trigger to handle the inserts in the parent table.

However, because the trigger is fired for every insert, the initial load using AWS DMS can be very slow.

To speed up initial loads from Oracle to PostgreSQL 9.0, this pattern creates a separate AWS DMS task for each partition and loads the corresponding child tables. You then create a trigger during cutover.

PostgreSQL version 10 supports native partitioning. However, you might decide to use inherited partitioning in some cases. For more information, see the [Additional information](#) section.

## Prerequisites and limitations

### Prerequisites

- An active AWS account
- A source Oracle database with a partitioned table
- A PostgreSQL database on AWS

## Product versions

- PostgreSQL 9.0

## Architecture

### Source technology stack

- A partitioned table in Oracle

### Target technology stack

- A partitioned table in PostgreSQL (on Amazon EC2, Amazon RDS for PostgreSQL, or Aurora PostgreSQL)

### Target architecture

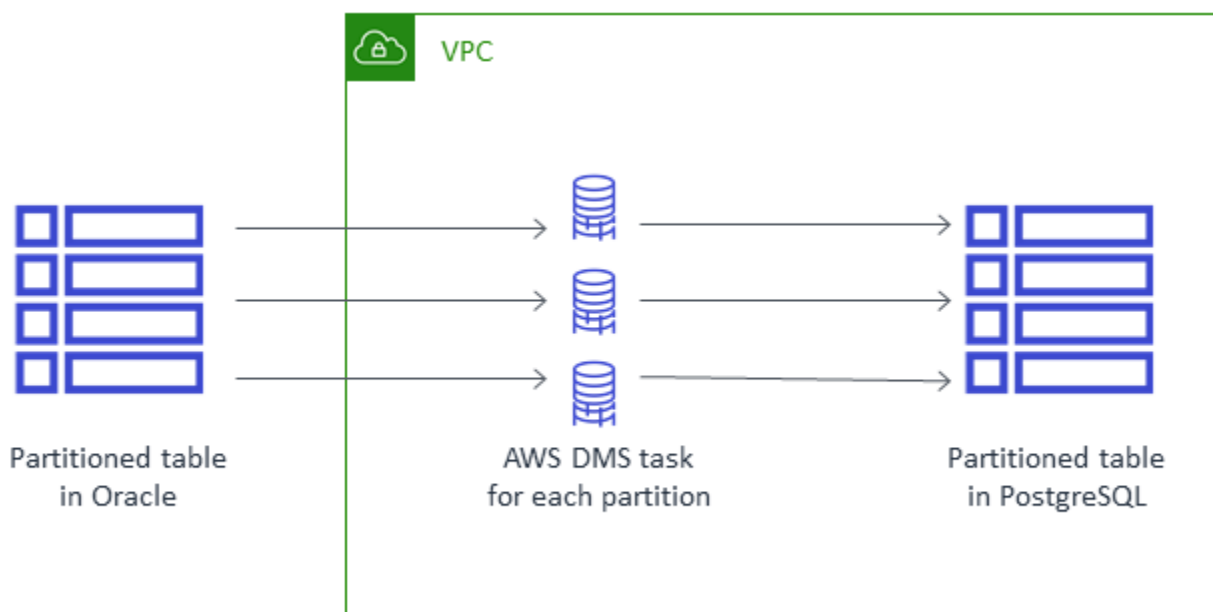

## Tools

- [AWS Database Migration Service \(AWS DMS\)](#) helps you migrate data stores into the AWS Cloud or between combinations of cloud and on-premises setups.

## Epics

### Set up AWS DMS

Task	Description	Skills required
Create the tables in PostgreSQL.	Create the parent and corresponding child tables in PostgreSQL with the required check conditions for partitions.	DBA
Create the AWS DMS task for each partition.	Include the filter condition of the partition in the AWS DMS task. Map the partitions to the corresponding PostgreSQL child tables.	DBA
Run the AWS DMS tasks using full load and change data capture (CDC).	Make sure that the <code>StopTaskCachedChangesApplied</code> parameter is set to <code>true</code> and the <code>StopTaskCachedChangesNotApplied</code> parameter is set to <code>false</code> .	DBA



## Cut over

Task	Description	Skills required
Stop the replication tasks.	Before you stop the tasks, confirm that the source and destination are in sync.	DBA
Create a trigger on the parent table.	Because the parent table will receive all insert and update commands, create a trigger that will route these commands to the respective child tables based on the partitioning condition.	DBA

## Related resources

- [AWS DMS](#)
- [Table Partitioning \(PostgreSQL documentation\)](#)

## Additional information

Although PostgreSQL version 10 supports native partitioning, you might decide to use inherited partitioning for the following use cases:

- Partitioning enforces a rule that all partitions must have the same set of columns as the parent, but table inheritance supports children having extra columns.
- Table inheritance supports multiple inheritances.
- Declarative partitioning supports only list and range partitioning. With table inheritance, you can divide the data as you want. However, if the constraint exclusion can't prune partitions effectively, query performance will suffer.
- Some operations need a stronger lock when using declarative partitioning than when using table inheritance. For example, adding or removing a partition to or from a partitioned table requires an `ACCESS EXCLUSIVE` lock on the parent table, whereas a `SHARE UPDATE EXCLUSIVE` lock is enough for regular inheritance.

When you use separate job partitions, you can also reload partitions if there are any AWS DMS validation issues. For better performance and replication control, run tasks on separate replication instances.

# Migrate from Amazon RDS for Oracle to Amazon RDS for MySQL

Created by Jitender Kumar (AWS), Neha Sharma (AWS), and Srin Ramaswamy (AWS)

<b>Environment:</b> PoC or pilot	<b>Source:</b> Amazon RDS for Oracle	<b>Target:</b> Amazon RDS for MySQL
<b>R Type:</b> Re-architect	<b>Workload:</b> Oracle	<b>Technologies:</b> Migration; Databases
<b>AWS services:</b> Amazon RDS		

## Summary

This pattern provides guidance for migrating an Amazon Relational Database Service (Amazon RDS) for Oracle DB instance to an Amazon RDS for MySQL DB instance on Amazon Web Services (AWS). The pattern uses AWS Database Migration Service (AWS DMS) and AWS Schema Conversion Tool (AWS SCT).

The pattern provides best practices for handling the migration of stored procedures. It also covers and code changes to support the application layer.

## Prerequisites and limitations

### Prerequisites

- An active AWS account.
- An Amazon RDS for Oracle source database.
- An Amazon RDS for MySQL target database. Source and target databases should be in the same virtual private cloud (VPC). If you're using multiple VPCs, or you must have the required access permissions.
- Security groups that allow connectivity between the source and target databases, AWS SCT, the application server, and AWS DMS.
- A user account with the required privilege to run AWS SCT on the source database.
- Supplemental logging enabled for running AWS DMS on the source database.

## Limitations

- The source and target Amazon RDS database size limit is 64 TB. For Amazon RDS size information, see the [AWS documentation](#).
- Oracle is case-insensitive for database objects, but MySQL is not. AWS SCT can handle this issue while creating an object. However, some manual work is required to support full case insensitivity.
- This migration doesn't use MySQL extensions to enable Oracle-native functions. AWS SCT handles most of the conversion, but some work is required to change code manually.
- Java Database Connectivity (JDBC) driver changes are required in the application.

## Product versions

- Amazon RDS for Oracle 12.2.0.1 and later. For currently supported RDS for Oracle versions, see the [AWS documentation](#).
- Amazon RDS for MySQL 8.0.15 and later. For currently supported RDS for MySQL versions, see the [AWS documentation](#).
- AWS DMS version 3.3.0 and later. See the AWS documentation for more information about AWS DMS supported [source endpoints](#) and [target endpoints](#).
- AWS SCT version 1.0.628 and later. See the [AWS SCT source and target endpoint support matrix](#) in the AWS documentation.

## Architecture

### Source technology stack

- Amazon RDS for Oracle. For more information, see [Using an Oracle database as a source for AWS DMS](#).

### Target technology stack

- Amazon RDS for MySQL. For more information, see [Using a MySQL-Compatible database as a target for AWS DMS](#).

### Migration architecture

In the following diagram, AWS SCT copies and converts schema objects from the Amazon RDS for Oracle source database and sends the objects to the Amazon RDS for MySQL target database. AWS DMS replicates data from the source database and sends it to the Amazon RDS for MySQL instance.

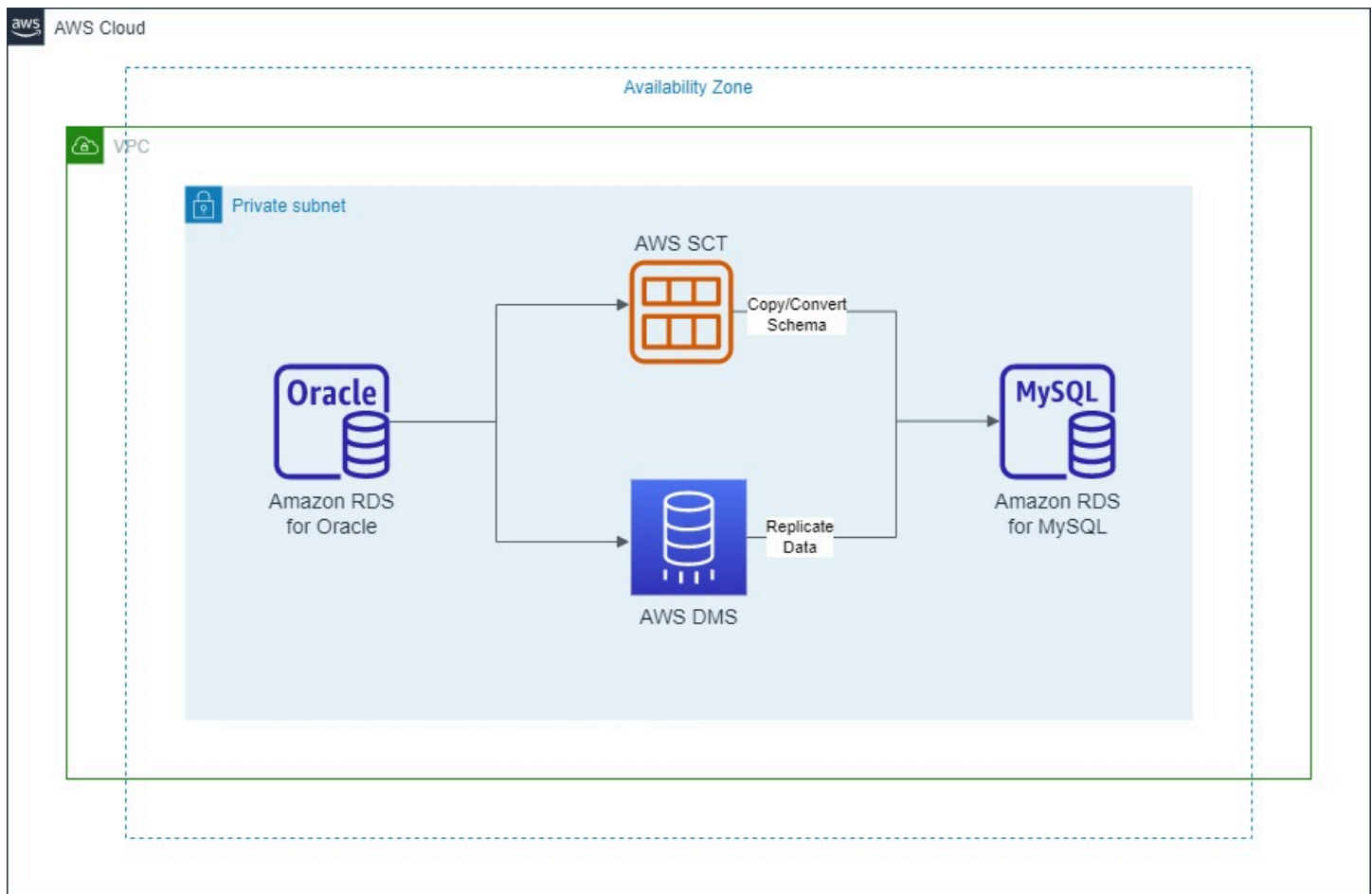

## Tools

- [AWS Data Migration Service](#) helps you migrate data stores into the AWS Cloud or between combinations of cloud and on-premises setups.
- [Amazon Relational Database Service \(Amazon RDS\)](#) helps you set up, operate, and scale a relational database in the AWS Cloud. This pattern uses [Amazon RDS for Oracle](#) and [Amazon RDS for MySQL](#).
- [AWS Schema Conversion Tool \(AWS SCT\)](#) supports heterogeneous database migrations by automatically converting the source database schema and a majority of the custom code to a format that's compatible with the target database.

## Epics

### Prepare for migration

Task	Description	Skills required
Validate the source and target database versions and engines.		DBA
Identify hardware requirements for the target server instance.		DBA, SysAdmin
Identify storage requirements (storage type and capacity).		DBA, SysAdmin
Choose the proper instance type (capacity, storage features, network features).		DBA, SysAdmin
Identify network-access security requirements for the source and target databases.		DBA, SysAdmin
Choose an application migration strategy.	Consider whether you want full downtime or partial downtime for cutover activities.	DBA, SysAdmin, App owner

### Configure infrastructure

Task	Description	Skills required
Create a VPC and subnets.		SysAdmin

Task	Description	Skills required
Create security groups and network access control lists (ACLs).		SysAdmin
Configure and start the Amazon RDS for Oracle instance.		DBA, SysAdmin
Configure and start the Amazon RDS for MySQL instance.		DBA, SysAdmin
Prepare a test case for validation of code conversion.	This will help in unit-testing for the converted code.	DBA, Developer
Configure the AWS DMS instance.		
Configure source and target endpoints in AWS DMS.		

## Migrate data

Task	Description	Skills required
Generate the target database script using AWS SCT.	Check the accuracy of the code that was converted by AWS SCT. Some manual work will be required.	DBA, Developer
In AWS SCT, choose the "Case Insensitive" setting.	In AWS SCT, choose Project Settings, Target Case Sensitivity, Case Insensitive.	DBA, Developer

Task	Description	Skills required
In AWS SCT, choose not to use the Oracle native function.	In Project Settings, check the functions TO_CHAR/TO_NUMBER/TO_DATE.	DBA, Developer
Make changes for "sql%notfound" code.	You might have to convert the code manually.	
Query on tables and objects in stored procedures (use lowercase queries).		DBA, Developer
Create the primary script after all changes are made, and then deploy the primary script on the target database.		DBA, Developer
Unit-test stored procedures and application calls using sample data.		
Clean up data that was created during unit testing.		DBA, Developer
Drop foreign key constraints on the target database.	This step is required to load initial data. If you don't want to drop the foreign key constraints, you must create a migration task for data specific to the primary and secondary tables.	DBA, Developer
Drop primary keys and unique keys on the target database.	This step results in better performance for the initial load.	DBA, Developer
Enable supplemental logging on the source database.		DBA



Task	Description	Skills required
Create a migration task for the initial load in AWS DMS, and then run it.	Choose the option to migrate existing data.	DBA
Add the primary keys and foreign keys to the target database.	Constraints need to be added after the initial load.	DBA, Developer
Create a migration task for ongoing replication.	Ongoing replication keeps the target database synchronized with the source database.	DBA

## Migrate applications

Task	Description	Skills required
Replace Oracle native functions with MySQL native functions.		App owner
Make sure that only lowercase names are used for database objects in SQL queries.		DBA, SysAdmin, App owner

## Cut over to the target database

Task	Description	Skills required
Shut down the application server.		App owner
Validate that the source and target databases are in sync.		DBA, App owner

Task	Description	Skills required
Stop the Amazon RDS for Oracle DB instance.		DBA
Stop the migration task.	This will stop automatically after you complete the previous step.	DBA
Change the JDBC connection from Oracle to MySQL.		App owner, DBA
Start the application.		DBA, SysAdmin, App owner

## Close the project

Task	Description	Skills required
Review and validate the project documents.		DBA, SysAdmin
Gather metrics about time to migrate, percentage of manual versus tool tasks, cost savings, etc.		DBA, SysAdmin
Stop and delete AWS DMS instances.		DBA
Remove the source and target endpoints.		DBA
Remove migration tasks.		DBA
Take a snapshot of the Amazon RDS for Oracle DB instance.		DBA

Task	Description	Skills required
Delete the Amazon RDS for Oracle DB instance.		DBA
Shut down and delete any other temporary AWS resources you used.		DBA, SysAdmin
Close the project and provide any feedback.		DBA

## Related resources

- [AWS DMS](#)
- [AWS SCT](#)
- [Amazon RDS Pricing](#)
- [Getting Started with AWS DMS](#)
- [Getting Started with Amazon RDS](#)

# Migrate from IBM Db2 on Amazon EC2 to Aurora PostgreSQL-Compatible using AWS DMS and AWS SCT

Created by *Sirsendu Halder (AWS)* and *Abhimanyu Chhabra (AWS)*

<b>Environment:</b> PoC or pilot	<b>Source:</b> IBM Db2	<b>Target:</b> Aurora PostgreSQL-Compatible
<b>R Type:</b> Re-architect	<b>Workload:</b> IBM	<b>Technologies:</b> Migration; Databases
<b>AWS services:</b> Amazon Aurora; AWS DMS; AWS SCT		

## Summary

This pattern provides guidance for migrating an IBM Db2 database on an Amazon Elastic Compute Cloud (Amazon EC2) instance to an Amazon Aurora PostgreSQL-Compatible Edition DB instance. This pattern uses AWS Database Migration Service (AWS DMS) and AWS Schema Conversion Tool (AWS SCT) for data migration and schema conversion.

The pattern targets an online migration strategy with little or no downtime for a multi-terabyte IBM Db2 database that has a high number of transactions. We recommend that you convert the columns in primary keys (PKs) and foreign keys (FKs) with the data type NUMERIC to INT or BIGINT in PostgreSQL for better performance.

## Prerequisites and limitations

### Prerequisites

- An active AWS account
- A source IBM Db2 database on an EC2 instance

### Product versions

- DB2/LINUX8664 version 11.1.4.4 and later

## Architecture

### Source technology stack

- A Db2 database on an EC2 instance

### Target technology stack

- An Aurora PostgreSQL-Compatible version 10.18 or later DB instance

### Database migration architecture

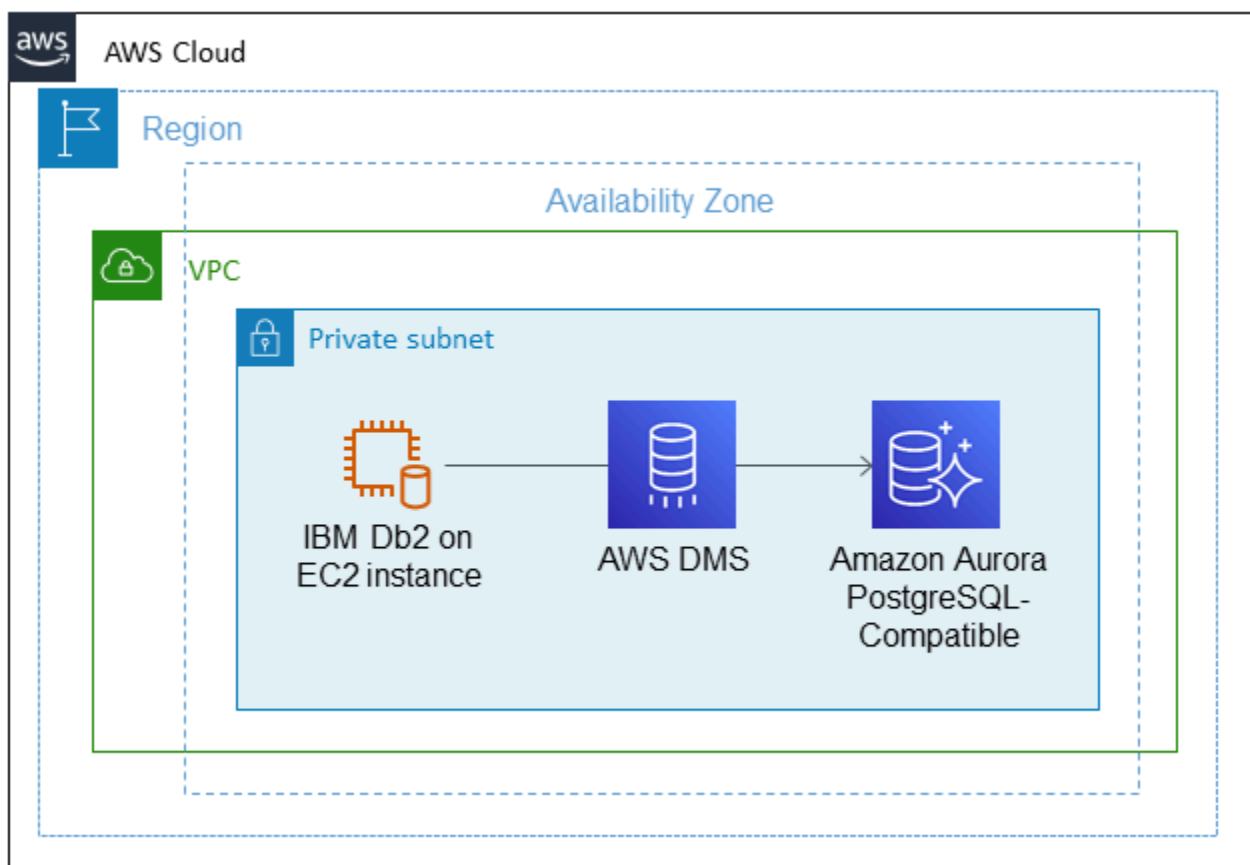

## Tools

- [AWS Database Migration Service \(AWS DMS\)](#) helps you migrate databases into the AWS Cloud or between combinations of cloud and on-premises setups. The source database remains fully operational during the migration, minimizing downtime to applications that rely on the database. You can use AWS DMS to migrate your data to and from the most widely used

commercial and open-source databases. AWS DMS supports heterogeneous migrations between different database platforms, such as IBM Db2 to Aurora PostgreSQL-Compatible version 10.18 or higher. For details, see [Sources for Data Migration](#) and [Targets for Data Migration](#) in the AWS DMS documentation.

- [AWS Schema Conversion Tool \(AWS SCT\)](#) supports heterogeneous database migrations by automatically converting the source database schema and a majority of the database code objects, including views, stored procedures, and functions, to a format that's compatible with the target database. Any objects that are not automatically converted are clearly marked so that they can be manually converted to complete the migration. AWS SCT can also scan the application source code for embedded SQL statements and convert them.

## Epics

### Set up the environment

Task	Description	Skills required
Create an Aurora PostgreSQL-Compatible DB instance.	<p>To create the DB instance, follow the instructions in the <a href="#">AWS documentation</a>. For engine type, choose <b>Amazon Aurora</b>. For edition, choose <b>Amazon Aurora PostgreSQL-Compatible Edition</b>.</p> <p>The Aurora PostgreSQL-Compatible version 10.18 or later DB instance should be in the same virtual private cloud (VPC) as the source IBM Db2 database.</p>	Amazon RDS

## Convert your database schema

Task	Description	Skills required
Install and verify AWS SCT.	<ol style="list-style-type: none"><li>1. Install AWS SCT by following the steps in the <a href="#">AWS SCT documentation</a>.</li><li>2. Verify the installation by following the procedures in the <a href="#">AWS SCT documentation</a>.</li></ol>	AWS administrator, DBA, Migration engineer
Start AWS SCT and create a project.	To start the AWS SCT tool and create a new project to run a database migration assessment report, follow the instructions in the <a href="#">AWS SCT documentation</a> .	Migration engineer
Add database servers and create a mapping rule.	<ol style="list-style-type: none"><li>1. Add source and target database servers by following the instructions in the <a href="#">AWS SCT documentation</a>.</li><li>2. Create a mapping rule to define the target database platform for your source database. For instructions, see the <a href="#">AWS SCT documentation</a>.</li></ol>	Migration engineer
Create a database migration assessment report.	Create the database migration assessment report by following the steps in the <a href="#">AWS SCT documentation</a> .	Migration engineer

Task	Description	Skills required
View the assessment report.	Use the <b>Summary</b> tab of the database migration assessment report to view the report and analyze the data. This analysis will help you determine the complexity of the migration. For more information, see the <a href="#">AWS SCT documentation</a> .	Migration engineer
Convert the schema.	To convert your source database schemas:  <ol style="list-style-type: none"><li>1. On the AWS SCT console, choose <b>View</b>, and then <b>Main view</b>.</li><li>2. Select the object or parent node from your source schema, open the context (right-click) menu, and then choose <b>Convert schema</b>.</li></ol> For more information, see the <a href="#">AWS SCT documentation</a> .	Migration engineer



Task	Description	Skills required
Apply the converted database schema to the target DB instance.	<ol style="list-style-type: none"><li>1. Choose the schema element in the right panel of your project that displays the planned schema for your target DB instance.</li><li>2. Open the context (right-click) menu for the schema element, and then choose <b>Apply to database</b>.</li></ol> <p>For more information, see the <a href="#">AWS SCT documentation</a>.</p>	Migration engineer

## Migrate your data

Task	Description	Skills required
Set up a VPC and DB parameter groups.	<p>Set up a VPC and DB parameter groups, and configure the inbound rules and parameters required for migration. For instructions, see the <a href="#">AWS DMS documentation</a>.</p> <p>For the VPC security group, select both the EC2 instance for Db2 and the Aurora PostgreSQL-Compatible DB instance. This replication instance must be in the same</p>	Migration engineer

Task	Description	Skills required
	VPC as the source and target DB instances.	
Prepare source and target DB instances.	<p>Prepare the source and target DB instances for migration . In a production environment, the source database will already exist.</p> <p>For the source database, the server name must be the public Domain Name System (DNS) of the EC2 instance where Db2 is running. For user name, you can use db2inst1 followed by the port, which will be 5000 for IBM Db2.</p>	Migration engineer

Task	Description	Skills required
Create an Amazon EC2 client and endpoints.	<ol style="list-style-type: none"><li>1. Create an Amazon EC2 client. You use this client to populate your source database with data to replicate. You also use this client to verify replication by running queries on the target database.</li><li>2. Create endpoints for the source database and target DB instance to use for the next steps. For instructions, see the <a href="#">AWS DMS documentation</a>. You must create separate endpoints for the source and target databases. For Aurora PostgreSQL-Compatible version 10.18 or later, the port will be 5432, and you can get the server name from the DB instance's endpoint.</li></ol>	Migration engineer
Create a replication instance.	Create a replication instance by using the AWS DMS console and specify the source and target endpoints . The replication instance performs the data migration between the endpoints. For more information, see the <a href="#">AWS DMS documentation</a> .	Migration engineer

Task	Description	Skills required
Create an AWS DMS task to migrate the data.	<p>Create a task to load the source IBM Db2 tables to the target PostgreSQL DB instance by following the steps in the <a href="#">AWS DMS documentation</a>.</p> <ul style="list-style-type: none"><li>• For source and target, use the source and destination endpoint names.</li><li>• The migration type can be full load.</li><li>• For the schema rule, you can use the <code>inst1</code> schema from the Db2 database.</li><li>• For the table name, specify <code>%</code> to migrate all tables. When the load is complete, you'll see the Db2 tables of the <code>inst1</code> schema appearing in the Aurora PostgreSQL-Compatible database.</li></ul>	Migration engineer

## Related resources

### References

- [Amazon Aurora documentation](#)
- [PostgreSQL foreign data wrapper \(FDW\) documentation](#)
- [PostgreSQL IMPORT FOREIGN SCHEMA documentation](#)
- [AWS DMS documentation](#)
- [AWS SCT documentation](#)

## Tutorials and videos

- [Getting Started with AWS DMS](#) (walkthrough)
- [Introduction to Amazon EC2 - Elastic Cloud Server & Hosting with AWS](#) (video)

# Migrate from Oracle 8i or 9i to Amazon RDS for PostgreSQL using SharePlex and AWS DMS

Created by Kumar Babu P G (AWS)

<b>Environment:</b> PoC or pilot	<b>Source:</b> Databases: Relational	<b>Target:</b> Amazon RDS for PostgreSQL/Amazon Aurora PostgreSQL
<b>R Type:</b> Re-architect	<b>Workload:</b> Oracle	<b>Technologies:</b> Migration; Databases
<b>AWS services:</b> Amazon RDS; Amazon Aurora		

## Summary

This pattern describes how to migrate an on-premises Oracle 8i or 9i database to Amazon Relational Database Service (Amazon RDS) for PostgreSQL or Amazon Aurora PostgreSQL. AWS Database Migration Service (AWS DMS) doesn't support Oracle 8i or 9i as a source, so Quest SharePlex replicates data from an on-premises 8i or 9i database to an intermediate Oracle database (Oracle 10g or 11g), which is compatible with AWS DMS.

From the intermediate Oracle instance, the schema and data are migrated to the PostgreSQL database on AWS by using AWS Schema Conversion Tool (AWS SCT) and AWS DMS. This method helps achieve continuous streaming of data from the source Oracle database to the target PostgreSQL DB instance with minimum replication lag. In this implementation, the downtime is limited to the length of time it takes to create or validate all the foreign keys, triggers, and sequences on the target PostgreSQL database.

The migration uses an Amazon Elastic Compute Cloud (Amazon EC2) instance with Oracle 10g or 11g installed to host the changes from the source Oracle database. AWS DMS uses this intermediate Oracle instance as the source to stream the data to Amazon RDS for PostgreSQL or Aurora PostgreSQL. Data replication can be paused and resumed from the on-premises Oracle database to the intermediate Oracle instance. It can also be paused and resumed from the intermediate Oracle instance to the target PostgreSQL database so you can validate the data by using either AWS DMS data validation or a custom data validation tool.

## Prerequisites and limitations

### Prerequisites

- An active AWS account
- A source Oracle 8i or 9i database in an on-premises data center
- AWS Direct Connect configured between the on-premises data center and AWS
- Java Database Connectivity (JDBC) drivers for AWS SCT connectors installed either on a local machine or on the EC2 instance where AWS SCT is installed
- Familiarity with [using an Oracle database as an AWS DMS source](#)
- Familiarity with [using a PostgreSQL database as an AWS DMS target](#)
- Familiarity with Quest SharePlex data replication

### Limitations

- The database size limit is 64 TB
- The on-premises Oracle database must be Enterprise Edition

### Product versions

- Oracle 8i or 9i for the source database
- Oracle 10g or 11g for the intermediate database
- PostgreSQL 9.6 or later

## Architecture

### Source technology stack

- Oracle 8i or 9i database
- Quest SharePlex

### Target technology stack

- Amazon RDS for PostgreSQL or Aurora PostgreSQL

## Source and target architecture

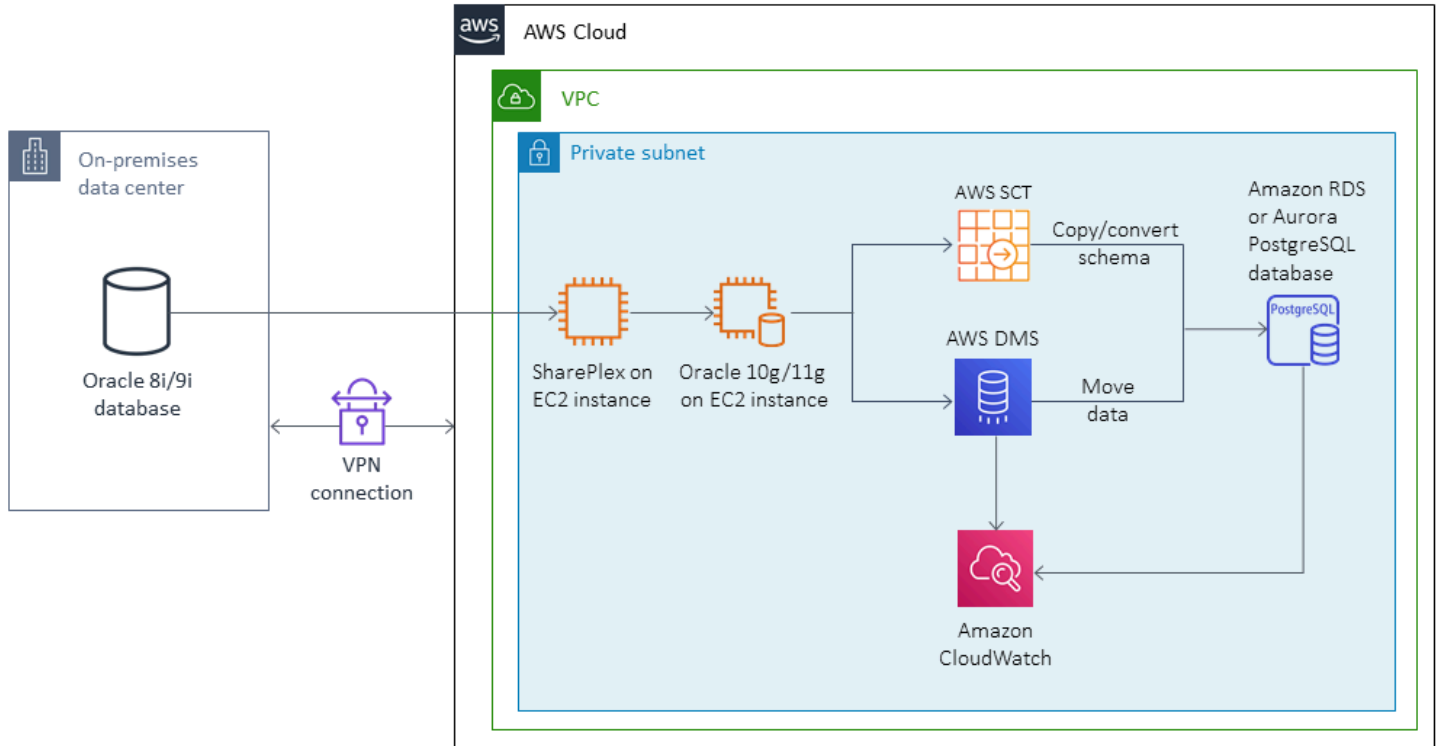

## Tools

- **AWS DMS** – [AWS Database Migration Service](#) (AWS DMS) helps you migrate databases quickly and securely. The source database remains fully operational during the migration, minimizing downtime to applications that rely on the database. AWS DMS can migrate your data to and from the most widely used commercial and open-source databases.
- **AWS SCT** – [AWS Schema Conversion Tool](#) (AWS SCT) makes heterogeneous database migrations predictable by automatically converting the source database schema and a majority of the database code objects, including views, stored procedures, and functions, to a format compatible with the target database. Objects that cannot be automatically converted are clearly marked so that they can be manually converted to complete the migration. AWS SCT can also scan your application source code for embedded SQL statements and convert them as part of a database schema conversion project. During this process, AWS SCT performs cloud-native code optimization by converting legacy Oracle and SQL Server functions to their AWS equivalents, to help you modernize your applications while migrating your databases. When schema conversion is complete, AWS SCT can help migrate data from a range of data warehouses to Amazon Redshift by using built-in data migration agents.



- **Quest SharePlex** – [Quest SharePlex](#) is an Oracle-to-Oracle data replication tool for moving data with minimal downtime and no data loss.

## Epics

### Create the EC2 instance and install Oracle

Task	Description	Skills required
Set up the network for Amazon EC2.	Create the virtual private cloud (VPC), subnets, internet gateway, route tables, and security groups.	AWS SysAdmin
Create the new EC2 instance.	Select the Amazon Machine Image (AMI) for the EC2 instance. Choose the instance size and configure instance details: the number of instances (1), the VPC and subnet from the previous step, auto-assign public IP, and other options. Add storage, configure security groups, and launch the instance. When prompted, create and save a key pair for the next step.	AWS SysAdmin
Install Oracle on the EC2 instance.	Acquire the licenses and the required Oracle binaries, and install Oracle 10g or 11g on the EC2 instance.	DBA

## Set up SharePlex on an EC2 instance and configure data replication

Task	Description	Skills required
Set up SharePlex.	Create an Amazon EC2 instance and install the SharePlex binaries that are compatible with Oracle 8i or 9i.	AWS SysAdmin, DBA
Configure data replication.	Follow SharePlex best practices to configure data replication from an on-premises Oracle 8i/9i database to an Oracle 10g/11g instance.	DBA

## Convert the Oracle database schema to PostgreSQL

Task	Description	Skills required
Set up AWS SCT.	Create a new report, and then connect to Oracle as the source and PostgreSQL as the target. In project settings, open the SQL Scripting tab and change the target SQL script to Multiple Files.	DBA
Convert the Oracle database schema.	In the Action tab, choose Generate Report, Convert Schema, and then Save as SQL.	DBA
Modify the SQL scripts generated by AWS SCT.		DBA

## Create and configure the Amazon RDS DB instance

Task	Description	Skills required
Create the Amazon RDS DB instance.	In the Amazon RDS console, create a new PostgreSQL DB instance.	AWS SysAdmin, DBA
Configure the DB instance.	Specify the DB engine version, DB instance class, Multi-AZ deployment, storage type, and allocated storage. Enter the DB instance identifier, a master user name, and a master password.	AWS SysAdmin, DBA
Configure network and security.	Specify the VPC, subnet group, public accessibility, Availability Zone preference, and security groups.	AWS SysAdmin, DBA
Configure database options.	Specify the database name, port, parameter group, encryption, and master key.	AWS SysAdmin, DBA
Configure backups.	Specify the backup retention period, backup window, start time, duration, and whether to copy tags to snapshots.	AWS SysAdmin, DBA
Configure monitoring options.	Enable or disable enhanced monitoring and performance insights.	AWS SysAdmin, DBA
Configure maintenance options.	Specify auto minor version upgrade, maintenance	AWS SysAdmin, DBA

Task	Description	Skills required
	window, and the start day, time, and duration.	
Run the pre-migration scripts from AWS SCT.	On the Amazon RDS instance, run these scripts: create_database.sql, create_sequence.sql, create_table.sql, create_view.sql, and create_function.sql.	AWS SysAdmin, DBA

### Migrate data by using AWS DMS

Task	Description	Skills required
Create a replication instance in AWS DMS.	Complete the fields for the name, instance class, VPC (same as for the EC2 instance), Multi-AZ, and public accessibility. In the advanced configuration section, specify allocated storage, subnet group, Availability Zone, VPC security groups, and AWS Key Management Service (AWS KMS) root key.	AWS SysAdmin, DBA
Create the source database endpoint.	Specify the endpoint name, type, source engine (Oracle), server name (Amazon EC2 private DNS name), port, SSL mode, user name, password, SID, VPC (specify the VPC that has the replication instance), and replication instance. To test the connection, choose	AWS SysAdmin, DBA

Task	Description	Skills required
	Run Test, and then create the endpoint. You can also configure the following advanced settings: maxFileSize and numberDataTypeScale.	
Create the AWS DMS replication task.	Specify the task name, replication instance, source and target endpoints, and replication instance. For migration type, choose "Migrate existing data and replicate ongoing changes." Clear the "Start task on create" check box.	AWS SysAdmin, DBA
Configure the AWS DMS replication task settings.	For target table preparation mode, choose "Do nothing." Stop the task after the full load completes to create primary keys. Specify limited or full LOB mode, and enable control tables. Optionally, you can configure the CommitRate advanced setting.	DBA

Task	Description	Skills required
Configure the table mappings.	In the table mappings section, create an Include rule for all tables in all schemas included in the migration, and then create an Exclude rule. Add three transformation rules to convert the schema, table, and column names to lowercase, and add any other rules needed for this specific migration.	DBA
Start the task.	Start the replication task. Make sure that the full load is running. Run ALTER SYSTEM SWITCH LOGFILE on the primary Oracle database to kick-start the task.	DBA
Run the mid-migration scripts from AWS SCT.	In Amazon RDS for PostgreSQL, run these scripts: create_index.sql and create_constraint.sql.	DBA
Restart the task to continue change data capture (CDC).	In the Amazon RDS for PostgreSQL DB instance, run VACUUM, and restart the AWS DMS task to apply the cached CDC changes.	DBA

## Cut over to the PostgreSQL database

Task	Description	Skills required
Check the AWS DMS logs and metadata tables.	Validate any errors and fix if required.	DBA
Stop all Oracle dependencies.	Shut down listeners on the Oracle database and run ALTER SYSTEM SWITCH LOGFILE. Stop the AWS DMS task when it shows no activity.	DBA
Run the post-migration scripts from AWS SCT.	In Amazon RDS for PostgreSQL, run these scripts: create_foreign_key_constraint.sql and create_triggers.sql.	DBA
Complete any additional Amazon RDS for PostgreSQL steps.	Increment sequences to match Oracle if needed, run VACUUM and ANALYZE, and take a snapshot for compliance.	DBA
Open the connections to Amazon RDS for PostgreSQL.	Remove the AWS DMS security groups from Amazon RDS for PostgreSQL, add production security groups, and point your applications to the new database.	DBA
Clean up AWS DMS resources.	Remove the endpoints, replication tasks, replication instances, and the EC2 instance.	SysAdmin, DBA

## Related resources

- [AWS DMS documentation](#)
- [AWS SCT documentation](#)
- [Amazon RDS for PostgreSQL pricing](#)
- [Using an Oracle database as a source for AWS DMS](#)
- [Using a PostgreSQL database as a target for AWS DMS](#)
- [Quest SharePlex documentation](#)



# Migrate from Oracle 8i or 9i to Amazon RDS for PostgreSQL using materialized views and AWS DMS

Created by Kumar Babu P G (AWS) and Pragnesh Patel (AWS)

<b>Environment:</b> PoC or pilot	<b>Source:</b> Oracle 8i or 9i	<b>Target:</b> Amazon RDS for PostgreSQL or Aurora PostgreSQL-Compatible
<b>R Type:</b> Re-architect	<b>Workload:</b> Oracle	<b>Technologies:</b> Migration; Databases
<b>AWS services:</b> Amazon RDS; Amazon Aurora		

## Summary

This pattern describes how to migrate an on-premises legacy Oracle 8i or 9i database to Amazon Relational Database Service (Amazon RDS) for PostgreSQL or Amazon Aurora PostgreSQL-Compatible Edition.

AWS Database Migration Service (AWS DMS) doesn't support Oracle 8i or 9i as a source, so this pattern uses an intermediate Oracle database instance that's compatible with AWS DMS, such as Oracle 10g or 11g. It also uses the materialized views feature to migrate data from the source Oracle 8i/9i instance to the intermediate Oracle 10g/11g instance.

AWS Schema Conversion Tool (AWS SCT) converts the database schema, and AWS DMS migrates the data to the target PostgreSQL database.

This pattern helps users who want to migrate from legacy Oracle databases with minimum database downtime. In this implementation, the downtime would be limited to the length of time it takes to create or validate all the foreign keys, triggers, and sequences on the target database.

The pattern uses Amazon Elastic Compute Cloud (Amazon EC2) instances with an Oracle 10g/11g database installed to help AWS DMS stream the data. You can temporarily pause streaming replication from the on-premises Oracle database to the intermediate Oracle instance to enable AWS DMS to catch up on data validation or to use another data validation tool. The PostgreSQL DB

instance and intermediate Oracle database will have the same data when AWS DMS has finished migrating current changes.

## Prerequisites and limitations

### Prerequisites

- An active AWS account
- A source Oracle 8i or 9i database in an on-premises data center
- AWS Direct Connect configured between the on-premises data center and AWS
- Java Database Connectivity (JDBC) drivers for AWS SCT connectors installed either on a local machine or on the EC2 instance where AWS SCT is installed
- Familiarity with [using an Oracle database as an AWS DMS source](#)
- Familiarity with [using a PostgreSQL database as an AWS DMS target](#)

### Limitations

- The database size limit is 64 TB

### Product versions

- Oracle 8i or 9i for the source database
- Oracle 10g or 11g for the intermediate database
- PostgreSQL 10.17 or later

## Architecture

### Source technology stack

- Oracle 8i or 9i database

### Target technology stack

- Amazon RDS for PostgreSQL or Aurora PostgreSQL-Compatible

### Target architecture

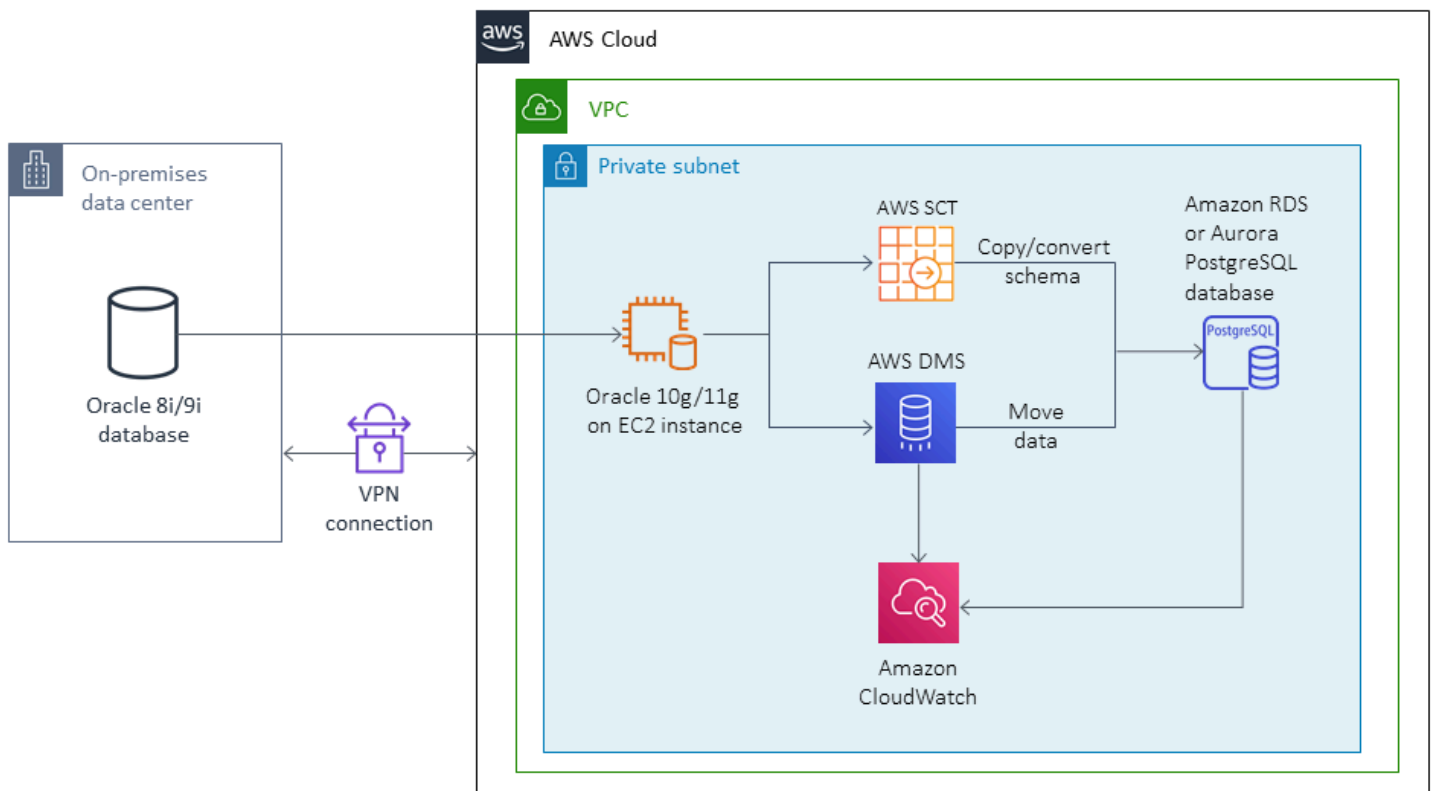

## Tools

- [AWS DMS](#) helps migrate databases quickly and securely. The source database remains fully operational during the migration, minimizing downtime to applications that rely on the database. AWS DMS can migrate your data to and from the most widely used commercial and open-source databases.
- [AWS SCT](#) automatically converting the source database schema and a majority of the database code objects, including views, stored procedures, and functions, to a format compatible with the target database. Objects that cannot be automatically converted are clearly marked so that they can be manually converted to complete the migration. AWS SCT can also scan your application source code for embedded SQL statements and convert them as part of a database schema conversion project. During this process, AWS SCT performs cloud-native code optimization by converting legacy Oracle and SQL Server functions to their AWS equivalents, to help you modernize your applications while migrating your databases. When schema conversion is complete, AWS SCT can help migrate data from a range of data warehouses to Amazon Redshift by using built-in data migration agents.

## Best practices

For best practices for refreshing materialized views, see the following Oracle documentation:

- [Refreshing materialized views](#)
- [Fast refresh for materialized views](#)

## Epics

### Install Oracle on an EC2 instance and create materialized views

Task	Description	Skills required
Set up the network for the EC2 instance.	Create the virtual private cloud (VPC), subnets, internet gateway, route tables, and security groups.	AWS SysAdmin
Create the EC2 instance.	Select the Amazon Machine Image (AMI) for the EC2 instance. Choose the instance size and configure instance details: the number of instances (1), the VPC and subnet from the previous step, auto-assign public IP, and other options. Add storage, configure security groups, and launch the instance. When prompted, create and save a key pair for the next step.	AWS SysAdmin
Install Oracle on the EC2 instance.	Acquire the licenses and the required Oracle binaries, and install Oracle 10g or 11g on the EC2 instance.	DBA

Task	Description	Skills required
Configure Oracle networking.	Modify or add entries in <code>listener.ora</code> to connect to the on-premises source Oracle 8i/9i database, and then create the database links.	DBA
Create materialized views.	Identify the database objects to replicate in the source Oracle 8i/9i database, and then create materialized views for all the objects by using the database link.	DBA
Deploy scripts to refresh materialized views at required intervals.	Develop and deploy scripts to refresh materialized views at required intervals on the Amazon EC2 Oracle 10g/11g instance. Use the incremental refresh option to refresh materialized views.	DBA

## Convert the Oracle database schema to PostgreSQL

Task	Description	Skills required
Set up AWS SCT.	Create a new report, and then connect to Oracle as the source and PostgreSQL as the target. In project settings, open the <b>SQL Scripting</b> tab. Change the target SQL script to <b>Multiple Files</b> . (AWS SCT doesn't support Oracle 8i/9i databases, so you have to	DBA

Task	Description	Skills required
	restore the schema-only dump on the intermediate Oracle 10g/11g instance and use it as a source for AWS SCT.)	
Convert the Oracle database schema.	On the <b>Action</b> tab, choose <b>Generate Report, Convert Schema</b> , and then <b>Save as SQL</b> .	DBA
Modify the SQL scripts.	Make modifications based on best practices. For example, switch to suitable data types and develop PostgreSQL equivalents for Oracle-specific functions.	DBA, DevDBA

### Create and configure the Amazon RDS DB instance to host the converted database

Task	Description	Skills required
Create the Amazon RDS DB instance.	In the Amazon RDS console, create a new PostgreSQL DB instance.	AWS SysAdmin, DBA
Configure the DB instance.	Specify the DB engine version, DB instance class, Multi-AZ deployment, storage type, and allocated storage. Enter the DB instance identifier, a master user name, and a master password.	AWS SysAdmin, DBA

Task	Description	Skills required
Configure network and security.	Specify the VPC, subnet group, public accessibility, Availability Zone preference, and security groups.	DBA, SysAdmin
Configure database options.	Specify the database name, port, parameter group, encryption, and master key.	DBA, AWS SysAdmin
Configure backups.	Specify the backup retention period, backup window, start time, duration, and whether to copy tags to snapshots.	AWS SysAdmin, DBA
Configure monitoring options.	Enable or disable enhanced monitoring and performance insights.	AWS SysAdmin, DBA
Configure maintenance options.	Specify auto minor version upgrade, maintenance window, and the start day, time, and duration.	AWS SysAdmin, DBA
Run the pre-migration scripts from AWS SCT.	On the target Amazon RDS for PostgreSQL instance, create the database schema by using the SQL scripts from AWS SCT with other modifications. These might include running multiple scripts and including user creation, database creation, schema creation, tables, views, functions, and other code objects.	AWS SysAdmin, DBA

## Migrate data by using AWS DMS

Task	Description	Skills required
Create a replication instance in AWS DMS.	Complete the fields for the name, instance class, VPC (same as for the EC2 instance), Multi-AZ, and public accessibility. In the advanced configuration section, specify allocated storage, subnet group, Availability Zone, VPC security groups, and AWS Key Management Service (AWS KMS) key.	AWS SysAdmin, DBA
Create the source database endpoint.	Specify the endpoint name, type, source engine (Oracle), server name (the EC2 instance's private DNS name), port, SSL mode, user name, password, SID, VPC (specify the VPC that has the replication instance), and replication instance. To test the connection, choose <b>Run Test</b> , and then create the endpoint. You can also configure the following advanced settings: <b>maxFileSize</b> and <b>numberDataTypesScale</b> .	AWS SysAdmin, DBA
Connect AWS DMS to Amazon RDS for PostgreSQL.	Create a migration security group for connections across VPCs, if your PostgreSQL database is in another VPC.	AWS SysAdmin, DBA



Task	Description	Skills required
Create the target database endpoint.	Specify the endpoint name, type, source engine (PostgreSQL), server name (Amazon RDS endpoint), port, SSL mode, user name, password, database name, VPC (specify the VPC that has the replication instance), and replication instance. To test the connection, choose <b>Run Test</b> , and then create the endpoint. You can also configure the following advanced settings: <b>maxFileSize</b> and <b>numberDataTypes</b> .	AWS SysAdmin, DBA
Create the AWS DMS replication task.	Specify the task name, replication instance, source and target endpoints, and replication instance. For migration type, choose <b>Migrate existing data and replicate ongoing changes</b> . Clear the <b>Start task on create</b> check box.	AWS SysAdmin, DBA
Configure the AWS DMS replication task settings.	For target table preparation mode, choose <b>Do nothing</b> . Stop the task after full load completes (to create primary keys). Specify limited or full LOB mode, and enable control tables. Optionally, you can configure the <b>CommitRate</b> advanced setting.	DBA

Task	Description	Skills required
Configure the table mappings.	In the <b>Table mappings</b> section, create an Include rule for all tables in all schemas included in the migration, and then create an Exclude rule. Add three transformation rules to convert the schema, table, and column names to lowercase, and add any other rules you need for this specific migration.	DBA
Start the task.	Start the replication task. Make sure that the full load is running. Run <code>ALTER SYSTEM SWITCH LOGFILE</code> on the primary Oracle database to start the task.	DBA
Run the mid-migration scripts from AWS SCT.	In Amazon RDS for PostgreSQL, run the following scripts: <code>create_index.sql</code> and <code>create_constraint.sql</code> (if the complete schema wasn't initially created).	DBA
Resume the task to continue change data capture (CDC).	Run <code>VACUUM</code> on the Amazon RDS for PostgreSQL DB instance, and restart the AWS DMS task to apply cached CDC changes.	DBA

## Cut over to the PostgreSQL database

Task	Description	Skills required
Check the AWS DMS logs and validation tables.	Check and fix any replication or validation errors.	DBA
Stop using the on-premises Oracle database and its dependencies.	Stop all Oracle dependencies, shut down listeners on the Oracle database, and run <code>ALTER SYSTEM SWITCH LOGFILE</code> . Stop the AWS DMS task when it shows no activity.	DBA
Run the post-migration scripts from AWS SCT.	In Amazon RDS for PostgreSQL, run these scripts: <code>create_foreign_key_constraint.sql</code> and <code>create_triggers.sql</code> . Make sure that the sequences are up to date.	DBA
Complete additional Amazon RDS for PostgreSQL steps.	Increment sequences to match Oracle if needed, run <code>VACUUM</code> and <code>ANALYZE</code> , and take a snapshot for compliance.	DBA
Open the connections to Amazon RDS for PostgreSQL.	Remove the AWS DMS security groups from Amazon RDS for PostgreSQL, add production security groups, and point your applications to the new database.	DBA
Clean up the AWS DMS objects.	Remove the endpoints, replication tasks, replicati	SysAdmin, DBA

Task	Description	Skills required
	on instances, and the EC2 instance.	

## Related resources

- [AWS DMS documentation](#)
- [AWS SCT documentation](#)
- [Amazon RDS for PostgreSQL pricing](#)
- [Using an Oracle database as a source for AWS DMS](#)
- [Using a PostgreSQL database as a target for AWS DMS](#)

# Migrate from Oracle on Amazon EC2 to Amazon RDS for MySQL using AWS DMS and AWS SCT

*Created by Anil Kunapareddy (AWS) and Harshad Gohil*

<b>Environment:</b> PoC or pilot	<b>Source:</b> Databases: Relational	<b>Target:</b> Amazon RDS for MySQL
<b>R Type:</b> Re-architect	<b>Workload:</b> Oracle	<b>Technologies:</b> Migration; Databases
<b>AWS services:</b> Amazon RDS		

## Summary

Managing Oracle databases on Amazon Elastic Compute Cloud (Amazon EC2) instances requires resources and can be costly. Moving these databases to an Amazon Relational Database Service (Amazon RDS) for MySQL DB instance will ease your job by optimizing the overall IT budget. Amazon RDS for MySQL also provides features like Multi-AZ, scalability, and automatic backups.

This pattern walks you through the migration of a source Oracle database on Amazon EC2 to a target Amazon RDS for MySQL DB instance. It uses AWS Database Migration Service (AWS DMS) to migrate the data, and AWS Schema Conversion Tool (AWS SCT) to convert the source database schema and objects to a format that's compatible with Amazon RDS for MySQL.

## Prerequisites and limitations

### Prerequisites

- An active AWS account
- A source database with instance and listener services running, in ARCHIVELOG mode
- A target Amazon RDS for MySQL database, with sufficient storage for data migration

### Limitations

- AWS DMS does not create a schema on the target database; you have to do that. The schema name must already exist for the target. Tables from the source schema are imported to user/

schema, which AWS DMS uses to connect to the target instance. You must create multiple replication tasks if you have to migrate multiple schemas.

## Product versions

- All Oracle database editions for versions 10.2 and later, 11g and up to 12.2, and 18c. For the latest list of supported versions, see [Using an Oracle Database as a Source for AWS DMS](#) and [Using a MySQL-Compatible Database as a Target for AWS DMS](#). We recommend that you use the latest version of AWS DMS for the most comprehensive version and feature support. For information about Oracle database versions supported by AWS SCT, see the [AWS SCT documentation](#).
- AWS DMS supports versions 5.5, 5.6, and 5.7 of MySQL.

## Architecture

### Source technology stack

- An Oracle database on an EC2 instance

### Target technology stack

- Amazon RDS for MySQL DB instance

### Data migration architecture

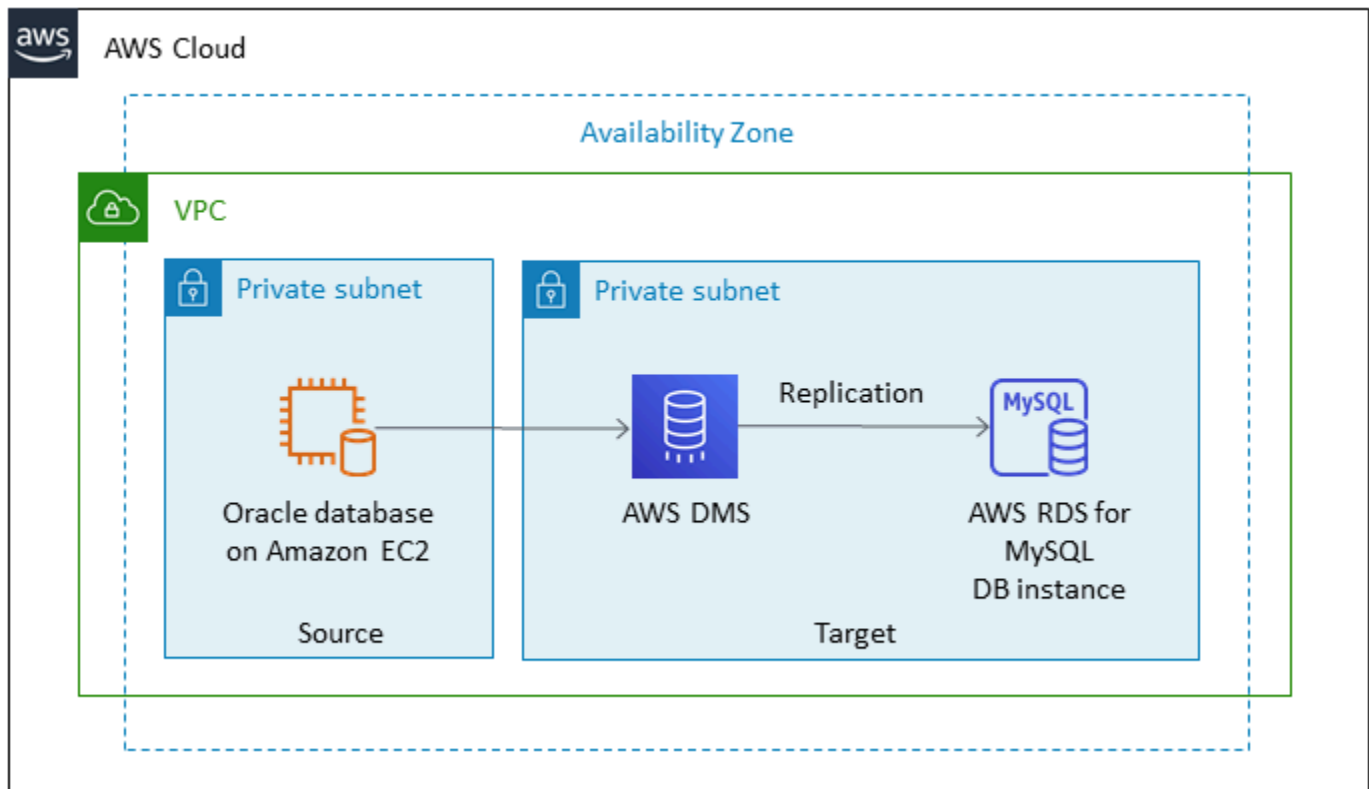

### Source and target architecture

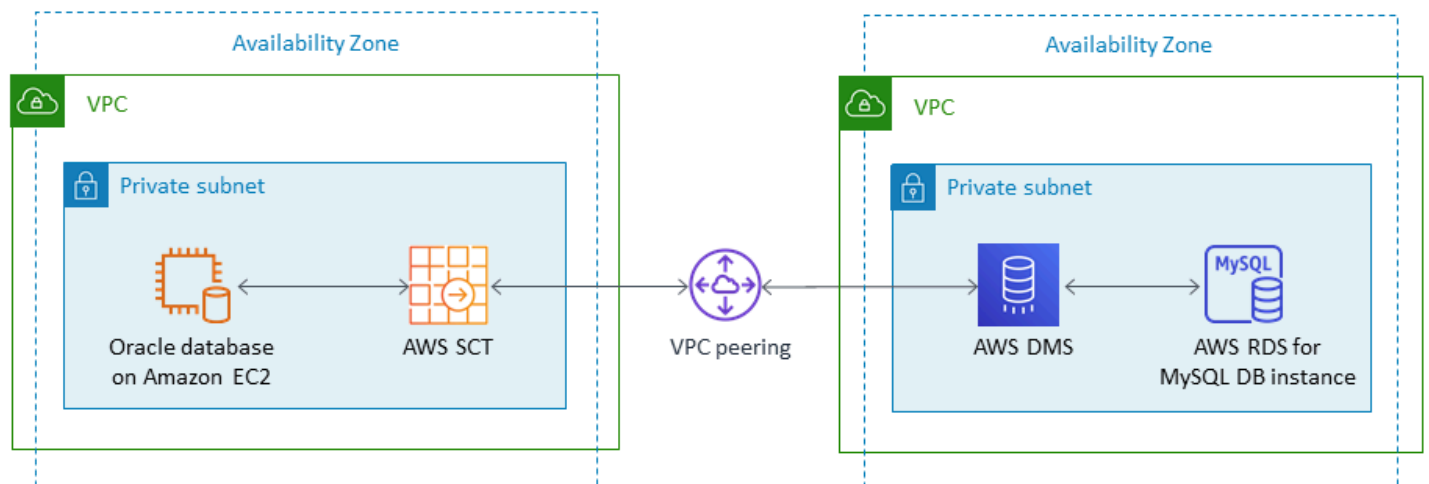

### Tools

- **AWS DMS** - [AWS Database Migration Service](#) (AWS DMS) is a web service you can use to migrate data from your database that is on-premises, on an Amazon RDS DB instance, or in a database on an EC2 instance, to a database on an AWS service such as Amazon RDS for MySQL or an EC2

instance. You can also migrate a database from an AWS service to an on-premises database. You can migrate data between heterogeneous or homogeneous database engines.

- **AWS SCT** - [AWS Schema Conversion Tool](#) (AWS SCT) makes heterogeneous database migrations predictable by automatically converting the source database schema and a majority of the database code objects, including views, stored procedures, and functions, to a format that's compatible with the target database. After converting your database schema and code objects using AWS SCT, you can use AWS DMS to migrate data from the source database to the target database to complete your migration projects.

## Epics

### Plan the migration

Task	Description	Skills required
Identify the source and target database versions and engines.		DBA/Developer
Identify the DMS replication instance.		DBA/Developer
Identify storage requirements such as storage type and capacity.		DBA/Developer
Identify network requirements such as latency and bandwidth.		DBA/Developer
Identify hardware requirements for the source and target server instances (based on Oracle compatibility list and capacity requirements).		DBA/Developer



Task	Description	Skills required
Identify network access security requirements for source and target databases.		DBA/Developer
Install AWS SCT and Oracle drivers.		DBA/Developer
Determine a backup strategy.		DBA/Developer
Determine availability requirements.		DBA/Developer
Identify application migration and switch-over strategy.		DBA/Developer
Select the proper DB instance type based on capacity, storage, and network features.		DBA/Developer

## Configure the environment

Task	Description	Skills required
Create a virtual private cloud (VPC). The source, target, and replication instance should be in the same VPC. It is also good to have these in the same Availability Zone.		Developer
Create the necessary security groups for database access.		Developer
Generate and configure a key pair.		Developer

Task	Description	Skills required
Configure subnets, Availability Zones, and CIDR blocks.		Developer

### Configure the source: Oracle database on EC2 instance

Task	Description	Skills required
Install Oracle Database on Amazon EC2 with required users and roles.		DBA
Perform the three steps in the next column to access Oracle from outside the EC2 instance.	<ol style="list-style-type: none"> <li>1. Change the local host in <code>tnsnames</code> to the Amazon EC2 public DNS.</li> <li>2. Change the local host in <code>listener</code> to the Amazon EC2 public DNS.</li> <li>3. Stop and restart the listener.</li> </ol>	DBA
When Amazon EC2 is restarted, the public DNS changes. Make sure to update Amazon EC2 public DNS in 'tnsnames' and 'listener' or use an Elastic IP address.		DBA/Developer
Configure the EC2 instance security group so that the replication instance and required clients can access the source database.		DBA/Developer

## Configure the target: Amazon RDS for MySQL

Task	Description	Skills required
Configure and start the Amazon RDS for MySQL DB instance.		Developer
Create the necessary tablespace in the Amazon RDS for MySQL DB instance.		DBA
Configure the security group so that the replication instance and required clients can access the target database.		Developer

## Configure AWS SCT and create a schema in the target database

Task	Description	Skills required
Install AWS SCT and Oracle drivers.		Developer
Enter the appropriate parameters and connect to the source and target.		Developer
Generate a schema conversion report.		Developer
Correct the code and schema as necessary, especially tablespaces and quotes, and run on the target database.		Developer

Task	Description	Skills required
Validate the schema on source vs. target before migrating data.		Developer

## Migrate data using AWS DMS

Task	Description	Skills required
For full-load and change data capture (CDC) or just CDC, you must set an extra connection attribute.		Developer
The user specified in the AWS DMS source Oracle database definitions must be granted all the required privileges. For a complete list, see <a href="https://docs.aws.amazon.com/dms/latest/userguide/CHAP_Source.Oracle.html#CHAP_Source.Oracle.Self-Managed">https://docs.aws.amazon.com/dms/latest/userguide/CHAP_Source.Oracle.html#CHAP_Source.Oracle.Self-Managed</a> .		DBA/Developer
Enable supplemental logging in the source database.		DBA/Developer
For full-load and change data capture (CDC) or just CDC, enable ARCHIVELOG mode in the source database.		DBA
Create source and target endpoints, and test the connections.		Developer

Task	Description	Skills required
When the endpoints are connected successfully, create a replication task.		Developer
Select CDC only (or) full load plus CDC in the task to capture changes for continuous replication only (or) full load plus ongoing changes, respectively.		Developer
Run the replication task and monitor Amazon CloudWatch logs.		Developer
Validate the data in the source and target databases.		Developer

### Migrate your application and cut over

Task	Description	Skills required
Follow the steps for your application migration strategy.		DBA, Developer, App owner
Follow the steps for your application cutover/switch-over strategy.		DBA, Developer, App owner

## Close the project

Task	Description	Skills required
Validate the schema and data in source vs. target databases.		DBA/Developer
Gather metrics around time to migrate, percent of manual vs. tool, cost savings, etc.		DBA/Developer/AppOwner
Review the project documents and artifacts.		DBA/Developer/AppOwner
Shut down temporary AWS resources.		DBA/Developer
Close out the project and provide feedback.		DBA/Developer/AppOwner

## Related resources

- [AWS DMS documentation](#)
- [AWS DMS website](#)
- [AWS DMS blog posts](#)
- [Strategies for Migrating Oracle Database to AWS](#)
- [Amazon RDS for Oracle FAQs](#)
- [Oracle FAQ](#)
- [Amazon EC2](#)
- [Amazon EC2 FAQs](#)
- [Licensing Oracle Software in the Cloud Computing Environment](#)

# Migrate from Oracle to Amazon DocumentDB using AWS DMS

*Created by Sashikanta Pattanayak (AWS) and Munesh Siddappa (AWS)*

<b>Environment:</b> PoC or pilot	<b>Source:</b> Databases: Relational	<b>Target:</b> Amazon DocumentDB
<b>R Type:</b> Re-architect	<b>Workload:</b> Oracle	<b>Technologies:</b> Migration; Databases
<b>AWS services:</b> Amazon DocumentDB		

## Summary

This pattern provides guidance for migrating an Oracle database to an Amazon DocumentDB (with MongoDB compatibility) database by using AWS Database Migration Service (AWS DMS). This approach can be applied to an on-premises Oracle source database as well as an Amazon Relational Database Service (Amazon RDS) for Oracle DB instance. This pattern uses an Amazon RDS Oracle DB source instance as an example.

Amazon DocumentDB (with MongoDB compatibility) is a fully managed, MongoDB-compatible document database service that makes it easy to store, query, and index JSON data.

The use case for this pattern is one-to-one replication of an Oracle database table to an Amazon DocumentDB collection. The pattern uses AWS DMS replication tasks to read the table structure of the Oracle database, create the corresponding collection in Amazon DocumentDB, and perform a full load migration. You can view and query your data in Amazon DocumentDB, the same as you would in MongoDB.

## Prerequisites and limitations

### Prerequisites

- An active AWS account
- Familiarity with using Oracle databases

- Familiarity with using Amazon DocumentDB
- For the Oracle user, SELECT ANY TABLE privilege
- For the Amazon DocumentDB use, the privilege required to dump data

## Limitations

The following limitations apply when using Amazon DocumentDB as a target for AWS DMS:

- In Amazon DocumentDB, collection names can't contain the dollar symbol (\$). In addition, database names can't contain any Unicode characters.
- AWS DMS doesn't support merging of multiple source tables into a single Amazon DocumentDB collection.
- When AWS DMS processes changes from a source table that doesn't have a primary key, any large binary object (LOB) columns in that table are ignored.
- If the **Change table** option is enabled and AWS DMS encounters a source column named "\_id", that column appears as "\_\_id" (two underscores) in the change table.
- If you choose Oracle as a source endpoint, the Oracle source must have full supplemental logging enabled. Otherwise, if there are columns at the source that weren't changed, the data is loaded into Amazon DocumentDB as null values.

## Product versions

- Amazon RDS for Oracle version 11.2.0.3 or later
- AWS DMS version 3.1.3 or later (for the latest version information, see [Using Amazon DocumentDB as a Target for AWS DMS](#) in the AWS DMS documentation)

## Architecture

### Source technology stack

- Amazon RDS for Oracle DB instance

### Target technology stack

- Amazon DocumentDB



## Source and target architecture

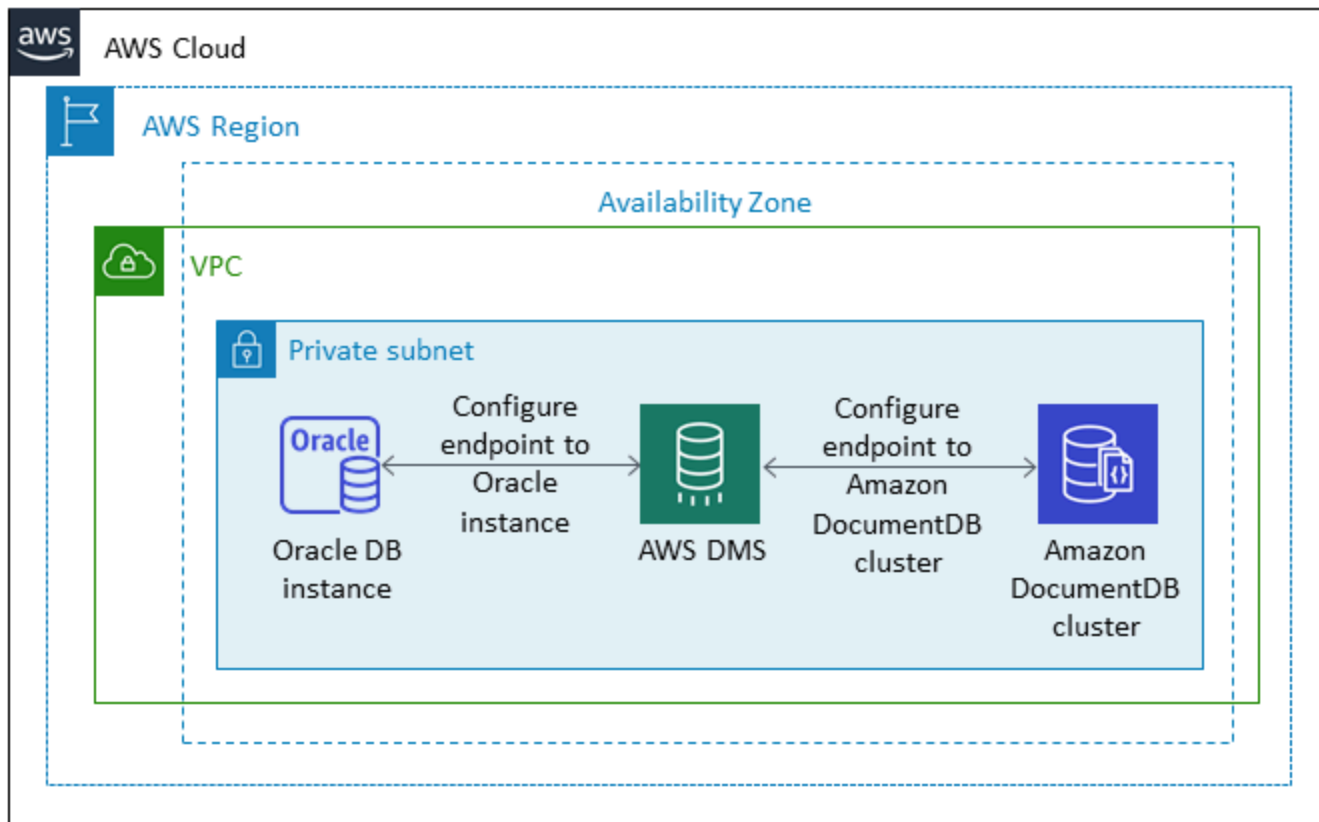

## Tools

- **AWS DMS** – [AWS Database Migration Service](#) (AWS DMS) is a web service that you can use to migrate data from a source data store to a target data store. The [AWS DMS User Guide](#) specifies the Oracle source database versions and editions that are supported for use with AWS DMS. For additional information relevant to this pattern, see [Using Amazon DocumentDB as a Target for AWS DMS](#).
- **Amazon EC2** – [Amazon Elastic Compute Cloud](#) (Amazon EC2) provides scalable computing capacity in the AWS cloud. Your Amazon DocumentDB cluster should be running in your default virtual private cloud (VPC). To interact with your Amazon DocumentDB cluster, you must launch an EC2 instance into your default VPC, in the same AWS Region where you created your Amazon DocumentDB cluster. For details, refer to [Launch an Amazon EC2 instance](#) in the Amazon DocumentDB documentation.

## Epics

### Plan the migration

Task	Description	Skills required
Validate the source and target database versions and engines.		AWS Admin
Choose the proper instance type (capacity, storage features, network features).		AWS Admin
Identify network/host access security requirements for the source and target databases.		AWS Admin
Create an outbound security group to the source and target databases.		AWS Admin
Create and configure an EC2 instance for Amazon DocumentDB.		AWS Admin

### Configure infrastructure

Task	Description	Skills required
Create a VPC and subnets.		AWS Admin
Create security groups and network access control lists (ACLs).		AWS Admin

Task	Description	Skills required
Configure and start the source Amazon RDS for Oracle instance.		AWS Admin
Configure and start the Amazon DocumentDB instance.		AWS Admin

### Prepare the source database

Task	Description	Skills required
Verify that the Oracle database can be connected using the connection details.		AWS Admin
Verify that the Oracle user has the SELECT ANY TABLE privilege.		AWS Admin

### Prepare the target database

Task	Description	Skills required
Create the Amazon DocumentDB cluster by choosing the proper instance class and number of instances .		AWS Admin

## Configure Amazon EC2

Task	Description	Skills required
Configure the EC2 instance.	To interact with your Amazon DocumentDB cluster, you must launch an EC2 instance into your default VPC, in the same AWS Region where you created your Amazon DocumentDB cluster. Configure the AWS Region, VPCs, Availability Zones, and subnets for the EC2 instance.	AWS Admin
Configure the key pair.	A public/private key pair allows you to connect securely to the EC2 instance after it launches.	AWS Admin
Set the bastion host CIDR ranges (optional).	Set the CIDR IP range that is allowed for external Secure Shell (SSH) access to the bastion host instances.	AWS Admin

## Migrate data – full load

Task	Description	Skills required
Create an AWS DMS replication instance.		AWS Admin
Create source and target endpoints.		AWS Admin
Create AWS DMS replication tasks for a full load.		AWS Admin

## Test the migration

Task	Description	Skills required
Connect to the Amazon DocumentDB cluster through the EC2 instance.		AWS Admin
Connect to the cluster using the mongo shell.	For instructions, see the Amazon DocumentDB links in the References and Help section.	AWS Admin
Verify the results of the migration.		AWS Admin

## Related resources

- [How AWS DMS Works](#)
- [Migrating to Amazon DocumentDB](#)
- [Using Amazon DocumentDB as a Target for AWS DMS](#)
- [Amazon DocumentDB overview](#)
- [Access and Use Your Amazon DocumentDB cluster Using the mongo Shell](#)
- [Migrate from MongoDB to Amazon DocumentDB using the offline method \(blog post\)](#)
- [How to use Amazon DocumentDB \(with MongoDB compatibility\) to build and manage applications at scale \(blog post\)](#)

# Migrate an Oracle database from Amazon EC2 to Amazon RDS for MariaDB using AWS DMS and AWS SCT

Created by Veeranjanyulu Grandhi (AWS) and vinod kumar (AWS)

<b>Environment:</b> PoC or pilot	<b>Source:</b> Databases: Relational	<b>Target:</b> Amazon RDS for MariaDB
<b>R Type:</b> Re-architect	<b>Workload:</b> Oracle	<b>Technologies:</b> Migration; Databases
<b>AWS services:</b> Amazon RDS		

## Summary

This pattern walks you through the steps for migrating an Oracle database on an Amazon Elastic Compute Cloud (Amazon EC2) instance to an Amazon Relational Database Service (Amazon RDS) for MariaDB DB instance. The pattern uses AWS Data Migration Service (AWS DMS) for data migration and AWS Schema Conversion Tool (AWS SCT) for schema conversion.

Managing Oracle databases on EC2 instances requires more resources and is more costly than using a database on Amazon RDS. Amazon RDS makes it easy to set up, operate, and scale a relational database in the cloud. Amazon RDS provides cost-efficient and resizable capacity while automating time-consuming administration tasks such as hardware provisioning, database setup, patching, and backups.

## Prerequisites and limitations

### Prerequisites

- An active AWS account.
- A source Oracle database with instance and listener services up and running. This database should be in ARCHIVELOG mode.
- Familiarity with [Using an Oracle Database as a Source for AWS DMS](#).
- Familiarity with [Using Oracle as a Source for AWS SCT](#).

## Limitations

- Database size limit: 64 TB

## Product versions

- All Oracle database editions for versions 10.2 and later, 11g and up to 12.2, and 18c. For the latest list of supported versions, see [Using an Oracle Database as a Source for AWS DMS](#) and the [AWS SCT version table](#) in the AWS documentation.
- Amazon RDS supports MariaDB Server Community Server versions 10.3, 10.4, 10.5, and 10.6. For the latest list of supported versions, see the [Amazon RDS documentation](#).

## Architecture

### Source technology stack

- An Oracle database on an EC2 instance

### Target technology stack

- Amazon RDS for MariaDB

### Data migration architecture

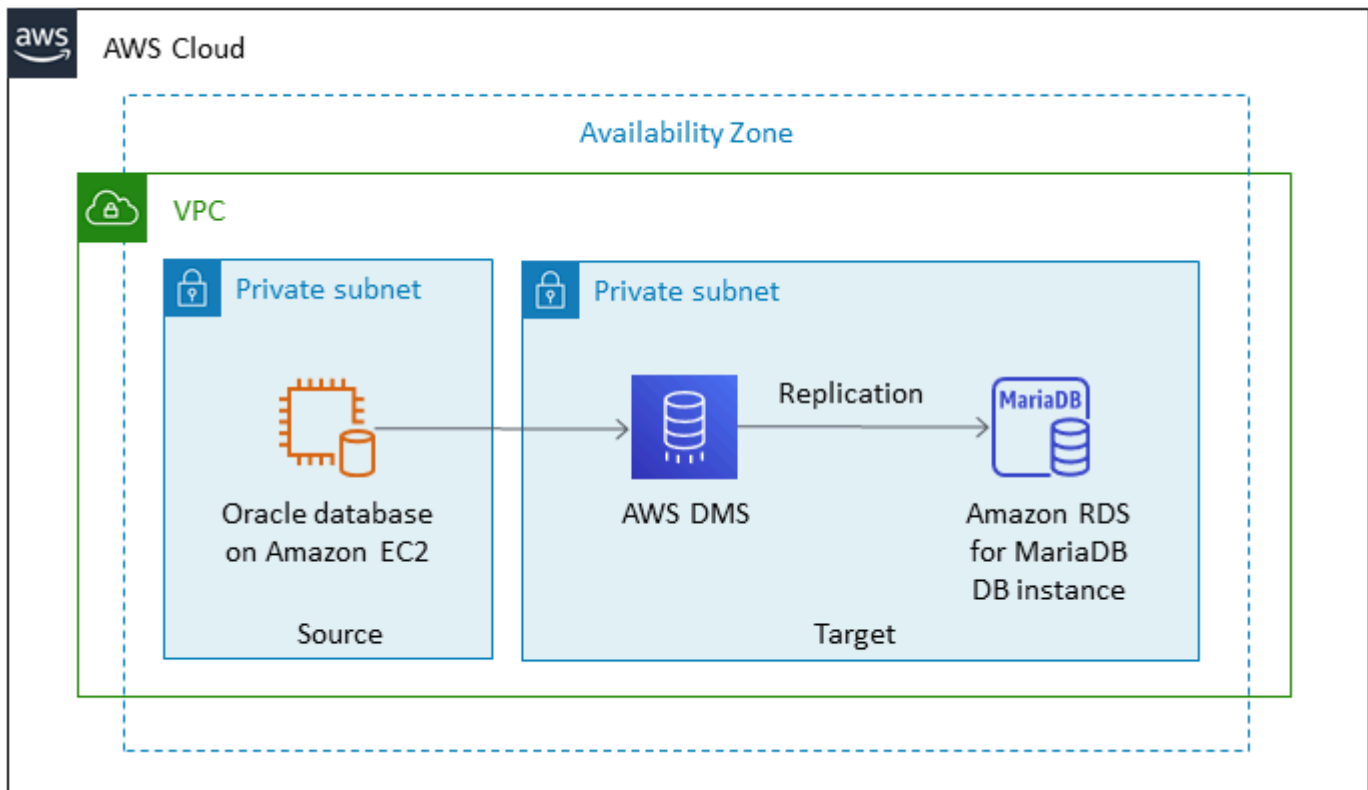

### Target architecture

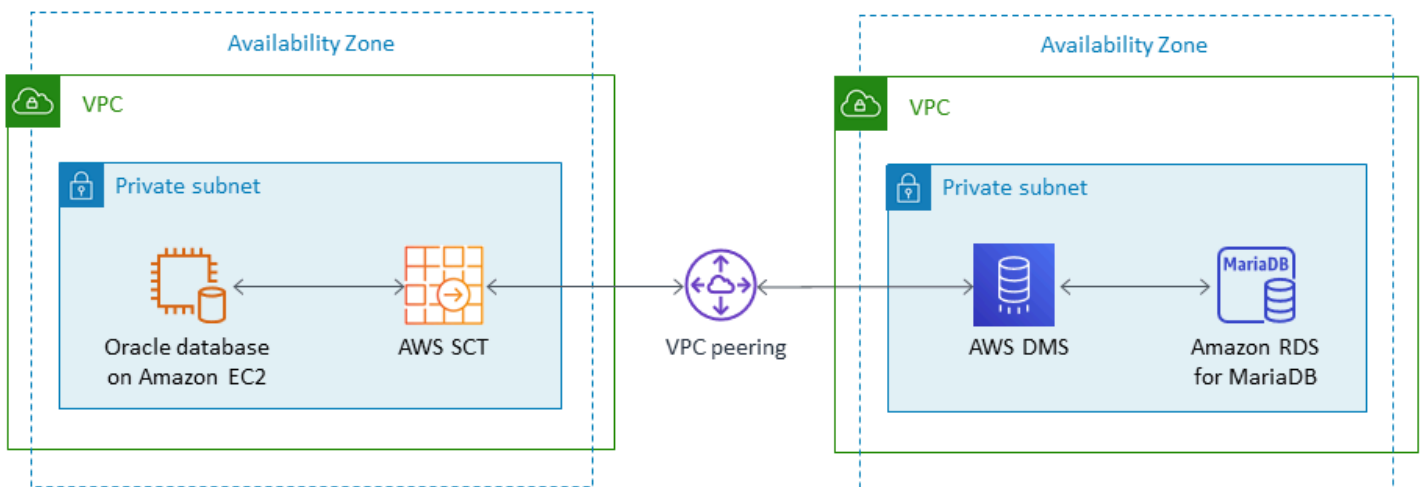

### Tools

- [AWS Schema Conversion Tool \(AWS SCT\)](#) makes heterogeneous database migrations predictable by automatically converting the source database schema and a majority of the database code objects—including views, stored procedures, and functions—to a format compatible with the



target database. After converting your database schema and code objects using AWS SCT, you can use AWS DMS to migrate data from the source database to the target database to complete your migration projects. For more information, see [Using Oracle as a Source for AWS SCT](#) in the AWS SCT documentation.

- [AWS Database Migration Service](#) (AWS DMS) helps you migrate databases to AWS quickly and securely. The source database remains fully operational during the migration, minimizing downtime to applications that rely on the database. AWS DMS can migrate your data to and from the most widely used commercial and open-source databases. AWS DMS supports homogeneous migrations such as Oracle to Oracle, as well as heterogeneous migrations between different database platforms, such as Oracle or Microsoft SQL Server to Amazon Aurora. To learn more about migrating Oracle databases, see [Using an Oracle Database as a Source for AWS DMS](#) in the AWS DMS documentation.

## Epics

### Plan for the migration

Task	Description	Skills required
Identify versions and database engines.	Identify the source and target database versions and engines.	DBA, Developer
Identify the replication instance.	Identify the AWS DMS replication instance.	DBA, Developer
Identify storage requirements.	Identify storage type and capacity.	DBA, Developer
Identify network requirements.	Identify network latency and bandwidth.	DBA, Developer
Identify hardware requirements.	Identify hardware requirements for the source and target server instances (based on the Oracle compatibility list and capacity requirements).	DBA, Developer

Task	Description	Skills required
Identify security requirements.	Identify network-access security requirements for the source and target databases.	DBA, Developer
Install drivers.	Install the latest AWS SCT and Oracle drivers.	DBA, Developer
Determine a backup strategy.		DBA, Developer
Determine availability requirements.		DBA, Developer
Choose an application migration/switchover strategy.		DBA, Developer
Select the instance type.	Select the proper instance type based on capacity, storage, and network features.	DBA, Developer

## Configure the environment

Task	Description	Skills required
Create a virtual private cloud (VPC).	The source, target, and replication instances should be in the same VPC and in the same Availability Zone (recommended).	Developer
Create security groups.	Create the necessary security groups for database access.	Developer
Generate a key pair.	Generate and configure a key pair.	Developer

Task	Description	Skills required
Configure other resources.	Configure subnets, Availability Zones, and CIDR blocks.	Developer

## Configure the source

Task	Description	Skills required
Launch the EC2 instance.	For instructions, see the <a href="#">Amazon EC2 documentation</a> .	Developer
Install the Oracle database.	Install the Oracle database on the EC2 instance, with required users and roles.	DBA
Follow the steps in the task description to access Oracle from outside of the EC2 instance.	<ol style="list-style-type: none"> <li>1. Change the local host in <code>tnsnames</code> to the Amazon EC2 public DNS.</li> <li>2. Change the local host in <code>listener</code> to the Amazon EC2 public DNS.</li> <li>3. Stop and restart the listener.</li> </ol>	DBA
Update the Amazon EC2 public DNS.	After the EC2 instance restarts, the public DNS changes. Make sure to update the Amazon EC2 public DNS in <code>tnsnames</code> and <code>listener</code> , or use an Elastic IP address.	DBA, Developer
Configure the EC2 instance security group.	Configure the EC2 instance security group so the replication instance and required	DBA, Developer

Task	Description	Skills required
	clients can access the source database.	

### Configure the target Amazon RDS for MariaDB environment

Task	Description	Skills required
Start the RDS DB instance.	Configure and start the Amazon RDS for MariaDB DB instance.	Developer
Create tablespaces.	Create any necessary tablespaces in the Amazon RDS MariaDB database.	DBA
Configure a security group.	Configure a security group so the replication instance and required clients can access the target database.	Developer

### Configure AWS SCT

Task	Description	Skills required
Install drivers.	Install the latest AWS SCT and Oracle drivers.	Developer
Connect.	Enter appropriate parameters and then connect to the source and target.	Developer
Generate a schema conversion report.	Generate an AWS SCT schema conversion report.	Developer

Task	Description	Skills required
Correct the code and schema as necessary.	Make any necessary corrections to the code and schema (especially tablespaces and quotation marks).	DBA, Developer
Validate the schema.	Validate the schema on the source versus the target before loading data.	Developer

### Migrate data using AWS DMS

Task	Description	Skills required
Set a connection attribute.	For full-load and change data capture (CDC) or just for CDC, set an extra connection attribute. For more information, see the <a href="#">Amazon RDS documentation</a> .	Developer
Enable supplemental logging.	Enable supplemental logging on the source database.	DBA, Developer
Enable archive log mode.	For full-load and CDC (or just for CDC), enable archive log mode on the source database.	DBA
Create and test endpoints.	Create source and target endpoints and test the connections. For more information, see the <a href="#">Amazon DMS documentation</a> .	Developer
Create a replication task.	When the endpoints are connected successfully, create	Developer

Task	Description	Skills required
	a replication task. For more information, see the <a href="#">Amazon DMS documentation</a> .	
Choose replication type.	Choose <b>CDC only</b> or <b>Full load plus CDC</b> in the task to capture changes for continuous replication only, or for full load and ongoing changes, respectively.	Developer
Start and monitor the task.	Start the replication task and monitor Amazon CloudWatch logs. For more information, see the <a href="#">Amazon DMS documentation</a> .	Developer
Validate the data.	Validate the data in the source and target databases.	Developer

## Migrate applications and cut over to the target database

Task	Description	Skills required
Follow the chosen application migration strategy.		DBA, App owner, Developer
Follow the chosen application cutover/switchover strategy.		DBA, App owner, Developer

## Close the project

Task	Description	Skills required
Validate the schema and data.	Ensure that the schema and data are validated successfully in the source versus the target before project closure.	DBA, Developer
Gather metrics.	Gather metrics for time to migrate, percentage of manual versus tool tasks, cost savings, and similar criteria.	DBA, App owner, Developer
Review documentation.	Review the project documents and artifacts.	DBA, App owner, Developer
Shut down resources.	Shut down temporary AWS resources.	DBA, Developer
Close the project.	Close the migration project and provide any feedback.	DBA, App owner, Developer

## Related resources

- [MariaDB Amazon RDS overview](#)
- [Amazon RDS for MariaDB product details](#)
- [Using an Oracle Database as a Source for AWS DMS](#)
- [Strategies for Migrating Oracle Databases to AWS](#)
- [Licensing Oracle Software in the Cloud Computing Environment](#)
- [Amazon RDS for Oracle FAQs](#)
- [AWS DMS overview](#)
- [AWS DMS blog posts](#)
- [Amazon EC2 overview](#)
- [Amazon EC2 FAQs](#)

- [AWS SCT documentation](#)



# Migrate an on-premises Oracle database to Amazon RDS for MySQL using AWS DMS and AWS SCT

Created by Sergey Dmitriev (AWS) and Naresh Damera (AWS)

<b>R Type:</b> Re-architect	<b>Source:</b> Databases: Relational	<b>Target:</b> Amazon RDS for MySQL
<b>Created by:</b> AWS	<b>Environment:</b> PoC or pilot	<b>Technologies:</b> Databases; Migration
<b>Workload:</b> Oracle	<b>AWS services:</b> Amazon RDS	

## Summary

This pattern walks you through the migration of an on-premises Oracle database to an Amazon Relational Database Service (Amazon RDS) for MySQL DB instance. It uses AWS Database Migration Service (AWS DMS) to migrate the data, and AWS Schema Conversion Tool (AWS SCT) to convert the source database schema and objects to a format that's compatible with Amazon RDS for MySQL.

## Prerequisites and limitations

### Prerequisites

- An active AWS account
- A source Oracle database in an on-premises data center

### Limitations

- Database size limit: 64 TB

### Product versions

- All Oracle database editions for versions 11g (versions 11.2.0.3.v1 and later) and up to 12.2, and 18c. For the latest list of supported versions, see [Using an Oracle Database as a Source for AWS DMS](#). We recommend that you use the latest version of AWS DMS for the most comprehensive

version and feature support. For information about Oracle database versions supported by AWS SCT, see the [AWS SCT documentation](#).

- AWS DMS currently supports MySQL versions 5.5, 5.6, and 5.7. For the latest list of supported versions, see [Using a MySQL-Compatible Database as a Target for AWS DMS](#) in the AWS documentation.

## Architecture

### Source technology stack

- On-premises Oracle database

### Target technology stack

- Amazon RDS for MySQL DB instance

### Data migration architecture

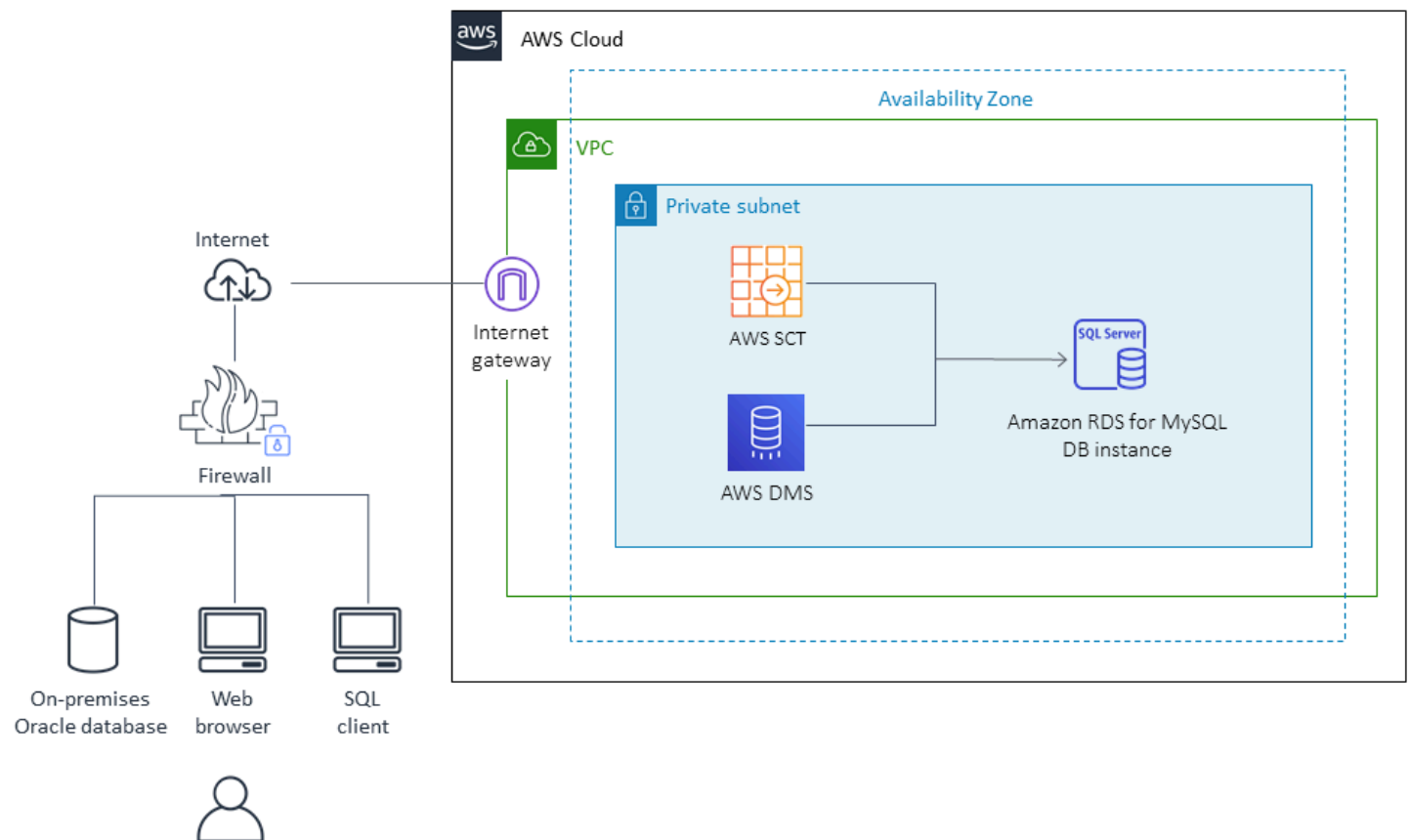

## Tools

- **AWS DMS** - [AWS Database Migration Services](#) (AWS DMS) helps you migrate relational databases, data warehouses, NoSQL databases, and other types of data stores. You can use AWS DMS to migrate your data into the AWS Cloud, between on-premises instances (through an AWS Cloud setup), or between combinations of cloud and on-premises setups.
- **AWS SCT** - [AWS Schema Conversion Tool](#) (AWS SCT) is used to convert your database schema from one database engine to another. The custom code that the tool converts includes views, stored procedures, and functions. Any code that the tool cannot convert automatically is clearly marked so that you can convert it yourself.

## Epics

### Plan the migration

Task	Description	Skills required
Validate the source and target database version and engine.		DBA
Identify the hardware requirements for the target server instance.		DBA, SysAdmin
Identify the storage requirements (storage type and capacity).		DBA, SysAdmin
Choose the proper instance type based on capacity, storage features, and network features.		DBA, SysAdmin
Identify the network access security requirements for the source and target databases.		DBA, SysAdmin

Task	Description	Skills required
Identify the application migration strategy.		DBA, SysAdmin, App owner

## Configure the infrastructure

Task	Description	Skills required
Create a virtual private cloud (VPC) and subnets.		SysAdmin
Create the security groups and network access control lists (ACLs).		SysAdmin
Configure and start an Amazon RDS DB instance.		DBA, SysAdmin

## Migrate data

Task	Description	Skills required
Migrate the database schema by using AWS SCT.		DBA
Migrate data by using AWS DMS.		DBA

## Migrate the application

Task	Description	Skills required
Use AWS SCT to analyze and convert the SQL code inside the application code.	For more information, see <a href="https://docs.aws.amazon.com/SchemaConversionTool/">https://docs.aws.amazon.com/SchemaConversionTool/</a>	App owner

Task	Description	Skills required
	latest/userguide/CHAP_Converting.App.html.	
Follow the application migration strategy.		DBA, SysAdmin, App owner

## Cut over

Task	Description	Skills required
Switch the application clients over to the new infrastructure.		DBA, SysAdmin, App owner

## Close the project

Task	Description	Skills required
Shut down the temporary AWS resources.		DBA, SysAdmin
Review and validate the project documents.		DBA, SysAdmin
Gather metrics around time to migrate, % of manual vs. tool, cost savings, etc.		DBA, SysAdmin
Close out the project and provide feedback.		

## Related resources

## References

- [AWS DMS documentation](#)
- [AWS SCT documentation](#)
- [Amazon RDS Pricing](#)

### **Tutorial and videos**

- [Getting Started with AWS DMS](#)
- [Getting Started with Amazon RDS](#)
- [AWS DMS \(video\)](#)
- [Amazon RDS \(video\)](#)

# Migrate an on-premises Oracle database to Amazon RDS for PostgreSQL by using an Oracle bystander and AWS DMS

Created by Cady Motyka (AWS)

<b>Environment:</b> PoC or pilot	<b>Source:</b> Databases: Relational	<b>Target:</b> Amazon RDS for PostgreSQL/Amazon Aurora PostgreSQL
<b>R Type:</b> Re-architect	<b>Workload:</b> Oracle	<b>Technologies:</b> Migration; Databases
<b>AWS services:</b> Amazon RDS		

## Summary

This pattern describes how you can migrate an on-premises Oracle database to either of the following PostgreSQL-compatible AWS database services with minimal downtime:

- Amazon Relational Database Service (Amazon RDS) for PostgreSQL
- Amazon Aurora PostgreSQL-Compatible Edition

The solution uses AWS Database Migration Service (AWS DMS) to migrate the data, AWS Schema Conversion Tool (AWS SCT) to convert the database schema, and an Oracle bystander database to help manage the migration. In this implementation, the downtime is restricted to however long it takes to create or validate all of the foreign keys on the database.

The solution also uses Amazon Elastic Compute Cloud (Amazon EC2) instances with an Oracle bystander database to help control the stream of data through AWS DMS. You can temporarily pause streaming replication from the on-premises Oracle database to the Oracle bystander to activate AWS DMS to catch up on data validation, or to use another data validation tool. The Amazon RDS for PostgreSQL DB instance or Aurora PostgreSQL-Compatible DB instance and the bystander database will have the same data when AWS DMS finishes migrating current changes.

## Prerequisites and limitations

### Prerequisites

- An active AWS account
- A source Oracle database in an on-premises data center with an Active Data Guard standby database configured
- AWS Direct Connect configured between the on-premises data center and AWS Secrets Manager for storing the database secrets
- Java Database Connectivity (JDBC) drivers for AWS SCT connectors, installed either on a local machine or on the EC2 instance where AWS SCT is installed
- Familiarity with [using an Oracle database as a source for AWS DMS](#)
- Familiarity with [using a PostgreSQL database as a target for AWS DMS](#)

## Limitations

- Database size limit: 64 TB

## Product versions

- AWS DMS supports all Oracle database editions for versions 10.2 and later (for versions 10.x), 11g and up to 12.2, 18c, and 19c. For the latest list of supported versions, see [Using an Oracle Database as a Source for AWS DMS](#). We recommend that you use the latest version of AWS DMS for the most comprehensive version and feature support. For information about Oracle database versions supported by AWS SCT, see the [AWS SCT documentation](#).
- AWS DMS supports PostgreSQL versions 9.4 and later (for versions 9.x), 10.x, 11.x, 12.x, and 13.x. For the latest information, see [Using a PostgreSQL Database as a Target for AWS DMS](#) in the AWS documentation.

## Architecture

### Source technology stack

- An on-premises Oracle database
- An EC2 instance that holds a bystander for the Oracle database

### Target technology stack

- Amazon RDS for PostgreSQL or Aurora PostgreSQL instance, PostgreSQL 9.3 and later



## Target architecture

The following diagram shows an example workflow for migrating an Oracle database to a PostgreSQL-compatible AWS database by using AWS DMS and an Oracle bystander:

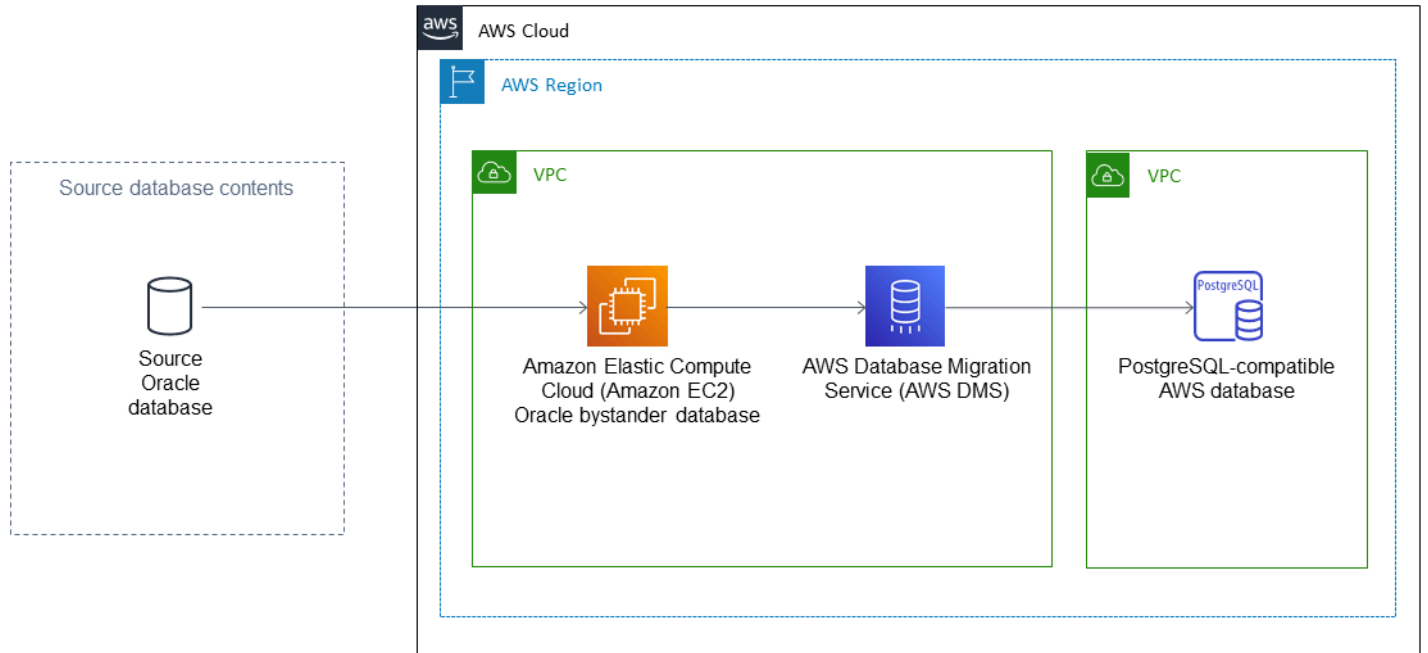

## Tools

- [AWS Database Migration Service \(AWS DMS\)](#) helps you migrate data stores into the AWS Cloud or between combinations of cloud and on-premises setups.
- [AWS Schema Conversion Tool \(AWS SCT\)](#) supports heterogeneous database migrations by automatically converting the source database schema and a majority of the custom code to a format that's compatible with the target database.
- [Amazon Relational Database Service \(Amazon RDS\)](#) helps you set up, operate, and scale a relational database in the AWS Cloud.

## Epics

### Convert the Oracle database schema to PostgreSQL

Task	Description	Skills required
Set up AWS SCT.	<p>Create a new report, and connect to Oracle as the source and PostgreSQL as the target. In <b>Project Settings</b>, go to the <b>SQL Scripting</b> tab. Change the <b>Target SQL Script</b> to <b>Multiple Files</b>. These files will be used later and named the following:</p> <ul style="list-style-type: none"><li>• create_database.sql</li><li>• create_sequence.sql</li><li>• create_table.sql</li><li>• create_view.sql</li><li>• create_function.sql</li></ul>	DBA
Convert the Oracle database schema.	<p>In the <b>Action</b> tab, choose <b>Generate Report</b>. Then, choose <b>Convert Schema</b> and choose <b>Save as SQL</b>.</p>	DBA
Modify the scripts.	<p>For example, you might want to modify the script if a number in the source schema has been converted to numeric format in PostgreSQL, but you want to use <b>BIGINT</b> instead for better performance.</p>	DBA

## Create and configure the Amazon RDS DB instance

Task	Description	Skills required
Create the Amazon RDS DB instance.	In the correct AWS Region, create a new PostgreSQL DB instance. For more information, see <a href="#">Creating a PostgreSQL DB instance and connecting to a database on a PostgreSQL DB instance</a> in the Amazon RDS documentation.	AWS SysAdmin, DBA
Configure DB instance specifications.	Specify the DB engine version, DB instance class, Multi-AZ deployment, storage type, and allocated storage. Enter the DB instance identifier, a primary user name, and a primary password.	AWS SysAdmin, DBA
Configure network and security.	Specify the virtual private cloud (VPC), subnet group, public accessibility, Availability Zone preference, and security groups.	DBA, SysAdmin
Configure database options.	Specify the database name, port, parameter group, encryption, and KMS key.	AWS SysAdmin, DBA
Configure backups.	Specify the backup retention period, backup window, start time, duration, and whether to copy tags to snapshots.	AWS SysAdmin, DBA

Task	Description	Skills required
Configure monitoring options.	Activate or deactivate enhanced monitoring and performance insights.	AWS SysAdmin, DBA
Configure maintenance options.	Specify auto minor version upgrade, maintenance window, and start day, time, and duration.	AWS SysAdmin, DBA
Run the pre-migration scripts from AWS SCT.	On the Amazon RDS instance, run the following scripts generated by AWS SCT: <ul style="list-style-type: none"> <li>• create_database.sql</li> <li>• create_sequence.sql</li> <li>• create_table.sql</li> <li>• create_view.sql</li> <li>• create_function.sql</li> </ul>	AWS SysAdmin, DBA

## Configure the Oracle bystander in Amazon EC2

Task	Description	Skills required
Set up the network for Amazon EC2.	Create the new VPC, subnets, internet gateway, route tables, and security groups.	AWS SysAdmin
Create the EC2 instance.	In the appropriate AWS Region, create a new EC2 instance. Select the Amazon Machine Image (AMI), choose the instance size, and configure instance details: number of instances (1),	AWS SysAdmin

Task	Description	Skills required
	the VPC and subnet you created in the previous task, auto-assign public IP, and other options. Add storage, configure security groups, and launch. When prompted, create and save a key pair for the next step.	
Connect the Oracle source database to the EC2 instance.	Copy the IPv4 public IP address and DNS to a text file and connect by using SSH as follows: <b>ssh -i "your_file.pem" ec2-user@&lt;your-IP-address-or-public-DNS&gt;</b> .	AWS SysAdmin
Set up the initial host for a bystander in Amazon EC2.	Set up SSH keys, bash profile, ORATAB, and symbolic links. Create Oracle directories.	AWS SysAdmin, Linux Admin
Set up the database copy for a bystander in Amazon EC2	Use RMAN to create a database copy, enable supplemental logging, and create the standby control file. After copying is complete, place the database in recovery mode.	AWS SysAdmin, DBA

Task	Description	Skills required
Set up Oracle Data Guard.	Modify your <b>listener.ora</b> file and start the listener. Set up a new archive destination. Place the bystander in recovery mode, replace temporary files to avoid future corruption, install a crontab if necessary to prevent the archive directory from running out of space, and edit the <b>manage-trclog-files-oracle.cfg</b> file for the source and standby.	AWS SysAdmin, DBA
Prep the Oracle database to sync shipping.	Add the standby log files and change the recovery mode. Change the log shipping to <b>SYNC AFFIRM</b> on both the source primary and the source standby. Switch logs on primary, confirm via the Amazon EC2 bystander alert log that you are using the standby log files, and confirm that the redo stream is flowing in SYNC.	AWS SysAdmin, DBA

## Migrate data with AWS DMS

Task	Description	Skills required
Create a replication instance in AWS DMS.	Complete the fields for the name, instance class, VPC (same as the Amazon	AWS SysAdmin, DBA

Task	Description	Skills required
	<p>EC2 instance), Multi-AZ, and public accessibility. Under <b>Advance</b>, specify allocated storage, subnet group, Availability Zone, VPC security groups, and AWS Key Management Service (AWS KMS) key.</p>	
<p>Create the source database endpoint.</p>	<p>Specify the endpoint name, type, source engine (Oracle), server name (Amazon EC2 private DNS name), port, SSL mode, user name, password, SID, VPC (specify the VPC that has the replication instance) , and replication instance. To test the connection, choose <b>Run Test</b>, and then create the endpoint. You can also configure the following advanced settings: <b>maxFileSize</b> and <b>numberDataTypeScale</b>.</p>	<p>AWS SysAdmin, DBA</p>
<p>Connect AWS DMS to Amazon RDS for PostgreSQL.</p>	<p>Create a migration security group for connections across VPCs.</p>	<p>AWS SysAdmin, DBA</p>

Task	Description	Skills required
Create the target database endpoint.	Specify the endpoint name, type, source engine (PostgreSQL), server name (Amazon RDS endpoint), port, SSL mode, user name, password, database name, VPC (specify the VPC that has the replication instance), and replication instance. To test the connection, choose <b>Run Test</b> , and then create the endpoint. You can also configure the following advanced settings: <b>maxFileSize</b> and <b>numberDataTypes</b> .	AWS SysAdmin, DBA
Create the AWS DMS replication task.	Specify the task name, replication instance, source and target endpoints, and replication instance. For migration type, choose <b>Migrate existing data and replicate ongoing changes</b> . Clear the <b>Start task on create</b> checkbox.	AWS SysAdmin, DBA
Configure the AWS DMS replication task settings.	For target table preparation mode, choose <b>Do nothing</b> . Stop task after full load completes (to create primary keys). Specify limited or full LOB mode, and activate control tables. Optionally, you can configure the <b>CommitRate</b> advance setting.	DBA



Task	Description	Skills required
Configure table mappings.	In the <b>Table mappings</b> section, create an <b>Include</b> rule for all tables in all schemas included in the migration, and then create an <b>Exclude</b> rule. Add three transformation rules to convert the schema, table, and column names to lowercase, and add any other rules needed for this specific migration.	DBA
Start the task.	Start the replication task. Make sure that the full load is running. Run <b>ALTER SYSTEM SWITCH LOGFILE</b> on the primary Oracle database to kick-start the task.	DBA
Run the mid-migration scripts from AWS SCT.	In Amazon RDS for PostgreSQL, run the following scripts generated by AWS SCT: <ul style="list-style-type: none"><li>• create_index.sql</li><li>• create_constraint.sql</li></ul>	DBA
Restart the task to continue change data capture (CDC).	Run <b>VACUUM</b> on the Amazon RDS for PostgreSQL DB instance, and restart the AWS DMS task to apply cached CDC changes.	DBA

## Cut over to the PostgreSQL database

Task	Description	Skills required
Review the AWS DMS logs and validation tables for any errors.	Check and fix any replication or validation errors.	DBA
Stop all Oracle dependencies.	Stop all Oracle dependencies, shut down listeners on the Oracle database, and run <b>ALTER SYSTEM SWITCH LOGFILE</b> . Stop the AWS DMS task when it shows no activity.	DBA
Run the post-migration scripts from AWS SCT.	In Amazon RDS for PostgreSQL, run the following scripts generated by AWS SCT: <ul style="list-style-type: none"> <li>• create_foreign_key_constraint.sql</li> <li>• create_triggers.sql</li> </ul>	DBA
Complete additional Amazon RDS for PostgreSQL steps.	Increment sequences to match Oracle if needed, run <b>VACUUM</b> and <b>ANALYZE</b> , and take a snapshot for compliance.	DBA
Open the connections to Amazon RDS for PostgreSQL.	Remove the AWS DMS security groups from Amazon RDS for PostgreSQL, add production security groups, and point your applications to the new database.	DBA

Task	Description	Skills required
Clean up AWS DMS objects.	Remove the endpoints, replication tasks, replication instances, and the EC2 instance.	SysAdmin, DBA

## Related resources

- [AWS DMS documentation](#)
- [AWS SCT documentation](#)
- [Amazon RDS for PostgreSQL pricing](#)

# Migrate from Oracle Database to Amazon RDS for PostgreSQL by using Oracle GoldenGate

Created by Dhairya Jindani (AWS), Rajeshkumar Sabankar (AWS), and Sindhusha Paturu (AWS)

<b>Environment:</b> PoC or pilot	<b>Source:</b> Databases: Relational	<b>Target:</b> Amazon RDS for PostgreSQL
<b>R Type:</b> Re-architect	<b>Workload:</b> Oracle	<b>Technologies:</b> Migration; Databases
<b>AWS services:</b> Amazon RDS		

## Summary

This pattern shows how to migrate an Oracle database to Amazon Relational Database Service (Amazon RDS) for PostgreSQL by using Oracle Cloud Infrastructure (OCI) GoldenGate.

By using Oracle GoldenGate, you can replicate data between your source database and one or more destination databases with minimal downtime.

**Note:** The source Oracle database can be either on-premises or on an Amazon Elastic Compute Cloud (Amazon EC2) instance. You can use a similar procedure when using on-premises replication tools.

## Prerequisites and limitations

### Prerequisites

- An active AWS account
- An Oracle GoldenGate license
- Java Database Connectivity (JDBC) driver to connect to the PostgreSQL database
- Schema and tables created with the [AWS Schema Conversion Tool \(AWS SCT\)](#) on the target Amazon RDS for PostgreSQL database

### Limitations

- Oracle GoldenGate can replicate existing table data (initial load) and ongoing changes (change data capture) only

## Product versions

- Oracle Database Enterprise Edition 10g or newer versions
- Oracle GoldenGate 12.2.0.1.1 for Oracle or newer versions
- Oracle GoldenGate 12.2.0.1.1 for PostgreSQL or newer versions

## Architecture

The following diagram shows an example workflow for migrating an Oracle database to Amazon RDS for PostgreSQL by using Oracle GoldenGate:

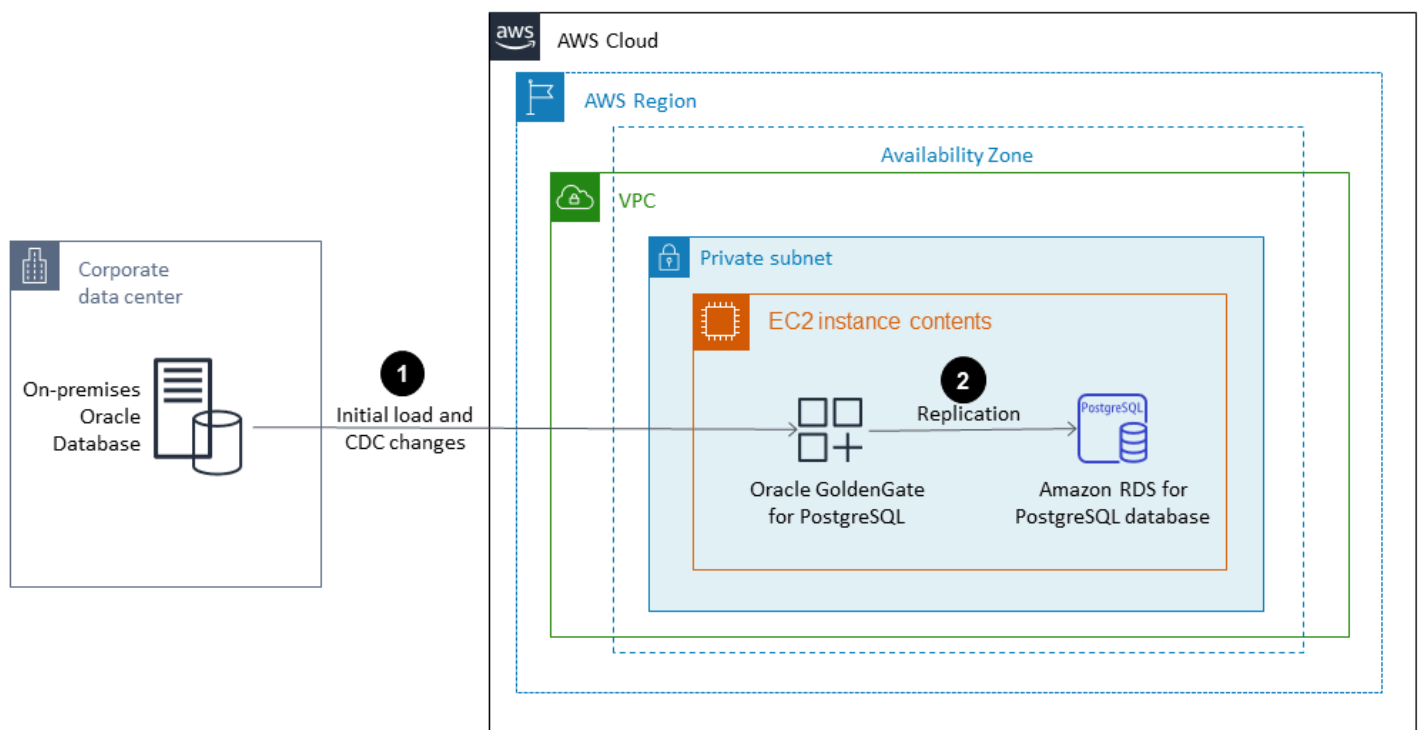

The diagram shows the following workflow:

1. The Oracle GoldenGate [Extract process](#) runs against the source database to extract data.
2. The Oracle GoldenGate [Replicat process](#) delivers the extracted data to the target Amazon RDS for PostgreSQL database.

## Tools

- [Oracle GoldenGate](#) helps you design, run, orchestrate, and monitor your data replication and stream data processing solutions in the Oracle Cloud Infrastructure.
- [Amazon Relational Database Service \(Amazon RDS\) for PostgreSQL](#) helps you set up, operate, and scale a PostgreSQL relational database in the AWS Cloud.

## Epics

### Download and install Oracle GoldenGate

Task	Description	Skills required
Download Oracle GoldenGate.	<p>Download the following versions of Oracle GoldenGate:</p> <ul style="list-style-type: none"> <li>• Oracle GoldenGate 12.2.0.1.1 for Oracle or a newer version</li> <li>• Oracle GoldenGate 12.2.0.1.1 for PostgreSQL or a newer version</li> </ul> <p>To download the software, see <a href="#">Oracle GoldenGate Downloads</a> on the Oracle website.</p>	DBA
Install Oracle GoldenGate for Oracle on the source Oracle Database server.	For instructions, see the <a href="#">Oracle GoldenGate documentation</a> .	DBA
Install Oracle GoldenGate for PostgreSQL database on the Amazon EC2 instance.	For instructions, see the <a href="#">Oracle GoldenGate documentation</a> .	DBA

## Configure Oracle GoldenGate on the source and target databases

Task	Description	Skills required
Set up Oracle GoldenGate for Oracle Database on the source database.	<p>For instructions, see the <a href="#">Oracle GoldenGate documentation</a>.</p> <p>Make sure that you configure the following:</p> <ul style="list-style-type: none"><li>• Supplemental logging</li><li>• Oracle GoldenGate users</li><li>• Any required grants and permissions</li><li>• Parameter files</li><li>• Manager process</li><li>• Directory</li><li>• <b>GLOBALS</b> files</li><li>• Oracle Wallet</li></ul>	DBA
Set up Oracle GoldenGate for PostgreSQL on the target database.	<p>For instructions, see <a href="#">Part VI Using Oracle GoldenGate for PostgreSQL</a> on the Oracle website.</p> <p>Make sure that you configure the following:</p> <ul style="list-style-type: none"><li>• Manager process</li><li>• <b>GLOBALS</b> files</li><li>• Oracle Wallet</li></ul>	DBA

## Configure the data capture

Task	Description	Skills required
Set up the Extract process in the source database.	<p>In the source Oracle Database, create an extract file to extract data.</p> <p>For instructions, see <a href="#">ADD EXTRACT</a> in the Oracle documentation.</p> <p><b>Note:</b> The extract file includes the creation of the extract parameter file and trail file directory.</p>	DBA
Set up a data pump to transfer the trail file from the source to the target database.	<p>Create an EXTRACT parameter file and trail file directory by following the instructions in <a href="#">PARFILE</a> in <i>Database Utilities</i> on the Oracle website.</p> <p>For more information, see <a href="#">What is a Trail?</a> in <i>Fusion Middleware Understanding Oracle GoldenGate</i> on the Oracle website.</p>	DBA
Set up replication on the Amazon EC2 instance.	<p>Create a replication parameter file and trail file directory.</p> <p>For more information about creating replication parameter files, see section <a href="#">3.5 Validating a parameter</a></p>	DBA



Task	Description	Skills required
	<p><a href="#">file</a> in the Oracle Database documentation.</p> <p>For more information about creating a trail file directory , see <a href="#">Creating a trail</a> in the Oracle Cloud documentation.</p> <p><b>Important:</b> Make sure that you add a checkpoint table entry in the GLOBALS file at the target.</p> <p>For more information, see <a href="#">What is a Replicat?</a> in <i>Fusion Middleware Understanding Oracle GoldenGate</i> on the Oracle website.</p>	

## Configure the data replication

Task	Description	Skills required
<p>In the source database, create a parameter file to extract data for the initial load.</p>	<p>Follow the instructions in <a href="#">Creating a parameter file in GGSCI</a> in the Oracle Cloud documentation.</p> <p><b>Important:</b> Make sure that the Manager is running on the target.</p>	<p>DBA</p>
<p>In the target database, create a parameter file to replicate data for the initial load.</p>	<p>Follow the instructions in <a href="#">Creating a parameter file in GGSCI</a> in the Oracle Cloud documentation.</p>	<p>DBA</p>

Task	Description	Skills required
	<b>Important:</b> Make sure that you add and start the Replicat process.	

## Cut over to the Amazon RDS for PostgreSQL database

Task	Description	Skills required
Stop the Replicat process and make sure that the source and target databases are in sync.	Compare row counts between the source and target databases to make sure that the data replication was successful.	DBA
Configure data definition language (DDL) support.	Run the DDL script for creating triggers, sequence, synonyms, and referential keys on PostgreSQL.  <b>Note:</b> You can use any standard SQL client application to connect to a database in your DB cluster. For example, you can use <a href="#">pgAdmin</a> to connect to your DB instance.	DBA

## Related resources

- [Amazon RDS for PostgreSQL](#) (*Amazon RDS User Guide*)
- [Amazon EC2 documentation](#)
- [Oracle GoldenGate supported processing methods and databases](#) (Oracle documentation)

# Migrate an Oracle Database to Amazon Redshift using AWS DMS and AWS SCT

*Created by Piyush Goyal (AWS) and Brian motzer (AWS)*

<b>Source:</b> Oracle	<b>Target:</b> Redshift	<b>R Type:</b> Re-architect
<b>Environment:</b> Production	<b>Technologies:</b> Migration; Analytics; Databases	<b>Workload:</b> Oracle
<b>AWS services:</b> Amazon Redshift; AWS DMS		

## Summary

This pattern provides guidance for migrating Oracle databases to an Amazon Redshift cloud data warehouse in the Amazon Web Services (AWS) Cloud by using AWS Database Migration Service (AWS DMS) and AWS Schema Conversion Tool (AWS SCT). The pattern covers source Oracle databases that are on premises or installed on an Amazon Elastic Compute Cloud (Amazon EC2) instance. It also covers Amazon Relational Database Service (Amazon RDS) for Oracle databases.

## Prerequisites and limitations

### Prerequisites

- An Oracle database that is running in an on-premises data center or in the AWS Cloud
- An active AWS account
- Familiarity with [using an Oracle database as a source for AWS DMS](#)
- Familiarity with [using an Amazon Redshift database as a target for AWS DMS](#)
- Knowledge of Amazon RDS, Amazon Redshift, the applicable database technologies, and SQL
- Java Database Connectivity (JDBC) drivers for AWS SCT connectors, where AWS SCT is installed

### Product versions

- For self-managed Oracle databases, AWS DMS supports all Oracle database editions for versions 10.2 and later (for versions 10.x), 11g and up to 12.2, 18c, and 19c. For Amazon RDS for Oracle

databases that AWS manages, AWS DMS supports all Oracle database editions for versions 11g (versions 11.2.0.4 and later) and up to 12.2, 18c, and 19c. We recommend that you use the latest version of AWS DMS for the most comprehensive version and feature support.

## Architecture

### Source technology stack

One of the following:

- An on-premises Oracle database
- An Oracle database on an EC2 instance
- An Amazon RDS for Oracle DB instance

### Target technology stack

- Amazon Redshift

### Target architecture

*From an Oracle database running in the AWS Cloud to Amazon Redshift:*

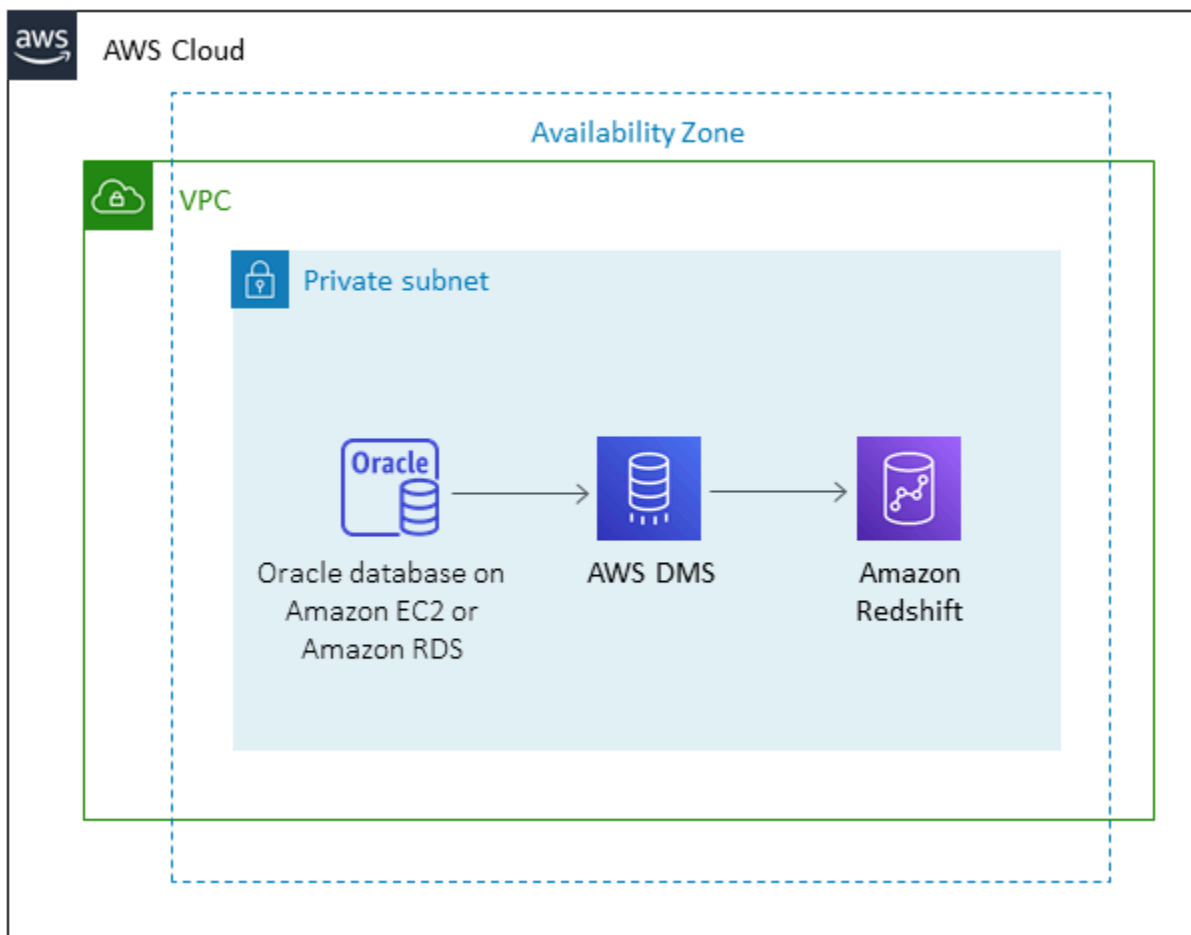

*From an Oracle database running in an on-premises data center to Amazon Redshift:*

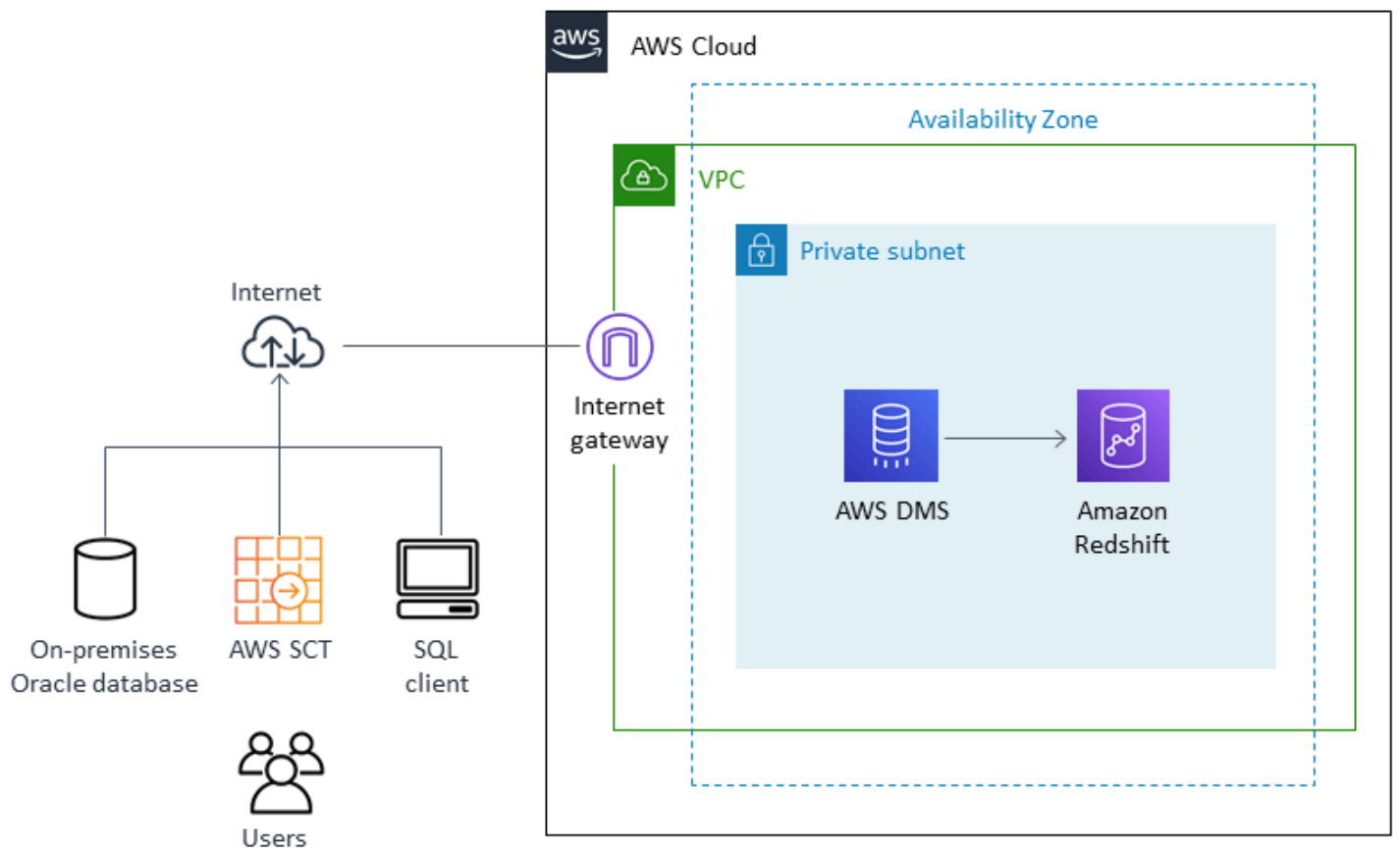

## Tools

- [AWS DMS](#) - AWS Data Migration Service (AWS DMS) helps you migrate databases to AWS quickly and securely. The source database remains fully operational during the migration, minimizing downtime to applications that rely on the database. AWS DMS can migrate your data to and from most widely used commercial and open-source databases.
- [AWS SCT](#) - AWS Schema Conversion Tool (AWS SCT) can be used to convert your existing database schema from one database engine to another. It supports various database engines, including Oracle, SQL Server, and PostgreSQL, as sources.

## Epics

### Prepare for the migration

Task	Description	Skills required
Validate the database versions.	Validate the source and target database versions and make sure they are supported by AWS DMS. For information about supported Oracle Database versions, see <a href="#">Using an Oracle database as a source for AWS DMS</a> . For information about using Amazon Redshift as a target, see <a href="#">Using an Amazon Redshift database as a target for AWS DMS</a> .	DBA
Create a VPC and security group.	In your AWS account, create a virtual private cloud (VPC), if it doesn't exist. Create a security group for outbound traffic to source and target databases. For more information, see the <a href="#">Amazon Virtual Private Cloud (Amazon VPC) documentation</a> .	Systems administrator
Install AWS SCT.	Download and install the latest version of AWS SCT and its corresponding drivers. For more information, see <a href="#">Installing, verifying, and updating the AWS SCT</a> .	DBA

Task	Description	Skills required
Create a user for the AWS DMS task.	Create an AWS DMS user in the source database and grant it READ privileges. This user will be used by both AWS SCT and AWS DMS.	DBA
Test the DB connectivity.	Test the connectivity to the Oracle DB instance.	DBA
Create a new project in AWS SCT.	Open the AWS SCT tool and create a new project.	DBA
Analyze the Oracle schema to be migrated.	Use AWS SCT to analyze the schema to be migrated, and generate a database migration assessment report. For more information, see <a href="#">Creating a database migration assessment report</a> in the AWS SCT documentation.	DBA
Review the assessment report.	Review the report for migration feasibility. Some DB objects might require manual conversion. For more information about the report, see <a href="#">Viewing the assessment report</a> in the AWS SCT documentation.	DBA



## Prepare the target database

Task	Description	Skills required
Create an Amazon Redshift cluster.	Create an Amazon Redshift cluster within the VPC that you created previously. For more information, see <a href="#">Amazon Redshift clusters</a> in the Amazon Redshift documentation.	DBA
Create database users.	Extract the list of users, roles, and grants from the Oracle source database. Create users in the target Amazon Redshift database and apply the roles from the previous step.	DBA
Evaluate database parameters.	Review the database options, parameters, network files, and database links from the Oracle source database, and evaluate their applicability to the target.	DBA
Apply any relevant settings to the target.	For more information about this step, see <a href="#">Configuration reference</a> in the Amazon Redshift documentation.	DBA

## Create objects in the target database

Task	Description	Skills required
Create an AWS DMS user in the target database.	Create an AWS DMS user in the target database and grant	DBA

Task	Description	Skills required
	it read and write privileges. Validate the connectivity from AWS SCT.	
Convert the schema, review the SQL report, and save any errors or warnings.	For more information, see <a href="#">Converting database schemas using the AWS SCT</a> in the AWS SCT documentation.	DBA
Apply the schema changes to the target database or save them as a .sql file.	For instructions, see <a href="#">Saving and applying your converted schema in the AWS SCT</a> in the AWS SCT documentation.	DBA
Validate the objects in the target database.	Validate the objects that were created in the previous step in the target database. Rewrite or redesign any objects that weren't successfully converted.	DBA
Disable foreign keys and triggers.	Disable any foreign key and triggers. These can cause data loading issues during the full load process when running AWS DMS.	DBA

## Migrate data using AWS DMS

Task	Description	Skills required
Create an AWS DMS replication instance.	Sign in to the AWS Management Console, and open the AWS DMS console. In the navigation pane,	DBA

Task	Description	Skills required
	choose <b>Replication instances</b> , <b>Create replication instance</b> . For detailed instructions, see <a href="#">step 1</a> in <i>Getting started with AWS DMS</i> in the AWS DMS documentation.	
Create source and target endpoints.	Create source and target endpoints, Test the connection from the replication instance to both source and target endpoints. For detailed instructions, see <a href="#">step 2</a> in <i>Getting started with AWS DMS</i> in the AWS DMS documentation.	DBA
Create a replication task.	Create a replication task and select the appropriate migration method. For detailed instructions, see <a href="#">step 3</a> in <i>Getting started with AWS DMS</i> in the AWS DMS documentation.	DBA
Start the data replication.	Start the replication task and monitor the logs for any errors.	DBA

## Migrate your application

Task	Description	Skills required
Create application servers.	Create the new application servers on AWS.	Application owner

Task	Description	Skills required
Migrate the application code.	Migrate the application code to the new servers.	Application owner
Configure the application server.	Configure the application server for the target database and drivers.	Application owner
Optimize the application code.	Optimize the application code for the target engine.	Application owner

### Cut over to the target database

Task	Description	Skills required
Validate users.	In the target Amazon Redshift database, validate users and grant them roles and privileges.	DBA
Validate that the application is locked.	Make sure that the application is locked, to prevent further changes.	Application owner
Validate the data.	Validate the data in the target Amazon Redshift database.	DBA
Enable foreign keys and triggers.	Enable foreign keys and triggers in the target Amazon Redshift database.	DBA
Connect to the new database.	Configure the application to connect to the new Amazon Redshift database.	Application owner

Task	Description	Skills required
Perform final checks.	Perform a final, comprehensive system check before going live.	DBA, Application owner
Go live.	Go live with the target Amazon Redshift database.	DBA

## Close the migration project

Task	Description	Skills required
Shut down temporary AWS resources.	Shut down temporary AWS resources such as the AWS DMS replication instance and the EC2 instance used for AWS SCT.	DBA, Systems administrator
Review documents.	Review and validate the migration project documents.	DBA, Systems administrator
Gather metrics.	Collect information about the migration project, such as the time to migrate, the percentage of manual versus tool tasks, and total cost savings.	DBA, Systems administrator
Close out the project.	Close out the project and provide feedback.	DBA, Systems administrator

## Related resources

## References

- [AWS DMS user guide](#)
- [AWS SCT user guide](#)
- [Amazon Redshift getting started guide](#)

### **Tutorials and videos**

- [Dive Deep into AWS SCT and AWS DMS](#) (presentation from AWS re:Invent 2019)
- [Getting Started with AWS Database Migration Service](#)

# Migrate an Oracle database to Aurora PostgreSQL using AWS DMS and AWS SCT

Created by Senthil Ramasamy (AWS)

<b>Environment:</b> PoC or pilot	<b>Source:</b> Oracle Database	<b>Target:</b> Amazon Aurora PostgreSQL-Compatible
<b>R Type:</b> Re-architect	<b>Workload:</b> Oracle	<b>Technologies:</b> Migration; Databases
<b>AWS services:</b> Amazon Aurora		

## Summary

This pattern describes how to migrate an Oracle database to Amazon Aurora PostgreSQL-Compatible Edition by using AWS Data Migration Service (AWS DMS) and AWS Schema Conversion Tool (AWS SCT).

The pattern covers source Oracle databases that are on premises, Oracle databases that are installed on Amazon Elastic Compute Cloud (Amazon EC2) instances, and Amazon Relational Database Service (Amazon RDS) for Oracle databases. The pattern converts these databases to Aurora PostgreSQL-Compatible.

## Prerequisites and limitations

### Prerequisites

- An active AWS account.
- An Oracle database in an on-premises data center or in the AWS Cloud.
- SQL clients installed either on a local machine or on an EC2 instance.
- Java Database Connectivity (JDBC) drivers for AWS SCT connectors, installed on either a local machine or an EC2 instance where AWS SCT is installed.

### Limitations

- Database size limit: 128 TB
- If the source database supports a commercial off-the-shelf (COTS) application or is vendor-specific, you might not be able to convert it to another database engine. Before using this pattern, confirm that the application supports Aurora PostgreSQL-Compatible.

## Product versions

- For self-managed Oracle databases, AWS DMS supports all Oracle database editions for versions 10.2 and later (for versions 10.x), 11g, and up to 12.2, 18c, and 19c. For the latest list of supported Oracle database versions (both self-managed and Amazon RDS for Oracle), see [Using an Oracle database as a source for AWS DMS](#) and [Using a PostgreSQL database as a target for AWS DMS](#).
- We recommend that you use the latest version of AWS DMS for the most comprehensive version and feature support. For information about Oracle database versions supported by AWS SCT, see the [AWS SCT documentation](#).
- Aurora supports the PostgreSQL versions listed in [Amazon Aurora PostgreSQL releases and engine versions](#).

## Architecture

### Source technology stack

One of the following:

- An on-premises Oracle database
- An Oracle database on an EC2 instance
- An Amazon RDS for Oracle DB instance

### Target technology stack

- Aurora PostgreSQL-Compatible

### Target architecture



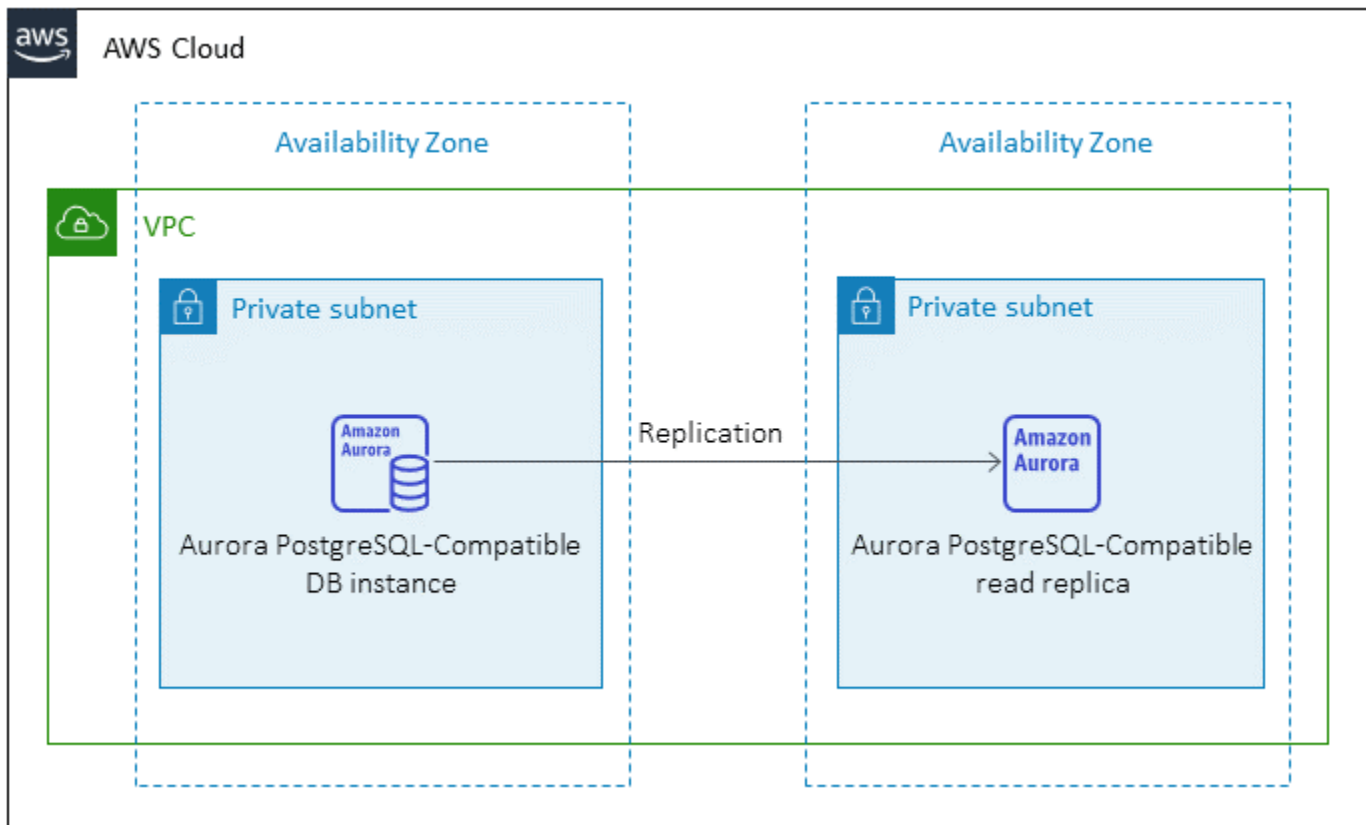

## Data migration architecture

- From an Oracle database running in the AWS Cloud

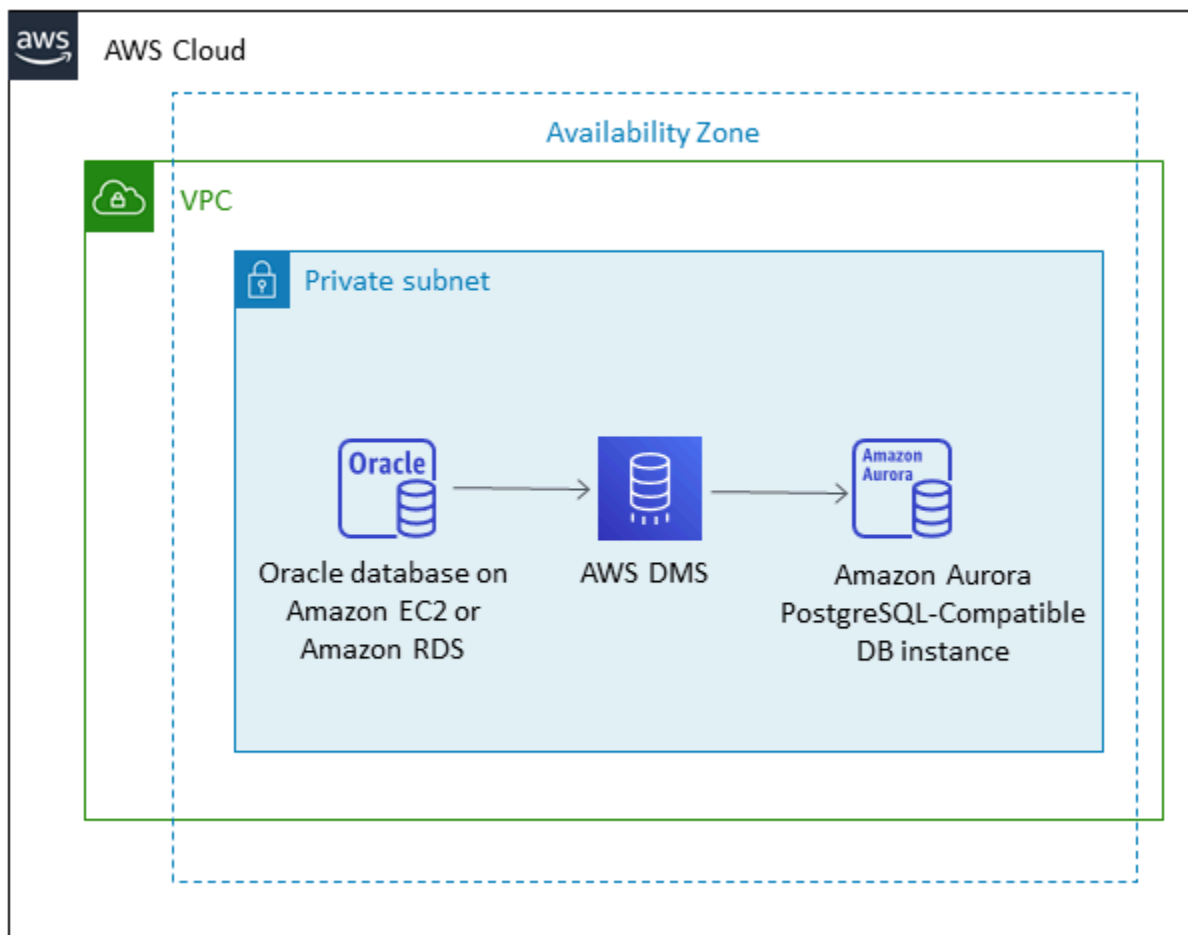

- From an Oracle database running in an on-premises data center

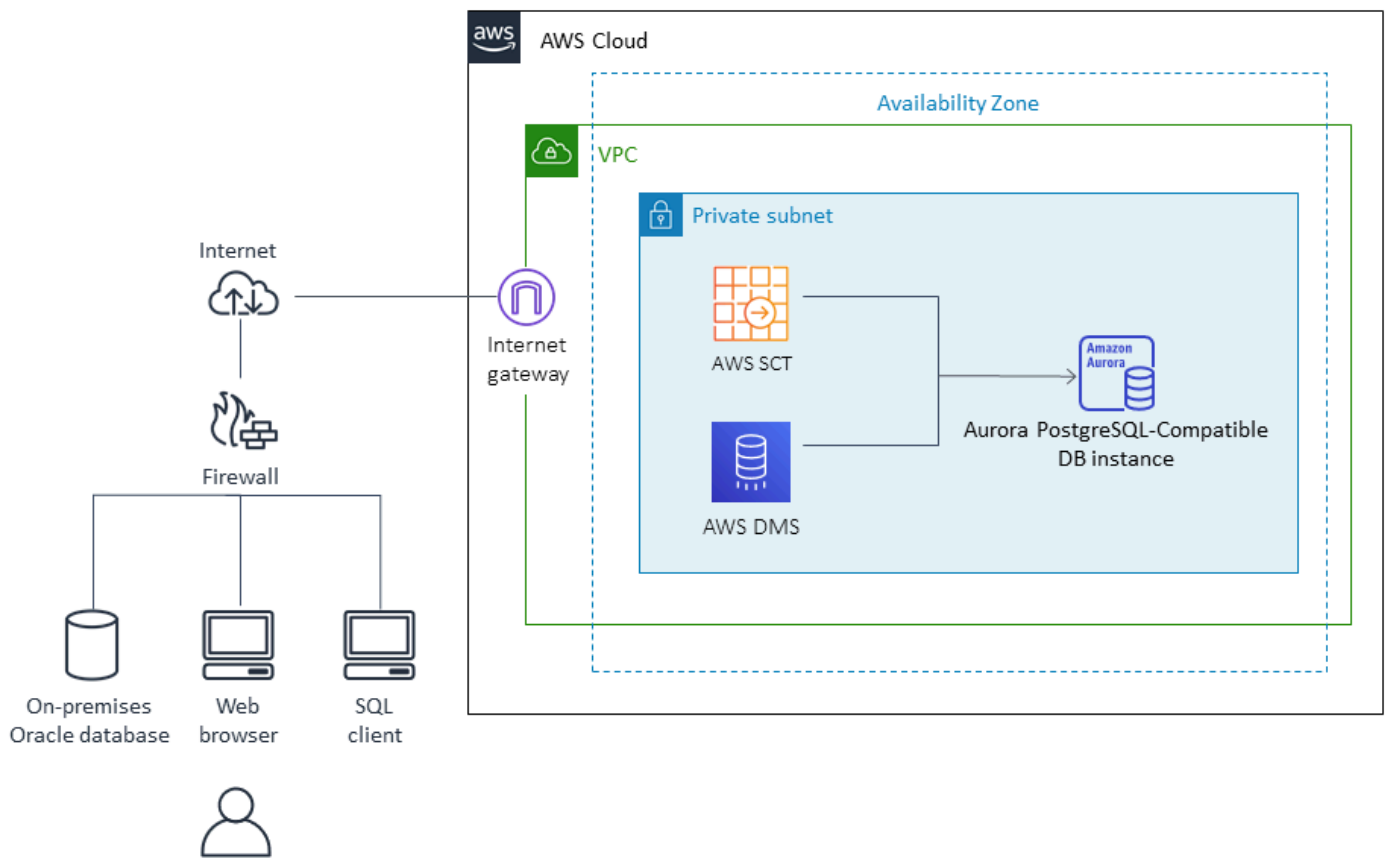

## Tools

- [AWS Database Migration Service \(AWS DMS\)](#) helps you migrate data stores into the AWS Cloud or between combinations of cloud and on-premises setups.
- [AWS Schema Conversion Tool \(AWS SCT\)](#) supports heterogeneous database migrations by automatically converting the source database schema and a majority of the custom code to a format compatible with the target database.

## Epics

### Prepare for the migration

Task	Description	Skills required
Prepare the source database.	To prepare the source database, see <a href="#">Using Oracle</a>	DBA

Task	Description	Skills required
	<a href="#">Database as a source for AWS SCT</a> in the AWS SCT documentation.	
Create an EC2 instance for AWS SCT.	Create and configure an EC2 instance for AWS SCT, if required.	DBA
Download AWS SCT.	Download the latest version of AWS SCT and associated drivers. For more information, see <a href="#">Installing, verifying, and updating AWS SCT</a> in the AWS SCT documentation.	DBA
Add users and permissions.	Add and validate the prerequisite users and permissions in the source database.	DBA
Create an AWS SCT project.	Create an AWS SCT project for the workload, and connect to the source database. For instructions, see <a href="#">Creating an AWS SCT project</a> and <a href="#">Adding database servers</a> in the AWS SCT documentation.	DBA

Task	Description	Skills required
Evaluate feasibility.	Generate an assessment report, which summarizes action items for schemas that can't be converted automatically and provides estimates for manual conversion efforts. For more information, see <a href="#">Creating and reviewing the database migration assessment report</a> in the AWS SCT documentation.	DBA

## Prepare the target database

Task	Description	Skills required
Create a target Amazon RDS DB instance.	Create a target Amazon RDS DB instance, using Amazon Aurora as the database engine. For instructions, see <a href="#">Creating an Amazon RDS DB instance</a> in the Amazon RDS documentation.	DBA
Extract users, roles, and permissions.	Extract the list of users, roles, and permissions from the source database.	DBA
Map users.	Map the existing database users to the new database users.	App owner
Create users.	Create users in the target database.	DBA, App owner

Task	Description	Skills required
Apply roles.	Apply roles from the previous step to the target database.	DBA
Check options, parameters, network files, and database links.	Review the source database for options, parameters, network files, and database links, and then evaluate their applicability to the target database.	DBA
Apply settings.	Apply any relevant settings to the target database.	DBA

## Transfer objects

Task	Description	Skills required
Configure AWS SCT connectivity.	Configure AWS SCT connectivity to the target database.	DBA
Convert the schema using AWS SCT.	AWS SCT automatically converts the source database schema and most of the custom code to a format that is compatible with the target database. Any code that the tool cannot convert automatically is clearly marked so that you can convert it manually.	DBA
Review the report.	Review the generated SQL report and save any errors and warnings.	DBA

Task	Description	Skills required
Apply automated schema changes.	Apply automated schema changes to the target database or save them as a .sql file.	DBA
Validate objects.	Validate that AWS SCT created the objects on the target.	DBA
Handle items that weren't converted.	Manually rewrite, reject, or redesign any items that failed to convert automatically.	DBA, App owner
Apply role and user permissions.	Apply the generated role and user permissions and review any exceptions.	DBA

## Migrate the data

Task	Description	Skills required
Determine the method.	Determine the method for migrating data.	DBA
Create a replication instance.	Create a replication instance from the AWS DMS console. For more information, see <a href="#">Working with an AWS DMS replication instance</a> in the AWS DMS documentation.	DBA
Create the source and target endpoints.	To create endpoints, follow the instructions in <a href="#">Creating source and target endpoints</a>	DBA

Task	Description	Skills required
	<a href="#">in the AWS DMS</a> documentation.	
Create a replication task.	To create a task, see <a href="#">Working with AWS DMS tasks</a> in the AWS DMS documentation.	DBA
Start the replication task and monitor the logs.	For more information about this step, see <a href="#">Monitoring AWS DMS tasks</a> in the AWS DMS documentation.	DBA

## Migrate the application

Task	Description	Skills required
Analyze and convert SQL items in the application code.	Use AWS SCT to analyze and convert the SQL items in the application code. When you convert your database schema from one engine to another, you also need to update the SQL code in your applications to interact with the new database engine instead of the old one. You can view, analyze, edit, and save the converted SQL code.	App owner
Create application servers.	Create the new application servers on AWS.	App owner
Migrate the application code.	Migrate the application code to the new servers.	App owner



Task	Description	Skills required
Configure the application servers.	Configure the application servers for the target database and drivers.	App owner
Fix code.	Fix any code that's specific to the source database engine in your application.	App owner
Optimize code.	Optimize your application code for the target database engine.	App owner

## Cut over

Task	Description	Skills required
Cut over to the target database.	Perform the cutover to the new database.	DBA
Lock the application.	Lock the application from any further changes.	App owner
Validate changes.	Validate that all changes were propagated to the target database.	DBA
Redirect to the target database.	Point the new application servers to the target database.	App owner
Check everything.	Perform a final, comprehensive system check.	App owner
Go live.	Complete final cutover tasks.	App owner

## Close the project

Task	Description	Skills required
Shut down temporary resources.	Shut down the temporary AWS resources such as the AWS DMS replication instance and the EC2 instance used for AWS SCT.	DBA, App owner
Update feedback.	Update feedback on the AWS DMS process for internal teams.	DBA, App owner
Revise process and templates.	Revise the AWS DMS process and improve the template if necessary.	DBA, App owner
Validate documents.	Review and validate the project documents.	DBA, App owner
Gather metrics.	Gather metrics to evaluate the time to migrate, percent of manual versus tool cost savings, and so on.	DBA, App owner
Close the project.	Close the migration project and provide feedback to stakeholders.	DBA, App owner

## Related resources

### References

- [Using an Oracle Database as a Source for AWS DMS](#)
- [Using a PostgreSQL Database as a Target for AWS Database Migration Service](#)
- [Oracle Database 11g/12c to Amazon Aurora with PostgreSQL Compatibility \(9.6.x\) Migration Playbook](#)

- [Oracle Database 19c to Amazon Aurora with PostgreSQL Compatibility \(12.4\) Migration Playbook](#)
- [Migrating an Amazon RDS for Oracle database to Amazon Aurora PostgreSQL-Compatible Edition](#)
- [AWS Data Migration Service](#)
- [AWS Schema Conversion Tool](#)
- [Migrate from Oracle to Amazon Aurora](#)
- [Amazon RDS pricing](#)

## Tutorials and videos

- [Database Migration Step-by-Step Walkthroughs](#)
- [Getting Started with AWS DMS](#)
- [Getting Started with Amazon RDS](#)
- [AWS Data Migration Service \(video\)](#)
- [Migrating an Oracle database to PostgreSQL \(video\)](#)

## Additional information

.

# Migrate data from an on-premises Oracle database to Aurora PostgreSQL

Created by Michelle Deng (AWS) and Shunan Xiang (AWS)

<b>Environment:</b> PoC or pilot	<b>Source:</b> Oracle	<b>Target:</b> Aurora PostgreSQL-Compatible
<b>R Type:</b> Re-architect	<b>Workload:</b> Oracle	<b>Technologies:</b> Migration; Databases
<b>AWS services:</b> Amazon Aurora; AWS DMS; AWS SCT		

## Summary

This pattern provides guidance for data migration from an on-premises Oracle database to Amazon Aurora PostgreSQL-Compatible Edition. It targets an online data migration strategy with a minimal amount of downtime for multi-terabyte Oracle databases that contain large tables with high data manipulation language (DML) activities. An Oracle Active Data Guard standby database is used as the source to offload data migration from the primary database. The replication from the Oracle primary database to standby can be suspended during the full load to avoid ORA-01555 errors.

Table columns in primary keys (PKs) or foreign keys (FKs), with data type NUMBER, are commonly used to store integers in Oracle. We recommend that you convert these to INT or BIGINT in PostgreSQL for better performance. You can use the AWS Schema Conversion Tool (AWS SCT) to change the default data type mapping for PK and FK columns. (For more information, see the AWS blog post [Convert the NUMBER data type from Oracle to PostgreSQL](#).) The data migration in this pattern uses AWS Database Migration Service (AWS DMS) for both full load and change data capture (CDC).

You can also use this pattern to migrate an on-premises Oracle database to Amazon Relational Database Service (Amazon RDS) for PostgreSQL, or an Oracle database that's hosted on Amazon Elastic Compute Cloud (Amazon EC2) to either Amazon RDS for PostgreSQL or Aurora PostgreSQL-Compatible.

## Prerequisites and limitations

### Prerequisites

- An active AWS account
- An Oracle source database in an on-premises data center with Active Data Guard standby configured
- AWS Direct Connect configured between the on-premises data center and the AWS Cloud
- Familiarity with [using an Oracle database as a source for AWS DMS](#)
- Familiarity with [using a PostgreSQL database as a target for AWS DMS](#)

### Limitations

- Amazon Aurora database clusters can be created with up to 128 TiB of storage. Amazon RDS for PostgreSQL database instances can be created with up to 64 TiB of storage. For the latest storage information, see [Amazon Aurora storage and reliability](#) and [Amazon RDS DB instance storage](#) in the AWS documentation.

### Product versions

- AWS DMS supports all Oracle database editions for versions 10.2 and later (for versions 10.x), 11g and up to 12.2, 18c, and 19c. For the latest list of supported versions, see [Using an Oracle Database as a Source for AWS DMS](#) in the AWS documentation.

## Architecture

### Source technology stack

- On-premises Oracle databases with Oracle Active Data Guard standby configured

### Target technology stack

- Aurora PostgreSQL-Compatible

### Data migration architecture

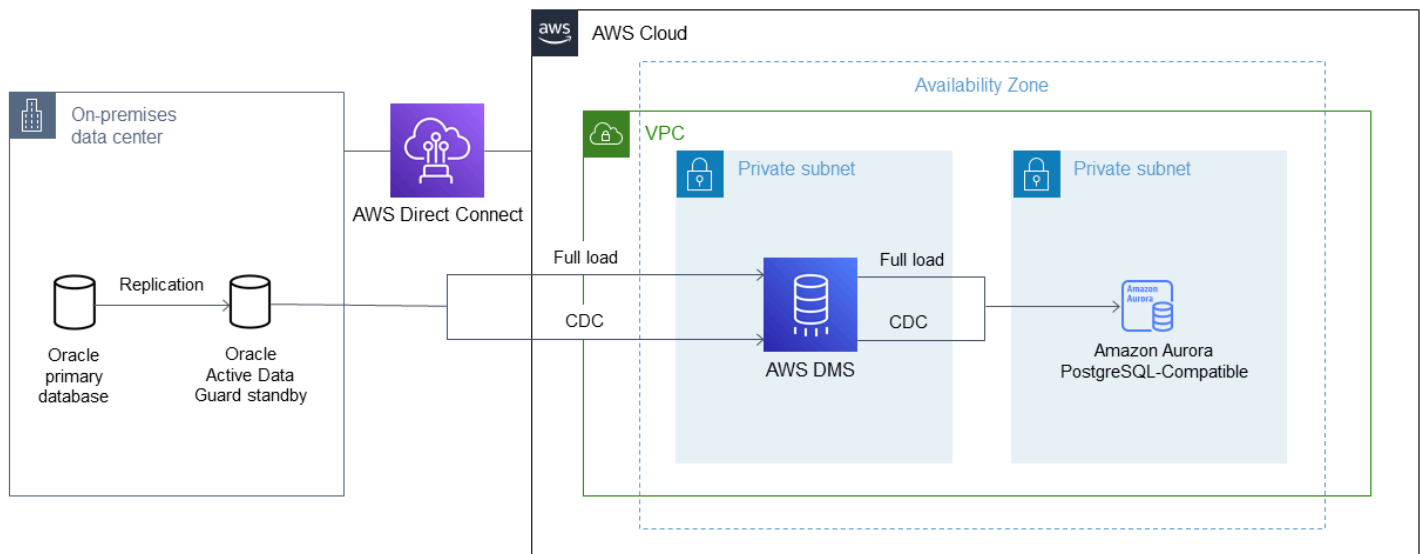

## Tools

- AWS DMS** - [AWS Database Migration Service](#) (AWS DMS) supports several source and target databases. See [Using an Oracle Database as a Source for AWS DMS](#) in the AWS DMS documentation for a list of supported Oracle source and target database versions and editions. If the source database is not supported by AWS DMS, you must select another method for migrating the data in Phase 6 (in the *Epics* section). **Important note:** Because this is a heterogeneous migration, you must first check to see whether the database supports a commercial off-the-shelf (COTS) application. If the application is COTS, consult the vendor to confirm that Aurora PostgreSQL-Compatible is supported before proceeding. For more information, see [AWS DMS Step-by-Step Migration Walkthroughs](#) in the AWS documentation.
- AWS SCT** - The [AWS Schema Conversion Tool](#) (AWS SCT) facilitates heterogeneous database migrations by automatically converting the source database schema and a majority of the custom code to a format that's compatible with the target database. The custom code that the tool converts includes views, stored procedures, and functions. Any code that the tool cannot convert automatically is clearly marked so that you can convert it yourself.

## Epics

### Plan the migration

Task	Description	Skills required
Validate the source and target database versions.		DBA
Install AWS SCT and drivers.		DBA
Add and validate the AWS SCT prerequisite users and grants-source database.		DBA
Create an AWS SCT project for the workload, and connect to the source database.		DBA
Generate an assessment report and evaluate feasibility.		DBA, App owner

### Prepare the target database

Task	Description	Skills required
Create an Aurora PostgreSQL-Compatible target database.		DBA
Extract users, roles, and grants list from the source database.		DBA
Map the existing database users to the new database users.		App owner

Task	Description	Skills required
Create users in the target database.		DBA
Apply roles from the previous step to the target Aurora PostgreSQL-Compatible database.		DBA
Review database options, parameters, network files, and database links from the source database, and evaluate their applicability to the target database.		DBA, App owner
Apply any relevant settings to the target database.		DBA

### Prepare for database object code conversion

Task	Description	Skills required
Configure AWS SCT connectivity to the target database.		DBA
Convert the schema in AWS SCT, and save the converted code as a .sql file.		DBA, App owner
Manually convert any database objects that failed to convert automatically.		DBA, App owner
Optimize the database code conversion.		DBA, App owner



Task	Description	Skills required
Separate the .sql file into multiple .sql files based on the object type.		DBA, App owner
Validate the SQL scripts in the target database.		DBA, App owner

## Prepare for data migration

Task	Description	Skills required
Create an AWS DMS replication instance.		DBA
Create the source and target endpoints.	If the data type of the PKs and FKs is converted from NUMBER in Oracle to BIGINT in PostgreSQL, consider specifying the connection attribute <code>numberDatatypeScale=-2</code> when you create the source endpoint.	DBA

## Migrate data – full load

Task	Description	Skills required
Create the schema and tables in the target database.		DBA
Create AWS DMS full-load tasks by either grouping tables or splitting a big table based on the table size.		DBA

Task	Description	Skills required
Stop the applications on the source Oracle databases for a short period.		App owner
Verify that the Oracle standby database is synchronous with the primary database, and stop the replication from the primary database to the standby database.		DBA, App owner
Start applications on the source Oracle database.		App owner
Start the AWS DMS full-load tasks in parallel from the Oracle standby database to the Aurora PostgreSQL-Compatible database.		DBA
Create PKs and secondary indexes after the full load is complete.		DBA
Validate the data.		DBA

### Migrate data – CDC

Task	Description	Skills required
Create AWS DMS ongoing replication tasks by specifying a custom CDC start time or system change number (SCN) when the Oracle		DBA

Task	Description	Skills required
standby was synchronized with the primary database, and before the applications were restarted in the previous task.		
Start AWS DMS tasks in parallel to replicate ongoing changes from the Oracle standby database to the Aurora PostgreSQL-Compatible database.		DBA
Re-establish the replication from the Oracle primary database to the standby database.		DBA
Monitor the logs and stop the applications on the Oracle database when the target Aurora PostgreSQL-Compatible database is almost synchronous with the source Oracle database.		DBA, App owner
Stop the AWS DMS tasks when the target is fully synchronized with the source Oracle database.		DBA
Create FKs and validate the data in the target database.		DBA

Task	Description	Skills required
Create functions, views, triggers, sequences, and other object types in the target database.		DBA
Apply role grants in the target database.		DBA

## Migrate the application

Task	Description	Skills required
Use AWS SCT to analyze and convert the SQL statements inside the application code.		App owner
Create new application servers on AWS.		App owner
Migrate the application code to the new servers.		App owner
Configure the application server for the target database and drivers.		App owner
Fix any code that's specific to the source database engine in the application.		App owner
Optimize the application code for the target database.		App owner

## Cut over

Task	Description	Skills required
Point the new application server to the target database.		DBA, App owner
Perform sanity checks.		DBA, App owner
Go live.		DBA, App owner

## Close the project

Task	Description	Skills required
Shut down temporary AWS resources.		DBA, Systems administrator
Review and validate the project documents.		DBA, App owner
Gather metrics for time to migrate, percentage of manual versus tool use, cost savings, and similar data.		DBA, App owner
Close out the project and provide feedback.		DBA, App owner

## Related resources

### References

- [Oracle Database to Aurora PostgreSQL-Compatible: Migration Playbook](#)
- [Migrating an Amazon RDS for Oracle Database to Amazon Aurora MySQL](#)
- [AWS DMS website](#)
- [AWS DMS documentation](#)

- [AWS SCT website](#)
- [AWS SCT documentation](#)
- [Migrate from Oracle to Amazon Aurora](#)

## Tutorials

- [Getting Started with AWS DMS](#)
- [Getting Started with Amazon RDS](#)
- [AWS Database Migration Service Step-by-Step Walkthroughs](#)

# Migrate from SAP ASE to Amazon RDS for SQL Server using AWS DMS

*Created by Amit Kumar (AWS)*

<b>Environment:</b> PoC or pilot	<b>Source:</b> SAP ASE	<b>Target:</b> Amazon RDS for SQL Server
<b>R Type:</b> Re-architect	<b>Workload:</b> SAP	<b>Technologies:</b> Migration; Databases; Modernization
<b>AWS services:</b> Amazon RDS; AWS DMS		

## Summary

This pattern provides guidance for migrating an SAP Adaptive Server Enterprise (ASE) database to an Amazon Relational Database Service (Amazon RDS) DB instance that's running Microsoft SQL Server. The source database can be located in an on-premises data center or on an Amazon Elastic Compute Cloud (Amazon EC2) instance. The pattern uses AWS Database Migration Service (AWS DMS) to migrate data and (optionally) computer-aided software engineering (CASE) tools to convert the database schema.

## Prerequisites and limitations

### Prerequisites

- An active AWS account
- An SAP ASE database in an on-premises data center or on an EC2 instance
- A target Amazon RDS for SQL Server database that's up and running

### Limitations

- Database size limit: 64 TB

### Product versions

- SAP ASE version 15.7 or 16.x only. For the latest information, see [Using an SAP Database as a Source for AWS DMS](#).
- For Amazon RDS target databases, AWS DMS supports [Microsoft SQL Server versions on Amazon RDS](#) for the Enterprise, Standard, Web, and Express editions. For the latest information about supported versions, see the [AWS DMS documentation](#). We recommend that you use the latest version of AWS DMS for the most comprehensive version and feature support.

## Architecture

### Source technology stack

- An SAP ASE database that's on premises or on an Amazon EC2 instance

### Target technology stack

- An Amazon RDS for SQL Server DB instance

### Source and target architecture

*From an SAP ASE database on Amazon EC2 to an Amazon RDS for SQL Server DB instance:*



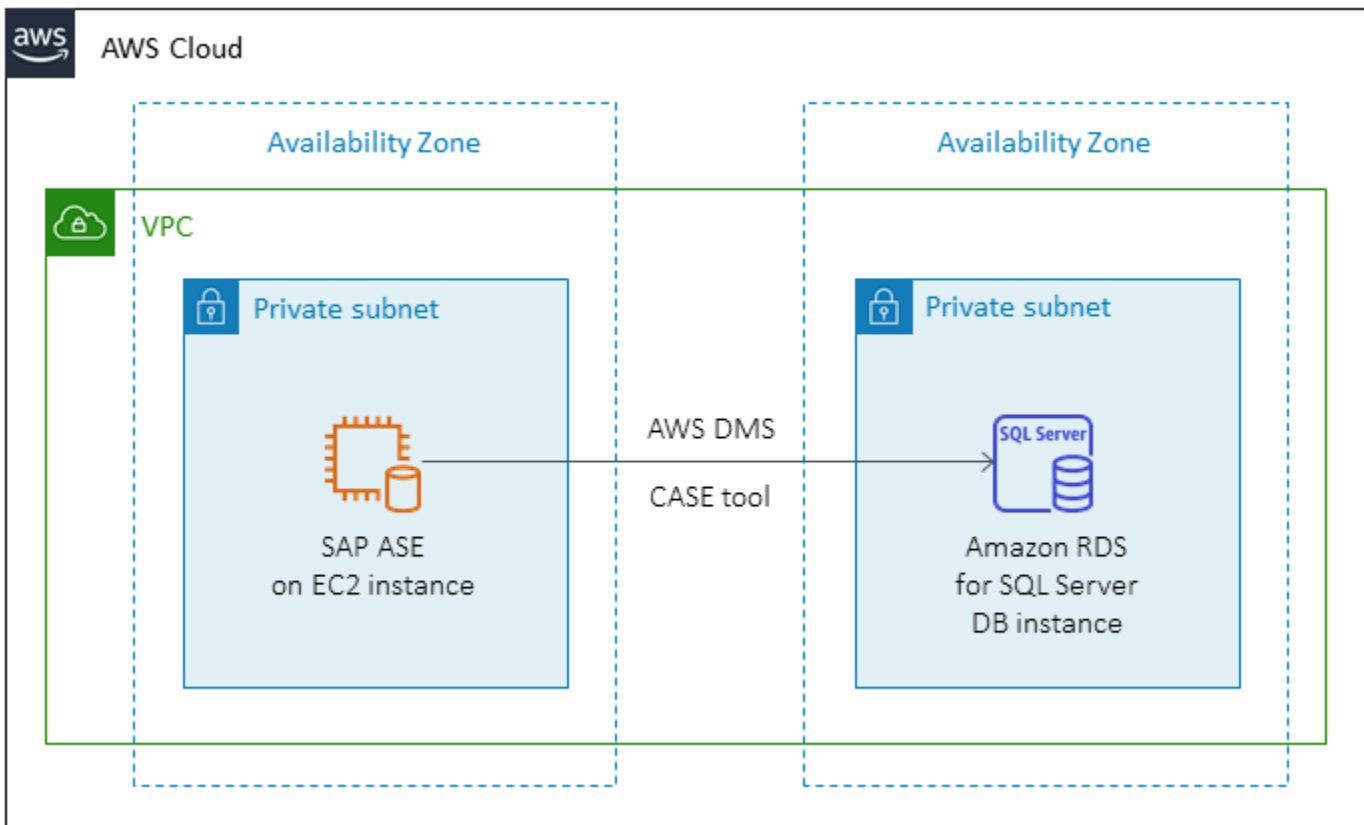

*From an on-premises SAP ASE database to an Amazon RDS for SQL Server DB instance:*

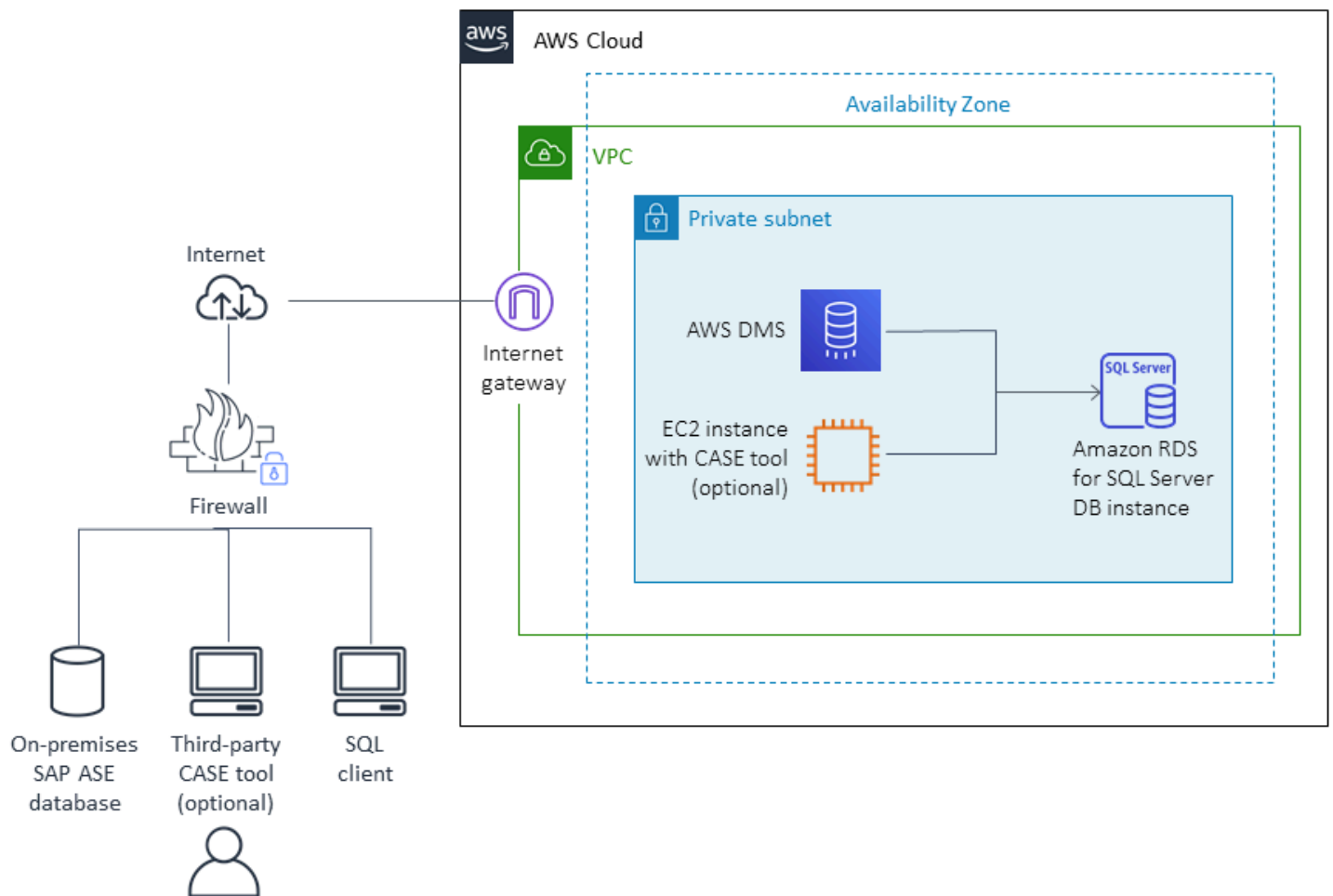

## Tools

- [AWS Database Migration Service](#) (AWS DMS) is a web service you can use to migrate data from your database that is on-premises, on an Amazon RDS DB instance, or in a database on an EC2 instance, to a database on an AWS service such as Amazon RDS for SQL Server or an EC2 instance. You can also migrate a database from an AWS service to an on-premises database. You can migrate data between heterogeneous or homogeneous database engines.
- For schema conversions, you can optionally use [erwin Data Modeler](#) or [SAP PowerDesigner](#).

## Epics

### Plan the migration

Task	Description	Skills required
Validate the source and target database versions.		DBA
Identify the storage requirements (storage type and capacity).		DBA, SysAdmin
Choose the proper instance type based on capacity, storage features, and network features.		DBA, SysAdmin
Identify the network access security requirements for the source and target databases.		DBA, SysAdmin
Identify the application migration strategy.		DBA, SysAdmin, App owner

### Configure the infrastructure

Task	Description	Skills required
Create a virtual private cloud (VPC) and subnets.		SysAdmin
Create security groups and network access control lists (ACLs).		SysAdmin
Configure and start an Amazon RDS DB instance.		SysAdmin

## Migrate data - option 1

Task	Description	Skills required
Migrate the database schema manually or use a CASE tool such as erwin Data Modeler or SAP PowerDesigner.		DBA

## Migrate data - option 2

Task	Description	Skills required
Migrate data using AWS DMS.		DBA

## Migrate the application

Task	Description	Skills required
Follow the application migration strategy.		DBA, SysAdmin, App owner

## Cut over

Task	Description	Skills required
Switch the application clients over to the new infrastructure.		DBA, SysAdmin, App owner

## Close the project

Task	Description	Skills required
Shut down the temporary AWS resources.		DBA, SysAdmin
Review and validate the project documents.		DBA, SysAdmin, App owner
Gather metrics such as time to migrate, percentage of manual versus automated tasks, and cost savings.		DBA, SysAdmin, App owner
Close out the project and provide feedback.		DBA, SysAdmin, App owner

## Related resources

### References

- [AWS DMS website](#)
- [Amazon RDS Pricing](#)
- [Using a SAP ASE Database as a Source for AWS DMS](#)
- [Limitations for RDS Custom for SQL Server](#)

### Tutorials and videos

- [Getting Started with AWS DMS](#)
- [Getting Started with Amazon RDS](#)
- [AWS DMS \(video\)](#)
- [Amazon RDS \(video\)](#)

# Migrate an on-premises Microsoft SQL Server database to Amazon Redshift using AWS DMS

Created by Marcelo Fernandes (AWS)

<b>Environment:</b> PoC or pilot	<b>Source:</b> Microsoft SQL Server	<b>Target:</b> Amazon Redshift
<b>R Type:</b> Re-architect	<b>Workload:</b> Microsoft	<b>Technologies:</b> Migration; Databases
<b>AWS services:</b> Amazon Redshift		

## Summary

This pattern provides guidance for migrating an on-premises Microsoft SQL Server database to Amazon Redshift by using AWS Data Migration Service (AWS DMS).

## Prerequisites and limitations

### Prerequisites

- An active AWS account
- A source Microsoft SQL Server database in an on-premises data center
- Completed prerequisites for using an Amazon Redshift database as a target for AWS DMS, as discussed in the [AWS DMS documentation](#)

### Product versions

- SQL Server 2005-2019, Enterprise, Standard, Workgroup, Developer, and Web editions. For the latest list of supported versions, see [Using a Microsoft SQL Server Database as a Source for AWS DMS](#) in the AWS documentation.

## Architecture

### Source technology stack

- An on-premises Microsoft SQL Server database

## Target technology stack

- Amazon Redshift

## Data migration architecture

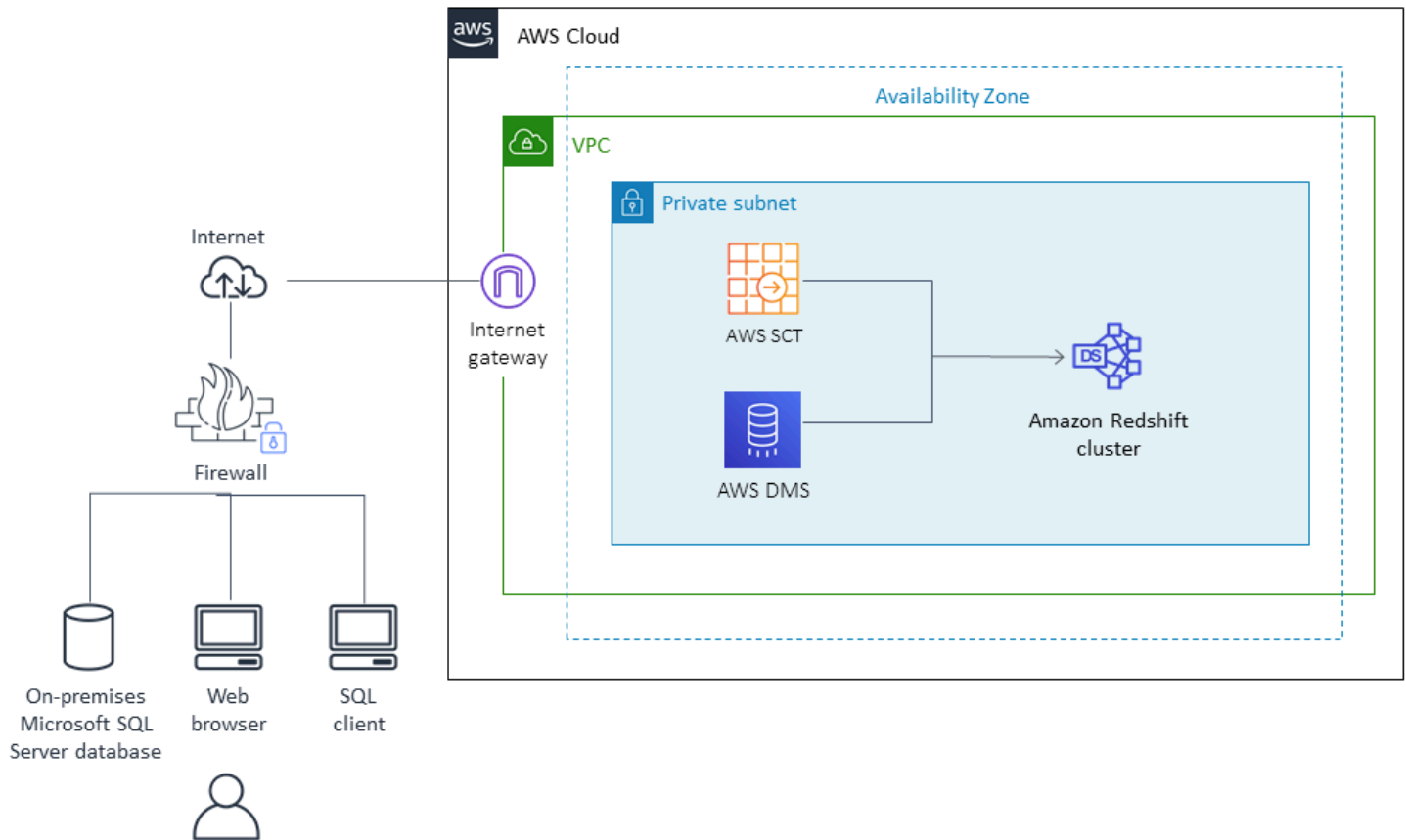

## Tools

- [AWS DMS](#) is a data migration service that supports several types of source and target databases. For information about the Microsoft SQL Server database versions and editions that are supported for use with AWS DMS, see [Using a Microsoft SQL Server Database as a Source for AWS DMS](#) in the AWS DMS documentation. If AWS DMS doesn't support your source database, you must select an alternative method for data migration.

## Epics

### Plan the migration

Task	Description	Skills required
Validate the source and target database version and engine.		DBA
Identify the hardware requirements for the target server instance.		DBA, Systems administrator
Identify the storage requirements (storage type and capacity).		DBA, Systems administrator
Choose the proper instance type based on capacity, storage features, and network features.		DBA, Systems administrator
Identify the network access security requirements for the source and target databases.		DBA, Systems administrator
Identify the application migration strategy.		DBA, App owner, Systems administrator

### Configure the infrastructure

Task	Description	Skills required
Create a virtual private cloud (VPC).	For more information, see <a href="#">Working with a DB instance in a VPC</a> in the AWS documentation.	Systems administrator



Task	Description	Skills required
Create security groups.		Systems administrator
Configure and start an Amazon Redshift cluster.	For more information, see <a href="#">Create a sample Amazon Redshift cluster</a> in the Amazon Redshift documentation.	DBA, Systems administrator

## Migrate data

Task	Description	Skills required
Migrate the data from the Microsoft SQL Server database by using AWS DMS.		DBA

## Migrate the application

Task	Description	Skills required
Follow the application migration strategy.		DBA, App owner, Systems administrator

## Cut over

Task	Description	Skills required
Switch the application clients over to the new infrastructure.		DBA, App owner, Systems administrator

## Close the project

Task	Description	Skills required
Shut down the temporary resources.		DBA, Systems administrator
Review and validate the project documents.		DBA, App owner, Systems administrator
Gather metrics such as time to migrate, percentage of manual versus automated tasks, and cost savings.		DBA, App owner, Systems administrator
Close out the project and provide feedback.		DBA, App owner, Systems administrator

## Related resources

### References

- [AWS DMS documentation](#)
- [Amazon Redshift documentation](#)
- [Amazon Redshift Pricing](#)

### Tutorials and videos

- [Getting Started with AWS DMS](#)
- [Getting Started with Amazon Redshift](#)
- [Using an Amazon Redshift database as a target for AWS Database Migration Service](#)
- [AWS DMS \(video\)](#)

# Migrate an on-premises Microsoft SQL Server database to Amazon Redshift using AWS SCT data extraction agents

Created by Neha Thakur (AWS)

<b>Environment:</b> PoC or pilot	<b>Source:</b> Microsoft SQL Server	<b>Target:</b> Amazon Redshift
<b>R Type:</b> Re-architect	<b>Workload:</b> Microsoft	<b>Technologies:</b> Migration; Databases
<b>AWS services:</b> Amazon Redshift; AWS SCT		

## Summary

This pattern outlines steps for migrating an on-premises Microsoft SQL Server source database to an Amazon Redshift target database by using AWS Schema Conversion Tool (AWS SCT) data extraction agents. An agent is an external program that is integrated with AWS SCT but performs data transformation elsewhere and interacts with other AWS services on your behalf.

## Prerequisites and limitations

### Prerequisites

- A Microsoft SQL Server source database used for the data warehouse workload in an on-premises data center
- An active AWS account

### Product versions

- Microsoft SQL Server version 2008 or later. For the latest list of supported versions, see [AWS SCT documentation](#).

## Architecture

### technology stackSource

- An on-premises Microsoft SQL Server database

## technology stackTarget

- Amazon Redshift

## Data migration architecture

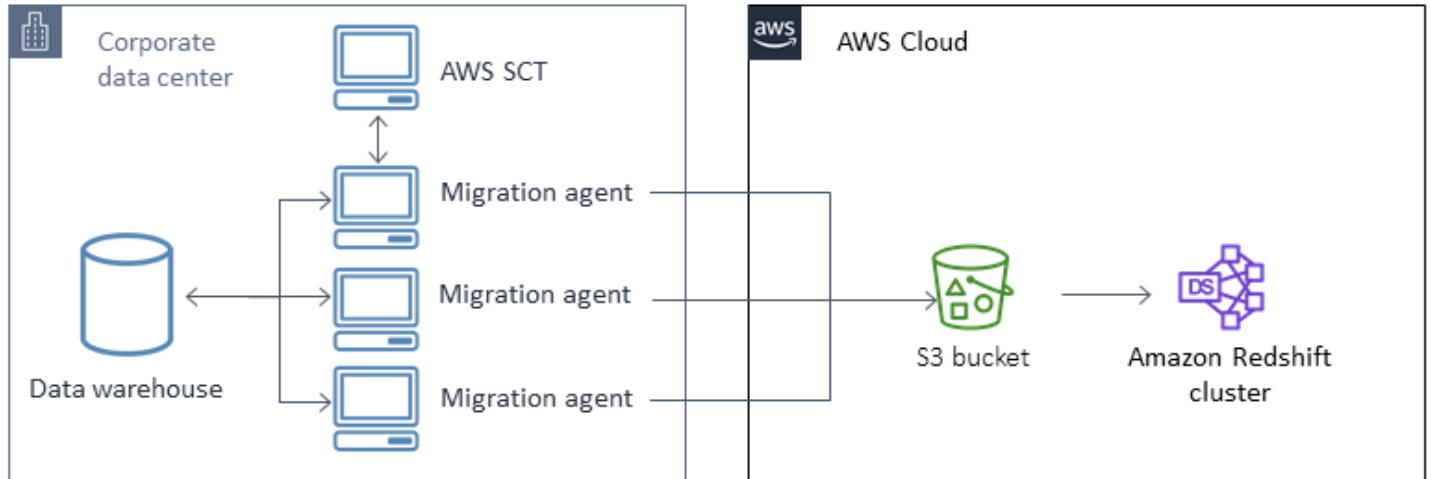

## Tools

- [AWS Schema Conversion Tool](#) (AWS SCT) handles heterogeneous database migrations by automatically converting the source database schema and a majority of the custom code to a format that's compatible with the target database. When the source and target databases are very different, you can use an AWS SCT agent to perform additional data transformation. For more information, see [Migrating Data from an On-Premises Data Warehouse to Amazon Redshift](#) in the AWS documentation.

## Best practices

- [Best practices for AWS SCT](#)
- [Best practices for Amazon Redshift](#)

## Epics

### Prepare for migration

Task	Description	Skills required
Validate the source and target database versions and engines.		DBA
Identify hardware requirements for the target server instance.		DBA, SysAdmin
Identify storage requirements (storage type and capacity).		DBA, SysAdmin
Choose the proper instance type (capacity, storage features, network features).		DBA, SysAdmin
Identify network access security requirements for the source and target databases.		DBA, SysAdmin
Choose an application migration strategy.		DBA, SysAdmin, App owner

### Configure infrastructure

Task	Description	Skills required
Create a virtual private cloud (VPC) and subnets.		SysAdmin
Create security groups.		SysAdmin

Task	Description	Skills required
Configure and start the Amazon Redshift cluster.		SysAdmin

## Migrate data

Task	Description	Skills required
Migrate the data using the AWS SCT data extraction agents.		DBA

## Migrate applications

Task	Description	Skills required
Follow the chosen application migration strategy.		DBA, SysAdmin, App owner

## Cut over to the target database

Task	Description	Skills required
Switch application clients over to the new infrastructure.		DBA, SysAdmin, App owner

## Close the project

Task	Description	Skills required
Shut down temporary AWS resources.		DBA, SysAdmin

Task	Description	Skills required
Review and validate the project documents.		DBA, SysAdmin, App owner
Gather metrics such as time to migrate, percentage of manual versus automated tasks, and cost savings.		DBA, SysAdmin, App owner
Close the project and provide any feedback.		DBA, SysAdmin, App owner

## Related resources

### References

- [AWS SCT User Guide](#)
- [Using Data Extraction Agents](#)
- [Amazon Redshift Pricing](#)

### Tutorials and videos

- [Getting Started with the AWS Schema Conversion Tool](#)
- [Getting Started with Amazon Redshift](#)

# Migrate a Teradata database to Amazon Redshift using AWS SCT data extraction agents

Created by Sergey Dmitriev (AWS)

<b>R Type:</b> Re-architect	<b>Source:</b> Databases: Relational	<b>Target:</b> Amazon Redshift
<b>Created by:</b> AWS	<b>Environment:</b> PoC or pilot	<b>Technologies:</b> Databases; Migration
<b>AWS services:</b> Amazon Redshift		

## Summary

This pattern walks you through the steps for migrating a Teradata database, used as a data warehouse in an on-premises data center, to an Amazon Redshift database. The pattern uses AWS Schema Conversion Tool (AWS SCT) data extraction agents. An agent is an external program that is integrated with AWS SCT but performs data transformation elsewhere and interacts with other AWS services on your behalf.

## Prerequisites and limitations

### Prerequisites

- An active AWS account
- A Teradata source database in an on-premises data center

### Product versions

- Teradata version 13 and later. For the latest list of supported versions, see the [AWS SCT documentation](#).

## Architecture

### Source technology stack



- On-premises Teradata database

## Target technology stack

- Amazon Redshift cluster

## Data migration architecture

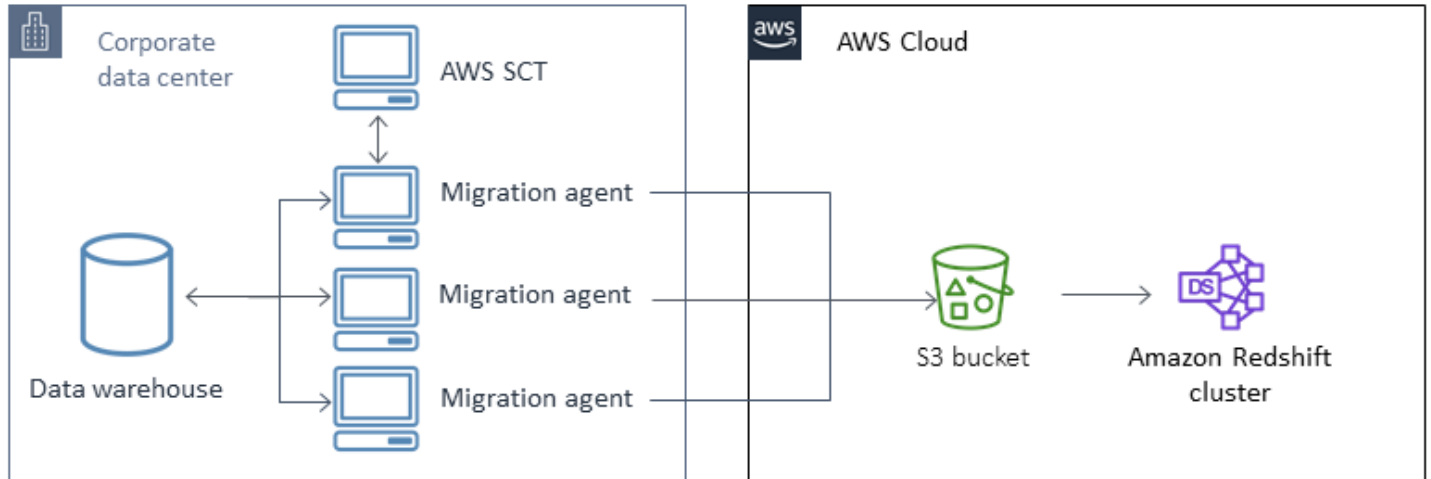

## Tools

- **AWS SCT** – [AWS Schema Conversion Tool](#) (AWS SCT) handles heterogeneous database migrations by automatically converting the source database schema and a majority of the custom code to a format that's compatible with the target database. When the source and target databases are very different from one another, you can use an AWS SCT agent to perform additional data transformation. For more information, see [Migrating Data from an On-Premises Data Warehouse to Amazon Redshift](#) in the AWS documentation.

## Epics

### Prepare for migration

Task	Description	Skills required
Validate the source and target database versions and engines.		DBA
Identify hardware requirements for the target server instance.		DBA, SysAdmin
Identify storage requirements (storage type and capacity).		DBA, SysAdmin
Choose the proper instance type (capacity, storage features, network features).		DBA, SysAdmin
Identify network-access security requirements for the source and target databases.		DBA, SysAdmin
Choose an application migration strategy.		DBA, SysAdmin, App owner

### Configure infrastructure

Task	Description	Skills required
Create a virtual private cloud (VPC) and subnets.		SysAdmin
Create security groups.		SysAdmin

Task	Description	Skills required
Configure and start the Amazon Redshift cluster.		SysAdmin

## Migrate data

Task	Description	Skills required
Migrate data by using AWS SCT data extraction agents.	For detailed information on using AWS SCT data extraction agents, see the links in the References and Help section.	DBA

## Migrate applications

Task	Description	Skills required
Follow the chosen application migration strategy.		DBA, SysAdmin, App owner

## Cut over to the target Amazon Redshift database

Task	Description	Skills required
Switch over application clients to the new infrastructure.		DBA, SysAdmin, App owner

## Close the project

Task	Description	Skills required
Shut down temporary AWS resources.		DBA, SysAdmin
Review and validate the project documents.		DBA, SysAdmin, App owner
Gather metrics about time to migrate, percentage of manual versus tool tasks, cost savings, etc.		DBA, SysAdmin, App owner
Close the project and provide any feedback.		

## Related resources

### References

- [AWS SCT User Guide](#)
- [Using Data Extraction Agents](#)
- [Amazon Redshift Pricing](#)
- [Convert the Teradata RESET WHEN feature to Amazon Redshift SQL](#) (AWS Prescriptive Guidance)
- [Convert the Teradata NORMALIZE temporal feature to Amazon Redshift SQL](#) (AWS Prescriptive Guidance)

### Tutorials

- [Getting Started with the AWS Schema Conversion Tool](#)
- [Getting Started with Amazon Redshift](#)

# Migrate an on-premises Vertica database to Amazon Redshift using AWS SCT data extraction agents

Created by Sergey Dmitriev (AWS)

<b>Environment:</b> PoC or pilot	<b>Source:</b> Vertica database	<b>Target:</b> Amazon Redshift
<b>R Type:</b> Re-architect	<b>Technologies:</b> Migration; Databases	<b>AWS services:</b> Amazon Redshift

## Summary

This pattern provides guidance for migrating an on-premises Vertica database to an Amazon Redshift cluster using AWS Schema Conversion Tool (AWS SCT) data extraction agents. An agent is an external program that is integrated with AWS SCT but performs data transformation elsewhere and interacts with other AWS services on your behalf.

## Prerequisites and limitations

### Prerequisites

- An active AWS account
- A Vertica source database used for the data warehouse workload in an on-premises data center
- An Amazon Redshift target cluster

### Product versions

- Vertica version 7.2.2 and later. For the latest list of supported versions, see the [AWS SCT documentation](#).

## Architecture

### Source technology stack

- An on-premises Vertica database

## Target technology stack

- An Amazon Redshift cluster

## Data migration architecture

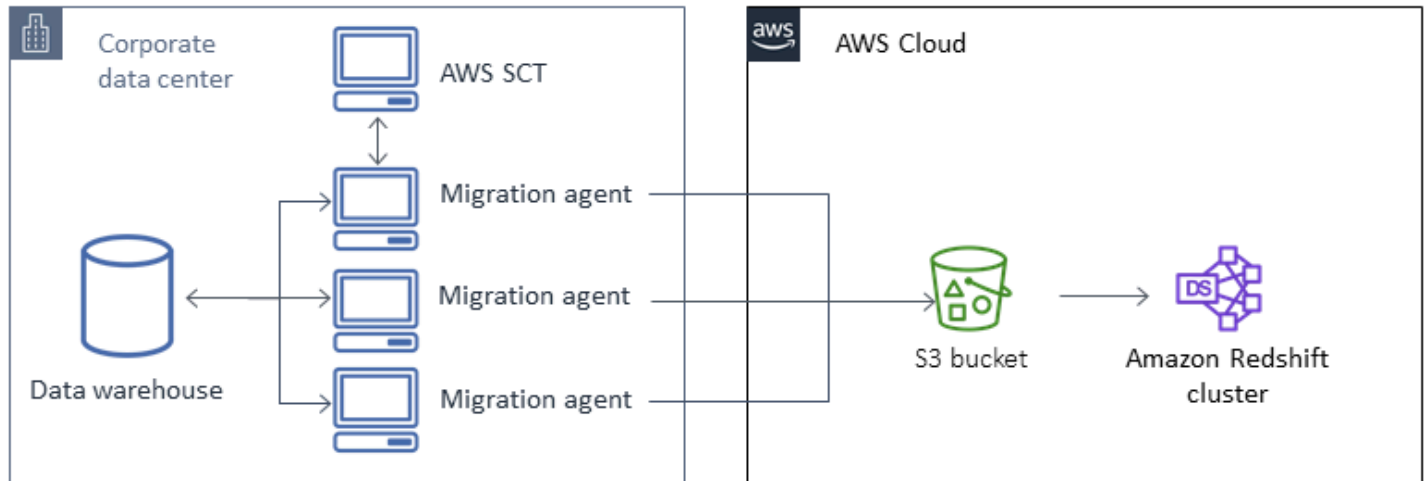

## Tools

- [AWS Schema Conversion Tool](#) (AWS SCT) handles heterogeneous database migrations by automatically converting the source database schema and a majority of the custom code to a format that's compatible with the target database. When the source and target databases are very different from one another, you can use an AWS SCT agent to perform additional data transformation. For more information, see [Migrating Data from an On-Premises Data Warehouse to Amazon Redshift](#) in the AWS documentation.

## Epics

### Prepare for migration

Task	Description	Skills required
Validate the source and target database versions.		DBA
Identify storage requirements (storage type and capacity).		DBA, SysAdmin

Task	Description	Skills required
Choose the proper instance type (capacity, storage features, network features).		DBA, SysAdmin
Identify the network-access security requirements for the source and target databases.		DBA, SysAdmin
Choose an application migration strategy.		DBA, SysAdmin, App owner

### Configure infrastructure

Task	Description	Skills required
Create a virtual private cloud (VPC) and subnets.		SysAdmin
Create security groups.		SysAdmin
Configure and start an Amazon Redshift cluster.		SysAdmin

### Migrate data

Task	Description	Skills required
Migrate the data using the AWS SCT data extraction agents.	For detailed information on using AWS SCT data extraction agents, see the links in the References and Help section.	DBA

## Migrate applications

Task	Description	Skills required
Follow the chosen application migration strategy.		DBA, SysAdmin, App owner

## Cut over to the target database

Task	Description	Skills required
Switch over application clients to the new infrastructure.		DBA, SysAdmin, App owner

## Close the project

Task	Description	Skills required
Shut down temporary AWS resources.		DBA, SysAdmin
Review and validate the project documents.		DBA, SysAdmin, App owner
Gather metrics about time to migrate, percentage of manual versus tool tasks, cost savings, etc.		DBA, SysAdmin, App owner
Close the project and provide any feedback.		

## Related resources

### References



- [AWS SCT User Guide](#)
- [Using Data Extraction Agents](#)
- [Amazon Redshift Pricing](#)

### **Tutorials and videos**

- [Getting Started with the AWS Schema Conversion Tool](#)
- [Getting Started with Amazon Redshift](#)

# Migrate legacy applications from Oracle Pro\*C to ECPG

Created by Sai Parthasaradhi (AWS) and Mahesh Balumuri (AWS)

<b>Environment:</b> PoC or pilot	<b>Source:</b> Oracle	<b>Target:</b> PostgreSQL
<b>R Type:</b> Re-architect	<b>Workload:</b> Oracle	<b>Technologies:</b> Migration; Databases

## Summary

Most legacy applications that have embedded SQL code use the Oracle Pro\*C precompiler to access the database. When you migrate these Oracle databases to Amazon Relational Database Service (Amazon RDS) for PostgreSQL or Amazon Aurora PostgreSQL-Compatible Edition, you have to convert your application code to a format that's compatible with the precompiler in PostgreSQL, which is called ECPG. This pattern describes how to convert Oracle Pro\*C code to its equivalent in PostgreSQL ECPG.

For more information about Pro\*C, see the [Oracle documentation](#). For a brief introduction to ECPG, see the [Additional information](#) section.

## Prerequisites and limitations

### Prerequisites

- An active AWS account
- An Amazon RDS for PostgreSQL or Aurora PostgreSQL-Compatible database
- An Oracle database running on premises

## Tools

- The PostgreSQL packages listed in the next section.
- [AWS CLI](#) – The AWS Command Line Interface (AWS CLI) is an open-source tool for interacting with AWS services through commands in your command-line shell. With minimal configuration, you can run AWS CLI commands that implement functionality equivalent to that provided by the browser-based AWS Management Console from a command prompt.

## Epics

### Set the build environment on CentOS or RHEL

Task	Description	Skills required
Install PostgreSQL packages.	<p>Install the required PostgreSQL packages by using the following commands.</p> <pre>yum update -y yum install -y yum- utils rpm -ivh https://d ownload.postgresql .org/pub/repos/yum /repopms/EL-8-x86 _64/pgdg-redhat-repo- latest.noarch.rpm dnf -qy module disable postgresql</pre>	App developer, DevOps engineer
Install the header files and libraries.	<p>Install the postgresql112-devel package, which contains header files and libraries, by using the following commands. Install the package in both the development and the runtime environments to avoid errors in the runtime environment.</p> <pre>dnf -y install postgresq l112-devel yum install ncompress zip ghostscript jq unzip wget git -y</pre>	App developer, DevOps engineer

Task	Description	Skills required
	<p>For the development environment only, also run the following commands.</p> <pre>yum install zlib-devel make -y ln -s /usr/pgsql-12/bin/ecpg /usr/bin/</pre>	
Configure the environment path variable.	<p>Set the environment path for PostgreSQL client libraries.</p> <pre>export PATH=\$PATH:/usr/pgsql-12/bin</pre>	App developer, DevOps engineer

Task	Description	Skills required
Install additional software as necessary.	<p>If required, install <b>pgLoader</b> as a replacement for <b>SQL*Loader</b> in Oracle.</p> <pre>wget -O /etc/yum.repos.d/pgloader-ccl.repo https://dl.packager.io/srv/opf/pgloader-ccl/master/installer/el/7.repo yum install pgloader-ccl -y ln -s /opt/pgloader-ccl/bin/pgloader /usr/bin/</pre> <p>If you're calling any Java applications from Pro*C modules, install Java.</p> <pre>yum install java -y</pre> <p>Install <b>ant</b> to compile the Java code.</p> <pre>yum install ant -y</pre>	App developer, DevOps engineer

Task	Description	Skills required
Install the AWS CLI.	<p>Install the AWS CLI to run commands to interact with AWS services such as AWS Secrets Manager and Amazon Simple Storage Service (Amazon S3) from your applications.</p> <pre>cd /tmp/ curl "https://awscli.amazonaws.com/awscli-exe-linux-x86_64.zip" -o "awscliv2.zip" unzip awscliv2.zip ./aws/install -i /usr/local/aws-cli -b /usr/local/bin --update</pre>	App developer, DevOps engineer
Identify the programs to be converted.	Identify the applications that you want to convert from Pro*C to ECPG.	App developer, App owner

## Convert Pro\*C code to ECPG

Task	Description	Skills required
Remove unwanted headers.	Remove the include headers that are not required in PostgreSQL, such as <code>oci.h</code> , <code>oratypes</code> , and <code>sqllda</code> .	App owner, App developer
Update variable declarations.	Add EXEC SQL statements for all variable declarations	App developer, App owner

Task	Description	Skills required
	<p>that are used as host variables</p> <ul style="list-style-type: none"><li>•</li></ul> <p>Remove the EXEC SQL VAR declarations such as the following from your application.</p> <pre>EXEC SQL VAR query IS STRING(2048);</pre>	

Task	Description	Skills required
Update ROWNUM functionality.	<p>The ROWNUM function isn't available in PostgreSQL. Replace this with the ROW_NUMBER window function in SQL queries.</p> <p>Pro*C code:</p> <pre data-bbox="594 569 1029 1125">SELECT SUBSTR(RTRIM(FILE_NAME, '.txt'),12) INTO :gcplFileSeq FROM (SELECT       FILE_NAME       FROM DEMO_FILES_TABLE       WHERE FILE_NAME LIKE            '%POC%'       ORDER BY FILE_NAME DESC) FL2 WHERE ROWNUM &lt;=1 ORDER BY ROWNUM;</pre> <p>ECPG code:</p> <pre data-bbox="594 1236 1029 1845">SELECT SUBSTR(RTRIM(FILE_NAME, '.txt'),12) INTO :gcplFileSeq FROM (SELECT       FILE_NAME , ROW_NUMBER() OVER (ORDER BY       FILE_NAME DESC) AS       ROWNUM       FROM demo_schema.DEMO_FILES_TABLE       WHERE FILE_NAME LIKE            '%POC%'       ORDER BY FILE_NAME       DESC) FL2</pre>	App developer, App owner



Task	Description	Skills required
	<pre>WHERE ROWNUM &lt;=1 ORDER BY ROWNUM;</pre>	
Update function parameters to use alias variables.	<p>In PostgreSQL, function parameters can't be used as host variables. Overwrite them by using an alias variable.</p> <p>Pro*C code:</p> <pre>int processData(int referenceId){     EXEC SQL char     col_val[100];     EXEC SQL select     column_name     INTO :col_val from     table_name where     col=:referenceId; }</pre> <p>ECPG code:</p> <pre>int processData(int referenceIdParam){     EXEC SQL int reference     Id = referenceIdParam;     EXEC SQL char     col_val[100];     EXEC SQL select     column_name     INTO :col_val from     table_name where     col=:referenceId; }</pre>	App developer, App owner

Task	Description	Skills required
Update struct types.	<p>Define struct types in EXEC SQL BEGIN and END blocks with typedef if the struct type variables are used as host variables. If the struct types are defined in header (.h) files, include the files with EXEC SQL include statements.</p> <p>Pro*C code:</p> <p>Header file (demo.h)</p> <pre data-bbox="594 842 1027 1682"> struct s_partiti on_ranges { char sc_table_ group[31]; char sc_table_ name[31]; char sc_range_ value[10]; }; struct s_partiti on_ranges_ind { short ss_table_ group; short ss_table_ name; short ss_range_ value; }; </pre> <p>ECPG code:</p> <p>Header file (demo.h)</p>	App developer, App owner

Task	Description	Skills required
	<pre data-bbox="609 226 1027 1163"> EXEC SQL BEGIN DECLARE SECTION; typedef struct { char sc_table_ group[31]; char sc_table_ name[31]; char sc_range_ value[10]; } s_partition_ranges; typedef struct { short ss_table_ group; short ss_table_ name; short ss_range_ value; } s_partition_ranges _ind; EXEC SQL END DECLARE SECTION; </pre> <p data-bbox="591 1199 891 1234">Pro*C file (demo . pc)</p> <pre data-bbox="609 1276 1027 1671"> #include "demo.h" struct s_partiti on_ranges gc_partit ion_data[MAX_PART_ TABLE] ; struct s_partiti on_ranges_ind gc_partition_data_ ind[MAX_PART_TABLE] ; </pre> <p data-bbox="591 1707 886 1743">ECPG file (demo . pc)</p> <pre data-bbox="609 1785 1027 1873"> exec sql include "demo.h" </pre>	

Task	Description	Skills required
	<pre>EXEC SQL BEGIN DECLARE SECTION; s_partition_ranges gc_partition_data[ MAX_PART_TABLE] ; s_partition_ranges_ind gc_partition_data_ ind[MAX_PART_TABLE] ; EXEC SQL END DECLARE SECTION;</pre>	
<p>Modify logic to fetch from cursors.</p>	<p>To fetch multiple rows from cursors by using array variables, change the code to use FETCH FORWARD.</p> <p>Pro*C code:</p> <pre>EXEC SQL char aPoeFiles [MAX_FILES][FILENA ME_LENGTH]; EXEC SQL FETCH filename_ cursor into :aPoeFile s;</pre> <p>ECPG code:</p> <pre>EXEC SQL char aPoeFiles [MAX_FILES][FILENA ME_LENGTH]; EXEC SQL int fetchSize = MAX_FILES; EXEC SQL FETCH FORWARD :fetchSiz e filename_cursor into :aPoeFiles;</pre>	<p>App developer, App owner</p>

Task	Description	Skills required
Modify package calls that don't have return values.	<p>Oracle package functions that don't have return values should be called with an indicator variable. If your application includes multiple functions that have the same name or if the unknown type functions generate runtime errors, typecast the values to the data types.</p> <p>Pro*C code:</p> <pre data-bbox="594 806 1029 1402">void ProcessData (char  *data , int id) {     EXEC SQL EXECUTE         BEGIN          pkg_demo. process_data (:data, :id);          END;     END-EXEC; }</pre> <p>ECPG code:</p> <pre data-bbox="594 1514 1029 1845">void ProcessData (char *dataParam, int idParam ) {     EXEC SQL char  *data = dataParam;     EXEC SQL int id  = idParam;</pre>	App developer, App owner

Task	Description	Skills required
	<pre>EXEC SQL short rowInd; EXEC SQL short rowInd = 0; EXEC SQL SELECT pkg_demo.process_data ( inp_data =&gt; :data::te xt, inp_id =&gt; :id ) INTO :rowInd; }</pre>	

Task	Description	Skills required
Rewrite SQL_CURSOR variables.	<p>Rewrite the SQL_CURSOR variable and its implementation.</p> <p>Pro*C code:</p> <pre data-bbox="609 478 1027 1071"> /* SQL Cursor */ SQL_CURSOR demo_cursor; EXEC SQL   ALLOCATE :demo_cursor; EXEC SQL EXECUTE   BEGIN     pkg_demo.     get_cursor(       demo_cur=       &gt;:demo_cursor     );   END; END-EXEC; </pre> <p>ECPG code:</p> <pre data-bbox="609 1182 1027 1875"> EXEC SQL DECLARE   demo_cursor CURSOR FOR   SELECT     * from     pkg_demo.open_file   name_rc(     demo_cur=     &gt;refcursor   ); EXEC SQL char open_file   name_rcInd[100]; # As the below function   returns cursor_name   as # return we need to   use char[] type as   indicator. </pre>	App developer, App owner

Task	Description	Skills required
	<pre>EXEC SQL SELECT   pkg_demo.get_cursor (     demo_cur= &gt;'demo_cursor'   ) INTO :open_fil ename_rcInd;</pre>	
<p>Apply common migration patterns.</p>	<ul style="list-style-type: none"> <li>• Change SQL queries so they're compatible with PostgreSQL.</li> <li>• Move anonymous blocks, when they aren't supported in ECPG, to the database.</li> <li>• Remove dbms_application_info logic, which isn't supported by PostgreSQL.</li> <li>• Move EXEC SQL COMMIT statements after the cursor close. If you commit queries while in the loop to fetch the records from the cursor, the cursor is closed and a cursor doesn't exist error is displayed.</li> <li>• For information about handling exceptions in ECPG and error codes, see <a href="#">Error Handling</a> in the PostgreSQL documentation.</li> </ul>	<p>App developer, App owner</p>



Task	Description	Skills required
Enable debugging, if required.	To run the ECPG program in debug mode, add the following command inside the main function block.  <pre>ECPGdebug(1, stderr);</pre>	App developer, App owner

## Compile ECPG programs

Task	Description	Skills required
Create an executable file for ECPG.	If you have an embedded SQL C source file named <code>prog1.pgc</code> , you can create an executable program by using the following sequence of commands.  <pre>ecpg prog1.pgc cc -I/usr/local/pgsql/ include -c prog1.c cc -o prog1 prog1.o -L/ usr/local/pgsql/lib - lecpg</pre>	App developer, App owner
Create a make file for compilation.	Create a make file to compile the ECPG program, as shown in the following sample file.  <pre>CFLAGS ::= \$(CFLAGS) -I/ usr/pgsql-12/include - g -Wall LDFLAGS ::= \$(LDFLAGS ) -L/usr/pgsql-12/li b -Wl,-rpath,/usr/pg sql-12/lib</pre>	App developer, App owner

Task	Description	Skills required
	<pre>LDLIBS ::= \$(LDLIBS) - lecpg PROGRAMS = test .PHONY: all clean %.c: %.pgc     ecpg \$&lt; all: \$(PROGRAMS) clean:     rm -f \$(PROGRAM S) \$(PROGRAMS:%=%.c) \$(PROGRAMS:%=%.o)</pre>	

## Test the application

Task	Description	Skills required
Test the code.	Test the converted application code to make sure that it functions correctly.	App developer, App owner, Test engineer

## Related resources

- [ECPG - Embedded SQL in C](#) (PostgreSQL documentation)
- [Error Handling](#) (PostgreSQL documentation)
- [Why Use the Oracle Pro\\*C/C++ Precompiler](#) (Oracle documentation)

## Additional information

PostgreSQL has an embedded SQL precompiler, ECPG, which is equivalent to the Oracle Pro\*C precompiler. ECPG converts C programs that have embedded SQL statements to standard C code by replacing the SQL calls with special function calls. The output files can then be processed with any C compiler tool chain.

## Input and output files

ECPG converts each input file you specify on the command line to the corresponding C output file. If an input file name doesn't have a file extension, .pgc is assumed. The file's extension is replaced by .c to construct the output file name. However, you can override the default output file name by using the `-o` option.

If you use a dash (-) as the input file name, ECPG reads the program from standard input and writes to standard output, unless you override that by using the `-o` option.

## Header files

When the PostgreSQL compiler compiles the pre-processed C code files, it looks for the ECPG header files in the PostgreSQL `include` directory. Therefore, you might have to use the `-I` option to point the compiler to the correct directory (for example, `-I/usr/local/pgsql/include`).

## Libraries

Programs that use C code with embedded SQL have to be linked against the `libecpg` library. For example, you can use the linker options `-L/usr/local/pgsql/lib -lecpg`.

Converted ECPG applications call functions in the `libpq` library through the embedded SQL library (`ecpglib`), and communicate with the PostgreSQL server by using the standard frontend/backend protocol.

# Migrate virtual generated columns from Oracle to PostgreSQL

Created by Veeranjanyulu Grandhi (AWS), Rajesh Madiwale (AWS), and Ramesh Pathuri (AWS)

<b>Environment:</b> Production	<b>Source:</b> Oracle Database	<b>Target:</b> Amazon RDS for PostgreSQL or Aurora PostgreSQL-Compatible
<b>R Type:</b> Re-architect	<b>Workload:</b> Oracle	<b>Technologies:</b> Migration; Databases
<b>AWS services:</b> Amazon Aurora; Amazon RDS; AWS DMS		

## Summary

In version 11 and earlier, PostgreSQL doesn't provide a feature that is directly equivalent to an Oracle virtual column. Handling virtual generated columns while migrating from Oracle Database to PostgreSQL version 11 or earlier is difficult for two reasons:

- Virtual columns aren't visible during migration.
- PostgreSQL doesn't support the `generate` expression before version 12.

However, there are workarounds to emulate similar functionality. When you use AWS Database Migration Service (AWS DMS) to migrate data from Oracle Database to PostgreSQL version 11 and earlier, you can use trigger functions to populate the values in virtual generated columns. This pattern provides examples of Oracle Database and PostgreSQL code that you can use for this purpose. On AWS, you can use Amazon Relational Database Service (Amazon RDS) for PostgreSQL or Amazon Aurora PostgreSQL-Compatible Edition for your PostgreSQL database.

Starting with PostgreSQL version 12, generated columns are supported. Generated columns can either be calculated from other column values on the fly, or calculated and stored. [PostgreSQL generated columns](#) are similar to Oracle virtual columns.

## Prerequisites and limitations

### Prerequisites

- An active AWS account
- A source Oracle database
- Target PostgreSQL databases (on Amazon RDS for PostgreSQL or Aurora PostgreSQL-Compatible)
- [PL/pgSQL](#) coding expertise

### Limitations

- Applies only to PostgreSQL versions before version 12.
- Applies to Oracle Database version 11g or later.
- Virtual columns are not supported in data migration tools.
- Applies only to columns defined in the same table.
- If a virtual generated column refers to a deterministic user-defined function, it cannot be used as a partitioning key column.
- The output of the expression must be a scalar value. It cannot return an Oracle supplied datatype, a user-defined type, LOB, or LONG RAW.
- Indexes that are defined against virtual columns are equivalent to function-based indexes in PostgreSQL.
- Table statistics must be gathered.

### Tools

- [pgAdmin 4](#) is an open source management tool for PostgreSQL. This tool provides a graphical interface that simplifies the creation, maintenance, and use of database objects.
- [Oracle SQL Developer](#) is a free, integrated development environment for working with SQL in Oracle databases in both traditional and cloud deployments.

## Epics

### Create source and target database tables

Task	Description	Skills required
Create a source Oracle Database table.	<p>In Oracle Database, create a table with virtual generated columns by using the following statement.</p> <pre data-bbox="594 642 1027 1157">CREATE TABLE test.generated_column ( CODE NUMBER,   STATUS VARCHAR2(12)   DEFAULT 'PreOpen',   FLAG CHAR(1) GENERATED   ALWAYS AS (CASE   UPPER(STATUS) WHEN   'OPEN' THEN 'N' ELSE   'Y' END) VIRTUAL   VISIBLE );</pre> <p>In this source table, the data in the STATUS column is migrated through AWS DMS to the target database. The FLAG column, however, is populated by using generate by functionality, so this column isn't visible to AWS DMS during migration. To implement the functionality of generated by, you must use triggers and functions in the target database to populate the</p>	DBA, App developer

Task	Description	Skills required
	values in the FLAG column, as shown in the next epic.	
Create a target PostgreSQL table on AWS.	<p>Create a PostgreSQL table on AWS by using the following statement.</p> <pre data-bbox="597 506 1027 905">CREATE TABLE test.generated_column (     code integer not null,     status character varying(12) not null ,     flag character(1) );</pre> <p>In this table, the status column is a standard column. The flag column will be a generated column based on the data in the status column.</p>	DBA, App developer

## Create a trigger function to handle the virtual column in PostgreSQL

Task	Description	Skills required
Create a PostgreSQL trigger.	<p>In PostgreSQL, create a trigger.</p> <pre data-bbox="597 1629 1027 1885">CREATE TRIGGER tgr_gen_column AFTER INSERT OR UPDATE OF status ON test.generated_column FOR EACH ROW</pre>	DBA, App developer

Task	Description	Skills required
	<pre>EXECUTE FUNCTION test.tgf_gen_colu m();</pre>	



Task	Description	Skills required
Create a PostgreSQL trigger function.	<p>In PostgreSQL, create a function for the trigger. This function populates a virtual column that is inserted or updated by the application or AWS DMS, and validates the data.</p> <pre data-bbox="597 590 1027 1875">CREATE OR REPLACE FUNCTION test.tgf_ gen_column() RETURNS trigger AS \$VIRTUAL_ COL\$ BEGIN IF (TG_OP = 'INSERT') THEN IF (NEW.flag IS NOT NULL) THEN RAISE EXCEPTION 'ERROR: cannot insert into column "flag" USING DETAIL = 'Column "flag" is a generated column.'; END IF; END IF; IF (TG_OP = 'UPDATE') THEN IF (NEW.flag::VARCHAR ! = OLD.flag::varchar) THEN RAISE EXCEPTION 'ERROR: cannot update column "flag" USING DETAIL = 'Column "flag" is a generated column.'; END IF; END IF; IF TG_OP IN ('INSERT' , 'UPDATE') THEN</pre>	DBA, App developer

Task	Description	Skills required
	<pre> IF (old.flag is NULL)   OR (coalesce(old.stat us, '') != coalesce( new.status, '')) THEN UPDATE test.gene rated_column SET flag = (CASE   UPPER(status) WHEN   'OPEN' THEN 'N' ELSE   'Y' END) WHERE code = new.code; END IF; END IF; RETURN NEW; END \$VIRTUAL_COL\$ LANGUAGE plpgsql; </pre>	

## Test data migration by using AWS DMS

Task	Description	Skills required
Create a replication instance.	To create a replication instance, follow the <a href="#">instructions</a> in the AWS DMS documentation. The replication instance should be in the same virtual private cloud (VPC) as your source and target databases.	DBA, App developer
Create source and target endpoints.	To create the endpoints, follow the <a href="#">instructions</a> in the AWS DMS documentation.	DBA, App developer
Test the endpoint connections.	You can test the endpoint connections by specifying the	DBA, App developer

Task	Description	Skills required
	VPC and replication instance and choosing <b>Run test</b> .	
Create and start a full load task.	For instructions, see <a href="#">Creating a Task</a> and <a href="#">Full-load task settings</a> in the AWS DMS documentation.	DBA, App developer
Validate the data for the virtual column.	Compare the data in the virtual column in the source and target databases. You can validate the data manually or write a script for this step.	DBA, App developer

## Related resources

- [Getting started with AWS Database Migration Service](#) (AWS DMS documentation)
- [Using an Oracle database as a source for AWS DMS](#) (AWS DMS documentation)
- [Using a PostgreSQL database as a target for AWS DMS](#) (AWS DMS documentation)
- [Generated columns in PostgreSQL](#) (PostgreSQL documentation)
- [Trigger functions](#) (PostgreSQL documentation)
- [Virtual columns](#) in Oracle Database (Oracle documentation)

# Set up Oracle UTL\_FILE functionality on Aurora PostgreSQL-Compatible

Created by Rakesh Raghav (AWS) and anuradha chintha (AWS)

<b>Environment:</b> PoC or pilot	<b>Source:</b> Oracle	<b>Target:</b> Aurora PostgreSQL
<b>R Type:</b> Re-architect	<b>Workload:</b> Oracle	<b>Technologies:</b> Migration; Infrastructure; Databases
<b>AWS services:</b> Amazon S3; Amazon Aurora		

## Summary

As part of your migration journey from Oracle to Amazon Aurora PostgreSQL-Compatible Edition on the Amazon Web Services (AWS) Cloud, you might encounter multiple challenges. For example, migrating code that relies on the Oracle UTL\_FILE utility is always a challenge. In Oracle PL/SQL, the UTL\_FILE package is used for file operations, such as read and write, in conjunction with the underlying operating system. The UTL\_FILE utility works for both server and client machine systems.

Amazon Aurora PostgreSQL-Compatible is a managed database offering. Because of this, it isn't possible to access files on the database server. This pattern walks you through the integration of Amazon Simple Storage Service (Amazon S3) and Amazon Aurora PostgreSQL-Compatible to achieve a subset of UTL\_FILE functionality. Using this integration, we can create and consume files without using third-party extract, transform, and load (ETL) tools or services.

Optionally, you can set up Amazon CloudWatch monitoring and Amazon SNS notifications.

We recommend thoroughly testing this solution before implementing it in a production environment.

## Prerequisites and limitations

### Prerequisites

- An active AWS account
- AWS Database Migration Service (AWS DMS) expertise
- Expertise in PL/pgSQL coding
- An Amazon Aurora PostgreSQL-Compatible cluster
- An S3 bucket

## Limitations

This pattern doesn't provide the functionality to act as a replacement for the Oracle UTL\_FILE utility. However, the steps and sample code can be enhanced further to achieve your database modernization goals.

## Product versions

- Amazon Aurora PostgreSQL-Compatible Edition 11.9

## Architecture

### Target technology stack

- Amazon Aurora PostgreSQL-Compatible
- Amazon CloudWatch
- Amazon Simple Notification Service (Amazon SNS)
- Amazon S3

### Target architecture

The following diagram shows a high-level representation of the solution.

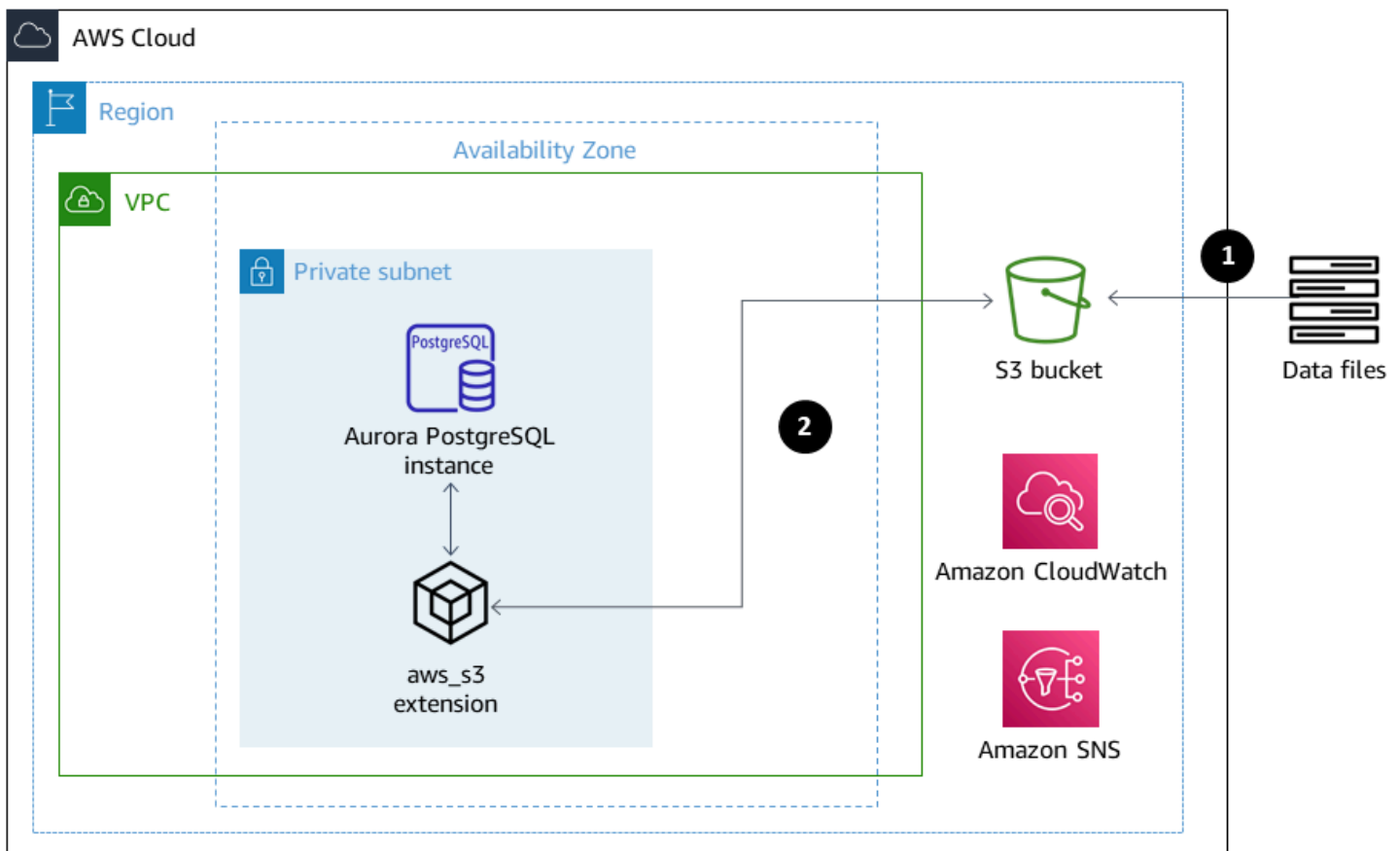

1. Files are uploaded from the application into the S3 bucket.
2. The `aws_s3` extension accesses the data, using PL/pgSQL, and uploads the data to Aurora PostgreSQL-Compatible.

## Tools

- [Amazon Aurora PostgreSQL-Compatible](#) – Amazon Aurora PostgreSQL-Compatible Edition is a fully managed, PostgreSQL-compatible, and ACID-compliant relational database engine. It combines the speed and reliability of high-end commercial databases with the cost-effectiveness of open-source databases.
- [AWS CLI](#) – The AWS Command Line Interface (AWS CLI) is a unified tool to manage your AWS services. With only one tool to download and configure, you can control multiple AWS services from the command line and automate them through scripts.
- [Amazon CloudWatch](#) – Amazon CloudWatch monitors Amazon S3 resources and use.

- [Amazon S3](#) – Amazon Simple Storage Service (Amazon S3) is storage for the internet. In this pattern, Amazon S3 provides a storage layer to receive and store files for consumption and transmission to and from the Aurora PostgreSQL-Compatible cluster.
- [aws\\_s3](#) – The `aws_s3` extension integrates Amazon S3 and Aurora PostgreSQL-Compatible.
- [Amazon SNS](#) – Amazon Simple Notification Service (Amazon SNS) coordinates and manages the delivery or sending of messages between publishers and clients. In this pattern, Amazon SNS is used to send notifications.
- [pgAdmin](#) – pgAdmin is an open-source management tool for Postgres. pgAdmin 4 provides a graphical interface for creating, maintaining, and using database objects.

## Code

To achieve the required functionality, the pattern creates multiple functions with naming similar to `UTL_FILE`. The *Additional information* section contains the code base for these functions.

In the code, replace `testaurorabucket` with the name of your test S3 bucket. Replace `us-east-1` with the AWS Region where your test S3 bucket is located.

## Epics

### Integrate Amazon S3 and Aurora PostgreSQL-Compatible

Task	Description	Skills required
Set up IAM policies.	Create AWS Identity and Access Management (IAM) policies that grant access to the S3 bucket and objects in it. For the code, see the <i>Additional information</i> section.	AWS administrator, DBA
Add Amazon S3 access roles to Aurora PostgreSQL.	Create two IAM roles: one role for read and one role for write access to Amazon S3. Attach the two roles to the Aurora PostgreSQL-Compatible cluster:	AWS administrator, DBA

Task	Description	Skills required
	<ul style="list-style-type: none"> <li>One role for the S3Export feature</li> <li>One role for the S3Import feature</li> </ul> <p>For more information, see the Aurora PostgreSQL-Compatible documentation on <a href="#">importing</a> and <a href="#">exporting</a> data to Amazon S3.</p>	

### Set up the extensions in Aurora PostgreSQL-Compatible

Task	Description	Skills required
Create the aws_commons extension.	The aws_commons extension is a dependency of the aws_s3 extension.	DBA, Developer
Create the aws_s3 extension.	The aws_s3 extension interacts with Amazon S3.	DBA, Developer

### Validate Amazon S3 and Aurora PostgreSQL-Compatible integration

Task	Description	Skills required
Test importing files from Amazon S3 into Aurora PostgreSQL.	To test importing files into Aurora PostgreSQL-Compatible, create a sample CSV file and upload it into the S3 bucket. Create a table definition based on the CSV file, and load the file	DBA, Developer



Task	Description	Skills required
	into the table by using the <code>aws_s3.table_import_from_s3</code> function.	
Test exporting files from Aurora PostgreSQL to Amazon S3.	To test exporting files from Aurora PostgreSQL-Compatible, create a test table, populate it with data, and then export the data by using the <code>aws_s3.query_export_to_s3</code> function.	DBA, Developer

### To mimic the UTL\_FILE utility, create wrapper functions

Task	Description	Skills required
Create the <code>utl_file_utility</code> schema.	The schema keeps the wrapper functions together. To create the schema, run the following command.  <pre>CREATE SCHEMA utl_file_utility;</pre>	DBA, Developer
Create the <code>file_type</code> type.	To create the <code>file_type</code> type, use the following code.  <pre>CREATE TYPE utl_file_utility.file_type AS (   p_path character varying(30),   p_file_name character varying);</pre>	DBA/Developer

Task	Description	Skills required
Create the init function.	The <code>init</code> function initializes common variables such as <code>bucket</code> or <code>region</code> . For the code, see the <i>Additional information</i> section.	DBA/Developer
Create the wrapper functions.	Create the wrapper functions <code>fopen</code> , <code>put_line</code> , and <code>fclose</code> . For code, see the <i>Additional information</i> section.	DBA, Developer

### Test the wrapper functions

Task	Description	Skills required
Test the wrapper functions in write mode.	To test the wrapper functions in write mode, use the code provided in the <i>Additional information</i> section.	DBA, Developer
Test the wrapper functions in append mode.	To test the wrapper functions in append mode, use the code provided in the <i>Additional information</i> section.	DBA, Developer

### Related resources

- [Amazon S3 integration](#)
- [Amazon S3](#)
- [Aurora](#)
- [Amazon CloudWatch](#)

- [Amazon SNS](#)

## Additional information

### Set up IAM policies

Create the following policies.

#### Policy name

#### JSON

S3IntRead

```
{
  "Version": "2012-10-17",
  "Statement": [
    {
      "Sid": "S3integrationtest",
      "Effect": "Allow",
      "Action": [
        "s3:GetObject",
        "s3:ListBucket"
      ],
      "Resource": [
        "arn:aws:s3:::testaurorabucket/*",
        "arn:aws:s3:::testaurorabucket"
      ]
    }
  ]
}
```

S3IntWrite

```
{
  "Version": "2012-10-17",
  "Statement": [
    {
      "Sid": "S3integrationtest",
      "Effect": "Allow",
      "Action": [
        "s3:PutObject",

```

```

        "s3:ListBucket"
    ],
    "Resource": [
        "arn:aws:s3:::testaurorabucket/
*",
        "arn:aws:s3:::test
aurorabucket"
    ]
}
}
}

```

## Create the init function

To initialize common variables, such as bucket or region, create the `init` function by using the following code.

```

CREATE OR REPLACE FUNCTION utl_file_utility.init(
)
RETURNS void
LANGUAGE 'plpgsql'

COST 100
VOLATILE
AS $BODY$
BEGIN
    perform set_config
    ( format( '%s.%s', 'UTL_FILE_UTILITY', 'region' )
    , 'us-east-1'::text
    , false );

    perform set_config
    ( format( '%s.%s', 'UTL_FILE_UTILITY', 's3bucket' )
    , 'testaurorabucket'::text
    , false );
END;
$BODY$;

```

## Create the wrapper functions

Create the `fopen`, `put_line`, and `fclose` wrapper functions.

### *fopen*

```

CREATE OR REPLACE FUNCTION utl_file_utility.fopen(
  p_file_name character varying,
  p_path character varying,
  p_mode character DEFAULT 'W'::bpchar,
  OUT p_file_type utl_file_utility.file_type)
RETURNS utl_file_utility.file_type
LANGUAGE 'plpgsql'

COST 100
VOLATILE
AS $BODY$
declare
  v_sql character varying;
  v_cnt_stat integer;
  v_cnt integer;
  v_tabname character varying;
  v_filewithpath character varying;
  v_region character varying;
  v_bucket character varying;

BEGIN
  /*initialize common variable */
  PERFORM utl_file_utility.init();
  v_region := current_setting( format( '%s.%s', 'UTL_FILE_UTILILITY', 'region' ) );
  v_bucket := current_setting( format( '%s.%s', 'UTL_FILE_UTILILITY', 's3bucket' ) );

  /* set tabname*/
  v_tabname := substring(p_file_name,1,case when strpos(p_file_name, '.') = 0 then
length(p_file_name) else strpos(p_file_name, '.') - 1 end );
  v_filewithpath := case when NULLif(p_path, '') is null then p_file_name else
concat_ws('/',p_path,p_file_name) end ;
  raise notice 'v_bucket %, v_filewithpath % , v_region %', v_bucket,v_filewithpath,
v_region;

  /* APPEND MODE HANDLING; RETURN EXISTING FILE DETAILS IF PRESENT ELSE CREATE AN
EMPTY FILE */
  IF p_mode = 'A' THEN
    v_sql := concat_ws('','create temp table if not exists ', v_tabname,' (col1
text)');
    execute v_sql;

    begin
      PERFORM aws_s3.table_import_from_s3

```

```

        ( v_tabname,
          '',
          'DELIMITER AS ''#''',
          aws_commons.create_s3_uri
        (      v_bucket,
              v_filewithpath ,
              v_region)
        );
exception
  when others then
    raise notice 'File load issue ,%',sqlerrm;
    raise;
end;
execute concat_ws('','select count(*) from ',v_tabname) into v_cnt;

IF v_cnt > 0
then
  p_file_type.p_path := p_path;
  p_file_type.p_file_name := p_file_name;
else
  PERFORM aws_s3.query_export_to_s3('select ''''',
    aws_commons.create_s3_uri(v_bucket, v_filewithpath,
v_region)
    );

  p_file_type.p_path := p_path;
  p_file_type.p_file_name := p_file_name;
end if;
v_sql := concat_ws('','drop table ', v_tabname);
execute v_sql;
ELSEIF p_mode = 'W' THEN
  PERFORM aws_s3.query_export_to_s3('select ''''',
    aws_commons.create_s3_uri(v_bucket, v_filewithpath,
v_region)
    );

  p_file_type.p_path := p_path;
  p_file_type.p_file_name := p_file_name;
END IF;

EXCEPTION
  when others then
    p_file_type.p_path := p_path;
    p_file_type.p_file_name := p_file_name;
    raise notice 'fopenerror,%',sqlerrm;

```

```

        raise;
END;
$BODY$;

```

### *put\_line*

```

CREATE OR REPLACE FUNCTION utl_file_utility.put_line(
    p_file_name character varying,
    p_path character varying,
    p_line text,
    p_flag character DEFAULT 'W'::bpchar)
    RETURNS boolean
    LANGUAGE 'plpgsql'

    COST 100
    VOLATILE
AS $BODY$
/*****
 * Write line, p_line in windows format to file, p_fp - with carriage return
 * added before new line.
 *****/
declare
    v_sql varchar;
    v_ins_sql varchar;
    v_cnt INTEGER;
    v_filewithpath character varying;
    v_tabname character varying;
    v_bucket character varying;
    v_region character varying;

BEGIN
    PERFORM utl_file_utility.init();

/* check if temp table already exist */

    v_tabname := substring(p_file_name,1,case when strpos(p_file_name, '.') = 0 then
length(p_file_name) else strpos(p_file_name, '.') - 1 end );

    v_sql := concat_ws('','select count(1) FROM pg_catalog.pg_class c LEFT JOIN
pg_catalog.pg_namespace n ON n.oid = c.relnamespace where n.nspname like 'pg_temp_
%'
', ' AND pg_catalog.pg_table_is_visible(c.oid) AND
Upper(relname) = Upper( '''

```

```

        , v_tabname ,'' ) ');

execute v_sql into v_cnt;

IF v_cnt = 0 THEN
    v_sql := concat_ws('','create temp table ',v_tabname,' (col text)');
    execute v_sql;
    /* CHECK IF APPEND MODE */
    IF upper(p_flag) = 'A' THEN
        PERFORM utl_file_utility.init();
        v_region := current_setting( format( '%s.%s', 'UTL_FILE_UTILITY',
'region' ) );
        v_bucket := current_setting( format( '%s.%s', 'UTL_FILE_UTILITY',
's3bucket' ) );

        /* set tabname*/
        v_filewithpath := case when NULLif(p_path,'') is null then p_file_name else
concat_ws('/',p_path,p_file_name) end ;

        begin
            PERFORM aws_s3.table_import_from_s3
                ( v_tabname,
                  '',
                  'DELIMITER AS '#'',
                  aws_commons.create_s3_uri
                    ( v_bucket,
                      v_filewithpath,
                      v_region
                    )
                );
        exception
            when others then
                raise notice 'Error Message : %',sqlerrm;
                raise;
        end;
    END IF;
END IF;
/* INSERT INTO TEMP TABLE */
v_ins_sql := concat_ws('','insert into ',v_tabname,' values('',p_line,'')');
execute v_ins_sql;
RETURN TRUE;
exception
    when others then
        raise notice 'Error Message : %',sqlerrm;
        raise;

```



```
END;
$BODY$;
```

## *fclose*

```
CREATE OR REPLACE FUNCTION utl_file_utility.fclose(
  p_file_name character varying,
  p_path character varying)
  RETURNS boolean
  LANGUAGE 'plpgsql'

  COST 100
  VOLATILE
AS $BODY$
DECLARE
  v_filewithpath character varying;
  v_bucket character varying;
  v_region character varying;
  v_tabname character varying;
  v_sql character varying;
BEGIN
  PERFORM utl_file_utility.init();

  v_region := current_setting( format( '%s.%s', 'UTL_FILE_UTILITY', 'region' ) );
  v_bucket := current_setting( format( '%s.%s', 'UTL_FILE_UTILITY', 's3bucket' ) );

  v_tabname := substring(p_file_name,1,case when strpos(p_file_name, '.') = 0 then
length(p_file_name) else strpos(p_file_name, '.') - 1 end );
  v_filewithpath := case when NULLif(p_path, '') is null then p_file_name else
concat_ws('/', p_path, p_file_name) end ;

  raise notice 'v_bucket %, v_filewithpath % , v_region %', v_bucket, v_filewithpath,
v_region ;

  /* exporting to s3 */
  perform aws_s3.query_export_to_s3
    (concat_ws('', 'select * from ', v_tabname, ' order by ctid asc'),
     aws_commons.create_s3_uri(v_bucket, v_filewithpath, v_region)
    );
  v_sql := concat_ws('', 'drop table ', v_tabname);
  execute v_sql;
  RETURN TRUE;
EXCEPTION
```

```
        when others then
            raise notice 'error fclose %',sqlerrm;
            RAISE;
    END;
$BODY$;
```

## Test your setup and wrapper functions

Use the following anonymous code blocks to test your setup.

### *Test the write mode*

The following code writes a file named `s3inttest` in the S3 bucket.

```
do $$
declare
l_file_name varchar := 's3inttest' ;
l_path varchar := 'integration_test' ;
l_mode char(1) := 'W';
l_fs utl_file_utility.file_type ;
l_status boolean;

begin
select * from
utl_file_utility.fopen( l_file_name, l_path , l_mode ) into l_fs ;
raise notice 'fopen : l_fs : %', l_fs;

select * from
utl_file_utility.put_line( l_file_name, l_path , 'this is test file:in s3bucket: for
test purpose', l_mode ) into l_status ;
raise notice 'put_line : l_status %', l_status;

select * from utl_file_utility.fclose( l_file_name , l_path ) into l_status ;
raise notice 'fclose : l_status %', l_status;

end;
$$
```

### *Test the append mode*

The following code appends lines onto the `s3inttest` file that was created in the previous test.

```
do $$
```

```
declare
l_file_name varchar := 's3intttest' ;
l_path varchar := 'integration_test' ;
l_mode char(1) := 'A';
l_fs utl_file_utility.file_type ;
l_status boolean;

begin
select * from
utl_file_utility.fopen( l_file_name, l_path , l_mode ) into l_fs ;
raise notice 'fopen : l_fs : %', l_fs;

select * from
utl_file_utility.put_line( l_file_name, l_path , 'this is test file:in s3bucket: for
test purpose : append 1', l_mode ) into l_status ;
raise notice 'put_line : l_status %', l_status;

select * from
utl_file_utility.put_line( l_file_name, l_path , 'this is test file:in s3bucket : for
test purpose : append 2', l_mode ) into l_status ;
raise notice 'put_line : l_status %', l_status;

select * from utl_file_utility.fclose( l_file_name , l_path ) into l_status ;
raise notice 'fclose : l_status %', l_status;

end;
$$
```

## Amazon SNS notifications

Optionally, you can set up Amazon CloudWatch monitoring and Amazon SNS notifications on the S3 bucket. For more information, see [Monitoring Amazon S3](#) and [Setting up Amazon SNS Notifications](#).

# Validate database objects after migrating from Oracle to Amazon Aurora PostgreSQL

Created by Venkatramana Chintha (AWS) and Eduardo Valentim (AWS)

<b>R Type:</b> Re-architect	<b>Source:</b> Relational	<b>Target:</b> Amazon Aurora PostgreSQL, Amazon RDS for PostgreSQL
<b>Created by:</b> AWS	<b>Environment:</b> PoC or pilot	<b>Technologies:</b> Databases; Migration
<b>Workload:</b> Oracle	<b>AWS services:</b> Amazon Aurora	

## Summary

This pattern describes a step-by-step approach to validate objects after migrating an Oracle database to Amazon Aurora PostgreSQL-Compatible Edition.

This pattern outlines usage scenarios and steps for database object validation; for more detailed information, see [Validating database objects after migration using AWS SCT and AWS DMS](#) on the [AWS Database blog](#).

## Prerequisites and limitations

### Prerequisites

- An active AWS account.
- An on-premises Oracle database that was migrated to an Aurora PostgreSQL-Compatible database.
- Sign-in credentials that have the [AmazonRDSDDataFullAccess](#) policy applied, for the Aurora PostgreSQL-Compatible database.
- This pattern uses the [query editor for Aurora Serverless DB clusters](#), which is available in the Amazon Relational Database Service (Amazon RDS) console. However, you can use this pattern with any other query editor.

## Limitations

- Oracle SYNONYM objects are not available in PostgreSQL but can be partially validated through **views** or SET search\_path queries.
- The Amazon RDS query editor is available only in [certain AWS Regions and for certain MySQL and PostgreSQL versions](#).

## Architecture

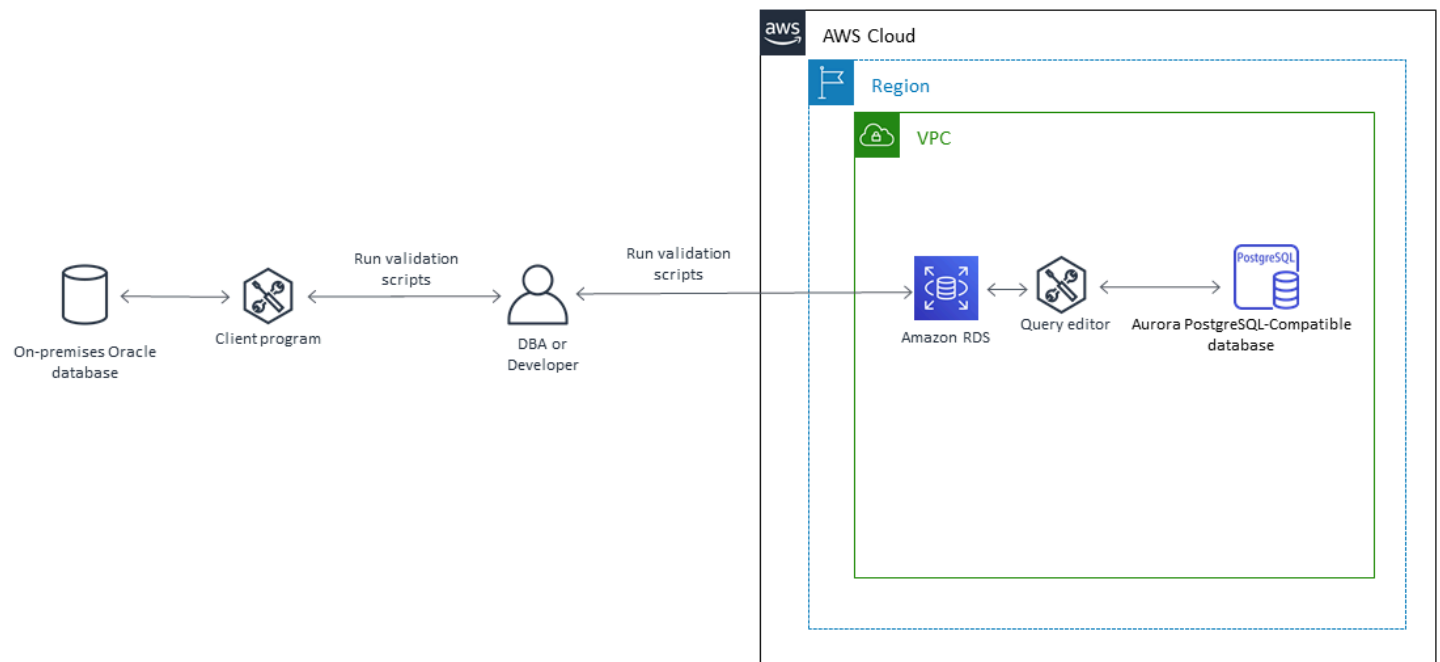

## Tools

### Tools

- [Amazon Aurora PostgreSQL-Compatible Edition](#) – Aurora PostgreSQL-Compatible is a fully managed, PostgreSQL-compatible, and ACID-compliant relational database engine that combines the speed and reliability of high-end commercial databases with the simplicity and cost-effectiveness of open-source databases.
- [Amazon RDS](#) – Amazon Relational Database Service (Amazon RDS) makes it easier to set up, operate, and scale a relational database in the AWS Cloud. It provides cost-efficient, resizable capacity for an industry-standard relational database and manages common database administration tasks.

- [Query Editor for Aurora Serverless](#) – Query editor helps you run SQL queries in the Amazon RDS console. You can run any valid SQL statement on the Aurora Serverless DB cluster, including data manipulation and data definition statements.

To validate the objects, use the full scripts in the "Object validation scripts" file in the "Attachments" section. Use the following table for reference.

<b>Oracle object</b>	<b>Script to use</b>
Packages	Query 1
Tables	Query 3
Views	Query 5
Sequences	Query 7
Triggers	Query 9
Primary keys	Query 11
Indexes	Query 13
Check constraints	Query 15
Foreign keys	Query 17
<b>PostgreSQL object</b>	<b>Script to use</b>
Packages	Query 2
Tables	Query 4
Views	Query 6
Sequences	Query 8
Triggers	Query 10

Primary keys	Query 12
Indexes	Query 14
Check constraints	Query 16
Foreign keys	Query 18

## Epics

### Validate objects in the source Oracle database

Task	Description	Skills required
Run the “packages” validation query in the source Oracle database.	Download and open the “Object validation scripts” file from the “Attachments” section. Connect to the source Oracle database through your client program. Run the “Query 1” validations script from the “Object validation scripts” file. Important: Enter your Oracle user name instead of “your_schema” in the queries. Make sure you record your query results.	Developer, DBA
Run the “tables” validation query.	Run the “Query 3” script from the “Object validation scripts” file. Make sure you record your query results.	Developer, DBA
Run the “views” validation query.	Run the “Query 5” script from the “Object validation scripts” file. Make sure you record your query results.	Developer, DBA

Task	Description	Skills required
Run the “sequences” count validation.	Run the “Query 7” script from the “Object validation scripts” file. Make sure you record your query results.	Developer, DBA
Run the “triggers” validation query.	Run the “Query 9” script from the “Object validation scripts” file. Make sure you record your query results.	Developer, DBA
Run the “primary keys” validation query.	Run the “Query 11” script from the “Object validation scripts” file. Make sure you record your query results.	Developer, DBA
Run the “indexes” validation query.	Run the “Query 13” validation script from the “Object validation scripts” file. Make sure you record your query results.	Developer, DBA
Run the “check constraints” validation query.	Run the “Query 15” script from the “Object validation scripts” file. Make sure you record your query results.	Developer, DBA
Run the “foreign keys” validation query.	Run the “Query 17” validation script from the “Object validation scripts” file. Make sure you record your query results.	Developer, DBA



## Validate objects in the target Aurora PostgreSQL-Compatible database

Task	Description	Skills required
Connect to the target Aurora PostgreSQL-Compatible database by using the query editor.	Sign in to the AWS Management Console and open the Amazon RDS console. In the upper-right corner, choose the AWS Region in which you created the Aurora PostgreSQL-Compatible database. In the navigation pane, choose "Databases," and choose the target Aurora PostgreSQL-Compatible database. In "Actions," choose "Query." Important: If you haven't connected to the database before, the "Connect to database" page opens. You then need to enter your database information, such as user name and password.	Developer, DBA
Run the "packages" validation query.	Run the "Query 2" script from the "Object validation scripts" file in the "Attachments" section. Make sure you record your query results.	Developer, DBA
Run the "tables" validation query.	Return to the query editor for the Aurora PostgreSQL-Compatible database, and run the "Query 4" script from the "Object validation scripts"	Developer, DBA

Task	Description	Skills required
	file. Make sure you record your query results.	
Run the “views” validation query.	Return to the query editor for the Aurora PostgreSQL-Compatible database, and run the “Query 6” script from the “Object validation scripts” file. Make sure you record your query results.	Developer, DBA
Run the “sequences” count validation.	Return to the query editor for the Aurora PostgreSQL-Compatible database, and run the “Query 8” script from the “Object validation scripts” file. Make sure you record your query results.	Developer, DBA
Run the “triggers” validation query.	Return to the query editor for the Aurora PostgreSQL-Compatible database, and run the “Query 10” script from the “Object validation scripts” file. Make sure you record your query results.	Developer, DBA
Run the “primary keys” validation query.	Return to the query editor for the Aurora PostgreSQL-Compatible database, and run the “Query 12” script from the “Object validation scripts” file. Make sure you record your query results.	Developer, DBA

Task	Description	Skills required
Run the “indexes” validation query.	Return to the query editor for the Aurora PostgreSQL-Compatible database, and run the “Query 14” script from the “Object validation scripts” file. Make sure you record your query results.	Developer, DBA
Run the “check constraints” validation query.	Run the “Query 16” script from the “Object validation scripts” file. Make sure you record your query results.	Developer, DBA
Run the “foreign keys” validation query.	Run the “Query 18” validation script from the “Object validation scripts” file. Make sure you record your query results.	Developer, DBA

### Compare source and target database validation records

Task	Description	Skills required
Compare and validate both query results.	Compare the query results of the Oracle and Aurora PostgreSQL-Compatible databases to validate all objects. If they all match, then all objects have been successfully validated.	Developer, DBA

### Related resources

- [Validating database objects after a migration using AWS SCT and AWS DMS](#)

- [Amazon Aurora Features: PostgreSQL-Compatible Edition](#)

## Attachments

To access additional content that is associated with this document, unzip the following file:

[attachment.zip](#)

# Rehost

## Topics

- [Accelerate the discovery and migration of Microsoft workloads to AWS](#)
- [Automate pre-workload ingestion activities for AWS Managed Services on Windows](#)
- [Create an approval process for firewall requests during a rehost migration to AWS](#)
- [Ingest and migrate EC2 Windows instances into an AWS Managed Services account](#)
- [Migrate Db2 for LUW to Amazon EC2 by using log shipping to reduce outage time](#)
- [Migrate Db2 for LUW to Amazon EC2 with high availability disaster recovery](#)
- [Migrate VMware VMs with HCX Automation by using PowerCLI](#)
- [Migrate an F5 BIG-IP workload to F5 BIG-IP VE on the AWS Cloud](#)
- [Migrate an on-premises Go web application to AWS Elastic Beanstalk by using the binary method](#)
- [Migrate an on-premises SFTP server to AWS using AWS Transfer for SFTP](#)
- [Migrate an on-premises VM to Amazon EC2 by using AWS Application Migration Service](#)
- [Migrate small sets of data from on premises to Amazon S3 using AWS SFTP](#)
- [Migrate from Oracle GlassFish to AWS Elastic Beanstalk](#)
- [Migrate an on-premises Oracle database to Oracle on Amazon EC2](#)
- [Migrate an on-premises Oracle database to Amazon EC2 by using Oracle Data Pump](#)
- [Migrate an on-premises SAP ASE database to Amazon EC2](#)
- [Migrate an on-premises Microsoft SQL Server database to Amazon EC2](#)
- [Migrate an on-premises MySQL database to Amazon EC2](#)
- [Reduce homogeneous SAP migration cutover time by using Application Migration Service](#)
- [Rehost on-premises workloads in the AWS Cloud: migration checklist](#)
- [Set up Multi-AZ infrastructure for a SQL Server Always On FCI by using Amazon FSx](#)
- [Use BMC Discovery queries to extract migration data for migration planning](#)

# Accelerate the discovery and migration of Microsoft workloads to AWS

*Created by Ali Alzand*

<b>Environment:</b> Production	<b>Source:</b> Microsoft workload running either on-premises or other cloud service providers	<b>Target:</b> Amazon EC2 Windows
<b>R Type:</b> Rehost	<b>Workload:</b> Microsoft	<b>Technologies:</b> Migration
<b>AWS services:</b> Amazon EC2		

## Summary

This pattern shows you how to use the [Migration Validator Toolkit PowerShell module](#) to discover and migrate your Microsoft workloads to AWS. The module works by performing multiple checks and validations for common tasks associated with any Microsoft workload. For example, the module checks for instances that might have multiple disks attached to it or instances that use many IP addresses. For a full list of checks that the module can perform, see the [Checks](#) section on the module's GitHub page.

The Migration Validator Toolkit PowerShell module can help your organization reduce the time and effort involved in discovering what applications and services are running on your Microsoft workloads. The module can also help you identify the configurations of your workloads so that you can find out if your configurations are supported on AWS. The module also provides recommendations for next steps and mitigation actions, so that you can avoid any misconfigurations before, during, or after your migration.

## Prerequisites and limitations

### Prerequisites

- Local administrator account
- PowerShell 4.0

### Limitations

- Works only on Microsoft Windows Server 2012 R2 or later

## Tools

### Tools

- PowerShell 4.0

### Code repository

The Migration Validator Toolkit PowerShell module for this pattern is available in the GitHub [migration-validator-toolkit-for-microsoft-workloads](#) repository.

## Epics

### Run the Migration Validator Toolkit PowerShell module on a single target

Task	Description	Skills required
Download, extract, import, and invoke the module.	<p>Choose one of the following methods to download and deploy the module:</p> <ul style="list-style-type: none"><li>• Run the PowerShell script</li><li>• Download and extract the .zip file</li><li>• Clone the GitHub repository</li></ul> <p><b>Run the PowerShell script</b></p> <p>In PowerShell, run the following example code:</p> <pre>#MigrationValidato rToolkit \$uri = 'https:// github.com/aws-sam ples/migration-val</pre>	System Administrator

Task	Description	Skills required
	<pre> idator-toolkit-for- microsoft-workloads/ archive/refs/heads/ main.zip' \$destination = (Get- Location).Path if ((Test-Path -Path "\$destination\Migr ationValidatorTool kit.zip" -PathType Leaf) -or (Test-Path - Path "\$destination\Migr ationValidatorTool kit")) {     write-host "File \$destination\Migra tionValidatorToolk it.zip or folder \$destination\Migra tionValidatorToolkit found, exiting" }else {     Write-host "Enable TLS 1.2 for this PowerShell session only."     [Net.ServicePointM anager]::SecurityP rotocol = [Net.Secu rityProtocolType]: :Tls12     \$webClient = New-Object System.Ne t.WebClient     Write-host "Downloading Migration ValidatorToolkit.zip"     \$webClient.Downloa dFile(\$uri, "\$destina tion\MigrationVali datorToolkit.zip") </pre>	



Task	Description	Skills required
	<pre data-bbox="592 210 1031 1417"> Write-host "MigrationValidatorToolkit.zip download successfully" Add-Type -Assembly "system.io.compression.filesystem" [System.IO.Compression.ZipFile]::ExtractToDirectory("\$destination\MigrationValidatorToolkit.zip", "\$destination\MigrationValidatorToolkit") Write-host "Extracting MigrationValidatorToolkit.zip complete successfully" Import-Module "\$destination\MigrationValidatorToolkit\migration-validator-toolkit-for-microsoft-workloads-main\MigrationValidatorToolkit.psm1"; Invoke-MigrationValidatorToolkit } </pre> <p data-bbox="592 1459 1031 1638">The code downloads the module from a .zip file. Then, the code extracts, imports, and invokes the module.</p> <p data-bbox="592 1680 1031 1753"><b>Download and extract the .zip file</b></p>	

Task	Description	Skills required
	<ol style="list-style-type: none"><li>1. Download the <a href="#">.zip file</a> (download).</li><li>2. Extract the .zip file.</li><li>3. Follow the steps in the <i>Invoke the module manually</i> story of this guide.</li></ol> <p><b>Clone the GitHub repository</b></p> <ol style="list-style-type: none"><li>1. To clone the GitHub <a href="#">migration-validator-toolkit-for-microsoft-workloads</a> repository, run the following Git command in a terminal window:</li></ol> <pre data-bbox="630 1016 1029 1297">git clone https://github.com/aws-samples/migration-validator-toolkit-for-microsoft-workloads.git</pre> <ol style="list-style-type: none"><li>2. Follow the steps in the <i>Invoke the module manually</i> story of this guide.</li></ol>	

Task	Description	Skills required
Invoke the module manually.	<ol style="list-style-type: none"><li>1. Go to the directory where the downloaded module is stored.</li><li>2. To generate the output of your choice, run one of the following commands as an administrator in PowerShell:</li></ol> <p><a href="#">Format-Table</a> format:</p> <pre>Import-Module .\MigrationValidatorToolkit.psm1;Invoke-MigrationValidatorToolkit</pre> <p><a href="#">Format-List</a> format:</p> <pre>Import-Module .\MigrationValidatorToolkit.psm1;Invoke-MigrationValidatorToolkit -List</pre> <p><a href="#">Out-GridView</a> format:</p> <pre>Import-Module .\MigrationValidatorToolkit.psm1;Invoke-MigrationValidatorToolkit -GridView</pre> <p><a href="#">ConvertTo-Csv</a> format:</p> <pre>Import-Module .\MigrationValidatorToolkit</pre>	System Administrator

Task	Description	Skills required
	<pre>.psm1;Invoke-MigrationValidatorToolkit -csv</pre>	

## Run the Migration Validator Toolkit PowerShell module on multiple targets

Task	Description	Skills required
Download the .zip file or clone the GitHub repository.	<p>Choose one of the following options:</p> <ul style="list-style-type: none"> <li>Download the <a href="#">zip file</a>. (download).</li> <li>To clone the GitHub <a href="#">migration-validator-toolkit-for-microsoft-workloads</a> repository, run the following Git command in a terminal window:</li> </ul> <pre>git clone https://github.com/aws-samples/migration-validator-toolkit-for-microsoft-workloads.git</pre>	System Administrator
Update the server.csv list.	<p>If you downloaded the .zip file, follow these steps:</p> <ol style="list-style-type: none"> <li>Extract the .zip file.</li> <li>Go to the MigrationValidatorToolkit\Inputs\ directory.</li> </ol>	System Administrator

Task	Description	Skills required
<p>Invoke the module.</p>	<p>3. Update <code>serverlist.csv</code> with the host name of your target computers.</p> <p>You can use any computer within the domain that uses a domain user that has administrator access to target computers.</p> <ol style="list-style-type: none"> <li>1. Download the source code as a .zip file and extract the file.</li> <li>2. As an administrator in PowerShell, run the following command:</li> </ol> <pre data-bbox="594 1062 1029 1262">Import-Module .\MigrationValidatorToolkit.psm1;Invoke-DomainComputers</pre> <p>The output .csv file is saved in <code>MigrationValidatorToolkit\Outputs\folder</code> with the prefix name <code>DomainComputers_MigrationAutomations_YYYY-MM-DDTHH-MM-SS</code> .</p>	<p>System Administrator</p>

## Troubleshooting

Issue	Solution
MigrationValidatorToolkit writes information about executions, commands, and errors to log files on the running host.	You can view log files manually in the following location: <ol style="list-style-type: none"><li>1. Go to the MigrationValidatorToolkit\logs\ directory.</li><li>2. Locate the log file. The format of the log file name is: ComputerName_MigrationValidatorToolkit_YYYY-MM-SSTHH-MM-SS.log</li></ol>

### Related resources

- [Options, tools, and best practices for migrating Microsoft workloads to AWS](#) (AWS Prescriptive Guidance)
- [Microsoft migration patterns](#) (AWS Prescriptive Guidance)
- [Free Cloud Migration Services on AWS](#) (AWS documentation)
- [Predefined post-launch actions](#) (Application marketing documentation)

### Additional information

#### Frequently asked questions

*Where can I run the Migration Validator Toolkit PowerShell module?*

You can run the module on Microsoft Windows Server 2012 R2 or later.

*When do I run this module?*

We recommend that you run the module during the [assess phase](#) of the migration journey.

*Does the module modify my existing servers?*

No. All actions in this module are read-only.

### *How long does it take to run the module?*

It typically takes 1–5 minutes to run the module, but it depends on the resource allocation of your server.

### *What permissions does the module need to run?*

You must run the module from a local administrator account.

### *Can I run the module on physical servers?*

Yes, as long as the operating system is Microsoft Windows Server 2012 R2 or later.

### *How do I run the module at scale for multiple servers?*

To run the module on multiple domain-joined computers at scale, follow the steps in the *Run the Migration Validator Toolkit PowerShell module on multiple targets* epic of this guide. For non domain-joined computers, use a remote invocation or run the module locally by following the steps in the *Run the Migration Validator Toolkit PowerShell module on a single target* epic of this guide.

# Automate pre-workload ingestion activities for AWS Managed Services on Windows

Created by Jacob Zhang (AWS), Calvin Yeh (AWS), and Dwayne Bordelon (AWS)

<b>Code repository:</b> <a href="#">GitHub</a>	<b>Environment:</b> Production	<b>Source:</b> Windows Servers
<b>Target:</b> AWS Managed Services	<b>R Type:</b> Rehost	<b>Technologies:</b> Migration

**AWS services:** AWS CloudFormation; AWS Managed Services; AWS Systems Manager; Amazon S3

## Summary

On the Amazon Web Services (AWS) Cloud, AWS Managed Services (AMS) uses AMS workload ingest (WIGS) to move existing workloads into an AMS managed VPC. This pattern describes a solution to automate common pre-workload ingestion activities, such as upgrading .NET and Windows PowerShell and running Windows WIGS pre-ingestion validation maintained by AMS. The pattern also provides a unified user interface for the run results. It packages an AWS Systems Manager Command document, which performs the pre-ingestion activities, into an AWS CloudFormation template. The template can be deployed repeatedly without requiring access to Systems Manager itself or conflicting with automations from AMS.

## Business background

Migrations to AMS require the provision of new Amazon Elastic Compute Cloud (Amazon EC2) instances using AMS managed Amazon Machine Images (AMIs) that include AMS components. Any workloads or applications running in existing data centers must be redeployed to fresh EC2 instances launched from these AMS AMIs. To avoid the potentially massive amount of manual work during the process, the AMS team built the AMS workload ingest (WIGS) workflow to onboard your custom images to AMS.

Windows instances must satisfy a few prerequisites before the WIGS process takes place. Windows PowerShell scripts are usually used to perform the necessary preparations (WIGS prep) and check if



the instances are ready for WIGs (WIGS pre-ingestion validation). The prep and validation processes require an engineer to spend 15–30 minutes on each server, manually logging in and running the scripts one by one.

## Business driver

Traditionally, using Systems Manager, you can automate operational tasks such as running Windows PowerShell scripts. However, because of elevated risks and frequent conflicts between automations from AMS and those from the users, AMS does not usually grant its users access to Systems Manager.

For mass migrations using AWS Application Migration Service (AWS MGN), Windows PowerShell scripts in the `C:\Program Files (x86)\AWS Replication Agent\post_launch` folder usually run automatically when a test or cutover instance is launched. However, these scripts, if run immediately during an instance launch, frequently conflict with automations from AMS. As a result, the launch might fail without providing the run results that you need to troubleshoot the failure.

This pattern tackles these problems and provides a working automated solution.

## Prerequisites and limitations

### Prerequisites

- An active AWS account with AMS onboarding completed.
- An Amazon Simple Storage Service (Amazon S3) bucket in the AWS account. If there is no S3 bucket over which you have control in the account, use a request for change (RFC) to create one.
- The PreWIGs\_CFN.json template downloaded from the [ams-auto-prewigs-windows](#) repository.
- A server to which you apply this pattern must meet the following requirements:
  - Run Windows Server 2012 or later.
  - Be launched or ready to launch in the sandbox VPC migration subnet.
  - Have an AWS Systems Manager Agent (SSM Agent) installed.
  - Have an AWS Identity and Access Management (IAM) instance profile attached. The instance profile must have permissions to download files from S3 buckets in the same AWS account. An instance profile that satisfies the above-mentioned requirement is usually already established during earlier setups of a migration.
- Be viewable from AWS Systems Manager Fleet Manager.

## Limitations

- Pre-WIGS activities vary depending on your environment and business requirements. You might need to make minor modifications to this pattern to suit your specific needs.

## Product versions

- The pattern is tested with Windows Server 2012, 2012 R2, 2016, and 2019. It theoretically works with later Windows versions. It does not work with earlier Windows versions.

## Architecture

The architecture diagram shows the following:

1. A sandbox VPC with a migration subnet containing servers that have not been prepped.
2. The S3 bucket that stores scripts that are used by the CloudFormation template.
3. The CloudFormation template deploys the Systems Manager Command document. The process iterates until the steps complete.
4. The instances are prepped and RFCs for WIGS are made.
5. In the AMS managed VPC, the AMS managed subnet contains the servers after workload ingestion.

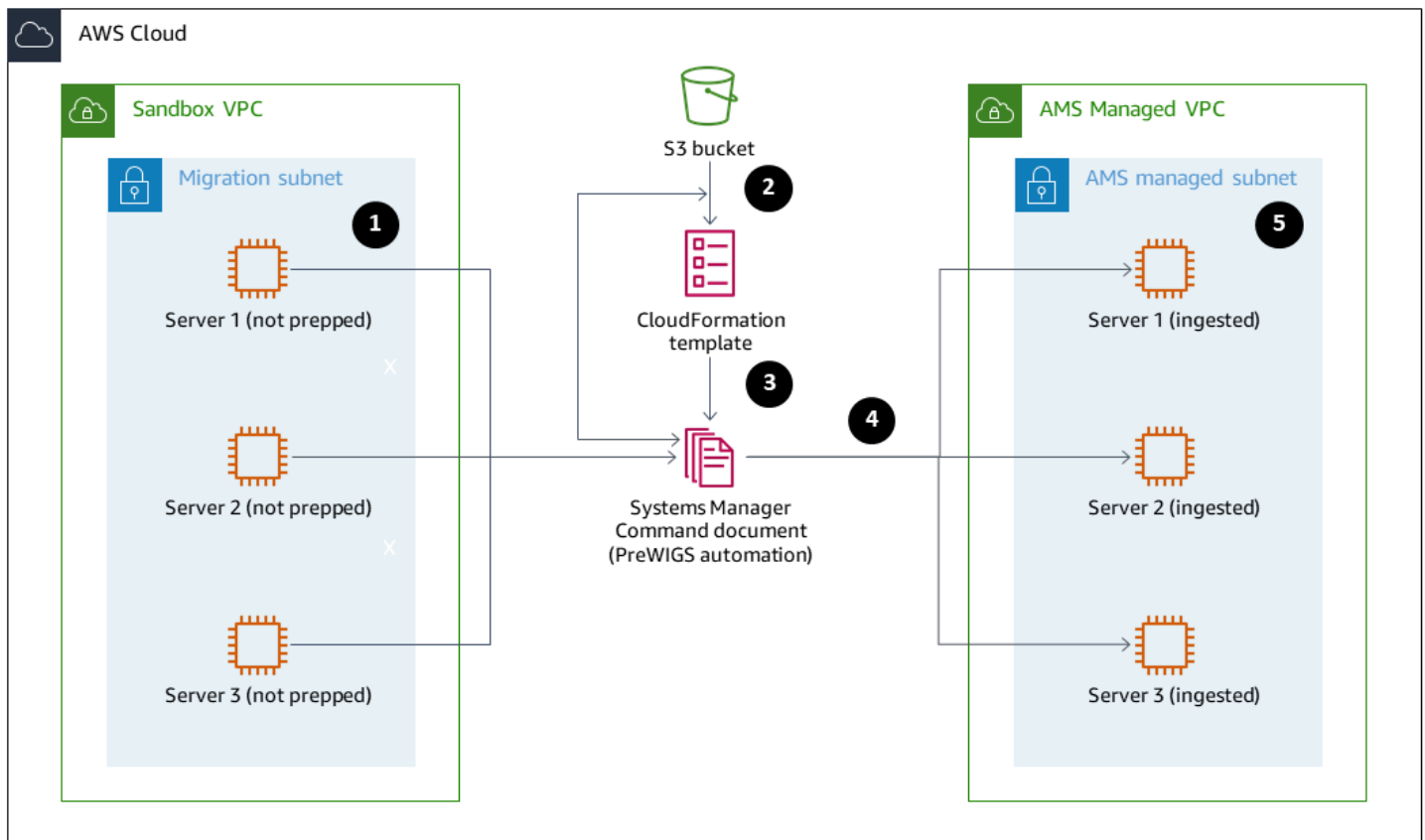

## How it works

- This pattern is packaged into an AWS CloudFormation template that allows infrastructure as code (IaC) repeatable deployments. You need to deploy this template only one time for each AWS account that requires this automation.
- The automation is applied to all EC2 instances with a tag key **AutoPreWIGs** in the AWS account where this pattern is deployed. The first time an Amazon EC2 Windows instance with the tag key **AutoPreWIGs** starts, the automation performs the following tasks.
  1. Upgrades Windows PowerShell to version 5.1 and .NET to version 4.5.2. The instance might reboot several times, depending on its existing Windows PowerShell and .NET versions. After each reboot, the upgrades continue until they are complete. This step uses embedded code in the CloudFormation template modified from a [Windows PowerShell script](#), as well as specific Systems Manager guidance on server reboots.
  2. Downloads from Amazon S3 and runs a Windows PowerShell script that you have customized to prepare the Amazon EC2 Windows instance for WIGS. For more information see the *Epics* section.
  3. Installs the Windows WIGS pre-ingestion validation PowerShell module from AWS.

4. Runs the Windows WIGS pre-ingestion validation and makes the results viewable in Systems Manager State Manager.

## Tools

- [AWS CloudFormation](#) – AWS CloudFormation is a service that helps you model and set up your AWS resources. You can use a `template` that describes all the AWS resources that you want and their dependencies, so that you can launch and configure those resources as a stack. This pattern uses a CloudFormation template to automate deployment of the resources in this pattern.
- [AWS Managed Services](#) – AWS Managed Services (AMS) is an enterprise service that provides ongoing management of your AWS infrastructure. Changes made to the infrastructure in an AMS environment must be made through an RFC.
- [AWS Systems Manager](#) – AWS Systems Manager (formerly known as SSM) is an AWS service that you can use to view and control your infrastructure on AWS. Using the Systems Manager console, you can view operational data from multiple AWS services and automate operational tasks across your AWS resources. This pattern uses Systems Manager to run and view the run results of the pre-WIGS activities.
- [Amazon S3](#) – Amazon Simple Storage Service (Amazon S3) is an object storage service that offers industry-leading scalability, data availability, security, and performance. This pattern uses Amazon S3 to store the CloudFormation template and a Windows PowerShell script that is downloaded.

## Epics

### Create a custom Windows PowerShell script to automate additional tasks

Task	Description	Skills required
Perform necessary changes to the servers based on business needs.	If you need changes automatically applied to your servers before their ingestions, create a Windows PowerShell script named <code>ingestion-prep.ps1</code> .	PowerShell scripting

Task	Description	Skills required
	<p><b>Important:</b> The script must not contain instructions to reboot the server, and it must not require administrator privileges.</p>	
Remove software that isn't supported by AMS.	<p>AMS requires certain software, such as antivirus applications and VMware Tools removed before WIGS runs. Include the uninstallation in the <code>ingestion-prep.ps1</code> script. For more information about software that isn't supported, see the <a href="#">AWS documentation</a>.</p>	PowerShell scripting

## Upload the CloudFormation template and the optional Windows PowerShell script to Amazon S3

Task	Description	Skills required
Create a folder in S3.	In an S3 bucket in the same AWS account where you deploy this pattern, create a folder.	General AWS
Upload the scripts.	Upload the <code>PreWIGs_CFN.json</code> CloudFormation template and the <code>ingestion-prep.ps1</code> Windows PowerShell script, which you created in the	General AWS

Task	Description	Skills required
	previous epic, to the Amazon S3 folder.	

## Deploy the CloudFormation stack

Task	Description	Skills required
Select the change type.	Navigate to the AMS console to create an RFC. Use the <b>Create Stack from CloudFormation (CFN) Template</b> change type.	General AMS
Set run parameters for the path to the CloudFormation template.	In the <b>Execution configuration</b> section, expand <b>Additional configuration</b> . In the <b>CloudFormation template S3 endpoint</b> box, paste the URL to the CloudFormation template.	General AMS
Specify the path to the Amazon S3 folder.	Under <b>Parameters</b> , use <b>ScriptSource</b> as the <b>Name</b> . For <b>Value</b> , enter the path to the S3 folder that contains the Windows PowerShell scripts. Make sure that you use the <code>https://xxx</code> URL instead of the <code>s3://xxx</code> URI, and include the <code>/</code> at the end.	General AMS
Deploy the stack.	To deploy the stack, choose <b>Create</b> .	General AMS

Task	Description	Skills required
Escalate the RFC to AMS Ops.	The RFC must be implemented manually by the AMS Ops team because it uses Systems Manager to deploy resources with and requires a security review. As soon as you create the RFC, it will be automatically rejected by the system. Choose the RFC, and add a correspondence to the RFC stating <b>Please execute manually</b> . Note the RFC ID, and escalate it with a service request.	General AMS

### Apply the automation to the instances

Task	Description	Skills required
Add the AutoPreWIGs tag to instances.	<p>Note IDs of all instances to which you want to apply this automation and wait at least 30 minutes for the instance to finish the automations implemented by AMS. Submit an automated RFC to add the tag with <b>AutoPreWIGs</b> as the key and any string, such as <b>1</b>, as the value.</p> <p>The automation will be applied a few minutes after you add the tag.</p>	General AMS

Task	Description	Skills required
Verify the automation results.	Open the Systems Manager console, and choose <b>State Manager</b> . Choose the <b>Association ID</b> with the name <b>AMS-PreWIG-Prep-and-Validation-Association</b> . On the <b>Execution history</b> tab, you can see the results of the automation.	General AMS
Fix any errors.	If the automation fails, choose its <b>Execution ID</b> . You can see the run results for each EC2 instance. To see the details for each step of the automation, choose <b>Output</b> . If a particular step fails, use the information in the <b>Output</b> and the <b>Error</b> sections to diagnose the problem.	Migration engineer
Remove the AutoPreWIGs tag.	<b>Important:</b> After you fix the errors, if any, submit an automated RFC to remove the <b>AutoPreWIGs</b> tag. WIGS will fail if you don't remove the tag.	General AMS



## Ingest the prepared instances

Task	Description	Skills required
Submit RFCs for WIGS.	Now that the instances are ready for workload ingestion, submit the RFCs for WIGS.	General AMS

## Related resources

- [AMS Workload Ingest \(WIGS\)](#)
- [Migrating workloads: Windows pre-ingestion validation](#)
- [AWS Application Migration Service quick start guide](#)
- [Getting started with AWS CloudFormation](#)
- [Setting up AWS Systems Manager](#)

# Create an approval process for firewall requests during a rehost migration to AWS

Created by Srikanth Rangavajhala (AWS)

<b>R Type:</b> Rehost	<b>Environment:</b> Production	<b>Technologies:</b> Migration
<b>Source:</b> On premises	<b>Target:</b> AWS Cloud	

## Summary

If you want to use [AWS Application Migration Service](#) or [Cloud Migration Factory on AWS](#) for a rehost migration to the Amazon Web Services (AWS) Cloud, one of the prerequisites is that you must keep TCP ports 443 and 1500 open. Typically, opening these firewall ports requires approval from your information security (InfoSec) team.

This pattern outlines the process to obtain a firewall request approval from an InfoSec team during a rehost migration to the AWS Cloud. You can use this process to avoid rejections of your firewall request by the InfoSec team, which can become expensive and time consuming. The firewall request process has two review and approval steps between AWS migration consultants and leads who work with your InfoSec and application teams to open the firewall ports.

This pattern assumes that you are planning a rehost migration with AWS consultants or migration specialists from your organization. You can use this pattern if your organization doesn't have a firewall approval process or firewall request blanket approval form. For more information about this, see the *Limitations* section of this pattern. For more information on network requirements for Application Migration Service, see [Network requirements](#) in the Application Migration Service documentation.

## Prerequisites and limitations

### Prerequisites

- A planned rehost migration with AWS consultants or migration specialists from your organization
- The required port and IP information to migrate the stack
- Existing and future state architecture diagrams

- Firewall information about the on-premises and destination infrastructure, ports, and zone-to-zone traffic flow
- A firewall request review checklist (attached)
- A firewall request document, configured according to your organization's requirements
- A contact list for the firewall reviewers and approvers, including the following roles:
  - **Firewall request submitter** – AWS migration specialist or consultant. The firewall request submitter can also be a migration specialist from your organization.
  - **Firewall request reviewer** – Typically, this is the single point of contact (SPOC) from AWS.
  - **Firewall request approver** – An InfoSec team member.

## Limitations

- This pattern describes a generic firewall request approval process. Requirements can vary for individual organizations.
- Make sure that you track changes to your firewall request document.

The following table shows the use cases for this pattern.

Does your organization have an existing firewall approval process?	Does your organization have an existing firewall request form?	Suggested action
Yes	Yes	Collaborate with AWS consultants or your migration specialists to implement your organization's process.
No	Yes	Use this pattern's firewall approval process. Use either an AWS consultant or a migration specialist from your organization to submit the firewall request blanket approval form.

No

No

Use this pattern's firewall approval process. Use either an AWS consultant or a migration specialist from your organization to submit the firewall request blanket approval form.

## Architecture

The following diagram shows the steps for the firewall request approval process.

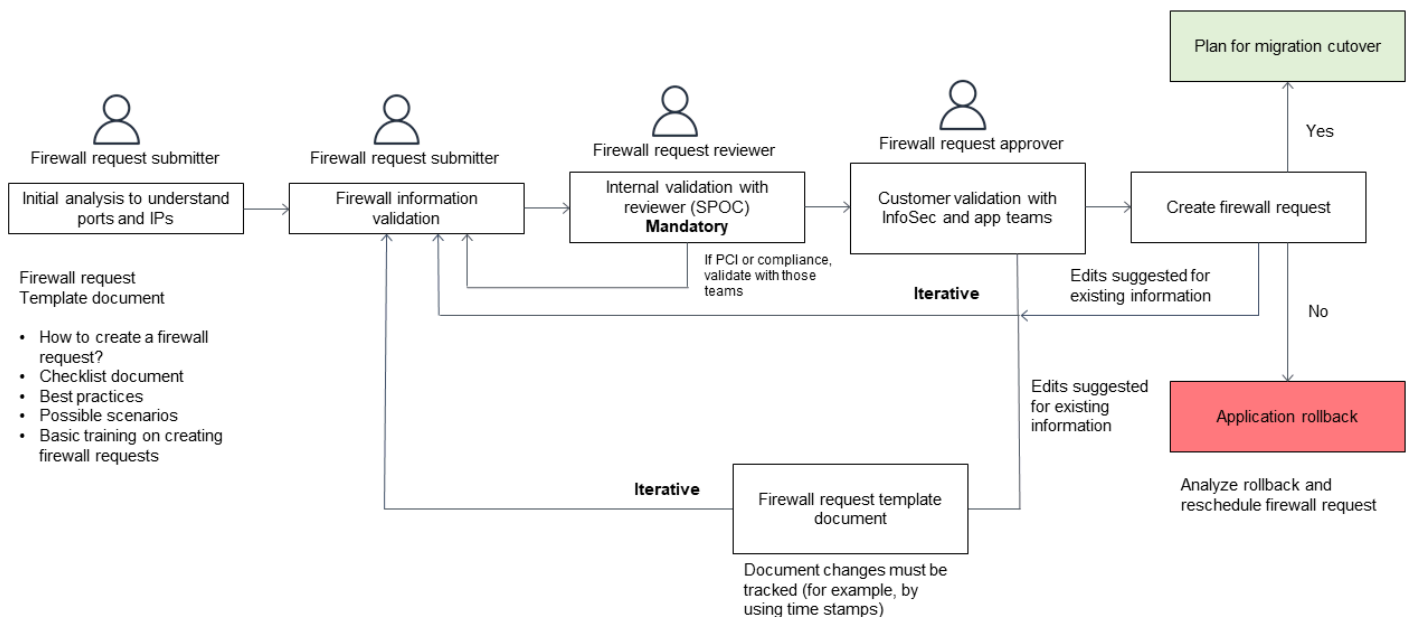

## Tools

You can use scanner tools such as [Palo Alto Networks](#) or [SolarWinds](#) to analyze and validate firewalls and IP addresses.

## Epics

### Analyze the firewall request

Task	Description	Skills required
Analyze the ports and IP addresses.	The firewall request submitter completes an initial analysis to understand the required firewall ports and IP addresses. After this is complete, they request that your InfoSec team opens the required ports and maps the IP addresses.	AWS Cloud engineer, migration specialist

### Validate the firewall request

Task	Description	Skills required
Validate the firewall information.	<p>The AWS Cloud engineer schedules a meeting with your InfoSec team. During this meeting, the engineer examines and validates the firewall request information.</p> <p>Typically, the firewall request submitter is the same person as the firewall requester. This validation phase can become iterative based on the feedback given by the approver if anything is observed or recommended.</p>	AWS Cloud engineer, migration specialist

Task	Description	Skills required
Update the firewall request document.	<p>After the InfoSec team shares their feedback, the firewall request document is edited, saved, and re-uploaded. This document is updated after each iteration.</p> <p>We recommend that you store this document in a version-controlled storage folder. This means that all changes are tracked and correctly applied.</p>	AWS Cloud engineer, migration specialist

## Submit the firewall request

Task	Description	Skills required
Submit the firewall request.	<p>After the firewall request approver has approved the firewall blanket approval request, the AWS Cloud engineer submits the firewall request. The request specifies the ports that must be open and IP addresses that are required to map and update the AWS account.</p> <p>You can make suggestions or provide feedback after the firewall request is submitted . We recommend that you automate this feedback process and send any edits</p>	AWS Cloud engineer, migration specialist

Task	Description	Skills required
	through a defined workflow mechanism.	

## Attachments

To access additional content that is associated with this document, unzip the following file:

[attachment.zip](#)

# Ingest and migrate EC2 Windows instances into an AWS Managed Services account

Created by Anil Kunapareddy (AWS) and Venkatramana Chintha (AWS)

<b>Environment:</b> Production	<b>Source:</b> VPC in AWS Cloud	<b>Target:</b> VPC Managed by AWS Managed Services
<b>R Type:</b> Rehost	<b>Workload:</b> Microsoft	<b>Technologies:</b> Migration; Operations; Security, identity, compliance
<b>AWS services:</b> AWS Managed Services		

## Summary

This pattern explains the step-by-step process of migrating and ingesting Amazon Elastic Compute Cloud (Amazon EC2) Windows instances into an Amazon Web Services (AWS) Managed Services (AMS) account. AMS can help you manage the instance more efficiently and securely. AMS provides operational flexibility, enhances security and compliance, and helps you optimize capacity and reduce costs.

This pattern starts with an EC2 Windows instance that you have migrated to a staging subnet in your AMS account. A variety of migration services and tools are available to perform this task, such as AWS Application Migration Service.

To make a change to your AMS-managed environment, you create and submit a request for change (RFC) for a particular operation or action. Using an AMS workload ingest (WIGS) RFC, you ingest the instance into the AMS account and create a custom Amazon Machine Image (AMI). You then create the AMS-managed EC2 instance by submitting another RFC to create an EC2 stack. For more information, see [AMS Workload Ingest](#) in the AMS documentation.

## Prerequisites and limitations

### Prerequisites



- An active, AMS-managed AWS account
- An existing landing zone
- Permissions to make changes in the AMS-managed VPC
- An Amazon EC2 Windows instance in a staging subnet in your AMS account
- Completion of the [general prerequisites](#) for migrating workloads using AMS WIGS
- Completion of the [Windows prerequisites](#) for migrating workloads using AMS WIGS

## Limitations

- This pattern is for EC2 instances operating Windows Server. This pattern doesn't apply to instances running other operating systems, such as Linux.

## Architecture

### Source technology stack

Amazon EC2 Windows instance in a staging subnet in your AMS account

### Target technology stack

Amazon EC2 Windows instance managed by AWS Managed Services (AMS)

### Target architecture

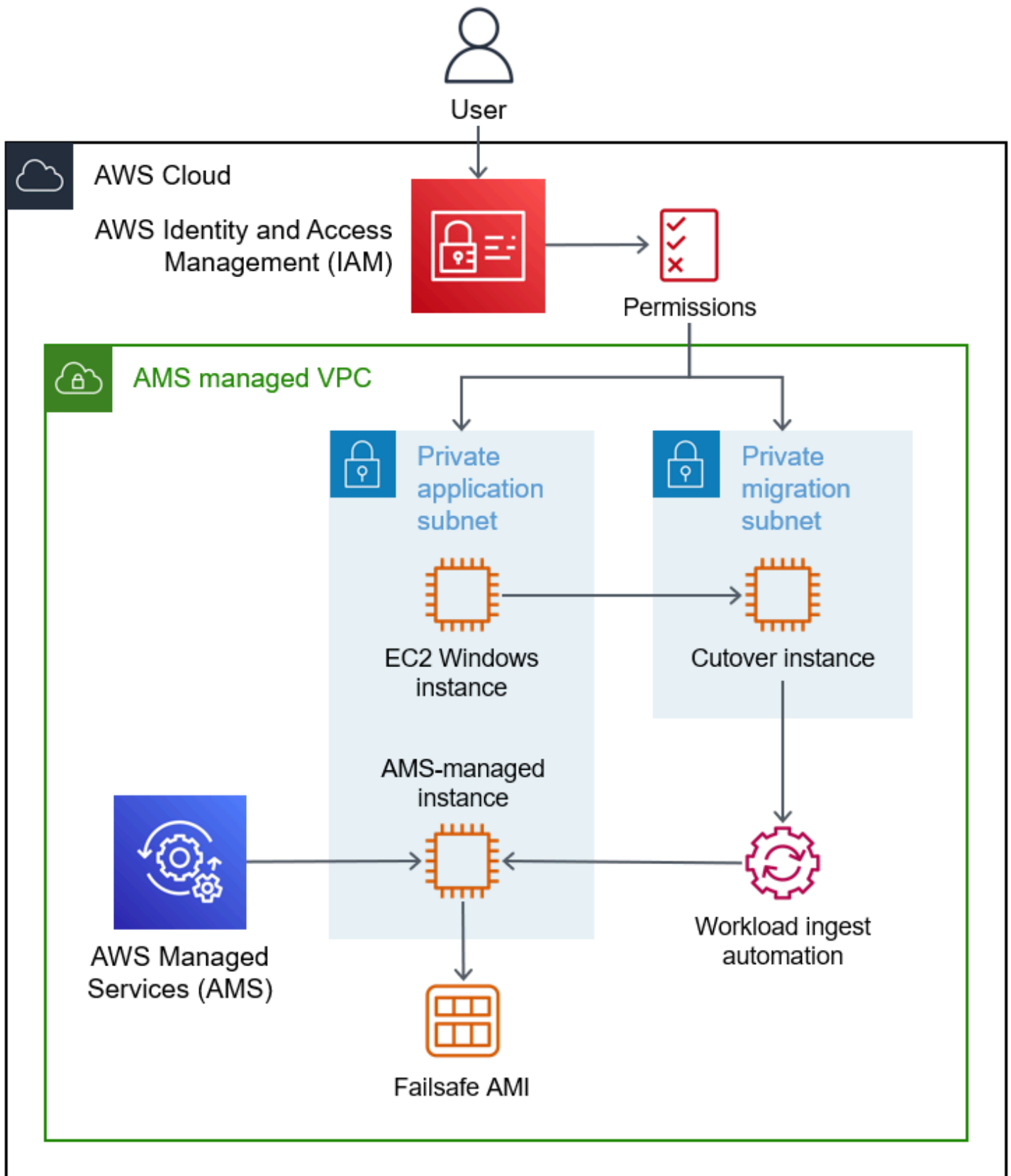

## Tools

### AWS services

- [Amazon Elastic Compute Cloud \(Amazon EC2\)](#) provides scalable computing capacity in the AWS Cloud. You can use Amazon EC2 to launch as many or as few virtual servers as you need, and you can scale out or scale in.
- [AWS Identity and Access Management \(IAM\)](#) helps you securely manage access to your AWS resources by controlling who is authenticated and authorized to use them.
- [AWS Managed Services \(AMS\)](#) helps you operate more efficiently and securely by providing ongoing management of your AWS infrastructure, including monitoring, incident management, security guidance, patch support, and backup for AWS workloads.

### Other services

- [PowerShell](#) is a Microsoft automation and configuration management program that runs on Windows, Linux, and macOS.

## Epics

### Configure settings on the instance

Task	Description	Skills required
Change the DNS Client settings.	<ol style="list-style-type: none"><li>1. On the source EC2 instance, open Command Prompt as an administrator, type <code>gpedit.msc</code>, and then press <b>Enter</b>.</li><li>2. In the Local Group Policy Editor, navigate to <b>Computer Configuration, Administrative Templates, Network, DNS Client</b>.</li><li>3. For <b>Primary DNS suffix</b>, choose <b>Not configured</b>.</li></ol>	Migration engineer

Task	Description	Skills required
	<p>4. For <b>Primary DNS suffix devolution</b>, choose <b>Not configured</b>.</p>	
<p>Change the Windows Update settings.</p>	<ol style="list-style-type: none"> <li>1. In the Local Group Policy Editor, navigate to <b>Computer Configuration, Administrative Templates, Windows Components, Windows Update</b>.</li> <li>2. For <b>Specify intranet Microsoft update service location</b>, choose <b>Not configured</b>.</li> <li>3. For <b>Configure Automatic Updates</b>, choose <b>Not configured</b>.</li> <li>4. For <b>Automatic Updates detection frequency</b>, choose <b>Not configured</b>.</li> <li>5. Close the Local Group Policy Editor.</li> </ol>	<p>Migration engineer</p>
<p>Enable the firewall.</p>	<ol style="list-style-type: none"> <li>1. On the source EC2 instance, open Command Prompt as an administrator, type <code>services.msc</code>, and then press <b>Enter</b>.</li> <li>2. In Windows Services, enable <b>Firewall</b>.</li> <li>3. Close Windows Services.</li> </ol>	<p>Migration engineer</p>

## Prepare the instance for AMS WIGS

Task	Description	Skills required
Clean up and prepare the instance.	<ol style="list-style-type: none"> <li>Using a bastion host and local credentials, create a Remote Desktop Protocol (RDP) connection to the EC2 instance in the staging subnet.</li> <li>Remove all legacy software, antivirus software, and backup solutions that aren't required in AMS.</li> </ol>	Migration engineer
Repair the sppnp.dll file.	<ol style="list-style-type: none"> <li>Go to C:\Windows\System32\sppnp.dll .</li> <li>Rename sppnp.dll to sppnp_old.dll .</li> <li>Using PowerShell and administrator credentials, enter the following commands: <div data-bbox="630 1373 1029 1535" style="border: 1px solid #ccc; border-radius: 10px; padding: 10px; margin: 10px 0;"> <pre>dism /online /cleanup-image /restorehealth sfc /scannow</pre> </div> </li> <li>Restart the EC2 Windows instance.</li> </ol>	Migration engineer
Run the pre-WIG validation script.	<ol style="list-style-type: none"> <li>Download the Windows WIGS Pre-ingestion Validation zip file (windows-prewings-</li> </ol>	Migration engineer

Task	Description	Skills required
	<p>validation.zip ) from <a href="#">Migrating workloads : Windows pre-ingestion validation</a> in the AMS documentation.</p> <ol style="list-style-type: none"> <li>Run the Windows pre-WIG validation script and verify the results.</li> <li>If the validation fails, fix the issue, and rerun the validation script until the validation succeeds.</li> </ol>	
Create the failsafe AMI.	<p>After the pre-WIG validation passes, create a pre-ingestion AMI as follows:</p> <ol style="list-style-type: none"> <li>Choose <b>Deployment, Advanced stack components, AMI, Create</b>.</li> <li>During creation, add a tag Key=Name, Value=APPLICATION-ID_Ingest Ready .</li> <li>Wait until AMI is created before proceeding.</li> </ol> <p>For more information, see <a href="#">AMI   Create</a> in the AMS documentation.</p>	Migration engineer

## Ingest and validate the instance

Task	Description	Skills required
Submit the RFC to create the workload ingest stack.	Submit a request for change (RFC) to start the AMS WIGS. For instructions, see <a href="#">Workload Ingest Stack: Creating</a> in the AMS documentation. This starts the workload ingestion and installs all the software required by AMS, including backup tools, Amazon EC2 management software, and antivirus software.	Migration engineer
Validate successful migration.	After the workload ingestion is complete, you can see the AMS-managed instance and AMS-ingested AMI.  <ol style="list-style-type: none"><li>1. Log in to the AMS-managed instance with domain credentials.</li><li>2. Validate the domain joining as follows:<ol style="list-style-type: none"><li>a. In Windows Explorer, right-click <b>This PC</b>, and then choose <b>Properties</b>.</li><li>b. In the Device Specification section, confirm that the domain appears in the <b>Full device name</b>.</li></ol></li><li>3. Validate the source and target disk drives.</li></ol>	Migration engineer

## Launch the instance in the target AMS account

Task	Description	Skills required
Submit the RFC to create an EC2 stack.	<ol style="list-style-type: none"><li>1. Using the AMS-ingested AMI of the Windows instance, prepare an RFC for an EC2 stack according to the instructions in <a href="#">Create EC2 stack instance</a> in AMS documentation. In the EC2 stack RFC, provide all the parameters, including the server name, tags, target VPC, target subnet, instance type, target security groups, ingestion AMI, and role.</li><li>2. Submit the RFC for the EC2 stack, and then wait for the instance to be successfully created.</li></ol>	Migration engineer

### Related resources

#### AWS Prescriptive Guidance

- [Automate pre-workload ingestion activities for AWS Managed Services on Windows](#)
- [Automatically create an RFC in AMS using Python](#)

#### AMS documentation

- [AMS Workload Ingest](#)
- [How Migration Changes Your Resource](#)
- [Migrating Workloads: Standard Process](#)



## Marketing resources

- [AWS Managed Services](#)
- [AWS Managed Services FAQs](#)
- [AWS Managed Services Resources](#)
- [AWS Managed Services Features](#)

# Migrate Db2 for LUW to Amazon EC2 by using log shipping to reduce outage time

Created by Feng Cai (AWS), Ambarish Satarkar (AWS), and Saurabh Sharma (AWS)

<b>Environment:</b> Production	<b>Source:</b> On-premises Db2 for Linux	<b>Target:</b> Db2 on Amazon EC2
<b>R Type:</b> Rehost	<b>Workload:</b> IBM	<b>Technologies:</b> Migration; Databases
<b>AWS services:</b> AWS Direct Connect; Amazon EBS; Amazon EC2; Amazon S3; AWS Site-to-Site VPN		

## Summary

When customers migrate their IBM Db2 for LUW (Linux, UNIX, and Windows) workloads to Amazon Web Services (AWS), using Amazon Elastic Compute Cloud (Amazon EC2) with the Bring Your Own License (BYOL) model is the fastest way. However, migrating large amounts of data from on-premises Db2 into AWS can be a challenge, especially when the outage window is short. Many customers try to set the outage window to less than 30 minutes, which leaves little time for the database itself.

This pattern covers how to accomplish a Db2 migration with a short outage window by using transaction log shipping. This approach applies to Db2 on a little-endian Linux platform.

## Prerequisites and limitations

### Prerequisites

- An active AWS account
- A Db2 instance running on EC2 instance that matches the on-premises file system layouts
- An Amazon Simple Storage Service (Amazon S3) bucket accessible to the EC2 instance
- An AWS Identity and Access Management (IAM) policy and role to make programmatic calls to Amazon S3

- Synchronized time zone and system clocks on Amazon EC2 and the on-premises server
- The on-premises network connected to AWS through [AWS Site-to-Site VPN](#) or [AWS Direct Connect](#)

## Limitations

- The Db2 on-premises instance and Amazon EC2 must be on the same [platform family](#).
- The Db2 on-premises workload must be logged. To block any unlogged transaction, set `blocknonlogged=yes` in the database configuration.

## Product versions

- Db2 for LUW version 11.5.9 and later

## Architecture

### Source technology stack

- Db2 on Linux x86\_64

### Target technology stack

- Amazon EBS
- Amazon EC2
- AWS Identity and Access Management (IAM)
- Amazon S3
- AWS Site-to-Site VPN or Direct Connect

### Target architecture

The following diagram shows one Db2 instance running on-premises with a virtual private network (VPN) connection to Db2 on Amazon EC2. The dotted lines represent the VPN tunnel between your data center and the AWS Cloud.

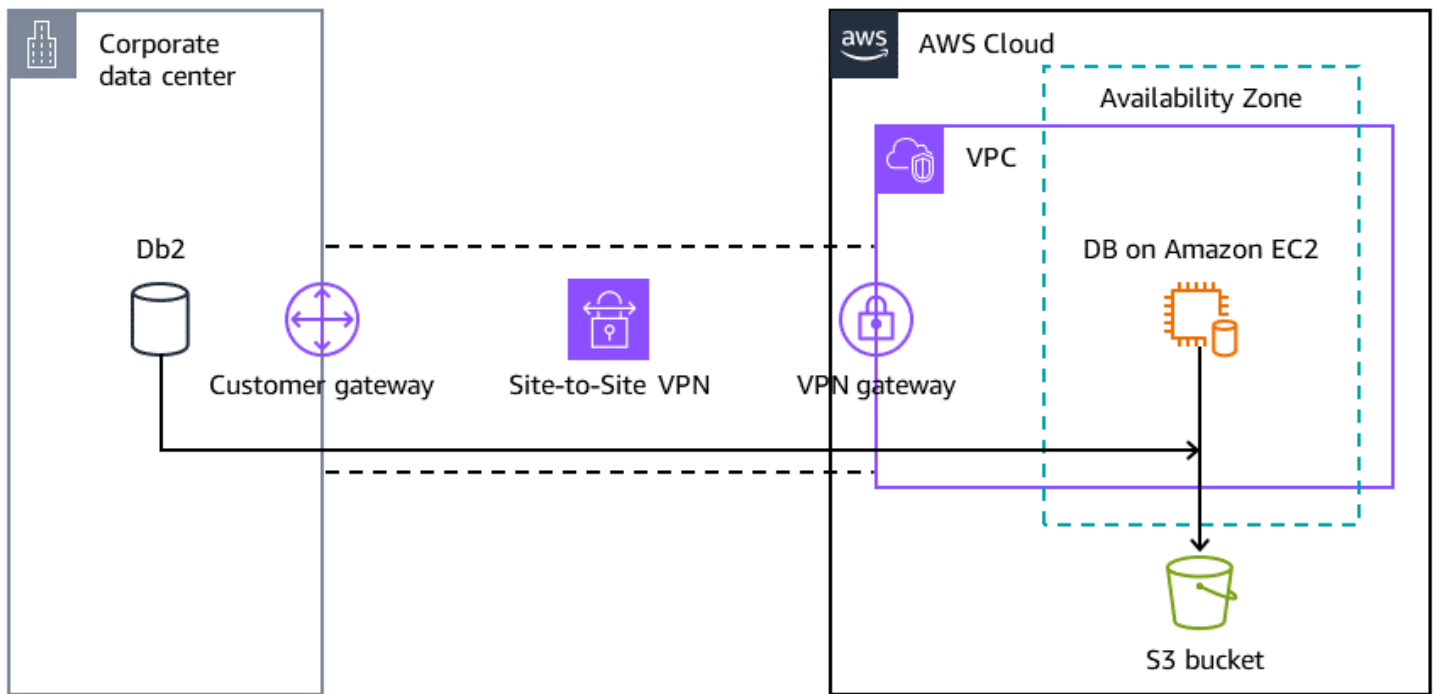

## Tools

### AWS services

- [AWS Command Line Interface \(AWS CLI\)](#) is an open-source tool that helps you interact with AWS services through commands in your command-line shell.
- [AWS Direct Connect](#) links your internal network to a Direct Connect location over a standard Ethernet fiber-optic cable. With this connection, you can create virtual interfaces directly to public AWS services while bypassing internet service providers in your network path.
- [Amazon Elastic Block Store \(Amazon EBS\)](#) provides block-level storage volumes for use with Amazon Elastic Compute Cloud (Amazon EC2) instances.
- [Amazon Elastic Compute Cloud \(Amazon EC2\)](#) provides scalable computing capacity in the AWS Cloud. You can launch as many virtual servers as you need and quickly scale them up or down.
- [AWS Identity and Access Management \(IAM\)](#) helps you securely manage access to your AWS resources by controlling who is authenticated and authorized to use them.
- [Amazon Simple Storage Service \(Amazon S3\)](#) is a cloud-based object storage service that helps you store, protect, and retrieve any amount of data.
- [AWS Site-to-Site VPN](#) helps you pass traffic between instances that you launch on AWS and your own remote network.

## Other tools

- [db2cli](#) is the Db2 interactive CLI command.

## Best practices

- On the target database, use [gateway endpoints for Amazon S3](#) to access the database backup image and log files in Amazon S3.
- On the source database, use [AWS PrivateLink for Amazon S3](#) to send the database backup image and log files to Amazon S3.

## Epics

### Set environment variables

Task	Description	Skills required
Set environment variables.	<p>This pattern uses the following names:</p> <ul style="list-style-type: none"> <li>• Instance name: db2inst1</li> <li>• Database name: SAMPLE</li> </ul> <p>You can change them to fit your environment.</p>	DBA

### Configure the on-premises Db2 server

Task	Description	Skills required
Set up the AWS CLI.	<p>To download and install the latest version of the AWS CLI, run the following commands:</p> <pre>\$ curl "https://awscli.amazonaws.com" </pre>	Linux administrator

Task	Description	Skills required
	<pre>om/awscli-exe-linux-x86_64.zip" -o "awscliv2.zip" unzip awscliv2.zip sudo ./aws/install</pre>	
Set up a local destination for Db2 archive logs.	<p>To keep the target database on Amazon EC2 in sync with the on-premises source database, the latest transaction logs need be retrieved from the source.</p> <p>In this setup, /db2logs is set by LOGARCHMETH2 on the source as a staging area. The archived logs in this directory will be synced into Amazon S3 and accessed by Db2 on Amazon EC2. The pattern uses LOGARCHMETH2 because LOGARCHMETH1 might have been configured to use a third-party vendor tool that AWS CLI command cannot access. To retrieve the logs, run the following command:</p> <pre>db2 connect to sample db2 update db cfg for SAMPLE using LOGARCHMETH2 disk:/db2logs</pre>	DBA

Task	Description	Skills required
Run an online database backup.	Run an online database backup, and save it to the local backup file system:  <pre>db2 backup db sample online to /backup</pre>	DBA

## Set up the S3 bucket and IAM policy

Task	Description	Skills required
Create an S3 bucket.	Create an S3 bucket for the on-premises server to send the backup Db2 images and log files to on AWS. The bucket will also be accessed by Amazon EC2:  <pre>aws s3api create-bucket --bucket logshipmig- db2 --region us-east-1</pre>	AWS systems administrator
Create an IAM policy.	The <code>db2bucket.json</code> file contains the IAM policy to access the Amazon S3 bucket:  <pre>{   "Version":     "2012-10-17",   "Statement": [     {       "Effect":         "Allow",       "Action": [</pre>	AWS administrator, AWS systems administrator

Task	Description	Skills required
	<pre> "kms:GenerateDataKey", "kms:Decrypt", "s3:PutObject", "s3:GetObject", "s3:AbortMultipartUpload", "s3:ListBucket", "s3:DeleteObject", "s3:GetObjectVersion", "s3:ListMultipartUploadParts" ], "Resource": [ "arn:aws:s3:::logshippmig-db2/*", "arn:aws:s3:::logshippmig-db2" ] } ] } </pre> <p>To create the policy, use the following AWS CLI command:</p> <pre>aws iam create-policy \</pre>	



Task	Description	Skills required
	<pre data-bbox="597 205 1023 424">--policy-name db2s3policy \ --policy-document file://db2bucket.j son</pre> <p data-bbox="597 466 1023 684">The JSON output shows the Amazon Resource Name (ARN) for the policy, where <code>aws_account_id</code> represents your account ID:</p> <pre data-bbox="597 726 1023 886">"Arn": "arn:aws: iam::aws_account_i d:policy/db2s3policy"</pre>	

Task	Description	Skills required
<p>Attach the IAM policy to the IAM role used by the EC2 instance.</p>	<p>In most AWS environments, a running EC2 instance has an IAM Role set by your systems administrator. If the IAM role is not set, create the role and choose <b>Modify IAM role</b> on the EC2 console to associate the role with the EC2 instance that hosts the Db2 database. Attach the IAM policy to the IAM role with the policy ARN:</p> <pre data-bbox="594 772 1029 1136">aws iam attach-role-policy \   --policy-arn   "arn:aws:iam::aws_   account_id:policy/   db2s3policy" \   --role-name   db2s3role</pre> <p>After the policy is attached, any EC2 instance associated with the IAM role can access the S3 bucket.</p>	<p>AWS administrator, AWS systems administrator</p>

### Send the source database backup image and log files to Amazon S3

Task	Description	Skills required
<p>Configure the AWS CLI on the on-premises Db2 server.</p>	<p>Configure the AWS CLI with the Access Key ID and Secret Access Key generated in the earlier step:</p>	<p>AWS administrator, AWS systems administrator</p>

Task	Description	Skills required
	<pre>\$ aws configure AWS Access Key ID [None]: ***** AWS Secret Access Key [None]: ***** ***** Default region name [None]: us-east-1 Default output format [None]: json</pre>	
Send the backup image to Amazon S3.	<p>Earlier, an online database backup was saved to the /backup local directory. To send that backup image to the S3 bucket, run the following command:</p> <pre>aws s3 sync /backup s3://logshipmig-db2/ SAMPLE_backup</pre>	AWS administrator, Migration engineer

Task	Description	Skills required
Send the Db2 archive logs to Amazon S3.	<p>Sync the on-premises Db2 archive logs with the S3 bucket that can be accessed by the target Db2 instance on Amazon EC2:</p> <pre>aws s3 sync /db2logs s3://logshipmig-db2/ SAMPLE_LOG</pre> <p>Run this command periodically by using cron or other scheduling tools. The frequency depends on how often the source database archives transaction log files.</p>	AWS administrator, Migration engineer

### Connect Db2 on Amazon EC2 to Amazon S3 and start the database sync

Task	Description	Skills required
Create a PKCS12 keystore.	<p>Db2 uses a Public-Key Cryptography Standards (PKCS) encryption keystore to keep the AWS access key secure. Create a keystore and configure the source Db2 instance to use it:</p> <pre>gsk8capicmd_64 -keydb -create -db "/home/db 2inst1/.keystore/d b2s3.p12" -pw "&lt;password&gt;" -type pkcs12 - stash</pre>	DBA

Task	Description	Skills required
	<pre>db2 "update dbm cfg using keystore_ location /home/db2 inst1/.keystore/db 2s3.p12 keystore_type pkcs12"</pre>	
Create the Db2 storage access alias.	<p>To create the <a href="#">storage access alias</a>, use the following script syntax:</p> <pre>db2 "catalog storage access alias &lt;alias_na me&gt; vendor S3 server &lt;S3 endpoint&gt; container '&lt;bucket_ name&gt;'"</pre> <p>For example, your script might look like the following:</p> <pre>db2 "catalog storage access alias DB2AWSS3 vendor S3 server s3.us-east-1.amazo naws.com container 'logshipmig-db2'"</pre>	DBA

Task	Description	Skills required
Set the staging area.	<p>By default, Db2 uses <code>DB2_OBJECT_STORAGE_LOCAL_STAGING_PATH</code> as the staging area to upload and download files to and from Amazon S3. The default path is <code>sqllib/tmp/RemoteStorage.xx</code> under the instance home directory, with <code>xxxx</code> referring to the Db2 partition number. Note that the staging area must have enough capacity to hold the backup images and log files. You can use the registry to point the staging area into a different directory.</p> <p>We also recommend using <code>DB2_ENABLE_COS_SDK=ON</code>, <code>DB2_OBJECT_STORAGE_SETTINGS=EnableStreamingRestore</code>, and the link to the <code>awssdk</code> library to bypass the Amazon S3 staging area for database backup and restore:</p> <pre>#By root: cp -rp /home/db2inst1/ sqllib/lib64/awssdk/ RHEL/7.6/* /home/db2 inst1/sqllib/lib64/  #By db2 instance owner:</pre>	DBA

Task	Description	Skills required
	<pre>db2set DB2_OBJECS T_STORAGE_LOCAL_ST AGING_PATH=/db2stage db2set DB2_ENABL E_COS_SDK=ON Db2set DB2_OBJECS T_STORAGE_SETTINGS =EnableStreamingRe store db2stop db2start</pre>	
Restore the database from the backup image.	<p>Restore the target database on Amazon EC2 from the backup image in the S3 bucket:</p> <pre>db2 restore db sample from DB2REMOTE:// DB2AWSS3/logshipmig- db2/SAMPLE_backup replace existing</pre>	DBA

Task	Description	Skills required
Roll forward the database.	<p>After the restore is complete, the target database will be put into rollforward pending state. Configure LOGARCHMETH1 and LOGARCHMETH2 so that Db2 knows where to get the transaction log files:</p> <pre data-bbox="594 583 1026 905">db2 update db cfg for SAMPLE using LOGARCHME TH1 'DB2REMOTE://DB2AW SS3//SAMPLE_LOGS/' db2 update db cfg for SAMPLE using LOGARCHME TH2 OFF</pre> <p>Start database rollforward:</p> <pre data-bbox="594 1014 1026 1171">db2 ROLLFORWARD DATABASE sample to END OF LOGS</pre> <p>This command processes all log files that have been transferred to the S3 bucket. Run it periodically based on the frequency of the s3 sync command on the on-premises Db2 servers. For example, if s3 sync runs at each hour, and it takes 10 minutes to sync all the log files, set the command to run at 10 minutes after each hour.</p>	DBA



## Bring Db2 on Amazon EC2 online during the cutover window

Task	Description	Skills required
Bring the target database online.	<p>During the cutover window, do one of the following:</p> <ul style="list-style-type: none"> <li>Put the on-premises database in ADMIN MODE, and run the <code>s3 sync</code> command to force the last transaction log to be archived.</li> <li>Shut down the database.</li> </ul> <p>After the last transaction log is synced into Amazon S3, run the <code>ROLLFORWARD</code> command for the final time:</p> <pre> db2 rollforward DB   sample to END OF LOGS db2 rollforward DB   sample complete                Rollforward Status .... Rollforward status                         = not pending .... DB20000I The ROLLFORWA RD command completed successfully.  db2 activate db sample DB20000I The ACTIVATE DATABASE command </pre>	DBA

Task	Description	Skills required
	<p>completed successfully.</p> <p>Bring the target database online, and point the application connections to Db2 on Amazon EC2.</p>	

## Troubleshooting

Issue	Solution
If multiple databases have the same instance name and database name on different hosts (DEV, QA, PROD), backups and logs might go to the same subdirectory.	Use different S3 buckets for DEV, QA, and PROD, and add the hostname as subdirectory prefix to avoid confusion.
<p>If there are multiple backup images in the same location, you will get the following error when you restore:</p> <p>SQL2522N More than one backup file matches the time stamp value provided for the backed up database image.</p>	<p>In the <code>restore</code> command, add the timestamp of the backup:</p> <pre>db2 restore db sample from DB2REMOTE://DB2AWSS3/logshimig-db2/SAMPLE_backup taken at 20230628164042 replace existing</pre>

## Related resources

- [Db2 backup and restore operations between different operating systems and hardware platforms](#)
- [Set up Db2 STORAGE ACCESS ALIAS and DB2REMOTE](#)
- [Db2 ROLLFORWARD command](#)
- [Db2 secondary log archive method](#)



# Migrate Db2 for LUW to Amazon EC2 with high availability disaster recovery

Created by Feng Cai (AWS), Aruna Gangireddy (AWS), and Venkatesan Govindan (AWS)

<b>Environment:</b> Production	<b>Source:</b> IBM Db2 for LUW on premises	<b>Target:</b> Db2 on Amazon EC2
<b>R Type:</b> Rehost	<b>Workload:</b> IBM	<b>Technologies:</b> Migration; Databases; Operating systems
<b>AWS services:</b> AWS Direct Connect; Amazon EC2; Amazon S3; AWS Site-to-Site VPN		

## Summary

When customers migrate their IBM Db2 LUW (Linux, UNIX, and Windows) workload to Amazon Web Services (AWS), using Amazon Elastic Compute Cloud (Amazon EC2) with the Bring Your Own License (BYOL) model is the fastest way. However, migrating large amounts of data from on-premises Db2 into AWS can be a challenge, especially when the outage window is short. Many customers try to set the outage window to less than 30 minutes, which leaves little time for the database itself.

This pattern covers how to accomplish a Db2 migration with a short outage window by using Db2 high availability disaster recovery (HADR). This approach applies to Db2 databases that are on the little-endian Linux platform and are not using Data Partitioning Feature (DPF).

## Prerequisites and limitations

### Prerequisites

- An active AWS account
- A Db2 instance running on an Amazon EC2 instance that matches the on-premises file system layouts

- An Amazon Simple Storage Service (Amazon S3) bucket accessible to the EC2 instance
- An AWS Identity and Access Management (IAM) policy and role to make programmatic calls to Amazon S3
- Synchronized time zone and system clocks on Amazon EC2 and the on-premises server
- The on-premises network connected to AWS through [AWS Site-to-Site VPN](#) or [AWS Direct Connect](#)
- Communication between the on-premises server and Amazon EC2 on HADR ports

## Limitations

- The Db2 on-premises instance and Amazon EC2 must be on the same [platform family](#).
- HADR is not supported in a partitioned database environment.
- HADR doesn't support the use of raw I/O (direct disk access) for database log files.
- HADR doesn't support infinite logging.
- LOGINDEXBUILD must be set to YES, which will increase the log usage for rebuilding the index.
- The Db2 on-premises workload must be logged. Set `blocknonlogged=yes` in the database configuration to block any unlogged transactions.

## Product versions

- Db2 for LUW version 11.5.9 and later

## Architecture

### Source technology stack

- Db2 on Linux x86\_64

### Target technology stack

- Amazon EC2
- AWS Identity and Access Management (IAM)
- Amazon S3
- AWS Site-to-Site VPN

## Target architecture

In the following diagram, Db2 on premises is running on `db2-server1` as the primary. It has two HADR standby targets. One standby target is on premises and is optional. The other standby target, `db2-ec2`, is on Amazon EC2. After the database is cut over to AWS, `db2-ec2` becomes the primary.

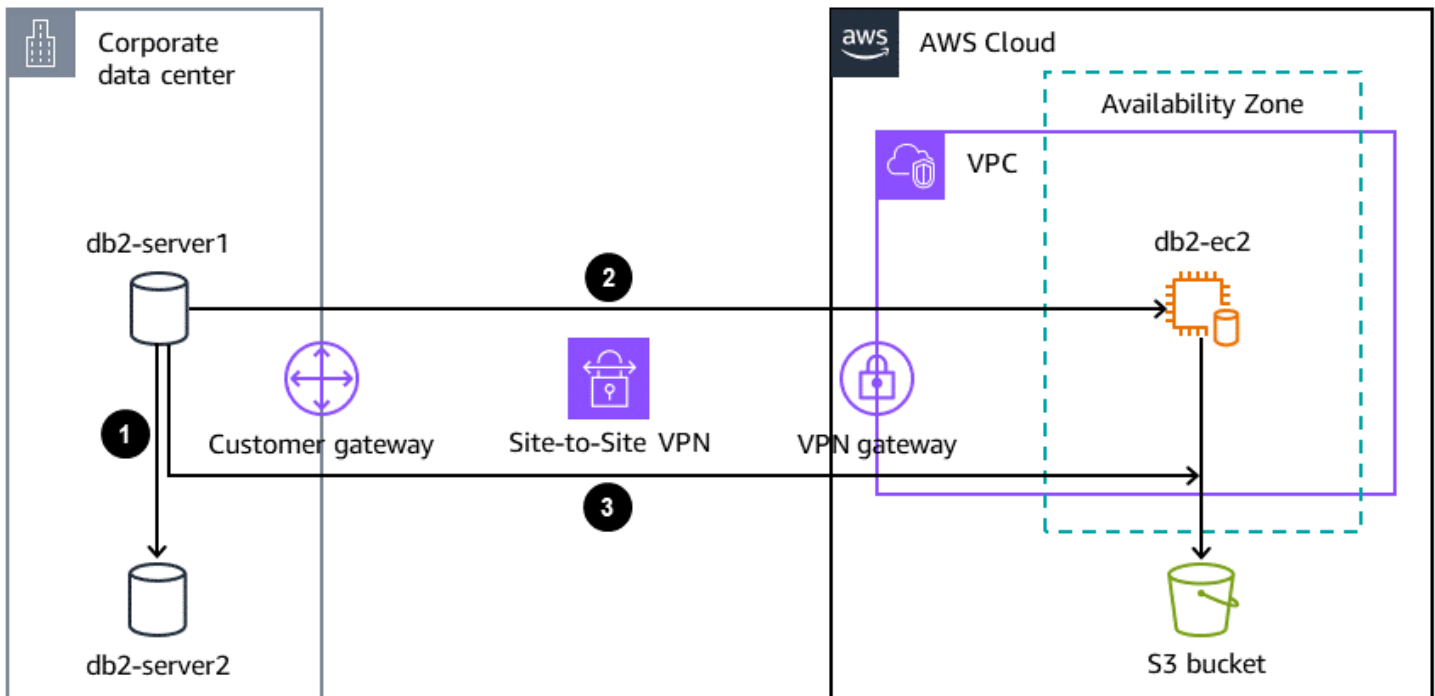

1. Logs are streamed from the primary on-premises database to the standby on-premises database.
2. Using Db2 HADR, logs are streamed from the primary on-premises database through Site-to-Site VPN to Db2 on Amazon EC2.
3. Db2 backup and archive logs are sent from the primary on-premises database to the S3 bucket on AWS.

## Tools

### AWS services

- [AWS Command Line Interface \(AWS CLI\)](#) is an open-source tool that helps you interact with AWS services through commands in your command-line shell.

- [AWS Direct Connect](#) links your internal network to a Direct Connect location over a standard Ethernet fiber-optic cable. With this connection, you can create virtual interfaces directly to public AWS services while bypassing internet service providers in your network path.
- [Amazon Elastic Compute Cloud \(Amazon EC2\)](#) provides scalable computing capacity in the AWS Cloud. You can launch as many virtual servers as you need and quickly scale them up or down.
- [AWS Identity and Access Management \(IAM\)](#) helps you securely manage access to your AWS resources by controlling who is authenticated and authorized to use them.
- [Amazon Simple Storage Service \(Amazon S3\)](#) is a cloud-based object storage service that helps you store, protect, and retrieve any amount of data.
- [AWS Site-to-Site VPN](#) helps you pass traffic between instances that you launch on AWS and your own remote network.

## Other tools

- [db2cli](#) is the Db2 interactive CLI command.

## Best practices

- On the target database, use [gateway endpoints for Amazon S3](#) to access the database backup image and log files in Amazon S3.
- On the source database, use [AWS PrivateLink for Amazon S3](#) to send the database backup image and log files to Amazon S3.

## Epics

### Set environment variables

Task	Description	Skills required
Set environment variables.	<p>This pattern uses the following names and ports:</p> <ol style="list-style-type: none"> <li>1. Db2 on-premises hostname: <code>db2-server1</code></li> <li>2. HADR standby hostname: <code>db2-server2</code> (if HADR</li> </ol>	DBA

Task	Description	Skills required
	<p>is currently running on premises)</p> <ol style="list-style-type: none"> <li>3. Amazon EC2 hostname: db2-ec2</li> <li>4. Instance name: db2inst1</li> <li>5. Database name: SAMPLE</li> <li>6. HADR ports: <ul style="list-style-type: none"> <li>• db2-server1: 50010</li> <li>• db2-server2: 50011</li> <li>• db2-ec2: 50012</li> </ul> </li> </ol> <p>You can change them to fit your environment.</p>	

### Configure the on-premises Db2 server

Task	Description	Skills required
Set up AWS CLI.	<p>To download and install the latest version of AWS CLI, run the following commands:</p> <pre>\$ curl "https://awscli.amazonaws.com/awscli-exe-linux-x86_64.zip" -o "awscliv2.zip" unzip awscliv2.zip sudo ./aws/install</pre>	Linux administrator
Set up a local destination for Db2 archive logs.	Conditions such as heavy update batch jobs and network slowdowns can cause	DBA



Task	Description	Skills required
	<p>the HADR standby server to have a lag. To catch up, the standby server needs the transaction logs from the primary server. The sequence of places to request logs is the following:</p> <ul style="list-style-type: none"> <li>• The active log directory on the primary server</li> <li>• The LOGARCHMETH1 or LOGARCHMETH2 location on the standby server</li> <li>• The LOGARCHMETH1 or LOGARCHMETH2 location on the primary server</li> </ul> <p>In this setup, /db2logs is set by LOGARCHMETH2 on the source as a staging area. The archived logs in this directory will be synced into Amazon S3 and accessed by Db2 on Amazon EC2. The pattern uses LOGARCHMETH2 because LOGARCHMETH1 might have been configured to use a third-party vendor tool that the AWS CLI command cannot access:</p> <pre data-bbox="594 1696 1027 1749">db2 connect to sample</pre>	

Task	Description	Skills required
	<pre>db2 update db cfg for SAMPLE using LOGARCHME TH2 disk:/db2logs</pre>	
Run an online database backup.	<p>Run an online database backup, and save it to the local backup file system:</p> <pre>db2 backup db sample online to /backup</pre>	DBA

### Set up the S3 bucket and IAM policy

Task	Description	Skills required
Create an S3 bucket.	<p>Create an S3 bucket for the on-premises server to send the backup Db2 images and log files to on AWS. The bucket will be accessed by Amazon EC2:</p> <pre>aws s3api create-bucket --bucket hadrmig-db2 --region us-east-1</pre>	AWS administrator
Create an IAM policy.	<p>The db2bucket.json file contains the IAM policy for accessing the S3 bucket:</p> <pre>{   "Version":   "2012-10-17",   "Statement": [     {</pre>	AWS administrator, AWS systems administrator

Task	Description	Skills required
	<pre>       "Effect":         "Allow",       "Action": [         "kms:GenerateDataKey",         "kms:Decrypt",         "s3:PutObject",         "s3:GetObject",         "s3:AbortMultipartUpload",         "s3:ListBucket",         "s3:DeleteObject",         "s3:GetObjectVersion",         "s3:ListMultipartUploadParts"       ],       "Resource": [         "arn:aws:s3:::hadr-mig-db2/*",         "arn:aws:s3:::hadr-mig-db2"       ]     }   ] } </pre> <p>To create the policy, use the following AWS CLI command:</p>	

Task	Description	Skills required
	<pre>aws iam create-policy \   --policy-name   db2s3hapolicy \   --policy-document   file://db2bucket.j son</pre> <p>The JSON output shows the Amazon Resource Name (ARN) for the policy, where <code>aws_account_id</code> represents your account ID:</p> <pre>"Arn": "arn:aws: iam::aws_account_i d:policy/db2s3hapo licy"</pre>	

Task	Description	Skills required
<p>Attach the IAM policy to the IAM role.</p>	<p>Usually, the EC2 instance with Db2 running would have an IAM role assigned by the systems administrator. If no IAM role is assigned, you can choose <b>Modify IAM role</b> on the Amazon EC2 console.</p> <p>Attach the IAM policy to the IAM role associated with the EC2 instance. After the policy is attached, the EC2 instance can access the S3 bucket:</p> <pre data-bbox="597 856 1027 1129">aws iam attach-role-policy --policy-arn "arn:aws:iam::aws_account_id:policy/db2s3hapolicy" --role-name db2s3harole</pre>	

### Send the source database backup image and log files to Amazon S3

Task	Description	Skills required
<p>Configure AWS CLI on the on-premises Db2 server.</p>	<p>Configure AWS CLI with the Access Key ID and Secret Access Key that you generated earlier:</p> <pre data-bbox="597 1633 1027 1885">\$ aws configure AWS Access Key ID [None]: ***** AWS Secret Access Key [None]: ***** *****</pre>	<p>AWS administrator, AWS systems administrator</p>

Task	Description	Skills required
	<pre>Default region name [None]: us-east-1 Default output format [None]: json</pre>	
Send the backup image to Amazon S3.	<p>Earlier, an online database backup was saved to the /backup local directory. To send that backup image to the S3 bucket, run the following command:</p> <pre>aws s3 sync /backup s3://hadrmig-db2/S AMPLE_backup</pre>	AWS administrator, AWS systems administrator
Send the Db2 archive logs to Amazon S3.	<p>Sync the on-premises Db2 archive logs with the Amazon S3 bucket that can be accessed by the target Db2 instance on Amazon EC2:</p> <pre>aws s3 sync /db2logs s3://hadrmig-db2/S AMPLE_LOGS</pre> <p>Run this command periodically by using cron or other scheduling tools. The frequency depends on how often the source database archives transaction log files.</p>	

## Connect Db2 on Amazon EC2 to Amazon S3 and start the initial database sync

Task	Description	Skills required
<p>Create a PKCS12 keystore.</p>	<p>Db2 uses a Public-Key Cryptography Standards (PKCS) encryption keystore to keep the AWS access key secure. Create a keystore, and configure the source Db2 to use it:</p> <pre data-bbox="597 688 1027 1247"> gsk8capicmd_64 -keydb   -create -db "/home/db 2inst1/.keystore/d b2s3.p12" -pw "&lt;password&gt;" -type pkcs12 - stash  db2 "update dbm cfg   using keystore_ location /home/db2 inst1/.keystore/db 2s3.p12 keystore_type pkcs12" </pre>	<p>DBA</p>
<p>Create the Db2 storage access alias.</p>	<p>Db2 uses a storage access alias to access Amazon S3 directly with the INGEST, LOAD, BACKUP DATABASE, or RESTORE DATABASE commands.</p> <p>Because you assigned an IAM role to the EC2 instance, USER and PASSWORD are not required:</p>	<p>DBA</p>

Task	Description	Skills required
	<pre>db2 "catalog storage access alias &lt;alias_name&gt; vendor S3 server &lt;S3 endpoint&gt; container '&lt;bucket_name&gt;' "</pre> <p>For example, your script might look like the following:</p> <pre>db2 "catalog storage access alias DB2AWSS3 vendor S3 server s3.us-east-1.amazonaws.com container 'hadrmig-db2' "</pre>	



Task	Description	Skills required
Set the staging area.	<p>We recommend using DB2_ENABLE_COS_SDK=ON , DB2_OBJEC T_STORAGE_SETTINGS=EnableStreamingRe store , and the link to the awssdk library to bypass the Amazon S3 staging area for database backup and restore:</p> <pre data-bbox="594 684 1026 1394">#By root: cp -rp /home/db2inst1/ sqllib/lib64/awssdk/ RHEL/7.6/* /home/db2 inst1/sqllib/lib64/  #By db2 instance owner: db2set DB2_OBJEC T_STORAGE_LOCAL_ST AGING_PATH=/db2stage db2set DB2_ENABL E_COS_SDK=ON db2set DB2_OBJEC T_STORAGE_LOCAL_ST AGING_PATH=/db2stage db2stop db2start</pre>	DBA

Task	Description	Skills required
Restore the database from the backup image.	<p>Restore the target database on Amazon EC2 from the backup image in the S3 bucket:</p> <pre>db2 create db sample on /data1 db2 restore db sample from DB2REMOTE:// DB2AWSS3/hadrmig-db2/ SAMPLE_backup replace existing</pre>	DBA

### Set up HADR with no HADR on premises

Task	Description	Skills required
Configure the on-premises Db2 server as the primary.	<p>Update the database configuration settings for HADR on db2-server1 (the on-premises source) as the primary. Set HADR_SYNC MODE to SUPERASYNC mode, which has the shortest transaction response time:</p> <pre>db2 update db cfg for sample using HADR_LOCA L_HOST db2-server1 HADR_LOCAL_SVC 50010 HADR_REMOTE_HOST db2- ec2 HADR_REMOTE_SVC 50012 HADR_REMO TE_INST db2inst1 HADR_SYNCMODE</pre>	DBA

Task	Description	Skills required
	<p>SUPERASYNC DB20000 I The UPDATE DATABASE CONFIGURATION command completed successfully</p> <p>Some network delays between the on-premises data center and AWS are expected. (You can set a different HADR_SYNCMODE value based on network reliability. For more information, see the <a href="#">Related resources</a> section).</p>	
<p>Change the target database log archive destination.</p>	<p>Change the target database log archive destination to match the Amazon EC2 environment:</p> <pre data-bbox="594 1163 1027 1556"> db2 update db cfg for SAMPLE using LOGARCHME TH1 'DB2REMOTE://DB2AW SS3//SAMPLE_LOGS/' LOGARCHMETH2 OFF DB20000I The UPDATE DATABASE CONFIGURA TION command completed successfully </pre>	<p>DBA</p>

Task	Description	Skills required
Configure HADR for Db2 on the Amazon EC2 server.	<p>Update database configuration for HADR on db2-ec2 as standby:</p> <pre>db2 update db cfg for sample using HADR_LOCAL_HOST db2-ec2 HADR_LOCAL_SVC 50012 HADR_REMOTE_HOST db2-server1 HADR_REMOTE_SVC 50010 HADR_REMOTE_INST db2inst1 HADR_SYNCMODE SUPERASYNC DB20000I The UPDATE DATABASE CONFIGURATION command completed successfully</pre>	DBA

Task	Description	Skills required
Verify HADR setup.	<p>Verify the HADR parameters on the source and target Db2 servers.</p> <p>To verify the setup on db2-server1 , run the following command:</p> <pre data-bbox="597 569 1027 1816"> db2 get db cfg for sample grep HADR HADR database role             = PRIMARY HADR local host name            (HADR_LOCAL_HOST) = db2-server1 HADR local service name (HADR_LOCAL_SVC) = 50010 HADR remote host name            (HADR_REMOTE_HOST) = db2-ec2 HADR remote service name (HADR_REMOTE_SVC) = 50012 HADR instance name of remote server (HADR_REMOTE_INST) = db2inst1 HADR timeout value  (HADR_TIMEOUT) = 120 HADR target list            (HADR_TARGET_LIST) = HADR log write synchronization mode </pre>	DBA

Task	Description	Skills required
	<pre> (HADR_SYNCMODE) = NEARSYNC HADR spool log data limit (4KB) (HADR_SPOOL_LIMIT) = AUTOMATIC(52000) HADR log replay delay (seconds) (HADR_REP LAY_DELAY) = 0 HADR peer window duration (seconds) (HADR_PEER_WINDOW) = 0 HADR SSL certifica te label (HADR_SSL_LABEL) = HADR SSL Hostname Validation (HADR_SSL_HOST_VAL) = OFF </pre> <p>To verify the setup on db2-ec2, run the following command:</p> <pre> db2 get db cfg for sample grep HADR HADR database role  = STANDBY HADR local host name (HADR_LOCAL_HOST) = db2-ec2 HADR local service name (HADR_LOCAL_SVC) = 50012 HADR remote host name (HADR_REMOTE_HOST) = db2-server1 </pre>	

Task	Description	Skills required
	<pre> HADR remote service name (HADR_REMOTE_SVC) = 50010 HADR instance name of remote server (HADR_REMOTE_INST) = db2inst1 HADR timeout value  (HADR_TIMEOUT) = 120 HADR target list       (HADR_TAR GET_LIST) = HADR log write synchronization mode       (HADR_SYNCMODE) = SUPERASYNC HADR spool log data limit (4KB) (HADR_SPOOL_LIMIT) = AUTOMATIC(52000) HADR log replay delay (seconds)      (HADR_REP LAY_DELAY) = 0 HADR peer window duration (seconds) (HADR_PEER_WINDOW) = 0 HADR SSL certifica te label (HADR_SSL_LABEL) = HADR SSL Hostname Validation (HADR_SSL_HOST_VAL) = OFF </pre> <p>The HADR_LOCAL_HOST , HADR_LOCAL_SVC , HADR_REMOTE_HOST , and HADR_REMOTE_SVC</p>	

Task	Description	Skills required
<p>Start up the Db2 HADR instance.</p>	<p>parameters indicate the one primary and one standby HADR setup.</p> <p>Start the Db2 HADR instance on the standby server db2-ec2 first:</p> <pre data-bbox="594 556 1027 835">db2 start hadr on db sample as standby DB20000I The START HADR ON DATABASE command completed successfully.</pre> <p>Start Db2 HADR on the primary (source) server db2-server1 :</p> <pre data-bbox="594 1041 1027 1320">db2 start hadr on db sample as primary DB20000I The START HADR ON DATABASE command completed successfully.</pre> <p>The HADR connection between Db2 on premises and on Amazon EC2 has now been successfully established. The Db2 primary server db2-server1 starts streaming transaction log records to db2-ec2 in real time.</p>	<p>DBA</p>



## Set up HADR when HADR exists on premises

Task	Description	Skills required
<p>Add Db2 on Amazon EC2 as an auxiliary standby.</p>	<p>If HADR is running on the on-premises Db2 instance, you can add Db2 on Amazon EC2 as an auxiliary standby using HADR_TARGET_LIST by running the following commands on db2-ec2:</p> <pre>db2 update db cfg for sample using HADR_LOCAL_HOST db2-ec2 HADR_LOCA L_SVC 50012 HADR_REMO TE_HOST db2-server1 HADR_REMOTE_SVC 50010 HADR_REMOTE_INST db2inst1 HADR_SYNC MODE SUPERASYN C DB20000I The UPDATE DATABASE CONFIGURATION command completed successfu lly. db2 update db cfg for sample using HADR_TARGET_LIST "db2-server1:50010  db2-server2:50011 " DB20000I The UPDATE DATABASE CONFIGURATION command completed successfu lly.</pre>	<p>DBA</p>

Task	Description	Skills required
Add the auxiliary standby information to the on-premises servers.	<p>Update HADR_TARG ET_LIST on the two on-premises servers (primary and standby).</p> <p>On db2-server1 , run the following code:</p> <pre>db2 update db cfg for sample using HADR_TARG ET_LIST "db2-server2:50011 db2-ec2:50012" DB20000I</pre> <p>The UPDATE DATABASE CONFIGURATION command completed successfully. SQL1363W One or more of the parameters submitted for immediate modification were not changed dynamically. For these configuration parameters, the database must be shutdown and reactivated before the configuration parameter changes become effective.</p> <p>On db2-server2 , run the following code:</p>	DBA

Task	Description	Skills required
	<pre>db2 update db cfg for sample using HADR_TARG ET_LIST "db2-serv er1:50010 db2-ec2: 50012" DB2000I The UPDATE DATABASE CONFIGURATION command completed successfu lly. SQL1363W One or more of the parameter s submitted for immediate modificat ion were not changed dynamically. For these configura tion parameters, the database must be shutdown and reactivated before the configuration parameter changes become effective.</pre>	

Task	Description	Skills required
Verify HADR setup.	<p>Verify the HADR parameters on the source and target Db2 servers.</p> <p>On db2-server1 , run the following code:</p> <pre>db2 get db cfg for sample grep HADR HADR database role          = PRIMARY HADR local host name         (HADR_LOCAL_HOST) = db2-server1 HADR local service name (HADR_LOCAL_SVC) = 50010 HADR remote host name         (HADR_REMOTE_HOST) = db2-server2 HADR remote service name (HADR_REMOTE_SVC) = 50011 HADR instance name of remote server (HADR_REMOTE_INST) = db2inst1 HADR timeout value  (HADR_TIMEOUT) = 120 HADR target list         (HADR_TARGET_LIST) = db2-server2:50011 db2-ec2:50012</pre>	

Task	Description	Skills required
	<pre> HADR log write synchronization mode     (HADR_SYNCMODE) = NEARSYNC HADR spool log data limit (4KB) (HADR_SPOOL_LIMIT) = AUTOMATIC(52000) HADR log replay delay (seconds)    (HADR_REP LAY_DELAY) = 0 HADR peer window duration (seconds) (HADR_PEER_WINDOW) = 0 HADR SSL certifica te label (HADR_SSL_LABEL) = HADR SSL Hostname Validation (HADR_SSL_HOST_VAL) = OFF </pre> <p>On db2-server2 , run the following code:</p> <pre> db2 get db cfg for sample grep HADR HADR database role          = STANDBY HADR local host name         (HADR_LOCA AL_HOST) = db2-server2 HADR local service name (HADR_LOCAL_SVC) = 50011 HADR remote host name         (HADR_REM OTE_HOST) = db2-serve r1 </pre>	

Task	Description	Skills required
	<pre> HADR remote service name (HADR_REMOTE_SVC) = 50010 HADR instance name of remote server (HADR_REMOTE_INST) = db2inst1 HADR timeout value  (HADR_TIMEOUT) = 120 HADR target list       (HADR_TAR GET_LIST) = db2-serve r1:50010 db2-ec2:5 0012 HADR log write synchronization mode       (HADR_SYNCMODE) = NEARSYNC HADR spool log data limit (4KB) (HADR_SPOOL_LIMIT) = AUTOMATIC(52000) HADR log replay delay (seconds)      (HADR_REP LAY_DELAY) = 0 HADR peer window duration (seconds) (HADR_PEER_WINDOW) = 0 HADR SSL certifica te label (HADR_SSL_LABEL) = HADR SSL Hostname Validation (HADR_SSL_HOST_VAL) = OFF </pre> <p>On db2-ec2, run the following code:</p>	

Task	Description	Skills required
	<pre> db2 get db cfg for sample grep HADR HADR database role            = STANDBY HADR local host name           (HADR_LOCAL_HOST) = db2-ec2 HADR local service name (HADR_LOCAL_SVC) = 50012 HADR remote host name           (HADR_REMOTE_HOST) = db2-serve r1 HADR remote service name (HADR_REMOTE_SVC) = 50010 HADR instance name of remote server (HADR_REMOTE_INST) = db2inst1 HADR timeout value  (HADR_TIMEOUT) = 120 HADR target list           (HADR_TARGET_LIST) = db2-serve r1:50010 db2-serve r2:50011 HADR log write synchronization mode           (HADR_SYNCMODE) = SUPERASYNC HADR spool log data limit (4KB) (HADR_SPOOL_LIMIT) = AUTOMATIC(52000) </pre>	

Task	Description	Skills required
	<pre>HADR log replay delay (seconds) (HADR_REP LAY_DELAY) = 0 HADR peer window duration (seconds) (HADR_PEER_WINDOW) = 0 HADR SSL certifica te label (HADR_SSL_LABEL) = HADR SSL Hostname Validation (HADR_SSL_HOST_VAL) = OFF</pre> <p>The HADR_LOCAL_HOST , HADR_LOCAL_SVC , HADR_REMOTE_HOST , HADR_REMOTE_SVC , and HADR_TARGET_LIST parameters indicate the one primary and two standby HADR setup.</p>	



Task	Description	Skills required
Stop and start Db2 HADR.	<p>HADR_TARGET_LIST is now set up on all three servers. Each Db2 server is aware of the other two. Stop and restart HADR (brief outage) to take advantage of the new configuration.</p> <p>On db2-server1 , run the following commands:</p> <pre>db2 stop hadr on db sample db2 deactivate db sample db2 activate db sample</pre> <p>On db2-server2 , run the following commands:</p> <pre>db2 deactivate db sample db2 start hadr on db sample as standby SQL1766W The command completed successfully</pre> <p>On db2-ec2, run the following commands:</p> <pre>db2 start hadr on db sample as standby SQL1766W The command completed successfully</pre> <p>On db2-server1 , run the following commands:</p>	DBA

Task	Description	Skills required
	<pre data-bbox="597 226 1024 407">db2 start hadr on db sample as primary SQL1766W The command completed successfully</pre> <p data-bbox="597 447 1008 863">The HADR connection between Db2 on premises and on Amazon EC2 is now successfully established. The Db2 primary server db2-server1 starts streaming transaction log records to both db2-server2 and db2-ec2 in real time.</p>	

### Make Db2 on Amazon EC2 as primary during the cutover window

Task	Description	Skills required
<p data-bbox="110 1146 488 1276">Make sure that there is no HADR lag on the standby server.</p>	<p data-bbox="597 1146 1024 1717">Check HADR status from the primary server db2-server1 . Don't be alarmed when HADR_STATE is in REMOTE_CATCHUP status, which is normal when HADR_SYNCMODE is set to SUPERASYNC . The PRIMARY_LOG_TIME and STANDBY_REPLAY_LOG_TIME show that they are in sync:</p> <pre data-bbox="597 1749 1024 1885">db2pd -hadr -db sample  HADR_ROLE = PRIMARY</pre>	<p data-bbox="1065 1146 1133 1178">DBA</p>

Task	Description	Skills required
	<pre>REPLAY_TYPE = PHYSICAL  HADR_SYNCMODE = SUPERASYNC  STANDBY_ID = 2  LOG_STREAM_ID = 0  HADR_STATE = REMOTE_CATCHUP .....  PRIMARY_LOG_TIME = 10/26/2022 02:11:32. 000000 (1666750292)  STANDBY_LOG_TIME = 10/26/2022 02:11:32. 000000 (1666750292) STANDBY_R EPLAY_LOG_TIME = 10/26/2022 02:11:32. 000000 (1666750292)</pre>	

Task	Description	Skills required
Run HADR takeover.	<p>To complete the migration, make db2-ec2 the primary database by running the HADR takeover command. Use the command db2pd to verify the HADR_ROLE value:</p> <pre data-bbox="594 537 1027 1373">db2 TAKEOVER HADR ON   DATABASE sample DB20000I The TAKEOVER   HADR ON DATABASE   command completed   successfully.  db2pd -hadr -db sample Database Member 0 -- Database SAMPLE -- Active -- Up 0   days 00:03:25 -- Date   2022-10-26-02.46.4   5.048988        HADR_ROLE = PRIMARY        REPLAY_TYPE =   PHYSICAL</pre> <p>To complete the migration to AWS, point the application connections to Db2 on Amazon EC2.</p>	

## Troubleshooting

Issue	Solution
<p>If you use NAT for firewall and security reasons, the host can have two IP addresses (one internal and one external), which can cause an HADR IP address check failure. The <code>START HADR ON DATABASE</code> command will return the following message:</p> <pre>HADR_LOCAL_HOST:HADR_LOCAL_SVC (-xx-xx-xx-xx.:50011 (xx.xx.xx .xx:50011)) on remote database is different from HADR_REMOTE_HOST:H ADR_REMOTE_SVC (xx-xx-xx- xx.:50011 (x.x.x.x:50011)) on local database.</pre>	<p>To <a href="#">support HADR in a NAT environment</a>, you can configure the <code>HADR_LOCAL_HOST</code> with both the internal and external address. For example, if the Db2 server has the internal name <code>host1</code> and the external name <code>host1E</code>, <code>HADR_LOCAL_HOST</code> can be <code>HADR_LOCAL_HOST: "host1   host1E"</code>.</p>

### Related resources

- [Db2 backup and restore operations between different operating systems and hardware platforms](#)
- [Set up Db2 STORAGE ACCESS ALIAS and DB2REMOTE](#)
- [Db2 high availability disaster recovery](#)
- [hadr\\_syncmode - HADR synchronization mode for log writes in peer state configuration parameter](#)

# Migrate VMware VMs with HCX Automation by using PowerCLI

Created by *Giri Nadiminty (AWS)*, *Hassan Adekoya (AWS)*, and *Naveen Deshwal*

<b>Environment:</b> Production	<b>Source:</b> On-premises or cloud-based VMware vCenter or SDDC	<b>Target:</b> VMware Cloud on AWS
<b>R Type:</b> Rehost	<b>Workload:</b> All other workloads	<b>Technologies:</b> Migration; Hybrid cloud
<b>AWS services:</b> VMware Cloud on AWS		

## Summary

**Notice:** As of April 30, 2024, VMware Cloud on AWS is no longer resold by AWS or its channel partners. The service will continue to be available through Broadcom. We encourage you to reach out to your AWS representative for details.

This pattern describes how to migrate VMware on-premises virtual machines (VMs) to VMware Cloud on AWS by using VMware Hybrid Cloud Extension (HCX) Automation powered by VMware PowerCLI scripts. [PowerCLI](#) is a command-line tool that's built on Windows PowerShell. It helps you manage VMware software, and automates infrastructure and migration tasks.

You can adapt this pattern for migration between any combination of vCenters, software-defined data centers (SDDCs), and cloud environments. The PowerCLI scripts included with this pattern use automation instead of mouse clicks for all VM configuration and scheduling tasks, so they provide time savings in migration activities and help reduce the risk of human error.

## Prerequisites and limitations

### Prerequisites

- A VMware Cloud on AWS account with SDDC

- An existing on-premises or cloud-based vCenter or SDDC
- A user account with the necessary permissions for source and destination vCenters or SDDCs
- [HCX Site Pairing](#) with [HCX Network Extension \(HCX-NE\)](#) configured between source and destination vCenters or SDDCs
- [VMware PowerCLI](#) installed on your server of choice

## Limitations

- If the source vCenter uses cross-vCenter NSX, the PowerCLI module will not work. Use a scripting method (such as Python) with the HCX API instead of PowerCLI.
- If the migrated VMs need new names or IP addresses, use a scripting method (such as Python) with the HCX API.
- This pattern doesn't populate the .csv file, which is required. You can populate the file by using VMware vRealize Network Insight (vRNI) or some other method.

## Product versions

- VMware vSphere version 5 or later
- VMware HCX version 4.4 or later
- VMware PowerCLI version 12.7 or later

## Architecture

### Source technology stack

- On-premises or cloud-based VMware

### Target technology stack

- VMware Cloud on AWS

### Target architecture

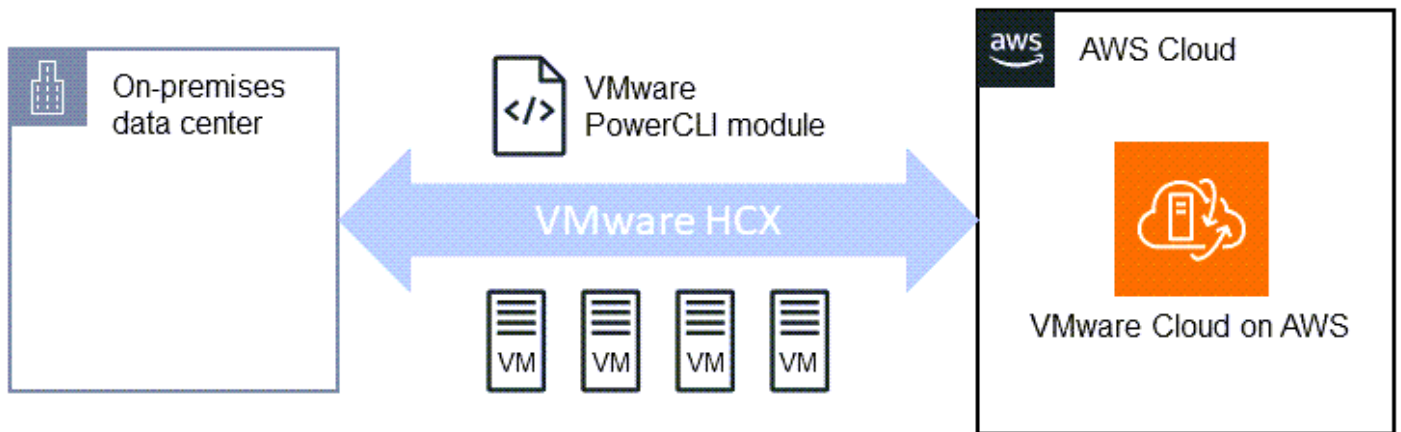

## Tools

### AWS services

- [VMware Cloud on AWS](#) is a service jointly designed by AWS and VMware to help you migrate and extend your on-premises VMware vSphere-based environments to the AWS Cloud.

### Other tools

- [VMware Hybrid Cloud Extension \(HCX\)](#) is a utility for migrating workloads from your on-premises VMware environment to VMware Cloud on AWS without changing the underlying platform. Note: This product was formerly known as Hybrid Cloud Extension and NSX Hybrid Connect. This pattern uses HCX for VM migration.
- [VMware PowerCLI](#) is a command-line tool for automating VMware vSphere and vCloud management. You run PowerCLI commands in Windows PowerShell by using PowerShell cmdlets. This pattern uses PowerCLI to run migration commands.

## Code

### Simple, self-contained script

We recommend that you use this single-machine script for initial testing, to verify that configuration options are accepted and behave as expected. For instructions, see the [Epics](#) section.

```
<# Manual Variables #>
$HcxServer = "[enterValue]"
$SrcNetworkName = "[enterValue]"
```



```

$DstNetworkName = "[enterValue]"
$DstComputeName = "[enterValue]"
$DstDSName = "[enterValue]"
$DstFolderName = "[enterValue]"
$vmName = "[enterValue]"

<# Environment Setup #>
Connect-HCXServer -Server $HcxServer
$HcxDstSite = Get-HCXSite -Destination
$HcxSrcSite = Get-HCXSite -Source
$SrcNetwork = Get-HCXNetwork -Name $SrcNetworkName -Type VirtualWire -Site $HcxSrcSite
$DstNetwork = Get-HCXNetwork -Name $DstNetworkName -Type NsxtSegment -Site $HcxDstSite
$DstCompute = Get-HCXContainer -Name $DstComputeName -Site $HcxDstSite
$DstDS = Get-HCXDatastore -Name $DstDSName -Site $HcxDstSite
$DstFolder = Get-HCXContainer -name $DstFolderName -Site $HcxDstSite
$vm = Get-HCXVM -Name $vmName

<# Migration #>
$NetworkMapping = New-HCXNetworkMapping -SourceNetwork $SrcNetwork -DestinationNetwork
  $DstNetwork
$NewMigration = New-HCXMigration -VM $vm -MigrationType vMotion -SourceSite $HcxSrcSite
  -DestinationSite $HcxDstSite -Folder $DstFolder -TargetComputeContainer $DstCompute
  -TargetDatastore $DstDS -NetworkMapping $NetworkMapping -DiskProvisionType Thin
  -UpgradeVMTools $True -RemoveISOs $True -ForcePowerOffVm $True -RetainMac $True -
  UpgradeHardware $True -RemoveSnapshots $True

```

## Full-featured, .csv-based script

After testing is complete, you can use the following script in your production environments. For instructions, see the [Epics](#) section.

```

<# Schedule #>
write-host("Getting Time for Scheduling")
$startTime = [DateTime]::Now.AddDays(12)
$endTime = [DateTime]::Now.AddDays(15)

<# Migration #>
Connect-HCXServer -Server [enterValue]
write-host("Getting Source Site")
$HcxSrcSite = Get-HCXSite
write-host("Getting Target Site")
$HcxDstSite = Get-HCXSite -Destination
$HCXVMS = Import-CSV .\Import_VM_list.csv

```

```

ForEach ($HCXVM in $HCXVMS) {
    $DstFolder = Get-HCXContainer $HCXVM.DESTINATION_VM_FOLDER -Site $HcxDstSite
    $DstCompute = Get-HCXContainer $HCXVM.DESTINATION_COMPUTE -Site $HcxDstSite
    $DstDatastore = Get-HCXDatastore $HCXVM.DESTINATION_DATASTORE -Site $HcxDstSite
    $SrcNetwork = Get-HCXNetwork $HCXVM.SOURCE_NETWORK -Type VirtualWire -Site
    $HcxSrcSite
    $DstNetwork = Get-HCXNetwork $HCXVM.DESTINATION_NETWORK -Type NsxtSegment -Site
    $HcxDstSite
    $NetworkMapping = New-HCXNetworkMapping -SourceNetwork $SrcNetwork -
    DestinationNetwork $DstNetwork
    $NewMigration = New-HCXMigration -VM (Get-HCXVM $HCXVM.VM_NAME) -MigrationType
    Bulk -SourceSite $HcxSrcSite -DestinationSite $HcxDstSite -Folder $DstFolder -
    TargetComputeContainer $DstCompute -TargetDatastore $DstDatastore -NetworkMapping
    $NetworkMapping -DiskProvisionType Thin -UpgradeVMTools $True -RemoveISOs $True -
    ForcePowerOffVm $True -RetainMac $True -UpgradeHardware $True -RemoveSnapshots $True -
    ScheduleStartTime $startTime -ScheduleEndTime $endTime
    Start-HCXMigration -Migration $NewMigration -Confirm:$false
}

```

## Epics

### Collect information for manual variables

Task	Description	Skills required
Find the source and destination vCenter and SDDC server names.	<p>PowerCLI scripts require the variables described in this epic. You can gather this information in advance for ease of script use.</p> <p>In the HCX section of the vSphere console, choose <b>Infrastructure, Site Pairing</b>. Make a note of the source and destination server names that are displayed.</p>	Cloud architect
Find the source and destination HCX names.	In the HCX section of the vSphere console, choose <b>System, Administration</b> .	Cloud architect

Task	Description	Skills required
	<p>Make a note of the source and destination HCX names that are displayed.</p>	
<p>Find the source and destination network names.</p>	<p>In the HCX section of the vSphere console, choose <b>System, Network Extension</b>. Make a note of the source and destination network names.</p> <p><b>Note:</b> As an alternative, you can get the source and destination network names by using the PowerCLI <b>Get-HCXNetwork</b> and <b>Get-HCXNetwork-Destination</b> commands after you connect to the HCX server.</p>	<p>Cloud architect</p>
<p>Gather additional information from the vSphere console.</p>	<p>On the vSphere console, collect the following information:</p> <ul style="list-style-type: none"> <li>• Names of VMs that you want to migrate</li> <li>• Destination compute environment (cluster/host)</li> <li>• Destination datastore</li> <li>• Destination VM folder name</li> </ul>	<p>Cloud architect</p>

## Make migration decisions

Task	Description	Skills required
Determine migration options.	<p>Determine the following:</p> <ul style="list-style-type: none"><li>• MigrationType – The HCX-assisted migration types are vMotion, bulk, cold, and RAV. Your choice depends on your downtime requirements, network bandwidth, migration time frame, and workload type. For more information, see the AWS blog post <a href="#">Migrating Workloads to VMware Cloud on AWS with Hybrid Cloud Extension (HCX)</a>.</li><li>• DiskProvisionType (Thin, Thick)</li><li>• UpgradeVMTools (\$True, \$False)</li><li>• RemoveISOs (\$True, \$False)</li><li>• ForcePowerOffVm (\$True, \$False)</li><li>• RetainMac (\$True, \$False)</li><li>• UpgradeHardware (\$True, \$False)</li><li>• RemoveSnapshots (\$True, \$False)</li></ul>	Cloud architect

Task	Description	Skills required
	For more Information about each option, see the <a href="#">VMware developer documentation</a> .	

### Run the simple script for initial testing

Task	Description	Skills required
Copy the script.	<p>The simple version of the script is self-contained in a single file. You can use it to test the migration of a single machine.</p> <p>Copy the first script from the <i>Code</i> section of this pattern and store it on the computer that has the VMware PowerCLI module installed. (To install PowerCLI, follow the instructions in the <a href="#">VMware documentation</a>.)</p>	Cloud architect
Set script variables.	Set all the variables in the <code>Manual Variables</code> section of the script.	Cloud architect
Set migration variables.	Set all the <code>New-HCXMi</code> migration settings in the <code>Migration</code> section of the script.	Cloud architect
Specify sites.	(Optional) If the source or destination has multiple sites, specify the sites manually in	Cloud architect

Task	Description	Skills required
Run the script.	<p>the Environment Setup section of the script.</p> <p>If the source and destination have single sites, the script will automatically look the information up.</p> <p>On the server where PowerCLI is installed, from an elevated PowerShell window, run the script, and enter your credentials when prompted.</p>	Cloud architect
Validate the script.	Confirm that VM migration has been initiated.	Cloud architect

### Run the full-featured script to migrate multiple VMs

Task	Description	Skills required
Create and populate the .csv file.	<p>Create a .csv file called <code>Import_VM_list.csv</code> on your computer and populate it with the following sample content:</p> <pre> VM_NAME, DESTINATION_VM_FOLDER, DESTINATION_COMPUTE, DESTINATION_DATASTORE, SOURCE_NETWORK, DESTINATION_NETWORK [enterValue], [enterValue], [enterValue], [enterValue], [enterValue], [en </pre>	Cloud architect

Task	Description	Skills required
	<pre>terValue],[enterValue]</pre> <p>Replace each [enterValue] in the .csv file with the information you collected earlier.</p> <p><b>Note:</b> You can populate the .csv file by using VMware vRealize Network Insight (vRNI) or some other method.</p>	
Copy the script.	<p>The full-featured version of the script uses information from an external .csv file to automatically migrate multiple VMs.</p> <p>Copy the second script from the <i>Code</i> section of this pattern and store it on the computer that has the VMware PowerCLI module installed, in the same folder as the .csv file.</p>	Cloud architect

Task	Description	Skills required
Modify the script.	<p>Edit the script to make the following changes:</p> <ul style="list-style-type: none"><li>• Line 7: Set the HCX server variable (Connect-HCXServer ).</li><li>• Line 12: (Optional) If you set the .csv filename differently, update it.</li><li>• Lines 3-4: (Optional) Set the schedule.</li><li>• Line 20: (Optional) Specify the New-HCXMigration settings in the Migration section.</li><li>• Lines 9 and 11: (Optional ) If the source or destination includes multiple sites, specify the desired sites manually.</li></ul>	Cloud architect
Run the script.	On the server where PowerCLI is installed, from an elevated PowerShell window, run the script, and enter your credentials when prompted.	Cloud architect
Validate the script.	Confirm that VM migration has been initiated.	Cloud architect



## Troubleshooting

Issue	Solution
The script fails with the error message:  “All source networks are not mapped to target!”	If the source vCenter uses cross-vCenter NSX, the PowerCLI module will not work. Use a scripting method (such as Python) with the HCX API instead of PowerCLI. This is a known limitation of the PowerCLI script.
The script fails with the error message:  “Connect-HCXServer Error: Unauthorized”	The credentials you entered don't provide the necessary permissions.

### Related resources

- [Migrating Workloads to VMware Cloud on AWS with Hybrid Cloud Extension \(HCX\)](#) (AWS blog post)
- [Choosing a migration approach for relocating your VMware applications and workloads to the AWS Cloud](#) (AWS Prescriptive Guidance)
- [Migrate VMware SDDC to VMware Cloud on AWS using VMware HCX](#) (AWS Prescriptive Guidance)
- [Getting Started with the HCX Module](#) (VMware blog post)

# Migrate an F5 BIG-IP workload to F5 BIG-IP VE on the AWS Cloud

Created by Will Bauer (AWS)

<b>Source:</b> F5 BIG-IP TMOS 13.1 and later	<b>Target:</b> F5 BIG-IP VE on AWS	<b>R Type:</b> Rehost
<b>Environment:</b> Production	<b>Technologies:</b> Migration; Security, identity, compliance; Networking	<b>Workload:</b> All other workloads
<b>AWS services:</b> Amazon EC2; Amazon VPC; AWS Transit Gateway; Amazon CloudFront; Amazon CloudWatch; AWS Global Accelerator; AWS CloudFormation		

## Summary

Organizations are looking to migrate to the Amazon Web Services (AWS) Cloud to increase their agility and resilience. After you migrate your [F5 BIG-IP](#) security and traffic management solutions to the AWS Cloud, you can focus on agility and adoption of high-value operational models across your enterprise architecture.

This pattern describes how to migrate an F5 BIG-IP workload to an [F5 BIG-IP Virtual Edition \(VE\)](#) workload on the AWS Cloud. The workload will be migrated by rehosting the existing environment and deploying aspects of replatforming, such as service discovery and API integrations. [AWS CloudFormation templates](#) accelerate your workload's migration to the AWS Cloud.

This pattern is intended for technical engineering and architectural teams that are migrating F5 security and traffic management solutions, and accompanies the guide [Migrating from F5 BIG-IP to F5 BIG-IP VE on the AWS Cloud](#) on the AWS Prescriptive Guidance website.

## Prerequisites and limitations

### Prerequisites

- An existing on-premises F5 BIG-IP workload.
- Existing F5 licenses for BIG-IP VE versions.
- An active AWS account.
- An existing virtual private cloud (VPC) configured with an egress through a NAT gateway or Elastic IP address, and configured with access to the following endpoints: Amazon Simple Storage Service (Amazon S3), Amazon Elastic Compute Cloud (Amazon EC2), AWS Security Token Service (AWS STS), and Amazon CloudWatch. You can also modify the [Modular and scalable VPC architecture](#) Quick Start as a building block for your deployments.
- One or two existing Availability Zones, depending on your requirements.
- Three existing private subnets in each Availability Zone.
- AWS CloudFormation templates, [available in the F5 GitHub repository](#).

During the migration, you might also use the following, depending on your requirements:

- An [F5 Cloud Failover Extension](#) to manage Elastic IP address mapping, secondary IP mapping, and route table changes.
- If you use multiple Availability Zones, you will need to use the F5 Cloud Failover Extensions to handle the Elastic IP mapping to virtual servers.
- You should consider using [F5 Application Services 3 \(AS3\)](#), [F5 Application Services Templates \(FAST\)](#), or another infrastructure as code (IaC) model to manage the configurations. Preparing the configurations in an IaC model and using code repositories will help with the migration and your ongoing management efforts.

## Expertise

- This pattern requires familiarity with how one or more VPCs can be connected to existing data centers. For more information about this, see [Network-to-Amazon VPC connectivity options](#) in the Amazon VPC documentation.
- Familiarity is also required with F5 products and modules, including [Traffic Management Operating System \(TMOS\)](#), [Local Traffic Manager \(LTM\)](#), [Global Traffic Manager \(GTM\)](#), [Access Policy Manager \(APM\)](#), [Application Security Manager \(ASM\)](#), [Advanced Firewall Manager \(AFM\)](#), and [BIG-IQ](#).

## Product versions

- We recommend that you use F5 BIG-IP [version 13.1](#) or later, although the pattern supports F5 BIG-IP [version 12.1](#) or later.

## Architecture

### Source technology stack

- F5 BIG-IP workload

### Target technology stack

- Amazon CloudFront
- Amazon CloudWatch
- Amazon EC2
- Amazon S3
- Amazon VPC
- AWS Global Accelerator
- AWS STS
- AWS Transit Gateway
- F5 BIG-IP VE

### Target architecture

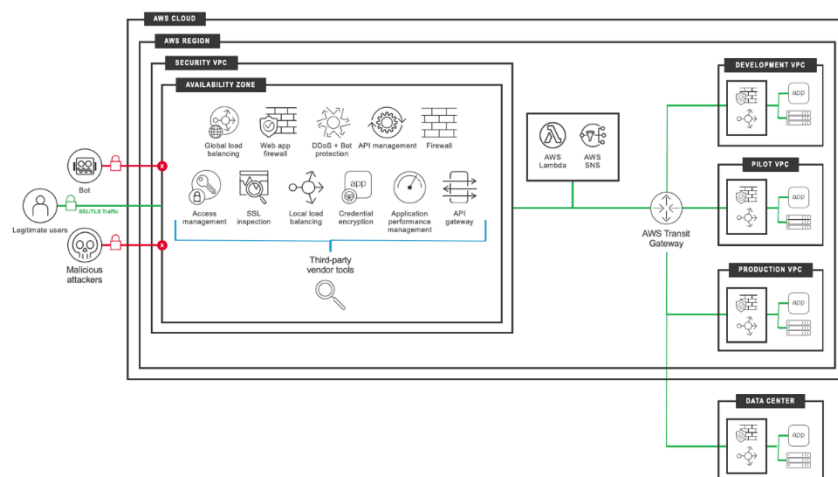

## Tools

- [AWS CloudFormation](#) helps you set up AWS resources, provision them quickly and consistently, and manage them throughout their lifecycle across AWS accounts and Regions.
- [Amazon CloudFront](#) speeds up distribution of your web content by delivering it through a worldwide network of data centers, which lowers latency and improves performance.
- [Amazon CloudWatch](#) helps you monitor the metrics of your AWS resources and the applications you run on AWS in real time.
- [Amazon Elastic Compute Cloud \(Amazon EC2\)](#) provides scalable computing capacity in the AWS Cloud. You can launch as many virtual servers as you need and quickly scale them up or down.
- [AWS Identity and Access Management \(IAM\)](#) helps you securely manage access to your AWS resources by controlling who is authenticated and authorized to use them.
- [Amazon Simple Storage Service \(Amazon S3\)](#) is a cloud-based object storage service that helps you store, protect, and retrieve any amount of data.
- [AWS Security Token Service \(AWS STS\)](#) helps you request temporary, limited-privilege credentials for users.
- [AWS Transit Gateway](#) is a central hub that connects virtual private clouds (VPCs) and on-premises networks.
- [Amazon Virtual Private Cloud \(Amazon VPC\)](#) helps you launch AWS resources into a virtual network that you've defined. This virtual network resembles a traditional network that you'd operate in your own data center, with the benefits of using the scalable infrastructure of AWS.

## Epics

### Discovery and assessment

Task	Description	Skills required
Assess the performance of F5 BIG-IP.	Collect and record the performance metrics of the applications on the virtual server, and metrics of systems that will be migrated. This will help to correctly size the	F5 Architect, Engineer and Network Architect, Engineer

Task	Description	Skills required
	target AWS infrastructure for better cost optimization.	
Evaluate the F5 BIG-IP operating system and configuration.	Evaluate which objects will be migrated and if a network structure needs to be maintained, such as VLANs.	F5 Architect, Engineer
Evaluate F5 license options.	Evaluate which license and consumption model you will require. This assessment should be based on your evaluation of the F5 BIG-IP operating system and configuration.	F5 Architect, Engineer
Evaluate the public applications.	Determine which applications will require public IP addresses. Align those applications to the required instances and clusters to meet performance and service-level agreement (SLA) requirements.	F5 Architect, Cloud Architect, Network Architect, Engineer, App Teams
Evaluate internal applications.	Evaluate which applications will be used by internal users. Make sure you know where those internal users sit in the organization and how those environments connect to the AWS Cloud. You should also make sure those applications can use domain name system (DNS) as part of the default domain.	F5 Architect, Cloud Architect, Network Architect, Engineer, App Teams

Task	Description	Skills required
Finalize the AMI.	Not all F5 BIG-IP versions are created as Amazon Machine Images (AMIs). You can use the F5 BIG-IP Image Generator Tool if you have specific required quick-fix engineering (QFE) versions. For more information about this tool, see the "Related resources" section.	F5 Architect, Cloud Architect, Engineer
Finalize the instance types and architecture.	Decide on the instance types, VPC architecture, and interconnected architecture.	F5 Architect, Cloud Architect, Network Architect, Engineer

### Complete security and compliance-related activities

Task	Description	Skills required
Document the existing F5 security policies.	Collect and document existing F5 security policies. Make sure you create a copy of them in a secure code repository.	F5 Architect, Engineer
Encrypt the AMI.	(Optional) Your organization might require encryption of data at rest. For more information about creating a custom Bring Your Own License (BYOL) image, see the "Related resources" section.	F5 Architect, Engineer Cloud Architect, Engineer

Task	Description	Skills required
Harden the devices.	This will help protect against potential vulnerabilities.	F5 Architect, Engineer

## Configure your new AWS environment

Task	Description	Skills required
Create edge and security accounts.	Sign in to the AWS Management Console and create the AWS accounts that will provide and operate the edge and security services. These accounts might be different from the accounts that operate VPCs for shared services and applications. This step can be completed as part of a landing zone.	Cloud Architect, Engineer
Deploy edge and security VPCs.	Set up and configure the VPCs required to deliver edge and security services.	Cloud Architect, Engineer
Connect to the source data center.	Connect to the source data center that hosts your F5 BIG-IP workload.	Cloud Architect, Network Architect, Engineer
Deploy the VPC connections.	Connect the edge and security service VPCs to the application VPCs.	Network Architect, Engineer
Deploy the instances.	Deploy the instances by using the AWS CloudFormation templates from the "Related resources" section.	F5 Architect, Engineer



Task	Description	Skills required
Test and configure instance failover.	Make sure that the AWS Advanced HA iAPP template or F5 Cloud Failover Extension is configured and operating correctly.	F5 Architect, Engineer

## Configure networking

Task	Description	Skills required
Prepare the VPC topology.	Open the Amazon VPC console and make sure that your VPC has all the required subnets and protections for the F5 BIG-IP VE deployment.	Network Architect, F5 Architect, Cloud Architect, Engineer
Prepare your VPC endpoints.	Prepare the VPC endpoints for Amazon EC2, Amazon S3, and AWS STS if an F5 BIG-IP workload does not have access to a NAT Gateway or Elastic IP address on a TMM interface.	Cloud Architect, Engineer

## Migrate data

Task	Description	Skills required
Migrate the configuration.	Migrate the F5 BIG-IP configuration to F5 BIG-IP VE on the AWS Cloud.	F5 Architect, Engineer
Associate the secondary IPs.	Virtual server IP addresses have a relationship with	F5 Architect, Engineer

Task	Description	Skills required
	the secondary IP addresses assigned to the instances. Assign secondary IP addresses and make sure "Allow remap/reassignment" is selected.	

## Test configurations

Task	Description	Skills required
Validate the virtual server configurations.	Test the virtual servers.	F5 Architect, App Teams

## Finalize operations

Task	Description	Skills required
Create the backup strategy.	Systems must be shut down to create a full snapshot. For more information, see "Updating an F5 BIG-IP virtual machine" in the "Related resources" section.	F5 Architect, Cloud Architect, Engineer
Create the cluster failover runbook.	Make sure that the failover runbook process is complete.	F5 Architect, Engineer
Set up and validate logging.	Configure F5 Telemetry Streaming to send logs to the required destinations.	F5 Architect, Engineer

## Complete the cutover

Task	Description	Skills required
Cut over to the new deployment.		F5 Architect, Cloud Architect , Network Architect, Engineer, AppTeams

## Related resources

### Migration guide

- [Migrating from F5 BIG-IP to F5 BIG-IP VE on the AWS Cloud](#)

### F5 resources

- [AWS CloudFormation templates in the F5 GitHub repository](#)
- [F5 in AWS Marketplace](#)
- [F5 BIG-IP VE overview](#)
- [Example Quickstart - BIG-IP Virtual Edition with WAF \(LTM + ASM\)](#)
- [F5 Application services on AWS: an overview \(video\)](#)
- [F5 Application Services 3 Extension User Guide](#)
- [F5 cloud documentation](#)
- [F5 iControl REST wiki](#)
- [F5 Overview of single configuration files \(11.x - 15.x\)](#)
- [F5 topology lab](#)
- [F5 whitepapers](#)
- [F5 BIG-IP Image Generator Tool](#)
- [Updating an F5 BIG-IP VE virtual machine](#)
- [Overview of the UCS archive "platform-migrate" option](#)

# Migrate an on-premises Go web application to AWS Elastic Beanstalk by using the binary method

Created by Suhas Basavaraj (AWS) and Shumaz Mukhtar Kazi (AWS)

<b>Environment:</b> PoC or pilot	<b>Source:</b> Applications	<b>Target:</b> Elastic Beanstalk
<b>R Type:</b> Rehost	<b>Technologies:</b> Migration; Web & mobile apps	<b>AWS services:</b> AWS Elastic Beanstalk

## Summary

This pattern describes how to migrate an on-premises Go web application to AWS Elastic Beanstalk. After the application is migrated, Elastic Beanstalk builds the binary for the source bundle and deploys it to an Amazon Elastic Compute Cloud (Amazon EC2) instance.

As a rehost migration strategy, this pattern's approach is fast and requires no code changes, which means less testing and migration time.

## Prerequisites and limitations

### Prerequisites

- An active AWS account.
- An on-premises Go web application.
- A GitHub repository that contains your Go application's source code. If you do not use GitHub, there are other ways to [create an application source bundle for Elastic Beanstalk](#).

### Product versions

- The most recent Go version supported by Elastic Beanstalk. For more information, see the [Elastic Beanstalk documentation](#).

## Architecture

### Source technology stack

- An on-premises Go web application

**Target technology stack**

- AWS Elastic Beanstalk
- Amazon CloudWatch

**Target architecture**

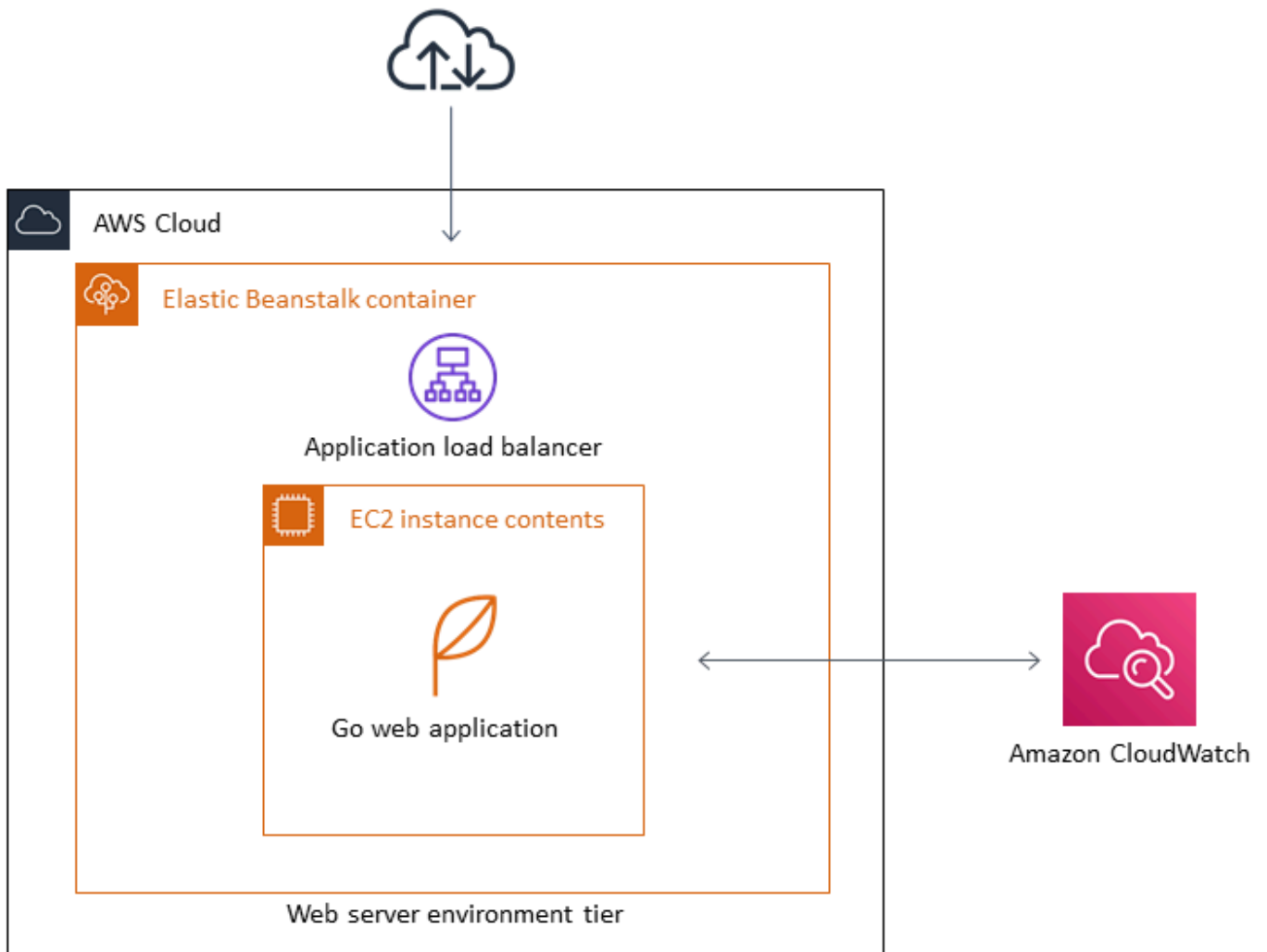

## Tools

- [AWS Elastic Beanstalk](#) quickly deploys and manages applications in the AWS Cloud without users having to learn about the infrastructure that runs those applications. Elastic Beanstalk reduces management complexity without restricting choice or control.
- [GitHub](#) is an open-source distributed version control system.

## Epics

### Create the Go web application source bundle .zip file

Task	Description	Skills required
Create the source bundle for the Go application.	Open the GitHub repository that contains your Go application's source code and prepare the source bundle. The source bundle contains an <code>application.go</code> source file in the root directory, which hosts the main package for your Go application. If you do not use GitHub, see the <i>Prerequisites</i> section earlier in this pattern for other ways to create your application source bundle.	System Admin, Application Developer
Create a configuration file.	Create an <code>.ebextensions</code> folder in your source bundle, and then create an <code>options.config</code> file inside this folder. For more information, see the <a href="#">Elastic Beanstalk documentation</a> .	System Admin, Application Developer

Task	Description	Skills required
Create the source bundle .zip file.	<p>Run the following command.</p> <pre>git archive -o ../godemo app.zip HEAD</pre> <p>This creates the source bundle .zip file. Download and save the .zip file as a local file.</p> <p><b>Important:</b> The .zip file cannot exceed 512 MB and cannot include a parent folder or top-level directory.</p>	System Admin, Application Developer

## Migrate the Go web application to Elastic Beanstalk

Task	Description	Skills required
Choose the Elastic Beanstalk application.	<ol style="list-style-type: none"><li>1. Sign in to the AWS Management Console and open the <a href="#">Elastic Beanstalk console</a>.</li><li>2. From the <b>Regions</b> list, choose your AWS Region.</li><li>3. In the navigation pane, choose <b>Applications</b>, and then choose an existing Elastic Beanstalk application or create one.</li></ol> <p>For instructions on how to create an Elastic Beanstalk</p>	System Admin, Application Developer

Task	Description	Skills required
	application, see the <a href="#">Elastic Beanstalk documentation</a> .	
Initiate the Elastic Beanstalk web server environment.	<ol style="list-style-type: none"><li>1. On the application overview page, choose <b>Create a new environment</b>, and then choose <b>Web server environment</b>.</li><li>2. Complete the <b>Environment name</b> and <b>Domain name</b> fields.</li><li>3. Choose <b>Platform version</b>, and select <b>Go</b> as your platform.</li></ol>	System Admin, Application Developer
Upload the source bundle .zip file to Elastic Beanstalk.	<ol style="list-style-type: none"><li>1. In <b>Application code</b>, choose <b>Upload your code</b>, and then choose <b>Local file</b>.</li><li>2. Choose the .zip file that contains your source bundle.</li><li>3. In <b>Version label</b>, give the file a unique name, and then choose <b>Create environment</b>.</li></ol>	System Admin, Application Developer



Task	Description	Skills required
Test the deployed Go web application.	You will be redirected to the Elastic Beanstalk application's overview page. At the top of the overview, next to <b>Environment ID</b> , choose the URL that ends in <code>elasticbeanstalk.com</code> to navigate to your application. Your application must use this name in its configuration file as an environment variable and display it on the web page.	System Admin, Application Developer

## Troubleshooting

Issue	Solution
Unable to access the application through an Application Load Balancer.	Check the target group that contains your Elastic Beanstalk application. If it's unhealthy, log in to your Elastic Beanstalk instance and check the <code>nginx.conf</code> file configuration to verify that it routes to the correct health status URL. You might need to change the target group health check URL.

## Related resources

- [Go platform versions supported by Elastic Beanstalk](#)
- [Using configuration files with Elastic Beanstalk](#)
- [Creating an example application in Elastic Beanstalk](#)

# Migrate an on-premises SFTP server to AWS using AWS Transfer for SFTP

Created by Akash Kumar (AWS)

<b>Environment:</b> Production	<b>Source:</b> Storage	<b>Target:</b> Amazon S3
<b>R Type:</b> Rehost	<b>Technologies:</b> Migration; Storage & backup; Web & mobile apps	<b>AWS services:</b> Amazon S3; AWS Transfer Family; Amazon CloudWatch Logs

## Summary

This pattern describes how to migrate an on-premises file transfer solution that uses the Secure Shell (SSH) File Transfer Protocol (SFTP) to the Amazon Web Services (AWS) Cloud by using the AWS Transfer for SFTP service. Users generally connect to an SFTP server either through its domain name or by fixed IP. This pattern covers both cases.

AWS Transfer for SFTP is a member of the AWS Transfer Family. It is a secure transfer service that you can use to transfer files into and out of AWS storage services over SFTP. You can use AWS Transfer for SFTP with Amazon Simple Storage Service (Amazon S3) or Amazon Elastic File System (Amazon EFS). This pattern uses Amazon S3 for storage.

## Prerequisites and limitations

### Prerequisites

- An active AWS account.
- An existing SFTP domain name or fixed SFTP IP.

### Limitations

- The largest object that you can transfer in one request is currently 5 GiB. For files that are larger than 100 MiB, consider using [Amazon S3 multipart upload](#).

## Architecture

### Source technology stack

- On-premises flat files or database dump files.

### Target technology stack

- AWS Transfer for SFTP
- Amazon S3
- Amazon Virtual Private Cloud (Amazon VPC)
- AWS Identity and Access Management (IAM) roles and policies
- Elastic IP addresses
- Security groups
- Amazon CloudWatch Logs (optional)

### Target architecture

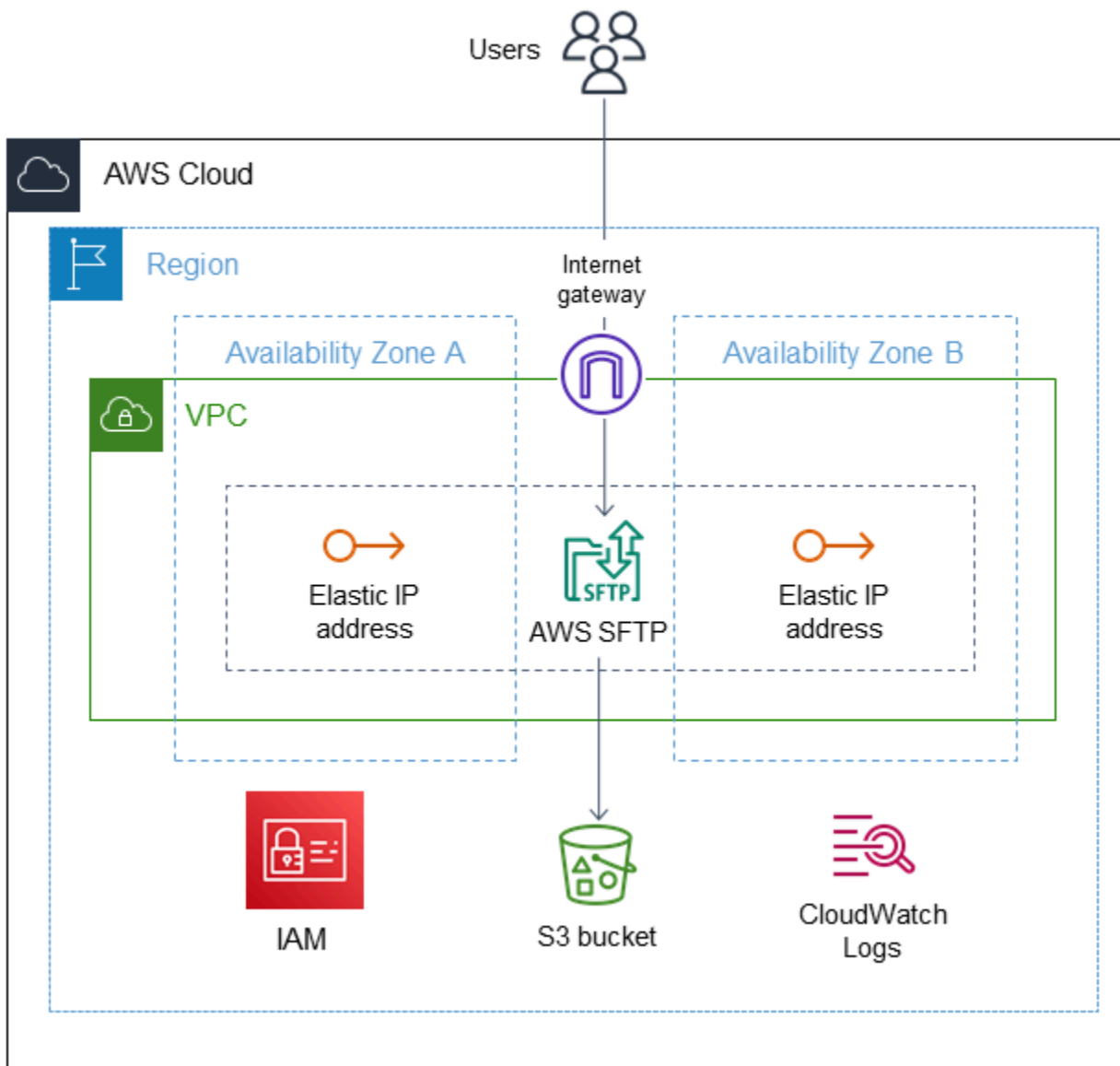

## Automation and scale

To automate the target architecture for this pattern, use the attached AWS CloudFormation templates:

- `amazon-vpc-subnets.yml` provisions a virtual private cloud (VPC) with two public and two private subnets.
- `amazon-sftp-server.yml` provisions the SFTP server.
- `amazon-sftp-customer.yml` adds users.

## Tools

### AWS services

- [Amazon CloudWatch Logs](#) helps you centralize the logs from all your systems, applications, and AWS services so you can monitor them and archive them securely.
- [AWS Identity and Access Management \(IAM\)](#) helps you securely manage access to your AWS resources by controlling who is authenticated and authorized to use them.
- [Amazon Simple Storage Service \(Amazon S3\)](#) is a cloud-based object storage service that helps you store, protect, and retrieve any amount of data. This pattern uses Amazon S3 as the storage system for file transfers.
- [AWS Transfer for SFTP](#) helps you transfer files into and out of AWS storage services over the SFTP protocol.
- [Amazon Virtual Private Cloud \(Amazon VPC\)](#) helps you launch AWS resources into a virtual network that you've defined. This virtual network resembles a traditional network that you'd operate in your own data center, with the benefits of using the scalable infrastructure of AWS.

## Epics

### Create a VPC

Task	Description	Skills required
Create a VPC with subnets.	<p>Open the Amazon VPC console at <a href="https://console.aws.amazon.com/vpc/">https://console.aws.amazon.com/vpc/</a>. Create a virtual private cloud (VPC) with two public subnets. (The second subnet provides high availability.)</p> <p>—or—</p> <p>You can deploy the attached CloudFormation template, <code>amazon-vpc-subnets.yml</code>, in the <a href="#">CloudFormation</a></p>	Developer, Systems administrator

Task	Description	Skills required
	<a href="#">console</a> to automate the tasks in this epic.	
Add an internet gateway.	Provision an internet gateway and attach it to the VPC.	Developer, Systems administrator
Migrate an existing IP.	Attach an existing IP to the Elastic IP address. You can create an Elastic IP address from your address pool and use it.	Developer, Systems administrator

### Provision an SFTP server

Task	Description	Skills required
Create an SFTP server.	<p>Open the AWS Transfer Family console at <a href="https://console.aws.amazon.com/transfer/">https://console.aws.amazon.com/transfer/</a>. Follow the instructions in <a href="#">Create an internet-facing endpoint for your server</a> in the AWS Transfer Family documentation to create an SFTP server with an internet-facing endpoint. For <b>Endpoint type</b>, choose <b>VPC hosted</b>. For <b>Access</b>, choose <b>Internet Facing</b>. For <b>VPC</b>, choose the VPC you created in the previous epic.</p> <p>—or—</p> <p>You can deploy the attached CloudFormation template,</p>	Developer, Systems administrator

Task	Description	Skills required
	amazon-sftp-server .yaml , in the <a href="#">CloudFormation console</a> to automate the tasks in this epic.	
Migrate the domain name.	Attach the existing domain name to the custom hostname. If you're using a new domain name, use the <b>Amazon Route 53 DNS</b> alias. For an existing domain name, choose <b>Other DNS</b> . For more information, see <a href="#">Working with custom hostnames</a> in the AWS Transfer Family documentation.	Developer, Systems administrator
Add a CloudWatch logging role.	(Optional) if you want to enable CloudWatch logging, create a Transfer role with the CloudWatch Logs API operations <code>logs:CreateLogGroup</code> , <code>logs:CreateLogStream</code> , <code>logs:DescribeLogStreams</code> , and <code>logs:PutLogEvents</code> . For more information, see <a href="#">Log activity with CloudWatch</a> in the AWS Transfer Family documentation.	Developer, system administrator

Task	Description	Skills required
Save and submit.	Choose <b>Save</b> . For <b>Actions</b> , choose <b>Start</b> and wait for the SFTP server to be created with the status <b>Online</b> .	Developer, Systems administrator

## Map Elastic IP addresses to the SFTP server

Task	Description	Skills required
Stop the server so you can modify settings.	On the <a href="#">AWS Transfer Family console</a> , choose <b>Servers</b> , and then select the SFTP server you created. For <b>Actions</b> , choose <b>Stop</b> . When the server is offline, choose <b>Edit</b> to modify its settings.	Developer, system admin
Choose Availability Zones and subnets.	In the <b>Availability Zones</b> section, choose the Availability Zones and subnets for your VPC.	Developer, Systems administrator
Add Elastic IP addresses.	For <b>IPv4 Addresses</b> , choose an Elastic IP address for each subnet, and then choose <b>Save</b> .	Developer, Systems administrator

## Add users

Task	Description	Skills required
Create an IAM role for users to access the S3 bucket.	Create a IAM role for Transfer and add <code>s3:ListBu</code>	Developer, Systems administrator



Task	Description	Skills required
	<p>cket , s3:GetBucketLocation , and s3:PutObject with the S3 bucket name as a resource. For more information, see <a href="#">Create an IAM role and policy</a> in the AWS Transfer Family documentation.</p> <p>—or—</p> <p>You can deploy the attached CloudFormation template, amazon-sftp-custom er.yml , in the <a href="#">CloudFormation console</a> to automate the tasks in this epic.</p>	
Create an S3 bucket.	Create a S3 bucket for the application.	Developer, Systems administrator
Create optional folders.	(Optional) If you want to store files for users separately, in specific Amazon S3 folders, add folders as appropriate.	Developer, Systems administrator
Create an SSH public key.	To create an SSH key pair, see <a href="#">Generate SSH keys</a> in the AWS Transfer Family documentation.	Developer, Systems administrator

Task	Description	Skills required
Add users.	On the <a href="#">AWS Transfer Family console</a> , choose <b>Servers</b> , select the SFTP server you created, and then choose <b>Add user</b> . For <b>Home directory</b> , choose the S3 bucket you created. For <b>SSH public key</b> , specify the public key portion of the SSH key pair. Add users for the SFTP server, and then choose <b>Add</b> .	Developer, Systems administrator

### Test the SFTP server

Task	Description	Skills required
Update the security group.	In the <b>Security Groups</b> section of your SFTP server, add your test machine's IP to gain SFTP access.	Developer
Use an SFTP client utility to test the server.	Test file transfers by using any SFTP client utility. For a list of clients and instructions, see <a href="#">Transferring files using a client</a> in the AWS Transfer Family documentation.	Developer

### Related resources

- [AWS Transfer Family User Guide](#)
- [Amazon S3 User Guide](#)
- [Elastic IP addresses](#) in the Amazon EC2 documentation

## Attachments

To access additional content that is associated with this document, unzip the following file:  
[attachment.zip](#)

# Migrate an on-premises VM to Amazon EC2 by using AWS Application Migration Service

Created by Thanh Nguyen (AWS)

<b>Environment:</b> Production	<b>Source:</b> On-premises virtual machine	<b>Target:</b> Amazon EC2
<b>R Type:</b> Rehost	<b>Technologies:</b> Migration	<b>AWS services:</b> AWS MGN; Amazon EC2; Amazon EBS

## Summary

When it comes to application migration, organizations can take different approaches to rehost (lift and shift) the application's servers from the on-premises environment to the Amazon Web Services (AWS) Cloud. One way is to provision new Amazon Elastic Compute Cloud (Amazon EC2) instances and then install and configure the application from scratch. Another approach is to use third-party or AWS native migration services to migrate multiple servers at the same time.

This pattern outlines the steps for migrating a supported virtual machine (VM) to an Amazon EC2 instance on the AWS Cloud by using AWS Application Migration Service. You can use the approach in this pattern to migrate one or multiple virtual machines manually, one by one, or automatically by creating appropriate automation scripts based on the outlined steps.

## Prerequisites and limitations

### Prerequisites

- An active AWS account in one of the AWS Regions that support Application Migration Service
- Network connectivity between the source server and target EC2 server through a private network by using AWS Direct Connect or a virtual private network (VPN), or through the internet

### Limitations

- For the latest list of supported Regions, see the [Supported AWS Regions](#).
- For a list of supported operating systems, see the [Supported operating systems](#) and the *General* section of [Amazon EC2 FAQs](#).

## Architecture

### Source technology stack

- A physical, virtual, or cloud-hosted server running an operating system supported by Amazon EC2

### Target technology stack

- An Amazon EC2 instance running the same operating system as the source VM
- Amazon Elastic Block Store (Amazon EBS)

### Source and target architecture

The following diagram shows the high-level architecture and main components of the solution. In the on-premises data center, there are virtual machines with local disks. On AWS, there is a staging area with replication servers and a migrated resources area with EC2 instances for test and cutover. Both subnets contain EBS volumes.

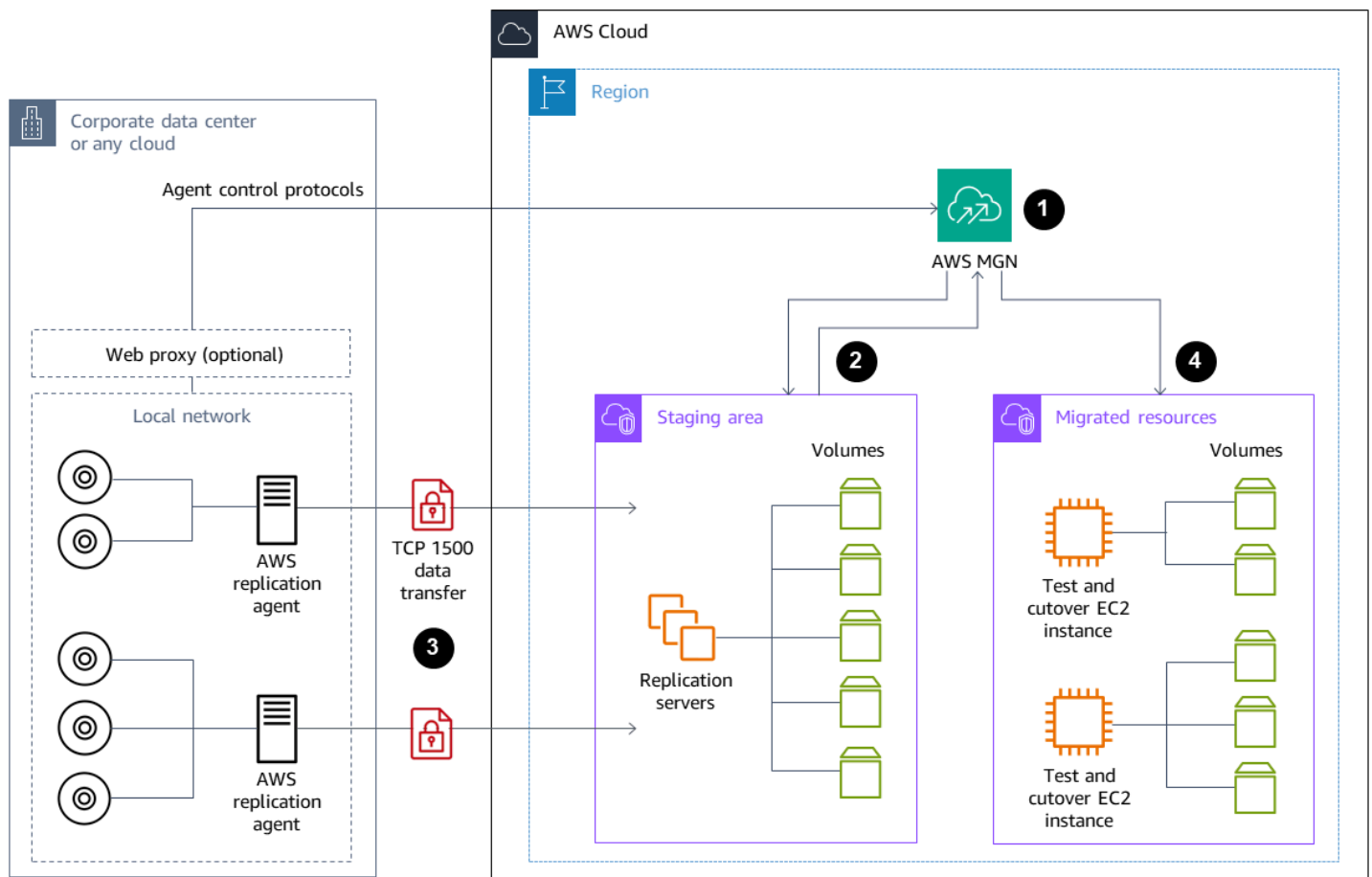

1. Initialize AWS Application Migration Service.
2. Set up the staging area server configuration and reporting, including staging area resources.
3. Install agents on source servers, and use continuous block-level data replication (compressed and encrypted).
4. Automate orchestration and system conversion to shorten the cutover window.

## Network architecture

The following diagram shows the high-level architecture and main components of the solution from the networking perspective, including required protocols and ports for communication between primary components in the on-premises data center and on AWS.

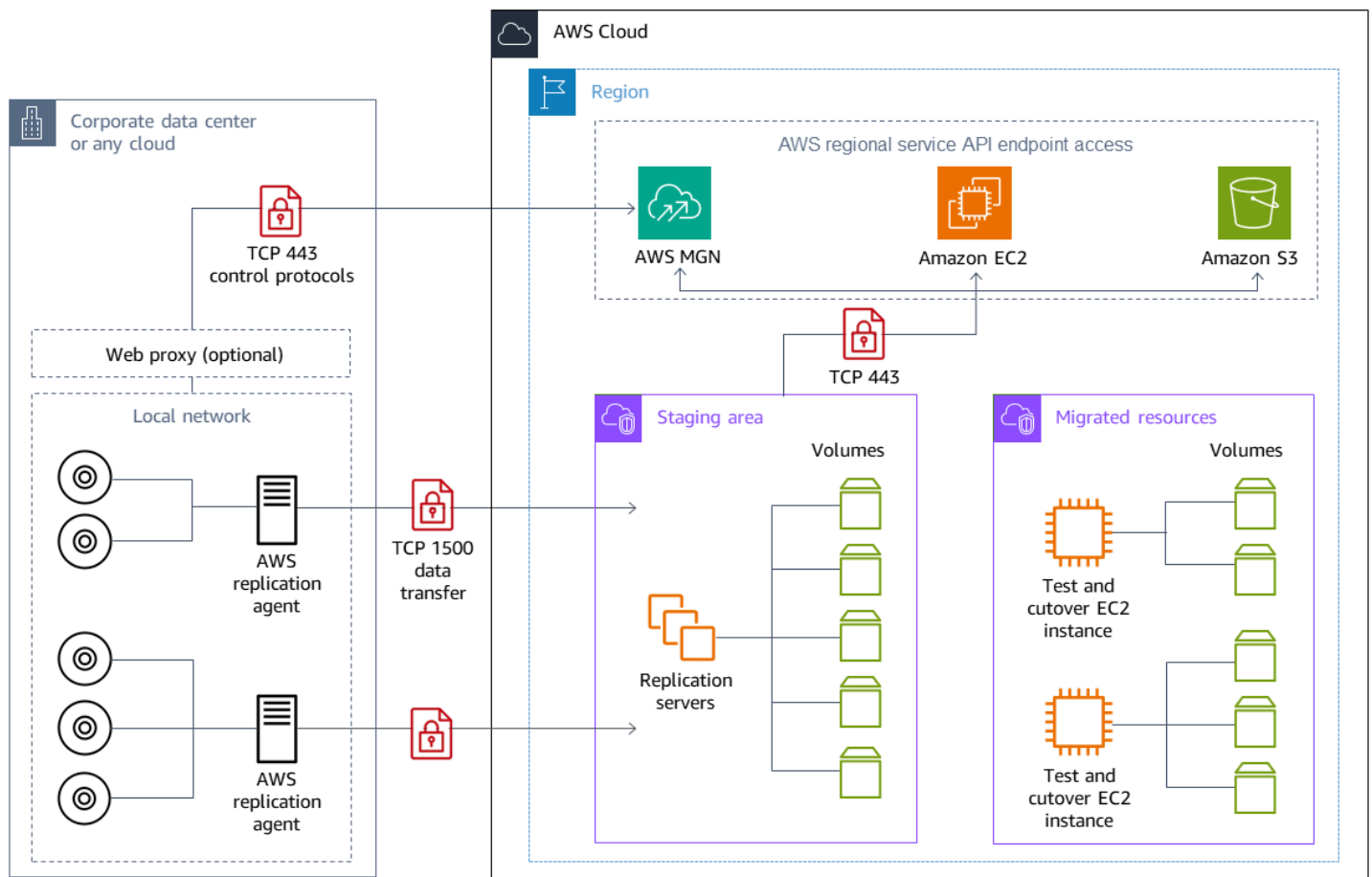

## Tools

- [AWS Application Migration Service](#) helps you rehost (*lift and shift*) applications to the AWS Cloud without change and with minimal downtime.

## Best practices

- Do not take the source server offline or perform a reboot until the cutover to the target EC2 instance is complete.
- Provide ample opportunity for the users to perform user acceptance testing (UAT) on the target server to identify and resolve any issues. Ideally, this testing should start at least two weeks before cutover.
- Frequently monitor the server replication status on the Application Migration Service console to identify issues early on.

- Use temporary AWS Identity and Access Management (IAM) credentials for agent installation instead of permanent IAM user credentials.

## Epics

### Generate AWS credentials

Task	Description	Skills required
Create the AWS Replication Agent IAM role.	<p>Sign in with administrative permissions to the AWS account.</p> <p>On the AWS Identity and Access Management (IAM) <a href="#">console</a>, create an IAM role:</p> <ol style="list-style-type: none"><li>1. On the IAM console, choose <b>Roles</b>.</li><li>2. Choose <b>Create role</b>.</li><li>3. On the <b>Select trusted entity</b> page, in <b>Trusted entity type</b> section, select <b>AWS Account</b>.</li><li>4. In the <b>An AWS account</b> section, select <b>This account (&lt;account-id&gt;)</b>.</li><li>5. Choose <b>Next</b>.</li><li>6. On the <b>Add permissions</b> page, search for the <code>AWSApplicationMigrationAgentInstallationPolicy</code> policy, select the check box next to the policy name.</li><li>7. Choose <b>Next</b>.</li></ol>	AWS administrator, Migration engineer



Task	Description	Skills required
	<ol style="list-style-type: none"><li data-bbox="591 212 1029 390">8. On the <b>Role details</b> page, enter <b>MGN_Agent_Installation_Role</b> as the role name.</li><li data-bbox="591 411 1029 541">9. Verify that the fields are correct, and then choose <b>Create role</b>.</li></ol>	

Task	Description	Skills required
<p>Generate temporary security credentials.</p>	<p>On a machine with AWS Command Line Interface (AWS CLI) installed, sign in with administrative permissions. Or alternatively (within a supported AWS Region), on the AWS Management Console, sign in with administrative permissions to the AWS account, and open AWS CloudShell.</p> <p>Generate temporary credentials with the following command, replacing <code>&lt;account-id&gt;</code> with the AWS account ID.</p> <pre>aws sts assume-role --role-arn arn:aws:iam::&lt;account-id&gt;:role/MGN_Agent_Installation_Role -- role-session-name mgn_installation_session_role</pre> <p>From the output of the command, copy the values for <code>AccessKeyId</code> , <code>SecretAccessKey</code> , and <code>SessionToken</code> . Store them in a safe location for later use.</p> <p><b>Important:</b> These temporary credentials will expire</p>	<p>AWS administrator, Migration engineer</p>

Task	Description	Skills required
	after one hour. If you need credentials after one hour, repeat the previous steps.	

## Initialize Application Migration Service and create the Replication Settings template

Task	Description	Skills required
Initialize the service.	<p>On the console, sign in with administrative permissions to the AWS account.</p> <p>Choose <b>Application Migration Service</b>, and then choose <b>Get started</b>.</p>	AWS administrator, Migration engineer
Create and configure the Replication Settings template.	<ol style="list-style-type: none"> <li>1. Provide the following configuration details: <ol style="list-style-type: none"> <li>a. Select the staging area subnet.</li> <li>b. Select the replication server instance type (t3.small by default).</li> <li>c. Select the EBS volume type (gp3 by default).</li> <li>d. Select the EBS encryption option.</li> <li>e. Ensure that the <b>Always use Application Migration Service security group</b> check box is selected.</li> <li>f. Select the <b>Use private IP for data replication</b></li> </ol> </li> </ol>	AWS administrator, Migration engineer

Task	Description	Skills required
	<p><b>(VPN, DirectConnect, VPC peering)</b> check box if you are using private network connectivity between the on-premises environment and AWS.</p> <p>g. Select the <b>Throttle network bandwidth (per server - in Mbps)</b> check box if you want to limit the network bandwidth for Application Migration Service.</p> <p>2. Choose <b>Create template</b>.</p> <p>Application Migration Service will automatically create all the IAM roles required to facilitate data replication and the launching of migrated servers.</p>	

## Install AWS Replication Agents on source machines

Task	Description	Skills required
Have the required AWS credentials ready.	When you run the installer file on a source server, you will need to enter the temporary credentials that you generated earlier, including AccessKeyId ,	Migration engineer, AWS administrator

Task	Description	Skills required
	SecretAccessKey , and SessionToken .	
For Linux servers, install the agent.	Copy the installer command, log in to your source servers, and run the installer. For detailed instructions, see the <a href="#">AWS documentation</a> .	AWS administrator, Migration engineer
For Windows servers, install the agent.	Download the installer file to each server, and then run the installer command. For detailed instructions, see the <a href="#">AWS documentation</a> .	AWS administrator, Migration engineer
Wait for initial data replication to be completed.	When the agent has been installed, the source server will appear on the Application Migration Service console, in the <b>Source servers</b> section. Wait while the server undergoes initial data replication.	AWS administrator, Migration engineer

## Configure launch settings

Task	Description	Skills required
Specify the server details.	On the Application Migration Service console, choose the <b>Source servers</b> section, and then choose a server name from the list to access the server details.	AWS administrator, Migration engineer

Task	Description	Skills required
Configure the launch settings.	Choose the <b>Launch settings</b> tab. You can configure a variety of settings, including general launch settings and EC2 launch template settings. For detailed instructions, see the <a href="#">AWS documentation</a> .	AWS administrator, Migration engineer

## Perform a test

Task	Description	Skills required
Test the source servers.	<ol style="list-style-type: none"> <li>1. On the Application Migration Service console, in the <b>Source servers</b> section, ensure that the source servers' <b>Migration lifecycle</b> is <b>Ready for testing</b> and that <b>Data replication status</b> is <b>Healthy</b>.</li> <li>2. Select the check box to the left of each source server.</li> <li>3. Choose <b>Test and Cutover</b>, and then choose <b>Launch Test Instance</b>.</li> <li>4. When prompted, choose <b>Launch</b>.</li> </ol> <p>The servers will be launched.</p>	AWS administrator, Migration engineer
Verify that the test completed successfully.	After the test server is completely launched, the	AWS administrator, Migration engineer

Task	Description	Skills required
	<b>Alerts</b> status on the page will show <b>Launched</b> for each server.	
Test the server.	Perform testing against the test server to ensure that it functions as expected.	AWS administrator, Migration engineer

### Schedule and perform a cutover

Task	Description	Skills required
Schedule a cutover window.	Schedule an appropriate cutover timeframe with relevant teams.	AWS administrator, Migration engineer
Perform the cutover.	<ol style="list-style-type: none"> <li>1. On the Application Migration console, on the <b>Source Servers</b> page, select the check box to the left of each source server.</li> <li>2. Choose <b>Test and Cutover</b>, and select <b>Mark as 'Ready for cutover'</b>.</li> <li>3. Verify that each source server's <b>Migration lifecycle</b> is <b>Ready for cutover</b>.</li> <li>4. Choose <b>Test and Cutover</b>, and then select <b>Launch cutover instances</b>.</li> <li>5. When prompted, choose <b>Launch</b>. The servers will be launched.</li> </ol>	AWS administrator, Migration engineer

Task	Description	Skills required
	The source server's <b>Migration lifecycle</b> will change to <b>Cutover in progress</b> .	
Verify that the cutover completed successfully.	After the cutover servers are completely launched, the <b>Alerts</b> status on the <b>Source Servers</b> page will show <b>Launched</b> for each server.	AWS administrator, Migration engineer
Test the server.	Perform testing against the cutover server to ensure that it functions as expected.	AWS administrator, Migration engineer
Finalize the cutover.	Choose <b>Test and Cutover</b> , and then select <b>Finalize cutover</b> to finalize the migration process.	AWS administrator, Migration engineer

## Related resources

- [AWS Application Migration Service](#)
- [AWS Application Migration Service User Guide](#)



# Migrate small sets of data from on premises to Amazon S3 using AWS SFTP

Created by Charles Gibson (AWS) and Sergiy Shevchenko (AWS)

<b>R Type:</b> Rehost	<b>Source:</b> Storage	<b>Target:</b> Amazon S3
<b>Created by:</b> AWS	<b>Environment:</b> Production	<b>Technologies:</b> Storage & backup; Migration
<b>AWS services:</b> Amazon S3		

## Summary

This pattern describes how to migrate small sets of data (5 TB or less) from on-premises data centers to Amazon Simple Storage Service (Amazon S3) by using AWS Transfer for SFTP (AWS SFTP). The data can be either database dumps or flat files.

## Prerequisites and limitations

### Prerequisites

- An active AWS account
- An AWS Direct Connect link established between your data center and AWS

### Limitations

- The data files must be less than 5 TB. For files over 5 TB, you can perform a multipart upload to Amazon S3 or choose another data transfer method.

## Architecture

### Source technology stack

- On-premises flat files or database dumps

### Target technology stack

- Amazon S3

## Source and target architecture

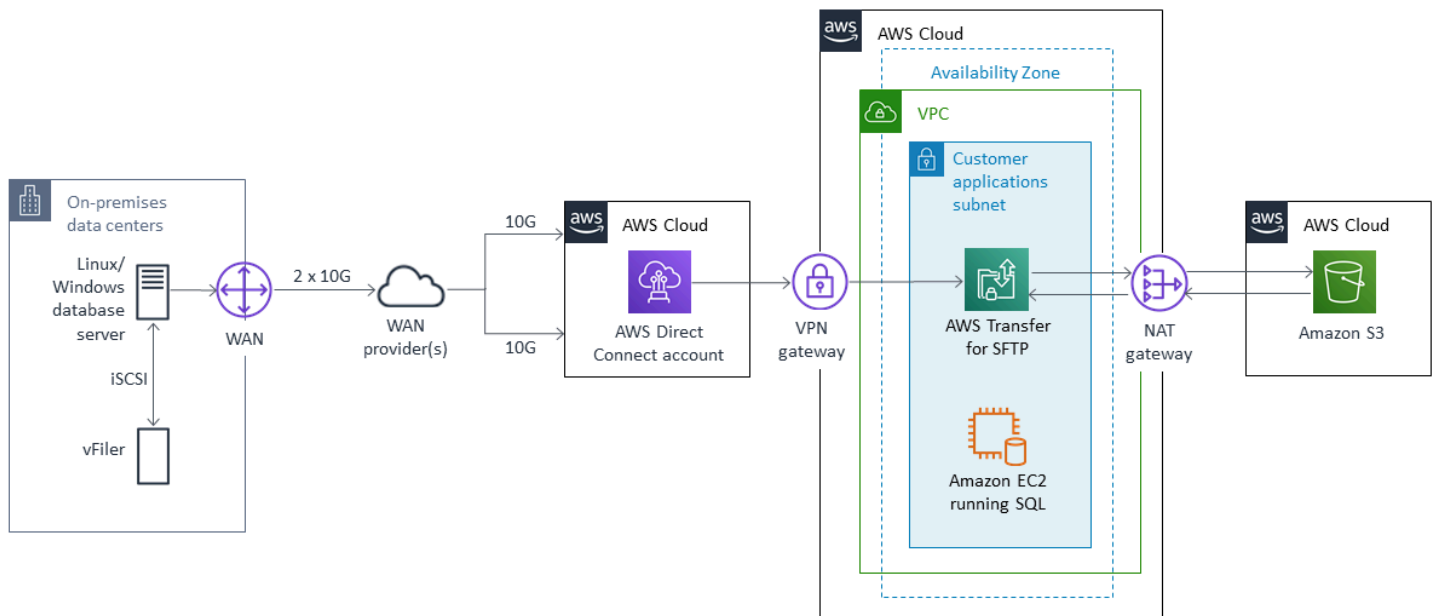

## Tools

- [AWS SFTP](#) – Enables the transfer of files directly into and out of Amazon S3 using Secure File Transfer Protocol (SFTP).
- [AWS Direct Connect](#) – Establishes a dedicated network connection from your on-premises data centers to AWS.
- [VPC endpoints](#) – Enable you to privately connect a VPC to supported AWS services and VPC endpoint services powered by AWS PrivateLink without an internet gateway, network address translation (NAT) device, VPN connection, or AWS Direct Connect connection. Instances in a VPC don't require public IP addresses to communicate with resources in the service.

## Epics

### Prepare for the migration

Task	Description	Skills required
Document the current SFTP requirements.		Application owner, SA
Identify the authentication requirements.	Requirements may include key-based authentication, user name or password, or identity provider (IdP).	Application owner, SA
Identify the application integration requirements.		Application owner
Identify the users who require the service.		Application owner
Determine the DNS name for the SFTP server endpoint.		Networking
Determine the backup strategy.		SA, DBA (if data is transferred)
Identify the application migration or cutover strategy.		Application owner, SA, DBA

### Configure the infrastructure

Task	Description	Skills required
Create one or more virtual private clouds (VPCs) and subnets in your AWS account.		Application owner, AMS

Task	Description	Skills required
Create the security groups and network access control list (ACL).		Security, Networking, AMS
Create the S3 bucket.		Application owner, AMS
Create the identity and access management (IAM) role.	Create an IAM policy that includes the permissions to enable AWS SFTP to access your S3 bucket. This IAM policy determines what level of access you provide SFTP users. Create another IAM policy to establish a trust relationship with AWS SFTP.	Security, AMS
Associate a registered domain (optional).	If you have your own registered domain, you can associate it with the SFTP server. You can route SFTP traffic to your SFTP server endpoint from a domain or from a subdomain.	Networking, AMS
Create an SFTP server.	Specify the identity provider type used by the service to authenticate your users.	Application owner, AMS

Task	Description	Skills required
Open an SFTP client.	Open an SFTP client and configure the connection to use the SFTP endpoint host. AWS SFTP supports any standard SFTP client. Commonly used SFTP clients include OpenSSH, WinSCP, Cyberduck, and FileZilla. You can get the SFTP server host name from the AWS SFTP console.	Application owner, AMS

## Plan and test

Task	Description	Skills required
Plan the application migration.	Plan for any application configuration changes required, set the migration date, and determine the test schedule.	Application owner, AMS
Test the infrastructure.	Test in a non-production environment.	Application owner, AMS

## Related resources

### References

- [AWS Transfer for SFTP User Guide](#)
- [AWS Direct Connect resources](#)
- [VPC Endpoints](#)

## Tutorials and videos

- [AWS Transfer for SFTP \(video\)](#)
- [AWS Transfer for SFTP user guide](#)
- [AWS SA Whiteboarding - Direct Connect \(video\)](#)

# Migrate from Oracle GlassFish to AWS Elastic Beanstalk

Created by Sandeep Bondugula (AWS)

<b>Environment:</b> PoC or pilot	<b>Source:</b> Application Development	<b>Target:</b> AWS Elastic Beanstalk
<b>R Type:</b> Rehost	<b>Workload:</b> Open-source; Oracle	<b>Technologies:</b> Migration; Containers & microservices; Web & mobile apps
<b>AWS services:</b> AWS Elastic Beanstalk		

## Summary

This pattern describes how to migrate a Java application running on an on-premises Oracle GlassFish server to AWS Elastic Beanstalk in the AWS Cloud.

On AWS, the Java application is deployed on a Docker GlassFish server with AWS Elastic Beanstalk, which runs in an Amazon Elastic Compute Cloud (Amazon EC2) Auto Scaling group.

Additional features:

- Amazon Elastic Beanstalk acts as a wrapper for several underlying resources. It sets up Elastic Load Balancing (which handles incoming traffic from Amazon Route 53), disperses the traffic to one or more EC2 instances, and also serves as a deployment tool.
- To migrate an on-premises database to Amazon Relational Database Service (Amazon RDS), update the database connection details. In the backend database, you can configure Amazon RDS Multi-AZ deployments and choose the database engine type.
- You can use Multi-AZ deployment for high availability along with the Auto Scaling group and scaling policy to improve resiliency.
- You can set up a scaling policy based on Amazon CloudWatch metrics.
- In AWS Elastic Beanstalk, you can configure the underlying Elastic Load Balancing settings and Amazon EC2 Auto Scaling.

## Prerequisites and limitations

### Prerequisites

- An active AWS account
- An on-premises Java application running on GlassFish
- A Java Web Application Resource (WAR) file

### Product versions

- Oracle Glassfish 4.1.2 and 5.0
- Java 7 GlassFish 4.0
- Java 8 GlassFish 4.1 or later

## Architecture

### Source technology stack

- Applications developed in GlassFish

### Target technology stack

- Elastic Beanstalk

### Target architecture



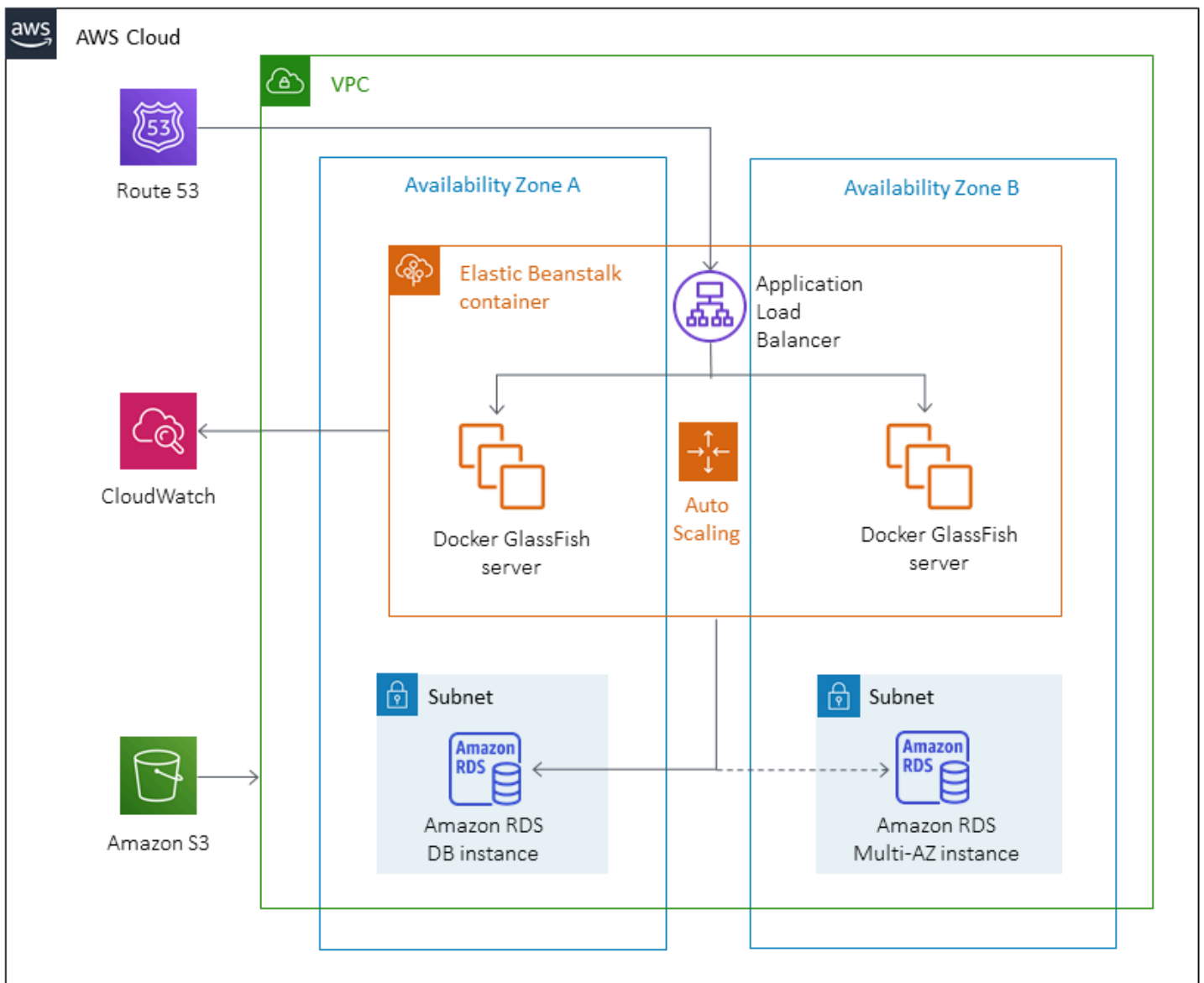

### Deployment workflow

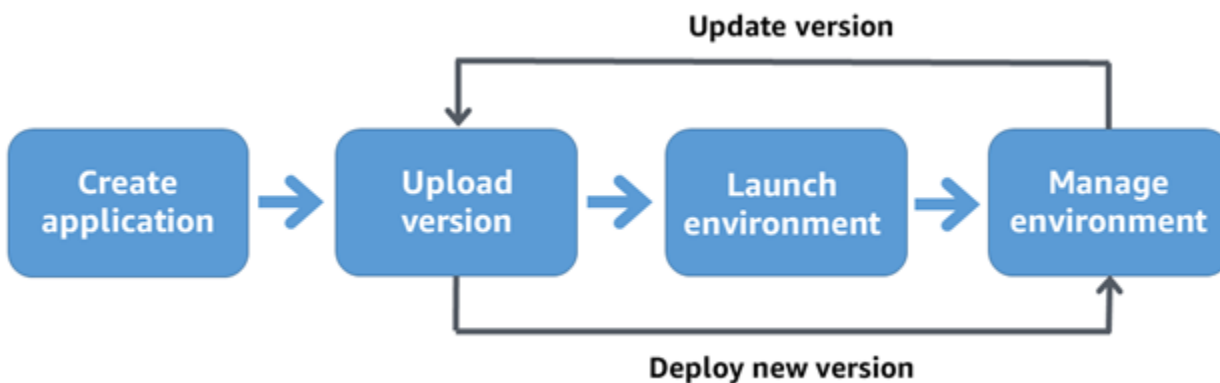

## Tools

- [Amazon Elastic Beanstalk](#) – A service for deploying and scaling web applications and services developed with Java, .NET, PHP, Node.js, Python, Ruby, Go, and Docker on servers including Apache, NGINX, Passenger, and IIS.
- [Amazon CloudWatch](#) – Provides data and actionable insights to monitor applications, responds to systemwide performance changes, optimizes resource utilization, and provides a unified view of operational health.
- [Docker](#) – A platform that packages software into standardized units to build, test, and deploy applications quickly.
- [Java](#) – A general-purpose programming language. Java is class-based, object-oriented, and designed to have fewer implementation dependencies.

## Epics

### Set up a VPC

Task	Description	Skills required
Create a virtual private cloud (VPC) instance with the required information.		SysAdmin
Create at least two subnets within the VPC.		SysAdmin
Create a route table per requirements.		SysAdmin

### Set up Amazon S3

Task	Description	Skills required
Create an Amazon Simple Storage Service (Amazon S3) bucket.		SysAdmin

Task	Description	Skills required
Copy the WAR file to the S3 bucket and upload the application code.		SysAdmin

## Create an IAM role

Task	Description	Skills required
Create an AWS Identity and Access Management (IAM) role.	You can use the default "aws-elasticbeanstalk-ec2-role" profile, or let Elastic Beanstalk create it automatically.	SysAdmin

## Set up Elastic Beanstalk

Task	Description	Skills required
Open the Elastic Beanstalk dashboard.		SysAdmin
Create a new application and choose the web server environment.		SysAdmin
Choose GlassFish Docker as the preconfigured platform.		SysAdmin
Upload the code.	Provide the S3 bucket file URL or ZIP file from local system files.	SysAdmin

Task	Description	Skills required
Choose the environment type.	In Configuration Capacity settings, choose either Single Instance or Load Balancer.	SysAdmin
Configure Load Balancer.	If you chose Load Balancer in the previous step, configure the Multi-AZ deployment.	SysAdmin
In Configuration Security settings, choose the previously created IAM role.		SysAdmin
In Configuration Security settings, if you have an existing key pair, use it or create a new Amazon EC2 key pair.		SysAdmin
In Configuration Monitoring settings, configure Amazon CloudWatch.		SysAdmin
In Configuration Security settings, choose the previously created VPC.		SysAdmin
Choose Create Environment.		SysAdmin

## Test the application

Task	Description	Skills required
Test the application by using the URL provided in the created environment.		

Task	Description	Skills required
Apply the Domain Name Service (DNS) changes in Amazon Route 53.		

## Related resources

- [Oracle GlassFish documentation](#)
- [GlassFish Open Source Java EE Reference Implementation](#)
- [AWS Elastic Beanstalk documentation](#)
- [Using Elastic Beanstalk with Amazon CloudWatch](#)
- [AWS Elastic Beanstalk pricing](#)
- [EC2 Auto Scaling Group](#)
- [Scaling the Size of Your Auto Scaling Group](#)
- [Amazon RDS Multi-AZ Deployments](#)

# Migrate an on-premises Oracle database to Oracle on Amazon EC2

Created by *Baji Shaik (AWS)* and *Pankaj Choudhary (AWS)*

<b>Environment:</b> PoC or pilot	<b>Source:</b> Databases: Relational	<b>Target:</b> Oracle on Amazon EC2
<b>R Type:</b> Rehost	<b>Workload:</b> Oracle	<b>Technologies:</b> Migration; Databases
<b>AWS services:</b> Amazon EC2		

## Summary

This pattern walks you through the steps for migrating an on-premises Oracle database to Oracle on an Amazon Elastic Compute Cloud (Amazon EC2) instance. It describes two options for migration: using AWS Data Migration Service (AWS DMS) or using native Oracle tools such as RMAN, Data Pump import/export, transportable tablespaces, and Oracle GoldenGate.

## Prerequisites and limitations

### Prerequisites

- An active AWS account
- A source Oracle database in an on-premises data center

### Limitations

- The target operating system (OS) must be supported by Amazon EC2. For a complete list of supported systems, see [Amazon EC2 FAQs](#).

### Product versions

- Oracle versions 10.2 and later (for versions 10.x), 11g and up to 12.2, and 18c for the Enterprise, Standard, Standard One, and Standard Two editions. For the latest list of versions supported by AWS DMS, see "On-premises and Amazon EC2 instance databases" in [Sources for Data Migration](#) in the AWS DMS documentation.

## Architecture

### Source technology stack

- An on-premises Oracle database

### Target technology stack

- An Oracle database instance on Amazon EC2

### Target architecture

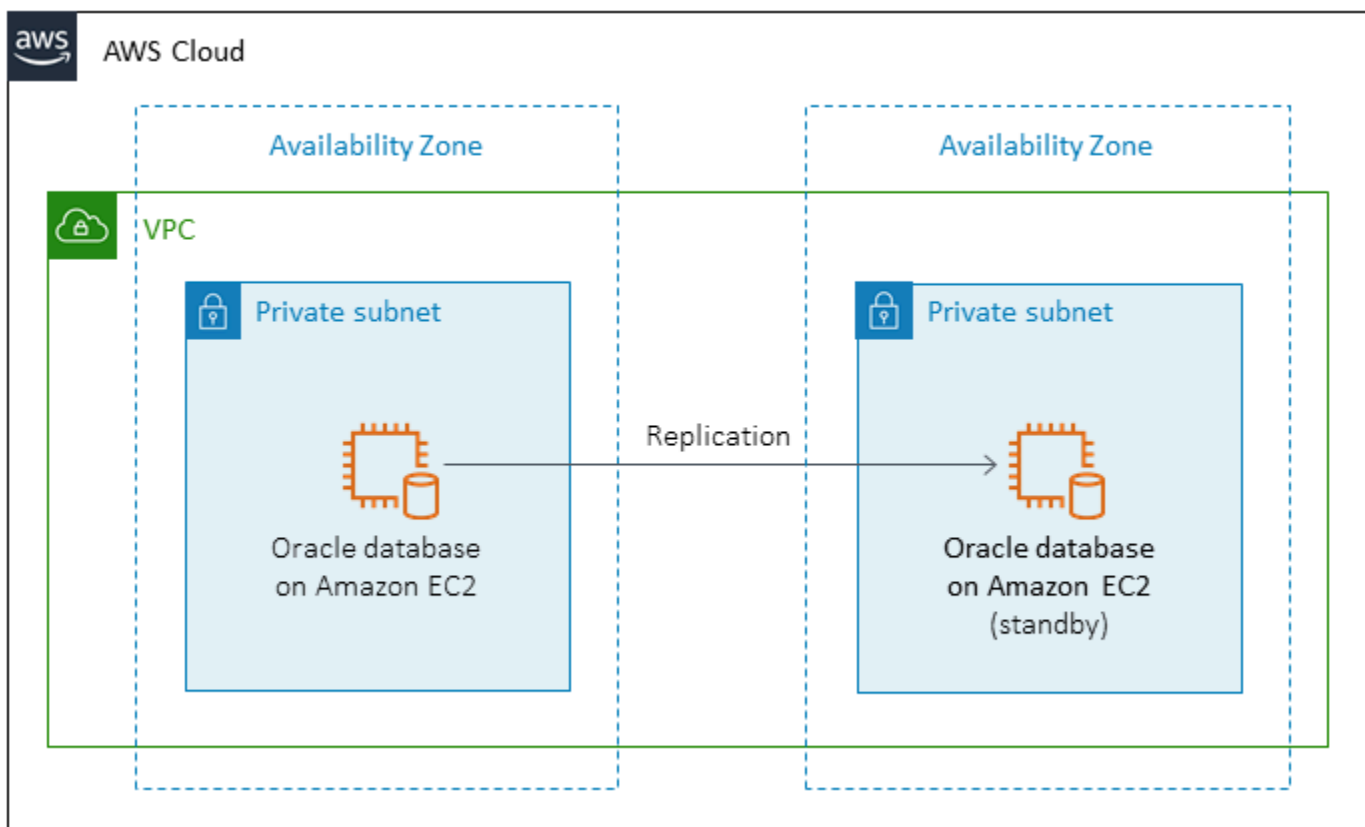

### Data migration architecture

*Using AWS DMS:*

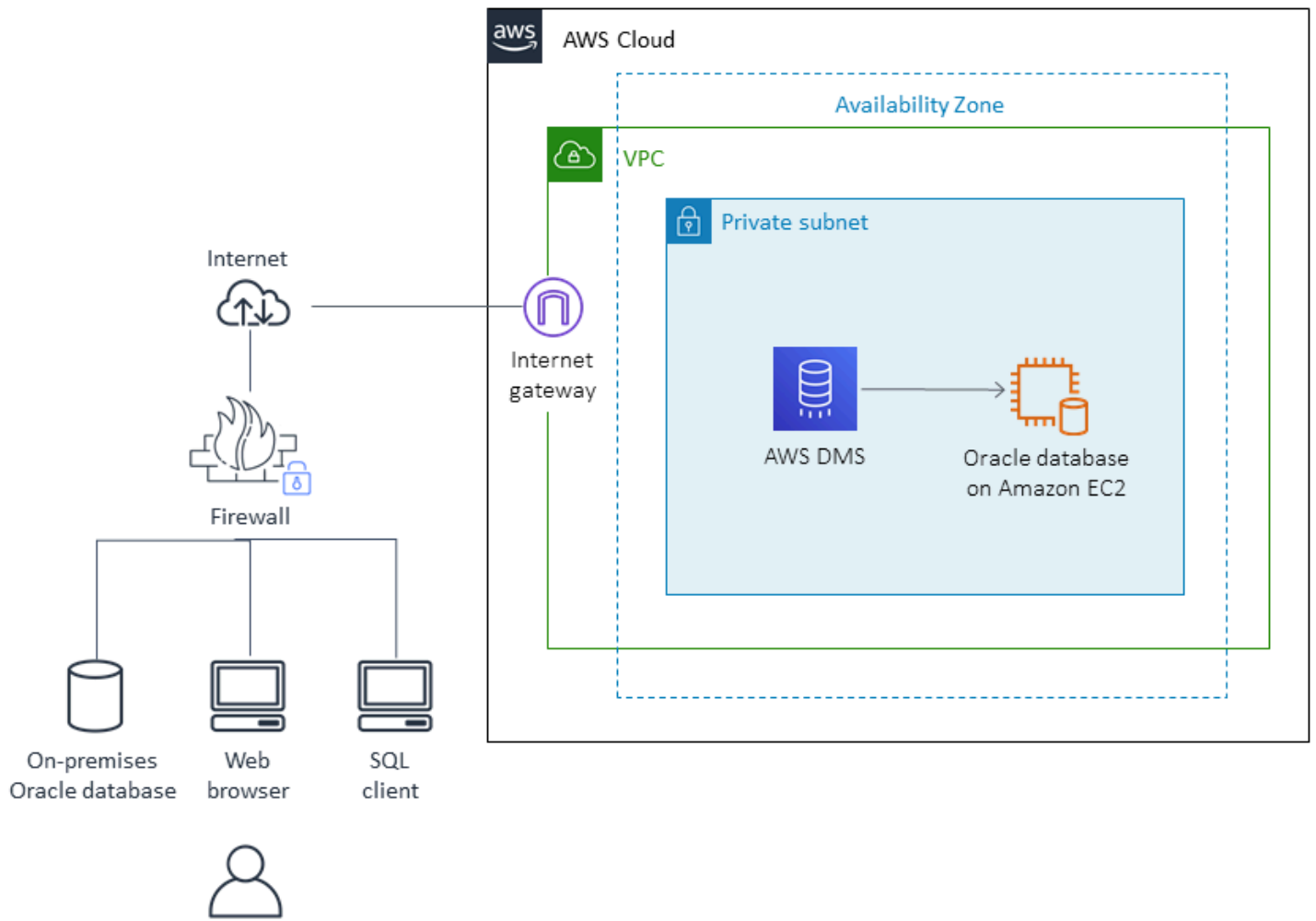

*Using native Oracle tools:*



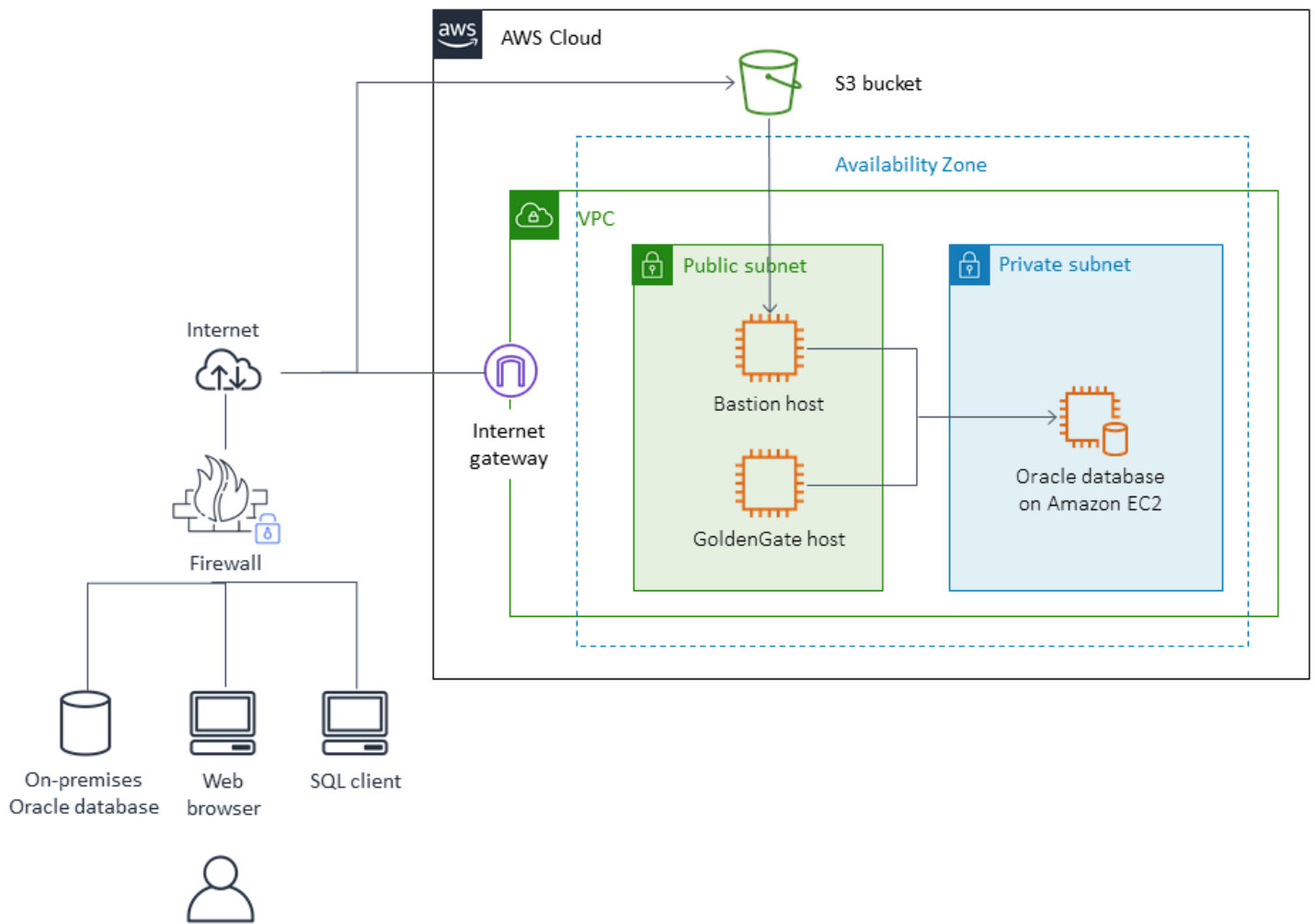

## Tools

- **AWS DMS** - [AWS Database Migration Services](#) (AWS DMS) supports several types of source and target databases. For information about the database versions and editions that are supported, see [Using an Oracle Database as a Source for AWS DMS](#). We recommend that you use the latest version of AWS DMS for the most comprehensive version and feature support.
- **Native Oracle tools** - RMAN, Data Pump import/export, transportable tablespaces, Oracle GoldenGate

## Epics

### Plan the migration

Task	Description	Skills required
Validate the versions of the source and target databases.		DBA
Identify the version of the target OS.		DBA, SysAdmin
Identify hardware requirements for the target server instance based on the Oracle compatibility list and capacity requirements.		DBA, SysAdmin
Identify storage requirements (storage type and capacity).		DBA, SysAdmin
Identify network requirements (latency and bandwidth).		DBA, SysAdmin
Choose the proper instance type based on capacity, storage features, and network features.		DBA, SysAdmin
Identify network/host access security requirements for source and target databases.		DBA, SysAdmin
Identify a list of OS users required for Oracle software installation.		DBA, SysAdmin

Task	Description	Skills required
Download AWS Schema Conversion Tool (AWS SCT) and drivers.		DBA
Create an AWS SCT project for the workload, and connect to the source database.		DBA
Generate SQL files for the creation of objects (tables, indexes, sequences, etc.).		DBA
Determine a backup strategy.		DBA, SysAdmin
Determine availability requirements.		DBA
Identify the application migration/switch-over strategy.		DBA, SysAdmin, App owner

## Configure the infrastructure

Task	Description	Skills required
Create a virtual private cloud (VPC) and subnets in your AWS account.		SysAdmin
Create security groups and network access control lists (ACLs).		SysAdmin
Configure and start the EC2 instance.		SysAdmin

## Install the Oracle software

Task	Description	Skills required
Create the OS users and groups required for the Oracle software.		DBA, SysAdmin
Download the required version of Oracle software.		
Install the Oracle software on the EC2 instance.		DBA, SysAdmin
Create objects like tables, primary keys, views, and sequences by using the scripts generated by AWS SCT.		DBA

## Migrate data - option 1

Task	Description	Skills required
Use native Oracle tools or third-party tools to migrate database objects and data.	Oracle tools include Data Pump import/export, RMAN, transportable tablespaces, and GoldenGate.	DBA

## Migrate data - option 2

Task	Description	Skills required
Determine the migration method.		DBA

Task	Description	Skills required
Create a replication instance in the AWS DMS console.		DBA
Create source and target endpoints.		DBA
Create a replication task.		DBA
Enable change data capture (CDC) to capture changes for a continuous replication.		DBA
Run the replication task and monitor logs.		DBA
Create secondary objects like indexes and foreign keys when the full load is done.		DBA

## Migrate the application

Task	Description	Skills required
Follow the application migration strategy.		DBA, SysAdmin, App owner

## Cut over

Task	Description	Skills required
Follow the application cutover/switch-over strategy.		DBA, SysAdmin, App owner

## Close the project

Task	Description	Skills required
Shut down temporary AWS Secrets Manager resources.		DBA, SysAdmin
Review and validate the project documents.		DBA, SysAdmin, App owner
Gather metrics around time to migrate, % of manual vs. tool, cost savings, etc.		DBA, SysAdmin, App owner
Close out the project and provide feedback.		

## Related resources

### References

- [Strategies for Migrating Oracle Databases to AWS](#)
- [Migrating Oracle databases to the AWS Cloud](#)
- [Amazon EC2 website](#)
- [AWS DMS website](#)
- [AWS DMS blog posts](#)
- [Amazon EC2 Pricing](#)
- [Licensing Oracle Software in the Cloud Computing Environment](#)

### Tutorials and videos

- [Getting Started with Amazon EC2](#)
- [Getting Started with AWS DMS](#)
- [Introduction to Amazon EC2 - Elastic Cloud Server & Hosting with AWS \(video\)](#)

# Migrate an on-premises Oracle database to Amazon EC2 by using Oracle Data Pump

Created by Navakanth Talluri (AWS)

<b>Environment:</b> PoC or pilot	<b>Source:</b> On-premises Oracle database	<b>Target:</b> Oracle database on Amazon EC2
<b>R Type:</b> Rehost	<b>Workload:</b> Oracle	<b>Technologies:</b> Migration; Databases
<b>AWS services:</b> Amazon EC2; AWS Direct Connect		

## Summary

When migrating databases, you must consider factors such as the source and target database engines and versions, migration tools and services, and acceptable downtime periods. If you're migrating an on-premises Oracle database to Amazon Elastic Compute Cloud (Amazon EC2), you can use Oracle tools, such as Oracle Data Pump and Oracle Recovery Manager (RMAN). For more information about strategies, see [Migrating Oracle databases to the AWS Cloud](#).

Oracle Data Pump helps you extract the logical, consistent backup of the database and restore it to the target EC2 instance. This pattern describes how to migrate an on-premises Oracle database to an EC2 instance by using Oracle Data Pump and the NETWORK\_LINK parameter, with minimal downtime. The NETWORK\_LINK parameter starts an import through a database link. The Oracle Data Pump Import (impdp) client on the target EC2 instance connects to the source database, retrieves data from it, and writes the data directly to the database on the target instance. There are no backup, or *dump*, files used in this solution.

## Prerequisites and limitations

### Prerequisites

- An active AWS account.
- An on-premises Oracle database that:

- Isn't an Oracle Real Application Clusters (RAC) database
- Isn't an Oracle Automatic Storage Management (Oracle ASM) database
- Is in read-write mode.
- You have created an AWS Direct Connect link between your on-premises data center and AWS. For more information, see [Create a connection](#) (Direct Connect documentation).

## Product versions

- Oracle Database 10g release 1 (10.1) and later

## Architecture

### Source technology stack

- A standalone (non-RAC and non-ASM) Oracle database server in an on-premises data center

### Target technology stack

- An Oracle database running on Amazon EC2

### Target architecture

The [reliability pillar](#) of the AWS Well-Architected Framework recommends creating data backups to help provide high availability and resiliency. For more information, see [Architecting for high availability](#) in *Best Practices for Running Oracle Database on AWS*. This pattern sets up primary and standby databases on EC2 instances by using Oracle Active Data Guard. For high availability, the EC2 instances should be in different Availability Zones. However, the Availability Zones can be in the same AWS Region or in different AWS Regions.

Active Data Guard provides read-only access to a physical standby database and applies redo changes continuously from the primary database. Based on your recovery point objective (RPO) and recovery time objective (RTO), you can choose between synchronous and asynchronous redo transport options.

The following image shows the target architecture if the primary and standby EC2 instances are in different AWS Regions.



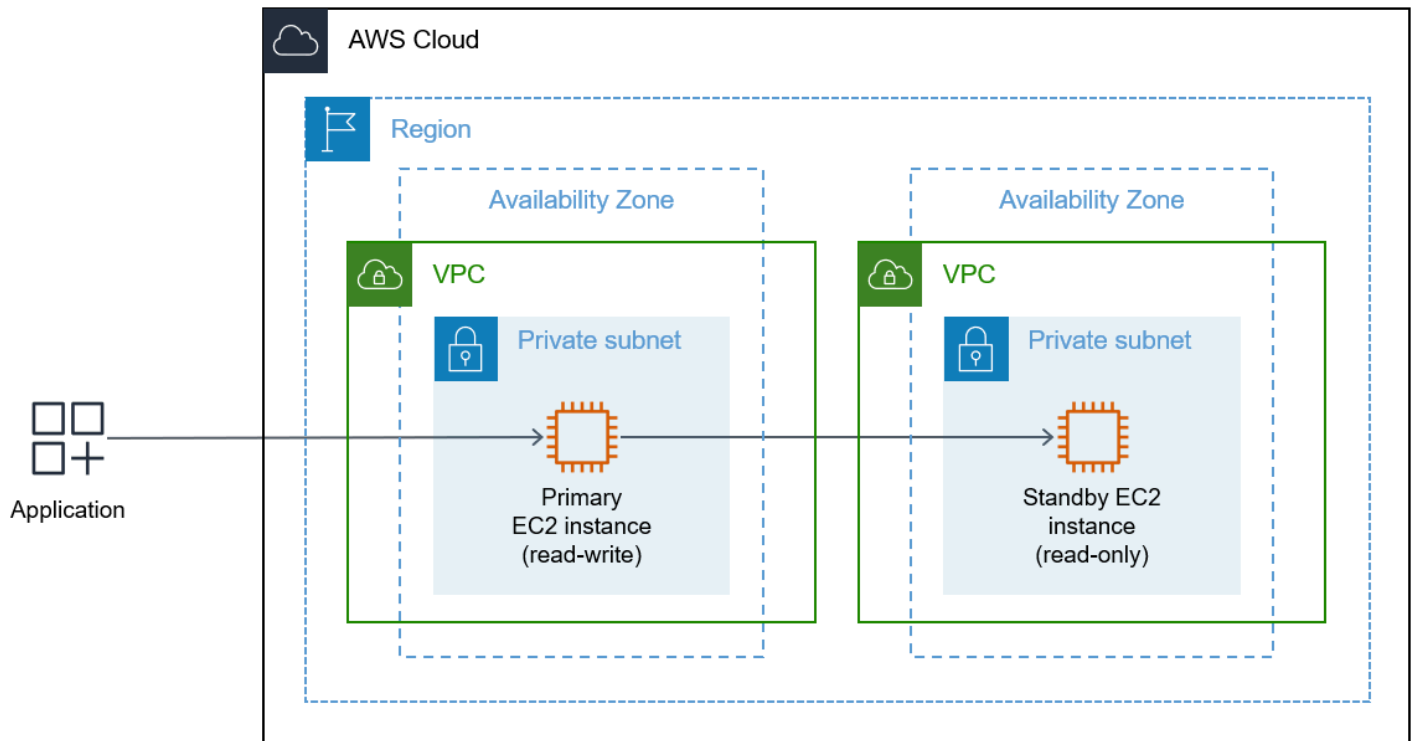

## Data migration architecture

After you have finished setting up the target architecture, you use Oracle Data Pump to migrate the on-premises data and schemas to the primary EC2 instance. During cutover, applications can't access the on-premises database or the target database. You shut down these applications until they can be connected to the new target database on the primary EC2 instance.

The following image shows the architecture during the data migration. In this sample architecture, the primary and standby EC2 instances are in different AWS Regions.

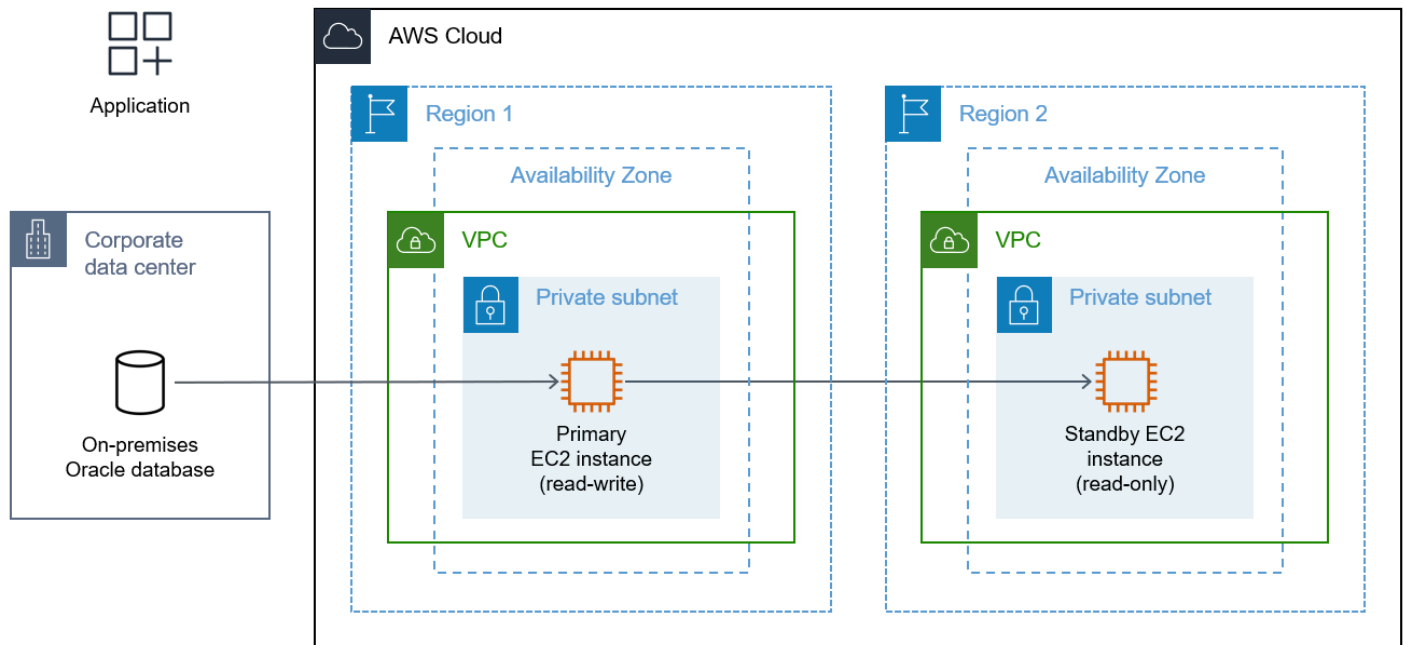

## Tools

### AWS services

- [AWS Direct Connect](#) links your internal network to a Direct Connect location over a standard Ethernet fiber-optic cable. With this connection, you can create virtual interfaces directly to public AWS services while bypassing internet service providers in your network path.
- [Amazon Elastic Compute Cloud \(Amazon EC2\)](#) provides scalable computing capacity in the AWS Cloud. You can launch as many virtual servers as you need and quickly scale them up or down.

### Other tools and services

- [Oracle Active Data Guard](#) helps you create, maintain, manage, and monitor standby databases.
- [Oracle Data Pump](#) helps you move data and metadata from one database to another at high speeds.

## Best practices

- [Best Practices for Running Oracle Database on AWS](#)
- [Importing data using NETWORK\\_LINK](#)

## Epics

### Set up the EC2 instances on AWS

Task	Description	Skills required
Identify the source hardware configuration for the on-premises host and the kernel parameters.	Validate the on-premises configuration, including storage size, input/output operations per second (IOPS), and CPU. This is important for Oracle licensing, which is based on CPU cores.	DBA, SysAdmin
Create the infrastructure on AWS.	Create the virtual private clouds (VPCs), private subnets, security groups, network access control lists (ACLs), route tables, and internet gateway. For more information, see the following : <ul style="list-style-type: none"> <li>• <a href="#">VPCs and subnets</a></li> <li>• <a href="#">Tutorial: Create a VPC for use with a database instance</a></li> </ul>	DBA, AWS systems administrator
Set up the EC2 instances by using Active Data Guard.	Configure AWS EC2 instances by using an Active Data Guard configuration, as described in the <a href="#">AWS Well-Architected Framework</a> . The version of Oracle Database on the EC2 instance can be different from the on-premises version because this pattern uses	DBA, AWS systems administrator

Task	Description	Skills required
	<p>logical backups. Note the following:</p> <ul style="list-style-type: none"> <li>Put the target database in read-write mode.</li> <li>On the target database, provide the Transparent Network Substrate (TNS) detail for the source database.</li> </ul> <p>For more information, see:</p> <ul style="list-style-type: none"> <li><a href="#">Starting Up a Database</a> (Oracle documentation)</li> <li><a href="#">Creating and Configuring an Oracle Database</a> (Oracle documentation)</li> </ul>	

## Migrate the database to Amazon EC2

Task	Description	Skills required
<p>Create a dblink to the on-premises database from the EC2 instance.</p>	<p>Create a database link (dblink) between the Oracle database on the EC2 instance and the on-premises Oracle database. For more information, see <a href="#">Using Network Link Import to Move Data</a> (Oracle documentation).</p>	<p>DBA</p>

Task	Description	Skills required
Verify the connection between the EC2 instance and the on-premises host.	Use the dblink to confirm that the connection between the EC2 instance and the on-premises database is functioning. For instructions, see <a href="#">CREATE DATABASE LINK</a> (Oracle documentation).	DBA
Stop all applications connected to the on-premises database.	After the database downtime is approved, shut down any applications and dependent jobs that connect to your on-premises database. You can do this either from the application directly or from the database by using cron. For more information, see <a href="#">Use the Crontab Utility to Schedule Tasks on Oracle Linux</a> .	DBA, App developer
Schedule the data migration job.	On the target host, use the command <code>impdp</code> to schedule the Data Pump import. This connects the target database to the on-premises host and starts the data migration . For more information, see <a href="#">Data Pump Import</a> and <a href="#">NETWORK_LINK</a> (Oracle documentation).	DBA

Task	Description	Skills required
Validate the data migration.	Data validation is a crucial step. For data validation, you can use custom tools or Oracle tools, such as a combination of dblink and SQL queries.	DBA

## Cut over

Task	Description	Skills required
Put the source database in read-only mode.	Confirm that the application is shut down and no changes are being made to the source database. Open the source database in read-only mode. This helps you avoid any open transactions. For more information, see ALTER DATABASE in <a href="#">SQL Statements</a> (Oracle documentation).	DBA, DevOps engineer, App developer
Validate the object count and data.	To validate the data and object, use custom tools or Oracle tools, such as a combination of dblink and SQL queries.	DBA, App developer
Connect the applications to the database on the primary EC2 instance.	Change the application's connection attribute to point to the new database you created on the primary EC2 instance.	DBA, App developer

Task	Description	Skills required
Validate the application performance.	Start the application. Validate the functionality and performance of the application by using <a href="#">Automated Workload Repository</a> (Oracle documentation).	App developer, DevOps engineer, DBA

## Related resources

### AWS references

- [Migrating Oracle databases to the AWS Cloud](#)
- [Amazon EC2 for Oracle](#)
- [Migrating bulky Oracle databases to AWS for cross-platform environments](#)
- [VPCs and subnets](#)
- [Tutorial: Create a VPC for use with a database instance](#)

### Oracle references

- [Oracle Data Guard Configurations](#)
- [Data Pump Import](#)

# Migrate an on-premises SAP ASE database to Amazon EC2

Created by Sergey Dmitriev (AWS) and Gergely Cserdi (AWS)

<b>R Type:</b> Rehost	<b>Source:</b> Databases: Relational	<b>Target:</b> SAP Adaptive Server Enterprise on Amazon EC2
<b>Created by:</b> AWS	<b>Environment:</b> PoC or pilot	<b>Technologies:</b> Databases; Migration
<b>Workload:</b> SAP	<b>AWS services:</b> Amazon EC2	

## Summary

This pattern describes how to migrate an SAP Adaptive Server Enterprise (ASE) database from an on-premises host to an Amazon Elastic Compute Cloud (Amazon EC2) instance. The pattern covers the use of AWS Database Migration Service (AWS DMS) or SAP ASE native tools such as ASE Cockpit, Sybase Central for ASE, and DBA Cockpit for migration.

## Prerequisites and limitations

### Prerequisites

- An active AWS account
- An SAP ASE source database in an on-premises data center

### Limitations

- The source database must be less than 64 TB

### Product versions

- SAP ASE version 15.x and 16.x or later

## Architecture

### Source technology stack



- On-premises SAP ASE database

### Target technology stack

- SAP ASE database on an EC2 instance

### Database migration architecture

*Using AWS DMS:*

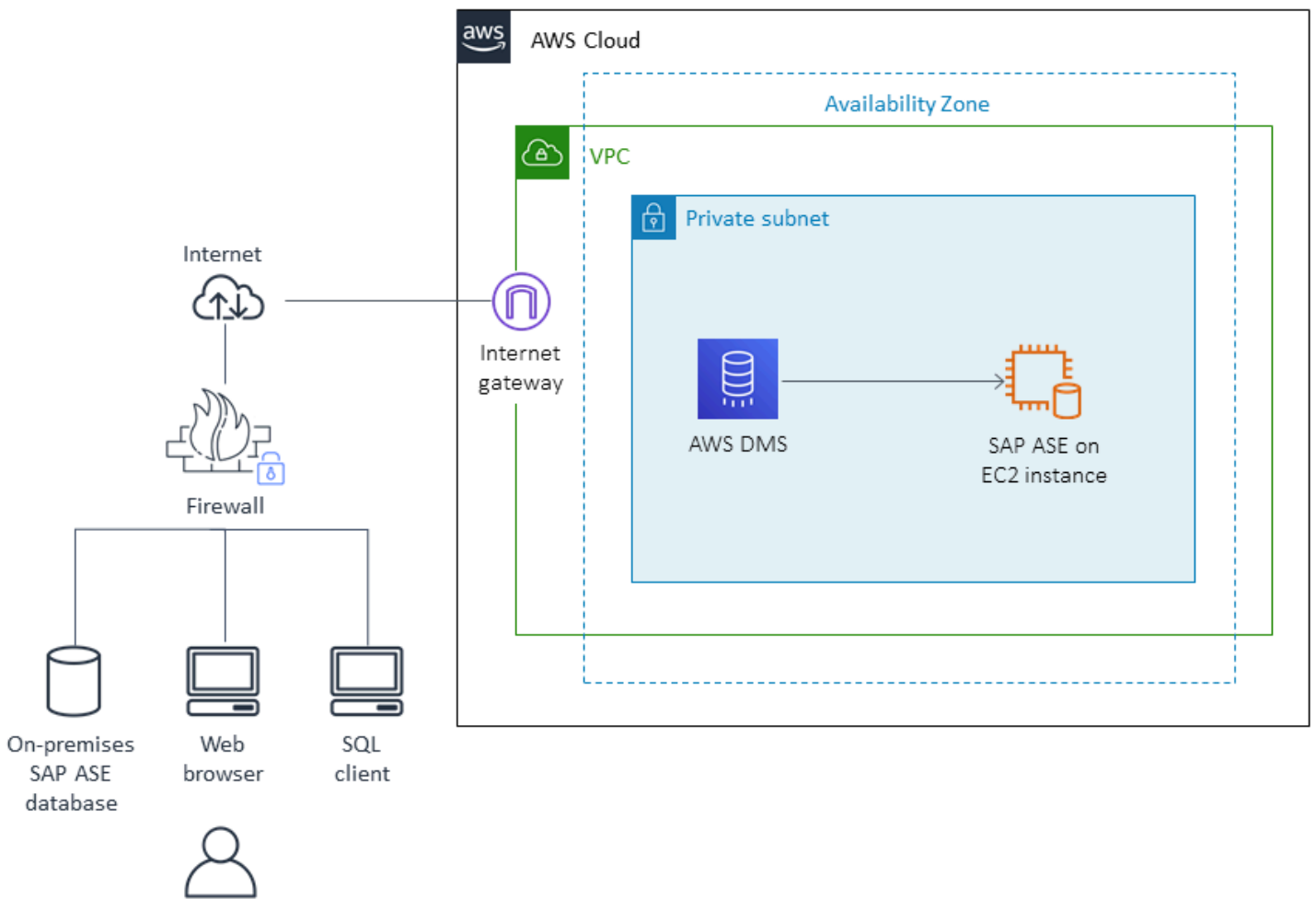

*Using native SAP ASE tools:*

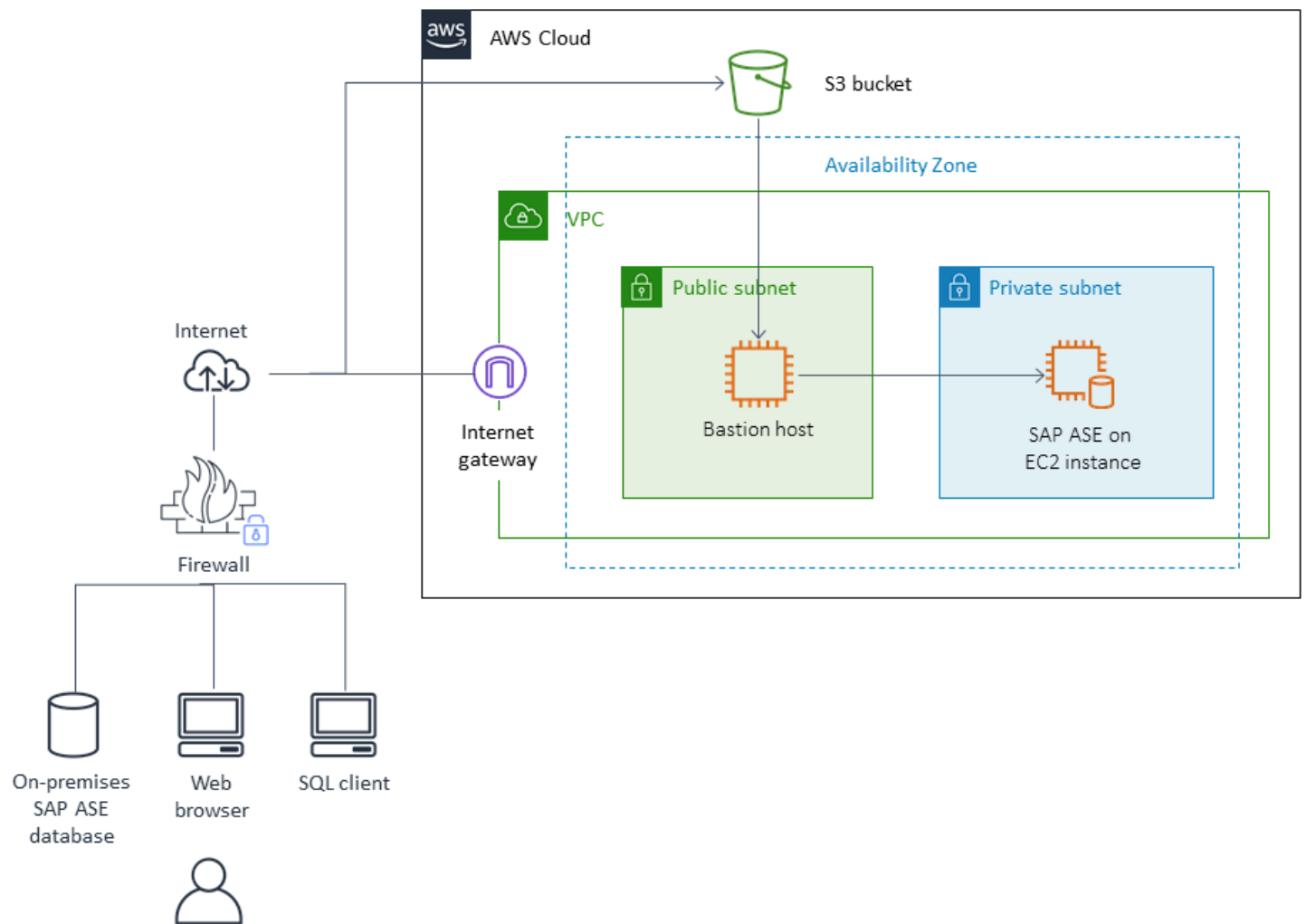

## Tools

- **AWS DMS** - [AWS Data Migration Service](#) (AWS DMS) supports several different source and target databases. For more information, see [Sources for Data Migration](#) and [Targets for Data Migration](#). We recommend that you use the latest version of AWS DMS for the most comprehensive version and feature support.
- **SAP ASE** - Native tools include ASE Cockpit, Sybase Central for ASE, and DBA Cockpit.

## Epics

### Analyze the migration

Task	Description	Skills required
Validate the source and target database versions.		DBA
Identify the target OS version.		DBA, SysAdmin
Identify the hardware requirements for the target server instance based on the SAP ASE compatibility list and capacity requirements.		DBA, SysAdmin
Identify the requirements for the storage type and capacity.		DBA, SysAdmin
Identify the network requirements including latency and bandwidth.		DBA, SysAdmin
Choose the proper instance type, capacity, storage features, and network features.		DBA, SysAdmin
Identify the network and host access security requirements for the source and target databases.		DBA, SysAdmin
Identify a list of operating system users required for the SAP ASE software installation.		DBA, SysAdmin

Task	Description	Skills required
Determine the backup strategy.		DBA
Determine the availability requirements.		DBA
Identify the application migration and switchover strategy.		DBA, SysAdmin, App owner

### Configure the infrastructure

Task	Description	Skills required
Create a virtual private cloud (VPC) and subnets.		SysAdmin
Create security groups and the network access control list (ACL).		SysAdmin
Configure and start the EC2 instance.		SysAdmin

### Install the software

Task	Description	Skills required
Create the OS users and groups required for SAP ASE software to work.		DBA, SysAdmin
Download the required version of SAP ASE software.		DBA, SysAdmin

Task	Description	Skills required
Install the SAP ASE database, backup server software, and replication server software on the EC2 instance and then configure the server.		DBA, SysAdmin

### Migrate the data - option 1

Task	Description	Skills required
Migrate the database objects and data by using native SAP ASE tools or third-party tools.	See the documentation for the SAP ASE or third-party tools. These include ASE Cockpit, Sybase Central for ASE, and DBA Cockpit.	DBA

### Migrate the data - option 2

Task	Description	Skills required
Migrate the data by using AWS DMS.		DBA

### Migrate the application

Task	Description	Skills required
Follow the application migration strategy.		DBA, SysAdmin, App owner

## Cut over

Task	Description	Skills required
Follow the application cutover or switchover strategy.		DBA, SysAdmin, App owner

## Close the project

Task	Description	Skills required
Shut down the temporary AWS resources.		DBA, SysAdmin
Validate and review the project documents.		DBA, SysAdmin, App owner
Gather metrics around time to migrate, percent of manual versus tool cost savings, and so on.		DBA, SysAdmin, App owner
Close the project and provide any feedback.		DBA, SysAdmin, App owner

## Related resources

### References

- [Amazon EC2](#)
- [AWS DMS](#)
- [Amazon EC2 pricing](#)

### Tutorials and videos

- [Getting Started with Amazon EC2](#)
- [Getting Started with AWS Database Migration Service](#)
- [AWS Data Migration Service \(video\)](#)
- [Introduction to Amazon EC2 - Elastic Cloud Server & Hosting with AWS \(video\)](#)

# Migrate an on-premises Microsoft SQL Server database to Amazon EC2

Created by Senthil Ramasamy (AWS)

<b>Environment:</b> PoC or pilot	<b>Source:</b> Microsoft SQL Server on premises	<b>Target:</b> Microsoft SQL Server on Amazon EC2
<b>R Type:</b> Rehost	<b>Workload:</b> Microsoft	<b>Technologies:</b> Migration; Databases
<b>AWS services:</b> AWS DMS; Amazon EC2; AWS SCT		

## Summary

This pattern describes how to migrate an on-premises Microsoft SQL Server database to Microsoft SQL Server on an Amazon Elastic Compute Cloud (Amazon EC2) instance. It covers two options for migration: using AWS Database Migration Service (AWS DMS) or using native Microsoft SQL Server tools such as backup and restore, Copy Database Wizard, or copy and attach database.

## Prerequisites and limitations

### Prerequisites

- An active AWS account
- An operating system supported by Amazon EC2 (for a complete list of supported operating system versions, see [Amazon EC2 FAQs](#))
- A Microsoft SQL Server source database in an on-premises data center

### Product versions

- For on-premises and Amazon EC2 instance databases, AWS DMS supports:
  - SQL Server versions 2005, 2008, 2008R2, 2012, 2014, 2016, 2017, and 2019
  - Enterprise, Standard, Workgroup, Developer, and Web editions
- For the latest list of supported versions, see [Using a Microsoft SQL Server Database as a Target for AWS DMS](#).



## Architecture

### Source technology stack

- On-premises Microsoft SQL Server database

### Target technology stack

- Microsoft SQL Server database on an EC2 instance

### Target architecture

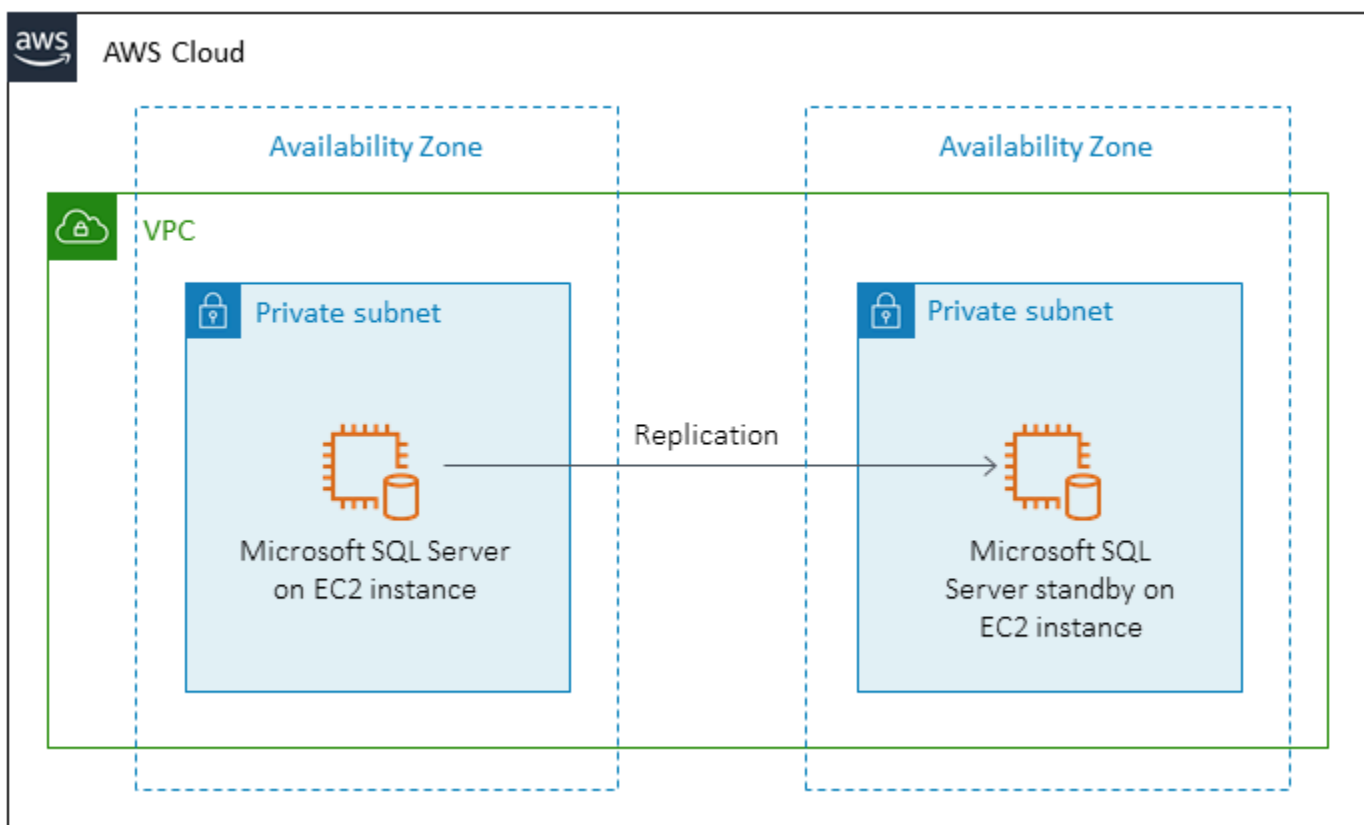

### Data migration architecture

- Using AWS DMS

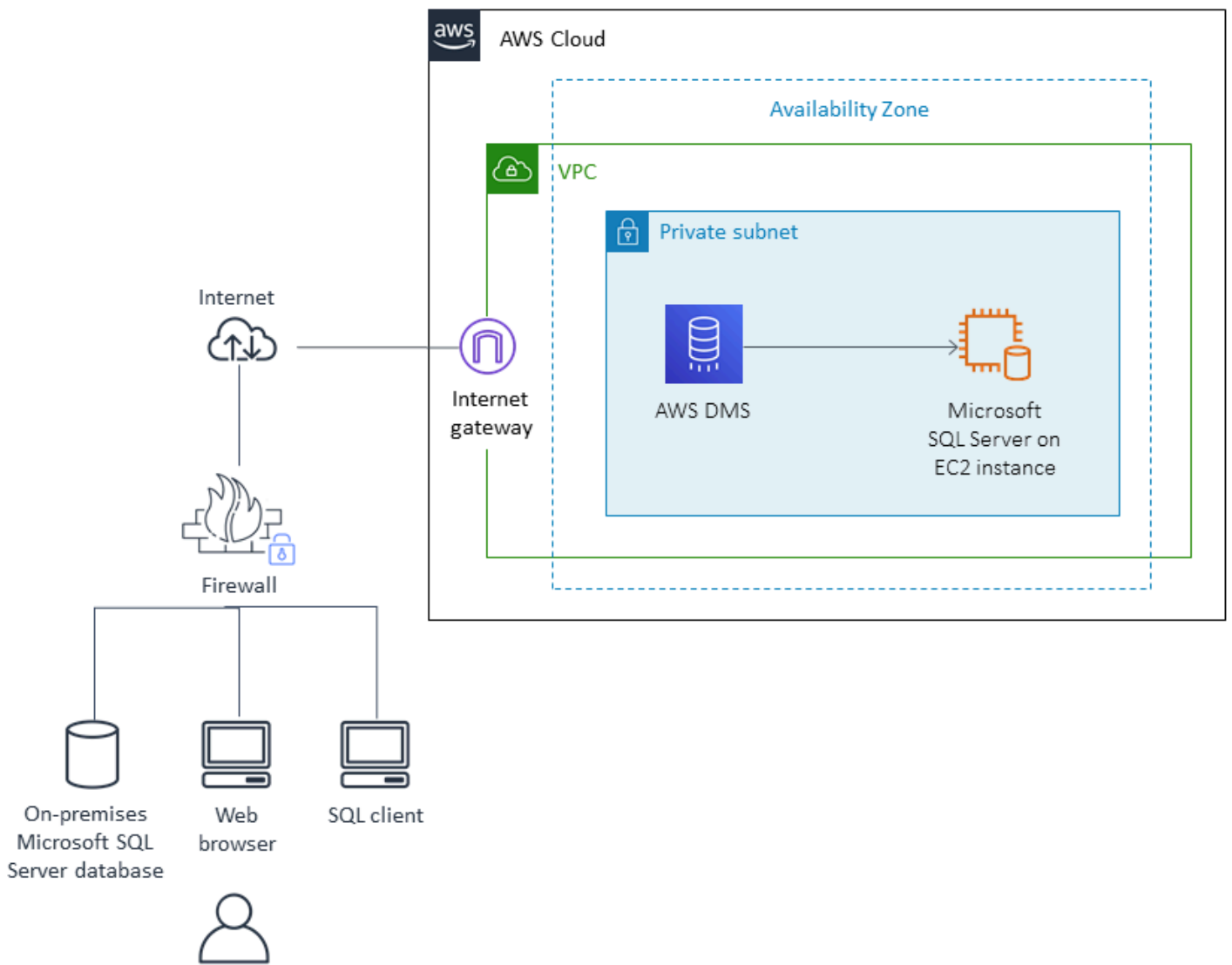

- Using native SQL Server tools

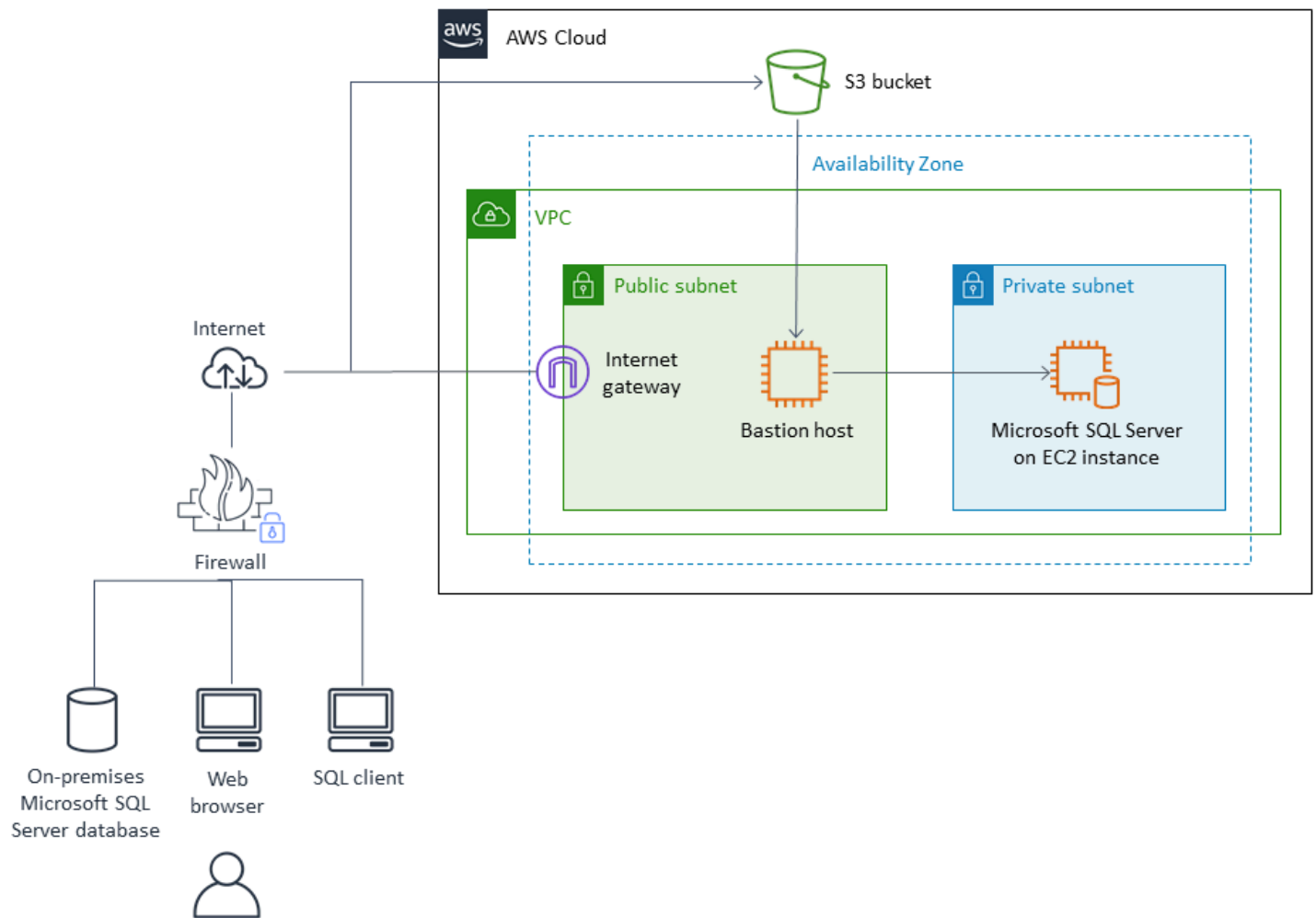

## Tools

- [AWS Database Migration Service \(AWS DMS\)](#) helps you migrate your data to and from widely used commercial and open-source databases, including Oracle, SQL Server, MySQL, and PostgreSQL. You can use AWS DMS to migrate your data into the AWS Cloud, between on-premises instances (through an AWS Cloud setup), or between combinations of cloud and on-premises setups.
- [AWS Schema Conversion Tool \(AWS SCT\)](#) supports heterogeneous database migrations by automatically converting the source database schema and a majority of the custom code to a format that's compatible with the target database.
- Native Microsoft SQL Server tools include backup and restore, Copy Database Wizard, and copy and attach database.

## Epics

### Plan the migration

Task	Description	Skills required
Validate the source and target database versions.		DBA
Identify the target operating system version.		DBA, Systems administrator
Identify the hardware requirements for the target server instance based on the Microsoft SQL Server compatibility list and capacity requirements.		DBA, Systems administrator
Identify the storage requirements for type and capacity.		DBA, Systems administrator
Identify the network requirements, including latency and bandwidth.		DBA, Systems administrator
Choose the EC2 instance type based on capacity, storage features, and network features.		DBA, Systems administrator
Identify the network and host access security requirements for the source and target databases.		DBA, Systems administrator
Identify a list of users required for the Microsoft		DBA, Systems administrator

Task	Description	Skills required
SQL Server software installation.		
Determine the backup strategy.		DBA
Determine the availability requirements.		DBA
Identify the application migration and cutover strategy.		DBA, Systems administrator

### Configure the infrastructure

Task	Description	Skills required
Create a virtual private cloud (VPC) and subnets.		Systems administrator
Create security groups and network access control list (ACL).		Systems administrator
Configure and start an EC2 instance.		Systems administrator

### Install the software

Task	Description	Skills required
Create the users and groups required for Microsoft SQL Server software.		DBA, Systems administrator

Task	Description	Skills required
Download the Microsoft SQL Server software.		DBA, Systems administrator
Install Microsoft SQL Server software on the EC2 instance and configure the server.		DBA, Systems administrator

### Migrate the data - option 1

Task	Description	Skills required
Use native Microsoft SQL Server tools or third-party tools to migrate the database objects and data.	Tools include backup and restore, Copy Database Wizard, and copy and attach database. For more information, see the guide <a href="#">Migrating Microsoft SQL Server databases to the AWS Cloud</a> .	DBA

### Migrate the data - option 2

Task	Description	Skills required
Migrate the data by using AWS DMS.	For more information about using AWS DMS, see the links in the <a href="#">Related resources</a> section.	DBA

## Migrate the application

Task	Description	Skills required
Follow the application migration strategy.	Use AWS Schema Conversion Tool (AWS SCT) to analyze and modify SQL code that's embedded in application source code.	DBA, App owner

## Cut over

Task	Description	Skills required
Follow the application switch-over strategy.		DBA, App owner, Systems administrator

## Close the project

Task	Description	Skills required
Shut down all temporary AWS resources.	Temporary resources include the AWS DMS replication instance and the EC2 instance for AWS SCT.	DBA, Systems administrator
Review and validate the project documents.		DBA, App owner, Systems administrator
Gather metrics around time to migrate, percent of manual versus tool cost savings, and so on.		DBA, App owner, Systems administrator
Close the project and provide feedback.		DBA, App owner, Systems administrator

## Related resources

### References

- [Migrating Microsoft SQL Server databases to the AWS Cloud](#)
- [Amazon EC2](#)
- [Amazon EC2 FAQs](#)
- [Amazon EC2 pricing](#)
- [AWS Database Migration Service](#)
- [Microsoft Products on AWS](#)
- [Microsoft Licensing on AWS](#)
- [Microsoft SQL Server on AWS](#)

### Tutorials and videos

- [Getting Started with Amazon EC2](#)
- [Getting Started with AWS Database Migration Service](#)
- [Join an Amazon EC2 instance to your Simple AD Active Directory](#)
- [Join an Amazon EC2 instance to your AWS Managed Microsoft AD Active Directory](#)
- [AWS Database Migration Service \(video\)](#)
- [Introduction to Amazon EC2 – Elastic Cloud Server & Hosting with AWS \(video\)](#)



# Migrate an on-premises MySQL database to Amazon EC2

Created by Lorenzo Mota (AWS)

<b>Environment:</b> PoC or pilot	<b>Source:</b> On-premises MySQL database	<b>Target:</b> MySQL database on Amazon EC2
<b>R Type:</b> Rehost	<b>Workload:</b> Open-source	<b>Technologies:</b> Migration; Databases
<b>AWS services:</b> AWS DMS; Amazon EC2		

## Summary

This pattern provides guidance for migrating an on-premises MySQL database to a MySQL database on an Amazon Elastic Compute Cloud (Amazon EC2) instance. The pattern discusses the use of AWS Database Migration Service (AWS DMS) or native MySQL tools such as **mysqldump** for the migration. It focuses on full database migration to a MySQL DB instance.

The pattern is primarily for DBAs and solutions architects. It can be used in small or large projects, in a testing or final migration phase. We recommend that you run at least one testing cycle before you use this pattern in a production environment.

## Prerequisites and limitations

### Prerequisites

- An active AWS account
- A MySQL source database in an on-premises data center

### Product versions

- MySQL version 5.5 and later
- A target operating system supported by Amazon EC2; see [Amazon EC2 FAQs](#)

## Architecture

### Source technology stack

- An on-premises MySQL database

### Target technology stack

- A MySQL database instance on Amazon EC2

### AWS data migration methods

- AWS DMS
- Native MySQL tools such as [mysqldump](#), or third-party tools such as [Percona XtraBackup](#)

### Target architecture

The following diagram illustrates the target Amazon EC2 implementation after cutover.

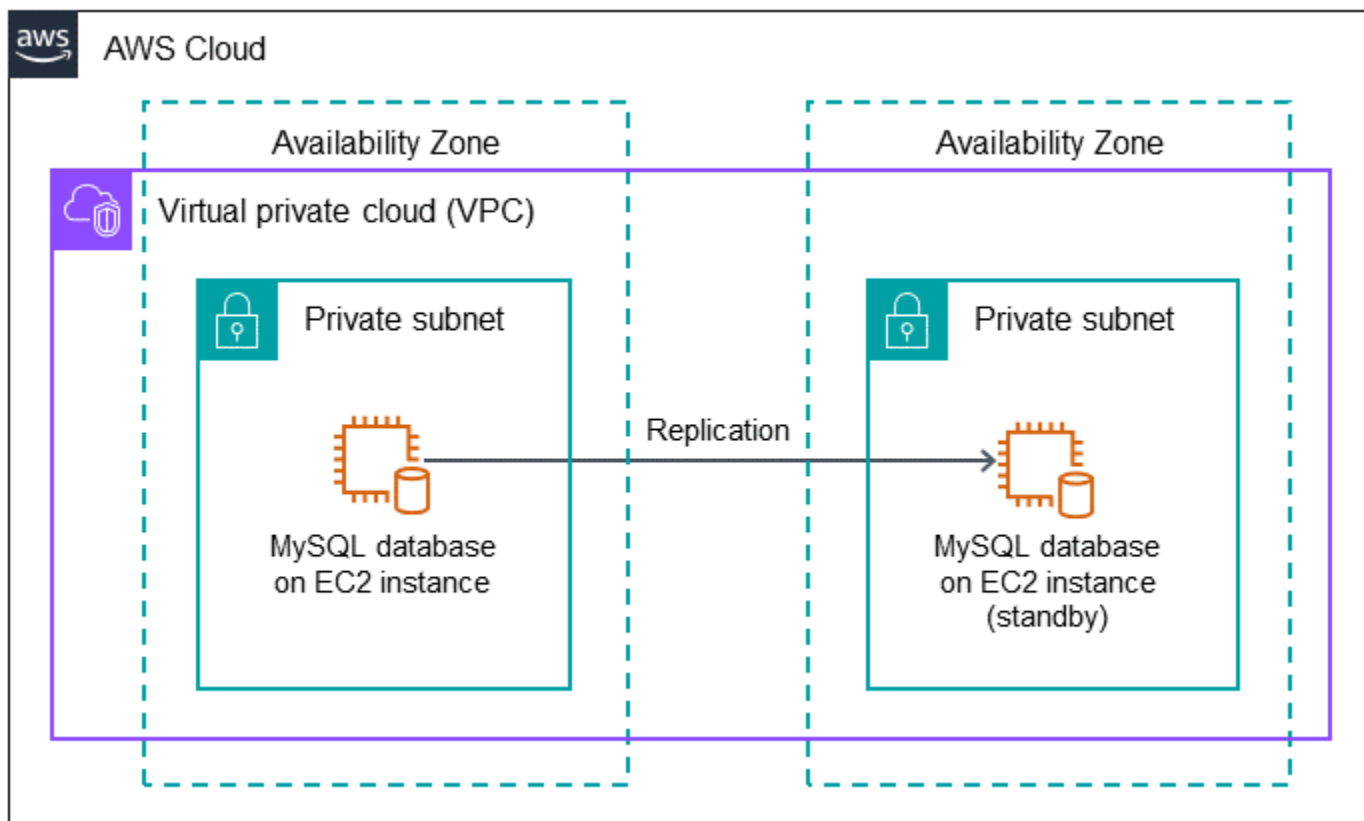

## AWS data migration architecture

### Using AWS DMS:

The following diagram illustrates the data migration workflow based on AWS DMS for sending full and incremental changes to the target MySQL database until cutover. The network connection from on premises to AWS depends on the requirements of the SQL client and is outside the scope of this pattern.

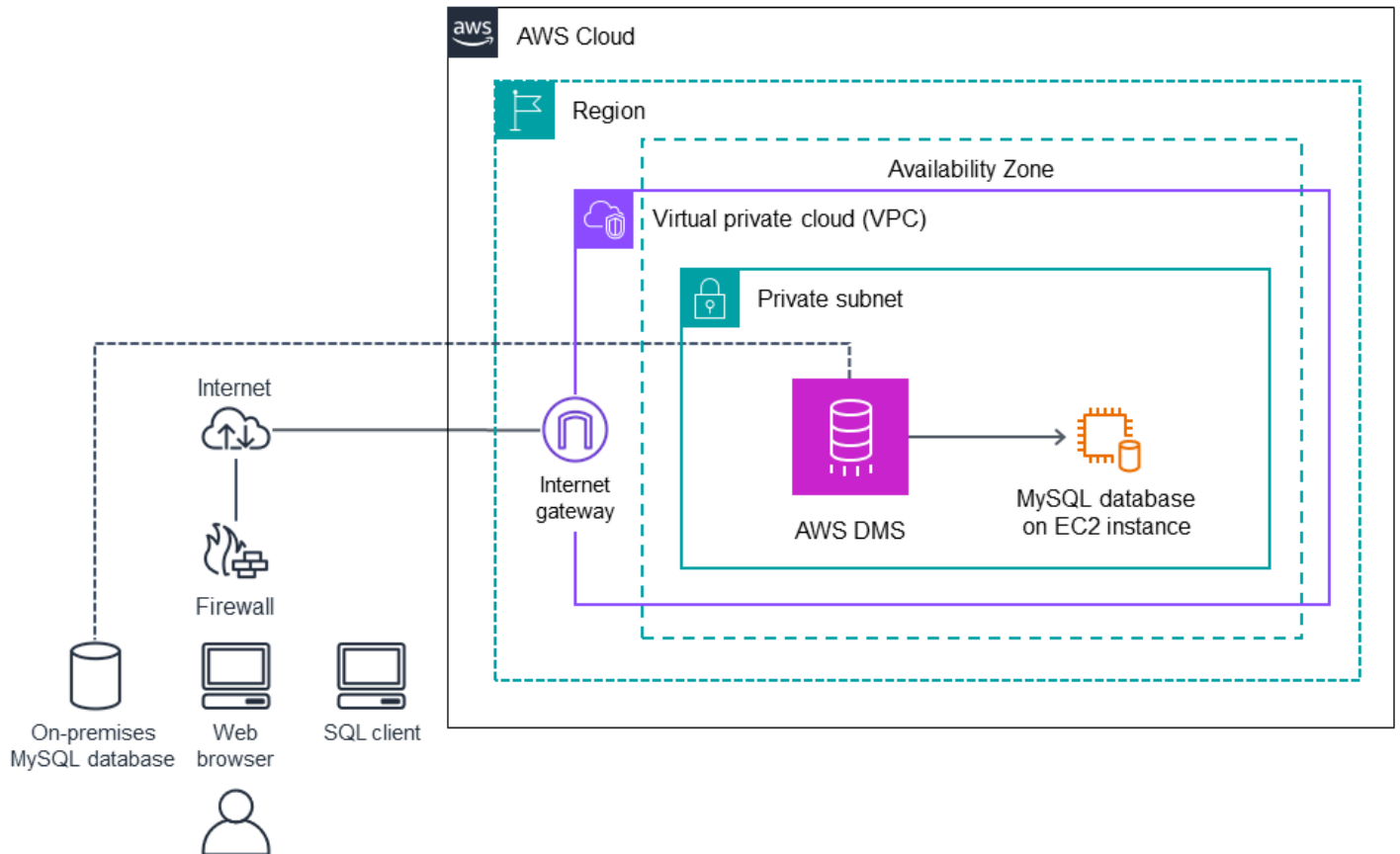

### Using other MySQL tools:

The following diagram illustrates the data migration workflow based on using MySQL tools to generate export dump files from the on-premises database. These files are moved to Amazon Simple Storage Service (Amazon S3) and imported into the target MySQL database before cutover. The network connection from on premises to AWS depends on the requirements of the SQL client and is outside the scope of this pattern.

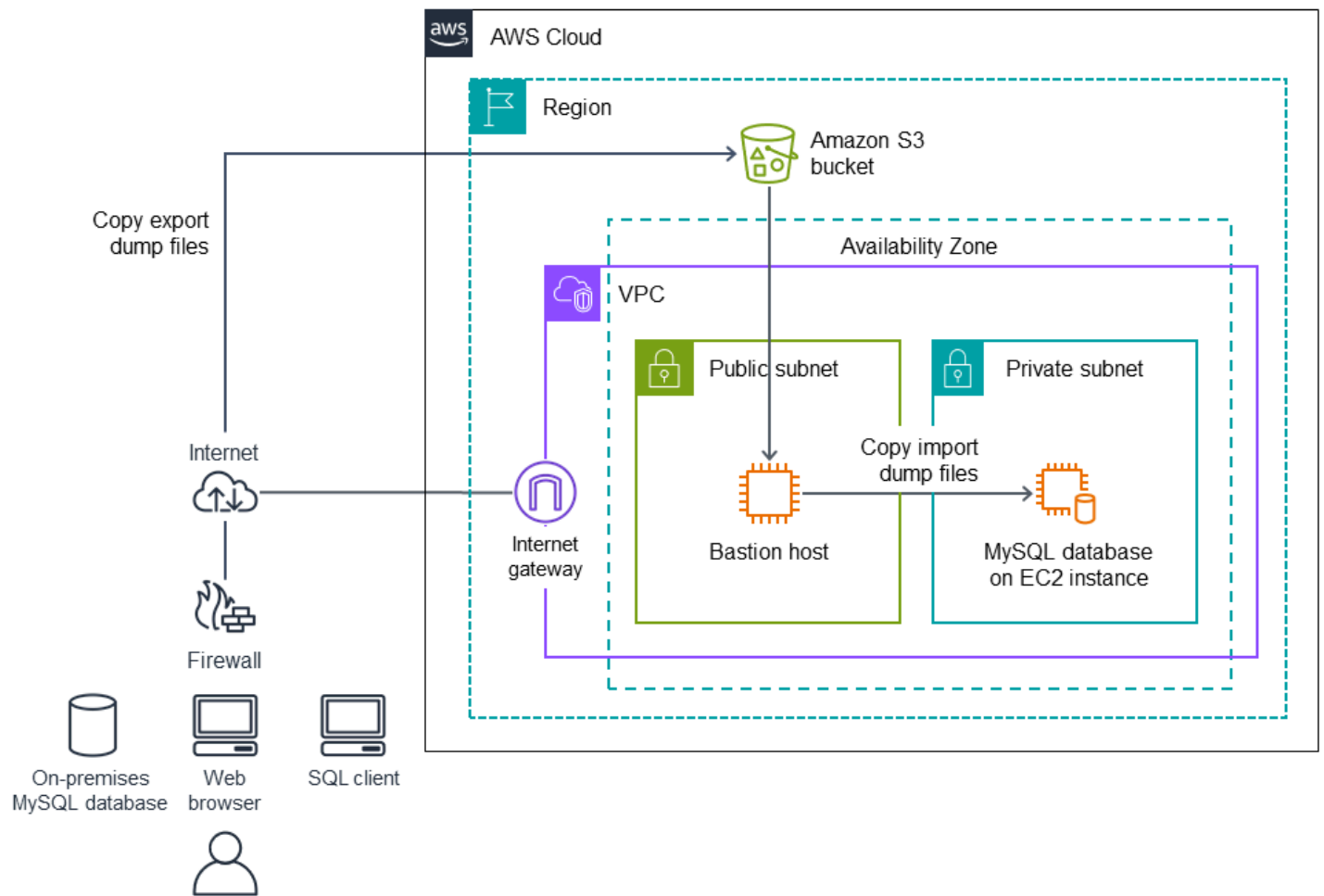

## Notes:

- Depending on down time considerations and the size of the database for the final cutover, you can use AWS DMS or another change data capture (CDC) tool to minimize the cutover time. When you use a CDC tool such as AWS DMS, you can migrate to the target database in minutes.
- An offline strategy with **mysqldump** can suffice if the size of the database and network latency allow for a short cutover migration window. (We recommend that you perform testing to get an approximate time.)
- Usually a CDC strategy through AWS DMS requires more monitoring and complexity than an offline option.

## Tools

### AWS services

- [AWS Database Migration Service \(AWS DMS\)](#) supports several source and target databases. For information about MySQL source and target databases supported by AWS DMS, see [Using a MySQL-compatible database as a source for AWS DMS](#) and [Using a MySQL-compatible database as a target for AWS DMS](#). If your source database isn't supported by AWS DMS, you must choose another method to migrate your data.

## Other tools

- [mysqldump](#) is a MySQL utility that creates a dump file from a MySQL database for backup or migration purposes.
- [Percona XtraBackup](#) is an open source utility for performing non-blocking backups on MySQL databases.

## Epics

### Plan the migration

Task	Description	Skills required
Validate the database versions.	Validate the versions of the source and target databases . For information about MySQL versions supported by AWS DMS, see <a href="#">Sources for AWS DMS</a> and <a href="#">Targets for AWS DMS</a> in the AWS DMS documentation.	DBA
Identify the target operating system.	Determine the version of the target operating system. For a list of target operating systems supported by Amazon EC2, see <a href="#">Amazon EC2 FAQs</a> .	DBA, Systems administrator
Identify hardware requirements.	Determine the hardware requirements for the <a href="#">target</a>	DBA, Systems administrator

Task	Description	Skills required
	<a href="#">server instance</a> based on the MySQL compatibility list and capacity requirements.	
Identify storage requirements.	Determine the storage type and capacity for the target database.	DBA, Systems administrator
Identify network requirements.	Determine networking requirements such as latency and bandwidth.	DBA, Systems administrator
Choose the target instance type.	Choose the <a href="#">target instance type</a> based on capacity, storage features, and network features.	DBA, Systems administrator
Identify security requirements.	Determine the network or host access security requirements for the source and target databases.	DBA, Systems administrator
Identify users.	Determine the list of operating system users for the MySQL software installation. For more information, see the <a href="#">MySQL documentation</a> .	DBA, Systems administrator
Determine a backup strategy.		DBA
Determine availability requirements.		DBA
Identify the application migration or switchover strategy.		DBA, Systems administrator

## Configure the infrastructure

Task	Description	Skills required
Create a virtual private cloud (VPC) and subnets.	Configure route tables, internet gateway, NAT gateways, and subnets. For more information, see <a href="#">VPC configuration options</a> in the Amazon VPC documentation.	Systems administrator
Create security groups and network access control lists (ACLs).	Configure ports (default for MySQL is 3306) and CIDR ranges or specific IPs depending on your requirements.	Systems administrator
Configure and start an EC2 instance.	For instructions, see <a href="#">Launch an EC2 instance</a> in the Amazon EC2 documentation.	Systems administrator

## Install MySQL software

Task	Description	Skills required
Create users and groups.	Create the operating system users and groups who need access to the server and database. For more information, see <a href="#">Access Control and Account Management</a> in the MySQL documentation.	DBA, Systems administrator
Download MySQL.	Download the MySQL software. For instructions and binaries, see <a href="#">Installing MySQL</a> in the MySQL documentation.	DBA, Systems administrator

Task	Description	Skills required
Install MySQL on the EC2 instance and configure the server.	Connect to your EC2 instance and install the MySQL software. For more information, see <a href="#">Connect to your EC2 instance</a> in the Amazon EC2 documentation.	DBA, Systems administrator

### Migrate data – option 1

Task	Description	Skills required
Migrate data with native MySQL or third-party tools.	This option uses native MySQL tools or third-party tools to migrate database objects and data. For instructions, see the documentation for <a href="#">mysqldump</a> or <a href="#">Percona XtraBackup</a> (for physical migration). For more information about using these tools, see the AWS blog post <a href="#">Migration options for MySQL to Amazon RDS for MySQL or Amazon Aurora MySQL</a> .	DBA

### Migrate data – option 2

Task	Description	Skills required
Migrate data with AWS DMS.	For more information, see <a href="#">High-level view of</a>	DBA



Task	Description	Skills required
	<a href="#">AWS DMS</a> in the AWS DMS documentation.	

## Prepare for cutover

Task	Description	Skills required
Gather object counts.	Gather object counts from source database and new target databases. Fix any discrepancies in the target database.	DBA
Check dependencies.	Confirm that dependencies (links) to and from other databases are still valid and work correctly.	DBA
Test.	If this is a testing cycle, perform query testing, gather metrics, and fix any issues.	DBA

## Cut over

Task	Description	Skills required
Move clients.	Switch the application clients over to the new infrastructure.	DBA, App owner, Systems administrator
Provide support.	Provide support during functional application testing.	DBA

## Close the project

Task	Description	Skills required
Shut down resources.	Shut down the AWS DMS replication instance and other temporary AWS resources.	DBA, Systems administrator
Review and project documents.	Review and validate the project documents.	DBA, App owner, Systems administrator
Collect metrics.	Collect metrics such as time to migrate, percentage of manual changes compared with tool-aided changes, and cost savings.	DBA, App owner, Systems administrator
Close out project.	Close out the migration project and provide feedback.	DBA, App owner, Systems administrator
Decommission source database.	Decommission the on-premises MySQL database.	DBA, Systems administrator

## Related resources

### References

- [Amazon EC2 documentation](#)
- [AWS DMS documentation](#)
- [Amazon EC2 Pricing](#)
- [AWS DMS Step-by-Step Walkthroughs](#)
- [mysqldump](#)
- [Percona XtraBackup](#)

### Tutorials and videos

- [Getting Started with AWS DMS](#)

- [Introduction to Amazon EC2 – Elastic Cloud Server & Hosting with AWS \(video\)](#)

# Reduce homogeneous SAP migration cutover time by using Application Migration Service

Created by Pavel Rubin (AWS), Diego Valverde (AWS), and Sunil Yadav (AWS)

<b>Environment:</b> Production	<b>Source:</b> On-premises SAP ASE database	<b>Target:</b> SAP database on Amazon EC2
<b>R Type:</b> Rehost	<b>Workload:</b> SAP	<b>Technologies:</b> Migration; Databases
<b>AWS services:</b> AWS MGN; Amazon EBS		

## Summary

This pattern outlines the steps for migrating SAP workloads by using AWS Application Migration Service. Application Migration Service facilitates cutovers by using block-level replication to maintain replication volumes that continually sync from their sources.

SAP workloads include the applications SAP Customer Relationship Management (SAP CRM), SAP Enterprise Resource Planning (ERP), and SAP Business Warehouse (SAP BW).

## Prerequisites and limitations

### Prerequisites

- An active AWS account with stable network connectivity between source SAP servers and the destination virtual private cloud (VPC) on AWS
- An SAP Adaptive Server Enterprise (ASE) source database for Linux or Windows in an on-premises data center

### Limitations

- The target operating system must be supported by Amazon Elastic Compute Cloud (Amazon EC2). For more information, see [Amazon EC2 FAQs](#).

## Architecture

### Source technology stack

- An SAP ASE database

### Target technology stack

- Amazon EC2
- Amazon Elastic Block Store (Amazon EBS)

### Source and target architecture

The following diagram shows migration from the on-premises servers through the Replication Agent to the Application Migration Service endpoint. An Amazon Simple Storage Service (Amazon S3) endpoint is used to access installation and configuration files. The subnets for the staging area and the migrated resources contain EC2 instances, with data storage on EBS volumes. Port TCP 443 is used to connect the source machine network to Application Migration Service, and to connect the staging area subnets to the Application Migration Service, Amazon EC2, and Amazon S3 Regional endpoints. Port TCP 1500 is used for data replication between the local network and the staging area.

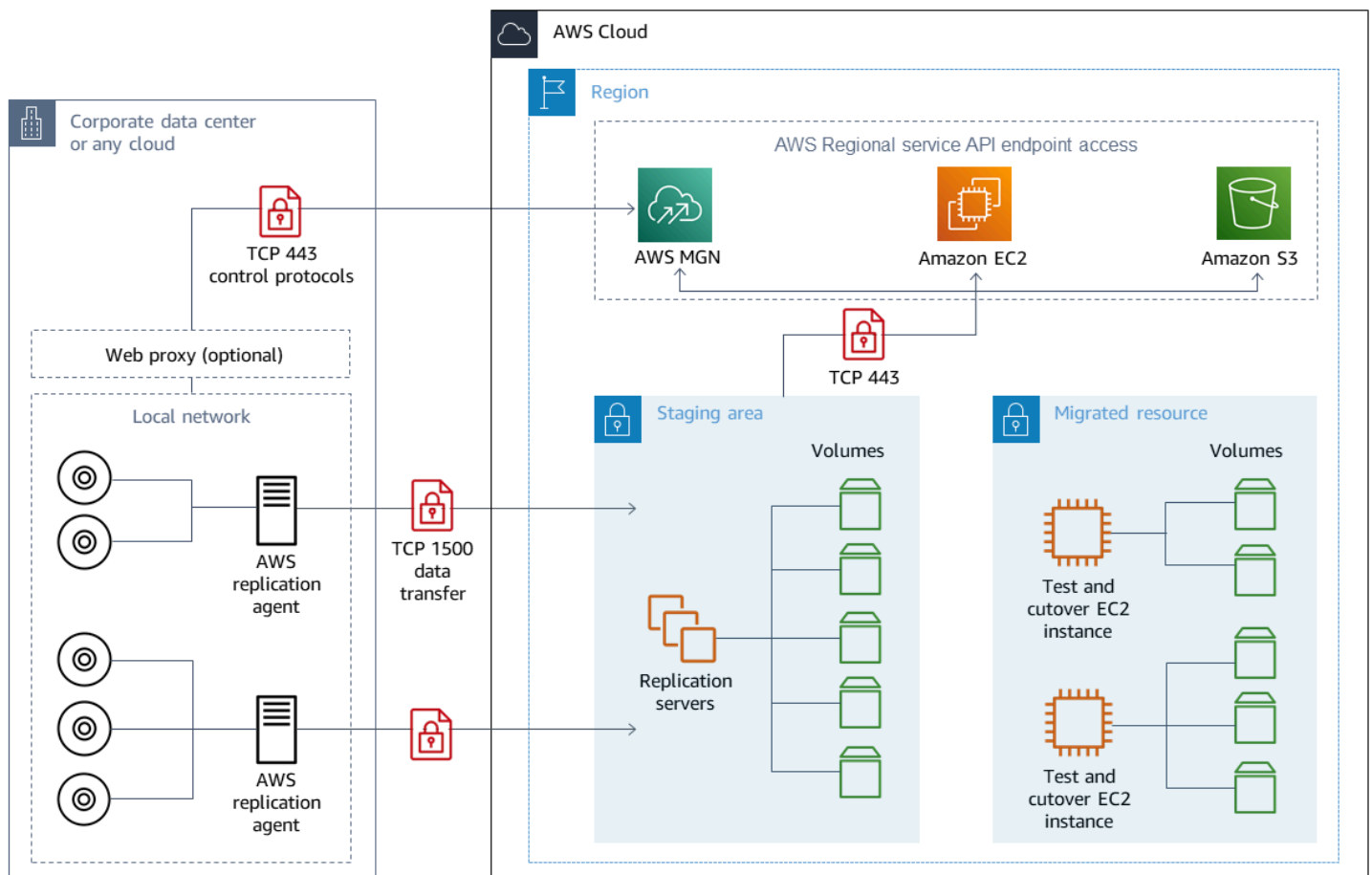

## Tools

- [AWS Application Migration Service](#) helps you rehost (*lift-and-shift*) applications to the AWS Cloud without change and with minimal downtime.
- [Amazon Elastic Block Store \(Amazon EBS\)](#) provides block-level storage volumes for use with Amazon Elastic Compute Cloud (Amazon EC2) instances.
- [Amazon Elastic Compute Cloud \(Amazon EC2\)](#) provides scalable computing capacity in the AWS Cloud. You can launch as many virtual servers as you need and quickly scale them up or down.
- [Amazon Simple Storage Service \(Amazon S3\)](#) is a cloud-based object storage service that helps you store, protect, and retrieve any amount of data.
- [AWS Security Token Service \(AWS STS\)](#) helps you request temporary, limited-privilege credentials for users.

## Epics

### Initialize Application Migration Service

Task	Description	Skills required
Initialize Application Migration Service.	Initialize Application Migration Service in the AWS Region where you want to deploy the SAP ASE database. AWS provides an automated setup the first time that you navigate to the Application Migration Service page in each Region.	AWS administrator
Manually create service roles.	(Optional) If you want to use automation (for example, AWS Control Tower) to set up the account, you can manually create the six AWS Identity and Access Management (IAM) roles that are required for installation, replication, and launches. For instructions, see the <a href="#">AWS documentation</a> .	AWS administrator
Create a Replication Settings template.	The Replication Settings template defines the subnet, instance type, Amazon EBS encryption, and how data is routed. For detailed settings information, see the <a href="#">AWS documentation</a> .	General AWS

## Generate credentials for Agent installation

Task	Description	Skills required
Create a new IAM Role.	<p>On the IAM console, navigate to <b>Roles</b>, and choose <b>Create role</b>.</p> <p>For the <b>Trusted entity type</b>, choose <b>AWS account</b>, and then choose <b>Next</b>.</p>	AWS systems administrator
Attach AWSApplicationMigrationAgentPolicy to the IAM Role.	<p>The AWS managed AWSApplicationMigrationAgentPolicy policy contains the necessary permissions to perform Application Migration Service Agent installation.</p> <p>After you attach the policy, choose <b>Next</b>.</p>	AWS systems administrator
Complete the role creation.	Assign a friendly name, and choose <b>Create role</b> .	AWS systems administrator
Generate temporary credentials.	To generate the access key ID, secret access key, and session token, follow the instructions in the <a href="#">AWS STS documentation</a> . These credentials are used during Agent installation.	AWS systems administrator



## Install the Application Migration Service Agent on the SAP source machine

Task	Description	Skills required
Download the Agent installer on the SAP source machine.	Download the Agent installer appropriate for your source operating system: <a href="#">Windows</a> or <a href="#">Linux</a> .	App owner
Install the AWS Replication Agent.	When you run the Agent installer file on a source machine, you are first asked to enter your access key, secret access key, session token, and the Region to replicate to. Use the temporary credentials from the IAM role that you previously created, and the same Region that you configured during initialization.	App owner
Wait for initial data replication.	After the Agent is installed, the source machine appears on the <b>Machines</b> tab on the Application Migration Service console.	App owner

## Configure the target machine's Launch template

Task	Description	Skills required
Update the Launch template for the source server.	Each source server uses a unique EC2 Launch template that informs the configuration of the target EC2 server.	General AWS

Task	Description	Skills required
	You can edit this template if you want to customize the Amazon EC2 configuration of your migrated server.	
Set the default Launch template version.	After you make the required changes to the Launch template, specify to use this updated version as the default Launch template. For more information, see the <a href="#">AWS documentation</a> .	General AWS
Turn off Instance type right sizing.	(Optional) <a href="#">Instance type right sizing</a> provides automatic instance type recommendations based on the configuration of the source SAP server. We recommend turning off this setting so that you can specify customized instance types in the Launch template.	General AWS

## Perform a test

Task	Description	Skills required
Initiate a test launch.	On the Application Migration Service console, select one or more servers, and then select <b>Launch test instances</b> under <b>Test and Cutover</b> .	General AWS, Migration engineer, Migration lead

Task	Description	Skills required
Wait for the conversion and launch process to be completed.	You can review the launch process on the <b>Launch history</b> tab. After the machine has successfully launched as an EC2 instance, the <b>Alerts</b> tab will be updated to <b>Launched</b> .	
Verify that the test completed successfully.	Connect to the launched instance through Remote Desktop Protocol (RDP) or SSH (Secure Shell), and perform the appropriate application checks. For example, log in to the SAP interface and validate functionality.	Migration engineer, App owner
Update the source lifecycle.	If testing was successful, update the source machine lifecycle to <b>Mark as "Ready for cutover"</b> on the <b>Test and Cutover</b> tab.	Migration engineer, Migration lead

### Schedule and perform a cutover to the Amazon EC2 target

Task	Description	Skills required
Schedule a cutover window.		Cutover lead, Migration lead, App owner
Initiate a cutover launch.	Select one or more servers. On the <b>Test and Cutover</b> tab, select <b>Launch cutover instances</b> under <b>Test and</b>	Migration engineer

Task	Description	Skills required
	<b>Cutover</b> on the Application Migration Service console.	
Wait for the conversion and launch processes to be completed.	You can review the launch process on the <b>Launch history</b> tab. After the machine has successfully launched as an EC2 instance, the <b>Alerts</b> tab will be updated to <b>Launched</b> .	
Verify that the cutover completed successfully.	Connect to the launched instance through RDP or SSH, and perform the appropriate application checks.	App owner, Migration engineer
Update the source lifecycle.	If cutover was successful, update the source machine lifecycle by selecting <b>Finalize cutover</b> on the <b>Test and Cutover</b> tab.	Migration engineer

## Related resources

### References

- [AWS Application Migration Service](#)
- [AWS Application Migration FAQ](#)

### Video

- [AWS Application Migration Service Architecture](#)

# Rehost on-premises workloads in the AWS Cloud: migration checklist

Created by Srikanth Rangavajhala (AWS)

<b>Environment:</b> PoC or pilot	<b>Source:</b> On-premises workloads	<b>Target:</b> AWS Cloud
<b>R Type:</b> Rehost	<b>Workload:</b> Microsoft	<b>Technologies:</b> Migration ; Hybrid cloud; Operating systems
<b>AWS services:</b> AWS MGN; Amazon EC2; Amazon Connect		

## Summary

Rehosting on-premises workloads in the Amazon Web Services (AWS) Cloud involves the following migration phases: planning, pre-discovery, discovery, build, test, and cutover. This pattern outlines the phases and their related tasks. The tasks are described at a high level and support about 75% of all application workloads. You can implement these tasks over two to three weeks in an agile sprint cycle.

You should review and vet these tasks with your migration team and consultants. After the review, you can gather the input, eliminate or re-evaluate tasks as necessary to meet your requirements, and modify other tasks to support at least 75% of the application workloads in your portfolio. You can then use an agile project management tool such as Atlassian Jira or Rally Software to import the tasks, assign them to resources, and track your migration activities.

The pattern assumes that you're using [AWS Cloud Migration Factory](#) to rehost your workloads, but you can use your migration tool of choice.

Amazon Macie can help identify sensitive data in your knowledge bases, stored as data sources, model invocation logs, and prompt stores in Amazon Simple Storage Service (Amazon S3) buckets. For more information, see the [Macie documentation](#).

## Prerequisites and limitations

### Prerequisites

- Project management tool for tracking migration tasks (for example, Atlassian Jira or Rally Software)
- Migration tool for rehosting your workloads on AWS (for example, [Cloud Migration Factory](#))

## Architecture

### Source platform

- On-premises source stack (including technologies, applications, databases, and infrastructure)

### Target platform

- AWS Cloud target stack (including technologies, applications, databases, and infrastructure)

### Architecture

The following diagram illustrates rehosting (discovering and migrating servers from an on-premises source environment to AWS) by using Cloud Migration Factory and AWS Application Migration Service.

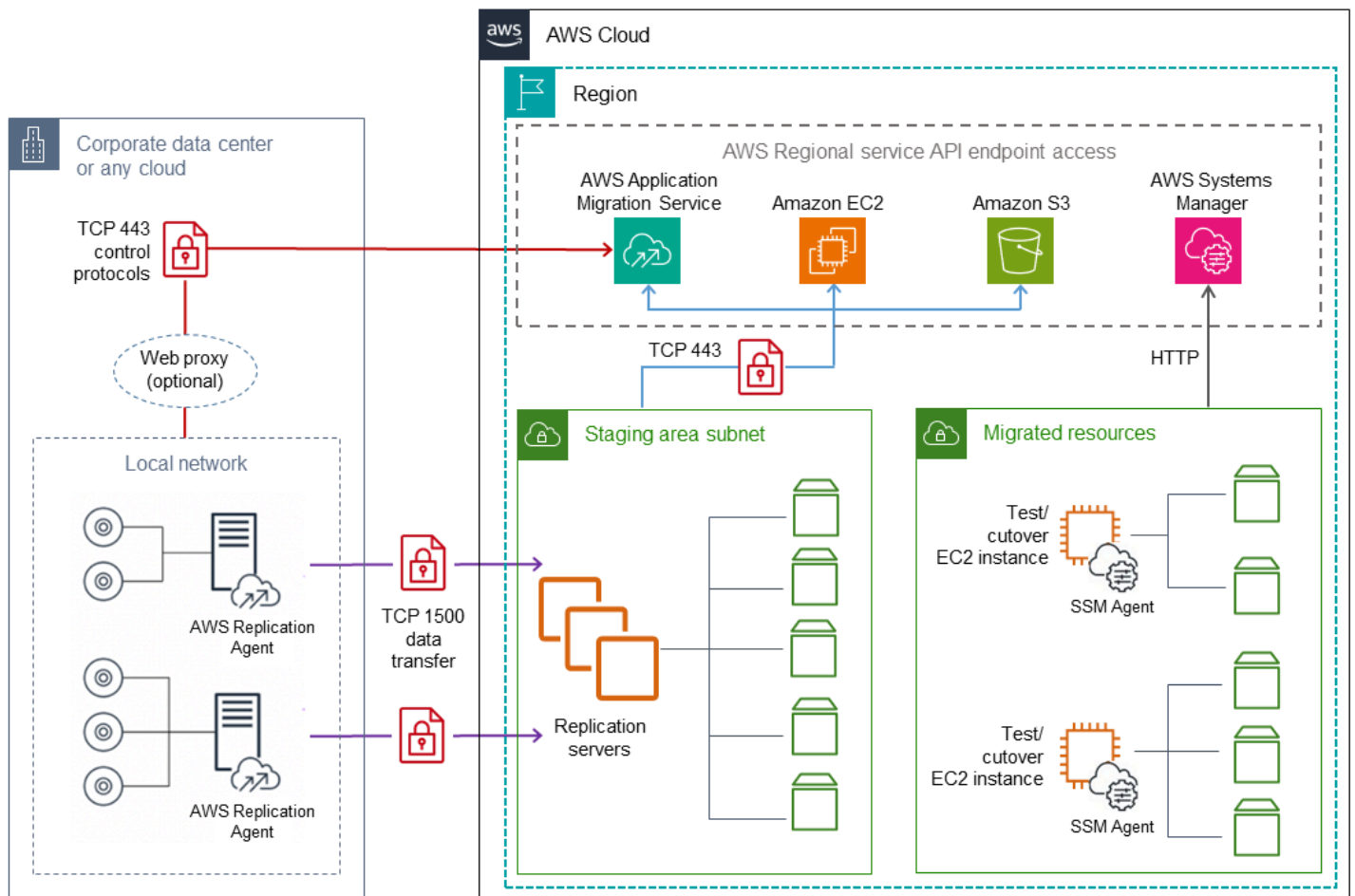

## Tools

- You can use a migration and project management tool of your choice.

## Epics

### Planning phase

Task	Description	Skills required
Groom the pre-discovery backlog.	Conduct the pre-discovery backlog grooming working session with department leads and application owners.	Project manager, Agile scrum leader

Task	Description	Skills required
Conduct the sprint planning working session.	As a scoping exercise, distribute the applications that you want to migrate across sprints and waves.	Project manager, Agile scrum leader

## Pre-discovery phase

Task	Description	Skills required
Confirm application knowledge.	Confirm and document the application owner and their knowledge of the application. Determine whether there's another point person for technical questions.	Migration specialist (interviewer)
Determine application compliance requirements.	Confirm with the application owner that the application doesn't have to comply with requirements for Payment Card Industry Data Security Standard (PCI DSS), Sarbanes-Oxley Act (SOX), personally identifiable information (PII), or other standards. If compliance requirements exist, teams must finish their compliance checks on the servers that will be migrated.	Migration specialist (interviewer)
Confirm production release requirements.	Confirm the requirements for releasing the migrated application to production (such as release date and downtime duration) with the	Migration specialist (interviewer)



Task	Description	Skills required
	application owner or technical contact.	
Get server list.	Get the list of servers that are associated with the targeted application.	Migration specialist (interviewer)
Get the logical diagram that shows the current state.	Obtain the current state diagram for the application from the enterprise architect or the application owner.	Migration specialist (interviewer)
Create a logical diagram that shows the target state.	Create a logical diagram of the application that shows the target architecture on AWS. This diagram should illustrate servers, connectivity, and mapping factors.	Enterprise architect, Business owner
Get server information.	Collect information about the servers that are associated with the application, including their configuration details.	Migration specialist (interviewer)
Add server information to the discovery template.	Add detailed server information to the application discovery template (see <code>mobilize-application-questionnaire.xlsx</code> in the attachment for this pattern). This template includes all the application-related security, infrastructure, operating system, and networking details.	Migration specialist (interviewer)

Task	Description	Skills required
Publish the application discovery template.	Share the application discovery template with the application owner and migration team for common access and use.	Migration specialist (interviewer)

## Discovery phase

Task	Description	Skills required
Confirm server list.	Confirm the list of servers and the purpose of each server with the application owner or technical lead.	Migration specialist
Identify and add server groups.	Identify server groups such as web servers or application servers, and add this information to the application discovery template. Select the tier of the application (web, application, database) that each server should belong to.	Migration specialist
Fill in the application discovery template.	Complete the details of the application discovery template with the help of the migration team, application team, and AWS.	Migration specialist
Add missing server details (middleware and OS teams).	Ask middleware and operating system (OS) teams to review the application discovery template and add any missing server details,	Migration specialist

Task	Description	Skills required
	including database information.	
Get inbound/outbound traffic rules (network team).	Ask the network team to get the inbound/outbound traffic rules for the source and destination servers. The network team should also add existing firewall rules, export these to a security group format, and add existing load balancers to the application discovery template.	Migration specialist
Identify required tagging.	Determine the tagging requirements for the application.	Migration specialist
Create firewall request details.	Capture and filter the firewall rules that are required to communicate with the application.	Migration specialist, Solutions architect, Network lead
Update the EC2 instance type.	Update the Amazon Elastic Compute Cloud (Amazon EC2) instance type to be used in the target environment, based on infrastructure and server requirements.	Migration specialist, Solutions architect, Network lead

Task	Description	Skills required
Identify the current state diagram.	Identify or create the diagram that shows the current state of the application. This diagram will be used in the information security (InfoSec) request.	Migration specialist, Solutions architect
Finalize the future state diagram.	Finalize the diagram that shows the future (target) state for the application. This diagram will also be used in the InfoSec request.	Migration specialist, Solutions architect
Create firewall or security group service requests.	Create firewall or security group service requests (for development/QA, pre-production, and production). If you're using Cloud Migration Factory, include replication-specific ports if they're not already open.	Migration specialist, Solutions architect, Network lead
Review firewall or security group requests (InfoSec team).	In this step, the InfoSec team reviews and approves the firewall or security group requests that were created in the previous step.	InfoSec engineer, Migration specialist
Implement firewall security group requests (network team).	After the InfoSec team approves the firewall requests, the network team implements the required inbound/outbound firewall rules.	Migration specialist, Solutions architect, Network lead

**Build phase (repeat for development/QA, pre-production, and production environments)**

Task	Description	Skills required
Import the application and server data.	<ol style="list-style-type: none"><li>1. Verify that you are logged in to your migration execution server as a domain user with local administrator permissions on the in-scope source servers.</li><li>2. Use the migration intake form to import the attributes for the in-scope source servers. For additional information, see the <a href="#">Cloud Migration Factory Implementation Guide</a>.</li></ol> <p>If you aren't using Cloud Migration Factory, follow the instructions for setting up your migration tool.</p>	Migration specialist, Cloud administrator
Check prerequisites for source servers.	Connect with the in-scope source servers to verify prerequisites such as TCP port 1500, TCP port 443, root volume free space, .NET Framework version, and other parameters. These are required for replication. For additional information, see the <a href="#">Cloud Migration Factory Implementation Guide</a> .	Migration specialist, Cloud administrator

Task	Description	Skills required
Create a service request to install replication agents.	Create a service request to install replication agents on the in-scope servers for development/QA, pre-production, or production.	Migration specialist, Cloud administrator
Install the replication agents.	Install the replication agents on the in-scope source servers on the development/QA, pre-production, or production machines. For additional information, see the <a href="#">Cloud Migration Factory Implementation Guide</a> .	Migration specialist, Cloud administrator
Push the post-launch scripts.	Application Migration Service supports post-launch scripts to help you automate OS-level activities such as installing or uninstalling software after you launch target instances. This step pushes the post-launch scripts to Windows or Linux machines, depending on the servers identified for migration. For instructions, see the <a href="#">Cloud Migration Factory Implementation Guide</a> .	Migration specialist, Cloud administrator

Task	Description	Skills required
Verify the replication status.	Confirm the replication status for the in-scope source servers automatically by using the provided script. The script repeats every five minutes until the status of all source servers in the given wave changes to <b>Healthy</b> . For instructions, see the <a href="#">Cloud Migration Factory Implementation Guide</a> .	Migration specialist, Cloud administrator
Create the admin user.	A local admin or sudo user on source machines might be needed to troubleshoot any issues after migration cutover from the in-scope source servers to AWS. The migration team uses this user to log in to the target server when the authentication server (for example, the DC or LDAP server) is not reachable. For instructions for this step, see the <a href="#">Cloud Migration Factory Implementation Guide</a> .	Migration specialist, Cloud administrator

Task	Description	Skills required
Validate the launch template.	Validate the server metadata to make sure it works successfully and has no invalid data. This step validates both test and cutover metadata. For instructions, see the <a href="#">Cloud Migration Factory Implementation Guide</a> .	Migration specialist, Cloud administrator

### Test phase (repeat for development/QA, pre-production, and production environments)

Task	Description	Skills required
Create a service request.	Create a service request for the infrastructure team and other teams to perform application cutover to development/QA, pre-production, or production instances.	Migration specialist, Cloud administrator
Configure a load balancer (optional).	Configure required load balancers, such as an <a href="#">Application Load Balancer</a> or an <a href="#">F5 load balancer</a> with iRules.	Migration specialist, Cloud administrator
Launch instances for testing.	Launch all target machines for a given wave in Application Migration Service in test mode. For additional information, see the <a href="#">Cloud</a>	Migration specialist, Cloud administrator



Task	Description	Skills required
	<a href="#">Migration Factory Implementation Guide.</a>	
Verify the target instance status.	Verify the status of the target instance by checking the bootup process for all in-scope source servers in the same wave. It may take up to 30 minutes for the target instances to boot up. You can check the status manually by logging in to the Amazon EC2 console, searching for the source server name, and reviewing the <b>Status check</b> column. The status <b>2/2 checks passed</b> indicates that the instance is healthy from an infrastructure perspective.	Migration specialist, Cloud administrator

Task	Description	Skills required
Modify DNS entries.	<p>Modify Domain Name System (DNS) entries. (Use <code>resolv.conf</code> or <code>host.conf</code> for a Microsoft Windows environment.)</p> <p>Configure each EC2 instance to point to the new IP address of this host.</p> <p><b>Note:</b> Make sure that there are no DNS conflicts between on-premises and AWS Cloud servers. This step and the following steps are optional, depending on the environment where the server is hosted.</p>	Migration specialist, Cloud administrator
Test connectivity to backend hosts from EC2 instances.	Check the logins by using the domain credentials for the migrated servers.	Migration specialist, Cloud administrator
Update the DNS A record.	Update the DNS A record for each host to point to the new Amazon EC2 private IP address.	Migration specialist, Cloud administrator
Update the DNS CNAME record.	Update the DNS CNAME record for virtual IPs (load balancer names) to point to the cluster for web and application servers.	Migration specialist, Cloud administrator

Task	Description	Skills required
Test the application in applicable environments.	Log in to the new EC2 instance and test the application in the development/ QA, pre-production, and production environments.	Migration specialist, Cloud administrator
Mark as ready for cutover.	When testing is complete, change the status of the source server to indicate that it's ready for cutover, so users can launch a cutover instance. For instructions, see the <a href="#">Cloud Migration Factory Implementation Guide</a> .	Migration specialist, Cloud administrator

## Cutover phase

Task	Description	Skills required
Create production deployment plan.	Create a production deployment plan (including a backout plan).	Migration specialist, Cloud administrator
Notify operations team of downtime.	Notify the operations team of the downtime schedule for the servers. Some teams might require a change request or service request (CR/SR) ticket for this notification.	Migration specialist, Cloud administrator
Replicate production machines.	Replicate production machines by using Applicati	Migration specialist, Cloud administrator

Task	Description	Skills required
	on Migration Service or another migration tool.	
Shut down in-scope source servers.	After you verify the source servers' replication status, you can shut down the source servers to stop transactions from client applications to the servers. You can shut down the source servers in the cutover window. For more information, see the <a href="#">Cloud Migration Factory Implementation Guide</a> .	Cloud administrator
Launch instances for cutover.	Launch all target machines for a given wave in Application Migration Service in cutover mode. For more information, see the <a href="#">Cloud Migration Factory Implementation Guide</a> .	Migration specialist, Cloud administrator
Retrieve target instance IPs.	Retrieve the IPs for target instances. If the DNS update is a manual process in your environment, you would need to get the new IP addresses for all target instances. For more information, see the <a href="#">Cloud Migration Factory Implementation Guide</a> .	Migration specialist, Cloud administrator

Task	Description	Skills required
Verify target server connections.	After you update the DNS records, connect to the target instances with the host name to verify the connections. For more information, see the <a href="#">Cloud Migration Factory Implementation Guide</a> .	Migration specialist, Cloud administrator

## Related resources

- [How to migrate](#)
- [AWS Cloud Migration Factory Implementation Guide](#)
- [Automating large-scale server migrations with Cloud Migration Factory](#)
- [AWS Application Migration Service User Guide](#)
- [AWS Migration Acceleration Program](#)

## Attachments

To access additional content that is associated with this document, unzip the following file: [attachment.zip](#)

# Set up Multi-AZ infrastructure for a SQL Server Always On FCI by using Amazon FSx

Created by Manish Garg (AWS), T.V.R.L.Phani Kumar Dadi (AWS), Nishad Mankar (AWS), and RAJNEESH TYAGI (AWS)

<b>Code repository:</b> <a href="#">aws-windows-failover-cluster-automation</a>	<b>Environment:</b> PoC or pilot	<b>Source:</b> On-premises SQL Server database
<b>Target:</b> Microsoft SQL Server on EC2	<b>R Type:</b> Rehost	<b>Workload:</b> Microsoft
<b>Technologies:</b> Migration; Infrastructure; DevOps	<b>AWS services:</b> AWS Managed Microsoft AD; Amazon EC2; Amazon FSx; AWS Systems Manager	

## Summary

If you need to migrate a large number of Microsoft SQL Server Always On Failover Cluster Instances (FCIs) quickly, this pattern can help you minimize provisioning time. By using automation and Amazon FSx for Windows File Server, it reduces manual efforts, human-made errors, and the time required to deploy a large number of clusters.

This pattern sets up the infrastructure for SQL Server FCIs in a Multi-Availability Zone (Multi-AZ) deployment on Amazon Web Services (AWS). The provisioning of the AWS services required for this infrastructure is automated by using [AWS CloudFormation](#) templates. SQL Server installation and cluster node creation on an [Amazon Elastic Compute Cloud \(Amazon EC2\)](#) instance is performed by using PowerShell commands.

This solution uses a highly available Multi-AZ [Amazon FSx for Windows](#) file system as the shared witness for storing the SQL Server database files. The Amazon FSx file system and EC2 Windows instances that host SQL Server are joined to the same AWS Directory Service for Microsoft Active Directory (AWS Managed Microsoft AD) domain.

## Prerequisites and limitations

### Prerequisites

- An active AWS account
- An AWS user with sufficient permissions to provision resources using AWS CloudFormation templates
- AWS Directory Service for Microsoft Active Directory
- Credentials in AWS Secrets Manager to authenticate to AWS Managed Microsoft AD in a key-value pair:
  - ADDomainName: <Domain Name>
  - ADDomainJoinUserName: <Domain Username>
  - ADDomainJoinPassword:<Domain User Password>
  - TargetOU: <Target OU Value>

**Note:** You will use the same key name in AWS Systems Manager automation for the AWS Managed Microsoft AD join activity.

- SQL Server media files for SQL Server installation and Windows service or domain accounts created, which will be used during cluster creation
- A virtual private cloud (VPC), with two public subnets in separate Availability Zones, two private subnets in the Availability Zones, an internet gateway, NAT gateways, route table associations, and a jump server

### Product versions

- Windows Server 2012 R2 and Microsoft SQL Server 2016

## Architecture

### Source technology stack

- On-premises SQL Server with FCIs using a shared drive

### Target technology stack

- AWS EC2 instances

- Amazon FSx for Windows File Server
- AWS Systems Manager Automation runbook
- Network configurations (VPC, subnets, internet gateway, NAT gateways, jump server, security groups)
- AWS Secrets Manager
- AWS Managed Microsoft AD
- Amazon EventBridge
- AWS Identity and Access Management (IAM)

### Target architecture

The following diagram shows an AWS account in a single AWS Region, with a VPC that includes two Availability Zones, two public subnets with NAT gateways, a jump server in the first public subnet, two private subnets, each with an EC2 instance for a SQL Server node in a node security group, and an Amazon FSx file system connecting to each of the SQL Server nodes. AWS Directory Service, Amazon EventBridge, AWS Secrets Manager, and AWS Systems Manager are also included.



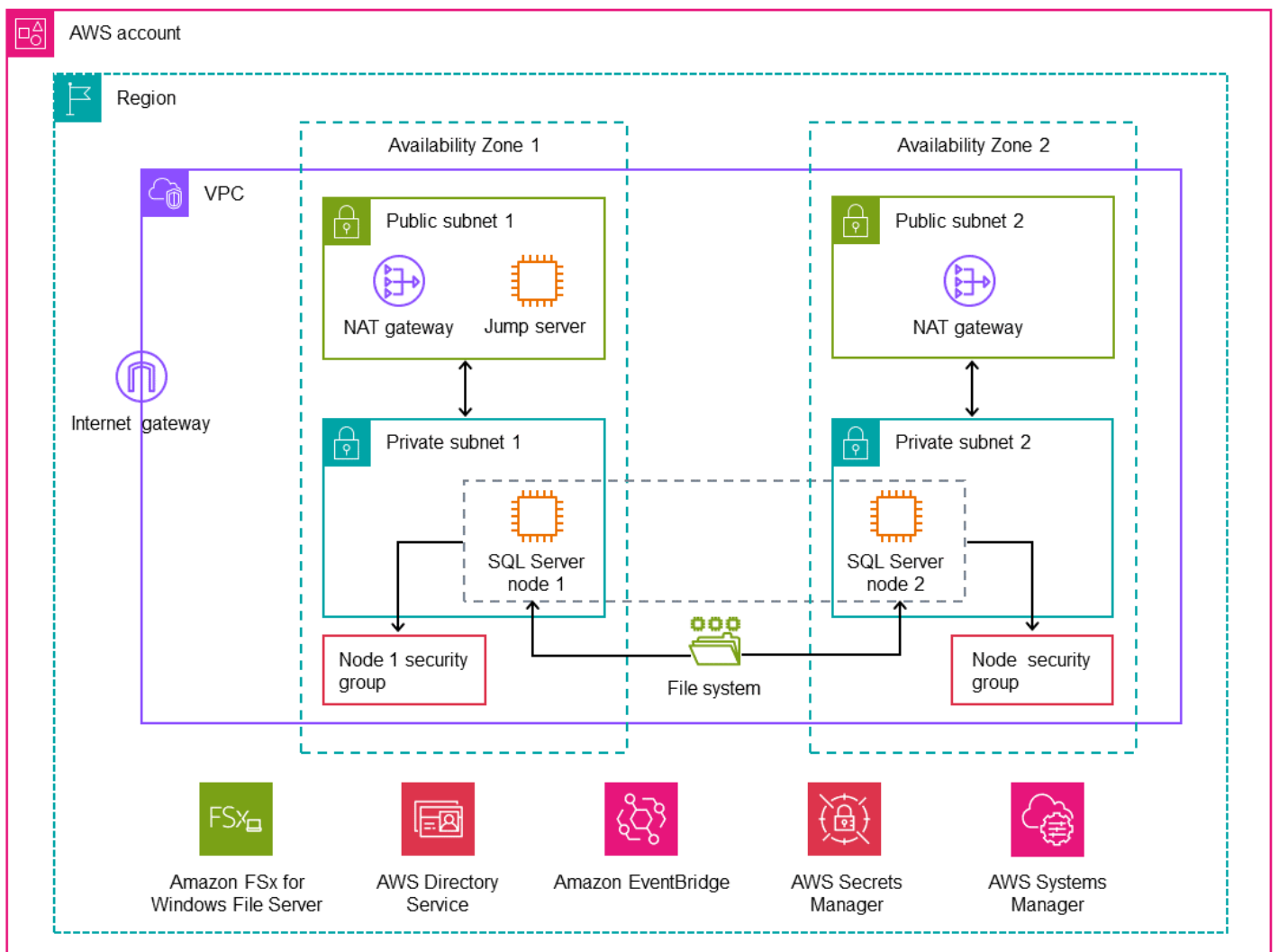

## Automation and scale

- You can use AWS Systems Manager to join AWS Managed Microsoft AD and perform the SQL Server installation.

## Tools

### AWS services

- [AWS CloudFormation](#) helps you set up AWS resources, provision them quickly and consistently, and manage them throughout their lifecycle across AWS accounts and Regions.

- [AWS Directory Service](#) provides multiple ways to use Microsoft Active Directory (AD) with other AWS services such as Amazon Elastic Compute Cloud (Amazon EC2), Amazon Relational Database Service (Amazon RDS) for SQL Server, and Amazon FSx for Windows File Server.
- [Amazon Elastic Compute Cloud \(Amazon EC2\)](#) provides scalable computing capacity in the AWS Cloud. You can launch as many virtual servers as you need and quickly scale them up or down.
- [Amazon EventBridge](#) is a serverless event bus service that helps you connect your applications with real-time data from a variety of sources. For example, AWS Lambda functions, HTTP invocation endpoints using API destinations, or event buses in other AWS accounts.
- [AWS Identity and Access Management \(IAM\)](#) helps you securely manage access to your AWS resources by controlling who is authenticated and authorized to use them.
- [AWS Secrets Manager](#) helps you replace hardcoded credentials in your code, including passwords, with an API call to Secrets Manager to retrieve the secret programmatically.
- [AWS Systems Manager](#) helps you manage your applications and infrastructure running in the AWS Cloud. It simplifies application and resource management, shortens the time to detect and resolve operational problems, and helps you manage your AWS resources securely at scale.

## Other tools

- [PowerShell](#) is a Microsoft automation and configuration management program that runs on Windows, Linux, and macOS. This pattern uses PowerShell scripts.

## Code repository

The code for this pattern is available in the GitHub [aws-windows-failover-cluster-automation](#) repository.

## Best practices

- The IAM roles that are used to deploy this solution should adhere to the principle of least privilege. For more information, see the [IAM documentation](#).
- Follow the [AWS CloudFormation best practices](#).

## Epics

### Deploy the infrastructure

Task	Description	Skills required
Deploy the Systems Manager CloudFormation stack.	<ol style="list-style-type: none"><li>1. Sign in to your AWS account, and open the AWS Management Console.</li><li>2. Navigate to the CloudFormation console, and create the Systems Manager CloudFormation stack by uploading the <code>ssm.yaml</code> template. Provide values for the following parameters:<ul style="list-style-type: none"><li>• <b>StateUnJoinAssociationLoggingBucketName</b> – Provide a name for the S3 bucket that the template will create for logging purposes.</li><li>• <b>SSMAssociationADUnjoinName</b> – Provide a name for the <code>AWS::SSM::Association</code> resource.</li><li>• <b>SSMAutomationDocumentName</b> – Provide a name for the Systems Manager Automation runbook.</li><li>• <b>EventBridgeName</b> – Provide a name for the EventBridge event bus.</li></ul></li></ol>	AWS DevOps, DevOps engineer

Task	Description	Skills required
	<p>3. Deploy the Systems Manager CloudFormation stack by launching the <code>ssm.yaml</code> CloudFormation template. The template will create the Systems Manager Automation runbook that is initiated when a new EC2 instance with the tag <code>ADJoined: FSXADD</code> launches. The Automation runbook will add the instance to AWS Managed Microsoft AD directory.</p>	

Task	Description	Skills required
Deploy the infrastructure stack.	<p>After successful deployment of the Systems Manager stack, create the <code>infra</code> stack, which includes EC2 instance nodes, security groups, the Amazon FSx for Windows File Server file system, and the IAM role.</p> <ol style="list-style-type: none"><li>1. Navigate to the CloudFormation console and launch the <code>infra-cf.yaml</code> template. To deploy this stack, the following parameters are required:<ul style="list-style-type: none"><li>• <code>ActiveDirectoryId</code> – ID for AWS Managed Microsoft AD</li><li>• <code>ADDnsIpAddresses1</code> – Primary DNS IP address of AWS Managed Microsoft AD</li><li>• <code>ADDnsIpAddresses2</code> – Secondary DNS IP address of AWS Managed Microsoft AD</li><li>• <code>FSxSecurityGroupName</code> – Name of the Amazon FSx security group</li><li>• <code>FSxWindowsFileSystemName</code> – Name of the Amazon FSx drive</li></ul></li></ol>	AWS DevOps, DevOps engineer

Task	Description	Skills required
	<ul style="list-style-type: none"><li>• ImageID – ID of the base Windows 2012 R2 image or Amazon Machine Image (AMI) used to create the SQL Server instance node</li><li>• KeyPairName – Key-value pair to attach to the EC2 instance nodes for access</li><li>• Node1SecurityGroupName – Name of the first node security group</li><li>• Node2SecurityGroupName – Name of the second node security group</li><li>• OUSecretName – Name of the secret that contains the AWS Managed Microsoft AD information</li><li>• PrivateSubnet1 – ID of the first private subnet</li><li>• PrivateSubnet2 – ID of the second private subnet</li><li>• SqlFSxFCIName – Name of the tag applied to the primary and secondary nodes and to Amazon FSx.</li></ul>	

Task	Description	Skills required
	<ul style="list-style-type: none"><li>• <code>SqlFSxServerNetBIOSName1</code> – Name of the primary EC2 instance node (maximum of 15 characters)</li><li>• <code>SqlFSxServerNetBIOSName2</code> – Name of the secondary EC2 instance node (maximum of 15 characters)</li><li>• VPC – VPC ID</li><li>• <code>WorkloadInstanceType</code> – Type of EC2 instance</li></ul> <p>Deploy the <code>infra</code> stack. The stack will create all the infrastructure components that are required to set up Windows SQL Server FCI.</p> <p>2. After the EC2 instance nodes are launched, the Systems Manager Automation document will be invoked to join these instances to AWS Managed Microsoft AD. You can track the progress on the Systems Manager console <b>Automation</b> page.</p>	

## Set up the Windows SQL Server Always On FCI

Task	Description	Skills required
Install Windows tools.	<p>1. Log in to the primary EC2 instance, which is node 1. To install the Windows features (Active Directory and FCI Tools), run the following PowerShell script.</p> <pre data-bbox="634 688 1029 1167">Install-WindowsFeature -Name RSAT-AD-Powershell,Failover-Clustering -IncludeManagementTools Install-WindowsFeature -Name RSAT-Clustering,RSAT-ADDS-Tools,RSAT-AD-Powershell,RSAT-DHCP,RSAT-DNS-Server</pre> <p>2. Log in to the secondary EC2 instance, which is node 2, and run same script to enable features on node 2.</p>	AWS DevOps, DevOps engineer, DBA
Prestage the cluster computer objects in Active Directory Domain Services.	To prestage the cluster name object (CNO) in Active Directory Domain Services (AD DS) and prestage a virtual computer object (VCO) for a clustered role, follow the instructions in the <a href="#">Windows Server documentation</a> .	AWS DevOps, DBA, DevOps engineer



Task	Description	Skills required
Create the WSFC.	<p>To create the Windows Server Failover Clustering (WSFC) cluster, do the following:</p> <ol style="list-style-type: none"><li>1. Log in to the primary EC2 instance, which is node 1. To create the Amazon FSx file share and grant full access to the listed AD service account, run the following code.</li></ol> <pre data-bbox="630 758 1029 1675">Invoke-Command - ComputerName "&lt;FSx Windows Remote PowerShell Endpoint&gt; " -ConfigurationName FSxRemoteAdmin - scriptblock { New-FSxSmbShare -Name "SQLDB" -Path "D: \share" -Descript ion "SQL Databases Share" -Continuo uslyAvailable \$true -FolderEnumeration Mode AccessBased - EncryptData \$true grant-fsx smb shareaccess -name SQLDB -AccountName "&lt;domain\user&gt;" - accessRight Full }</pre> <p>This command will also create the continuously available (CA) file share,</p>	AWS DevOps, DBA, DevOps engineer

Task	Description	Skills required
	<p>which is optimized for use by Microsoft SQL Server.</p> <p>2. To create the failover cluster on the primary instance (node 1), run the following command.</p> <pre data-bbox="634 531 1029 848">New-Cluster -Name &lt;CNO Name&gt; -Node &lt;Node1 Name&gt;, &lt;Node2 Name&gt; -StaticAddress &lt;Node1 Secondary Private IP&gt;, &lt;Node2 Secondary Private IP&gt;</pre> <p>The command requires the following parameters:</p> <ul data-bbox="630 993 1024 1478" style="list-style-type: none"><li>• Name – The name of the cluster (CNO)</li><li>• Node – The names of the primary and secondary nodes, respectively</li><li>• StaticAddress – The secondary IP addresses of the primary and secondary nodes, respectively</li></ul> <p><b>Important:</b> A domain administrator or regular user must have administrator permission on both the nodes to create the Windows Server Failover Clustering (WSFC)</p>	

Task	Description	Skills required
	<p>cluster. Otherwise, the previous command will fail and return the message, You do not have administrator privilege on servers.</p> <p>3. After the cluster is created, run the following command to attach the file share witness.</p> <pre>Set-ClusterQuorum - FileShareWitness \ &lt;FSx Windows Remote PowerShell Endpoint&gt; \share\witness</pre>	

Task	Description	Skills required
Install the SQL Server failover cluster.	<p>After the WSFC cluster is set up, install the SQL Server cluster on the primary instance (node1).</p> <ol style="list-style-type: none"><li>1. In the T drive on both nodes, create tempdb and log folders. The folders are used in the PowerShell commands.</li><li>2. After you copy the SQL Server media files for SQL Server installation on both nodes, run the following PowerShell command on node 1 to install SQL Server on node 1.</li></ol> <pre data-bbox="594 1094 1027 1822">D:\setup.exe /Q ` /ACTION=InstallF ailoverCluster ` /IACCEPTSQLSERVE RLICENSETERMS ` /FEATURES="SQL,I S,BC,Conn" ` /INSTALLSHAREDDIR="C: \Program Files\Mic rosoft SQL Server" ` /INSTALLSHAREDWO WDIR="C:\Program Files (x86)\Microsoft SQL Server" ` /RSINSTALLMODE=" FilesOnlyMode" ` /INSTANCEID="MSS QLSERVER" `</pre>	AWS DevOps, DBA, DevOps engineer

Task	Description	Skills required
	<pre> /INSTANCENAME="M SSQLSERVER" ` /FAILOVERCLUSTER GROUP="SQL Server (MSSQLSERVER)" ` /FAILOVERCLUSTER IPADDRESSES="IPv4; &lt;2nd Sec Private Ip node1&gt;;Cluster Network 1;&lt;subnet mask&gt;" ` /FAILOVERCLUSTER NETWORKNAME="&lt;Fail over cluster Network Name&gt;" ` /INSTANCEDIR="C: \Program Files\Mic rosoft SQL Server" ` /ENU="True" ` /ERRORREPORTING=0 ` /SQMREPORTING=0 ` /SAPWD="&lt;Domain User password&gt;" ` /SQLCOLLATION="S QL_Latin1_General_ CP1_CI_AS" ` /SQLSYSADMINACCO UNTS="&lt;domain\user name&gt;" ` /SQLSVCACCOUNT=" &lt;domain\username&gt;" /SQLSVCPASSWORD="&lt; Domain User password&gt;" ` /AGTSVCACCOUNT=" &lt;domain\username&gt;" /AGTSVCPASSWORD="&lt; Domain User password&gt;" ` /ISSVCACCOUNT="&lt;domain \username&gt;" /ISSVCPAS SWORD="&lt;Domain User password&gt;" ` </pre>	

Task	Description	Skills required
	<pre>/FTSVCAccount="NT Service\MSSQLFDLau ncher" ` /INSTALLSQLDATADIR="\ &lt;FSX DNS name&gt;\sha re\Program Files\Mic rosoft SQL Server" ` /SQLUSERDBDIR="\\&lt;FSX DNS name&gt;\share\data" ` /SQLUSERDBLOGDIR="\ &lt;FSX DNS name&gt;\share \log" ` /SQLTEMPDBDIR="T: \tempdb" ` /SQLTEMPDBLOGDIR="T: \log" ` /SQLBACKUPDIR="\\&lt;FSX DNS name&gt;\share\SQLBac kup" ` /SkipRules=Clust er_VerifyForErrors ` /INDICATEPROGRESS</pre>	

Task	Description	Skills required
Add a secondary node to the cluster.	<p>To add SQL Server to the secondary node (node 2), run the following PowerShell command.</p> <pre data-bbox="592 441 1031 1806">D:\setup.exe /Q ` /ACTION=AddNode ` /IACCEPTSQLSERVE RLICENSETERMS ` /INSTANCENAME="M SSQLSERVER" ` /FAILOVERCLUSTER GROUP="SQL Server (MSSQLSERVER)" ` /FAILOVERCLUSTER IPADDRESSES="IPv4; &lt;2nd Sec Private Ip node2&gt;;Cluster Network 2;&lt;subnet mask&gt;" ` /FAILOVERCLUSTER NETWORKNAME="&lt;Fail over cluster Network Name&gt;" ` /CONFIRMIPDEPEND ENCYCHANGE=1 ` /SQLSVCACCOUNT=" &lt;domain\username&gt;" /SQLSVCPASSWORD="&lt; Domain User password&gt;" ` /AGTSVCACCOUNT="domain \username&gt;" /AGTSVCPA SSWORD="&lt;Domain User password&gt;" ` /FTSVCACCOUNT="NT Service\MSSQLFDLau ncher" ` /SkipRules=Clust er_VerifyForErrors `</pre>	AWS DevOps, DBA, DevOps engineer

Task	Description	Skills required
	/INDICATEPROGRESS	
Test the SQL Server FCI.	<ol style="list-style-type: none"> <li>1. On the Windows instance for one of the nodes, in <b>Administrative Tools</b>, launch the <b>Failover Cluster Manager</b>.</li> <li>2. Navigate to <b>Nodes</b>, and confirm that the node status is <b>Status Running</b>.</li> <li>3. Select <b>Roles</b>, open the context (right-click) menu for SQL Server (MSSQLSERVER), and select <b>Move and Select Node</b>.</li> <li>4. After the node selection , SQL Server should be running on the other node.</li> </ol>	DBA, DevOps engineer

## Clean up resources

Task	Description	Skills required
Clean up resources.	<p>To clean up the resources, use the AWS CloudFormation stack deletion process:</p> <ol style="list-style-type: none"> <li>1. Open the <a href="#">AWS CloudFormation console</a>.</li> <li>2. On the <b>Stacks</b> page, select the <code>infra</code> stack. The stack must be currently running.</li> <li>3. In the stack details pane, choose <b>Delete</b>.</li> </ol>	AWS DevOps, DBA, DevOps engineer



Task	Description	Skills required
	<p>4. Select <b>Delete stack</b> when prompted.</p> <p>5. Repeat steps 2-4 for the ssm stack.</p> <p>After the stack deletion is complete, the stacks will be in the DELETE_COMPLETE state. Stacks in the DELETE_COMPLETE state aren't displayed in the CloudFormation console by default. To display deleted stacks, you must change the stack view filter as described in <a href="#">Viewing deleted stacks on the AWS CloudFormation console</a>.</p> <p>If the deletion failed, a stack will be in the DELETE_FAILED state. For solutions, see <a href="#">Delete stack fails</a> in the CloudFormation documentation.</p>	

## Troubleshooting

Issue	Solution
AWS CloudFormation template failure	<p>If the CloudFormation template fails during deployment, do the following:</p> <ol style="list-style-type: none"> <li>1. Open the <a href="#">AWS CloudFormation console</a>.</li> </ol>

Issue	Solution
AWS Managed Microsoft AD join failure	<p>To troubleshoot the join issues, follow these steps:</p> <ol style="list-style-type: none"><li>1. Open the <a href="#">Systems Manager</a> console.</li><li>2. Select the deployment Region.</li><li>3. In the left pane, choose <b>Automation</b>, and locate the failed Automation runbook.</li><li>4. Open the Automation runbook, and check for the <b>Execution status and Execution steps</b>.</li><li>5. Investigate the details of the failed step to see the exact error or failure.</li></ol>

## Related resources

- [Simplify your Microsoft SQL Server high availability deployments using Amazon FSx for Windows File Server](#)
- [Using FSx for Windows File Server with Microsoft SQL Server](#)

# Use BMC Discovery queries to extract migration data for migration planning

Created by Ben Taylor-Hamblin (AWS), Simon Cunningham (AWS), Emma Baldry (AWS), and Shabnam Khan (AWS)

<b>Environment:</b> Production	<b>Source:</b> BMC Discovery	<b>Target:</b> Migration Plan
<b>R Type:</b> Rehost	<b>Workload:</b> All other workloads	<b>Technologies:</b> Migration; Management & governance; Networking; Hybrid cloud
<b>AWS services:</b> AWS Migration Hub		

## Summary

This guide provides query examples and steps to help you extract data from your on-premises infrastructure and applications by using BMC Discovery. The pattern shows you how to use BMC Discovery queries to scan your infrastructure and extract software, service, and dependency information. The extracted data is required for the assess and mobilize phases of a large-scale migration to the Amazon Web Services (AWS) Cloud. You can use this data to make critical decisions about which applications to migrate together as part of your migration plan.

## Prerequisites and limitations

### Prerequisites

- A license for BMC Discovery (formerly BMC ADDM) or the software as a service (SaaS) version of BMC Helix Discovery
- On-premises or SaaS version of BMC Discovery, [installed](#) (**Note:** For on-premises versions of BMC Discovery, you must install the application on a client network with access to all networking and server devices that are in scope for a migration across multiple data centers. Access to the client network must be provided according to application installation instructions. If the scanning of Windows Server information is required, then you must set up a Windows proxy manager device in the network.)

- [Networking access](#) to allow the application to scan devices across data centers, if you're using BMC Helix Discovery

## Product versions

- BMC Discovery 22.2 (12.5)
- BMC Discovery 22.1 (12.4)
- BMC Discovery 21.3 (12.3)
- BMC Discovery 21.05 (12.2)
- BMC Discovery 20.08 (12.1)
- BMC Discovery 20.02 (12.0)
- BMC Discovery 11.3
- BMC Discovery 11.2
- BMC Discovery 11.1
- BMC Discovery 11.0
- BMC Atrium Discovery 10.2
- BMC Atrium Discovery 10.1
- BMC Atrium Discovery 10.0

## Architecture

The following diagram shows how asset managers can use BMC Discovery queries to scan BMC-modeled applications in both SaaS and on-premises environments.

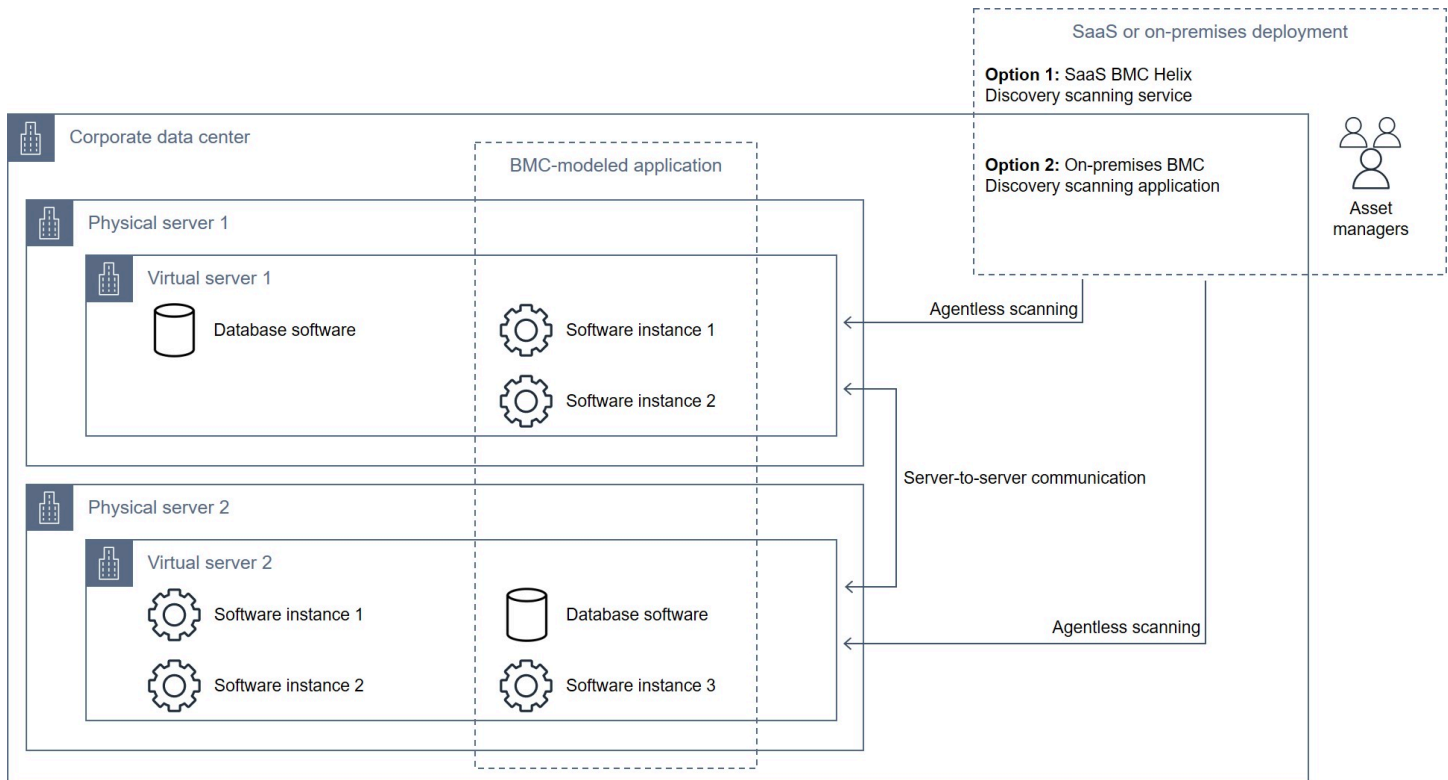

The diagram shows the following workflow: An asset manager uses BMC Discovery or BMC Helix Discovery to scan database and software instances running on virtual servers hosted on multiple physical servers. The tool can model applications with components spanning multiple virtual and physical servers.

## Technology stack

- BMC Discovery
- BMC Helix Discovery

## Tools

- [BMC Discovery](#) is a data center discovery tool that helps you automatically discover your data center.
- [BMC Helix Discovery](#) is a SaaS-based discovery and dependency modeling system that helps you dynamically model your data assets and their dependencies.

## Best practices

It's a best practice to map application, dependency, and infrastructure data when you migrate to the cloud. Mapping helps you understand the complexity of your current environment and the dependencies among various components.

The asset information these queries provide is important for several reasons:

1. **Planning** – Understanding the dependencies between components helps you plan the migration process more effectively. For example, you might need to migrate certain components first in order to ensure that others can be migrated successfully.
2. **Risk assessment** – Mapping the dependencies between components can help you identify any potential risks or issues that can arise during the migration process. For example, you might discover that certain components rely on outdated or unsupported technologies that could cause issues in the cloud.
3. **Cloud architecture** – Mapping your application and infrastructure data can also help you to design a suitable cloud architecture that meets your organizational needs. For example, you might need to design a multi-tier architecture to support high availability or scalability requirements.

Overall, mapping application, dependency, and infrastructure data is a crucial step in the cloud migration process. The mapping exercise can help you better understand your current environment, identify any potential issues or risks, and design a suitable cloud architecture.

## Epics

### Identify and evaluate discovery tooling

Task	Description	Skills required
Identify ITSM owners.	Identify the IT Service Management (ITSM) owners (usually by reaching out to the operational support teams).	Migration lead
Check CMDB.	Identify the number of configuration managemen	Migration lead

Task	Description	Skills required
	t databases (CMDBs) that contain asset information, and then identify the sources of that information.	
Identify discovery tools and check for use of BMC Discovery.	If your organization is using BMC Discovery to send data about your environment to the CMDB tool, check the scope and coverage of its scans. For example, check if BMC Discovery is scanning all data centers and if the access servers are located in perimeter zones.	Migration lead
Check the level of application modelling.	Check if applications are modelled in BMC Discovery . If not, recommend the use of the BMC Discovery tool to model which running software instances provide an application and business service.	Migration engineer, Migration lead

## Extract infrastructure data

Task	Description	Skills required
Extract data on physical and virtual servers.	To extract data on the physical and virtual servers scanned by BMC Discovery, use <a href="#">Query Builder</a> to run the following query:	Migration engineer, Migration lead

Task	Description	Skills required
	<pre>search Host show key as 'Serverid ', virtual, name as 'HOSTNAME', os_type as 'osName', os_versio n as 'OS Version', num_logical_proces sors as 'Logical Processor Counts', cores_per_processo r as 'Cores per Processor', logical_r am as 'Logical RAM', #Consumer:StorageU se:Provider:DiskDr ive.size as 'Size'</pre> <p><b>Note:</b> You can use extracted data to determine the appropriate instance sizes for migration.</p>	



Task	Description	Skills required
Extract data on modeled applications.	<p>If your applications are modeled in BMC Discovery , you can extract data about the servers that run the application software. To get the server names, use <a href="#">Query Builder</a> to run the following query:</p> <pre data-bbox="594 632 1027 951">search SoftwareInstance   show key as 'ApplicationID', #RunningSoftware:HostedSoftware:Host:Host.key as 'ReferenceID', type, name</pre> <p><b>Note:</b> Applications are modeled in BMC Discovery by a collection of running software instances. The application is dependent on all the servers that run the application software.</p>	BMC Discovery application owner

Task	Description	Skills required
Extract data on databases.	<p>To get a list of all scanned databases and the servers these databases are running on, use <a href="#">Query Builder</a> to run the following query:</p> <pre data-bbox="594 489 1029 1402">search Database show key as 'Key', name, type as 'Source Engine Type', #Detail:D etail:ElementWithD etail:SoftwareInst ance.name as 'Software Instance', #Detail:D etail:ElementWithD etail:SoftwareInst ance.product_version as 'Product Version', #Detail:Detail:Ele mentWithDetail:Sof twareInstance.edit ion as 'Edition', #Detail:Detail:Ele mentWithDetail:Sof twareInstance.#Run ningSoftware:Hoste dSoftware:Host:Hos t.key as 'ServerID'</pre>	App owner

Task	Description	Skills required
Extract data on server communication.	<p>To get information on all the network communications between servers that's collected by BMC Discovery from historic network communications logs, use <a href="#">Query Builder</a> to run the following query:</p> <pre data-bbox="597 632 1027 1268"> search Host   TRVERSE InferredElement:Inference:Associate:DiscoveryAccess   TRVERSE DiscoveryAccess:DiscoveryAccessResult:DiscoveryResult:NetworkConnectionList   TRVERSE List:List:Member:DiscoveredNetworkConnection   PROCESS WITH networkConnectionInfo </pre>	BMC Discovery application owner
Extract data on application discovery.	<p>To get information on application dependencies, use <a href="#">Query Builder</a> to run the following query:</p> <pre data-bbox="597 1522 1027 1843"> search SoftwareInstance   show key as 'SRC App ID', #Dependant:Dependency:DependedUpon:SoftwareInstance.key as 'DEST App ID' </pre>	BMC Discovery application owner

Task	Description	Skills required
Extract data on business services.	<p>To extract data on business services provided by hosts, use <a href="#">Query Builder</a> to run the following query:</p> <pre data-bbox="597 443 1027 678">search Host show name, #Host:HostedSoftwa re:AggregateSoftwa re:BusinessService .name as 'Name'</pre>	BMC Discovery application owner

## Troubleshooting

Issue	Solution
A query fails to run or contains unpopulated columns.	Review the asset records in BMC Discovery and determine which fields you require. Then, replace these fields in the query by using the <a href="#">Query Builder</a> .
The details of a dependent asset aren't populated.	<p>This is likely due to access permissions or network connectivity. The discovery tool might not have the necessary permissions to access certain assets, particularly if they are on different networks or in different environments.</p> <p>We recommend that you work closely with discovery subject matter experts to ensure that all relevant assets are identified.</p>

## Related resources

## References

- [BMC Discovery Licensing entitlement](#) (BMC documentation)
- [BMC Discovery features and components](#) (BMC documentation)
- [BMC Discovery User Guide](#) (BMC documentation)
- [Searching for data \(on BMC Discovery\)](#) (BMC documentation)
- [Portfolio discovery and analysis for migration](#) (AWS Prescriptive Guidance)

## Tutorials and videos

- [BMC Discovery: Webinar - Reporting Query Best Practices \(Part 1\)](#) (YouTube)

# Relocate

## Topics

- [Migrate an Amazon RDS for Oracle database to another AWS account and AWS Region using AWS DMS for ongoing replication](#)
- [Migrate VMware SDDC to VMware Cloud on AWS using VMware HCX](#)
- [Migrate an Amazon RDS DB instance to another VPC or account](#)
- [Migrate an Amazon RDS for Oracle DB instance to another VPC](#)
- [Migrate an Amazon Redshift cluster to an AWS Region in China](#)
- [Migrate workloads to the VMware Cloud on AWS by using VMware HCX](#)
- [Transport PostgreSQL databases between two Amazon RDS DB instances using pg\\_transport](#)

# Migrate an Amazon RDS for Oracle database to another AWS account and AWS Region using AWS DMS for ongoing replication

Created by Durga Prasad Cheepuri (AWS) and Eduardo Valentim (AWS)

<b>Environment:</b> PoC or pilot	<b>Source:</b> Databases: Relational	<b>Target:</b> Amazon RDS for Oracle
<b>R Type:</b> Relocate	<b>Workload:</b> Oracle	<b>Technologies:</b> Migration; Databases
<b>AWS services:</b> Amazon RDS		

## Summary

**Warning:** IAM users have long-term credentials, which presents a security risk. To help mitigate this risk, we recommend that you provide these users with only the permissions they require to perform the task and that you remove these users when they are no longer needed.

This pattern walks you through the steps for migrating an Amazon Relational Database Service (Amazon RDS) for Oracle source database to a different AWS account and AWS Region. The pattern uses a DB snapshot for a one-time full data load, and enables AWS Database Migration Service (AWS DMS) for ongoing replication.

## Prerequisites and limitations

### Prerequisites

- An active AWS account that contains the source Amazon RDS for Oracle database, which has been encrypted using a non-default AWS Key Management Service (AWS KMS) key
- An active AWS account in a different AWS Region from the source database, to use for the target Amazon RDS for Oracle database
- Virtual private cloud (VPC) peering between the source and target VPCs
- Familiarity with [using an Oracle database as a source for AWS DMS](#)

- Familiarity with [using an Oracle database as a target for AWS DMS](#)

### Product versions

- Oracle versions 11g (versions 11.2.0.3.v1 and later) and up to 12.2, and 18c. For the latest list of supported versions and editions, see [Using an Oracle Database as a Source for AWS DMS](#) and with [Using an Oracle database as a target for AWS DMS](#) in the AWS documentation. For Oracle versions supported by Amazon RDS, see [Oracle on Amazon RDS](#).

## Architecture

### Source and target technology stacks

- Amazon RDS for Oracle DB instance

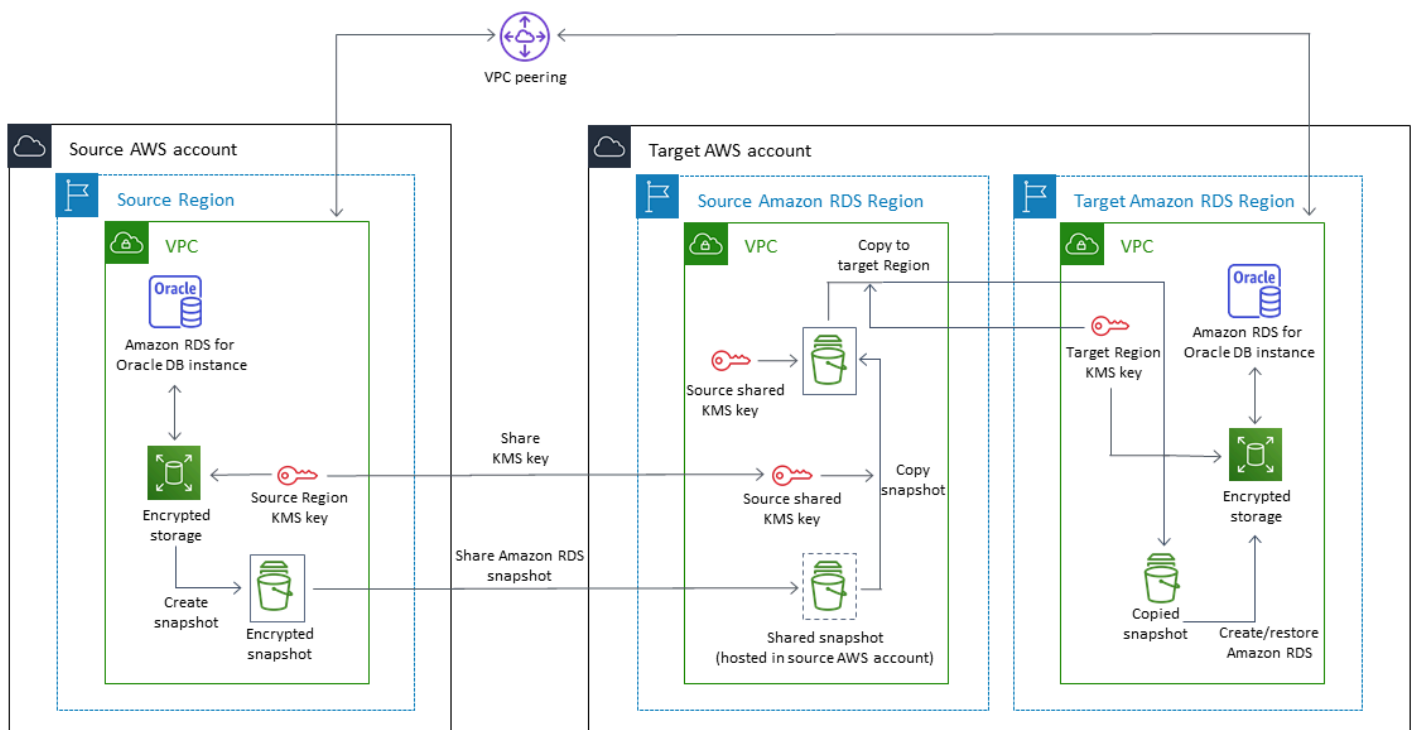

### Ongoing replication architecture



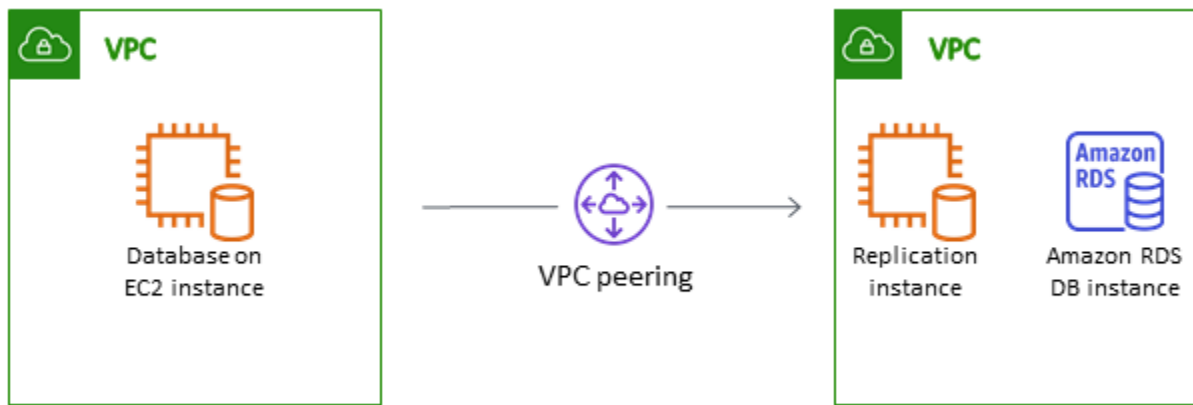

## Tools

### Tools used for one-time full data load

- [Amazon Relational Database Service \(Amazon RDS\)](#) creates a storage volume snapshot of your DB instance, backing up the entire DB instance and not just individual databases. When you create a DB snapshot, you need to identify which DB instance you are going to back up, and then give your DB snapshot a name so you can restore from it later. The amount of time it takes to create a snapshot varies with the size of your databases. Because the snapshot includes the entire storage volume, the size of files, such as temporary files, also affects the amount of time it takes to create the snapshot. For more information about using DB snapshots, see [Creating a DB Snapshot](#) in the Amazon RDS documentation.
- [AWS Key Management Service \(AWS KMS\)](#) creates a key for Amazon RDS encryption. When you create an encrypted DB instance, you can also supply the [AWS KMS](#) key identifier for your encryption key. If you don't specify an [AWS KMS](#) key identifier, Amazon RDS uses your default encryption key for your new DB instance. [AWS KMS](#) creates your default encryption key for your AWS account. Your AWS account has a different default encryption key for each AWS Region. For this pattern, the Amazon RDS DB instance should be encrypted using the non-default [AWS KMS](#) key. For more information about using [AWS KMS](#) keys for Amazon RDS encryption, see [Encrypting Amazon RDS resources](#) in the Amazon RDS documentation.

### Tools used for ongoing replication

- [AWS Database Migration Service \(AWS DMS\)](#) is used to replicate ongoing changes and to keep the source and target databases in sync. For more information about using AWS DMS

for ongoing replication, see [Working with an AWS DMS replication instance](#) in the AWS DMS documentation.

## Epics

### Configure your source AWS account

Task	Description	Skills required
Prepare the source Oracle DB instance.	Let the Amazon RDS for Oracle DB instance run in ARCHIVELOG mode, and set the retention period. For details, see <a href="#">Working with an AWS managed Oracle database as a source for AWS DMS</a> .	DBA
Set supplemental logging for the source Oracle DB instance.	Set database-level and table-level supplemental logging for the Amazon RDS for Oracle DB instance. For details, see <a href="#">Working with an AWS managed Oracle database as a source for AWS DMS</a> .	DBA
Update the AWS KMS key policy in the source account.	Update the AWS KMS key policy in the source AWS account to allow the target AWS account to use the encrypted Amazon RDS AWS KMS key. For details, see the <a href="#">AWS KMS documentation</a> .	SysAdmin

Task	Description	Skills required
Create a manual Amazon RDS DB snapshot of the source DB instance.		AWS IAM user
Share the manual, encrypted Amazon RDS snapshot with the target AWS account.	For details, see <a href="#">Sharing a DB snapshot</a> .	AWS IAM user

### Configure your target AWS account

Task	Description	Skills required
Attach a policy.	In the target AWS account, attach an AWS Identity and Access Management (IAM) policy to the root IAM user, to allow the IAM user to copy an encrypted DB snapshot using the shared AWS KMS key.	SysAdmin
Switch to the source AWS Region.		AWS IAM user
Copy the shared snapshot.	In the Amazon RDS console, in the <b>Snapshots</b> pane, choose <b>Shared with Me</b> , and select the shared snapshot. Copy the snapshot to the same AWS Region as the source database by using the Amazon Resource Name (ARN) for the AWS KMS key used by the source database.	AWS IAM user

Task	Description	Skills required
	For details, see <a href="#">Copying a DB snapshot</a> .	
Switch to the target AWS Region, and create a new AWS KMS key.		AWS IAM user
Copy the snapshot.	Switch to the source AWS Region. On the Amazon RDS console, in the <b>Snapshots</b> pane, choose <b>Owned by Me</b> , and select the copied snapshot. Copy the snapshot to the target AWS Region by using the AWS KMS key for the new target AWS Region.	AWS IAM user
Restore the snapshot.	Switch to the target AWS Region. On the Amazon RDS console, in the <b>Snapshots</b> pane, choose <b>Owned by Me</b> . Select the copied snapshot and restore it to an Amazon RDS for Oracle DB instance. For details, see <a href="#">Restoring from a DB snapshot</a> .	AWS IAM user

## Prepare your source database for ongoing replication

Task	Description	Skills required
Create an Oracle user with the appropriate permissions.	Create an Oracle user with the required privileges for Oracle as a source for AWS	DBA

Task	Description	Skills required
	DMS. For details, see the <a href="#">AWS DMS documentation</a> .	
Configure the source database for Oracle LogMiner or Oracle Binary Reader.		DBA

## Prepare your target database for ongoing replication

Task	Description	Skills required
Create an Oracle user with the appropriate permissions.	Create an Oracle user with the required privileges for Oracle as a target for AWS DMS. For details, see the <a href="#">AWS DMS documentation</a> .	DBA

## Create AWS DMS components

Task	Description	Skills required
Create a replication instance in the target AWS Region.	Create a replication instance in the VPC of the target AWS Region. For details, see the <a href="#">AWS DMS documentation</a> .	AWS IAM user
Create source and target endpoints with required encryption, and test connections.	For details, see the <a href="#">AWS DMS documentation</a> .	DBA
Create replication tasks.	1. For the migration type, choose ongoing replication.	IAM user

Task	Description	Skills required
	<ol style="list-style-type: none"><li data-bbox="592 212 1023 625">2. For the change data capture (CDC) start point, use the Oracle system change number (SCN) when the Amazon RDS snapshot was taken for full load, or the timestamp when the full load was taken.</li><li data-bbox="592 646 1023 1060">3. For TargetTablePrepMode, choose <b>DO_NOTHING</b>. If the task has large binary object (LOB) data tables, choose <b>Limited LOB mode</b>, and set the <b>max LOB size</b> to the maximum size of the LOB data in the table.</li><li data-bbox="592 1081 852 1123">4. Enable logging.</li><li data-bbox="592 1144 1023 1606">5. Group tables that are related through keys into a single task. If there are tables with a large amount of LOB data and the table has no relationship with other tables, create a separate task for it with the LOB settings described previously.</li></ol> <p data-bbox="592 1690 1023 1774">For details, see the <a href="#">AWS DMS documentation</a>.</p>	

Task	Description	Skills required
Start the tasks and monitor them.	For details, see the <a href="#">AWS DMS documentation</a> .	AWS IAM user
Enable validation on the task if needed.	Note that enabling validation does have a performance impact on the replication. For details, see the <a href="#">AWS DMS documentation</a> .	AWS IAM user

## Related resources

- [Changing a key policy](#)
- [Creating a manual Amazon RDS DB snapshot](#)
- [Sharing a manual Amazon RDS DB snapshot](#)
- [Copying a snapshot](#)
- [Restoring from an Amazon RDS DB snapshot](#)
- [Getting started with AWS DMS](#)
- [Using an Oracle database as a source for AWS DMS](#)
- [Using an Oracle database as a target for AWS DMS](#)
- [AWS DMS setup using VPC peering](#)
- [How do I share manual Amazon RDS DB snapshots or DB cluster snapshots with another AWS account? \(AWS Knowledge Center article\)](#)

# Migrate VMware SDDC to VMware Cloud on AWS using VMware HCX

Created by Deepak Kumar (AWS)

<b>Environment:</b> PoC or pilot	<b>Source:</b> Networking	<b>Target:</b> VMware Cloud on AWS
<b>R Type:</b> Relocate	<b>Technologies:</b> Migration; Infrastructure	

## Summary

**Notice:** As of April 30, 2024, VMware Cloud on AWS is no longer resold by AWS or its channel partners. The service will continue to be available through Broadcom. We encourage you to reach out to your AWS representative for details.

This pattern describes the use of VMware Hybrid Cloud Extension (HCX) to migrate your on-premises virtual machines (VMs) and applications to VMware Cloud on Amazon Web Services (AWS). The migration uses VMware enterprise-class software-defined data center (SDDC) software on the AWS Cloud to provide optimized access to AWS services.

VMware Cloud on AWS integrates compute, storage, and network virtualization products (vSphere, vSAN, and VMware NSX) with VMware vCenter server management, which is optimized to run on dedicated, elastic, bare-metal AWS infrastructure. The resulting infrastructure is low-maintenance, simplified, and hyper-converged.

With this service, IT teams can manage their cloud-based resources with familiar VMware tools. For more information, see [VMware Cloud on AWS](#) on the VMware website.

VMware HCX supports three types of cloud migrations:

- **Hybridity (data center extension):** Extending an existing, on-premises VMware SDDC to AWS to provide footprint expansion, on-demand capacity, a testing/development environment, and virtual desktops.



- **Cloud evacuation (data center-wide infrastructure refresh):** Consolidating data centers and moving completely to the AWS Cloud (including handling data center co-location or end of lease).
- **Application-specific migration:** Moving individual applications to the AWS Cloud to meet specific business needs.

## Prerequisites and limitations

### Prerequisites

- Sign up for an AWS account (required for VMware Cloud SDDC creation).
- Sign up for a My VMware account. Register at <https://my.vmware.com/web/vmware/> and fill out all fields.
- Check the version of vCenter and hosts, and collect the number of VMs. If possible, ask for an [RVTools](#) export to display information about your virtual environments. We recommend vCenter version 6.0 or later.
- You must deploy distributed virtual switches if you want to extend data center networks (L2), test vMotion by using HCX, or analyze application dependency by using vRealize Network Insight.
- Pick a non-conflicting on-premises current management subnet network to create the SDDC on VMware Cloud on AWS.
- Validate HCX requirements by reviewing the prerequisites provided in the [VMware HCX User Guide](#).
- Identify and group VMs for waves of migration. Check for VMs that you can use for testing.
- Collect any data about relative bandwidth consumption, WAN compression, and data transfer speed.

### Notes

- No need for VMware NSX-V or NSX-T on premises.
- No additional costs for HCX (it's included in VMware Cloud on AWS).

## Architecture

The following diagram shows the HCX solution built on multiple component services. Each component supports a specific function in the HCX solution. For more information about each HCX

component, see the blog post [Migrating Workloads to VMware Cloud on AWS with Hybrid Cloud Extension \(HCX\)](#).

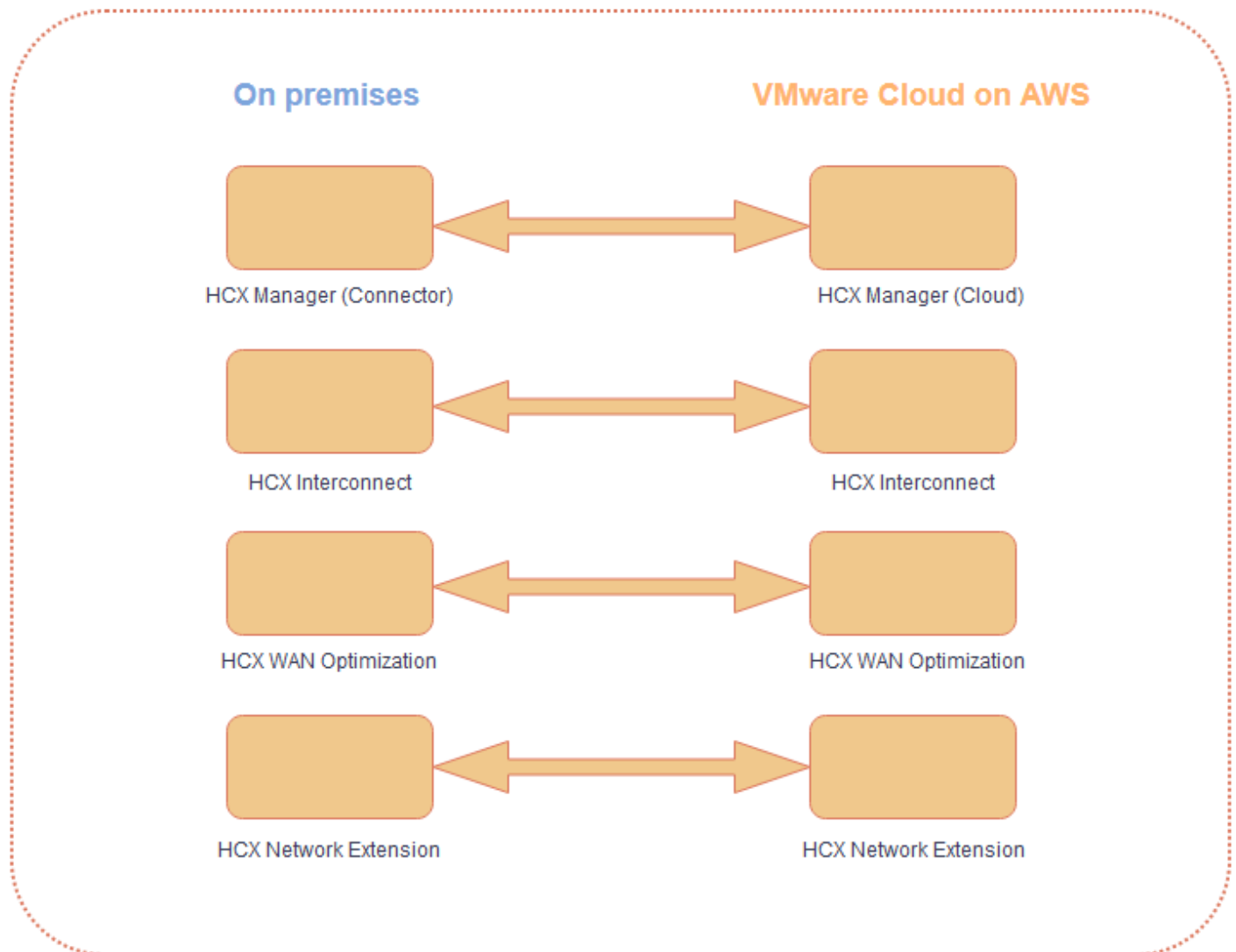

### Source technology stack

- On-premises VMs and applications managed by VMware vSphere

### Target technology stack

- VMware Cloud on AWS

## Tools

- [VMware HCX](#) – VMware HCX is a tool that you can use to migrate your applications and workloads across data centers and cloud environments. It is included with VMware Cloud on AWS.

## Epics

### Plan the migration

Task	Description	Skills required
Choose a migration strategy.	Decide whether you want to extend your data center (hybridity), move all your data centers (cloud evacuation), or move specific applications to AWS.	SysAdmin, App owner
Validate HCX requirements.	For migration information, review the <a href="#">VMware HCX User Guide</a> .	SysAdmin, App owner

### Migrate to VMware Cloud on AWS

Task	Description	Skills required
Migrate your VMs or applications.	For more information, see <a href="#">Hybrid Migration with VMware HCX</a> in the VMware documentation.	SysAdmin, App owner

## Related resources

- [VMware Cloud on AWS: Getting Started](#)
- [Hybrid Migration with VMware HCX](#)

- [VMware HCX User Guide](#)
- [VMware Cloud on AWS Pricing](#)
- [VMware Cloud on AWS Roadmap](#)

# Migrate an Amazon RDS DB instance to another VPC or account

Created by Dhrubajyoti Mukherjee (AWS)

<b>Environment:</b> PoC or pilot	<b>Source:</b> Amazon RDS	<b>Target:</b> Amazon RDS
<b>R Type:</b> Relocate	<b>Technologies:</b> Migration; Databases	<b>AWS services:</b> Amazon RDS; Amazon VPC

## Summary

This pattern provides guidance for migrating an Amazon Relational Database Service (Amazon RDS) DB instance from one virtual private cloud (VPC) to another in the same AWS account, or from one AWS account to another AWS account.

This pattern is useful if you want to migrate your Amazon RDS DB instances to another VPC or account for separation or security reasons (for example, when you want to place your application stack and database in different VPCs).

Migrating a DB instance to another AWS account involves steps such as taking a manual snapshot, sharing it, and restoring the snapshot in the target account. This process can be time-consuming, depending on database changes and transaction rates. It also causes database downtime, so plan ahead for the migration. Consider a blue/green deployment strategy to minimize downtime. Alternatively, you can evaluate AWS Data Migration Service (AWS DMS) to minimize downtime for the change. However, this pattern doesn't cover this option. To learn more, see the [AWS DMS documentation](#).

## Prerequisites and limitations

### Prerequisites

- An active AWS account
- AWS Identity and Access Management (IAM) permissions required for the VPC, subnets, and Amazon RDS console

### Limitations

- Changes to a VPC cause a database reboot, resulting in application outages. We recommend that you migrate during low peak times.
- Limitations when migrating Amazon RDS to another VPC:
  - The DB instance you're migrating must be a single instance with no standby. It must not be a member of a cluster.
  - Amazon RDS must not be in multiple Availability Zones.
  - Amazon RDS must not have any read replicas.
  - The subnet group created in the target VPC must have subnets from the Availability Zone where the source database is running.
- Limitations when migrating Amazon RDS to another AWS account:
  - Sharing snapshots encrypted with the default service key for Amazon RDS isn't currently supported.

## Architecture

### Migrating to a VPC in the same AWS account

The following diagram shows the workflow for migrating an Amazon RDS DB instance to a different VPC in the same AWS account.

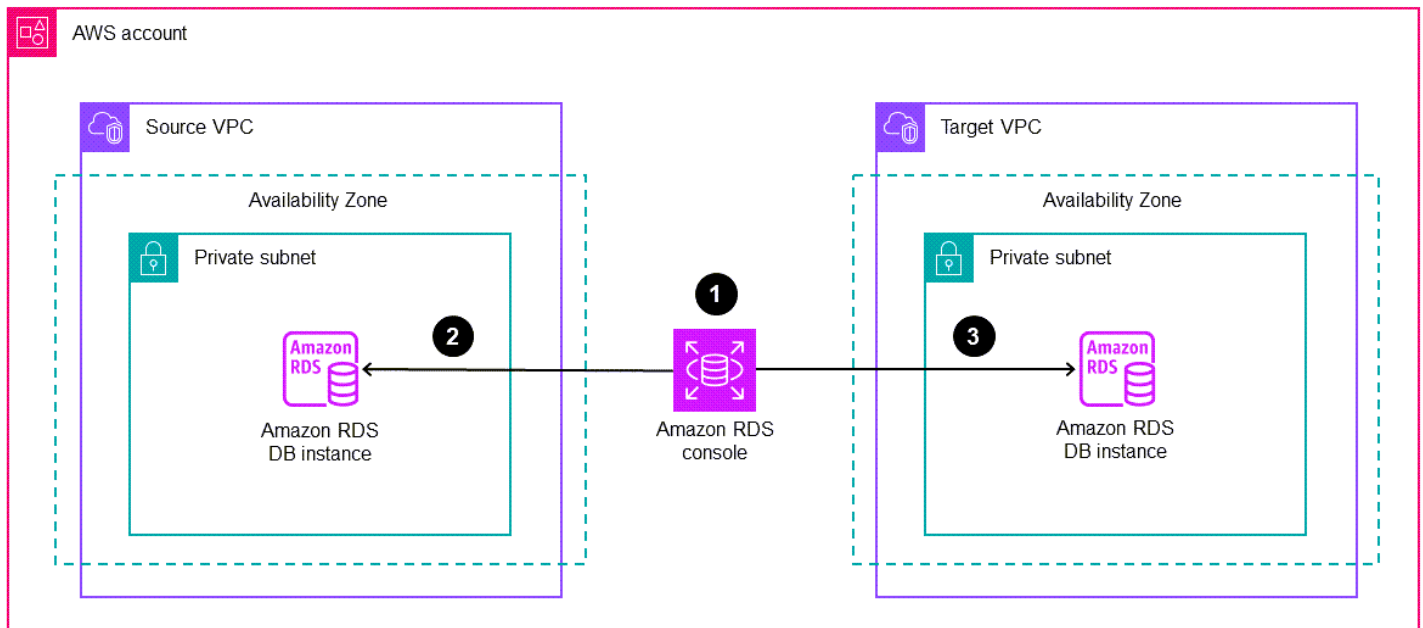

The steps consist of the following. See the [Epics](#) section for detailed instructions.

1. Create a DB subnet group in the target VPC. A DB subnet group is a collection of subnets that you can use to specify a specific VPC when you create DB instances.
2. Configure the Amazon RDS DB instance in the source VPC to use the new DB subnet group.
3. Apply the changes to migrate the Amazon RDS DB to the target VPC.

## Migrating to a different AWS account

The following diagram shows the workflow for migrating an Amazon RDS DB instance to a different AWS account.

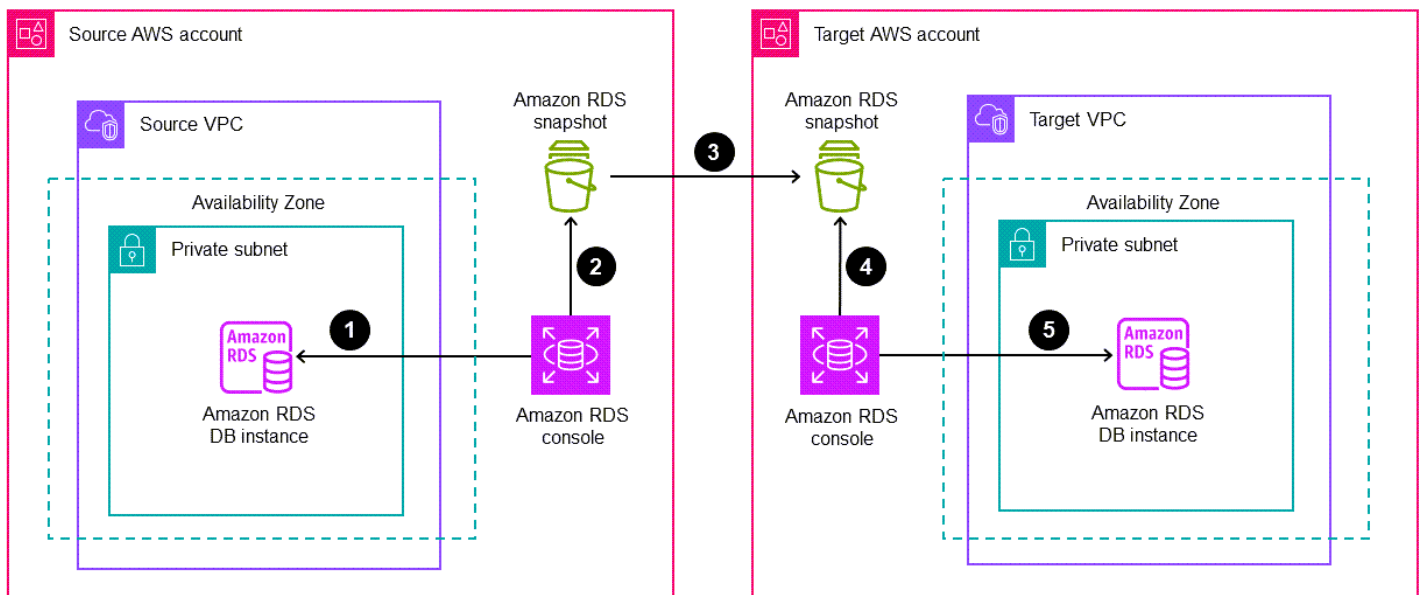

The steps consist of the following. See the [Epics](#) section for detailed instructions.

1. Access the Amazon RDS DB instance in the source AWS account.
2. Create an Amazon RDS snapshot in the source AWS account.
3. Share the Amazon RDS snapshot with the target AWS account.
4. Access the Amazon RDS snapshot in the target AWS account.
5. Create an Amazon RDS DB instance in the target AWS account.

## Tools

### AWS services

- [Amazon Relational Database Service \(Amazon RDS\)](#) helps you set up, operate, and scale a relational database in the AWS Cloud.
- [Amazon Virtual Private Cloud \(Amazon VPC\)](#) helps you launch AWS resources into a virtual network that you've defined. This virtual network resembles a traditional network that you'd operate in your own data center, with the benefits of using the scalable infrastructure of AWS.

## Best practices

- If database downtime is a concern when migrating an Amazon RDS DB instance to another account, we recommend that you use [AWS DMS](#). This service provides data replication, which causes less than five minutes of outage time.

## Epics

### Migrate to a different VPC in the same AWS account

Task	Description	Skills required
Create a new VPC.	On the <a href="#">Amazon VPC console</a> , create a new VPC and subnets with the desired properties and IP address ranges. For detailed instructions, see the <a href="#">Amazon VPC documentation</a> .	Administrator
Create a DB subnet group.	On the <a href="#">Amazon RDS console</a> : <ol style="list-style-type: none"> <li>1. Choose <b>Subnet groups</b>, <b>Create DB subnet group</b>.</li> <li>2. Enter the subnet group name, description, and VPC ID.</li> <li>3. Add the subnets that belong to the subnet group. Add subnets to</li> </ol>	Administrator



Task	Description	Skills required
	<p>cover at least two Availability Zones.</p> <p>4. Choose <b>Create</b>.</p> <p>For additional information, see the <a href="#">Amazon RDS documentation</a>.</p>	

Task	Description	Skills required
<p>Modify the Amazon RDS DB instance to use the new subnet group.</p>	<p>On the Amazon RDS console:</p> <ol style="list-style-type: none"><li>1. In the navigation pane, choose <b>Databases</b>, and then choose the Amazon RDS DB instance to be migrated.</li><li>2. In the <b>Connectivity</b> section, choose the subnet group that's associated with the target VPC.</li><li>3. In the <b>Schedule modifications</b> section, choose <b>Apply immediately</b>.</li></ol> <p>When the migration to the target VPC is complete, the target VPC's default security group is assigned to the Amazon RDS DB instance. You can configure a new security group for that VPC with the required inbound and outbound rules to your DB instance.</p> <p>Alternatively, use the AWS Command Line Interface (AWS CLI) to perform the migration to the target VPC by explicitly providing the new VPC security group ID. For example:</p>	<p>Administrator</p>

Task	Description	Skills required
	<pre>aws rds modify-db- instance \   --db-instance-iden- tifier testrds \   --db-subnet-group- name new-vpc-subnet- group \   --vpc-security-gro- up-ids sg-idxxxx \   --apply-immediatel- y</pre>	

## Migrate to a different AWS account

Task	Description	Skills required
<p>Create a new VPC and subnet group in the target AWS account.</p>	<ol style="list-style-type: none"> <li>1. On the <a href="#">Amazon VPC console</a>, create a new VPC with the desired properties and IP address ranges. For detailed instructions, see the <a href="#">Amazon VPC documentation</a>.</li> <li>2. Create subnets for the new VPC by following the instructions in the <a href="#">Amazon VPC documentation</a>.</li> <li>3. On the <a href="#">Amazon RDS console</a>, create DB subnet groups. For instructions, see the <a href="#">Amazon RDS documentation</a>.</li> </ol>	<p>Administrator</p>

Task	Description	Skills required
Share a manual snapshot of the database and share it with the target account.	<ol style="list-style-type: none"> <li>1. Take a manual snapshot of the source database by following the instructions in the <a href="#">Amazon RDS documentation</a>.</li> <li>2. Share the snapshot with the target AWS account by providing the target account ID. For instructions, see the <a href="#">re:Post article</a> about sharing DB snapshots with other accounts.</li> </ol>	Administrator
Launch a new Amazon RDS DB instance.	Launch a new Amazon RDS DB instance from the shared snapshot in the target AWS account. For instructions, see the <a href="#">Amazon RDS documentation</a> .	Administrator

## Related resources

- [Amazon VPC documentation](#)
- [Amazon RDS documentation](#)
- [How do I change the VPC for an RDS DB instance?](#) (AWS re:Post article)
- [How do I transfer ownership of Amazon RDS resources to a different AWS account?](#) (AWS re:Post article)
- [How do I share manual Amazon RDS DB snapshots or Aurora DB cluster snapshots with another AWS account?](#) (AWS re:Post article)
- [AWS DMS documentation](#)

# Migrate an Amazon RDS for Oracle DB instance to another VPC

Created by Pinesh Singal (AWS)

<b>Environment:</b> PoC or pilot	<b>Source:</b> Databases: Relational	<b>Target:</b> Amazon RDS for Oracle
<b>R Type:</b> Relocate	<b>Workload:</b> Oracle	<b>Technologies:</b> Migration; Databases
<b>AWS services:</b> Amazon RDS		

## Summary

This migration pattern provides step-by-step guidance for migrating an Amazon Relational Database Service (Amazon RDS) for Oracle database (DB) instance from one virtual private cloud (VPC) to another VPC in same Amazon Web Services (AWS) account. For example, you can use this pattern if your business requires that the database and the Amazon Elastic Compute Cloud (Amazon EC2) application server are in the same VPC.

The pattern describes an online migration strategy with almost no downtime for a multi-terabyte Oracle source database with a high number of transactions.

To move an Amazon RDS for Oracle DB instance to another VPC, you must change the Amazon RDS subnet group. This subnet group needs to be preconfigured with the new VPC and required subnets. During the VPC change from one network to another, the Amazon RDS instance reboots, so the database won't be accessible while the movement is in progress.

## Prerequisites and limitations

### Prerequisites

- An active AWS account
- Two VPCs with private subnets
- An Amazon RDS for Oracle database instance (up and running), configured with inbound and outbound security groups

## Limitations

- A DB instance that spans multiple Availability Zones (Multi-AZ) is not supported. This pattern, however, provides a way to work around this limitation.
- The DB instance can't be migrated while a read replica is turned on.
- The subnet group in the new VPC should be in the same Availability Zone as the database.
- Migration should occur during scheduled maintenance period or low-traffic times, because moving the DB to another VPC causes a database reboot, resulting in application outages for few minutes.

## Product versions

- Amazon RDS for Oracle DB instance, 12.1.0.2 and later

## Architecture

### Source technology stack

- An Amazon RDS for Oracle 12.1.0.2.v22 DB instance in a VPC
- A VPC configured in a separate route table
- Amazon RDS subnet groups configured in a VPC
- Amazon RDS option groups (if needed)

### Target technology stack

- Amazon RDS for Oracle database instance with version 12.1.0.2.v22 in another VPC
- Amazon VPC configured in separate route
- Amazon RDS Subnet Groups configured in new VPC
- Amazon RDS Option Groups (if needed)

### Source and target architecture

The following diagram shows using the console to move the Amazon RDS for Oracle DB from a private subnet in one VPC to a private subnet in a different VPC.

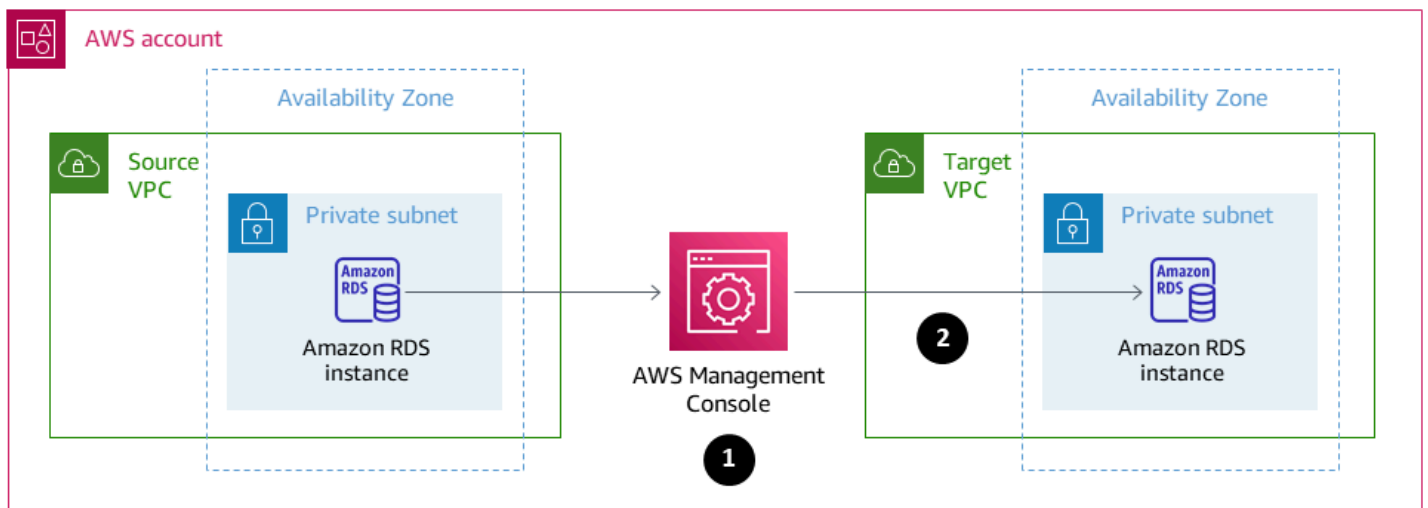

1. Use the console to modify the source Amazon RDS for Oracle DB instance.
2. In the target VPC, modify the subnet group, and modify the option group if used.

## Tools

- [Amazon RDS](#) – Amazon Relational Database Service (Amazon RDS) is a web service that makes it easier to set up, operate, and scale a relational database in the AWS Cloud. It provides cost-efficient, resizable capacity for a relational database and manages common database administration tasks. This pattern uses Amazon RDS for Oracle.

## Epics

### Change the configuration of the Amazon RDS for Oracle database in the existing VPC

Task	Description	Skills required
Create a subnet group.	Configure a subnet group in Amazon RDS.	General AWS
Create an option group.	(Optional) Configure an option group in Amazon RDS.	General AWS

Task	Description	Skills required
Modify the Amazon RDS for Oracle DB instance.	Modify the database with the subnet group and option group.	General AWS, DBA
Update the Oracle database, if necessary.	To migrate the source Amazon RDS for Oracle database, make the following changes: <ul style="list-style-type: none"> <li>Remove read replicas, if they exist.</li> <li>Turn off the Multi-AZ feature, if it's turned on.</li> </ul>	General AWS

### Configure the Amazon RDS for Oracle database in the target VPC

Task	Description	Skills required
Create a subnet group.	In Amazon RDS, configure a subnet group using the subnet of the new VPC and the Availability Zone of the database.	General AWS
Create an option group.	(Optional) Configure an option group in Amazon RDS.	General AWS
Modify the Amazon RDS for Oracle database.	Modify the database with new subnet group and option group of the new VPC. You can apply these changes immediately or in a maintenance window.	General AWS, DBA



Task	Description	Skills required
	<p>The modification can take several minutes to complete. During the modification, you will see the following status changes:</p> <ul style="list-style-type: none"><li>• moving-to-vpc</li><li>• Configuring-enhanced-monitoring</li><li>• Modifying</li><li>• Available</li></ul> <p>The modification will attach the default security group of the new VPC. Attach a new security group as needed by Amazon RDS for Oracle.</p>	
Update the Amazon RDS for Oracle database, if necessary.	<p>After migrating to the target Amazon RDS for Oracle database in the new VPC, make the following modifications, if needed:</p> <ul style="list-style-type: none"><li>• Turn on read replicas, if they existed in the source database.</li><li>• Turn on the Multi-AZ feature, if it was turned on in the source database.</li></ul>	General AWS

Task	Description	Skills required
Test application connectivity.	Perform a database connectivity test from any application. Confirm that the modified Amazon RDS for Oracle DB in the new VPC is connected and is accessible from the application.	App owner

## Related resources

- [Amazon VPC documentation](#)
- [VPCs and subnets](#)
- [Working with a DB instance in a VPC](#)
- [Amazon RDS documentation](#)
- [Oracle on Amazon RDS](#)
- [Amazon RDS console](#)
- [How do I change the VPC for an Amazon RDS DB instance?](#)

# Migrate an Amazon Redshift cluster to an AWS Region in China

Created by Jing Yan (AWS)

<b>R Type:</b> Relocate	<b>Environment:</b> Production	<b>Technologies:</b> Databases; Migration
<b>Workload:</b> All other workloads	<b>AWS services:</b> Amazon Redshift	<b>Source:</b> AWS Redshift
<b>Target:</b> AWS Redshift		

## Summary

This pattern provides a step-by-step approach to migrate an Amazon Redshift cluster to an AWS Region in China from another AWS Region.

This pattern uses SQL commands to recreate all the database objects, and uses the UNLOAD command to move this data from Amazon Redshift to an Amazon Simple Storage Service (Amazon S3) bucket in the source Region. The data is then migrated to an S3 bucket in the AWS Region in China. The COPY command is used to load data from the S3 bucket and transfer it to the target Amazon Redshift cluster.

Amazon Redshift doesn't currently support cross-Region features such as snapshot copying to AWS Regions in China. This pattern provides a way to work around that limitation. You can also reverse the steps in this pattern to migrate data from an AWS Region in China to another AWS Region.

## Prerequisites and limitations

### Prerequisites

- Active AWS accounts in both a China Region and an AWS Region outside China
- Existing Amazon Redshift clusters in both a China Region and an AWS Region outside China

### Limitations

- This is an offline migration, which means the source Amazon Redshift cluster cannot perform write operations during the migration.

## Architecture

### Source technology stack

- Amazon Redshift cluster in an AWS Region outside China

### Target technology stack

- Amazon Redshift cluster in an AWS Region in China

### Target architecture

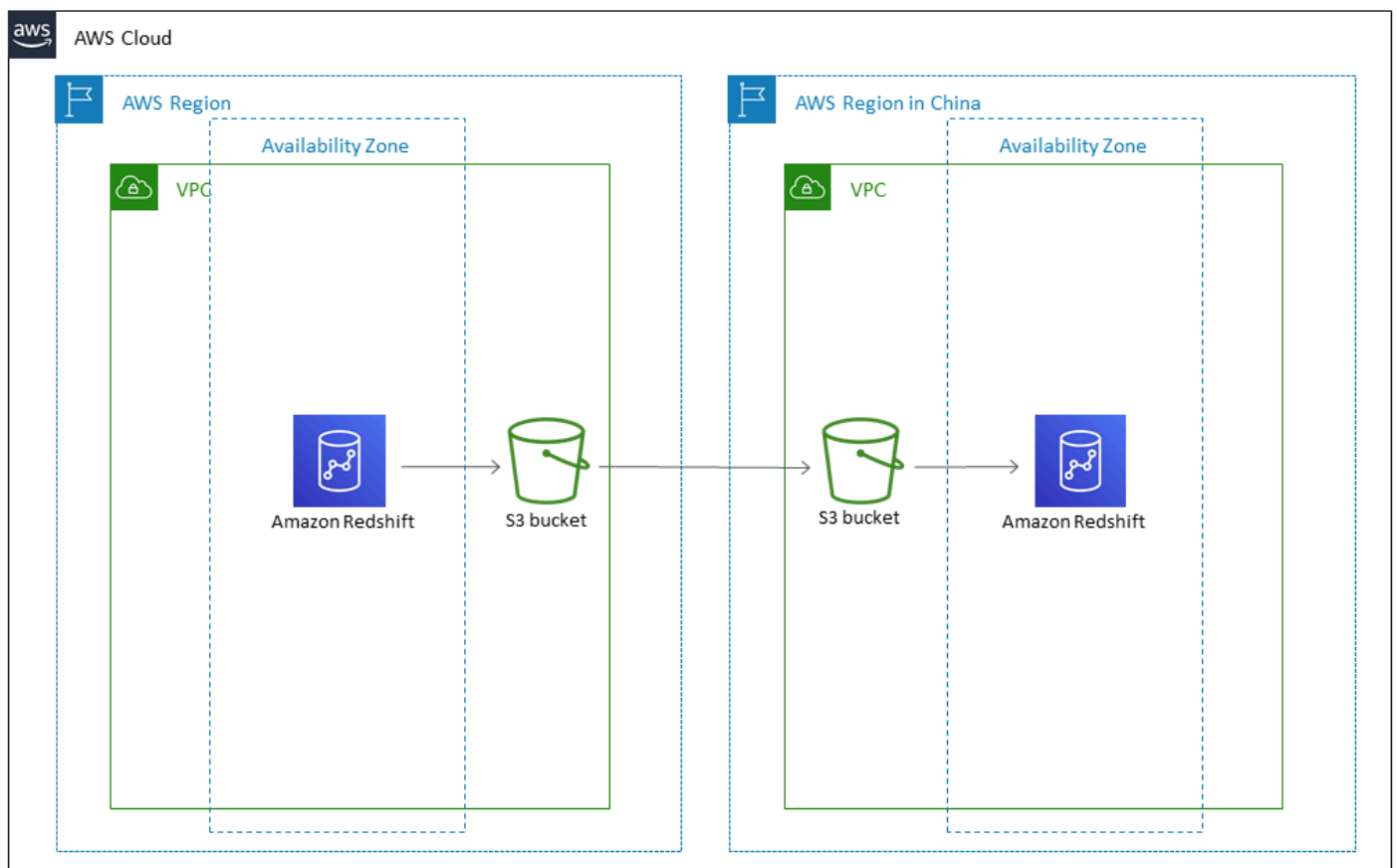

## Tools

## Tools

- [Amazon S3](#) – Amazon Simple Storage Service (Amazon S3) is an object storage service that offers scalability, data availability, security, and performance. You can use Amazon S3 to store data from Amazon Redshift, and you can copy data from an S3 bucket to Amazon Redshift.
- [Amazon Redshift](#) – Amazon Redshift is a fully managed, petabyte-scale data warehouse service in the cloud.
- [psql](#) – psql is a terminal-based front-end to PostgreSQL.

## Epics

### Prepare for migration in the source Region

Task	Description	Skills required
Launch and configure an EC2 instance in the source Region.	Sign in to the AWS Management Console and open the Amazon Elastic Compute Cloud (Amazon EC2) console. Your current Region is displayed in the navigation bar at the top of the screen. This Region cannot be an AWS Region in China. From the Amazon EC2 console dashboard, choose “Launch instance,” and create and configure an EC2 instance. Important: Ensure your EC2 security groups for inbound rules allow unrestricted access to TCP port 22 from your source machine. For instructions on how to launch and configure an EC2 instance, see the “Related resources” section.	DBA, Developer

Task	Description	Skills required
Install the psql tool.	Download and install PostgreSQL. Amazon Redshift does not provide the psql tool, it is installed with PostgreSQL. For more information about using psql and installing PostgreSQL tools, see the "Related resources" section.	DBA
Record the Amazon Redshift cluster details.	Open the Amazon Redshift console, and choose "Clusters" in the navigation pane. Then choose the Amazon Redshift cluster name from the list. On the "Properties" tab, in the "Database configurations" section, record the "Database name" and "Port." Open the "Connection details" section and record the "Endpoint," which is in the "endpoint :<port>/<databasename>" format. Important: Ensure your Amazon Redshift security groups for inbound rules allow unrestricted access to TCP port 5439 from your EC2 instance.	DBA

Task	Description	Skills required
Connect psql to the Amazon Redshift cluster.	At a command prompt, specify the connection information by running the “psql -h <endpoint> -U <userid> -d <databasename> -p <port>” command. At the psql password prompt, enter the password for the “<userid>” user. You are then connected to the Amazon Redshift cluster and can interactively enter commands.	DBA
Create an S3 bucket.	Open the Amazon S3 console, and create an S3 bucket to hold the files exported from Amazon Redshift. For instructions on how to create an S3 bucket, see the “Related resources” section.	DBA, AWS General

Task	Description	Skills required
Create an IAM policy that supports unloading data.	Open the AWS Identity and Access Management (IAM) console and choose "Policies ." Choose "Create policy," and choose the "JSON" tab. Copy and paste the IAM policy for unloading data from the "Additional information" section. Important: Replace "s3_bucket_name" with your S3 bucket's name. Choose "Review policy," and enter a name and description for the policy. Choose "Create policy."	DBA
Create an IAM role to allow UNLOAD operation for Amazon Redshift.	Open the IAM console and choose "Roles." Choose "Create role," and choose "AWS service" in "Select type of trusted entity." Choose "Redshift" for the service, choose "Redshift – Customizable," and then choose "Next." Choose the "Unload" policy you created earlier, and choose "Next." Enter a "Role name," and choose "Create role."	DBA



Task	Description	Skills required
Associate IAM role with the Amazon Redshift cluster.	Open the Amazon Redshift console, and choose "Manage IAM roles." Choose "Available roles" from the dropdown menu and choose the role you created earlier. Choose "Apply changes." When the "Status" for the IAM role on the "Manage IAM roles" shows as "In-sync", you can run the UNLOAD command.	DBA
Stop write operations to the Amazon Redshift cluster.	You must remember to stop all write operations to the source Amazon Redshift cluster until the migration is complete.	DBA

### Prepare for migration in the target Region

Task	Description	Skills required
Launch and configure an EC2 instance in the target Region.	Sign in to the AWS Management Console for a Region in China, either Beijing or Ningxia. From the Amazon EC2 console, choose "Launch instance," and create and configure an EC2 instance. Important: Make sure your Amazon EC2 security groups for inbound rules allow unrestricted access to TCP port 22 from your source	DBA

Task	Description	Skills required
	<p>machine. For further instructions on how to launch and configure an EC2 instance, see the “Related resources” section.</p>	
Record the Amazon Redshift cluster details.	<p>Open the Amazon Redshift console, and choose “Clusters” in the navigation pane. Then choose the Amazon Redshift cluster name from the list. On the “Properties” tab, in the “Database configurations” section, record the “Database name” and “Port.” Open the “Connection details” section and record the “Endpoint,” which is in the “endpoint :&lt;port&gt;/&lt;databasename&gt;” format. Important: Make sure your Amazon Redshift security groups for inbound rules allow unrestricted access to TCP port 5439 from your EC2 instance.</p>	DBA

Task	Description	Skills required
Connect psql to the Amazon Redshift cluster.	At a command prompt, specify the connection information by running the "psql -h <endpoint> -U <userid> -d <databasename> -p <port>" command. At the psql password prompt, enter the password for the "<userid>" user. You are then connected to the Amazon Redshift cluster and can interactively enter commands.	DBA
Create an S3 bucket.	Open the Amazon S3 console, and create an S3 bucket to hold the exported files from Amazon Redshift. For help with this and other stories, see the "Related resources" section.	DBA
Create an IAM policy that supports copying data.	Open the IAM console and choose "Policies." Choose "Create policy," and choose the "JSON" tab. Copy and paste the IAM policy for copying data from the "Additional information" section. Important: Replace "s3_bucket_name" with your S3 bucket's name. Choose "Review policy," enter a name and description for the policy. Choose "Create policy."	DBA

Task	Description	Skills required
Create an IAM role to allow COPY operation for Amazon Redshift.	Open the IAM console and choose "Roles." Choose "Create role," and choose "AWS service" in "Select type of trusted entity." Choose "Redshift" for the service, choose "Redshift – Customizable," and then choose "Next." Choose the "Copy" policy you created earlier, and choose "Next." Enter a "Role name," and choose "Create role."	DBA
Associate IAM role with the Amazon Redshift cluster.	Open the Amazon Redshift console, and choose "Manage IAM roles." Choose "Available roles" from the dropdown menu and choose the role you created earlier. Choose "Apply changes." When the "Status" for the IAM role on the "Manage IAM roles" shows as "In-sync", you can run the "COPY" command.	DBA

### Verify source data and object information before beginning the migration

Task	Description	Skills required
Verify the rows in the source Amazon Redshift tables.	Use the scripts in the "Additional information" section to verify and record the number of rows in the source Amazon Redshift	DBA

Task	Description	Skills required
	tables. Remember to split the data evenly for the UNLOAD and COPY scripts. This will improve the data unloading and loading efficiency, because the data quantity covered by each script will be balanced.	
Verify the number of database objects in the source Amazon Redshift cluster.	Use the scripts in the "Additional information" section to verify and record the number of databases, users, schemas, tables, views, and user-defined functions (UDFs) in your source Amazon Redshift cluster.	DBA
Verify SQL statement results before migration.	Some SQL statements for data validation should be sorted according to actual business and data situations. This is to verify the imported data to ensure it is consistent and displayed correctly.	DBA

### Migrate data and objects to the target Region

Task	Description	Skills required
Generate Amazon Redshift DDL scripts.	Generate Data Definition Language (DDL) scripts by using the links from the "SQL statements to query Amazon Redshift" section in	DBA

Task	Description	Skills required
	<p>the “Additional information” section. These DDL scripts should include the “create user,” “create schema,” “privileges on schema to user,” “create table/view,” “privileges on objects to user,” and “create function” queries.</p>	
<p>Create objects in the Amazon Redshift cluster for the target Region.</p>	<p>Run the DDL scripts by using the AWS Command Line Interface (AWS CLI) in the AWS Region in China. These scripts will create objects in the Amazon Redshift cluster for the target Region.</p>	<p>DBA</p>
<p>Unload source Amazon Redshift cluster data to the S3 bucket.</p>	<p>Run the UNLOAD command to unload data from the Amazon Redshift cluster in the source Region to the S3 bucket.</p>	<p>DBA, Developer</p>
<p>Transfer source Region S3 bucket data to target Region S3 bucket.</p>	<p>Transfer the data from your source Region S3 bucket to the target S3 bucket. Because the “\$ aws s3 sync” command cannot be used, make sure you use the process outlined in the “Transferring Amazon S3 data from AWS Regions to AWS Regions in China” article in the “Related resources” section.</p>	<p>Developer</p>

Task	Description	Skills required
Load data into the target Amazon Redshift cluster.	In the psql tool for your target Region, run the COPY command to load data from the S3 bucket to the target Amazon Redshift cluster.	DBA

### Verify the data in the source and target Regions after the migration

Task	Description	Skills required
Verify and compare the number of rows in the source and target tables.	Verify and compare the number of table rows in the source and target Regions to ensure all are migrated.	DBA
Verify and compare the number of source and target database objects.	Verify and compare all database objects in the source and target Regions to ensure all are migrated.	DBA
Verify and compare SQL script results in the source and target Regions.	Run the SQL scripts prepared before the migration. Verify and compare the data to ensure that the SQL results are correct.	DBA
Reset the passwords of all users in the target Amazon Redshift cluster.	After the migration is complete and all data is verified, you should reset all user passwords for the Amazon Redshift cluster in the AWS Region in China.	DBA

## Related resources

- [Transferring Amazon S3 data from AWS Regions to AWS Regions in China](#)
- [Creating an S3 bucket](#)
- [Resetting an Amazon Redshift user password](#)
- [psql documentation](#)

## Additional information

### *IAM policy for unloading data*

```
{
  "Version": "2012-10-17",
  "Statement": [
    {
      "Effect": "Allow",
      "Action": ["s3:ListBucket"],
      "Resource": ["arn:aws:s3:::s3_bucket_name"]
    },
    {
      "Effect": "Allow",
      "Action": ["s3:GetObject", "s3:DeleteObject"],
      "Resource": ["arn:aws:s3:::s3_bucket_name/*"]
    }
  ]
}
```

### *IAM policy for copying data*

```
{
  "Version": "2012-10-17",
  "Statement": [
    {
      "Effect": "Allow",
      "Action": ["s3:ListBucket"],
      "Resource": ["arn:aws:s3:::s3_bucket_name"]
    },
    {
      "Effect": "Allow",
      "Action": ["s3:GetObject"],
      "Resource": ["arn:aws:s3:::s3_bucket_name/*"]
    }
  ]
}
```



```
    }  
  ]  
}
```

## SQL statements to query Amazon Redshift

### ##Database

```
select * from pg_database where datdba>1;
```

### ##User

```
select * from pg_user where usesysid>1;
```

### ##Schema

```
SELECT n.nspname AS "Name",  
       pg_catalog.pg_get_userbyid(n.nspowner) AS "Owner"  
FROM pg_catalog.pg_namespace n  
WHERE n.nspname !~ '^pg_' AND n.nspname <> 'information_schema'  
ORDER BY 1;
```

### ##Table

```
select count(*) from pg_tables where schemaname not in  
('pg_catalog','information_schema');  
  
select schemaname,count(*) from pg_tables where schemaname not in  
('pg_catalog','information_schema') group by schemaname order by 1;
```

### ##View

```
SELECT  
       n.nspname AS schemaname,c.relname AS  
viewname,pg_catalog.pg_get_userbyid(c.relowner) as "Owner"  
FROM
```

```
pg_catalog.pg_class AS c

INNER JOIN

pg_catalog.pg_namespace AS n

ON c.relnamespace = n.oid

WHERE relkind = 'v' and n.nspname not in ('information_schema','pg_catalog');

##UDF

SELECT

n.nspname AS schemaname,

p.proname AS proname,

pg_catalog.pg_get_userbyid(p.proowner) as "Owner"

FROM pg_proc p

LEFT JOIN pg_namespace n on n.oid = p.pronamespace

WHERE p.proowner != 1;
```

### *SQL scripts to generate DDL statements*

- [Get\\_schema\\_priv\\_by\\_user script](#)
- [Generate\\_tbl\\_ddl script](#)
- [Generate\\_view\\_ddl](#)
- [Generate\\_user\\_grant\\_revoke\\_ddl](#)
- [Generate\\_udf\\_ddl](#)

# Migrate workloads to the VMware Cloud on AWS by using VMware HCX

Created by Deepak Kumar (AWS), Derek Cox (AWS), and Himanshu Gupta (AWS)

<b>Environment:</b> Production	<b>Source:</b> On-premises VMware workloads	<b>Target:</b> VMware Cloud on AWS
<b>R Type:</b> Relocate	<b>Workload:</b> All other workloads	<b>Technologies:</b> Migration; Hybrid cloud
<b>AWS services:</b> VMware Cloud on AWS; Amazon VPC		

## Summary

**Notice:** As of April 30, 2024, VMware Cloud on AWS is no longer resold by AWS or its channel partners. The service will continue to be available through Broadcom. We encourage you to reach out to your AWS representative for details.

This pattern explains how you can use VMware Hybrid Cloud Extension (HCX) to migrate workloads from your on-premises VMware environment to VMware Cloud on AWS without changing the underlying platform. VMware HCX streamlines migration, helps rebalance workloads, helps protect data, and optimizes disaster recovery processes for both on-premises data centers and cloud servers. The pattern discusses the steps for installing, configuring, upgrading, and uninstalling HCX.

HCX supports the following:

- Older versions of VMware vSphere – HCX helps you migrate virtual machines (VMs) from older versions of vSphere to VMware Cloud on AWS. The hosts are automatically updated and repaired to eliminate time-consuming updates in preparation for migration.
- Bulk migrations – You can use HCX with a WAN optimization service to migrate a large number of VMs in one step without downtime, to expand your on-premises networks to the cloud.
- Heterogeneous network environments – Your current network (such as vSphere, NSX, VXLAN, or NSX-T) determines the complexity of your migration. HCX extracts the fundamentals of

your network application and extends your current network to the cloud without requiring any complicated procedures.

- Slow network speeds – Migrations generally require connection speeds above 250 Mbps. HCX can migrate your workloads at much lower speeds, around 100 Mbps.

HCX supports three types of cloud migrations:

- **Hybridity (data center extension)** – Extending an existing, on-premises VMware software-defined data center (SDDC) to AWS to provide footprint expansion, on-demand capacity, a testing/development environment, and virtual desktops.
- **Cloud evacuation (data center-wide infrastructure refresh)** – Consolidating data centers and moving completely to the AWS Cloud (including handling data center co-location or end of lease).
- **Application-specific migration** – Moving individual applications to the AWS Cloud to meet specific business needs.

You can use HCX to migrate workloads bidirectionally between your on-premises environment and VMware Cloud on AWS. HCX offers multiple ways to migrate your workloads between source and target locations:

- **HCX cold migration** migrates VMs that are offline. This method is suitable for VMs that are powered off because it requires significant downtime.
- **HCX vMotion** uses the VMware vMotion protocol to move VMs. HCX vMotion offers zero downtime migration but can migrate only one VM at a time.
- **HCX Bulk Migration** uses VMware vSphere replication protocols to move VMs to the destination. You can migrate multiple VMs in parallel and schedule a switchover. The downtime is equivalent to a server reboot, and switchover for all VMs happen in parallel.
- **HCX Replication Assisted vMotion (RAV)** is a combination of HCX bulk migration and HCX vMotion. It provides parallel migrations, scheduling, and zero downtime.
- **HCX OS Assisted Migration** helps you migrate multiple VMs in bulk when you're using multiple hypervisors and non-vSphere VMs on premises. HCX OS Assisted Migration is free when you use it to migrate from on premises to VMware Cloud on AWS, but requires additional licenses when you want to migrate between two on-premises environments or from on premises to other cloud providers.

## Prerequisites and limitations

### Prerequisites

- A VMware account for access to the VMware console at [vmware.com](https://www.vmware.com).
- The following firewall ports are required for HCX.

Source	Destination	Port
HCX Manager and appliances IP on premises	HCX Manager and appliances IP on VMware Cloud on AWS	UDP 500, UDP 4500, and ICMP
HCX Manager and appliances IP on premises	connect.hcx.vmware.com   hybridity-depot.vmware.com	TCP 443
HCX Manager and appliances IP on premises	HCX cloud URL	TCP 443

If the on-premises network has internal firewalls, you will have to allow a few more ports locally within the data center. For a full list of port requirements for HCX, see the [VMware HCX documentation](#).

- To configure HCX, you need the Domain Name System (DNS) IP, the vCenter fully qualified domain name (FQDN), the NTP server FQDN, the single sign-on (SSO) user, and similar information. Gather these details in advance to avoid any delays in the deployment.

### Limitations

You can use the Network Extension appliance to extend a maximum of eight networks between the on-premises environment and VMware Cloud on AWS. For a full list of HCX service limits, see the [VMware HCX documentation](#).

## Architecture

### Source technology stack

- On-premises VMware workloads

## Target technology stack

- VMware Cloud on AWS

## Tools

### Tools

- [VMware Cloud on AWS](#) is a service jointly designed by AWS and VMware to help you migrate and extend your on-premises VMware vSphere-based environments to the AWS Cloud.
- [VMware Hybrid Cloud Extension \(HCX\)](#) is a VMware utility for migrating workloads from your on-premises VMware environment to VMware Cloud on AWS without changing the underlying platform.

## Epics

### Deploy HCX

Task	Description	Skills required
Enable HCX service in VMware Cloud on AWS	<ol style="list-style-type: none"> <li>1. Log in to the <a href="#">VMware Cloud on AWS console</a>.</li> <li>2. Navigate to your SDCC and choose <b>View details</b>.</li> <li>3. Choose the <b>Add Ons</b> tab.</li> <li>4. Choose <b>Open HCX</b>.</li> <li>5. Choose <b>Deploy HCX</b> and confirm. HCX deployment will begin.</li> </ol>	Cloud administrator, Systems administrator
Generate the HCX activation key.	<ol style="list-style-type: none"> <li>1. On the <a href="#">VMware Cloud on AWS console</a>.</li> <li>2. Navigate to your SDCC and choose <b>View details</b>.</li> <li>3. Choose the <b>Add Ons</b> tab.</li> </ol>	Cloud administrator, Systems administrator

Task	Description	Skills required
	<ol style="list-style-type: none"><li data-bbox="591 212 971 342">4. Choose <b>Open HCX</b>, and then choose <b>Activation keys</b>.</li><li data-bbox="591 363 1000 447">5. Choose <b>Create activation key</b> and copy the key.</li></ol>	

Task	Description	Skills required
Add firewall rules for HCX on cloud SDDC.	<p>After the HCX Manager is deployed, you need to configure firewall rules to enable communications between the on-premises environment and the SDDC. You need to create two firewall rules: one for inbound and the other for outbound communications.</p> <ol style="list-style-type: none"><li>1. On the <a href="#">VMware Cloud on AWS console</a>, select your SDDC and navigate to <b>Networking &amp; Security</b>.</li><li>2. Choose <b>Gateway Firewall</b>, and then choose the <b>Management Gateway</b> tab.</li><li>3. Choose <b>Add rule</b> and create an outbound rule:<ol style="list-style-type: none"><li>a. Provide the rule name.</li><li>b. Edit the source and select <b>HCX</b>.</li><li>c. Edit the destination and provide the on-premises IP and subnet where HCX can be accessed.</li><li>d. For <b>Services</b>, choose <b>Any</b>.</li><li>e. For <b>Action</b>, choose <b>Allow</b>.</li><li>f. Choose <b>Publish</b>.</li></ol></li></ol>	Cloud administrator, Systems administrator



Task	Description	Skills required
	<ol style="list-style-type: none"><li>4. Choose <b>Add rule</b> and create an inbound rule:<ol style="list-style-type: none"><li>a. Provide the rule name.</li><li>b. Edit the source and provide the on-premises IP and subnet where HCX can be accessed.</li><li>c. Edit the destination and select <b>HCX</b>.</li><li>d. For <b>Services</b>, choose SSH, HTTPS, TCP (9443), and ICMP.</li><li>e. For <b>Action</b>, choose <b>Allow</b>.</li><li>f. Choose <b>Publish</b>.</li></ol></li></ol>	

Task	Description	Skills required
Install HCX Manager on premises.	<ol style="list-style-type: none"><li data-bbox="591 226 1027 352">1. Log in to the cloud vCenter and navigate to HCX from the menu.</li><li data-bbox="591 380 1027 506">2. On the HCX dashboard, choose <b>Administration, System Updates</b>.</li><li data-bbox="591 533 1027 701">3. Request the download link for VMware HCX Connector , and download the on-premises OVA file.</li><li data-bbox="591 728 1027 896">4. Log in to your on-premises vCenter and deploy the OVF template by using the downloaded OVA file.</li><li data-bbox="591 924 1027 1134">5. During template deployment, provide static IP, NTP, DNS, DNS search list, and other details when prompted.</li><li data-bbox="591 1161 1027 1245">6. Verify all details to finish HCX Manager deployment.</li></ol>	Cloud administrator, Systems administrator

Task	Description	Skills required
Configure HCX Manager on premises.	<ol style="list-style-type: none"><li data-bbox="592 226 1027 405">1. Open HCX Manager in a browser: <code>https://&lt;HCX_Manager_IP&gt;:9433</code> .</li><li data-bbox="592 430 1027 609">2. Log in by using the username and password provided during the deployment.</li><li data-bbox="592 634 1027 812">3. Enter the activation key you created previously, and choose <b>Activate</b> to activate your HCX instance.</li><li data-bbox="592 837 1027 911">4. Choose <b>Confirm</b> to go to the next step.</li><li data-bbox="592 936 1027 1062">5. Select the location of your on-premises data center, and then choose <b>Continue</b>.</li><li data-bbox="592 1087 1027 1266">6. For <b>System Name</b>, enter the hostname, and then choose <b>Continue</b> to complete the activation.</li><li data-bbox="592 1291 1027 1417">7. Enter the information to configure your vCenter connection.</li><li data-bbox="592 1442 1027 1516">8. Enter the information to configure SSO/PSC details.</li><li data-bbox="592 1541 1027 1614">9. Choose <b>Restart</b> for your changes to take effect.</li></ol>	Cloud administrator, Systems administrator

Task	Description	Skills required
Configure site pairing.	<p>After you have configured HCX in the cloud and on premises, follow these steps to configure site pairing between them.</p> <ol style="list-style-type: none"><li>1. Log in to your on-premises vCenter, and navigate to the HCX dashboard.</li><li>2. In the left navigation pane, choose <b>Site pairing</b>, and then choose <b>Connect to Remote Site</b>.</li><li>3. In the <b>Connect to Remote Site</b> dialog box, add the HCX cloud URL and credentials, and then choose <b>Connect</b>.</li></ol> <p>When site pairing is complete, the site pairing dashboard shows the on-premises and cloud SDDC connected.</p>	Cloud administrator, Systems administrator

Task	Description	Skills required
Create a network profile.	<p>A network profile is an abstraction of the Layer 3 components of a network. This profile is a prerequisite for creating a compute profile.</p> <ol style="list-style-type: none"><li>1. Log in to your cloud vCenter, and navigate to the HCX dashboard.</li><li>2. Choose <b>Interconnect</b>, choose the <b>Network Profiles</b> tab, and then choose <b>Create network profile</b>.</li><li>3. Configure the network profile:<ol style="list-style-type: none"><li>a. Choose the vCenter server.</li><li>b. Choose the network.</li><li>c. Add a name for the profile.</li><li>d. Provide the IP pool, prefix length, gateway, DND, and MTU.</li><li>e. Choose <b>Create</b>.</li></ol></li><li>4. Follow the same process to create a network profile on premises.</li></ol>	Cloud administrator, Systems administrator

Task	Description	Skills required
Create a compute profile.	<p>The compute profile consists of network, storage and compute details for HCX. HCX uses these settings when it creates HCX appliances during the creation of the service mesh.</p> <ol style="list-style-type: none"><li>1. Log in to your on-premises vCenter, and navigate to the HCX dashboard.</li><li>2. Choose <b>Interconnect</b>, choose the <b>Compute Profiles</b> tab, and then choose <b>Create compute profile</b>.</li><li>3. Specify a name for the compute profile.</li><li>4. Select the HCX services that you want to enable, and then choose <b>Continue</b>.</li><li>5. Select the service resources . If there are multiple clusters, select each cluster that you want HCX services to be activated for, and then choose <b>Continue</b>.</li><li>6. Select compute and storage resources for deploying HCX appliances, and then choose <b>Continue</b>.</li><li>7. Select a management network profile that can be used to reach the</li></ol>	Cloud administrator, Systems administrator

Task	Description	Skills required
	<p>management interface of vCenter and ESXi hosts, and then choose <b>Continue</b>.</p> <p>8. Select an uplink network profile that can be used to reach interconnect appliances on the remote site and that remote site appliances can use to reach the local interconnect appliances, and then choose <b>Continue</b>.</p> <p>9. Select the vMotion network profile, and then choose <b>Continue</b>.</p> <p>10 Select the vSphere replication network profile, and then choose <b>Continue</b>.</p> <p>11 Select the appropriate distributed switch for network extensions, and then choose <b>Continue</b>.</p> <p>12 Review all the ports that need to be opened in WAN and LAN connections, and then choose <b>Continue</b>.</p> <p>13 To create the compute profile, choose <b>Finish</b>.</p> <p>14 Follow the same steps to create a compute profile on the cloud site.</p>	

Task	Description	Skills required
Create a service mesh.	<p>The service mesh provides HCX service configuration for both the on-premises site and the cloud site. Creating a service mesh initiates the deployment of HCX interconnect virtual appliances on both sites. The interconnect service must be created on the source site.</p> <ol style="list-style-type: none"><li>1. Log in to your on-premises vCenter, and navigate to the HCX dashboard.</li><li>2. Choose <b>Interconnect</b>, choose the <b>Service Mesh</b> tab, and then choose <b>Create service mesh</b>.</li><li>3. Select the source and destination site the service mesh will be created between, and then choose <b>Continue</b>.</li><li>4. Select the compute profile for the source and the destination sites that you created earlier, and then choose <b>Continue</b>.</li><li>5. Select the HCX service that you want to enable, and then choose <b>Continue</b>.</li><li>6. Select the uplink profile for both source and target</li></ol>	Cloud administrator, Systems administrator



Task	Description	Skills required
	<p>sites, and then choose <b>Continue</b>.</p> <p>7. Review the resources and networks, and then choose <b>Continue</b>.</p> <p>8. Provide a name for the service mesh, and then choose <b>Finish</b>.</p> <p>Service mesh deployment will start. You can follow the progress in the <b>Tasks</b> tab for the service mesh. When deployment is complete, the status of all HCX services that you enabled for the service mesh is displayed.</p>	

## Extend networking by using HCX

Task	Description	Skills required
Create a network extension.	<p>You can use HCX network extension capabilities to create a L2 network extension at the cloud SDDC HCX site and bridge the remote and source networks.</p> <p>This allows you to migrate servers from on-premises to VMware Cloud on AWS while retaining the same IP addresses.</p>	Cloud administrator, Systems administrator

Task	Description	Skills required
	<ol style="list-style-type: none"> <li>1. Log in to your on-premises vCenter, and navigate to the HCX dashboard.</li> <li>2. Choose <b>Services, Network Extension</b>.</li> <li>3. Choose <b>Extend networks</b> or <b>Create a network extension</b>.</li> <li>4. Select the appropriate service mesh, distributed port group, or NSX logical switch.</li> <li>5. Provide the gateway IP address and then choose <b>Submit</b>.</li> </ol> <p>When the network extension is complete, the system shows <b>Extension complete</b>.</p>	

## Configure a replication job by using HCX

Task	Description	Skills required
Configure replication.	<p>To replicate VMs by using HCX:</p> <ol style="list-style-type: none"> <li>1. Log in to your on-premises vCenter, and navigate to the HCX dashboard.</li> <li>2. Choose <b>Migration</b>, and then choose the <b>Migrate</b> tab.</li> </ol>	Cloud administrator, Systems administrator

Task	Description	Skills required
	<ol style="list-style-type: none"> <li>3. Provide a mobility group name, select the VM that you want to migrate, and then choose <b>Add</b>.</li> <li>4. Choose the target compute container, storage folder, migration type (cold, bulk, RAV, vMotion), and switchover schedule.</li> <li>5. Choose <b>Validate</b>, wait for validation to complete, and then choose <b>Go</b> to start the replication.</li> </ol>	

## Upgrade HCX

Task	Description	Skills required
Review recommendations and steps.	A large migration project can last from six to eight months, sometimes longer, and VMware periodically publishes HCX updates that consist of software fixes, security updates, and bug fixes. We recommend that you keep HCX and your appliances up to date to eliminate any security vulnerabilities and to take advantage of new functionality.	Cloud administrator, Systems administrator

Task	Description	Skills required
	<p><b>Note:</b> If your current HCX version is three versions behind the latest release or older, you cannot upgrade HCX and will have to redeploy it.</p> <p>An HCX upgrade consists of three steps:</p> <ol style="list-style-type: none"><li>1. Back up HCX Manager on premises and in the cloud.</li><li>2. Upgrade HCX Manager on premises and in the cloud.</li><li>3. Upgrade service mesh appliances on on premises and in the cloud.</li></ol> <p>The following stories discuss these steps in more detail.</p>	

Task	Description	Skills required
Back up HCX Cloud Manager.	<p>HCX Cloud Manager for VMware Cloud on AWS is managed by VMware, so you cannot take snapshots. To back up HCX Cloud Manager, you must download a backup from the HCX console and use this backup to restore the HCX configuration in case the upgrade fails or you have to roll back to a previous stage.</p> <ol style="list-style-type: none"><li>1. Log in to HCX Cloud Manager at <code>https://&lt;HCX_cloudmanager_ip_or_fqdn&gt;:9433</code>.</li><li>2. Navigate to <b>Administration, Troubleshooting, Backup &amp; Restore</b>.</li><li>3. In the <b>Backup</b> section, choose <b>Generate</b> to create a backup file.</li><li>4. Choose <b>Download</b> to save the backup file.</li></ol> <p>HCX service appliances such as HCX-IX, HCX-NE, and HCX-WO do not require individual backups.</p>	Cloud administrator, Systems administrator

Task	Description	Skills required
<p>Back up HCX Manager on premises.</p>	<p>You can back up HCX Manager on-premises in two ways: by taking a VM snapshot or by backing up the configuration file.</p> <p>To take a VM snapshot:</p> <ol style="list-style-type: none"> <li>1. Log in to your on-premises vCenter.</li> <li>2. Go to <b>VM and templates</b> , and navigate to HCX manager VM.</li> <li>3. Choose <b>Actions, Snapshots</b> , <b>Take Snapshot</b>.</li> </ol> <p>To back up the configuration file:</p> <ol style="list-style-type: none"> <li>1. Log in to HCX Cloud Manager at <code>https://&lt;HCX_cloudmanager_ip_or_fqdn&gt;:9433</code> .</li> <li>2. Navigate to <b>Administration, Troubleshooting, Backup &amp; Restore</b>.</li> <li>3. In the <b>Backup</b> section, choose <b>Generate</b> to create a backup file.</li> <li>4. Choose <b>Download</b> to save the backup file.</li> </ol> <p>HCX service appliances such as HCX-IX, HCX-NE, and HCX-</p>	<p>Cloud administrator, Systems administrator</p>

Task	Description	Skills required
	WO do not require individual backups.	

Task	Description	Skills required
Upgrade HCX Manager on premises and in the cloud.	<p>You must upgrade HCX Manager on-premises first, and then upgrade HCX Cloud Manager.</p> <p>To upgrade HCX Manager on premises:</p> <ol style="list-style-type: none"><li>1. Log in to vCenter and navigate to the HCX dashboard.</li><li>2. Choose <b>System, Administration</b>.</li><li>3. On the <b>Administration</b> page, choose the <b>System Updates</b> tab. The <b>Available Service Update Versions</b> column shows pending updates.</li><li>4. Choose <b>Select Service Update, Download</b> to download the update for a later upgrade, or choose <b>Download &amp; Upgrade</b> to download and deploy the update immediately. If you selected <b>Download</b>, choose <b>Upgrade</b> and confirm to initiate the upgrade when you're ready.</li><li>5. When the upgrade is complete:<ul style="list-style-type: none"><li>• On the HCX manager <b>Administration</b> page,</li></ul></li></ol>	Cloud administrator, Systems administrator



Task	Description	Skills required
	<p>validate that the latest HCX version is displayed.</p> <ul style="list-style-type: none"><li>• On the HCX dashboard , check to confirm that site pairing is <b>Up</b>.</li><li>• Choose <b>Infrastructure, Service Mesh</b>, and confirm that all HCX services are healthy.</li></ul> <p>Follow the same steps to upgrade HCX Cloud Manager.</p>	

Task	Description	Skills required
Upgrade service mesh appliances.	<p>The service mesh is updated independently of HCX Manager at the source site. Service mesh appliances on the target site are updated automatically.</p> <p>To upgrade service mesh appliances at the source site:</p> <ol style="list-style-type: none"><li>1. Log in to vCenter, and navigate to the HCX dashboard.</li><li>2. Choose <b>Infrastructure</b>, and then choose the <b>Service mesh</b> tab.</li><li>3. If you see the banner "New version for service mesh appliances is available. Click on Update Appliances to upgrade to latest," choose <b>Update appliances</b>.</li><li>4. In the dialog box that displays appliances, choose one or more appliances, and then choose <b>OK</b> to start the upgrade process. (We recommend that you update all service mesh appliances.)</li><li>5. Choose <b>View tasks</b> for each service mesh to monitor the upgrade.</li></ol>	Cloud administrator, Systems administrator

Task	Description	Skills required
	<p>6. When the upgrade is complete, a banner appears for each appliance and service to confirm successful completion.</p> <p>7. Validate the tunnel status after the upgrade:</p> <ul style="list-style-type: none"> <li>• Choose <b>Infrastructure, Service mesh, View appliance</b>.</li> <li>• The tunnel status column should show <b>Up</b> and the screen shouldn't indicate any other available versions for the appliance.</li> </ul>	

## Remove HCX network extensions

Task	Description	Skills required
Unextend network.	<p>An earlier step explained how to use HCX network extension capabilities to create L2 network extensions and to keep existing IPs during migration from on premises to VMware cloud on AWS. When all the VMs from a particular VLAN have been moved to VMware Cloud on AWS, you must unextend the network between the on-premises site and the cloud</p>	Cloud administrator, Systems administrator

Task	Description	Skills required
	<p>SDDC, and make the network routable in the SDDC.</p> <p>We recommend that you remove the extended network as soon as all VMs are migrated from on premises to VMware Cloud on AWS to avoid latency.</p> <ol style="list-style-type: none"><li>1. Log in to your on-premises vCenter, and navigate to the HCX dashboard.</li><li>2. On the HCX dashboard, choose <b>Services, Network Extension</b>.</li><li>3. Select the network you want to unextend, and then choose <b>Unextend network</b>.</li><li>4. Select <b>Connect cloud network to cloud edge gateway after unextending</b>. This activates the network on the cloud side.</li></ol>	

Task	Description	Skills required
Route moved network in cloud SDDC.	<ol style="list-style-type: none"> <li>1. Log in to the <a href="#">VMC portal</a>.</li> <li>2. Navigate to the SDCC, and then choose <b>View details</b>.</li> <li>3. Choose the <b>Networking &amp; Security</b> tab.</li> <li>4. On the <b>Networking &amp; Security</b> page: <ul style="list-style-type: none"> <li>• Choose <b>Network, Segments</b>, and confirm that the recently unextended subnet is shown as <b>routable</b>.</li> <li>• Choose <b>Inventory, Groups</b>, and add that subnet to a group.</li> <li>• Choose <b>Security, Distributed firewall</b>, and confirm that the group is part of the intended firewall rule.</li> </ul> </li> </ol>	Cloud administrator, Systems administrator

## Uninstall HCX

Task	Description	Skills required
Check prerequisites.	In the case of a data center exit, we recommend that you uninstall HCX and remove its components at the end of your migration project. However, if you still retain an on-premises footprint,	Cloud administrator, Systems administrator

Task	Description	Skills required
	<p>you might want to keep HCX running.</p> <p>Before you uninstall HCX, make sure that:</p> <ul style="list-style-type: none"><li>• There are no active migrations.</li><li>• All network extensions have been removed.</li></ul>	

Task	Description	Skills required
Uninstall HCX on premises.	<ol style="list-style-type: none"><li>1. Log in to your on-premises vCenter and navigate to the HCX console.</li><li>2. Choose <b>Services, Migration</b>, and confirm that you have no active migrations.</li><li>3. Choose <b>Services, Network extension</b>, and confirm that there is no extended network.</li><li>4. Choose <b>Infrastructure, Site pairing, Service mesh</b>.</li><li>5. Identify the service mesh, and then choose <b>Delete</b>.</li><li>6. In the confirmation prompt, choose <b>Delete</b> again. The banner "Removing Service Mesh" appears on the service mesh screen.</li><li>7. Repeat steps 5-6 for any other service meshes you have.</li><li>8. To remove site pairing, choose <b>Infrastructure, Site pairing</b>, and then disconnect all paired sites.</li><li>9. Remove the HCX manager appliance:<ol style="list-style-type: none"><li>a. Log in to your on-premises vCenter and navigate</li></ol></li></ol>	Cloud administrator, Systems administrator

Task	Description	Skills required
	<p>to the HCX Manager appliance.</p> <p>b. Choose <b>Actions, Power, Power Off</b>.</p> <p>c. Choose <b>Actions, Delete from Disk</b>.</p>	



Task	Description	Skills required
Deregister HCX plugin from on-premises vCenter server.	<ol style="list-style-type: none"><li>1. Log in to the vCenter MOB UI at <code>https://&lt;vc_fqdn&gt;/mob</code> .</li><li>2. In the <b>Properties</b> section, choose the content in the <b>Value</b> column.</li><li>3. On the content page, choose <b>ExtensionManager</b> to see all registered plugins.</li><li>4. Note the extensions that start with <code>com.vmware.hybridity</code> , <code>com.vmware.hcsp.alarm</code> , and <code>com.vmware.vca.marketing.ngc.ui</code> .</li><li>5. Remove the extensions:<ul style="list-style-type: none"><li>• In the <b>Methods</b> section, choose <b>UnregisterExtension</b>.</li><li>• Enter the extension key noted in step 4, and then choose <b>Invoke Method</b> to remove the extension.</li></ul></li></ol> <p>When all extensions have been removed, the HCX plugin will disappear from the vSphere Web Client.</p>	Cloud administrator, Systems administrator

Task	Description	Skills required
Uninstall HCX in the cloud.	<p>To remove the HCX service mesh and site pairing in the cloud, repeat the steps described earlier in <i>Uninstall HCX on premises</i>. In VMware Cloud on AWS, HCX Manager is managed by VMware. You cannot delete it from vCenter, but you can undeploy it from the VMC management interface.</p> <p>To undeploy HCX Manager:</p> <ol style="list-style-type: none"> <li>1. Log in to the <a href="#">VMC management interface</a>.</li> <li>2. Choose your organization and SDDC.</li> <li>3. Choose <b>Add Ons</b> to display all SDDCs that have HCX deployed.</li> <li>4. Choose <b>Undeploy HCX</b>.</li> </ol>	Cloud administrator, Systems administrator

## Troubleshooting

Issue	Solution
You're unable to select the servers to migrate when you configure HCX bulk migration.	<p><b>Cause:</b> Migration for these servers were canceled, but the HCX database wasn't updated during the cleanup. HCX views database migration as still being in progress, so it has locked the status at "Switchover in-progress."</p>

Issue	Solution
	<p><b>Solution:</b> Reach out to the VMware support team to clean up the HCX database.</p>
<p>Switchover fails but works with the <b>Force Power Off</b> option.</p>	<p><b>Cause:</b> The version of VMware Tools didn't meet the prerequisites for HCX bulk migration, so HCX could not shut down the source VM.</p> <p><b>Solution:</b> Update the VMware tool to the recommended version for your migration type.</p>
<p>HCX site pairing appliance upgrade fails with the error "Operation not allowed for ongoing bulk migration" while migration is in progress.</p>	<p><b>Cause:</b> The HCX database didn't update after the switchover.</p> <p><b>Solution:</b> Make sure there are no ongoing migrations. Choose <b>Force upgrade</b> when you upgrade the site pairing appliance.</p>
<p>Cutover fails with error "Low resource availability."</p>	<p><b>Cause:</b> Low storage on the host VM.</p> <p><b>Solution:</b> Check storage and compute resources before migration.</p>

## Related resources

### References

- [VMware Cloud on AWS Features](#)
- [VMware Cloud on AWS overview and operating model](#) (AWS Prescriptive Guidance)
- [Migrate VMware SDDC to VMware Cloud on AWS using VMware HCX](#) (AWS Prescriptive Guidance)
- [VMware HCX in the VMware Cloud on AWS](#) (VMware documentation)
- [HCX HCX release notes](#) (VMware documentation)
- [SDDC Deployment and Best Practices Guide on AWS](#) (AWS whitepaper)

### Tools

- [VMware Cloud on AWS Automation using PowerCLI](#) (VMware Cloud Tech Zone)

## Partners

- [VMware Cloud on AWS Partner Initiative](#)

## Videos

- [VMware Cloud on AWS](#) (YouTube video)

# Transport PostgreSQL databases between two Amazon RDS DB instances using `pg_transport`

Created by Raunak Rishabh (AWS) and Jitender Kumar (AWS)

<b>Environment:</b> PoC or pilot	<b>Source:</b> Databases: Relational	<b>Target:</b> Amazon RDS for PostgreSQL
<b>R Type:</b> Relocate	<b>Workload:</b> Open-source	<b>Technologies:</b> Migration; Databases
<b>AWS services:</b> Amazon RDS		

## Summary

This pattern describes the steps for migrating extremely large databases between two Amazon Relational Database Service (Amazon RDS) for PostgreSQL DB instances by using the `pg_transport` extension. This extension provides a physical transport mechanism to move each database. By streaming the database files with minimal processing, it provides an extremely fast method for migrating large databases between DB instances with minimal downtime. This extension uses a pull model where the target DB instance imports the database from the source DB instance.

## Prerequisites and limitations

### Prerequisites

- Both DB instances must run the same major version of PostgreSQL.
- The database must not exist on the target. Otherwise, the transport fails.
- No extension other than `pg_transport` must be enabled in the source database.
- All source database objects must be in the default `pg_default` tablespace.
- The security group of the source DB instance should allow traffic from the target DB instance.
- Install a PostgreSQL client like [psql](#) or [PgAdmin](#) to work with the Amazon RDS PostgreSQL DB instance. You can install the client either in your local system or use an Amazon Elastic Compute Cloud (Amazon EC2) instance. In this pattern, we use `psql` on an EC2 instance.

### Limitations

- You can't transport databases between different major versions of Amazon RDS for PostgreSQL.
- The access privileges and ownership from the source database are not transferred to the target database.
- You can't transport databases on read replicas or on parent instances of read replicas.
- You can't use **reg** data types in any database tables that you plan to transport with this method.
- You can run up to 32 total transports (including both imports and exports) at the same time on a DB instance.
- You cannot rename or include/exclude tables. Everything is migrated as is.

### Caution

- Make backups before removing the extension, because removing the extension also removes dependent objects and some data that's critical to the operation of the database.
- Consider the instance class and processes running on other databases on the source instance when you determine the number of workers and `work_mem` values for **pg\_transport**.
- When the transport starts, all connections on the source database are ended and the database is put into read-only mode.

**Note:** When the transport is running on one database, it doesn't affect other databases on the same server.

### Product versions

- Amazon RDS for PostgreSQL 10.10 and later, and Amazon RDS for PostgreSQL 11.5 and later. For the latest version information, see [Transporting PostgreSQL Databases Between DB Instances](#) in the Amazon RDS documentation.

## Architecture

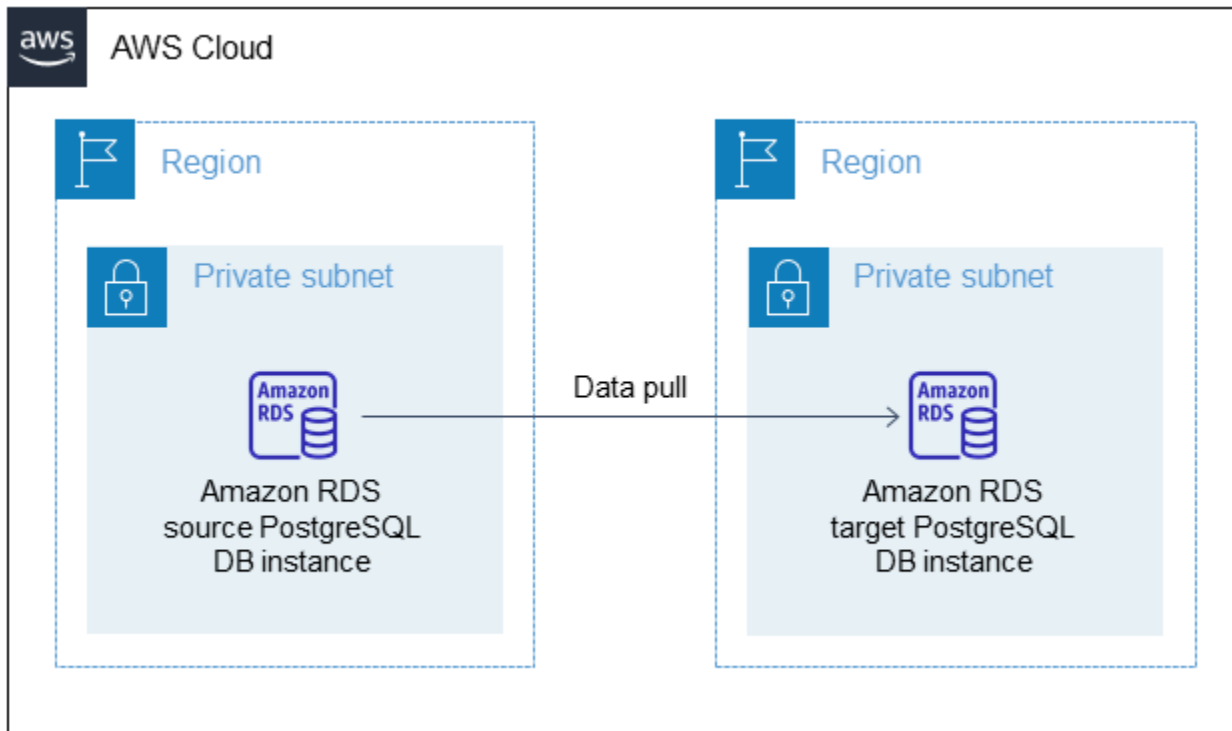

## Tools

- **pg\_transport** provides a physical transport mechanism to move each database. By streaming the database files with minimal processing, physical transport moves data much faster than traditional dump and load processes and requires minimal downtime. PostgreSQL transportable databases use a pull model where the destination DB instance imports the database from the source DB instance. You install this extension on your DB instances when you prepare the source and target environments, as explained in this pattern.
- **psql** enables you to connect to, and work with, your PostgreSQL DB instances. To install **psql** on your system, see the [PostgreSQL Downloads](#) page.

## Epics

### Create the target parameter group

Task	Description	Skills required
Create a parameter group for the target system.	Specify a group name that identifies it as a target parameter group; for	DBA

Task	Description	Skills required
	example, <code>pgtarget-param-group</code> . For instructions, see the <a href="#">Amazon RDS documentation</a> .	



Task	Description	Skills required
Modify the parameters for the parameter group.	<p>Set the following parameters:</p> <ol style="list-style-type: none"><li>1. Add <code>pg_transport</code> to the <code>shared_preload_libraries</code> parameter.</li></ol> <div data-bbox="630 520 1029 722" style="border: 1px solid #ccc; border-radius: 10px; padding: 10px; margin: 10px 0;"><pre>shared_preload_libraries = pg_stat_statements, pg_transport</pre></div> <ol style="list-style-type: none"><li>2. Set the <code>pg_transport.num_workers</code> parameter. Choose the number of workers you want to run the transport with. The value you set determines the number of <code>transport.send_file</code> workers that will be created in the source.</li><li>3. Increase the the value of <code>max_worker_processes</code> to more than three times the value of <code>pg_transport.num_workers</code> . For example, if you set the value of <code>pg_transport.num_workers</code> to 4, the <code>max_worker_processes</code> value should be at least 13. If this fails,</li></ol>	DBA

Task	Description	Skills required
	<p><b>pg_transport</b> recommends a minimum value.</p> <p>4. Set <code>pg_transport.timing</code> to 1. This setting enables the reporting of timing information during the transport.</p> <p>5. Set the <code>pg_transport.work_mem</code> parameter. This parameter specifies the maximum memory to allocate to each worker. The default value is 128 MB.</p> <p>For more information about these parameters, see the <a href="#">Amazon RDS documentation</a>.</p>	

## Create the source parameter group

Task	Description	Skills required
Create a parameter group for the source system.	Specify a group name that identifies it as a source parameter group; for example, <code>pgsource-param-group</code> . For instructions, see the <a href="#">Amazon RDS documentation</a> .	DBA
Modify the parameters for the parameter group.	Set the following parameters:	DBA

Task	Description	Skills required
	<ol style="list-style-type: none"><li data-bbox="591 212 1027 394">1. Add <code>pg_transport</code> to the <code>shared_preload_libraries</code> parameter. <div data-bbox="634 428 1027 625" style="border: 1px solid #ccc; border-radius: 10px; padding: 10px; margin: 10px 0;"><pre>shared_preload_libraries = pg_stat_statements, pg_transport</pre></div></li><li data-bbox="591 642 1027 1255">2. Set the <code>pg_transport.num_workers</code> parameter. The value of this parameter defined in the target determines the number of <code>transport.send_file</code> workers to be used. If you have an import running on this instance, increase this value, but consider the number of workers that are already running.</li><li data-bbox="591 1272 1027 1833">3. Increase the the value of <code>max_worker_processes</code> to more than three times the value of <code>pg_transport.num_workers</code> on the target. For example, if you set the value of <code>pg_transport.num_workers</code> to 4 on the target, the <code>max_worker_processes</code> value on the source</li></ol>	

Task	Description	Skills required
	<p>should be at least 13. If this fails, <code>pg_transport</code> recommends a minimum value.</p> <p>4. Set the <code>pg_transport.work_mem</code> parameter. This parameter specifies the maximum memory to allocate to each worker. The default value is 128 MB.</p> <p>For more information about these parameters, see the <a href="#">Amazon RDS documentation</a>.</p>	

## Prepare the target environment

Task	Description	Skills required
Create a new Amazon RDS for PostgreSQL DB instance to transport your source database to.	Determine the instance class and PostgreSQL version based on your business requirements.	DBA, Systems administrator, Database architect
Modify the security group of the target to allow connections on the DB instance port from the EC2 instance.	By default, the port for the PostgreSQL instance is 5432. If you're using another port, connections to that port must be open for the EC2 instance.	DBA, Systems administrator
Modify the instance, and assign the new target parameter group.	For example, <code>pgtarget-param-group</code> .	DBA

Task	Description	Skills required
Restart the target Amazon RDS DB instance.	The parameters <code>shared_preload_libraries</code> and <code>max_worker_processes</code> are static parameters and require a reboot of the instance.	DBA, Systems administrator
Connect to the database from the EC2 instance using <code>psql</code> .	Use the command: <pre>psql -h &lt;rd_s_end_point&gt; -p PORT -U username -d database -W</pre>	DBA
Create the <code>pg_transport</code> extension.	Run the following query as a user with the <code>rd_s_superuser</code> role: <pre>create extension pg_transport;</pre>	DBA

## Prepare the source environment

Task	Description	Skills required
Modify the security group of the source to allow connections on the DB instance port from the Amazon EC2 instance and target DB instance	By default, the port for PostgreSQL instance is 5432. If you're using another port, connections to that port must be open for the EC2 instance.	DBA, Systems administrator
Modify the instance and assign the new source parameter group.	For example, <code>pgsource-param-group</code> .	DBA

Task	Description	Skills required
Restart the source Amazon RDS DB instance.	The parameters <code>shared_preload_libraries</code> and <code>max_worker_processes</code> are static parameters and require a reboot of the instance.	DBA
Connect to the database from the EC2 instance using <code>psql</code> .	Use the command: <pre>psql -h &lt;rd_s_end_point&gt; -p PORT -U username -d database -W</pre>	DBA
Create the <code>pg_transport</code> extension and remove all other extensions from the databases to be transported.	The transport will fail if there are any extensions other than <b><code>pg_transport</code></b> installed on the source database. This command must be run by a user with the <code>rds_superuser</code> role.	DBA

## Perform the transport

Task	Description	Skills required
Perform a dry run.	Use the transport <code>.import_from_server</code> function to perform a dry run first: <pre>SELECT transport .import_from_server( 'source-db-instance-endpoint', source- db-instance-port,</pre>	DBA

Task	Description	Skills required
	<pre>'source-db-instance-user', 'source-user-password', 'source-database-name', 'destination-user-password', 'true');</pre> <p>The last parameter of this function (set to <code>true</code>) defines the dry run.</p> <p>This function displays any errors that you would see when you run the main transport. Resolve the errors before you run the main transport.</p>	

Task	Description	Skills required
If the dry run is successful, initiate the database transport.	<p>Run the <code>transport.import_from_server</code> function to perform the transport. It connects to the source and imports the data.</p> <pre data-bbox="597 493 1026 968">SELECT transport .import_from_server(  'source-db-instance-endpoint', source- db-instance-port,  'source-db-instance- user', 'source-user- password', 'source- database-name',  'destination-user- password', false);</pre> <p>The last parameter of this function (set to <code>false</code>) indicates that this isn't a dry run.</p>	DBA
Perform post-transport steps.	<p>After the database transport is complete:</p> <ul data-bbox="597 1360 1026 1850" style="list-style-type: none"><li>• Validate the data in the target environment.</li><li>• Add all the roles and permissions to the target.</li><li>• Enable all required extensions in the target and source, if required.</li><li>• Revert the value of the <code>max_worker_processes</code> parameter.</li></ul>	DBA



## Related resources

- [Amazon RDS documentation](#)
- [pg\\_transport documentation](#)
- [Migrating databases using RDS PostgreSQL Transportable Databases \(blog post\)](#)
- [PostgreSQL downloads](#)
- [psql utility](#)
- [Creating a DB Parameter Group](#)
- [Modify Parameters in a DB Parameter Group](#)
- [PostgreSQL downloads](#)

# Replatform

## Topics

- [Configure links between Oracle Database and Aurora PostgreSQL-Compatible](#)
- [Export a Microsoft SQL Server database to Amazon S3 by using AWS DMS](#)
- [Migrate ML Build, Train, and Deploy workloads to Amazon SageMaker using AWS Developer Tools](#)
- [Migrate OpenText TeamSite workloads to the AWS Cloud](#)
- [Migrate Oracle CLOB values to individual rows in PostgreSQL on AWS](#)
- [Migrate an on-premises Oracle database to Amazon RDS for Oracle by using direct Oracle Data Pump Import over a database link](#)
- [Migrate Oracle E-Business Suite to Amazon RDS Custom](#)
- [Migrate Oracle PeopleSoft to Amazon RDS Custom](#)
- [Migrate Oracle ROWID functionality to PostgreSQL on AWS](#)
- [Migrate Oracle Database error codes to an Amazon Aurora PostgreSQL-Compatible database](#)
- [Migrate Redis workloads to Redis Enterprise Cloud on AWS](#)
- [Migrate SAP ASE on Amazon EC2 to Amazon Aurora PostgreSQL-Compatible using AWS SCT and AWS DMS](#)
- [Migrate Windows SSL certificates to an Application Load Balancer using ACM](#)
- [Migrate a messaging queue from Microsoft Azure Service Bus to Amazon SQS](#)
- [Migrate an Oracle JD Edwards EnterpriseOne database to AWS by using Oracle Data Pump and AWS DMS](#)
- [Migrate an Oracle PeopleSoft database to AWS by using AWS DMS](#)
- [Migrate an on-premises MySQL database to Amazon RDS for MySQL](#)
- [Migrate an on-premises Microsoft SQL Server database to Amazon RDS for SQL Server](#)
- [Migrate data from Microsoft Azure Blob to Amazon S3 by using Rclone](#)
- [Migrate from Couchbase Server to Couchbase Capella on AWS](#)
- [Migrate from IBM WebSphere Application Server to Apache Tomcat on Amazon EC2](#)
- [Migrate from IBM WebSphere Application Server to Apache Tomcat on Amazon EC2 with Auto Scaling](#)
- [Migrate a .NET application from Microsoft Azure App Service to AWS Elastic Beanstalk](#)
- [Migrate a self-hosted MongoDB environment to MongoDB Atlas on the AWS Cloud](#)

- [Migrate from Oracle WebLogic to Apache Tomcat \(TomEE\) on Amazon ECS](#)
- [Migrate an Oracle database from Amazon EC2 to Amazon RDS for Oracle using AWS DMS](#)
- [Migrate an on-premises Oracle database to Amazon OpenSearch Service using Logstash](#)
- [Migrate an on-premises Oracle database to Amazon RDS for Oracle](#)
- [Migrate an on-premises Oracle database to Amazon RDS for Oracle using Oracle Data Pump](#)
- [Migrate from PostgreSQL on Amazon EC2 to Amazon RDS for PostgreSQL using pglogical](#)
- [Migrate an on-premises PostgreSQL database to Aurora PostgreSQL](#)
- [Migrate an on-premises Microsoft SQL Server database to Microsoft SQL Server on Amazon EC2 running Linux](#)
- [Migrate an on-premises Microsoft SQL Server database to Amazon RDS for SQL Server using linked servers](#)
- [Migrate an on-premises Microsoft SQL Server database to Amazon RDS for SQL Server using native backup and restore methods](#)
- [Migrate a Microsoft SQL Server database to Aurora MySQL by using AWS DMS and AWS SCT](#)
- [Migrate an on-premises MariaDB database to Amazon RDS for MariaDB using native tools](#)
- [Migrate an on-premises MySQL database to Aurora MySQL](#)
- [Migrate on-premises MySQL databases to Aurora MySQL using Percona XtraBackup, Amazon EFS, and Amazon S3](#)
- [Migrate on-premises Java applications to AWS using AWS App2Container](#)
- [Migrate shared file systems in an AWS large migration](#)
- [Migrate an Oracle database to Amazon RDS for Oracle by using Oracle GoldenGate flat file adapters](#)
- [Change Python and Perl applications to support database migration from Microsoft SQL Server to Amazon Aurora PostgreSQL-Compatible Edition](#)

# Configure links between Oracle Database and Aurora PostgreSQL-Compatible

Created by Jeevan Shetty (AWS), Bhanu Ganesh Gudivada (AWS), Sushant Deshmukh (AWS), Uttiya Gupta (AWS), and Vikas Gupta (AWS)

<b>Environment:</b> PoC or pilot	<b>Source:</b> Oracle Database	<b>Target:</b> Aurora PostgreSQL-Compatible
<b>R Type:</b> Replatform	<b>Workload:</b> Oracle; Open-source	<b>Technologies:</b> Migration; Databases
<b>AWS services:</b> Amazon Aurora; Amazon EC2 Auto Scaling; Amazon Route 53		

## Summary

As part of the migration to the Amazon Web Services (AWS) Cloud, you can modernize your applications to use cloud-native databases. Migrating from Oracle Database to Amazon Aurora PostgreSQL-Compatible Edition is one such step toward modernization. As part of that migration, native Oracle database links also require conversion.

Using a database link, one database can access objects in another database. After migration from Oracle Database to Aurora PostgreSQL-Compatible, the database links from the Oracle Database server to other Oracle Database servers must be converted to PostgreSQL-to-Oracle database links.

This pattern shows how you can set up database links from an Oracle Database server to the Aurora PostgreSQL-Compatible database. Because database links are one-way, the pattern also covers converting database links from the PostgreSQL database to Oracle Database.

After migration and conversion from Oracle Database to an Aurora PostgreSQL-Compatible database, the following steps are required to set up database links between databases:

- To set up a database link with Oracle Database as the source and Aurora PostgreSQL-Compatible as the target, [Oracle Database Gateways](#) must be configured for communication between heterogeneous databases.

- If you are setting up a database link between Aurora PostgreSQL-Compatible version 12.6 and earlier as the source database and Oracle Database as the target, the `oracle_fdw` extension is not available natively. Instead, you can use the `postgres_fdw` extension in the Aurora PostgreSQL-Compatible database and configure `oracle_fdw` in a PostgreSQL database created on Amazon Elastic Compute Cloud (Amazon EC2). This database acts as an intermediary between the Aurora PostgreSQL-Compatible database and Oracle Database. This pattern includes two options for setting up the database link with Aurora PostgreSQL 12.6 and earlier:
  - Configure the EC2 instance in an Amazon EC2 Auto Scaling group with an Amazon EC2 startup script that updates an internal Domain Name System (DNS) entry in Amazon Route 53.
  - Configure the EC2 instance in an Amazon EC2 Auto Scaling group, with a Network Load Balancer for high availability (HA).

If you are setting up a database link between Aurora PostgreSQL-Compatible version 12.7 and later, you can use the `oracle_fdw` extension.

## Prerequisites and limitations

### Prerequisites

- Amazon Aurora PostgreSQL-Compatible database in a virtual private cloud (VPC)
- Network connectivity between the Oracle and Aurora PostgreSQL-Compatible databases

### Limitations

- Currently, database links cannot be set up with Amazon Relational Database Service (Amazon RDS) for Oracle as the source database and Aurora PostgreSQL-Compatible as the target database.

### Product versions

- Oracle Database 11g and later
- Aurora PostgreSQL-Compatible 11 and later

## Architecture

### Source technology stack

Before migration, the source Oracle database can access objects in other Oracle databases using database links. This works natively between Oracle databases on premises or in the AWS Cloud.

## Target technology stack

### *Option 1*

- Amazon Aurora PostgreSQL-Compatible Edition
- PostgreSQL database on an Amazon EC2 instance
- Amazon EC2 Auto Scaling group
- Amazon Route 53
- Amazon Simple Notification Service (Amazon SNS)
- AWS Identity and Access Management (IAM)
- AWS Direct Connect

### *Option 2*

- Amazon Aurora PostgreSQL-Compatible Edition
- PostgreSQL database on an Amazon EC2 instance
- Amazon EC2 Auto Scaling group
- Network Load Balancer
- Amazon SNS
- Direct Connect

### *Option 3*

- Amazon Aurora PostgreSQL-Compatible Edition
- Direct Connect

## Target architecture

### *Option 1*

The following diagram shows database link setup using the `oracle_fdw` and `postgres_fdw` extensions, with HA provided by an Amazon EC2 Auto Scaling group and Route 53.

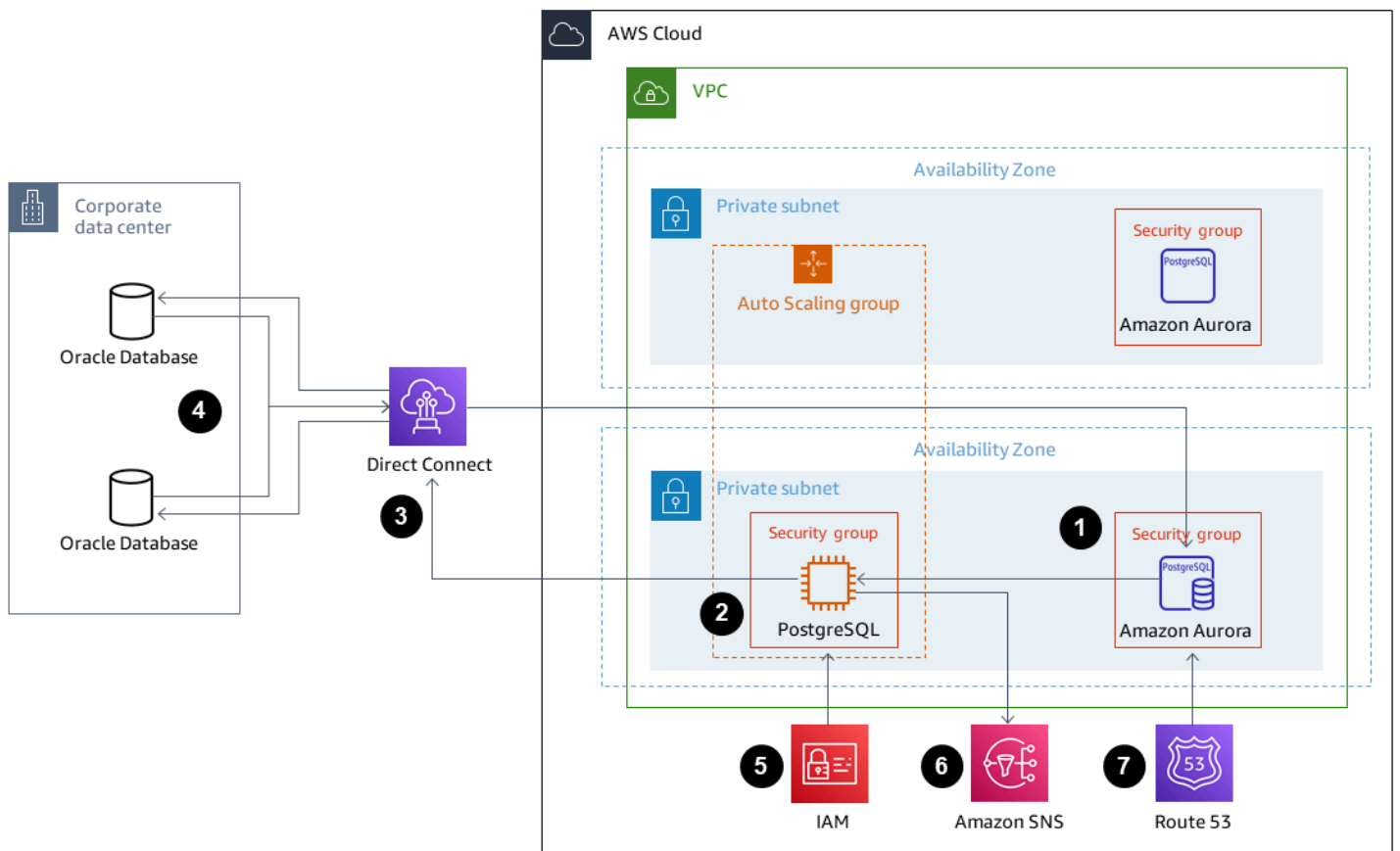

1. An Aurora PostgreSQL-Compatible instance with the `postgres_fdw` extension connects to the PostgreSQL database on Amazon EC2.
2. The PostgreSQL database with the `oracle_fdw` extension is in an Auto Scaling group.
3. The PostgreSQL database on Amazon EC2 uses Direct Connect to connect to Oracle Database on premises.
4. Oracle Database is configured with Oracle Database Gateways for connections from Oracle Database to the PostgreSQL database on AWS.
5. IAM grants permission to Amazon EC2 to update Route 53 records.
6. Amazon SNS sends alerts for automatic scaling actions.
7. The Domain Name configured in Route 53 points to the PostgreSQL Amazon EC2 instance IP address.

### Option 2

The following diagram shows database link setup using the `oracle_fdw` and `postgres_fdw` extensions, with HA provided by an Auto Scaling group and a Network Load Balancer.

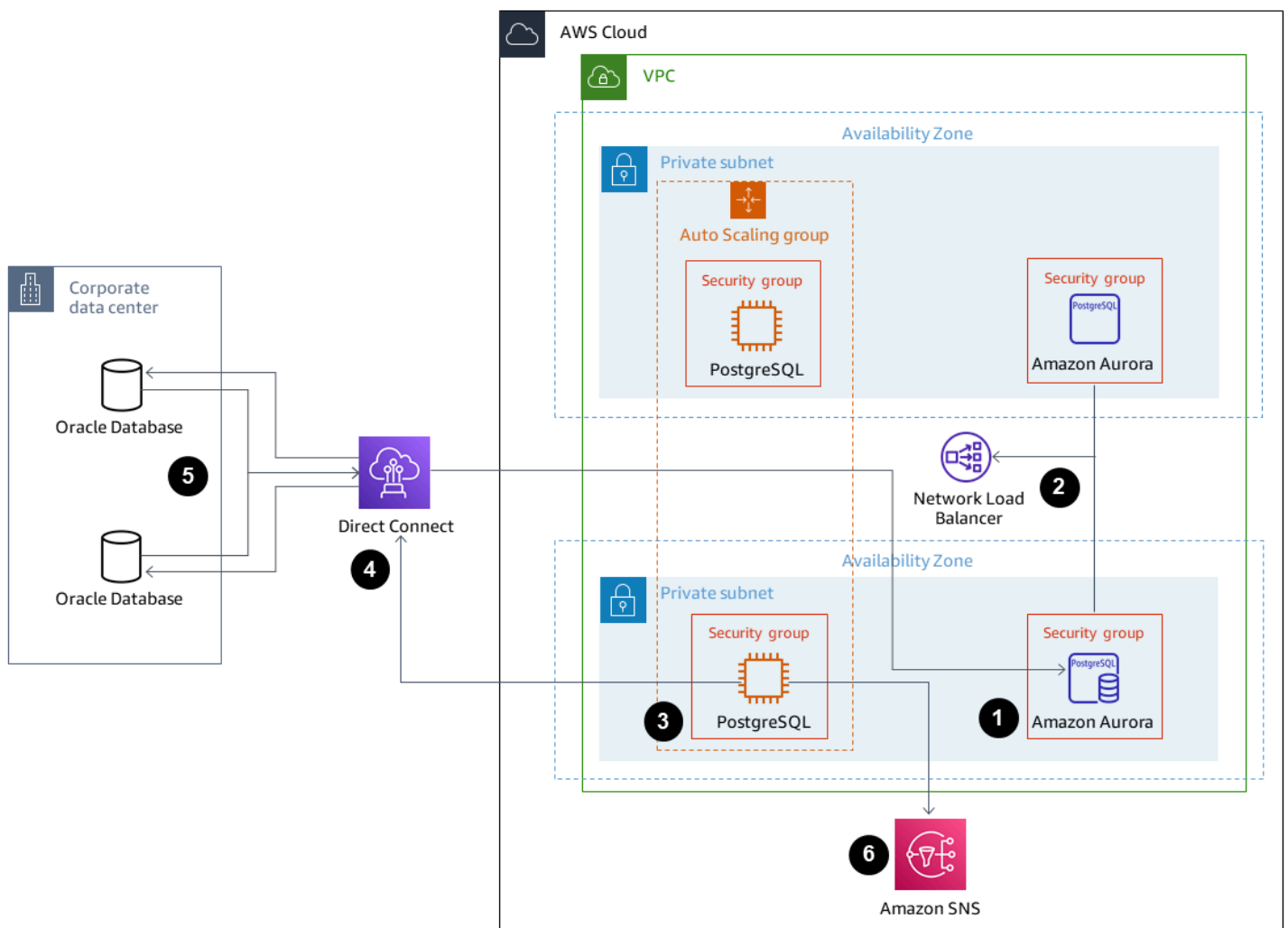

1. An Aurora PostgreSQL-Compatible instance with the `postgres_fdw` extension connects to the Network Load Balancer.
2. The Network Load Balancer distributes the connection from the Aurora PostgreSQL-Compatible database to the PostgreSQL database on Amazon EC2.
3. The PostgreSQL database with the `oracle_fdw` extension is in an Auto Scaling group.
4. The PostgreSQL database on Amazon EC2 uses Direct Connect to connect to Oracle Database on premises.
5. Oracle Database is configured with Oracle Database Gateways for connections from Oracle Database to the PostgreSQL database on AWS.
6. Amazon SNS sends alerts for automatic scaling actions.

### Option 3



The following diagram shows database link setup using the `oracle_fdw` extension in an Aurora PostgreSQL-Compatible database.

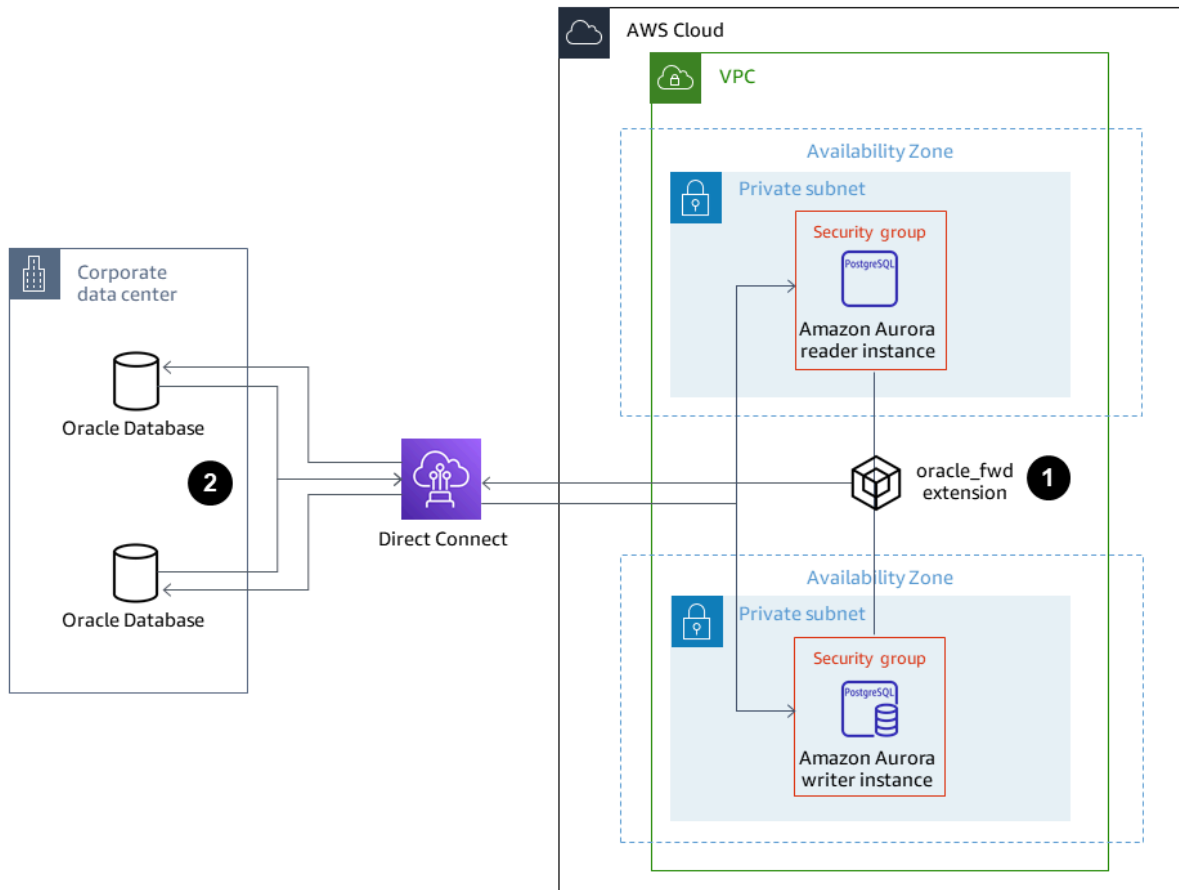

1. An Aurora PostgreSQL-Compatible instance with the `oracle_fdw` extension uses Direct Connect to connect to Oracle Database.
2. Oracle Database Gateways set up on Oracle Server enables connectivity through Direct Connect to the Aurora PostgreSQL-Compatible database.

## Tools

### AWS services

- [Amazon Aurora PostgreSQL-Compatible Edition](#) is a fully managed, ACID-compliant relational database engine that helps you set up, operate, and scale PostgreSQL deployments.

- [AWS Direct Connect](#) links your internal network to a Direct Connect location over a standard Ethernet fiber-optic cable. With this connection, you can create virtual interfaces directly to public AWS services while bypassing internet service providers in your network path.
- [Amazon Elastic Compute Cloud \(Amazon EC2\)](#) provides scalable computing capacity in the AWS Cloud. You can launch as many virtual servers as you need and quickly scale them up or down. In this pattern, options 1 and 2 use an EC2 instance to host a PostgreSQL database.
- [Amazon EC2 Auto Scaling](#) helps you maintain application availability and allows you to automatically add or remove Amazon EC2 instances according to conditions you define.
- [AWS Identity and Access Management \(IAM\)](#) helps you securely manage access to your AWS resources by controlling who is authenticated and authorized to use them.
- [Amazon Route 53](#) is a highly available and scalable DNS web service.
- [Amazon Simple Notification Service \(Amazon SNS\)](#) helps you coordinate and manage the exchange of messages between publishers and clients, including web servers and email addresses.
- [Elastic Load Balancing \(ELB\)](#) distributes incoming application or network traffic across multiple targets. For example, you can distribute traffic across Amazon Elastic Compute Cloud (Amazon EC2) instances, containers, and IP addresses in one or more Availability Zones. This pattern uses a Network Load Balancer.

## Other services

- [Oracle Database Gateways](#) provides Oracle Database with the ability to access data in a non-Oracle system.

## Epics

### Common setup tasks for Option 1 and Option 2

Task	Description	Skills required
Create an EC2 instance and configure the oracle_fdw PostgreSQL extension.	<ol style="list-style-type: none"> <li>1. Create an EC2 instance with the <a href="#">Amazon Linux 2</a> operating system.</li> </ol> <p><b>Note:</b> Amazon Linux 2 is nearing end of support. For</p>	Cloud administrator, DBA

Task	Description	Skills required
	<p>more information, see the <a href="#">Amazon Linux 2 FAQs</a>.</p> <p>2. To install PostgreSQL, log in to the EC2 instance as ec2-user, and run the following commands.</p> <pre data-bbox="634 531 1029 1724">sudo su - root  sudo tee /etc/yum. repos.d/pgdg.repo&lt; &lt;EOF [pgdg12] name=PostgreSQL 12   for RHEL/CentOS 7 -   x86_64 baseurl=https://down load.postgresql.or g/pub/repos/yum/12/ redhat/rhel-7-x86_64 enabled=1 gpgcheck=0 EOF  sudo yum install -y   postgresql12-server sudo yum install   postgresql12-devel  sudo /usr/pgsql-12/ bin/postgresql-12- setup initdb sudo systemctl enable   postgresql-12 sudo systemctl start   postgresql-12</pre>	
	<p>3. Download the <code>oracle_fdw</code> source code from GitHub.</p>	

Task	Description	Skills required
	<pre>mkdir -p /var/lib/ pgsql/oracle_fdw/ cd /var/lib/pgsql/ oracle_fdw/  wget https://g ithub.com/laurenz/ oracle_fdw/archive /refs/heads/master .zip unzip master.zip</pre> <p data-bbox="592 699 1026 829"><b>4. Install Oracle Instant Client and set up the Oracle environment variables.</b></p> <pre>yum install https://d ownload.oracle.com /otn_software/linu x/instantclient/19 12000/oracle-insta ntclient19.12-basi c-19.12.0.0.0-1.x8 6_64.rpm</pre> <pre>yum install https://d ownload.oracle.com /otn_software/linu x/instantclient/19 12000/oracle-insta ntclient19.12-deve l-19.12.0.0.0-1.x8 6_64.rpm</pre> <pre>export ORACLE_H0 ME=/usr/lib/oracle /19.12/client64exp ort LD_LIBRAR</pre>	

Task	Description	Skills required
	<pre>LD_LIBRARY_PATH=/usr/lib/oracle/19.12/client64/lib:\$LD_LIBRARY_PATH</pre> <p>5. Make sure that <code>pg_config</code> is referring to the correct version.</p> <pre>which pg_config</pre> <p>6. Compile <code>oracle_fdw</code> .</p> <pre>cd /var/lib/pgsql/oracle_fdw/oracle_fdw-master make make install</pre> <p><b>Note:</b> If you receive an error saying that <code>oci.h</code> is missing, add the following in Makefile:</p> <ul style="list-style-type: none"><li>• To <code>PG_CPPFLAGS</code> , add <code>-I/usr/include/oracle/19.12/client64</code></li><li>• To <code>SHLIB_LINK</code> , add <code>-L/usr/lib/oracle/19.12/client64/lib</code></li></ul> <p>For more information, see the <a href="#">oracle_fdw repository</a>.</p> <p>7. Log in to the PostgreSQL database and create the <code>oracle_fdw</code> extension.</p>	

Task	Description	Skills required
	<pre>sudo su - postgres psql postgres create extension oracle_fdw;</pre> <p data-bbox="592 422 998 548">8. Create a PostgreSQL user that will own the foreign tables.</p> <pre>CREATE USER pguser WITH PASSWORD '&lt;password&gt;'; GRANT CONNECT ON DATABASE postgres TO pguser;</pre> <p data-bbox="592 884 1015 1104">9. Create the foreign data wrapper. Substitute the following values with your Oracle Database server details:</p> <ul data-bbox="630 1136 987 1331" style="list-style-type: none"><li>• &lt;Oracle DB Server IP&gt;</li><li>• &lt;Oracle DB Port&gt;</li><li>• &lt;Oracle_SID&gt;</li></ul> <pre>create server oradb foreign data wrapper oracle_fdw options (dbserver '//&lt;Oracle DB Server IP&gt;:&lt;Oracle DB Port&gt;/&lt;Oracle_SID&gt;'); GRANT USAGE ON FOREIGN SERVER oradb TO pguser;</pre>	

Task	Description	Skills required
	<p>10.To create the user mapping and a foreign table that maps to the Oracle table, connect to the PostgreSQL database as <code>pguser</code>, and run the following command. Note that in the example code, <code>DMS_SAMPLE</code> is used as the Oracle schema containing the <code>NAME_DATA</code> table, and <code>dms_sample</code> is its password. Replace them as necessary.</p> <pre data-bbox="634 905 1029 1184">create user mapping for pguser server oradb options (user 'DMS_SAMPLE', password 'dms_samp le');</pre> <p><b>Note:</b> The following example creates a foreign table in PostgreSQL for a table in Oracle Database. A similar foreign table must be created for every Oracle table that requires access from the PostgreSQL instance.</p> <pre data-bbox="634 1675 1029 1768">CREATE FOREIGN TABLE name_data(</pre>	

Task	Description	Skills required
	<pre> name_type CHARACTER VARYING(1 5) NOT NULL, name CHARACTER VARYING(45) NOT NULL ) SERVER oradb OPTIONS (schema 'DMS_SAMPLE', table 'NAME_DATA');  select count(*) from name_data; </pre> <p>11 Configure the PostgreSQL database on the EC2 instance so that it can locate the Oracle libraries during PostgreSQL database startup. This is required by the <code>oracle_fdw</code> extension.</p> <pre> sudo systemctl stop postgresql-12 </pre> <p><b>Note:</b> Edit the <code>/usr/lib/systemd/system/postgresql-12.service</code> file to include the environment variables so that <code>systemctl</code> startup will find the Oracle libraries required by <code>oracle_fdw</code>.</p> <pre> # Oracle Environment Variables </pre>	



Task	Description	Skills required
	<pre>Environment=ORACLE_HOME=/u01/app/oracle/product/12.2.0.1/db_1 Environment=LD_LIBRARY_PATH=/u01/app/oracle/product/12.2.0.1/db_1/lib:/lib:/usr/lib  sudo systemctl start postgresql-12</pre>	

### Option 1: Set up a database link with the oracle\_fdw and postgres\_fdw extensions, an Auto Scaling group, and Route 53

Task	Description	Skills required
Set up a private hosted zone in Amazon Route 53.	<ol style="list-style-type: none"> <li>1. Create a private hosted zone in Amazon Route 53. Make a note of <b>Domain Name</b>, which will be associated with an EC2 instance.</li> <li>2. Add an "A" record using simple routing policy that resolves to the EC2 instance IP address, containing the oracle_fdw PostgreSQL extension.</li> <li>3. After saving the "A" record, make a note of the <b>Hosted zone ID</b> of the Domain Name from step 1. This</li> </ol>	DBA, Cloud administrator

Task	Description	Skills required
	will be used to create the appropriate IAM policy.	

Task	Description	Skills required
<p>Create an IAM role that will be attached to an EC2 instance.</p>	<p>To create an IAM role that will be attached to the EC2 instance, use the following policy. Replace &lt;Hosted zone ID&gt; with information captured in the previous story.</p> <pre data-bbox="597 583 1026 1816"> {   "Version":   "2012-10-17",   "Statement": [     {       "Sid":       "VisualEditor0",       "Effect":       "Allow",       "Action":       "route53:ChangeResourceRecordSets",       "Resource":       "arn:aws:route53::hostedzone/&lt;Hosted zone ID&gt;"     },     {       "Sid":       "VisualEditor1",       "Effect":       "Allow",       "Action":       "route53:ListHostedZones",       "Resource":       "*"     }   ] } </pre>	<p>Cloud administrator, DBA</p>

Task	Description	Skills required
Create an EC2 launch template.	<ol style="list-style-type: none"><li>1. Create an AMI of the EC2 instance that contains the <code>oracle_fdw</code> PostgreSQL extension.</li><li>2. Use the AMI to create an EC2 launch template.</li><li>3. To allow connection from the Aurora PostgreSQL-Compatible instance to the PostgreSQL database on the EC2 instance, associate the IAM role that you created earlier and attach security groups.</li><li>4. In the <b>User Data</b> section, add the following commands, changing Hosted zone ID and Domain Name to the appropriate values. Then choose <b>Create launch template</b>.</li></ol> <pre data-bbox="630 1329 1029 1814">#!/bin/bash  v_zone_id='Hosted zone ID' v_domain_name= 'Domain Name' v_local_ipv4= \$(curl -s http://16 9.254.169.254/late st/meta-data/local- ipv4)</pre>	Cloud administrator, DBA

Task	Description	Skills required
	<pre>aws route53 change-record-sets --hosted-zone-id \$v_zone_id --change-batch '{"Changes":[{"Action":"UPSERT","ResourceRecordSet":{"Name":"'\$v_domain_name',"Type":"A","TTL":10,"ResourceRecords":[{"Value":"'\$v_local_ipv4'"}]}}]}'</pre>	

Task	Description	Skills required
Set up the Auto Scaling group.	<ol style="list-style-type: none"><li data-bbox="591 226 1008 405">1. To set up an Auto Scaling group, use the launch template that you created in the previous step.</li><li data-bbox="591 426 1003 699">2. Configure appropriate VPC and subnets that will be used to launch the EC2 instance. Option 1 setup does not use <b>Load Balancer</b>.</li><li data-bbox="591 720 1024 856">3. Set the <b>Desired, Minimum, and Maximum</b> capacity to 1 under <b>Scaling policies</b>.</li><li data-bbox="591 877 967 1098">4. To send alerts to the operations team, add notifications for events such as Launch or Terminate.</li><li data-bbox="591 1119 1000 1255">5. Review the configuration, and choose <b>Create Auto Scaling group</b>.</li></ol> <p data-bbox="591 1329 1008 1602">On completion, the Auto Scaling group starts the EC2 instance containing the <code>oracle_fdw</code> PostgreSQL extension, which connects to Oracle Database.</p> <p data-bbox="591 1644 1000 1877"><b>Note:</b> When you need to access a new Oracle table or change the structure of an Oracle table, those changes must be reflected in the</p>	Cloud administrator, DBA

Task	Description	Skills required
	PostgreSQL foreign table. After you implement the changes, you must create a new AMI of the EC2 instance and use it to configure the launch template.	

Task	Description	Skills required
Configure the postgres_fdw extension in the Aurora PostgreSQL-Compatible instance.	<ol style="list-style-type: none"><li>1. Configure postgres_fdw in the Aurora PostgreSQL-Compatible instance. This connects to the PostgreSQL database on Amazon EC2, which acts as an intermediate node between the Aurora PostgreSQL-Compatible instance and Oracle Database.</li><li>2. Connect to the Aurora PostgreSQL-Compatible instance and run the following commands.</li></ol> <pre data-bbox="630 974 1029 1864">create extension postgres_fdw; CREATE SERVER pgoradb FOREIGN DATA WRAPPER postgres_fdw OPTIONS (dbname 'postgres', host 'Domain Name', port '5432');  CREATE USER MAPPING for postgres SERVER pgoradb OPTIONS (user 'pguser', password '&lt;password&gt;');  CREATE FOREIGN TABLE data_mart.name_data(     name_type     CHARACTER VARYING(15) NOT NULL,</pre>	Cloud administrator, DBA



Task	Description	Skills required
	<pre data-bbox="630 205 1026 625">name CHARACTER VARYING(45) NOT NULL ) SERVER pgoradb OPTIONS (schema_name 'public', table_name 'name_data');  select count(*) from data_mart.name_data; </pre> <p data-bbox="591 688 997 869">This completes the setup of a database link from Aurora PostgreSQL-Compatible to Oracle Database.</p> <p data-bbox="591 915 1023 1612">The solution provides a disaster recovery (DR) strategy, in case the EC2 instance hosting the PostgreSQL database fails. The Auto Scaling group starts a new EC2 instance and updates the DNS with the IP address of the new EC2 instance. This ensures that the foreign tables in the Aurora PostgreSQL-Compatible instance can access the Oracle tables without manual intervention.</p>	

## Option 2: Set up a database link with the `oracle_fdw` and `postgres_fdw` extensions, an Auto Scaling group, and a Network Load Balancer

Task	Description	Skills required
Create an EC2 launch template.	<ol style="list-style-type: none"> <li>1. Create an AMI of the EC2 instance that contains the <code>oracle_fdw</code> PostgreSQL extension.</li> <li>2. Use the AMI to create an EC2 launch template.</li> </ol>	Cloud administrator, DBA
Set up a target group, Network Load Balancer, and Auto Scaling group.	<ol style="list-style-type: none"> <li>1. To create a target group, choose <b>Instances</b> as the target type. For <b>Protocol</b>, choose <b>TCP</b>, and for <b>Port</b>, choose 5432. Then choose the VPC where you want the target group, and select the appropriate <b>Health check</b>.</li> <li>2. Create an internal Network Load Balancer in the VPC. Configure the load balancer to listen on protocol:port TCP:5432. Set the <b>Default action</b> as <b>Forward to</b>, and choose the target group that you created.</li> <li>3. Set up an Auto Scaling group using the launch template that you created.</li> <li>4. Configure the Auto Scaling group with the appropriate VPC and subnets that will</li> </ol>	Cloud administrator, DBA

Task	Description	Skills required
	<p>be used to launch the EC2 instances.</p> <ol style="list-style-type: none"><li data-bbox="592 310 1015 632">5. For the <b>Load Balancing</b> option, choose <b>Attach to an existing load balancer</b>, and select the <b>Target Group</b> that you created. For <b>Health checks</b>, select <b>ELB</b>.</li><li data-bbox="592 657 1003 978">6. Set the <b>Desired</b> and <b>Minimum</b> capacity to 2, and set the <b>Maximum</b> capacity to a higher number, as required to support the load with HA, under <b>Scaling policies</b>.</li><li data-bbox="592 1003 966 1220">7. To send alerts to the operations team, add notifications for events such as <b>Launch</b> or <b>Terminate</b>.</li><li data-bbox="592 1245 998 1377">8. Review the configuration, and choose <b>Create Auto Scaling group</b>.</li></ol> <p>On completion, the Auto Scaling group starts the desired number of EC2 instances containing the <code>oracle_fdw</code> PostgreSQL extension that connects to Oracle Database.</p>	

Task	Description	Skills required
	<p><b>Note:</b> When you need to access a new Oracle table or change the structure of an Oracle table, those changes must be reflected in the PostgreSQL foreign table. After you implement the changes, you must create a new AMI of the EC2 instance and use it to configure the launch template.</p>	

Task	Description	Skills required
Configure the postgres_fdw extension in the Aurora PostgreSQL-Compatible instance.	<p>Configure postgres_fdw in the Aurora PostgreSQL-Compatible instance. This connects to PostgreSQL Database on EC2 through a Network Load Balancer. The PostgreSQL instance on EC2 acts as an intermediate node between Aurora PostgreSQL-Compatible instance and Oracle Database.</p> <p>Connect to the Aurora PostgreSQL-Compatible instance and run the following commands.</p> <pre data-bbox="594 999 1029 1841">create extension postgres_fdw; CREATE SERVER pgoradb FOREIGN DATA WRAPPER postgres_fdw OPTIONS (dbname 'postgres ', host 'DNS name of Network Load Balancer' , port '5432');  CREATE USER MAPPING for postgres SERVER pgoradb OPTIONS (user 'pguser', password '&lt;password&gt;');  CREATE FOREIGN TABLE data_mart.name_data( name_type CHARACTER VARYING(15) NOT NULL,</pre>	Cloud administrator, DBA

Task	Description	Skills required
	<pre>name CHARACTER VARYING(45) NOT NULL ) SERVER pgoradb OPTIONS (schema_name 'public', table_name 'name_data');  select count(*) from data_mart.name_data;</pre> <p>This completes the setup of database link from Aurora PostgreSQL-Compatible to Oracle Database.</p> <p>In case of EC2 hosting the PostgreSQL database fails, the Network Load Balancer identifies the failure and stops the traffic to failed EC2 instance. The Auto Scaling group starts a new EC2 instance and registers it with the load balancer. This ensures that after the original EC2 instance fails, the foreign tables in the Aurora PostgreSQL-Compatible instance can access the Oracle tables without manual intervention.</p>	

### Option 3: Set up a database link with the `oracle_fdw` extension in an Aurora PostgreSQL-Compatible database

Task	Description	Skills required
Configure the <code>oracle_fdw</code> extension in the Aurora PostgreSQL-Compatible instance.	<p>For Aurora PostgreSQL-Compatible database version 12.7 and later, the <code>oracle_fdw</code> extension is natively available. This eliminates the need to create the intermediate PostgreSQL database on an EC2 instance. The Aurora PostgreSQL-Compatible instance can connect to Oracle Database directly.</p> <ol style="list-style-type: none"><li>1. To create the <code>oracle_fdw</code> extension, log in to the Aurora PostgreSQL-Compatible instance, and run the following command. <pre>create extension oracle_fdw;</pre></li><li>2. Create the foreign data wrapper. Substitute the following values with your Oracle Database server details:<ul style="list-style-type: none"><li>• &lt;Oracle DB Server IP&gt;</li><li>• &lt;Oracle DB Port&gt;</li><li>• &lt;Oracle_SID&gt;</li></ul></li></ol>	Cloud administrator, DBA

Task	Description	Skills required
	<pre data-bbox="634 212 1029 527">create server oradb foreign data wrapper oracle_fdw options (dbserver '//&lt;Oracle DB Server IP&gt;:&lt;Oracle DB Port&gt;/&lt;Oracle_SID&gt;');</pre> <p data-bbox="591 541 1024 1339">3. To create the user mapping and a foreign table that maps to the Oracle table, run the following command. Note that in the example code, DMS_SAMPLE is used as the Oracle schema containing the NAME_DATA table, and dms_sample is its password. Replace them as necessary. Also, Foreign Table has to be created in the Aurora PostgreSQL-Compatible instance for access to every other Oracle table.</p> <pre data-bbox="634 1381 1029 1835">create user mapping for postgres server oradb options (user 'DMS_SAMPLE', password 'dms_sample');  CREATE FOREIGN TABLE name_data( name_type character varying(1</pre>	



Task	Description	Skills required
	<pre data-bbox="634 212 1003 583">5) OPTIONS (key 'true') NOT NULL,     name character     varying(45) OPTIONS     (key 'true') NOT NULL )SERVER oradb OPTIONS (schema 'DMS_SAMP LE', table 'NAME_DAT A');</pre> <p data-bbox="630 625 1019 846">A similar foreign table must be created for every Oracle table that requires access from the PostgreSQL instance.</p>	

## Set up Oracle Database Gateways for connectivity from on-premises Oracle Database to Aurora PostgreSQL-Compatible

Task	Description	Skills required
Configure the gateway in the on-premises Oracle Database server.	<ol data-bbox="592 1192 1019 1577" style="list-style-type: none"> <li>As the root user, install the latest unixODBC driver manager.           <pre data-bbox="634 1360 1029 1478">sudo yum install unixODBC*</pre> </li> <li>Install the PostgreSQL ODBC driver (psqlODBC).           <pre data-bbox="634 1619 1029 1824">sudo wget https://d ownload.postgresql .org/pub/repos/yum /reporpms/EL-7-x86 _64/pgdg-redhat-re</pre> </li> </ol>	DBA

Task	Description	Skills required
	<pre data-bbox="634 212 992 506"> po-latest.noarch.r pm sudo yum install pgdg-redhat-repo-1 atest.noarch.rpm sudo yum install postgres12-odbc </pre> <p data-bbox="592 520 1023 651">3. Create an ODBC Data Source Name (DSN) for the driver.</p> <p data-bbox="630 695 1031 1304">The unixODBC driver manager provides the <code>odbcinst</code>, <code>odbc_config</code>, and <code>isql</code> command line utilities used to configure and test the driver. Using <code>odbcinst</code> or <code>odbc_config</code> utilities, you can locate the unixODBC driver manager files to pass driver information to create the DSN.</p> <pre data-bbox="634 1346 992 1423"> odbcinst -j </pre> <p data-bbox="630 1461 1006 1545">The following code shows example output.</p> <pre data-bbox="634 1581 992 1871"> unixODBC 2.3.1 DRIVERS..... .....: /etc/odbc inst.ini SYSTEM DATA SOURCES: /etc/odbc .ini </pre>	

Task	Description	Skills required
	<pre data-bbox="646 212 987 856"> FILE DATA SOURCES.. : /etc/ODBCDataSources USER DATA SOURCES.. : /root/.odbc.ini SQLULEN Size.....: 8 SQLLEN Size.....: 8 SQLSETPOSIRROW Size.: 8  odbc_config --odbcini --odbcinstini /etc/odbc.ini /etc/odbcinst.ini </pre> <p data-bbox="630 898 1029 1507">From the example output, you can see the <code>odbcinst.ini</code> and <code>odbc.ini</code> files. Basically, <code>odbcinst.ini</code> is a registry and configuration file for ODBC drivers in an environment, while <code>odbc.ini</code> is a registry and configuration file for ODBC DSNs. To enable the drivers, you need to modify these two files.</p> <p data-bbox="591 1528 1029 1801">4. Configure the <code>psqlODBC</code> driver libraries in the ODBC driver file <code>/etc/odbcinst.ini</code>, and add the following lines to the end of the file. These lines</p>	

Task	Description	Skills required
	<p>make an entry for the driver.</p> <pre data-bbox="630 327 1029 961">[PostgreSQL] Description    =   ODBC for PostgreSQL Driver         = /   usr/lib/psqlodbcw.so Setup         = /   usr/lib/libodbcps   qlS.so Driver64      = /   usr/lib64/psqlodb   cw.so Setup64       = /   usr/lib64/libodbc   psqlS.so FileUsage     = 1</pre> <p>5. Create a DSN in the <code>/etc/odbc.ini</code> file. The driver manager reads this file to determine how to connect to the database using the driver details specified in <code>odbcinst.ini</code>. Replace the following parameters with actual values:</p> <ul data-bbox="630 1423 1010 1776" style="list-style-type: none"><li>• <code>&lt;PostgreSQL Port&gt;</code></li><li>• <code>&lt;PostgreSQL Database Name&gt;</code></li><li>• <code>&lt;Aurora PostgreSQL Endpoint&gt;</code></li><li>• <code>&lt;PostgreSQL username&gt;</code></li></ul>	

Task	Description	Skills required
	<ul style="list-style-type: none"><li data-bbox="630 212 873 296">• &lt;PostgreSQL password&gt;</li></ul> <pre data-bbox="646 352 1029 1245">[pgdsn] Driver=/usr/pgsql-12/lib/psqlodbc.so Description=PostgreSQL ODBC Driver Database=&lt;PostgreSQL Database Name&gt; Servername=&lt;Aurora PostgreSQL Endpoint&gt; Username=&lt;PostgreSQL username&gt; Password=&lt;PostgreSQL password&gt; Port=&lt;PostgreSQL Port&gt; UseDeclareFetch=1 CommLog=/tmp/pgodbclink.log Debug=1 LowerCaseIdentifier=1</pre> <p data-bbox="591 1262 1013 1486">6. Using the <code>isql</code> utility, test the ODBC connection (<code>psqlODBC</code>) to the PostgreSQL database DSN that you created.</p> <pre data-bbox="634 1528 1029 1606">isql -v pgdsn</pre> <p data-bbox="630 1644 1008 1724">The following code shows example output.</p>	

Task	Description	Skills required
	<pre data-bbox="630 210 1029 1003"> +-----+ -----+ ----+   Connected!       sql-statement   help [tablename]   quit   +-----+ -----+ -----+ quit </pre> <p data-bbox="591 1016 1023 1146">7. Using the DSN, create the gateway for the ODBC (HS) service handler.</p> <p data-bbox="630 1192 1016 1520">As the oracle user, create a file <code>initDSN.ora</code> in location <code>\$ORACLE_HOME/hs/admin</code> . In this case, <code>pgdsn</code> is the DSN, so you need to create a file called <code>initpgdsn.ora</code> .</p> <div data-bbox="630 1554 1029 1633" style="border: 1px solid #ccc; border-radius: 10px; padding: 5px; display: inline-block;"> <pre data-bbox="646 1575 941 1608">more initpgdsn.ora</pre> </div> <p data-bbox="630 1671 1003 1755">The following code shows example output.</p>	

Task	Description	Skills required
	<pre data-bbox="634 212 1029 1598"># This is a sample agent init file that contains the HS parameters that are # needed for the Database Gateway for ODBC # # HS init parameters #  HS_FDS_CONNEC T_INFO=pgdsn HS_FDS_TRACE_L EVEL=OFF HS_FDS_TRACE_FILE_ NAME=/tmp/ora_hs_t race.log HS_FDS_SHAREABLE_N AME=/usr/lib64/lib odbc.so HS_NLS_NCHAR=UCS2 HS_LANGUAGE=AMERICA N_AMERICA.AL32UTF8  # # ODBC specific environment variables #  set ODBCINI=/etc/ odbc.ini</pre> <p data-bbox="592 1612 987 1797">8. Adjust the listener (\$ORACLE_HOME/network/admin/listener.ora ) by adding the</p>	

Task	Description	Skills required
	<p>DSN entry in SID_LIST_LISTENER .</p> <pre>more \$ORACLE_HOME/ network/admin/ listener.ora</pre> <p>The following code shows example output.</p> <pre>SID_LIST_LISTENER = (SID_LIST = (SID_DESC= (SID_NAME = pgdsn) (ORACLE_HOME = / u01/app/oracle/pr oduct/12.2.0.1/db_ 1) (ENVS="LD _LIBRARY_PATH=/lib 64:/usr/lib:/usr/l ib64:/u01/app/orac le/product/12.2.0. 1/db_1") (PROGRAM=dg4odbc) ) )</pre> <p>9. Adjust the tnsname (\$ORACLE_HOME/network/admin/tnsnames.ora ) by adding the DSN entry.</p> <pre>more \$ORACLE_HOME/ network/admin/ tnsnames.ora</pre>	



Task	Description	Skills required
	<p>The following code shows example output.</p> <pre data-bbox="630 327 1029 604">pgdsn=(DESCRIPTION =(ADDRESS=(PROTOCOL=tcp)(HOST=localhost)(PORT=1521))(CONNECT_DATA=(SID=pgdsn))(HS=OK))</pre> <p>10 Restart the Oracle listener so that the DSN-related entries made to the networking files can take effect, changing &lt;Listener Name&gt; with the appropriate Oracle listener name.</p> <pre data-bbox="630 1031 1029 1230">lsnrctl stop &lt;Listener Name&gt; lsnrctl start &lt;Listener Name&gt;</pre> <p>After you restart the Oracle listener, it will create an Oracle HS handler with a DSN name (pgdsn).</p> <p>11 Use the DSN to create an Oracle database link to access the PostgreSQL database by logging in to Oracle Database.</p> <pre data-bbox="630 1730 1029 1829">create public database link pgdb connect to</pre>	

Task	Description	Skills required
	<pre>"postgres" identified by "postgres" using 'pgdsn';</pre> <p>12 Access the PostgreSQL data by using the Oracle database link created.</p> <pre>select count(*) from "pg_tables"@pgdb;</pre>	

## Related resources

- [Amazon Aurora PostgreSQL](#)
- [Amazon Elastic Compute Cloud \(Amazon EC2\)](#)
- [AWS Identity and Access Management \(IAM\)](#)
- [Launch an instance from a launch template](#)
- [Auto Scaling groups](#)
- [Amazon Route 53](#)
- [Amazon Simple Notification Service \(SNS\)](#)
- [AWS Network Load Balancer](#)
- [Oracle Database Gateways](#)

## Additional information

Although the `oracle_fdw` extension is available with Aurora PostgreSQL-Compatible version 12.7 and later, this pattern includes solutions for earlier versions of Aurora PostgreSQL-Compatible databases, because many customers support older versions of Aurora PostgreSQL-Compatible databases, and upgrading a database involves multiple levels of application and performance testing. Also, the database link feature is extensively used, and providing options for all versions of Aurora PostgreSQL-Compatible is the objective of this article.

# Export a Microsoft SQL Server database to Amazon S3 by using AWS DMS

*Created by Sweta Krishna (AWS)*

<b>Environment:</b> PoC or pilot	<b>Source:</b> Microsoft SQL Server	<b>Target:</b> Amazon S3
<b>R Type:</b> Replatform	<b>Workload:</b> Microsoft	<b>Technologies:</b> Migration; Databases
<b>AWS services:</b> AWS DMS; Amazon S3		

## Summary

Organizations often need to copy databases to Amazon Simple Storage Service (Amazon S3) for database migration, backup and restore, data archiving, and data analytics. This pattern describes how you can export a Microsoft SQL Server database to Amazon S3. The source database can be hosted on premises or on Amazon Elastic Compute Cloud (Amazon EC2) or Amazon Relational Database Service (Amazon RDS) for Microsoft SQL Server on the Amazon Web Services (AWS) Cloud.

The data is exported by using AWS Database Migration Service (AWS DMS). By default, AWS DMS writes full load and change data capture (CDC) data in comma-separated value (.csv) format. For more compact storage and faster query options, this pattern uses the Apache Parquet (.parquet) format option.

## Prerequisites and limitations

### Prerequisites

- An active AWS account
- An AWS Identity and Access Management (IAM) role for the account with write, delete, and tag access to the target S3 bucket, and AWS DMS (dms.amazonaws.com) added as a trusted entity to this IAM role
- An on-premises Microsoft SQL Server database (or Microsoft SQL Server on an EC2 instance or an Amazon RDS for SQL Server database)

- Network connectivity between the virtual private cloud (VPC) on AWS and the on-premises network provided by AWS Direct Connect or a virtual private network (VPN)

## Limitations

- A VPC-enabled (gateway VPC) S3 bucket isn't currently supported in AWS DMS versions earlier than 3.4.7.
- Changes to the source table structure during full load are not supported.
- AWS DMS full large binary object (LOB) mode is not supported.

## Product versions

- Microsoft SQL Server versions 2005 or later for the Enterprise, Standard, Workgroup, and Developer editions.
- Support for Microsoft SQL Server version 2019 as a source is available in AWS DMS versions 3.3.2 and later.

## Architecture

### Source technology stack

- An on-premises Microsoft SQL Server database (or Microsoft SQL Server on an EC2 instance or an Amazon RDS for SQL Server database)

### Target technology stack

- AWS Direct Connect
- AWS DMS
- Amazon S3

### Target architecture

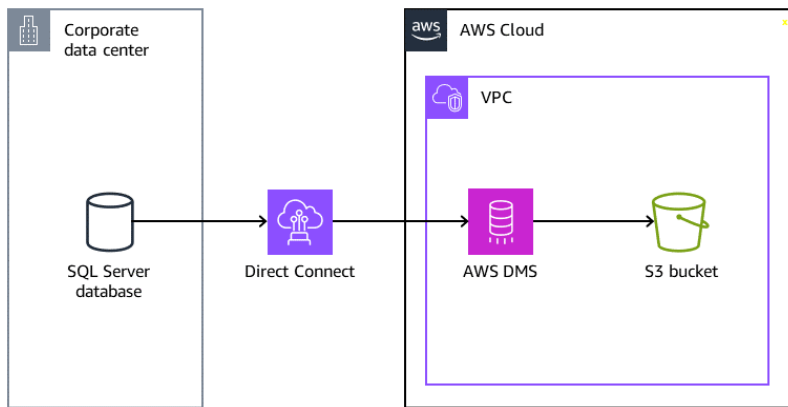

## Tools

- [AWS Database Migration Service \(AWS DMS\)](#) helps you migrate data stores into the AWS Cloud or between combinations of cloud and on-premises setups.
- [AWS Direct Connect](#) links your internal network to a Direct Connect location over a standard Ethernet fiber-optic cable. With this connection, you can create virtual interfaces directly to public AWS services while bypassing internet service providers in your network path.
- [Amazon Simple Storage Service \(Amazon S3\)](#) is a cloud-based object storage service that helps you store, protect, and retrieve any amount of data.

## Epics

### Prepare for the migration

Task	Description	Skills required
Validate the database version.	Validate the source database version and make sure that it's supported by AWS DMS. For information about supported SQL Server database versions, see <a href="#">Using a Microsoft SQL Server database as a source for AWS DMS</a> .	DBA

Task	Description	Skills required
Create a VPC and security group.	In your AWS account, create a VPC and security group. For more information, see the <a href="#">Amazon VPC documentation</a> .	System Administrator
Create a user for the AWS DMS task.	Create an AWS DMS user in the source database and grant it READ permissions. This user will be used by AWS DMS.	DBA
Test the DB connectivity.	Test the connectivity to the SQL Server DB instance from the AWS DMS user.	DBA
Create an S3 bucket.	Create the target S3 bucket. This bucket will hold the migrated table data.	Systems administrator
Create an IAM policy and role.	<ol style="list-style-type: none"> <li>To create an IAM policy with bucket permissions, use the code in the <i>Additional information</i> section.</li> <li>Create the role for AWS DMS, and attach the policy to the role.</li> </ol>	Systems administrator

## Migrate data by using AWS DMS

Task	Description	Skills required
Create an AWS DMS replication instance.	Sign in to the AWS Management Console, and open the AWS DMS console.	DBA

Task	Description	Skills required
	In the navigation pane, choose <b>Replication instances</b> , <b>Create replication instance</b> . For instructions, see <a href="#">step 1</a> in the AWS DMS documentation.	
Create source and target endpoints.	Create source and target endpoints. Test the connection from the replication instance to both source and target endpoints. For instructions, see <a href="#">step 2</a> in the AWS DMS documentation.	DBA
Create a replication task.	Create a replication task, and select full load or full load with change data capture (CDC) to migrate data from SQL Server to the S3 bucket. For instructions, see <a href="#">step 3</a> in the AWS DMS documentation.	DBA
Start the data replication.	Start the replication task, and monitor the logs for any errors.	DBA

## Validate the data

Task	Description	Skills required
Validate the migrated data.	On the console, navigate to your target S3 bucket. Open the subfolder that has the same name as the source database. Confirm that the	DBA

Task	Description	Skills required
	folder contains all the tables that were migrated from the source database.	

## Clean up resources

Task	Description	Skills required
Shut down and delete temporary AWS resources.	Shut down temporary AWS resources that you created for the data migration, such as the AWS DMS replication instance, and delete them after you validate the export.	DBA

## Related resources

- [AWS Database Migration Service User Guide](#)
- [Using a Microsoft SQL Server database as a source for AWS DMS](#)
- [Using Amazon S3 as a target for AWS Database Migration Service](#)
- [Using an S3 bucket as an AWS DMS target \(AWS re:Post\)](#)

## Additional information

Use the following code to add an IAM policy with S3 bucket permissions for the AWS DMS role. Replace bucketname with the name of your bucket.

```
{
  "Version": "2012-10-17",
  "Statement": [
    {
      "Effect": "Allow",
      "Action": [
        "s3:PutObject",
```



```
        "s3:DeleteObject"
    ],
    "Resource": [
        "arn:aws:s3:::bucketname*"
    ]
},
{
    "Effect": "Allow",
    "Action": [
        "s3:ListBucket"
    ],
    "Resource": [
        "arn:aws:s3:::bucketname*"
    ]
}
]
```

# Migrate ML Build, Train, and Deploy workloads to Amazon SageMaker using AWS Developer Tools

Created by Scot Marvin (AWS)

<b>R Type:</b> Replatform	<b>Source:</b> Machine Learning	<b>Target:</b> Amazon SageMaker
<b>Created by:</b> AWS	<b>Environment:</b> PoC or pilot	<b>Technologies:</b> Machine learning & AI; DevOps; Migration
<b>AWS services:</b> Amazon SageMaker		

## Summary

This pattern provides guidance for migrating an on-premises machine learning (ML) application running on Unix or Linux servers to be trained and deployed on AWS using Amazon SageMaker. This deployment uses a continuous integration and continuous deployment (CI/CD) pipeline. The migration pattern is deployed using an AWS CloudFormation stack.

## Prerequisites and limitations

### Prerequisites

- An active AWS account using [AWS Landing Zone](#)
- [AWS Command Line Interface \(AWS CLI\)](#) installed and configured on your Unix or Linux server
- An ML source code repository in either GitHub, AWS CodeCommit, or Amazon Simple Storage Service (Amazon S3)

### Limitations

- Only 300 individual pipelines can be deployed in one AWS Region.
- This pattern is intended for supervised ML workloads with train-and-deploy code in Python.

## Product versions

- Docker version 19.03.5, build 633a0ea, using Python 3.6x

## Architecture

### Source technology stack

- On-premises Linux compute instance with data on either the local file system or in a relational database

### Source architecture

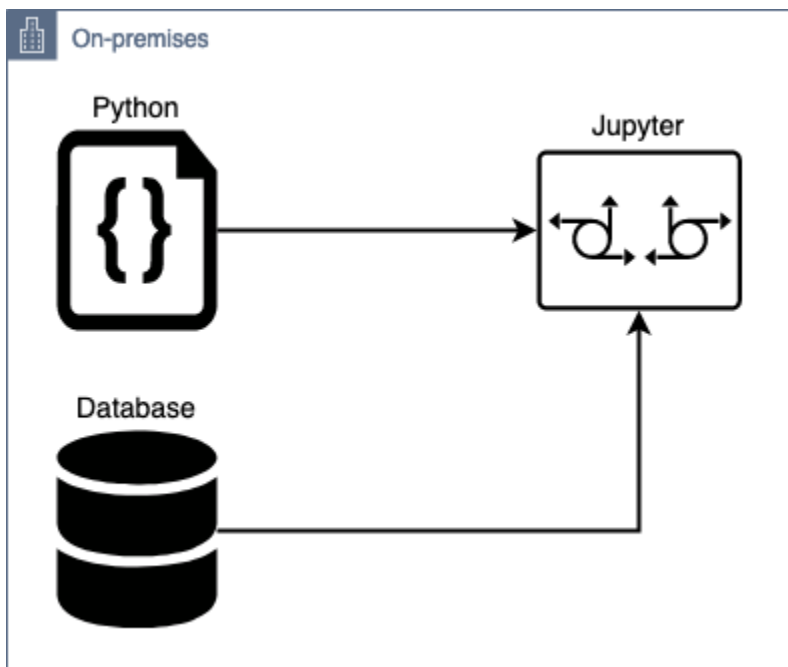

### Target technology stack

- AWS CodePipeline deployed with Amazon S3 for data storage and Amazon DynamoDB as metadata store for tracking or logging pipeline runs

### Target architecture

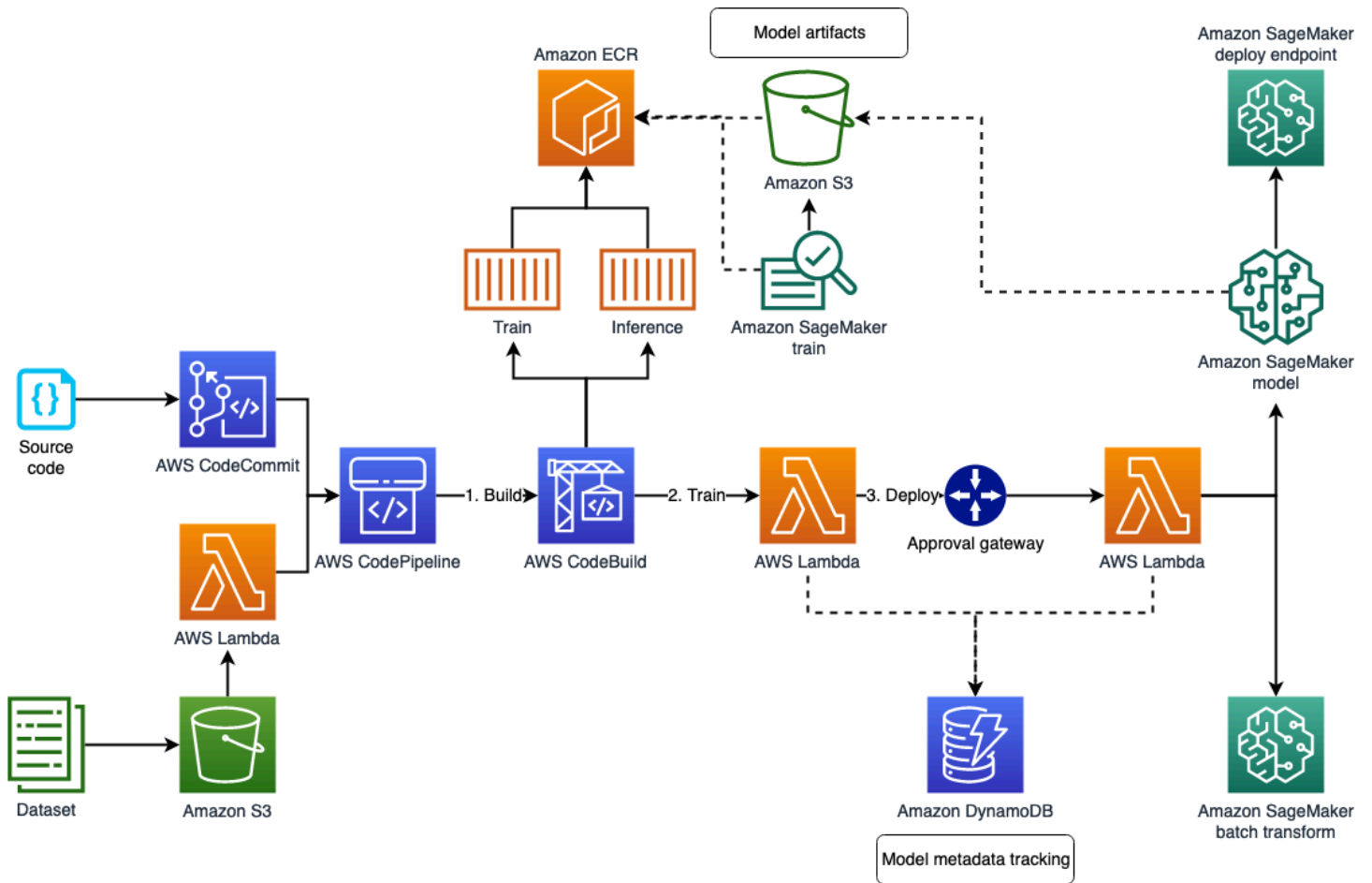

### Application migration architecture

- Native Python package and AWS CodeCommit repository (and an SQL client, for on-premises datasets on database instance)

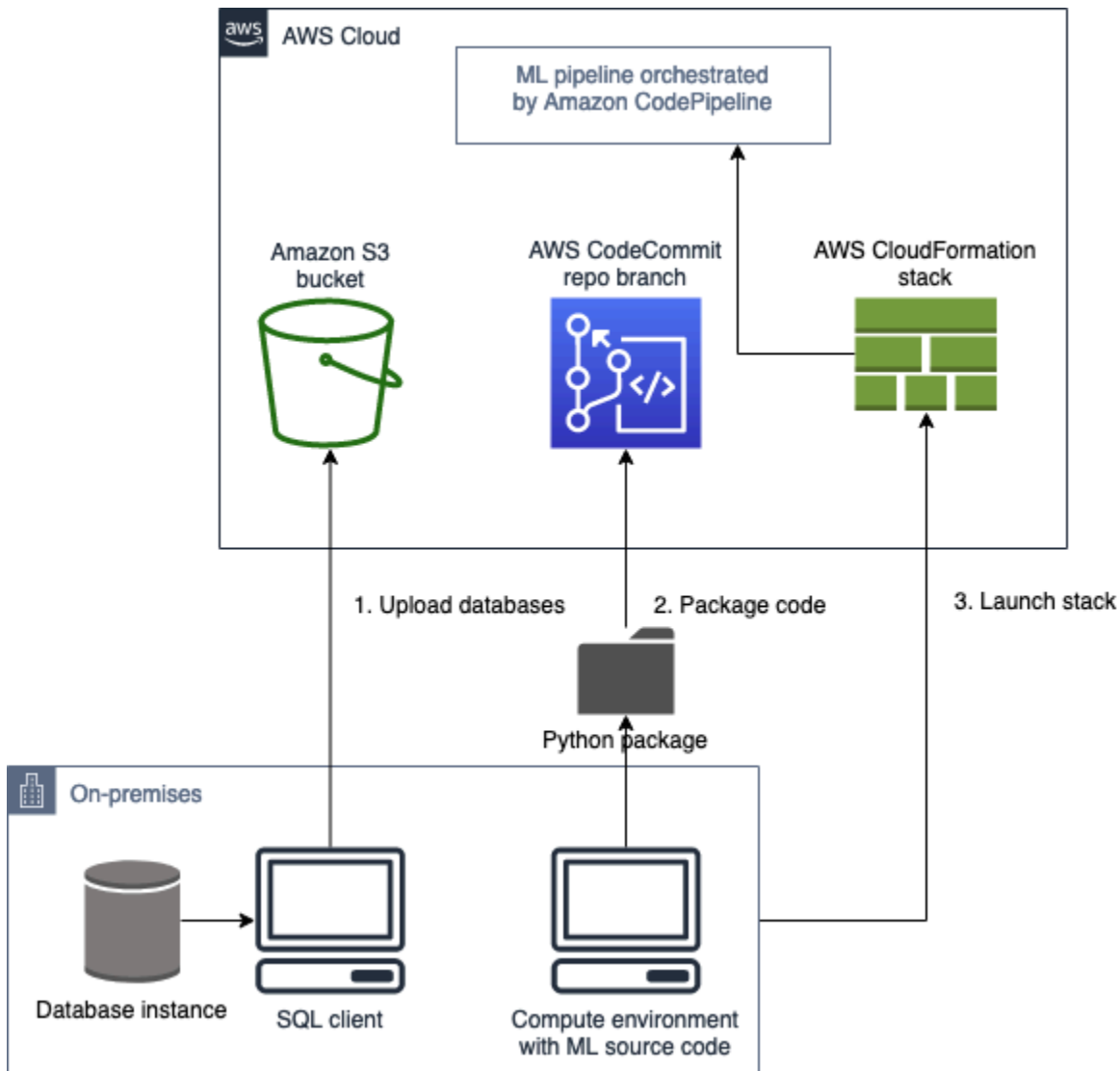

## Tools

- Python
- Git
- AWS CLI – The [AWS CLI](#) deploys the AWS CloudFormation stack and moves data to the S3 bucket. The S3 bucket, in turn, leads to the target.

## Epics

### Plan the migration

Task	Description	Skills required
Validate source code and datasets.		Data scientist
Identify target build, train, and deployment instance types and sizes.		Data engineer, Data scientist
Create capability list and capacity requirements.		
Identify network requirements.		DBA, Systems administrator
Identify the network or host access security requirements for the source and target applications.		Data engineer, ML engineer, Systems administrator
Determine backup strategy.		ML engineer, Systems administrator
Determine availability requirements.		ML engineer, Systems administrator
Identify the application migration or switchover strategy.		Data scientist, ML engineer

## Configure the infrastructure

Task	Description	Skills required
Create a virtual private cloud (VPC).		ML engineer, Systems administrator
Create security groups.		ML engineer, Systems administrator
Set up an Amazon S3 bucket and AWS CodeCommit repository branches for ML code.		ML engineer

## Upload the data and code

Task	Description	Skills required
Use native MySQL tools or third-party tools to migrate train, validate, and test datasets to provisioned S3 bucket.	This is required for AWS CloudFormation stack deployment.	Data engineer, ML engineer
Package the ML train and hosting code as Python packages and push to the provisioned repository in AWS CodeCommit or GitHub.	You need the repository's branch name to deploy the AWS CloudFormation template for migration.	Data scientist, ML engineer

## Migrate the application

Task	Description	Skills required
Follow the ML workload migration strategy.		Application owner, ML engineer
Deploy the AWS CloudFormation stack.	Use the AWS CLI to create the stack declared in the YAML template provided with this solution.	Data scientist, ML engineer

## Cut over

Task	Description	Skills required
Switch the application clients over to the new infrastructure.		Application owner, Data scientist, ML engineer

## Close the project

Task	Description	Skills required
Shut down the temporary AWS resources.	Shut down any custom resources from the AWS CloudFormation template (for example, any AWS Lambda functions that aren't being used).	Data scientist, ML engineer
Review and validate the project documents.		Application owner, Data scientist



Task	Description	Skills required
Validate the results and the ML model evaluation metrics with operators.	Make sure that model performance matches the application users' expectations and is comparable to the on-premises state.	Application owner, Data scientist
Close out the project and provide feedback.		Application owner, ML engineer

## Related resources

- [AWS CodePipeline](#)
- [AWS CodeBuild](#)
- [Amazon SageMaker](#)
- [Amazon S3](#)
- [Amazon DynamoDB](#)
- [AWS Lambda](#)

## Attachments

To access additional content that is associated with this document, unzip the following file: [attachment.zip](#)

# Migrate OpenText TeamSite workloads to the AWS Cloud

Created by Battulga Purevragchaa (AWS), Michael Stewart, and Carlos Marruenda Molina

<b>Environment:</b> Production	<b>Source:</b> On premises	<b>Target:</b> AWS
<b>R Type:</b> Replatform	<b>Workload:</b> All other workloads	<b>Technologies:</b> Migration; Web & mobile apps
<b>AWS services:</b> Amazon EC2; Amazon RDS		

## Summary

**Warning:** This scenario requires IAM users with programmatic access and long-term credentials, which presents a security risk. To help mitigate this risk, we recommend that you provide these users with only the permissions they require to perform the task and that you remove these users when they are no longer needed. Access keys can be updated if necessary. For more information, see [Updating access keys](#) in the *IAM user guide*.

Many [OpenText Experience Platform](#) instances are hosted on premises or on traditional hosting solutions with fixed capacity and legacy cost models. Migrating your OpenText Experience Platform workloads to the Amazon Web Services (AWS) Cloud provides additional capabilities and value by increasing your business agility and integration opportunities, in addition to reducing your overall ownership cost.

This pattern provides steps and a template to migrate [OpenText TeamSite](#) workloads to the AWS Cloud. The pattern helps you understand how to scope and budget your migration projects by providing a detailed *Epics* section that guides you through an OpenText TeamSite migration process.

This pattern was developed by AWS and [TBSCG](#), an AWS Partner, and accompanies the guide [Migrating OpenText TeamSite and Media Management workloads to the AWS Cloud](#) on the AWS Prescriptive Guidance website.

## Prerequisites and limitations

### Prerequisites

- At least one active AWS account
- An OpenText workload hosted in an on-premises data center or on another cloud provider
- Active OpenText licenses

The migration process also requires the roles and responsibilities that are described in the following table.

<b>Role</b>	<b>Responsibilities</b>
Sponsor	Internal sponsorship
Delivery manager	Migration delivery
Solutions architect	Define the current and new architecture
DevOps engineer	DevOps activities
QA tester	System-level testing
Product owner	Task prioritization based on business requirements
TeamSite authors	Migration user acceptance testing (UAT)
TeamSite administrator	Migration UAT
OpenText lead	OpenText product specialist
OpenText developer	OpenText product specialist
Pricing specialist	AWS and OpenText licensing
IT security	IT security baseline
Third-party integration developer	Rework existing integrations
Front-end developer	Make changes to migrated front-end code

Database administrator

Database configuration

## Limitations

- Ensure compatibility with your target operating systems (OSs). You can use the compatibility matrix from the product release notes of the OpenText product version that you are migrating.

## Architecture

### Source technology stack

- OpenText customer experience solutions hosted on premises or on another cloud provider:
  - OpenText TeamSite
  - OpenText LiveSite
  - OpenText Media Management
  - OpenText MediaBin

### Target technology stack

- An OpenText Customer Experience platform hosted on the AWS Cloud and that uses the following AWS services:
  - Amazon Elastic Compute Cloud (Amazon EC2)
  - Amazon Elastic Container Service (Amazon ECS)
  - Amazon OpenSearch Service
  - Elastic Load Balancing
  - AWS Lambda
  - Amazon API Gateway
  - Amazon Relational Database Service (Amazon RDS)
  - Amazon Elastic Block Store (Amazon EBS)
  - Amazon Simple Storage Service (Amazon S3)

### Target architecture

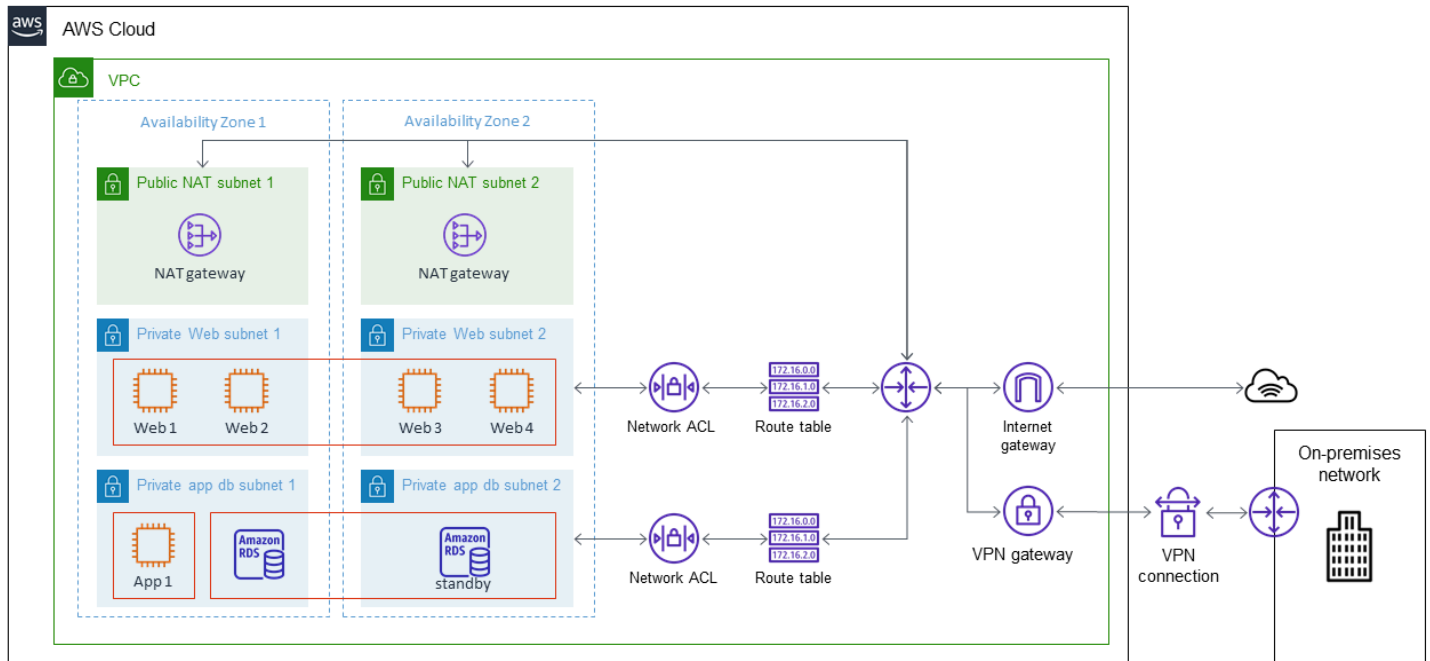

## Tools

- [AWS Database Migration Service \(AWS DMS\)](#) is a cloud service that makes it easy to migrate relational databases, data warehouses, NoSQL databases, and other types of data stores.
- [AWS Application Migration Service](#) automates the conversion of your source servers to run natively on AWS. It also simplifies application modernization with built-in and custom optimization options.

## Epics

### Discovery and assessment

Task	Description	Skills required
Hold workshops on discovery requirements.	Hold workshops with business and technical teams to discover the current landscape, gather requirements, and validate the migration strategy.	Sponsor (optional), Delivery manager, Solutions architect , OpenText lead, Product owner

Task	Description	Skills required
	<p>Depending on your migration's complexity and scope, your organization might require several workshops.</p> <p><b>Duration:</b> Two weeks</p>	
Analyze solution and migration requirements.	<p>Analyze and document the business, functional, and technical requirements that influence the design of the planned solution and migration process.</p> <p><b>Duration:</b> One week</p>	Solutions architect, OpenText lead, Product owner
Document your existing OpenText architecture.	<p>Document your existing OpenText architecture, including core components and all related applications and services.</p> <p><b>Duration:</b> One week</p>	Solutions architect, OpenText lead, Product owner
Define the planned AWS architecture.	<p>Define your planned AWS architecture based on the identified components, requirements, and using the OpenText compatibility matrix. You can find the OpenText compatibility matrix in the release notes of your OpenText TeamSite version.</p> <p><b>Duration:</b> One week</p>	Solutions architect, OpenText lead, Product owner, IT security

Task	Description	Skills required
Assess the size of your planned AWS architecture.	<p>Size requirements vary for different architectural components depending on the workload and other non-functional requirements.</p> <p><b>Duration:</b> Two days</p>	Solutions architect, OpenText lead
Calculate the TCO.	<p>Calculate the total cost of ownership (TCO) for your proposed solution.</p> <p><b>Duration:</b> Two days</p>	Solutions architect, Pricing specialist
Define the migration strategy for each component.	<p>Define and document which of the seven common migration strategies (7 Rs) to use for each core or additional component that must be migrated to the AWS Cloud.</p> <p><b>Duration:</b> One week</p>	Solutions architect, OpenText lead, Product owner
Define the migration process for the components.	<p>Define the detailed migration process for each of your workload's components.</p> <p><b>Duration:</b> One week</p>	Solutions architect, OpenText lead, Product owner, IT security
Define the global migration process and dependencies.	<p>Create a global migration process and calendar that includes the migration details for components, dependencies, and business continuity.</p> <p><b>Duration:</b> Three days</p>	Solutions architect, OpenText lead, Product owner, IT security

## Security and compliance activities

Task	Description	Skills required
Create security policies.	<p>Configure the customer managed security policies in your AWS accounts. These should include password complexity and rotation, in addition to automatically turning off unused accounts.</p> <p>For more information about customer managed policies, see <a href="#">Customer managed policies</a> in the AWS Identity and Access Management (IAM) documentation.</p>	Solutions architect
Create IAM users.	<p>Create the IAM users that require access to the AWS Management Console, AWS Command Line Interface (AWS CLI), and AWS SDK.</p> <p>For more information about creating IAM users, see <a href="#">Creating an IAM user in your AWS account</a> in the IAM documentation.</p>	Solutions architect
Create IAM groups.	<p>Create the required IAM user groups (for example, administrator or developer groups) and add IAM users to those groups.</p>	Solutions architect



Task	Description	Skills required
	For more information about IAM user groups, see <a href="#">IAM user groups</a> in the IAM documentation.	
Attach security policies.	Attach security policies to the IAM groups or roles.  For more information about this, see <a href="#">Attaching a policy to an IAM user group</a> in the IAM documentation.	Solutions architect
Turn on detailed billing.	For more information about billing, see <a href="#">Monitoring your usage and costs</a> in the AWS Billing and Cost Management documentation.	Solutions architect
Check the contact details for your accounts.	Make sure that the contact details for your accounts are up to date and map to more than one individual in your organization.  For more information, see <a href="#">Managing an AWS account</a> in the AWS Billing and Cost Management documentation.	Solutions architect, Product owner

Task	Description	Skills required
Add security contact information.	<p>Configure your contact information with your security contact information.</p> <p>For more information about this, see <a href="#">Managing an AWS account</a> in the AWS Billing and Cost Management documentation.</p>	Solutions architect, IT security
Set up IAM roles for EC2 instances.	<p>Configure the IAM roles for the EC2 instances.</p> <p>For more information about this, see <a href="#">IAM roles for Amazon EC2</a> in the Amazon EC2 documentation.</p>	Solutions architect
Configure access to AWS Support.	<p>Attach an IAM policy to IAM users that require access to AWS Support for Support Center and to create support cases.</p> <p>For more information about this, see <a href="#">Access permissions for AWS Support</a> in the AWS Support documentation.</p>	Solutions architect

Task	Description	Skills required
Enable CloudTrail.	<p>Automatically enable AWS CloudTrail in all your AWS Regions.</p> <p>For more information about this, see <a href="#">Using create-trail</a> in the AWS CloudTrail documentation.</p>	Solutions architect
Enable CloudTrail log file validation.	<p>Enable the validation of CloudTrail log files.</p> <p>For more information about this, see <a href="#">Enabling log file integrity validation for CloudTrail</a> in the AWS CloudTrail documentation.</p>	Solutions architect
Restrict access to any S3 buckets that contain CloudTrail logs.	<p>Apply a bucket policy restricting access to S3 buckets that contain CloudTrail log files.</p> <p>For more information about this, see <a href="#">Amazon S3 bucket policy for CloudTrail</a> in the AWS CloudTrail documentation.</p>	Solutions architect
Integrate CloudTrail with CloudWatch Logs	<p>Integrate trails generated by CloudTrail with Amazon CloudWatch Logs.</p> <p>For more information about this, see <a href="#">Sending events to CloudWatch Logs</a> in the AWS CloudTrail documentation</p>	Solutions architect

Task	Description	Skills required
Enable AWS Config in all required Regions.	<p>Automatically enable AWS Config in all required Regions.</p> <p>You can set up AWS Config by using AWS CLI. For more information, see <a href="#">Setting Up AWS Config with the AWS CLI</a> in the AWS Config documentation.</p>	Solutions architect
Enable logging of S3 bucket access.	<p>Automate S3 bucket access logging with CloudTrail.</p> <p>For more information about this, see <a href="#">Enabling CloudTrail event logging for S3 buckets and objects</a> in the Amazon S3 documentation.</p>	Solutions architect
Configure AWS KMS key policies for CloudTrail.	<p>Automate the configuration of AWS Key Management Service (AWS KMS) key policies for CloudTrail.</p> <p>For more information about this, see <a href="#">Configure AWS KMS key policies for CloudTrail</a> in the AWS CloudTrail documentation.</p>	Solutions architect

Task	Description	Skills required
Encrypt CloudTrail logs at rest.	<p>Configure server-side encryption of CloudTrail logs using customer managed keys held in AWS KMS.</p> <p>For more information about this, see <a href="#">Encrypting CloudTrail log files with AWS KMS managed keys (SSE-KMS)</a> in the AWS CloudTrail documentation.</p>	Solutions architect
Automatically rotate KMS keys.	<p>Configure the rotation of AWS KMS keys.</p> <p>For more information about this, see <a href="#">How to enable and disable automatic key rotation</a> in the AWS KMS documentation.</p>	Solutions architect
Configure CloudWatch alarms.	<p>Configure the Amazon CloudWatch alarms that are initiated by specific events. For example, unauthorized requests to APIs or use of the root account.</p> <p>For more information about this, see <a href="#">How to receive notifications when your AWS account's root access keys are used</a> from the AWS Security Blog.</p>	Solutions architect

Task	Description	Skills required
Configure security groups.	Configure security groups to ensure that unrestricted inbound traffic is not allowed on ports 22 and 3389.	Solutions architect
Turn on VPC flow logging.	Capture rejected IP traffic to and from network interfaces in your virtual private cloud (VPC) and configure CloudWatch to capture it.  For more information about this, see <a href="#">Creating a flow log</a> in the Amazon VPC documentation.	Solutions architect
Modify the default security group to restrict all traffic.	Modify each VPC's default security group so that traffic is denied by default and access is explicitly granted through your security groups.  For more information about this, see <a href="#">Security groups for your VPC</a> in the Amazon VPC documentation.	Solutions architect
Configure routing tables between the VPCs.	Configure the routing tables for VPC peering with the least access necessary.  For more information about this, see <a href="#">Updating your route tables for a VPC peering connection</a> in the Amazon VPC documentation.	Solutions architect

## Setup activities for the new AWS infrastructure

Task	Description	Skills required
Provision the AWS infrastructure.	Create the AWS accounts and resources.  <b>Duration:</b> Two weeks	DevOps engineer, Solutions architect
Set up DevOps tools and processes.	Set up DevOps tools and procedures, such as continuous integration and continuous delivery (CI/CD) pipelines and automated testing frameworks.	DevOps engineer, Solutions architect
Automate the migration of core components.	Use existing templates or scripts to automate the installation and configuration of OpenText products including TeamSite, LiveSite, OpenDeploy and MediaBin.  <b>Duration:</b> One week	DevOps engineer, Solutions architect, OpenText lead
Automate the migration of additional components.	Analyze and automate the migration of additional applications that are integrated with OpenText core components (for example, additional databases, communication, monitoring, or cache components).  <b>Duration:</b> Two weeks	DevOps engineer, Solutions architect, OpenText lead
Adapt core components.	Make any required changes to customizations of OpenText	Solutions architect, OpenText lead, OpenText developer

Task	Description	Skills required
	core components (for example, integrations).	, Third-party integration developer, Front-end developer
Implement and configure additional services.	Provision, configure, and implement any new AWS services, such as AWS Lambda functions or Amazon API Gateway.	DevOps engineer, Solutions architect, Third-party integration developer, Front-end developer
Migrate or refactor other components.	Migrate additional components, including any required refactoring. This includes external applications such as custom-made reporting portals or existing API integration layers.	DevOps engineer, Solutions architect, Third-party integration developer, Front-end developer
Carry out migration in development environment.	Automated migration activities for the development environment, including system provisioning, data migration, application migration, installation, and configuration.	DevOps engineer
Carry out migration in production environment.	Automated migration activities for the production environment, including system provisioning, data migration, application migration, installation, and configuration.	DevOps engineer



## Networking activities

Task	Description	Skills required
Define CIDR blocks for each VPC.	Define the Classless Inter-Domain Routing (CIDR) block (the IP range and mask) for each non-default VPC.  <b>Duration:</b> Less than one week	DevOps engineer, Solutions architect
Define subnets and Availability Zones.	Define the subnets and Availability Zones that are used in each non-default VPC.  <b>Duration:</b> Less than one week	DevOps engineer, Solutions architect
Define security groups.	Define security groups and security group rules for controlling security on AWS resources.  <b>Duration:</b> Less than one week	DevOps engineer, Solutions architect
Define network ACLs.	Define the network access control lists (ACLs) to control security at subnet boundaries.  <b>Duration:</b> Less than one week	DevOps engineer, Solutions architect

## Migrate databases

Task	Description	Skills required
Prepare the source databases.	Use AWS DMS to prepare each source database for ongoing replication to the AWS Cloud.	DevOps engineer, Solutions architect

Task	Description	Skills required
Create the databases for the OpenText core components.	Create the databases required by the OpenText TeamSite, LiveSite, and MediaBin components. Make sure that users and access rights are correctly configured according to the OpenText installation documentation.	Solutions architect, OpenText lead, OpenText developer
Copy data from source database servers.	Automate the process of copying data for OpenText core components from the source database server to the target database server.	Solutions architect, OpenText lead, OpenText developer
Synchronize data from the database servers.	Automate the process of performing regular data synchronization from the source databases to the target databases.	OpenText developer

### Content migration activities

Task	Description	Skills required
Copy the OpenText TeamSite content stores.	Automate the process of copying the content stores from the source OpenText TeamSite server to the target OpenText TeamSite server.	Solutions architect, OpenText lead, OpenText developer
Map users and groups.	Internal mapping of internal OpenText TeamSite user IDs to target system IDs.	OpenText lead

Task	Description	Skills required
Synchronize the OpenText TeamSite content stores.	Automate the process of performing regular synchronizing of source and target content stores. This is implemented as part of the migration and QA process.	OpenText developer
Copy data from web servers.	Automate the process of copying data from the source web servers to the target web servers.	Solutions architect, OpenText lead, OpenText developer
Synchronize the web server data.	Automate the process of performing regular synchronizing of source and target web server data.	OpenText developer
Copy data from web server file system.	Automate the process of copying content and other web assets from the source web server file system to the target web servers.	Solutions architect, OpenText lead, OpenText developer
Synchronize the web server file systems.	Automate the process of performing regular synchronizing of content and other web assets from the source web server file system to the target web servers.	OpenText developer

Task	Description	Skills required
Generate feeds and indexes.	Automate the process of running any processes that generate feeds or other indexes (for example, web search) that uses OpenText TeamSite or web server content as a data source.	Solutions architect, OpenText lead, OpenText developer
Synchronize the generation of feeds and indexes.	Automate the process of performing regular regeneration of feeds and indexes after data synchronizations.	OpenText developer

### Testing and QA activities

Task	Description	Skills required
Perform migration QA.	Test the target AWS environment, applications, and services to ensure the automated migration processes are correctly built and configured.	DevOps engineer, OpenText lead, QA tester
Carry out performance testing.	Test the performance in terms of responsiveness and stability under a particular workload. Investigate, measure, validate, or verify other quality attributes of the destination system, such as scalability and reliability.  For this test to be useful, you must have a testing	DevOps engineer, OpenText lead

Task	Description	Skills required
	<p>environment that is the same size as your production environment.</p> <p><b>Duration:</b> Between one and two weeks</p>	
Security testing.	<p>Vulnerability scanning and penetration testing to reveal potential flaws in the security mechanisms of an application that protect data and maintain functionality as required.</p> <p>For this test to be useful, you must have a testing environment that is equivalent to your production environment in terms of networking and security.</p> <p><b>Duration:</b> Between one and two weeks</p>	DevOps engineer, OpenText lead

## Operational integration activities

Task	Description	Skills required
Check operational readiness.	<p>Understand how you currently perform IT operations and how you will operate in the AWS Cloud. You can achieve this business outcome by defining a cloud operating model.</p>	DevOps engineer, OpenText lead, Service delivery manager

Task	Description	Skills required
	<b>Duration:</b> One week	
Invest in operations automation.	Invest in automation to deliver an AWS operating model.	DevOps engineer, OpenText lead, Service delivery manager
Integrate operations.	Continue using current IT tools and extend them through integration to the AWS Cloud.	DevOps engineer, OpenText lead, Service delivery manager

### Cutover activities

Task	Description	Skills required
Switch DNS.	Manually switch the domain name system (DNS) from existing hosts to hosts based in the AWS Cloud.  <b>Duration:</b> One hour	DevOps engineer, OpenText lead
Test disaster recovery.	Test disaster recovery, backup restore, and run your automated tests.  <b>Duration:</b> One day	DevOps engineer, OpenText lead, QA tester
Validate monitoring and analytics.	Validate that the monitoring and analytics are working.  <b>Duration:</b> Two hours	DevOps engineer, OpenText lead
Turn off old environment and request the server's shutdown.	<b>Duration:</b> Three days	DevOps engineer, OpenText lead

## Related resources

- [Customer managed policies](#)
- [Creating an IAM user in your AWS account](#)
- [IAM user groups](#)
- [Attaching a policy to an IAM user group](#)
- [Monitoring your usage and cost](#)
- [Managing an AWS account](#)
- [IAM roles for Amazon EC2](#)
- [Access permissions for AWS Support](#)
- [Using create-trail](#)
- [Enabling log file integrity validation for CloudTrail](#)
- [Amazon S3 bucket policy for CloudTrail](#)
- [Sending events to CloudWatch Logs](#)
- [Setting Up AWS Config with the AWS CLI](#)
- [Enabling CloudTrail event logging for S3 buckets and objects](#)
- [Configure AWS KMS key policies for CloudTrail](#)
- [Encrypting CloudTrail log files with AWS KMS managed keys \(SSE-KMS\)](#)
- [How to enable and disable automatic key rotation](#)
- [How to receive notifications when your AWS account's root access keys are used](#)
- [Creating a flow log](#)
- [Security groups for your VPC](#)
- [Updating your route tables for a VPC peering connection](#)

# Migrate Oracle CLOB values to individual rows in PostgreSQL on AWS

Created by Sai Krishna Namburu (AWS) and Sindhusa Paturu (AWS)

<b>Environment:</b> PoC or pilot	<b>Source:</b> Oracle Database	<b>Target:</b> Aurora PostgreSQL-Compatible or Amazon RDS for PostgreSQL
<b>R Type:</b> Replatform	<b>Workload:</b> Oracle; Open-source	<b>Technologies:</b> Migration; Storage & backup; Databases
<b>AWS services:</b> Amazon Aurora; AWS DMS; Amazon S3; Amazon RDS		

## Summary

This pattern describes how to split Oracle character large object (CLOB) values into individual rows in Amazon Aurora PostgreSQL-Compatible Edition and Amazon Relational Database Service (Amazon RDS) for PostgreSQL. PostgreSQL doesn't support the CLOB data type.

Tables with interval partitions are identified in the source Oracle database, and the table name, the type of partition, the interval of the partition, and other metadata are captured and loaded into the target database. You can load CLOB data that is less than 1 GB in size into target tables as text by using AWS Database Migration Service (AWS DMS), or you can export the data in CSV format, load it into an Amazon Simple Storage Service (Amazon S3) bucket, and migrate it to your target PostgreSQL database.

After migration, you can use the custom PostgreSQL code that is provided with this pattern to split the CLOB data into individual rows based on the new line character identifier (`CHR(10)`) and populate the target table.

## Prerequisites and limitations

### Prerequisites

- An Oracle database table that has interval partitions and records with a CLOB data type.



- An Aurora PostgreSQL-Compatible or Amazon RDS for PostgreSQL database that has a table structure that's similar to the source table (same columns and data types).

## Limitations

- The CLOB value cannot exceed 1 GB.
- Each row in the target table must have a new line character identifier.

## Product versions

- Oracle 12c
- Aurora Postgres 11.6

## Architecture

The following diagram shows a source Oracle table with CLOB data, and the equivalent PostgreSQL table in Aurora PostgreSQL-Compatible version 11.6.

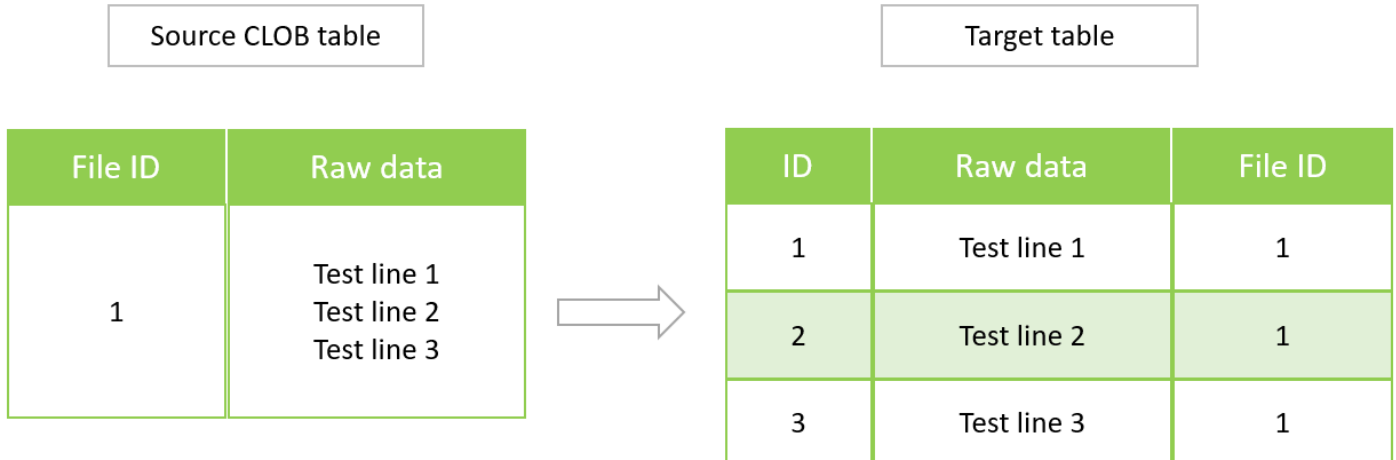

## Tools

### AWS services

- [Amazon Aurora PostgreSQL-Compatible Edition](#) is a fully managed, ACID-compliant relational database engine that helps you set up, operate, and scale PostgreSQL deployments.

- [Amazon Relational Database Service \(Amazon RDS\) for PostgreSQL](#) helps you set up, operate, and scale a PostgreSQL relational database in the AWS Cloud.
- [AWS Database Migration Service \(AWS DMS\)](#) helps you migrate data stores into the AWS Cloud or between combinations of cloud and on-premises setups.
- [Amazon Simple Storage Service \(Amazon S3\)](#) is a cloud-based object storage service that helps you store, protect, and retrieve any amount of data.

## Other tools

You can use the following client tools to connect to, access, and manage your Aurora PostgreSQL-Compatible and Amazon RDS for PostgreSQL databases. (These tools aren't used within this pattern.)

- [pgAdmin](#) is an open-source management tool for PostgreSQL. It provides a graphical interface that helps you create, maintain, and use database objects.
- [DBBeaver](#) is an open-source database tool for developers and database administrators. You can use the tool to manipulate, monitor, analyze, administer, and migrate your data.

## Best practices

For best practices for migrating your database from Oracle to PostgreSQL, see the AWS blog post [Best practices for migrating an Oracle database to Amazon RDS PostgreSQL or Amazon Aurora PostgreSQL: Migration process and infrastructure considerations](#).

For best practices for configuring the AWS DMS task for migrating large binary objects, see [Migrating large binary objects \(LOBs\)](#) in the AWS DMS documentation.

## Epics

### Identify the CLOB data

Task	Description	Skills required
Analyze the CLOB data.	In the source Oracle database, analyze the CLOB data to see whether it contains column headers, so you can	Developer

Task	Description	Skills required
	<p>determine the method for loading the data into the target table.</p> <p>To analyze the input data, use the following query.</p> <pre>SELECT * FROM clobdata_or;</pre>	
Load the CLOB data to the target database.	<p>Migrate the table that has CLOB data to an interim (staging) table in the Aurora or Amazon RDS target database. You can use AWS DMS or upload the data as a CSV file to an Amazon S3 bucket.</p> <p>For information about using AWS DMS for this task, see <a href="#">Using an Oracle database as a source</a> and <a href="#">Using a PostgreSQL database as a target</a> in the AWS DMS documentation.</p> <p>For information about using Amazon S3 for this task, see <a href="#">Using Amazon S3 as a target</a> in the AWS DMS documentation.</p>	Migration engineer, DBA

Task	Description	Skills required
Validate the target PostgreSQL table.	<p>Validate the target data, including headers, against the source data by using the following queries in the target database.</p> <pre>SELECT * FROM clobdata_pg; SELECT * FROM clobdatatarget;</pre> <p>Compare the results against the query results from the source database (from the first step).</p>	Developer
Split the CLOB data into separate rows.	<p>Run the custom PostgreSQL code provided in the <a href="#">Additional information</a> section to split the CLOB data and insert it into separate rows in the target PostgreSQL table.</p>	Developer

### Validate the data.

Task	Description	Skills required
Validate the data in the target table.	<p>Validate the data inserted into the target table by using the following queries.</p> <pre>SELECT * FROM clobdata_pg;</pre>	Developer

Task	Description	Skills required
	<pre>SELECT * FROM clobdatat arget;</pre>	

## Related resources

- [CLOB data type](#) (Oracle documentation)
- [Data types](#) (PostgreSQL documentation)

## Additional information

### PostgreSQL function for splitting CLOB data

```
do
$$
declare
totalstr varchar;
str1 varchar;
str2 varchar;
pos1 integer := 1;
pos2 integer ;
len integer;

begin
    select rawdata||chr(10) into totalstr from clobdata_pg;
    len := length(totalstr) ;
    raise notice 'Total length : %',len;
    raise notice 'totalstr : %',totalstr;
    raise notice 'Before while loop';

    while pos1 < len loop

        select position (chr(10) in totalstr) into pos2;
        raise notice '1st position of new line : %',pos2;
```

```

        str1 := substring (totalstr,pos1,pos2-1);
        raise notice 'str1 : %',str1;

        insert into clobdatatarget(data) values (str1);
        totalstr := substring(totalstr,pos2+1,len);
        raise notice 'new totalstr :%',totalstr;
        len := length(totalstr) ;

    end loop;
end
$$
LANGUAGE 'plpgsql' ;

```

## Input and output examples

You can use the following examples to try out the PostgreSQL code before you migrate your data.

Create an Oracle database with three input lines.

```

CREATE TABLE clobdata_or (
id INTEGER GENERATED ALWAYS AS IDENTITY,
rawdata clob );

insert into clobdata_or(rawdata) values (to_clob('test line 1') || chr(10) ||
to_clob('test line 2') || chr(10) || to_clob('test line 3') || chr(10));
COMMIT;

SELECT * FROM clobdata_or;

```

This displays the following output.

id	rawdata
1	test line 1 test line 2 test line 3

Load the source data into a PostgreSQL staging table (clobdata\_pg) for processing.

```
SELECT * FROM clobdata_pg;  
  
CREATE TEMP TABLE clobdatatarget (id1 SERIAL,data VARCHAR );  
  
<Run the code in the additional information section.>  
  
SELECT * FROM clobdatatarget;
```

This displays the following output.

id1	data
1	test line 1
2	test line 2
3	test line 3

# Migrate an on-premises Oracle database to Amazon RDS for Oracle by using direct Oracle Data Pump Import over a database link

Created by Rizwan Wangde (AWS)

<b>Environment:</b> Production	<b>Source:</b> On-premises Oracle database	<b>Target:</b> Amazon RDS for Oracle
<b>R Type:</b> Replatform	<b>Workload:</b> Oracle	<b>Technologies:</b> Migration; Databases
<b>AWS services:</b> AWS DMS; AWS Direct Connect; Amazon RDS		

## Summary

Numerous patterns cover migrating on-premises Oracle databases to Amazon RDS for Oracle by using Oracle Data Pump, a native Oracle utility that is the preferred way to migrate large Oracle workloads. These patterns typically involve exporting application schemas or tables into dump files, transferring the dump files to a database directory on Amazon RDS for Oracle, and then importing the application schemas and data from the dump files.

Using that approach, a migration can take longer depending on the size of the data and the time that it takes to transfer the dump files to the Amazon RDS instance. In addition, the dump files reside on the Amazon RDS instance's Amazon Elastic Block Store (Amazon EBS) volume, which must be large enough for the database and the dump files. When the dump files are deleted after import, the empty space cannot be retrieved, so you continue to pay for unused space.

This pattern mitigates those issues by performing a direct import on the Amazon RDS instance by using the Oracle Data Pump API (DBMS\_DATAPUMP) over a database link. The pattern initiates a simultaneous export and import pipeline between the source and target databases. This pattern doesn't require sizing an EBS volume for the dump files because no dump files are created or stored on the volume. This approach saves the monthly cost of unused disk space.

## Prerequisites and limitations

### Prerequisites



- An active Amazon Web Services (AWS) account.
- A virtual private cloud (VPC) configured with private subnets across at least two Availability Zones, to provide the network infrastructure for the Amazon RDS instance.
- An Oracle database in an on-premises data center.
- An existing [Amazon RDS Oracle](#) instance in a single Availability Zone. Using a single Availability Zone improves write performance during migration. A Multi-AZ deployment can be enabled 24–48 hours before cutover.
- [AWS Direct Connect](#) (recommended for large sized databases).
- Network connectivity and firewall rules on premises configured to allow an inbound connection from the Amazon RDS instance to the on-premises Oracle database.

## Limitations

- The database size limit on Amazon RDS for Oracle is 64 TiB (as of December 2022).

## Product versions

- Source database: Oracle Database version 10g Release 1 and later.
- Target database: For the latest list of supported versions and editions on Amazon RDS, see [Amazon RDS for Oracle](#) in the AWS documentation.

## Architecture

### Source technology stack

- Self-managed Oracle database on premises or in the cloud

### Target technology stack

- Amazon RDS for Oracle

### Target architecture

The following diagram shows the architecture for migrating from an on-premises Oracle database to Amazon RDS for Oracle in a Single-AZ environment. The arrow directions depict the data flow in the architecture. The diagram doesn't show what component is initiating the connection.

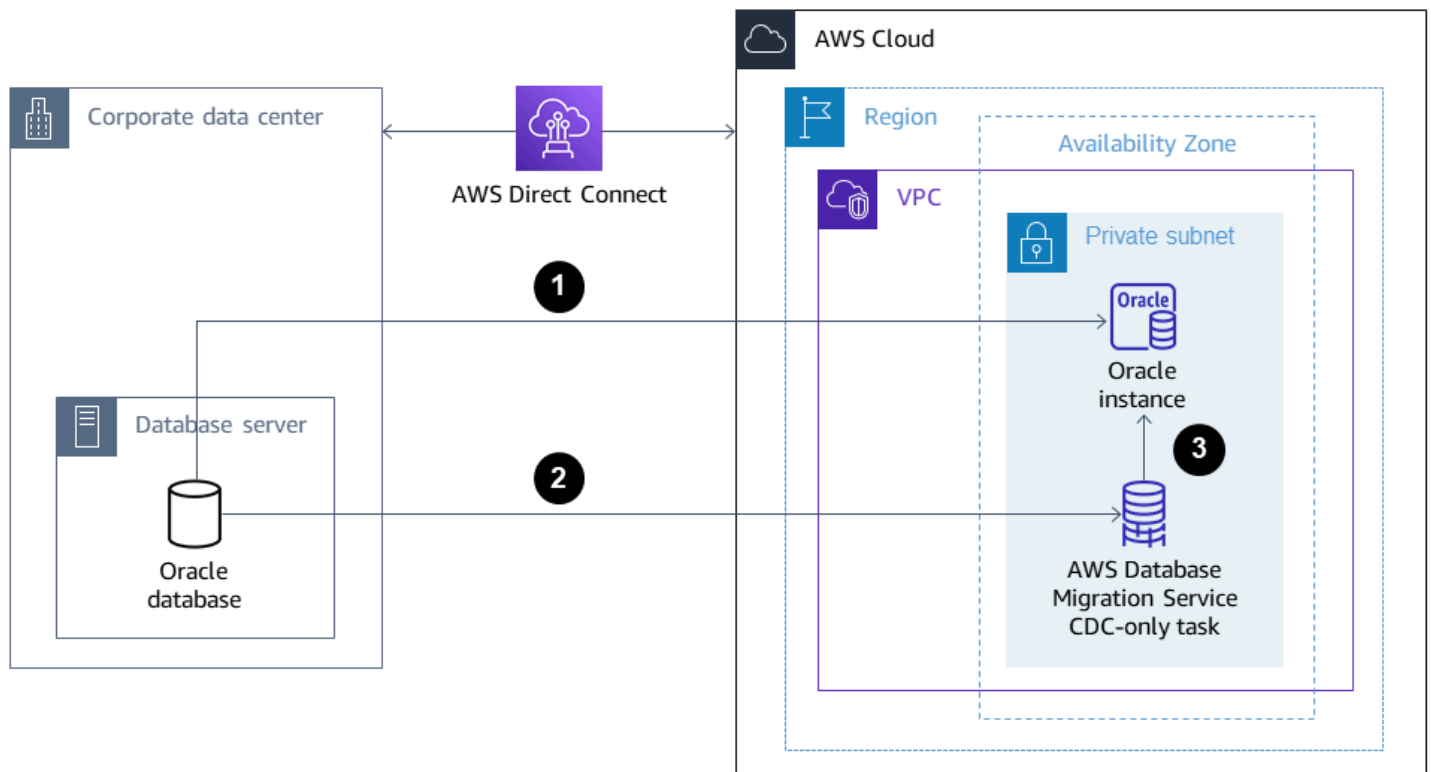

1. The Amazon RDS for Oracle instance connects to the on-premises source Oracle database to perform a full-load migration over the database link.
2. AWS DMS connects to the on-premises source Oracle database to perform ongoing replication by using change data capture (CDC).
3. CDC changes are applied to the Amazon RDS for Oracle database.

## Tools

### AWS services

- [AWS Database Migration Service \(AWS DMS\)](#) helps you migrate data stores into the AWS Cloud or between combinations of cloud and on-premises setups. This pattern uses CDC and the **Replicate data changes only** setting.
- [AWS Direct Connect](#) links your internal network to a Direct Connect location over a standard Ethernet fiber-optic cable. With this connection, you can create virtual interfaces directly to public AWS services while bypassing internet service providers in your network path.
- [Amazon Relational Database Service \(Amazon RDS\) for Oracle](#) helps you set up, operate, and scale an Oracle relational database in the AWS Cloud.

## Other tools

- [Oracle Data Pump](#) helps you move data and metadata from one database to another at high speeds.
- Client tools such as [Oracle Instant Client](#) or [SQL Developer](#) are used to connect and run SQL queries on the database.

## Best practices

Although [AWS Direct Connect](#) uses dedicated, private network connections between the on-premises network and AWS, consider the following options for additional security and data encryption for data in transit:

- [A virtual private network \(VPN\) using Amazon Site-to-Site VPN](#) or an IPsec VPN connection from the on-premises network to the AWS network
- [Oracle Database Native Network Encryption](#) configured on the on-premises Oracle database
- Encryption using [TLS](#)

## Epics

### Prepare the on-premises source Oracle database

Task	Description	Skills required
Set up network connectivity from the target database to the source database.	Configure the on-premises network and firewall to allow incoming connection from the target Amazon RDS instance to the on-premises source Oracle database.	Network administrator, Security engineer
Create a database user with the appropriate privileges.	Create a database user in the on-premises source Oracle database with privileges to migrate data between the source and target using Oracle Data Pump.	DBA

Task	Description	Skills required
	<pre>GRANT CONNECT to   &lt;migration_user&gt;; GRANT DATAPUMP_ EXP_FULL_DATABASE to   &lt;migration_user&gt;; GRANT SELECT ANY TABLE to &lt;migration_user&gt;;</pre>	

Task	Description	Skills required
<p>Prepare the on-premises source database for AWS DMS CDC migration.</p>	<p>(Optional) Prepare the on-premises source Oracle database for AWS DMS CDC migration after completion of Oracle Data Pump Full Load:</p> <ol style="list-style-type: none"> <li>1. Configure the additional privileges required to manage FLASHBACK during Oracle Data Pump migration.</li> </ol> <div data-bbox="630 758 1029 1039" style="border: 1px solid #ccc; border-radius: 10px; padding: 10px; margin: 10px 0;"> <pre>GRANT FLASHBACK ANY TABLE to &lt;migratio n_user&gt;; GRANT FLASHBACK ARCHIVE ADMINISTER to &lt;migration_user&gt;;</pre> </div> <ol style="list-style-type: none"> <li>2. To configure user account privileges required on a self-managed Oracle source for AWS DMS, see the <a href="#">AWS DMS documentation</a>.</li> <li>3. To prepare an Oracle self-managed source database for CDC using AWS DMS, see the <a href="#">AWS DMS documentation</a>.</li> </ol>	<p>DBA</p>
<p>Install and configure SQL Developer.</p>	<p>Install and configure <a href="#">SQL Developer</a> to connect and run SQL queries on the source and target databases.</p>	<p>DBA, Migration engineer</p>

Task	Description	Skills required
<p>Generate a script to create the tablespaces.</p>	<p>Use the following example SQL query to generate the script on the source database.</p> <pre data-bbox="594 394 1029 951">SELECT     'CREATE TABLESPACE E ' tablespace_name     ' DATAFILE SIZE 1G     AUTOEXTEND ON MAXSIZE     UNLIMITED;'     from dba_table spaces     where tablespac e_name not in ('SYSTEM' , 'SYSAUX', 'TEMP', 'U NDOTBS1')     order by 1;</pre> <p>The script will be applied on the target database.</p>	DBA
<p>Generate a script to create users, profiles, roles, and privileges.</p>	<p>To generate a script to create the database users, profiles, roles, and privileges, use the scripts from the Oracle Support document <a href="#">How to Extract DDL for User including Privileges and Roles Using dbms_metadata.get_ddl (Doc ID 2739952.1)</a> (Oracle account required).</p> <p>The script will be applied on the target database.</p>	DBA

## Prepare the target Amazon RDS for Oracle instance

Task	Description	Skills required
<p>Create a database link to the source database and verify connectivity.</p>	<p>To create a database link to the on-premises source database, you can use the following example command.</p> <pre data-bbox="594 541 1027 1178">CREATE DATABASE LINK   link2src   CONNECT TO &lt;migratio n_user_account&gt;   IDENTIFIED BY   &lt;password&gt;   USING '(DESCRIP TION=(ADDRESS=(PRO TOCOL=TCP)(HOST=&lt;dns or ip address of remote db&gt;)           (PORT=&lt;li stener port&gt;))(C ONNECT_DATA=(SID=&lt; remote SID&gt;)))';</pre> <p>To verify connectivity, run the following SQL command.</p> <pre data-bbox="594 1335 1027 1457">select * from dual@link 2src;</pre> <p>Connectivity is successful if the response is X.</p>	DBA
<p>Run the scripts to prepare the target instance.</p>	<p>Run the previously generated scripts to prepare the target Amazon RDS for Oracle instance:</p> <ol style="list-style-type: none"> <li>1. Tablespaces</li> </ol>	DBA, Migration engineer

Task	Description	Skills required
	<p>2. Profiles</p> <p>3. Roles</p> <p>This helps ensure that the Oracle Data Pump migration can create the schemas and their objects.</p>	

### Perform a full-load migration by using Oracle Data Pump Import over a database link

Task	Description	Skills required
Migrate the required schemas.	<p>To migrate the required schemas from the source on-premises database to the target Amazon RDS instance, use the code in the <i>Additional information</i> section:</p> <ul style="list-style-type: none"> <li>• To migrate a single schema, run <i>Code 1</i> from the <i>Additional information</i> section.</li> <li>• To migrate multiple schemas, run <i>Code 2</i> from the <i>Additional information</i> section.</li> </ul> <p>To tune the performance of the migration, you can adjust the number of parallel processes by running the following command.</p>	DBA



Task	Description	Skills required
	<pre>DBMS_DATAPUMP.SET_ PARALLEL (handle =&gt; v_hdn1, degree =&gt; 4);</pre>	
<p>Gather schema statistics to improve performance.</p>	<p>The Gather Schema Statistics command returns the Oracle query optimizer statistics gathered for database objects. By using this information, the optimizer can select the best execution plan for any query against these objects.</p> <pre>EXECUTE DBMS_STAT S.GATHER_SCHEMA_ST ATS(ownname =&gt; '&lt;schema_name&gt;');</pre>	DBA

## Perform a full-load migration and CDC replication by using Oracle Data Pump and AWS DMS

Task	Description	Skills required
<p>Capture the SCN on the source on-premises Oracle database.</p>	<p>Capture the <a href="#">system change number (SCN)</a> on the source on-premises Oracle database. You will use the SCN for full-load import and as the starting point for CDC replication.</p> <p>To generate the current SCN on the source database, run the following SQL statement.</p>	DBA

Task	Description	Skills required
	<pre>SELECT current_scn FROM V\$DATABASE;</pre>	

Task	Description	Skills required
Perform the full-load migration of the schemas.	<p>To migrate the required schemas (FULL LOAD) from the source on-premises database to the target Amazon RDS instance, do the following:</p> <ul style="list-style-type: none"><li>• To migrate a single schema, run <i>Code 3</i> from the <i>Additional information</i> section.</li><li>• To migrate multiple schemas, run <i>Code 4</i> from the <i>Additional information</i> section.</li></ul> <p>In the code, replace <code>&lt;CURRENT_SCN_VALUE_IN_SOURCE_DATABASE&gt;</code> with the SCN that you captured from the source database.</p> <pre>DBMS_DATAPUMP.SET_PARAMETER (handle =&gt; v_hdl, name =&gt; 'FLASHBACK_SCN', value =&gt; &lt;CURRENT_SCN_VALUE_IN_SOURCE_DATABASE&gt;);</pre> <p>To tune the performance of the migration, you can adjust the number of parallel processes.</p>	DBA

Task	Description	Skills required
	<pre>DBMS_DATAPUMP.SET_ PARALLEL (handle =&gt; v_hdn1, degree =&gt; 4);</pre>	
Disable the triggers under the migrated schemas.	Before you begin the AWS DMS CDC-only task, disable the TRIGGERS under the migrated schemas.	DBA
Gather schema statistics to improve performance.	<p>The Gather Schema Statistics command returns the Oracle query optimizer statistics gathered for database objects. By using this information, the optimizer can select the best execution plan for any query against these objects.</p> <pre>EXECUTE DBMS_STAT S.GATHER_SCHEMA_ST ATS(ownname =&gt; '&lt;schema_name&gt;');</pre>	DBA

Task	Description	Skills required
Use AWS DMS to perform an ongoing replication from the source to target.	<p>Use AWS DMS to perform an ongoing replication from the source Oracle database to the target Amazon RDS for Oracle instance.</p> <p>For more information, see <a href="#">Creating tasks for ongoing replication using AWS DMS</a> and the blog post <a href="#">How to work with native CDC support in AWS DMS</a>.</p>	DBA, Migration engineer

### Cut over to Amazon RDS for Oracle

Task	Description	Skills required
Enable Multi-AZ on the instance 48 hours before cutover.	If this is a production instance, we recommend enabling <a href="#">Multi-AZ</a> deployment on the Amazon RDS instance to provide the benefits of high availability (HA) and disaster recovery (DR).	DBA, Migration engineer
Stop the AWS DMS CDC-only task (if CDC was turned on).	<ol style="list-style-type: none"> <li>1. Ensure the source latency and target latency on the AWS DMS task's Amazon CloudWatch metrics show 0 seconds.</li> <li>2. Stop the AWS DMS CDC-only task.</li> </ol>	DBA

Task	Description	Skills required
Enable the triggers.	Enable the TRIGGERS that you disabled before the CDC task was created.	DBA

## Related resources

### AWS

- [Preparing an Oracle self-managed source database for CDC using AWS DMS](#)
- [Creating tasks for ongoing replication using AWS DMS](#)
- [Multi-AZ deployments for high availability](#)
- [How to work with native CDC support in AWS DMS](#) (blog post)

### Oracle documentation

- [DBMS\\_DATAPUMP](#)

## Additional information

### Code 1: Full-load migration only, single application schema

```
DECLARE
    v_hdn1 NUMBER;
BEGIN
    v_hdn1 := DBMS_DATAPUMP.OPEN(operation => 'IMPORT', job_mode => 'SCHEMA',
    remote_link => '<DB LINK Name to Source Database>', job_name => null);
    DBMS_DATAPUMP.ADD_FILE( handle => v_hdn1, filename => 'import_01.log', directory
=> 'DATA_PUMP_DIR', filetype => dbms_datapump.ku$_file_type_log_file);
    DBMS_DATAPUMP.METADATA_FILTER(v_hdn1, 'SCHEMA_EXPR', 'IN (''<schema_name>'')'); --
To migrate one selected schema
    DBMS_DATAPUMP.METADATA_FILTER (hdn1, 'EXCLUDE_PATH_EXPR', 'IN (''STATISTICS'')'); --
To prevent gathering Statistics during the import
    DBMS_DATAPUMP.SET_PARALLEL (handle => v_hdn1, degree => 4); -- Number of parallel
processes performing export and import
    DBMS_DATAPUMP.START_JOB(v_hdn1);
END;
```

/

**Code 2: Full-load migration only, multiple application schemas**

```
DECLARE
  v_hdn1 NUMBER;
BEGIN
  v_hdn1 := DBMS_DATAPUMP.OPEN(operation => 'IMPORT', job_mode => 'SCHEMA',
remote_link => '<DB LINK Name to Source Database>', job_name => null);
  DBMS_DATAPUMP.ADD_FILE( handle => v_hdn1, filename => 'import_01.log', directory
=> 'DATA_PUMP_DIR', filetype => dbms_datapump.ku$_file_type_log_file);
  DBMS_DATAPUMP.METADATA_FILTER (v_hdn1, 'SCHEMA_LIST',
'''<SCHEMA_1>''','<SCHEMA_2>''', ''<SCHEMA_3>'''); -- To migrate multiple schemas
  DBMS_DATAPUMP.METADATA_FILTER (v_hdn1, 'EXCLUDE_PATH_EXPR','IN (''STATISTICS'')');
-- To prevent gathering Statistics during the import
  DBMS_DATAPUMP.SET_PARALLEL (handle => v_hdn1, degree => 4); -- Number of parallel
processes performing export and import
  DBMS_DATAPUMP.START_JOB(v_hdn1);
END;
/
```

**Code 3: Full-load migration before CDC-only task, single application schema**

```
DECLARE
  v_hdn1 NUMBER;
BEGIN
  v_hdn1 := DBMS_DATAPUMP.OPEN(operation => 'IMPORT', job_mode => 'SCHEMA',
remote_link => '<DB LINK Name to Source Database>', job_name => null);
  DBMS_DATAPUMP.ADD_FILE( handle => v_hdn1, filename => 'import_01.log', directory
=> 'DATA_PUMP_DIR', filetype => dbms_datapump.ku$_file_type_log_file);
  DBMS_DATAPUMP.METADATA_FILTER(v_hdn1,'SCHEMA_EXPR','IN (''<schema_name>'')'); --
To migrate one selected schema
  DBMS_DATAPUMP.METADATA_FILTER (v_hdn1, 'EXCLUDE_PATH_EXPR','IN (''STATISTICS'')');
-- To prevent gathering Statistics during the import
  DBMS_DATAPUMP.SET_PARAMETER (handle => v_hdn1, name => 'FLASHBACK_SCN', value =>
<CURRENT_SCN_VALUE_IN_SOURCE_DATABASE>); -- SCN required for AWS DMS CDC only task.
  DBMS_DATAPUMP.SET_PARALLEL (handle => v_hdn1, degree => 4); -- Number of parallel
processes performing export and import
  DBMS_DATAPUMP.START_JOB(v_hdn1);
END;
/
```

**Code 4: Full-load migration before CDC-only task, multiple application schemas**

```
DECLARE
  v_hdn1 NUMBER;
BEGIN
  v_hdn1 := DBMS_DATAPUMP.OPEN (operation => 'IMPORT', job_mode => 'SCHEMA',
remote_link => '<DB LINK Name to Source Database>', job_name => null);
  DBMS_DATAPUMP.ADD_FILE (handle => v_hdn1, filename => 'import_01.log', directory
=> 'DATA_PUMP_DIR', filetype => dbms_datapump.ku$_file_type_log_file);
  DBMS_DATAPUMP.METADATA_FILTER (v_hdn1, 'SCHEMA_LIST',
'''<SCHEMA_1>','<SCHEMA_2>', '<SCHEMA_3>'''); -- To migrate multiple schemas
  DBMS_DATAPUMP.METADATA_FILTER (v_hdn1, 'EXCLUDE_PATH_EXPR', 'IN (''STATISTICS'')');
-- To prevent gathering Statistics during the import
  DBMS_DATAPUMP.SET_PARAMETER (handle => v_hdn1, name => 'FLASHBACK_SCN', value =>
<CURRENT_SCN_VALUE_IN_SOURCE_DATABASE>); -- SCN required for AWS DMS CDC only task.
  DBMS_DATAPUMP.SET_PARALLEL (handle => v_hdn1, degree => 4); -- Number of parallel
processes performing export and import
  DBMS_DATAPUMP.START_JOB(v_hdn1);
END;
/
```

## Scenario where a mixed migration approach can work better

In rare scenarios where the source database contains tables with millions of rows and very large-sized LOBSEGMENT columns, this pattern will slow down the migration. Oracle migrates LOBSEGMENTS over the network link one at a time. It extracts a single row (along with the LOB column data) from the source table, and inserts the row into the target table, repeating the process until all rows are migrated. Oracle Data Pump over the database link doesn't support bulk load or direct path load mechanisms for LOBSEGMENTS.

In this situation, we recommend the following:

- Skip the identified tables during the Oracle Data Pump migration by adding the following metadata filter.

```
dbms_datapump.metadata_filter(handle =>h1, name=>'NAME_EXPR', value => 'NOT IN
(''TABLE_1'', ''TABLE_2'')');
```

- Use an AWS DMS task (full-load migration, with CDC replication if required) to migrate the identified tables. AWS DMS will extract multiple rows from the source Oracle database, and insert them in a batch to the target Amazon RDS instance, which improves performance.



# Migrate Oracle E-Business Suite to Amazon RDS Custom

Created by Simon Cunningham (AWS), Jaydeep Nandy (AWS), Nitin Saxena (AWS), and Vishnu Vinnakota (AWS)

<b>Environment:</b> Production	<b>Source:</b> Amazon EC2 or on premises	<b>Target:</b> Amazon RDS Custom
<b>R Type:</b> Replatform	<b>Workload:</b> Oracle	<b>Technologies:</b> Migration; Databases; Infrastructure
<b>AWS services:</b> Amazon EFS; Amazon RDS; AWS Secrets Manager		

## Summary

Oracle E-Business Suite is an Enterprise Resource Planning (ERP) solution for automating enterprise-wide processes such as financials, human resources, supply chains, and manufacturing. It has a three-tier architecture: client, application, and database. Previously, you had to run your Oracle E-Business Suite database on a self-managed [Amazon Elastic Compute Cloud \(Amazon EC2\) instance](#), but you can now benefit from [Amazon Relational Database Service \(Amazon RDS\) Custom](#).

[Amazon RDS Custom for Oracle](#) is a managed database service for legacy, custom, and packaged applications that require access to the underlying operating system and database environment. It automates database administration tasks and operations while making it possible for you, as a database administrator, to access and customize your database environment and operating system. When you migrate your Oracle database to Amazon RDS Custom, Amazon Web Services (AWS) takes care of heavy lifting such as backup tasks and ensuring high availability, while you can focus on maintaining your Oracle E-Business Suite application and functionality. For key factors to consider for a migration, see [Oracle database migration strategies](#) in AWS Prescriptive Guidance.

This pattern focuses on the steps to migrate a standalone Oracle database on Amazon EC2 to Amazon RDS Custom by using an Oracle Recovery Manager (RMAN) backup and an [Amazon Elastic File System \(Amazon EFS\)](#) shared file system between the EC2 instance and Amazon RDS Custom. The pattern uses an RMAN full backup (which is sometimes referred to as a *level 0* backup). For

simplicity, it uses a cold backup where the application is shut down and the database is mounted and not open. (You can also use Oracle Data Guard or RMAN duplication for backup. However, this pattern doesn't cover those options.)

For information about architecting Oracle E-Business Suite on AWS for high availability and disaster recovery, see the pattern [Set up an HA/DR architecture for Oracle E-Business Suite on Amazon RDS Custom with an active standby database](#).

**Note:** This pattern provides links to Oracle support notes. You need an [Oracle Support](#) account to access these documents.

## Prerequisites and limitations

### Prerequisites

- An Oracle version 12.1.0.2 or 19c (minimum 19.3) source database that is running on Amazon EC2 with Oracle Linux 7 or Red Hat Enterprise Linux (RHEL) version 7.x. This pattern assumes that the source database name is VIS and that the additional container database name for Oracle 19c is VISCDB, but you can use other names.

**Note:** You can also use this pattern with on-premises Oracle source databases, as long as you have the appropriate network connectivity between the on-premises network and [Amazon Virtual Private Cloud \(Amazon VPC\)](#).

- An Oracle E-Business Suite version 12.2.x application (vision instance). This procedure has been tested on version 12.2.11.
- A single Oracle E-Business Suite application tier. However, you can adapt this pattern to work with multiple application tiers.
- For Oracle 12.1.0.2, Amazon RDS Custom configured with at least 16 GB of swap space. Otherwise, the 12c Examples CD displays a warning. (Oracle 19c doesn't require the Examples CD, as mentioned later in this document.)

Complete the following steps before you start your migration:

1. On the Amazon RDS console, create an Amazon RDS Custom for Oracle DB instance with the database name VIS (or your source database name). For instructions, see [Working with Amazon RDS Custom](#) in the AWS documentation and the [Amazon RDS Custom for Oracle – New Control Capabilities in Database Environment](#) blog post. This ensures that the database name is set to the same name as the source database. (If left blank, the EC2 instance and database name will

be set to ORCL.) Make sure that you create your [custom engine version \(CEV\)](#) with the patches that have been applied to the source at a minimum. For more information, see [Preparing to create a CEV](#) in the Amazon RDS documentation.

**Note for Oracle 19c:** Currently, for Oracle 19c, the Amazon RDS container database name can be customized. The default is RDSCDB. Make sure to create the RDS Custom Oracle instance with same system ID (SID) as on the source EC2 instance. For example, in this pattern, the Oracle 19c SID is assumed to be VISCDB on the source instance. Therefore, the target Oracle 19c SID on Amazon RDS Custom should also be VISCDB.

2. Configure the Amazon RDS Custom DB instance with enough storage, vCPU, and memory to match the Amazon EC2 source database. To do this, you can match the [Amazon EC2 instance types](#) based on vCPU and memory.
3. Create an Amazon EFS file system and mount it on the Amazon EC2 and Amazon RDS Custom instances. For instructions, see the [Integrate Amazon RDS Custom for Oracle with Amazon EFS](#) blog post. This pattern assumes that you have mounted the Amazon EFS volume on /RMAN on both the source Amazon EC2 and target Amazon RDS Custom DB instances, and that network connectivity is possible between the source and target. You can also use the same method by using [Amazon FSx](#) or any shared drive.

## Assumptions

This pattern assumes that your application and database are using logical hostnames, which reduce the number of migration steps. You can adjust these steps to use physical hostnames, but logical hostnames reduce the complexity of the migration process. For information about the advantages of using logical hostnames, see the following support notes:

- For 12c, Oracle Support Note 2246690.1
- For 19c, Oracle Support Note 2617788.1

This pattern doesn't cover the Oracle 12c to 19c upgrade scenario, and focuses on migrating the same version of the Oracle database running on Amazon EC2 to Amazon RDS Custom for Oracle.

Amazon RDS Custom for Oracle [supports Oracle Home customization](#). (Oracle Home stores the Oracle binaries.) You can change the default path of `/rdsdbbin/oracle` to a path that you specify, such as `/d01/oracle/VIS/19c`. For simplicity, the instructions in this pattern assume the default path `/rdsdbbin/oracle`.

## Limitations

This pattern doesn't support the following features and configurations:

- Setting the database ARCHIVE\_LAG\_TARGET parameter to a value outside the 60–7200 range
- Disabling the DB instance log mode (NOARCHIVELOG)
- Turning off the EBS-optimized attribute of the EC2 instance
- Modifying the original Amazon Elastic Block Store (Amazon EBS) volumes attached to the EC2 instance
- Adding new EBS volumes or changing the volume type from gp2 to gp3
- Support for the TNS ifile
- Changing the control\_file location and name (it must be /rdsdbdata/db/VISDCB\_A/controlfile/control-01.ctl, where VISDCB is the CDB name)

For additional information about these and other unsupported configurations, see [Fixing unsupported configurations](#) in the Amazon RDS documentation.

## Product versions

For Oracle Database versions and instance classes supported by Amazon RDS Custom, see [Availability and requirements for Amazon RDS Custom for Oracle](#).

## Architecture

The following architecture diagram represents an Oracle E-Business Suite system running in a single [Availability Zone](#) on AWS. The application tier is accessed through an [Application Load Balancer](#), both the application and the databases are in private subnets, and the Amazon RDS Custom and Amazon EC2 database tier uses an Amazon EFS shared file system to store and access the RMAN backup files.

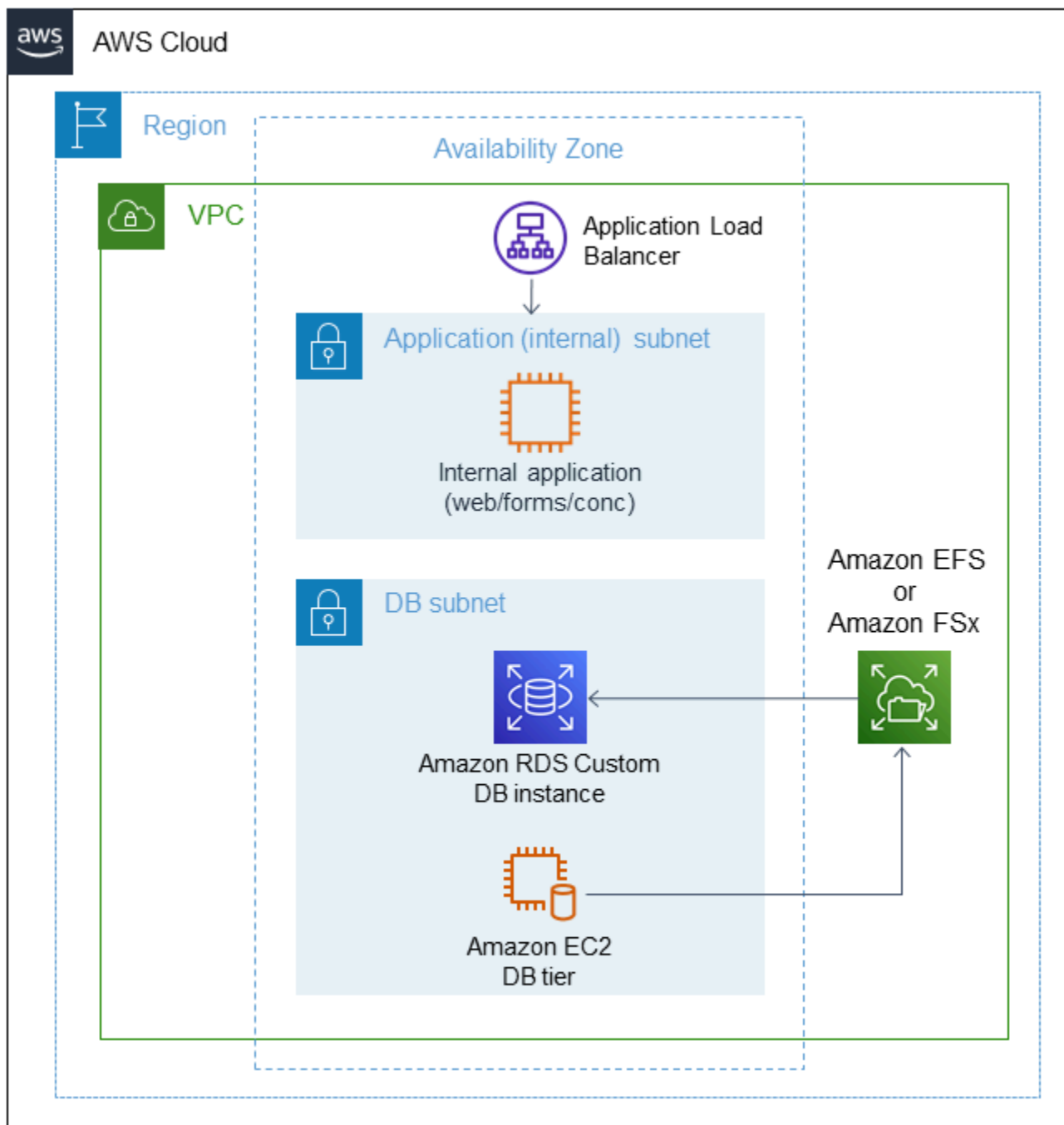

## Tools

### AWS services

- [Amazon RDS Custom for Oracle](#) is a managed database service for legacy, custom, and packaged applications that require access to the underlying operating system and database environment. It automates database administration tasks and operations while making it possible for you, as

a database administrator, to access and customize your database environment and operating system.

- [Amazon Elastic File System \(Amazon EFS\)](#) is a simple, serverless, elastic file system for adding and removing files with no need for management or provisioning. This pattern uses an Amazon EFS shared file system to store and access the RMAN backup files.
- [AWS Secrets Manager](#) is an AWS managed service that enables you to easily rotate, manage, and retrieve database credentials, API keys, and other secret information. Amazon RDS Custom stores the key pair and database user credentials in Secrets Manager upon database creation. In this pattern, you retrieve the database user passwords from Secrets Manager to create the RDSADMIN and ADMIN users and to change the sys and system passwords.

## Other tools

- RMAN is a tool that provides backup and recovery support for Oracle databases. This pattern uses RMAN to perform a cold backup of the source Oracle database on Amazon EC2 that is restored on Amazon RDS Custom.

## Best practices

- Use logical hostnames. This significantly reduces the number of post-clone scripts that you have to run. For more information, see Oracle Support Note 2246690.1.
- Amazon RDS Custom uses Oracle [Automatic Memory Management \(AMM\)](#) by default. If you want to use the hugemem kernel, you can configure Amazon RDS Custom to use Automatic Shared Memory Management (ASMM) instead.
- Leave the `memory_max_target` parameter enabled by default. The framework uses this parameter in the background to create read replicas.
- Enable Oracle Flashback Database. This feature is useful in failover (not switchover) testing scenarios to reinstate the standby.
- For database initialization parameters, customize the standard PFILE that's provided by the Amazon RDS Custom DB instance for Oracle E-Business Suite instead of using the SPFILE from the Oracle source database. This is because white spaces and comments cause issues when creating read replicas in Amazon RDS Custom. For more information about database initialization parameters, see Oracle Support Note 396009.1.

In the following *Epics* section, we've provided separate instructions for Oracle 12.1.0.2 and 19c, where the details differ.

## Epics

### Shut down the source application

Task	Description	Skills required
Shut down the application.	<p>To shut down the source application, use these commands:</p> <pre>\$ su - applmgr \$ cd \$INST_TOP/admin/sc ripts \$ ./adstpall.sh</pre>	DBA
Create the .zip file.	<p>Create the <code>appsutil.zip</code> file on the source application tier. You will use this file later to configure the Amazon RDS Custom database node.</p> <pre>\$ perl \$AD_TOP/bin/ admappsutil.pl</pre>	DBA
Copy the .zip file to Amazon EFS.	<p>Copy <code>appsutil.zip</code> from <code>\$INST_TOP/admin/output</code> to your shared Amazon EFS volume (<code>/RMAN/appsutil</code>). You can transfer the file manually by using secure copy (SCP) or another transfer mechanism.</p>	DBA

## Pre-clone the source database

Task	Description	Skills required
Pre-clone the database tier on Amazon EC2.	<p>Log in as Oracle user and run:</p> <pre>\$ cd \$ORACLE_HOME/appsutil/scripts/\$CONTEXT_NAME \$ perl adpreclone.pl dbTier</pre> <p>Check the log file generated to confirm that the operation completed successfully.</p>	DBA
Copy appsutil.zip to the shared Amazon EFS file system.	<p>Create a tar backup and copy \$ORACLE_HOME/appsutil to the shared Amazon EFS file system (for example, /RMAN/appsutil ):</p> <pre>\$ cd \$ORACLE_HOME \$ tar cvf sourceappsutil.tar appsutil \$ cp sourceappsutil.tar /RMAN/appsutil</pre>	DBA

## Perform a cold RMAN full backup of the source Amazon EC2 database

Task	Description	Skills required
Create a backup script.	Perform an RMAN full backup of the source database to the shared Amazon EFS file system.	DBA



Task	Description	Skills required
	<p>For simplicity, this pattern performs a cold RMAN backup. However, you can modify these steps to perform a hot RMAN backup with Oracle Data Guard to reduce downtime.</p> <p>1. Start up the source Amazon EC2 database in mount mode:</p> <pre data-bbox="597 695 1029 894">\$ sqlplus / as sysdba \$ SQL&gt; shutdown       immediate \$ SQL&gt; startup mount</pre> <p>2. Create an RMAN backup script (use one of the following examples, depending on your version of Oracle, or run one of your existing RMAN scripts) to back up the database to the Amazon EFS file system that you mounted (/RMAN in this example).</p> <p><b>For Oracle 12.1.0.2:</b></p> <pre data-bbox="597 1514 1029 1806">\$ vi FullRMANColdBackup .sh #!/bin/bash . /home/oracle/.bash _profile  export ORACLE_SID=VIS</pre>	

Task	Description	Skills required
	<pre> export ORACLE_HOME=/ d01/oracle/VIS/12.1.0 export DATE=\$(date + %y-%m-%d_%H%M%S)  rman target / log=/RMAN /VISDB_\${DATE}.log &lt;&lt; EOF run { allocate channel ch1 device type disk format '/RMAN/visdb_full_ bkp_%u'; allocate channel ch2 device type disk format '/RMAN/visdb_full_ bkp_%u'; crosscheck backup; delete noprompt obsolete; BACKUP AS COMPRESSED BACKUPSET DATABASE PLUS ARCHIVELOG; backup archivelog all; release channel ch1; release channel ch2; } EOF </pre> <p><b>For Oracle 19c:</b></p> <pre> \$ vi FullRMANColdBackup .sh #!/bin/bash . /home/oracle/.bash _profile  export ORACLE_SI D=VISCDB </pre>	

Task	Description	Skills required
	<pre>export ORACLE_HOME=/ d01/oracle/VIS/19c export DATE=\$(date + %y-%m-%d_%H%M%S)  rman target / log=/RMAN /VISDB_\${DATE}.log &lt;&lt; EOF run { allocate channel ch1 device type disk format '/RMAN/visdb_full_ bkp_%u'; allocate channel ch2 device type disk format '/RMAN/visdb_full_ bkp_%u'; crosscheck backup; delete noprompt obsolete; BACKUP AS COMPRESSED BACKUPSET DATABASE PLUS ARCHIVELOG; backup archivelog all; backup current controlfile format '/ RMAN/cntrl.bak'; release channel ch1; release channel ch2; } EOF</pre>	

Task	Description	Skills required
Run the backup script.	<p>Change permissions, log in as Oracle user, and run the script:</p> <pre data-bbox="597 394 1026 594">\$ chmod 755 FullRMANColdBackup.sh \$ ./FullRMANColdBackup.sh</pre>	DBA

Task	Description	Skills required
<p>Check for errors and note the name of the backup file.</p>	<p>Check the RMAN log file for errors. If everything looks fine, list the backup of the control file. Note the name of the output file.</p> <p><b>For Oracle 12.1.0.2:</b></p> <pre data-bbox="594 569 1029 1644"> RMAN&gt; connect target /  RMAN&gt; list backup of controlfile;  BS Key    Type LV Size       Device Type Elapsed Time Completion Time ----- ----- ----- 9         Full    1.11M       DISK          00:00:04       23-APR-22       BP Key: 9       Status: AVAILABLE       Compressed: YES  Tag:       TAG20220423T121011       Piece Name: / RMAN/visdb_full_b kp_100rlsbt       Control File Included:       Ckp SCN: 122045953 96727    Ckp time: 23- APR-22 </pre> <p>You will use the backup file /RMAN/visdb_full_b kp_100rlsbt later, when</p>	<p>DBA</p>

Task	Description	Skills required
	<p>you restore the database on Amazon RDS Custom.</p> <p><b>For Oracle 19c:</b></p> <pre> RMAN&gt; connect target /  RMAN&gt; list backup of controlfile;  BS Key   Type LV Size    Device Type Elapsed Time Completion Time ----- ----- ----- 38      Full   17.92M    DISK           00:00:01    25-NOV-22        BP Key: 38        Status: AVAILABLE        Compressed: NO   Tag:        TAG20221125T095014        Piece Name: / RMAN/cntrl.bak    Control File Included:    Ckp SCN: 122046201 88873   Ckp time: 23- NOV-22 </pre> <p>You will use the backup file <code>/RMAN/cntrl.bak</code> later, when you restore the database on Amazon RDS Custom.</p>	

## Configure the target Amazon RDS Custom database

Task	Description	Skills required
Change the hosts file and set the hostname.	<p><b>Note:</b> The commands in this section must be run as root user.</p> <ol style="list-style-type: none"><li>1. Edit the <code>/etc/hosts</code> file on the Amazon RDS Custom DB instance. A simple way to do this is to copy the database and application host entries from the source Amazon EC2 database hosts file.</li></ol> <pre data-bbox="597 913 1027 1310">&lt;IP-address&gt; OEBS-app01.localdomain OEBS-app01 OEBS-app01log.localdomain OEBS-app01log &lt;IP-address&gt; OEBS-db01.localdomain OEBS-db01 OEBS-db01log.localdomain OEBS-db01log</pre> <p>where <code>&lt;IP-address&gt;</code> is the database node IP address, which you should replace with the Amazon RDS Custom IP address. The logical hostnames are appended with <code>*log</code>.</p> <ol style="list-style-type: none"><li>2. Change the database hostname by running the <code>hostnamectl</code> command:</li></ol>	DBA

Task	Description	Skills required
	<pre data-bbox="597 210 1026 367">\$ sudo hostnamectl set-hostname --static persistent-hostname</pre> <p data-bbox="597 409 779 441">For example:</p> <pre data-bbox="597 472 1026 630">\$ sudo hostnamectl set- hostname --static OEBS- db01log</pre> <p data-bbox="597 672 982 850">For additional information, see the <a href="#">Knowledge Center article on assigning static hostnames</a>.</p> <p data-bbox="597 892 990 1165">3. Restart the Amazon RDS Custom DB instance. Don't worry about shutting down the database, because you will be dropping it in a later step.</p> <pre data-bbox="597 1207 1026 1281">\$ reboot</pre> <p data-bbox="597 1323 1023 1501">4. When the Amazon RDS Custom DB instance comes back up, log in and verify that the hostname has changed:</p> <pre data-bbox="597 1543 1026 1659">\$ hostname oebs-db01</pre>	



Task	Description	Skills required
Install the Oracle E-Business Suite software.	<p>Install the Oracle E-Business Suite recommended RPMs to the Oracle home location on the Amazon RDS Custom DB instance. For details, see Oracle Support Note #1330701.1. The following is a partial list. The RPM list changes for each release, so check to make sure that all the required RPMs are installed.</p> <p>As root user, run:</p> <pre data-bbox="594 905 1027 1339">\$ sudo yum -y update \$ sudo yum install -y elfutils-libelf-devel* \$ sudo yum install -y libXp-1.0.2-2.1*.i686 \$ sudo yum install -y libXp-1.0.2-2.1* \$ sudo yum install -y compat-libstdc++-*</pre>	DBA

Task	Description	Skills required
Install the VNC server.	<p><b>Note:</b> You can omit this step for Oracle 19c because the Examples CD is no longer required; see Oracle Support Note 2782085.1.</p> <p><b>For Oracle 12.1.0.2:</b></p> <p>Install the VNC server and its dependent desktop packages. This is a requirement for installing the 12c Examples CD in the next step.</p> <p>1. As root user, run:</p> <pre data-bbox="597 919 1026 1197">\$ sudo yum install -y tigervnc-server \$ sudo yum install -y *kde* \$ sudo yum install -y *xorg*</pre> <p>2. Start the VNC server for rdsdb user, and set the password for VNC:</p> <pre data-bbox="597 1402 1026 1558">\$ su - rdsdb \$ vncserver :1 \$ vncpassword</pre>	DBA

Task	Description	Skills required
Install the 12c Examples CD.	<p><b>Note:</b> You can omit this step for Oracle 19c because the Examples CD is no longer required; see Oracle Support Note 2782085.1.</p> <p><b>For Oracle 12.1.0.2:</b></p> <ol style="list-style-type: none"><li>1. Download the installation files from <a href="https://edelivery.oracle.com/">https://edelivery.oracle.com/</a>. For Oracle E-Business Suite 12.2.11 – Oracle Database 12c Release 1 (12.1.0.2), look for <b>Examples for Linux x86-64 V100102-01.zip</b>.</li><li>2. Create a directory to store the Examples CD: <pre>\$ mkdir /RMAN/12c examples</pre></li><li>3. Copy the Examples CD .zip file to this directory by using the transfer mechanism of your choice (for example, SCP): <pre>V100102-01.zip</pre></li><li>4. Change ownership to rdsdb:</li></ol>	DBA

Task	Description	Skills required
	<pre data-bbox="597 212 1024 327">\$ chown -R rdsdb:rdsdb /RMAN/12cexamples</pre> <p data-bbox="597 365 1024 449">5. As the rdsdb user, unzip the file:</p> <pre data-bbox="597 485 1024 562">\$ unzip V10010201.zip</pre> <p data-bbox="597 600 1024 1209">6. Connect from a client that has access to the VNC client and Amazon RDS Custom. Make sure that you have the necessary network connectivity and firewall ports open to allow access for VNC. For example, a VNC server that's running on <code>display :1</code> will need port 5901 opening on the security group that is associated with the Amazon RDS Custom EC2 host.</p> <p data-bbox="597 1247 1024 1383">7. Change to the directory where you copied the Examples CD:</p> <pre data-bbox="597 1419 1024 1535">\$ cd /RMAN/12cexamples/examples</pre> <p data-bbox="597 1572 1024 1709">8. Run the installer. Make sure to verify the location of the <code>oraInst.loc</code> file.</p> <pre data-bbox="597 1745 1024 1841">./runInstaller -invPtrLoc /rdsdbbin</pre>	

Task	Description	Skills required
	<pre data-bbox="597 205 1023 304">/oracle.12.1.custom.r1.EE.1/oraInst.loc</pre> <p data-bbox="597 346 1023 514">9. Use the following parameters during the installation of the Examples CD:</p> <pre data-bbox="597 556 1023 955">Skip Software Update Downloads Select Oracle Home 12.1.0.2 (Oracle Base = / rdsdbbin) (Software Location = /rdsdbbin/oracle/1 2.1.custom.r1.EE.1)</pre> <p data-bbox="597 997 1023 1165">10. The installation program includes five steps with prompts. Follow the steps until installation is complete.</p>	

### Drop the starter database and create the directories to store the database files

Task	Description	Skills required
Pause automation mode.	You have to pause <a href="#">automation mode</a> on your Amazon RDS Custom DB instance before you proceed with the next steps, to make sure that automation doesn't interfere with the RMAN activity.	DBA

Task	Description	Skills required
	<p>Pause the automation by using the following AWS Command Line Interface (AWS CLI) command. (Make sure that you have <a href="#">configured the AWS CLI</a> first.)</p> <pre data-bbox="594 520 1027 957">aws rds modify-db-instance \ --db-instance-id entifier VIS \ --automation-mode all-paused \ --resume-full-automation-mode-minute 360 \ --region eu-west-1</pre> <p>When you specify the duration of the pause, make sure that you leave enough time for the RMAN restore. This depends on the size of the source database, so modify the 360 value accordingly.</p>	

Task	Description	Skills required
Drop the starter database.	<p>Drop the existing Amazon RDS Custom database.</p> <p>As the Oracle home user, run the following commands. (The default user is <code>rdsdb</code>, unless you customized it.)</p> <pre data-bbox="597 569 1026 961">\$ sqlplus / as sysdba SQL&gt; shutdown immediate ; SQL&gt; startup nomount restrict; SQL&gt; alter database mount; SQL&gt; drop database; SQL&gt; exit</pre>	DBA

Task	Description	Skills required
Create directories to store the database files.	<p><b>For Oracle 12.1.0.2:</b></p> <p>Create directories for the database, control file, datafiles, and online log. Use the parent directory of the <code>control_files</code> parameter in the previous command (in this case, <code>VIS_A</code>). Run the following commands as the Oracle home user (by default, <code>rdsdb</code>).</p> <pre data-bbox="594 810 1029 1087">\$ mkdir -p /rdsdbdata/db/VIS_A/controlfile \$ mkdir -p /rdsdbdata/db/VIS_A/datafile \$ mkdir -p /rdsdbdata/db/VIS_A/onlinelog</pre>	DBA
	<p><b>For Oracle 19c:</b></p> <p>Create directories for the database, control file, datafiles, and online log. Use the parent directory of the <code>control_files</code> parameter in the previous command (in this case, <code>VISCDB_A</code>). Run the following commands as the Oracle home user (by default, <code>rdsdb</code>).</p>	



Task	Description	Skills required
	<pre>\$ mkdir -p /rdsdbdat a/db/cdb/VISCDB_A/ controlfile \$ mkdir -p /rdsdbdat a/db/cdb/VISCDB_A/ datafile \$ mkdir -p /rdsdbdat a/db/cdb/VISCDB_A/ onlineolog \$ mkdir -p /rdsdbdat a/db/cdb/VISCDB_A/ onlineolog/arch \$ mkdir /rdsdbdata/db/ pdb/VISCDB_A</pre>	

Task	Description	Skills required
Create and modify the parameter file for Oracle E-Business Suite.	<p>In this step, you won't copy the server parameter file (SPFILE) from the source database. Instead, you'll use the standard parameter file (PFILE) created with the Amazon RDS Custom DB instance and add the parameters that you need for Oracle E-Business Suite.</p> <p>When you drop the database, Amazon RDS automatically creates a backup of the <code>init.ora</code> file, which is associated with the Amazon RDS Custom database. This file is called <code>oracle_pfile</code> and is located in <code>/rdsdbdata/config</code>.</p> <p><b>For Oracle 12.1.0.2:</b></p> <ol style="list-style-type: none"><li>1. Copy <code>/rdsdbdata/config/oracle_pfile</code> to <code>\$ORACLE_HOME</code>.</li></ol> <pre data-bbox="594 1446 1027 1608">\$ cp /rdsdbdata/config/oracle_pfile \$ORACLE_HOME/dbs/initVIS.ora</pre> <ol style="list-style-type: none"><li>2. Edit the <code>initVIS.ora</code> file on the Amazon RDS Custom DB instance. Validate all the parameters on the source and add any</li></ol>	DBA

Task	Description	Skills required
	<p>parameters as needed. For details, see Oracle Support Note 396009.1.</p> <p><b>Important:</b> Make sure that there are no comments in the parameters that you add. Comments will cause issues with the automation, such as creating read replicas and issuing point-in-time recoveries (PITRs).</p> <p>3. Add parameters similar to the following to the <code>initVIS.ora</code> file, based on your requirements:</p> <pre data-bbox="597 1016 1026 1822">*.workarea_size_policy='AUTO' *.plsql_code_type='INTERPRETED' *.cursor_sharing='EXACT' *._b_tree_bitmap_plans=FALSE *.session_cached_cursors=500 *.optimizer_adaptive_features=false *.optimizer_secure_view_merging=false *.SQL92_SECURITY=TRUE *.temp_undo_enabled=true _system_trig_enabled = TRUE nls_language = american</pre>	

Task	Description	Skills required
	<pre> nls_territory =   america nls_numeric_characters = "., " nls_comp = binary nls_sort = binary nls_date_format = DD-MON-RR nls_length_semantics =   BYTE aq_tm_processes = 1 _sort_elimination_cost_ratio = 5 _like_with_bind_as_equality = TRUE _fast_full_scan_enabled = FALSE _b_tree_bitmap_plans =   FALSE optimizer_secure_view_merging = FALSE _optimizer_autostats_job = FALSE parallel_max_servers =   8 parallel_min_servers =   0 parallel_degree_policy =   MANUAL sec_case_sensitive_logon = FALSE compatible = 12.1.0.7 dictionary_accessibility = FALSE utl_file_dir = /tmp </pre> <p>4. Amend the following. The values will be dependent on your source system, so revise</p>	

Task	Description	Skills required
	<p>them based on your current setup.</p> <pre data-bbox="597 331 1026 489">*.open_cursors=500 *.undo_tablespace ='APPS_UNDOTS1'</pre> <p>5. Remove the SPFILE reference.</p> <pre data-bbox="597 646 1026 804">*.spfile='/rdsdbbin/oracle/dbs/spfileVIS.ora'</pre> <p><b>Notes:</b></p> <ul data-bbox="597 926 1026 1822" style="list-style-type: none"><li>• Don't alter the values provided by the Amazon RDS Custom PFILE for <code>control_files</code> and <code>db_unique_name</code>. Amazon RDS expects these values. Deviating from them will cause issues if you try to create a read replica in the future.</li><li>• Amazon RDS Custom uses <a href="#">Automatic Memory Management (AMM)</a> by default. If you want to use <code>hugemem</code>, you can configure Amazon RDS Custom to use Automatic Shared Memory Management (ASMM).</li></ul>	

Task	Description	Skills required
	<ul style="list-style-type: none"><li>• Leave the <code>memory_max_target</code> parameter enabled by default. The Amazon RDS framework uses this in the background to create read replicas.</li></ul> <p>6. Confirm that there are no issues with the <code>initVIS.ora</code> file by running the <code>startup nomount</code> command:</p> <pre>SQL&gt; startup nomount pfile=/rdsdbbin/oracle/dbs/initVIS.ora; SQL&gt; create spfile='/rdsdbdata/admin/VIS/pfile/spfileVIS.ora' from pfile; SQL&gt; exit</pre> <p>7. Create a symbolic link for SPFILE.</p> <pre>\$ ln -s /rdsdbdata/admin/VIS/pfile/spfileVIS.ora \$ORACLE_HOME/dbs/</pre> <p><b>For Oracle 19c:</b></p> <ol style="list-style-type: none"><li>1. Copy <code>/rdsdbdata/config/oracle_pfile</code> to <code>\$ORACLE_HOME .</code></li></ol>	

Task	Description	Skills required
	<pre data-bbox="597 226 1026 407">\$ cp /rdsdbdata/config/ oracle_pfile \$ORACLE_H OME/dbs/initVISCD B.ora .ora</pre> <p data-bbox="591 445 992 814">2. Edit the <code>initVISCD B.ora</code> file on the Amazon RDS Custom DB instance. Validate all the parameters on the source and add any parameters as needed. For details, see Oracle Support Note 396009.1.</p> <p data-bbox="591 856 1015 1276"><b>Important:</b> Make sure that there are no comments in the parameters that you add. If there are comments, they will cause issues with the automation, such as creating read replicas and issuing point-in-time recoveries (PITRs).</p> <p data-bbox="591 1318 1008 1499">3. Add parameters similar to the following to the <code>initVISCD B.ora</code> file, based on your requirements.</p> <pre data-bbox="597 1541 1026 1869">*.instance_name=VI SCDB *.sec_case_sensit ive_logon= FALSE *.result_cache_ma x_size = 600M *.optimizer_adaptive_p lans =TRUE</pre>	

Task	Description	Skills required
	<pre> *.optimizer_adaptive_ statistics = FALSE *.pga_aggregate_limit = 0 *.temp_undo_enabled = FALSE *._pdb_name_case_sens itive = TRUE *.event='10946 trace name context forever, level 8454144' *.workarea_size_p olicy='AUTO' *.plsql_code_t ype='INTERPRETED' *.cursor_sharing=' EXACT' *._b_tree_bitmap_pla ns=FALSE *.session_cached_c ursors=500 *.optimizer_secu re_view_merging=false *.SQL92_SECURITY=TRUE _system_trig_enabled = TRUE nls_language = american nls_territory = america nls_numeric_charact ers = "., " nls_comp = binary nls_sort = binary nls_date_format = DD- MON-RR nls_length_semantics = BYTE aq_tm_processes = 1 _sort_elimination n_cost_ratio =5 _like_with_bind _as_equality = TRUE </pre>	



Task	Description	Skills required
	<pre data-bbox="609 212 1015 781">_fast_full_scan_enabled = FALSE _b_tree_bitmap_plans = FALSE optimizer_secure_view_merging = FALSE _optimizer_autostats_job = FALSE parallel_max_servers = 8 parallel_min_servers = 0 parallel_degree_policy = MANUAL</pre> <p data-bbox="591 821 1023 999">4. Amend the following. The values will depend on your source system, so revise them based on your current setup.</p> <pre data-bbox="609 1052 1015 1192">*.open_cursors=500 *.undo_tablespace = 'UNDOTBS1'</pre> <p data-bbox="591 1232 907 1314">5. Remove the SPFILE reference:</p> <pre data-bbox="609 1367 1015 1507">*.spfile='/rdsdbbin/oracle/dbs/spfileVISADB.ora'</pre> <p data-bbox="591 1547 688 1581"><b>Notes:</b></p> <ul data-bbox="591 1629 979 1852" style="list-style-type: none"><li>• Don't alter the values provided by the Amazon RDS Custom PFILE for <code>control_files</code> and <code>db_unique_name</code>.</li></ul>	

Task	Description	Skills required
	<p>Amazon RDS expects these values. Deviating from them will cause issues if you try to create a read replica in the future.</p> <ul style="list-style-type: none"><li>• Amazon RDS Custom uses <a href="#">Automatic Memory Management (AMM)</a> by default. If you want to use hugemem, you can configure Amazon RDS Custom to use Automatic Shared Memory Management (ASMM).</li><li>• Leave the <code>memory_max_target</code> parameter enabled by default. The Amazon RDS framework uses this in the background to create read replicas.</li></ul> <p>6. Confirm that there are no issues with the <code>initVISCD B.ora</code> file by running the <code>startup nomount</code> command:</p> <pre>SQL&gt; startup nomount pfile=/rdsdbbin/oracle/dbs/initVISCD B.ora; SQL&gt; create spfile='/ rdsbdbdata/admin/VISCD B/pfile/spfileVISCD B.ora' from pfile;</pre>	

Task	Description	Skills required
	<pre>SQL&gt; exit</pre> <p>7. Create a symbolic link for SPFILE.</p> <pre>\$ ln -s /rdsdbdata/ admin/VISCDB/pfile/ spfileVISCDB.ora \$ORACLE_HOME/dbs/</pre>	

Task	Description	Skills required
Restore the Amazon RDS Custom database from the backup.	<p><b>For Oracle 12.1.0.2:</b></p> <p>1. Restore the control file by using the backup file that you captured on the source earlier:</p> <pre> RMAN&gt; connect target / RMAN&gt; RESTORE CONTROLFILE FROM '/RMAN/vi sdb_full_bkp_100r1 sbt';  Starting restore at 10- APR-22 using target database control file instead of recovery catalog allocated channel: ORA_DISK_1 channel ORA_DISK_ 1: SID=201 device type=DISK  channel ORA_DISK_1: restoring control file channel ORA_DISK_ 1: restore complete, elapsed time: 00:00:01 output file name=/rds dbdata/db/VIS_A/co ntrolfile/control- 01.ctl Finished restore at 10- APR-22 </pre> <p>2. Catalog the backup pieces, so you can issue an RMAN restore:</p>	DBA

Task	Description	Skills required
	<pre>RMAN&gt; alter database mount; RMAN&gt; catalog start with '/RMAN/visdb';</pre> <p>3. Create a script to restore the database:</p> <pre>\$ vi restore.sh rman target / log=/home /irdsdb/rman.log &lt;&lt; EOF run { set newname for database to '/irdsdbdata/db/VIS _A/datafile/%b'; restore database; switch datafile all; switch tempfile all; } EOF</pre> <p>4. Restore the source to the target Amazon RDS Custom database. You must change the permissions of the script to allow running it, and then run the <code>restore.sh</code> script to restore the database.</p> <pre>\$ chmod 755 restore.sh \$ nohup ./restore.sh &amp;</pre> <p><b>For Oracle 19c:</b></p> <p>1. Restore the control file by using the backup file that</p>	

Task	Description	Skills required
	<p>you captured on the source earlier:</p> <pre> RMAN&gt; connect target / RMAN&gt; RESTORE CONTROLFI LE FROM '/RMAN/cn trl.bak'; Starting restore at 07- JUN-23 using target database control file instead of recovery catalog allocated channel: ORA_DISK_1 channel ORA_DISK_ 1: SID=201 device type=DISK channel ORA_DISK_1: restoring control file channel ORA_DISK_ 1: restore complete, elapsed time: 00:00:01 output file name=/rds dbdata/db/cdb/VISC DB_A/controlfile/c ontrol-01.ctl Finished restore at 07- JUN-23 </pre> <p>2. Catalog the backup pieces, so you can issue an RMAN restore:</p> <pre> RMAN&gt; alter database mount; RMAN&gt; catalog start with '/RMAN/visdb'; </pre>	

Task	Description	Skills required
	<p>If you experience issues with the <code>start with</code> command, you can add the backup pieces individually; for example:</p> <pre data-bbox="594 474 1027 634">RMAN&gt; catalog backuppiece '/RMAN/visdb_full_bkp_1d1e507m';</pre> <p>and then repeat the command for each backup piece.</p> <p>3. Create a script to restore the database. Amend the pluggable database name based on your requirements. Allocate parallel channels based on the number of vCPUs available to speed up the restore process.</p> <pre data-bbox="594 1251 1027 1820">\$ vi restore.sh rman target / log=/home/ rdsdb/rmancdb.log &lt;&lt; EOF run { allocate channel c1 type disk; allocate channel c2 type disk; ..... allocate channel c&lt;N&gt; type disk; set newname for database to '/rdsbdbdata/db/cdb</pre>	

Task	Description	Skills required
	<pre data-bbox="609 210 1015 1176"> /VISDCB_A/datafile/ %b'; set newname for database   root to '/rdsbdba ta/db/cdb/VISDCB_A/ datafile/%f_%b'; set newname for   database "PDB\$SEED" to   '/rdsbdbdata/db/cdb/ pdbseed/%f_%b'; set newname for   pluggable database VIS   to '/rdsbdbdata/db/pdb /VISDCB_A/%f_%b'; restore database; switch datafile all; switch tempfile all; release channel c1; release channel c2; release channel c3; .... .... .... release channel c&lt;N&gt;; } EOF </pre> <p data-bbox="592 1218 1015 1543">4. Restore the source to the target Amazon RDS Custom database. You must change the permissions of the script to allow running it, and then run the <code>restore.sh</code> script to restore the database.</p> <pre data-bbox="609 1575 1015 1690"> \$ chmod 755 restore.sh \$ nohup ./restore.sh &amp; </pre>	



Task	Description	Skills required
Check log files for issues.	<p><b>For Oracle 12.1.0.2:</b></p> <ol style="list-style-type: none"> <li>1. Confirm that there are no issues by reviewing the <code>rman.log</code> file:           <pre data-bbox="597 474 1027 594">\$ cat /home/irdsdb/rman.log</pre> </li> <li>2. Confirm the path of the log files registered in the control file:           <pre data-bbox="597 800 1027 1394">SQL&gt; select member from v\$logfile; MEMBER ----- ----- ----- ----- ----- /d01/oracle/VIS/data/ log1.dbf /d01/oracle/VIS/data/ log2.dbf /d01/oracle/VIS/data/ log3.dbf</pre> </li> <li>3. Rename the log files to match the file path of the target. Replace the path to match the output from the previous step:           <pre data-bbox="597 1696 1027 1869">SQL&gt; ALTER DATABASE RENAME FILE '/d01/ora cle/VIS/data/log1. dbf' TO '/irdsdbdata/</pre> </li> </ol>	DBA

Task	Description	Skills required
	<pre>db/VIS_A/onlineolog/ log1.dbf'; SQL&gt; ALTER DATABASE   RENAME FILE '/d01/ora cle/VIS/data/log2. dbf' TO '/rdsbdbdata/ db/VIS_A/onlineolog/ log2.dbf'; SQL&gt; ALTER DATABASE   RENAME FILE '/d01/ora cle/VIS/data/log3. dbf' TO '/rdsbdbdata/ db/VIS_A/onlineolog/ log3.dbf';</pre> <p><b>For Oracle 19c:</b></p> <ol style="list-style-type: none"> <li>1. Confirm that there are no issues by reviewing the rmancdb.log file:</li> </ol> <pre>\$ cat /home/rdsdb/ rmancdb.log</pre> <ol style="list-style-type: none"> <li>2. Confirm the path of the log files registered in the control file:</li> </ol> <pre>SQL&gt; select member from v\$logfile; MEMBER ----- ----- ----- ----- ----- /d01/oracle/VIS/or adata/VIS/CDB/redo0 3.log</pre>	

Task	Description	Skills required
	<p data-bbox="609 212 1015 426">/d01/oracle/VIS/oradata/VIS/redo02.log /d01/oracle/VIS/oradata/VIS/redo01.log</p> <p data-bbox="592 464 982 688"><b>3. Rename the log files to match the file path of the target. Replace the path to match the output from the previous step:</b></p> <pre data-bbox="609 743 1015 1591">SQL&gt; ALTER DATABASE   RENAME FILE '/d01/oracle/VIS/oradata/VIS/redo01.log' TO   '/rdsbdbata/db/cdb/VIS/redo01.log'; SQL&gt; ALTER DATABASE   RENAME FILE '/d01/oracle/VIS/oradata/VIS/redo02.log' TO   '/rdsbdbata/db/cdb/VIS/redo02.log'; SQL&gt; ALTER DATABASE   RENAME FILE '/d01/oracle/VIS/oradata/VIS/redo03.log' TO   '/rdsbdbata/db/cdb/VIS/redo03.log';</pre> <p data-bbox="592 1640 982 1816"><b>4. Confirm the path, the status of the log files, and the group number that is registered in the control file:</b></p>	

Task	Description	Skills required
	<pre>SQL&gt; column REDOLOG_F ILE_NAME format a50 SQL&gt; SELECT a.GROUP#, a.status, b.MEMBER AS REDOLOG_FILE_NAME, (a.BYTES/1024/1024) AS SIZE_MB FROM v\$log a JOIN v\$logfile b ON a.Group#=b.Group# ORDER BY a.GROUP#;  GROUP# STATUS REDOLOG_F ILE_NAME           SIZE_MB 1 CURRENT /rdsdbdat a/db/cdb/VISCDDB_A/ onlineolog/log1.dbf           512 2 INACTIVE /rdsdbdat a/db/cdb/VISCDDB_A/ onlineolog/log2.dbf           512 3 INACTIVE /rdsdbdat a/db/cdb/VISCDDB_A/ onlineolog/log3.dbf           512</pre>	

Task	Description	Skills required
Confirm that you can open the Amazon RDS Custom database, and create OMF log files.	<p>Amazon RDS Custom for Oracle uses <a href="#">Oracle Managed Files</a> (OMF) to simplify operations. You can promote read replicas to standalone instances, but you must first create the log files by using OMF. This is to ensure that the correct path is used when the instance is promoted. For more information about how to promote read replicas, see the <a href="#">Amazon RDS documentation</a>. Failure to use OMF files can potentially cause problems when you try to promote read replicas.</p> <ol style="list-style-type: none"><li>1. Open the database with <code>resetlogs</code> :</li></ol> <pre data-bbox="594 1188 1029 1310">SQL&gt; alter database open resetlogs;</pre> <p><b>Note:</b> If you receive the error <i>ORA-00392: log xx of thread 1 is being cleared, operation not allowed</i>, follow the steps in the <a href="#">Troubleshooting</a> section for ORA-00392.</p> <ol style="list-style-type: none"><li>2. Confirm that the database is open:</li></ol> <pre data-bbox="594 1785 1029 1877">SQL&gt; select open_mode from v\$database;</pre>	DBA

Task	Description	Skills required
	<pre>OPEN_MODE ----- READ WRITE</pre> <p>3. Create the OMF log files. Change the group numbers, number of groups, and size depending on your requirements by using the output from the previous logfile query. The following example starts at group 4 and adds three groups for simplicity.</p> <pre>SQL&gt; alter database add logfile group 4 size 512M; Database altered. SQL&gt; alter database add logfile group 5 size 512M; Database altered. SQL&gt; alter database add logfile group 6 size 512M; Database altered.</pre> <p>4. Drop the previous non-OMF files. Here's an example that you can customize based on your requirements and the output from the query in earlier steps:</p> <pre>SQL&gt; alter database drop logfile group 1; System altered.</pre>	

Task	Description	Skills required
	<pre>SQL&gt; alter database   drop logfile group 2; System altered. SQL&gt; alter database   drop logfile group 3; System altered.</pre> <p><b>Note:</b> If you receive an ORA-01624 error when trying to drop the log files, see the <a href="#">Troubleshooting</a> section.</p> <p>5. Confirm that you can see the OMF files that were created. (The directory path varies for Oracle 12.1.0.2 and 19c, but the concept is the same.)</p> <pre>SQL&gt; select member from v\$logfile;  MEMBER ----- ----- /rdsdbdata/db/cdb/ VISCDB_A/online/ o1_mf_4_ksrbslny_.log /rdsdbdata/db/cdb/VIS CDB_A/online/ o1_mf_5_ksrchw0k_.log /rdsdbdata/db/cdb/ VISCDB_A/online/ o1_mf_6_ksrcn19v_.log</pre>	

Task	Description	Skills required
	<p>6. Restart the database and confirm that SPFILE is in use by the instance:</p> <pre data-bbox="597 380 1029 575">SQL&gt; shutdown immediate SQL&gt; startup SQL&gt; show parameter     spfile</pre> <p>For Oracle 12.1.0.2, this query returns:</p> <pre data-bbox="597 737 1029 894">spfile    /rdsdbbin /oracle/dbs/spfile VIS.ora</pre> <p>For Oracle 19c, the query returns:</p> <pre data-bbox="597 1056 1029 1213">spfile    /rdsdbbin /oracle/dbs/spfile VISCDB.ora</pre> <p>7. <b>For Oracle 19c only</b>, check the status of the container database, and open it if required:</p> <pre data-bbox="597 1465 1029 1837">SQL&gt; show pdbs CON_ID CON_NAME       OPEN MODE   RESTRICTED ----- -           2 PDB\$SEED       READ ONLY NO</pre>	



Task	Description	Skills required
	<pre> 3 VIS MOUNTED NO  SQL&gt; alter session set container=VIS; Session altered.  SQL&gt; alter database open; Database altered.  SQL&gt; alter database save state; Database altered.  SQL&gt; show pdbs CON_ID CON_NAME OPEN MODE RESTRICTED ----- ----- ----- 3 VIS READ WRITE NO  SQL&gt; exit </pre> <p>8. Delete the <code>init.ora</code> file from <code>\$ORACLE_HOME/dbs</code> , because you are not using the PFILE:</p> <pre>\$ cd \$ORACLE_HOME/dbs</pre> <p>For Oracle 12.1.0.2, use the command:</p> <pre>\$ pwd</pre>	

Task	Description	Skills required
	<pre>/rdsdbbin/oracle/dbs \$ rm initVIS.ora</pre> <p>For Oracle 19c, use the command:</p> <pre>\$ pwd /rdsdbbin/oracle/dbs \$ rm initVISCDB.ora</pre>	

### Retrieve passwords from Secrets Manager, create users, and change passwords

Task	Description	Skills required
Retrieve passwords from Secrets Manager.	<p>You can perform these steps in the console or by using the AWS CLI. The following steps provide instructions for the console.</p> <ol style="list-style-type: none"> <li>1. Sign in to the AWS Management Console and open the Amazon RDS console at <a href="https://console.aws.amazon.com/rds/">https://console.aws.amazon.com/rds/</a>.</li> <li>2. In the navigation pane, choose <b>Databases</b>, and then select the Amazon RDS database.</li> <li>3. Choose <b>Configuration</b>, and note the resource ID for the instance (it will be in the format: db-WZ4WLC</li> </ol>	DBA

Task	Description	Skills required
	<p>K6A0Q6TJGZKMGRCDI 3Y ).</p> <p>4. Open the AWS Secrets Manager console at <a href="https://console.aws.amazon.com/secretsmanager/">https://console.aws.amazon.com/secretsmanager/</a>.</p> <p>5. Choose the secret that has the same name as do-not-delete-custom-<code>&lt;resource_id&gt;</code> , where <code>resource-id</code> refers to the ID for the instance that you noted in step 3.</p> <p>6. Choose <b>Retrieve secret value</b>.</p>	

Task	Description	Skills required
Create the RDSADMIN user.	<p>RDSADMIN is a monitoring and orchestrator database user in the Amazon RDS Custom DB instance. Because the starter database was dropped and the target database was restored from the source by using RMAN, you must recreate this user after the restore operation to make sure that Amazon RDS Custom monitoring works as expected. You also have to create a separate profile and tablespace for the RDSADMIN user. The instructions differ slightly for Oracle 12.1.0.2 and 19c.</p> <p><b>For Oracle 12.1.0.2:</b></p> <p>1. Enter the following commands at a SQL prompt:</p> <pre>SQL&gt; set echo on       feedback on serverout       on SQL&gt; @?/rdbms/admin/utl       pwmg.sql  SQL&gt; ALTER PROFILE       DEFAULT       LIMIT       FAILED_LOGIN_ATTEMPTS       UNLIMITED       PASSWORD_LIFE_TIME       UNLIMITED</pre>	DBA

Task	Description	Skills required
	<pre>PASSWORD_VERIFY_FUNCTION NULL;</pre> <p>2. Create the profile RDSADMIN:</p> <pre>SQL&gt; create profile RDSADMIN LIMIT COMPOSITE_LIMIT UNLIMITED SESSIONS_PER_USER UNLIMITED CPU_PER_SESSION UNLIMITED CPU_PER_CALL UNLIMITED LOGICAL_READS_PER_SESSION UNLIMITED LOGICAL_READS_PER_CALL UNLIMITED IDLE_TIME UNLIMITED CONNECT_TIME UNLIMITED PRIVATE_SGA UNLIMITED FAILED_LOGIN_ATTEMPTS 10 PASSWORD_LIFE_TIME UNLIMITED PASSWORD_REUSE_TIME UNLIMITED PASSWORD_REUSE_MAX UNLIMITED PASSWORD_VERIFY_FUNCTION NULL PASSWORD_LOCK_TIME 86400/86400 PASSWORD_GRACE_TIME 604800/86400;</pre>	

Task	Description	Skills required
	<p data-bbox="591 212 997 342">3. Set the SYS, SYSTEM, and DBSNMP user profiles to RDSADMIN:</p> <pre data-bbox="610 405 964 751">SQL&gt; set echo on       feedback on serverout       on SQL&gt; alter user SYS       profile RDSADMIN; SQL&gt; alter user SYSTEM       profile RDSADMIN; SQL&gt; alter user DBSNMP       profile RDSADMIN;</pre> <p data-bbox="591 816 976 898">4. Create the RDSADMIN tablespace:</p> <pre data-bbox="610 961 997 1388">SQL&gt; create bigfile       tablespace rdsadmin       datafile size 7M       autoextend on next 1m       Logging online       permanent blocksize       8192 extent managemen       t local autoallocate       default nocompress       segment space managemen       t auto;</pre> <p data-bbox="591 1453 1003 1677">5. Create the RDSADMIN user. Replace the RDSADMIN password with the password you obtained earlier from Secrets Manager:</p> <pre data-bbox="610 1740 980 1845">SQL&gt; create user       rdsadmin identified by       xxxxxxxxxxxx</pre>	

Task	Description	Skills required
	<pre>Default tablespace rdsadmin Temporary tablespace temp profile rdsadmin ;</pre> <p><b>6. Grant privileges to RDSADMIN:</b></p> <pre>SQL&gt; grant select on sys.v_\$instance to rdsadmin; SQL&gt; grant select on sys.v_\$archived_log to rdsadmin; SQL&gt; grant select on sys.v_\$database to rdsadmin; SQL&gt; grant select on sys.v_\$database_in carnation to rdsadmin; SQL&gt; grant select on dba_users to rdsadmin; SQL&gt; grant alter system to rdsadmin; SQL&gt; grant alter database to rdsadmin; SQL&gt; grant connect to rdsadmin with admin option; SQL&gt; grant resource to rdsadmin with admin option; SQL&gt; alter user rdsadmin account unlock identified by xxxxxxxxxxxx; SQL&gt; @?/rdbms/admin/use rlock.sql</pre>	

Task	Description	Skills required
	<pre>SQL&gt; @?/rdbms/admin/utl ip.sql</pre> <p><b>For Oracle 19c:</b></p> <p>1. Enter the following commands at a SQL prompt:</p> <pre>SQL&gt; set echo on feedback on serverout on SQL&gt; @?/rdbms/admin/utl pwdmg.sql</pre> <pre>SQL&gt; alter profile default LIMIT FAILED_LOGIN_ATTEMPTS UNLIMITED PASSWORD_LIFE_TIME UNLIMITED PASSWORD_VERIFY_F UNCTION NULL;</pre> <p>2. Create the profile RDSADMIN.</p> <p><b>Note:</b> RDSADMIN has a prefix of C## in Oracle 19c. This is because the database parameter <code>common_user_prefix</code> is set to C##. RDSADMIN has no prefix in Oracle 12.1.0.2.</p> <pre>SQL&gt; create profile C##RDSADMIN LIMIT</pre>	



Task	Description	Skills required
	<pre> COMPOSITE_LIMIT   UNLIMITED SESSIONS_PER_USER   UNLIMITED CPU_PER_SESSION   UNLIMITED CPU_PER_CALL UNLIMITED LOGICAL_READS_PER _SESSION UNLIMITED LOGICAL_READS_PER_CALL   UNLIMITED IDLE_TIME UNLIMITED CONNECT_TIME UNLIMITED PRIVATE_SGA UNLIMITED FAILED_LOGIN_ATTEMPTS   10 PASSWORD_LIFE_TIME   UNLIMITED PASSWORD_REUSE_TIME   UNLIMITED PASSWORD_REUSE_MAX   UNLIMITED PASSWORD_VERIFY_F UNCTION NULL PASSWORD_LOCK_TIME   86400/86400 PASSWORD_GRACE_TIME   604800/86400; </pre> <p>3. Set the SYS, SYSTEM, and DBSNMP user profiles to RDSADMIN:</p> <pre> SQL&gt; alter user SYS   profile C##RDSADMIN; SQL&gt; alter user SYSTEM   profile C##RDSADMIN; SQL&gt; alter user DBSNMP   profile C##RDSADMIN; </pre>	

Task	Description	Skills required
	<p data-bbox="591 212 976 296">4. Create the RDSADMIN tablespace:</p> <pre data-bbox="610 352 997 783">SQL&gt; create bigfile tablespace rdsadmin datafile size 7M autoextend on next 1m Logging online permanent blocksize 8192 extent managemen t local autoallocate default nocompress segment space managemen t auto;</pre> <p data-bbox="591 848 1003 1073">5. Create the RDSADMIN user. Replace the RDSADMIN password with the password you obtained earlier from Secrets Manager.</p> <pre data-bbox="610 1129 964 1325">SQL&gt; create user C##rdsadmin identifie d by xxxxxxxxxxxx profile C##rdsadmin container=all;</pre> <p data-bbox="591 1388 857 1472">6. Grant privileges to RDSADMIN:</p> <pre data-bbox="610 1528 932 1877">SQL&gt; grant select on sys.v_\$instance to c##rdsadmin; SQL&gt; grant select on sys.v_\$archived_log to c##rdsadmin; SQL&gt; grant select on sys.v_\$database to c##rdsadmin;</pre>	

Task	Description	Skills required
	<pre>SQL&gt; grant select on   sys.v_\$database_in   carnation to c##rdsadm   in; SQL&gt; grant select on   dba_users to c##rdsadm   in; SQL&gt; grant alter system   to C##rdsadmin; SQL&gt; grant alter   database to C##rdsadm   in; SQL&gt; grant connect to   C##rdsadmin with admin   option; SQL&gt; grant resource to   C##rdsadmin with admin   option; SQL&gt; alter user   C##rdsadmin account   unlock identified by   xxxxxxxxxxxx; SQL&gt; @?/rdbms/admin/use   rlock.sql SQL&gt; @?/rdbms/admin/utl   rp.sql</pre>	

Task	Description	Skills required
Create the master user.	<p>Because the starter database was dropped and the target database was restored from the source by using RMAN, you must recreate the master user. In this example, the master username is admin.</p> <p><b>For Oracle 12.1.0.2:</b></p> <pre>SQL&gt; create user admin identified by &lt;password&gt;; SQL&gt; grant dba to admin</pre> <p><b>For Oracle 19c:</b></p> <pre>SQL&gt; alter session set container=VIS;  Session altered.  SQL&gt; create user admin identified by &lt;password&gt;;  User created.  SQL&gt; grant dba to admin;  Grant succeeded.</pre>	DBA

Task	Description	Skills required
Change the super user passwords.	<p>1. Change the system passwords by using the password you retrieved from Secrets Manager.</p> <p><b>For Oracle 12.1.0.2:</b></p> <pre>SQL&gt; alter user   sys identified by   xxxxxxxxxxxx; SQL&gt; alter user   system identified by   xxxxxxxxxxxx;</pre> <p><b>For Oracle 19c:</b></p> <pre>SQL&gt; alter user   sys identified by   xxxxxxxxxxxx container   =all; SQL&gt; alter user   system identified by   xxxxxxxxxxxx container   =all;</pre> <p>1. Change the EBS_SYSTEM passwords.</p> <p><b>For Oracle 12.1.0.2:</b></p> <pre>SQL&gt; alter user   ebs_system identified   by xxxxxxxxxxxx;</pre> <p><b>For Oracle 19c:</b></p>	DBA

Task	Description	Skills required
	<p>For this version, you also have to connect to the container database, to update the EBS_SYSTEM password there.</p> <pre data-bbox="597 474 1029 793">SQL&gt; alter session set   container=vis; SQL&gt; alter user   ebs_system identified   by xxxxxxxxxxxx;  SQL&gt; exit;</pre> <p>If you don't change these passwords, Amazon RDS Custom displays the error message: <i>The database monitoring user or user credentials have changed.</i></p>	

## Create directories for Oracle E-Business Suite, install ETCC, and run Autoconfig

Task	Description	Skills required
<p>Create the directories required for Oracle E-Business Suite.</p>	<p>1. On the Amazon RDS Custom Oracle database, run the following script as the Oracle home user, to create the 9idata directory in \$ORACLE_HOME/nls/data/9idata . This directory is required for Oracle E-Business Suite.</p>	

Task	Description	Skills required
	<pre>perl \$ORACLE_HOME/nls/data/old/cr9idata.pl</pre> <p>Ignore the ORA-NLS10 message, because you will create the context-enabled environment in later steps.</p> <p>2. Copy the <code>appsutil.tar</code> file, which you created earlier from the shared Amazon EFS file system, and untar it on the Amazon RDS Custom Oracle home directory.</p> <p>This creates the <code>appsutil</code> directory in the <code>\$ORACLE_HOME</code> directory.</p> <pre>\$ cd /RMAN/appsutil \$ cp sourceappsutil.tar \$ORACLE_HOME \$ cd \$ORACLE_HOME \$ tar xvf sourceappsutil.tar appsutil</pre> <p>3. Copy the <code>appsutil.zip</code> file, which you saved on the Amazon EFS shared file system earlier. This was the file you created on the application tier.</p> <p>As the <code>rdsdb</code> user on the Amazon RDS Custom DB instance:</p>	

Task	Description	Skills required
	<pre data-bbox="597 218 1026 369">\$ cp /RMAN/appsutil/app sutil.zip \$ORACLE_HOME \$ cd \$ORACLE_HOME</pre> <p data-bbox="597 407 1026 588">4. Unzip the <code>appsutil.zip</code> file to create the <code>appsutil</code> directory and subdirectories in the Oracle home directory:</p> <pre data-bbox="597 625 1026 701">\$ unzip -o appsutil.zip</pre> <p data-bbox="597 739 1026 873">The <code>-o</code> option means that some of the files will be overwritten.</p>	



Task	Description	Skills required
Configure the <code>tsnames.ora</code> and <code>sqlnet.ora</code> files.	<p>You have to configure the <code>tnsnames.ora</code> file so you can connect to the database with the Autoconfig tool. In the following example, you can see that the <code>tnsnames.ora</code> file is softlinked, but the file is empty by default.</p> <pre data-bbox="597 636 1027 1507">\$ cd \$ORACLE_HOME/network/admin \$ ls -ltr -rw-r--r-- 1 rdsdb database 373 Oct 31 2013 shrept.lst lrwxrwxrwx 1 rdsdb database 30 Feb 9 17:17 listener.ora - &gt; /rdsbdbdata/config/ listener.ora lrwxrwxrwx 1 rdsdb database 28 Feb 9 17:17 sqlnet.ora - &gt; /rdsbdbdata/config/ sqlnet.ora lrwxrwxrwx 1 rdsdb database 30 Feb 9 17:17 tnsnames.ora - &gt; /rdsbdbdata/config/ tnsnames.ora</pre> <ol style="list-style-type: none"><li>1. Create the <code>tnsnames.ora</code> entry. Because of the way Amazon RDS automation parses the files, you have to make sure that the entry doesn't contain any white spaces, comments, or extra</li></ol>	DBA

Task	Description	Skills required
	<p>lines. Otherwise, you might run into issues when using some of the APIs such as <a href="#">create-db-instance-read-replica</a>. Use the following as an example.</p> <p>2. Replace the port, host, and SID in accordance with your requirements:</p> <pre data-bbox="597 695 1027 1052">\$ vi tnsnames.ora VIS=(DESCRIPTION= (AADDRESS_LIST=(ADD RESS=(PROTOCOL=TCP )(PORT=1521)(HOST= xx.xx.xx.xx)))(CON NECT_DATA=(SID=VIS) (SERVER=DEDICATED)))</pre> <p><b>Note:</b> There should be no extra lines in the file. If you don't remove the lines, you might encounter issues when you create a read replica in the future. The creation of a read replica might fail with the error message: <i>Activity threw exception : HostManagerException: Unable to successfully call restrictReplication on any hosts.</i></p> <p>3. Confirm that the database can be reached:</p>	

Task	Description	Skills required
	<pre data-bbox="597 212 1024 323">\$ tnsping vis OK (0 msec)</pre> <p data-bbox="597 365 1024 831"><b>4. For Oracle 19c only,</b> update the <code>sqlnet.ora</code> file. Failure to do this will result in the error <code>ORA-01017 : invalid username/password; logon denied</code> when you try to connect to the database. Edit <code>sqlnet.ora</code> in <code>\$ORACLE_HOME/network/admin</code> to match the following:</p> <pre data-bbox="597 869 1024 1346">NAMES.DIRECTORY_PATH=(TNSNAMES, ONAMES, HOSTNAME) SQLNET.EXPIRE_TIME= 10 SQLNET.INBOUND_CONNECT_TIMEOUT =60 SQLNET.ALLOWED_LOGON_VERSION_SERVER=10 HTTPS_SSL_VERSION=undetermined</pre> <p data-bbox="597 1383 1024 1419"><b>5. Test connectivity:</b></p> <pre data-bbox="597 1457 1024 1528">\$ sqlplus apps/****@vis</pre>	

Task	Description	Skills required
Configure the database.	<p>Now that you have tested the connectivity to the database, you can configure the database with the appsutil utility to create the context-enabled environment.</p> <p><b>For Oracle 12.1.0.2:</b></p> <p>1. Run the following commands:</p> <pre data-bbox="594 743 1029 1579">\$ cd \$ORACLE_HOME/appsutil/bin \$ perl adbldxml.pl   appsuser=apps Enter Hostname of   Database server: oebs- db01 Enter Port of Database   server: 1521 Enter SID of Database   server: VIS Enter Database Service   Name: VIS Enter the value for   Display Variable: :1 The context file has   been created at:   /rdsdbbin/oracle/   appsutil/VIS_oebs-   db01.xml</pre> <p>2. Create oraInst.loc from root user:</p> <pre data-bbox="594 1738 1029 1869">\$ vi /etc/oraInst.loc inventory_loc=/rdsdbbin/oracle.12.1.c</pre>	DBA

Task	Description	Skills required
	<pre> custom.r1.EE.1/oraI nventory inst_group=database </pre> <p>3. Clone the context file to set the logical hostname by using the context file you created in the previous step. As the rdsdb user, run:</p> <pre> \$ cd \$ORACLE_HOME/appsutil/clone/bin \$ perl adclonectx.pl \ contextfile=[ORACLE_HOME]/appsutil/ [current context file] \ template=[ORACLE_HOME]/appsutil/te mplate/adxdbctx.tmp </pre> <p>where <code>oebs-db01log</code> refers to the logical hostname. For example:</p> <pre> \$ perl adclonectx.pl \ contextfile=/rdsdbbin/oracle.12.1.custom.r1.EE.1/appsutil/VIS_oebs-db01.xml \ template=/rdsdbbin/oracle/appsutil/ template/adxdbctx.tmp Target System Hostname (virtual or normal) [oebs-db01] : oebs- db01log Target System Base Directory : /rdsdbbin/ oracle </pre>	

Task	Description	Skills required
	<p>Target Instance is RAC (y/n) [n] : n</p> <p>Target System Database SID : VIS</p> <p>Oracle OS User [rdsdb] :</p> <p>Oracle OS Group [rdsdb] : database</p> <p>Role separation is supported y/n [n] ? : n</p> <p>Target System utl_file_ dir Directory List : / tmp</p> <p>Number of DATA_TOP's on the Target System [1] :</p> <p>Target System DATA_TOP Directory 1 [/rdsdbbi n/oracle/data] : / rdsbdbdata/db/VIS_A/ datafile/</p> <p>Target System RDBMS ORACLE_HOME Directory [/rdsdbbin/oracle/ 12.1.0] : /rdsdbbin/ oracle</p> <p>Do you want to preserve the Display [:1] (y/n) : y</p> <p>Do you want the target system to have the same port values as the source system (y/n) [y] ? : y</p> <p>The new database context file has been created :</p>	

Task	Description	Skills required
	<pre data-bbox="609 210 1015 577">/rdsdbbin/oracle.12.1.custom.r1.EE.1/appsutil/clone/bin/VIS_oebs-db01log.xml contextfile=/rdsdbbin/oracle.12.1.custom.r1.EE.1/appsutil/clone/bin/VIS_oebs-db01log.xml</pre> <p data-bbox="592 619 820 661"><b>For Oracle 19c:</b></p> <p data-bbox="592 703 885 787">1. Run the following commands:</p> <pre data-bbox="609 829 1015 1690">\$ cd \$ORACLE_HOME/appsutil/bin \$ perl adbldxml.pl   appsuser=apps Enter Hostname of Database server: oebs-db01 Enter Port of Database server: 1521 Enter SID of Database server: VIS Enter the database listener name:L_VI SCDB_001 Enter the value for Display Variable: :1 The context file has been created at: /rdsdbbin/oracle/appsutil/VIS_oebs-db01.xml</pre> <p data-bbox="592 1732 941 1816">2. Create oraInst.loc from root user:</p>	

Task	Description	Skills required
	<pre data-bbox="609 226 1015 445">\$ vi /etc/oraInst.loc inventory_loc=/rdsd bbin/oracle/oraInv entory inst_group=database</pre> <p data-bbox="592 487 1031 709">3. Clone the context file to set the logical hostname by using the context file you created in the previous step. As the rdsdb user, run:</p> <pre data-bbox="609 751 1015 1138">\$ cd \$ORACLE_HOME/appsu til/clone/bin \$ perl adclonctx.pl \ contextfile=[ORA CLE_HOME]/appsutil/ [current context file] \ template=[ORACLE _HOME]/appsutil/te mplate/adxdbctx.tmp</pre> <p data-bbox="592 1180 1031 1318">where oebs-db01log refers to the logical hostname. For example:</p> <pre data-bbox="609 1360 1015 1801">\$ perl adclonctx.pl \ contextfile=/rdsdbbin/ oracle/appsutil/VIS_o ebs-db01.xml \ template=/rdsdbbin/ oracle/appsutil/ template/adxdbctx.tmp Target System Hostname (virtual or normal) [oebs-db01] : oebs- db01log</pre>	



Task	Description	Skills required
	<pre> Target System Base   Directory : /rdsdbbin/ oracle Target Instance is RAC (y/n) [n] : n Target System CDB Name : VISCDB Target System PDB Name : VIS Oracle OS User [oracle] : rdsdb Oracle OS Group [dba] : database Role separation is supported y/n [n] ? : n Number of DATA_TOP's on the Target System [2] : Target System DATA_TOP Directory 1 [/d01/ oracle/VISCDB] : / rdsdbdata/db/pdb/ VISCDB_A Target System DATA_TOP Directory 2 [/d01/ora cle/data] : /rdsdbdat a/db/pdb/VISCDB_A/ datafile Specify value for OSBACKUPDBA group [database] : Specify value for OSDGDBA group [database ] : Specify value for OSKMDBA group [database ] : Specify value for OSRACDBA group [database] : Target System RDBMS ORACLE_HOME Directory </pre>	

Task	Description	Skills required
	<pre> [/d01/oracle/19.0. 0] : /rdsdbbin/oracle Do you want to preserve the Display [:1] (y/n) : y Do you want the target system to have the same port values as the source system (y/n) [y] ? : y Validating if the source port numbers are available on the target system.. Complete port informati on available at / rdsdbbin/oracle/a ppsutil/clone/bin/ out/VIS_oebs-db01log/ portpool.lst New context path and file name [VIS_oebs -db01log.xml] : / rdsdbbin/oracle/a ppsutil/VIS_oebs-d b01log.xml Do you want to overwrite it (y/n) [n] ? : y Replacing /rdsdbbin /oracle/appsutil/V IS_oebs-db01log.xml file. The new database context file has been created : contextfile=/rdsdbbin/ oracle/appsutil/VIS_o ebs-db01log.xml Check Clone Context logfile /rdsdbbin/ oracle/appsutil/clone/ </pre>	

Task	Description	Skills required
	bin/CloneContext_0609141428.log for details.	

Task	Description	Skills required
Install ETCC and run Autoconfig.	<p>1. Install the Oracle E-Business Suite Technology Codelevel Checker (ETCC).</p> <p>Download patch 17537119 from <a href="#">My Oracle Support</a>, and follow the instructions in <code>README.txt</code>. You will create a directory called <code>etcc</code> in the <code>\$ORACLE_HOME</code> directory, unzip the patch to create a script called <code>checkMTpatch.sh</code>, and then run the script to check the patch versions.</p> <p>2. Run the Autoconfig utility, and pass the new logical hostname context file.</p> <p><b>For Oracle 12.1.0.2:</b></p> <pre>cd \$ORACLE_HOME/appsu til/bin \$ ./adconfig.sh   contextfile=/rdsdb bin/oracle.12.1.cu stom.r1.EE.1/appsu til/clone/bin/VIS_ oeb-db01log.xml</pre> <p><b>For Oracle 19c:</b></p> <p>Autoconfig expects the listener name to match CDBNAME. Therefore, the backed up original listener</p>	DBA

Task	Description	Skills required
	<p>configuration file will use L_&lt;CDBNAME&gt;_001 temporarily.</p> <pre data-bbox="609 380 1029 1856">\$ lsnrctl stop L_VISCDB_001 \$ cp -rp /rdsdbdata/config/listener.ora /rdsdbdata/config/listener.ora_orig \$ vi /rdsdbdata/config/listener.ora :%s/L_VISCDB_001/VISCDB/g \$ lsnrctl start VISCDB \$ cd /rdsdbbin/oracle/appsutil \$ . ./txkSetCfgCDB.env   dboraclehome=/rdsdbbin/oracle.19.custom.r1.EE-CDB.1  Oracle Home being passed: /rdsdbbin/oracle  \$ echo \$ORACLE_HOME /rdsdbbin/oracle.19.custom.r1.EE-CDB.1 \$ export ORACLE_SID=VISCDB \$ cd \$ORACLE_HOME/appsutil/bin \$ perl \$ORACLE_HOME/appsutil/bin/txkPostPDBCreationTasks.pl -dboraclehome=\$ORACLE_HOME -outdir=\$ORACLE_HOME/appsutil/log -cidsid=VISCDB</pre>	

Task	Description	Skills required
	<pre data-bbox="613 212 964 321">-pdbid=VIS -appsuser =apps -dbport=1521 - servicetype=onpremise</pre> <p data-bbox="613 369 867 478">Enter the APPS Password: &lt;apps password&gt;</p> <p data-bbox="613 527 964 636">Enter the CDB SYSTEM Password:&lt;password from secrets manager&gt;</p> <p data-bbox="591 743 959 961"><b>Note:</b> If your database directories have changed, follow the instructions in Oracle Support Note 2525754.1.</p>	

## Configure the TNS entries for Amazon RDS Custom and Oracle E-Business Suite

Task	Description	Skills required
Configure the TNS entries for Amazon RDS Custom and Oracle E-Business Suite.	<p data-bbox="591 1262 1016 1873">Autoconfig generates the TNS ifiles in the default locations. For Oracle 12.1.0.2 (which is a non-CDB) and for Oracle19c PDB the default location is \$ORACLE_HOME/network/admin/\$&lt;CONTEXT_NAME&gt;. The CDB for Oracle 19c uses the default \$ORACLE_HOME/network/admin/, as defined by \$TNS_ADMIN in the environment files that</p>	DBA

Task	Description	Skills required
	<p>are generated when you ran Autoconfig in the previous steps.</p> <p>For Oracle 12.1.0.2 and 19c CDB, you won't use these because the <code>tnsnames.ora</code> and <code>listener.ora</code> files generated by Autoconfig do not adhere to the Amazon RDS requirements, such as no white spaces or comments. Instead, you use the generic files provided with the Amazon RDS Custom database to ensure compliance with what the system is expecting and to reduce the margin for error.</p> <p>For example, Amazon RDS Custom expects the following naming format:</p> <pre>L_&lt;INSTANCE_NAME&gt;_001</pre> <p>For Oracle 12.1.0.2 this would be:<pre>L_VIS_001</pre><p>For Oracle 19c, this would be:</p><pre>L_VISCDB_001</pre></p>	

Task	Description	Skills required
	<p>Here's an example of the <code>listener.ora</code> file that you will be using. This was generated when you created the Amazon RDS Custom database. At this point, you haven't made any changes to this file and you will be leaving it as the default.</p> <p><b>For Oracle 12.1.0.2:</b></p> <pre data-bbox="594 743 1029 1701">\$ cd \$ORACLE_HOME/netwo rk/admin \$ cat listener.ora ADR_BASE_L_VIS_001=/ rdsbdbdata/log/ SID_LIST_L_VIS_ 001=(SID_LIST =   (SID_DESC = (SID_NAME     = VIS)(GLOBAL_DBNAME =     VIS) (ORACLE_HOME = /     rdsdbbin/oracle))) L_VIS_001=(DESCR IPTION_LIST =   (DESCRIPTION =     (ADDRESS = (PROTOCOL     = TCP)(PORT = 1521)     (HOST = xx.xx.xx.     xx))) (DESCRIPTION =     (ADDRESS = (PROTOCOL =     TCP)(PORT = 1521)(HOST     = 127.0.0.1)))) SUBSCRIBE_FOR_NODE_DOW N_EVENT_L_VIS_001=OFF</pre> <p><b>For Oracle 19c:</b> Restore the original <code>listener.ora</code> file with the listener name</p>	



Task	Description	Skills required
	<pre>L_&lt;INSTANCE_NAME&gt;_ 001 .  \$ cd \$ORACLE_HOME/netwo rk/admin  \$ cp -rp /rdsdbdata/ config/listener.ora / rdsdbdata/config/ listener.ora_autoc onfig \$ cp -rp /rdsdbdat a/config/listener. ora_orig /rdsdbdata/ config/listener.ora  \$ cat listener.ora SUBSCRIBE_FOR_ NODE_DOWN_EVENT_L_ VISCDB_001=OFF ADR_BASE_L_VISCDB_001 =/rdsdbdata/log/ USE_SID_AS_SERVICE_ L_VISCDB_001=ON L_VISCDB_001=(DESCRI PTION_LIST = (DESCRIPT ION = (ADDRESS = (PROTOCOL = TCP)(PORT = 1521)(HOST = xx.xx.xx. xx))) (DESCRIPTION = (ADDRESS = (PROTOCOL = TCP)(PORT = 1521)(HOST = 127.0.0.1)))) SID_LIST_L_VISCDB_001= (SID_LIST = (SID_DESC = (SID_NAME = VISCDB)(G LOBAL_DBNAME = VISCDB) (ORACLE_HOME = / rdsdbbin/oracle)))</pre>	

Task	Description	Skills required
	<p>Start the listener L_&lt;INSTANCE_NAME&gt;_001 for standard Amazon RDS operations:</p> <pre data-bbox="592 426 1029 585">\$ lsnrctl stop \$ lsnrctl start L_VISCDB_001</pre> <p><b>For Oracle 12.1.0.2:</b></p> <p>Edit the Oracle E-Business Suite environment file to change the \$TNS_ADMIN path to use the Amazon RDS Custom generic TNS ifiles. The environment file was created when you ran Autoconfig earlier. Edit the TNS_ADMIN variable by removing the &lt;CONTEXT_NAME&gt; postfix.</p> <p><b>Note:</b> You should edit the environment file only in Oracle 12.1.0.2, because the default home for 19c is \$ORACLE_HOME/network/admin, which is the same as the default for Amazon RDS Custom.</p> <p>For example, in Oracle 12.1.0.2, edit the file:</p>	

Task	Description	Skills required
	<pre data-bbox="597 212 1024 327">\$ vi \$ORACLE_HOME/VIS_oebs-db01log.env</pre> <p data-bbox="597 365 922 401">Change the path from:</p> <pre data-bbox="597 436 1024 636">TNS_ADMIN="/rdsdbbin/oracle/network/admin/VIS_oebs-db01log" export TNS_ADMIN</pre> <p data-bbox="597 674 634 709">to:</p> <pre data-bbox="597 745 1024 905">TNS_ADMIN="/rdsdbbin/oracle/network/admin" export TNS_ADMIN</pre> <p data-bbox="597 942 1005 1167"><b>Note:</b> Every time you run Autoconfig, you must repeat this step to make sure that the correct TNS ifiles are being used. (12.1.0.2 only).</p> <p data-bbox="597 1205 818 1241"><b>For Oracle 19c:</b></p> <ol data-bbox="597 1287 984 1665" style="list-style-type: none"><li>1. Change the value for the database tier context variable <code>s_cdb_tnsadmin</code> to <code>&lt;ORACLE_HOME&gt;/network/admin</code> instead of <code>&lt;ORACLE_HOME&gt;/network/admin/&lt;CONTEXT_NAME&gt;</code> .</li></ol> <p data-bbox="597 1703 992 1835"><b>Note:</b> Do not update the <code>s_db_tnsadmin</code> context variable. Leave it as</p>	

Task	Description	Skills required
	<pre data-bbox="591 212 938 342">&lt;ORACLE_HOME&gt;/network/admin/&lt;CONTEXT_NAME&gt; .</pre> <div data-bbox="591 380 1029 541" style="border: 1px solid #ccc; border-radius: 10px; padding: 10px; margin: 10px 0;"> <pre data-bbox="610 405 964 512">\$ . \$ORACLE_HOME/VIS_oebs-db01log.env \$ vi \$CONTEXT_FILE</pre> </div> <p data-bbox="591 579 1029 709">2. Save the changes you made to the value of <code>s_cdb_tnsadmin</code> .</p> <p data-bbox="591 751 1029 1077">The values for <code>s_db_tnsadmin</code> and <code>s_cdb_tnsadmin</code> should look similar to the following, with the PDB name as <code>VIS</code> and the database node logical name as <code>oebs-db01log</code> .</p> <div data-bbox="591 1115 1029 1675" style="border: 1px solid #ccc; border-radius: 10px; padding: 10px; margin: 10px 0;"> <pre data-bbox="610 1140 980 1646">\$ grep -i tns_admin \$CONTEXT_FILE     &lt;TNS_ADMIN     oa_var="s_db_tnsadmin"&gt;/irdsdbbin/oracle/network/admin/VIS_oebs-db01log&lt;/TNS_ADMIN&gt;     &lt;CDB_TNS_ADMIN     oa_var="s_cdb_tnsadmin"&gt;/irdsdbbin/oracle/network/admin&lt;/CDB_TNS_ADMIN&gt;</pre> </div> <p data-bbox="591 1707 1029 1791">3. Run Autoconfig on the database tier:</p>	

Task	Description	Skills required
	<pre>\$ . \$ORACLE_HOME/VISCD B_oebs-db01log.env \$ export ORACLE_PD B_SID=VIS \$ sqlplus "/ as sysdba" @\$ORACLE_HOME/apps util/admin/adgrant s.sql APPS \$ sqlplus "/ as sysdba" @\$ORACLE_HOME/rdbms/ admin/utl1rp.sql  \$ . \$ORACLE_HOME/VIS_o ebs-db01log.env \$ echo \$ORACLE_SID VIS  \$ cd \$ORACLE_HOME/appsu til/scripts/\$CONTE XT_NAME \$ ./adautocfg.sh</pre>	

Task	Description	Skills required
Set the environment for the rdsdb user.	<p>Skip this step for Oracle 19c.</p> <p><b>For Oracle 12.1.0.2:</b></p> <p>Now that you have completed Autoconfig and TNS entries, you need to load the environment file by setting it in the rdsdb user's profile.</p> <p>Update <code>.bash_profile</code> to call the Oracle E-Business Suite database <code>.env</code> file. You need to update the profile to ensure that the environment is loaded. This environment file was created when you ran Autoconfig earlier.</p> <p>The following example environment file is created when you run Autoconfig:</p> <pre data-bbox="597 1241 1027 1356">. /rdsdbbin/oracle/V IS_oebs-db01log.env</pre> <p>As the rdsdb user:</p> <pre data-bbox="597 1472 1027 1833">cd \$HOME vi .bash_profile export LD_LIBRARY_PATH= \${ORACLE_HOME}/lib:\${ ORACLE_HOME}/ctx/lib export SHLIB_PATH= \${ORACLE_HOME}/lib export PATH=\$PATH: \${ORACLE_HOME}/bin</pre>	DBA

Task	Description	Skills required
	<pre>alias sql='rlwrap -c sqlplus / as sysdba' . \${ORACLE_HOME}/VIS _oebs-db01log.env</pre> <p><b>Note:</b> For Oracle 19c, you do not have to load the CDB environment in <code>.bash_profile</code>. This is because the default <code>ORACLE_HOME</code> is set to the default path <code>\$ORACLE_HOME/network/admin</code>, which is the default home of the <code>rdsdb</code> (Oracle home) user.</p>	

Task	Description	Skills required
Configure the application and database for Amazon RDS Custom.	<p>Complete the first two steps for both Oracle 12.1.0.2 and 19c. The subsequent steps differ for each version.</p> <ol style="list-style-type: none"><li>1. On the application tier, edit <code>/etc/hosts</code> and change the IP address for the database to the Amazon RDS Custom IP address:</li></ol> <pre data-bbox="594 709 1029 911">xx.xx.xx.xx OEBS-db01 .localdomain OEBS- db01 OEBS-db01log.local domain OEBS-db01log</pre> <p>Because you are using logical hostnames, you can replace the database node almost seamlessly.</p> <ol style="list-style-type: none"><li>2. On the Amazon RDS Custom DB instance, add or amend the security group that is assigned to the source EC2 instance to reflect the Amazon RDS Custom DB instance, to ensure that the application can access the node.</li></ol> <p><b>For Oracle 12.1.0.2:</b></p> <ol style="list-style-type: none"><li>3. Run Autoconfig. As application owner (for example, <code>app1mgr</code>), run:</li></ol>	DBA



Task	Description	Skills required
	<pre data-bbox="609 226 1015 445"> \$ cd \$INST_TOP/admin/scripts \$ ./adautocfg.sh AutoConfig completed successfully.</pre> <p data-bbox="592 487 950 571">4. Verify the fnd_nodes entries:</p> <pre data-bbox="609 613 1015 1075"> SQL&gt; select node_name        from apps.fnd_nodes        NODE_NAME ----- ----- ----- ----- ----- AUTHENTICATION OEBS-APP01LOG OEBS-DB01LOG</pre> <p data-bbox="592 1117 998 1201">5. Confirm that you can log in, and start the application:</p> <pre data-bbox="609 1243 1015 1318"> \$ ./adstrtal.sh</pre> <p data-bbox="592 1360 820 1390"><b>For Oracle 19c:</b></p> <p data-bbox="592 1432 990 1516">1. Check if the PDB is open, and open it if required:</p> <pre data-bbox="609 1600 1015 1766"> SQL&gt; show pdbs  CON_ID CON_NAME OPEN MODE RESTRICTED</pre>	

Task	Description	Skills required
	<pre> ----- ----- -----  2 PDB\$SEED      READ ONLY NO  3 VIS          MOUNTED  SQL&gt; alter session set container=vis;  SQL&gt; alter database open;  SQL&gt; alter database save state;  2. Test connectivity as apps:  SQL&gt; sqlplus apps/**** @vis  3. Run Autoconfig on the database tier:  \$ . \$ORACLE_HOME/VIS_o ebs-db01log.env \$ echo \$ORACLE_SID VIS  \$ cd \$ORACLE_HOME/appsu til/scripts/\$CONTE XT_NAME \$ ./adautocfg.sh  4. Run Autoconfig on the application tier as the application owner (for example, app1mgr): </pre>	

Task	Description	Skills required
	<pre data-bbox="609 226 1015 445">\$ cd \$INST_TOP/admin/scripts \$ ./adautocfg.sh AutoConfig completed successfully.</pre> <p data-bbox="592 485 950 569">5. Verify the fnd_nodes entries:</p> <pre data-bbox="609 625 1015 1081">SQL&gt; select node_name from apps.fnd_nodes NODE_NAME ----- ----- ----- ----- ----- AUTHENTICATION OEBS-APP01LOG OEBS-DB01LOG</pre> <p data-bbox="592 1121 933 1163">6. Start the application:</p> <pre data-bbox="609 1199 1015 1270">\$ ./adstrtal.sh</pre>	

## Perform post-migration steps

Task	Description	Skills required
Resume automation to confirm that it works.	<p data-bbox="592 1541 1015 1667">Resume automation by using the following AWS CLI command:</p> <pre data-bbox="609 1724 1015 1879">aws rds modify-db-instance \ --db-instance-identifier vis \</pre>	DBA

Task	Description	Skills required
	<pre data-bbox="594 205 1029 306">--automation-mode full \</pre> <p data-bbox="594 344 1029 716">The database is now managed by Amazon RDS Custom. For example, if the listener or database goes down, the Amazon RDS Custom agent will restart them. To test this, run commands such as the following.</p> <p data-bbox="594 758 915 793">Stop listener example:</p> <pre data-bbox="594 831 1029 949">-bash-4.2\$ lsnrctl stop vis</pre> <p data-bbox="594 987 1019 1022">Shutdown database example:</p> <pre data-bbox="594 1060 1029 1178">SQL&gt; shutdown immediate ;</pre>	

Task	Description	Skills required
Validate schema, connections, and maintenance tasks.	<p>To finalize the migration, you must perform the following tasks at a minimum.</p> <ul style="list-style-type: none"> <li>• Run FS_CLONE to synchronize the patch file system.</li> <li>• Gather schema statistics.</li> <li>• Ensure that external interfaces and systems can connect to the new Amazon RDS Custom database.</li> <li>• Set up your backups and maintenance schedules.</li> <li>• Verify that AD Online Patching (ADOP) is working as expected by issuing a cutover to switch the file systems.</li> </ul>	DBA

## Troubleshooting

Issue	Solution
You receive an ORA-01624 error when you try to drop the log files.	<p>If you receive an ORA-01624 error when you try to drop the log files, follow these steps.</p> <p>Issue the following command and wait until the status of the log files you want to drop is INACTIVE. For more information about the status codes in V\$log, see the <a href="#">Oracle documentation</a>. Here's an example command and its output:</p> <pre>SQL&gt; select group#, status from v\$log;</pre>

Issue	Solution
	<pre>GROUP# STATUS ----- 1 ACTIVE 2 CURRENT 3 UNUSED 4 UNUSED 5 UNUSED 6 UNUSED 6 rows selected.</pre> <p>In this example, log file 1 is ACTIVE, so you have to force a log file switch three times to ensure that the first new log file you added earlier has a status of CURRENT:</p> <pre>SQL&gt; alter system switch logfile; System altered. SQL&gt; alter system switch logfile; System altered. SQL&gt; alter system switch logfile; System altered.</pre> <p>Wait until all the log files that you want to drop are INACTIVE, as in the following example, and then run the DROP LOGFILE command.</p> <pre>SQL&gt; select group#, status from v\$log; GROUP# STATUS ----- 1 INACTIVE 2 INACTIVE 3 INACTIVE 4 CURRENT 5 UNUSED 6 UNUSED 6 rows selected.</pre>

Issue	Solution
<p>You receive an ORA-00392 error when you open the database with <code>resetlogs</code> .</p>	<p>If you receive the <i>error ORA-00392: log xx of thread 1 is being cleared, operation not allowed</i>, run the following command (replace <code>xx</code> with the log file number), and then rerun the <code>open resetlogs</code> command:</p> <pre data-bbox="831 491 1507 646">SQL&gt; alter database clear logfile group xx; SQL&gt; alter database open resetlogs;</pre>

Issue	Solution
<p>You have trouble connecting to the application using Sysadmin or application user.</p>	<p>To confirm the issue, run the following SQL query:</p> <pre data-bbox="829 346 1507 783">SQL&gt; select dbms_java.get_jdk_version() from dual; select dbms_java.get_jdk_version() from dual ERROR at line 1: ORA-29548: Java system class reported: release of Java system classes in the database (19.0.0.0.220719 1.8) does not match that of the oracle executable (19.0.0.0.0 1.8)</pre> <p><b>Root cause:</b> The source database was applied with multiple patches, but the Amazon RDS Custom DB_HOME is a new installation, or the CEV did not include all of the patches because you didn't use the necessary RSU patches, such as OJVM, when you created the CEV. To validate this, check if the source patch details are listed on <code>\$ORACLE_HOME/sqlpath</code> , <code>\$ORACLE_HOME/.patch_storage</code> , and <code>opatch -lsinventory</code> .</p> <p><b>Reference:</b> <i>datapatch -verbose Fails with Error : " Patch xxxxxx: Archived Patch Directory Is Empty"</i> (Doc ID 2235541.1)</p> <p><b>Fix:</b> Copy the missing patch-related files from the source (<code>\$ORACLE_HOME/sqlpatch/</code> ) to Amazon RDS Custom (<code>\$ORACLE_HOME/sqlpatch/</code> ), and then rerun <code>./datapatch -verbose</code> .</p> <p>For example:</p>



Issue	Solution
	<pre data-bbox="829 212 1507 365">-bash-4.2\$ cp -ip 18793246 20204035 20887355 22098146 22731026 \$ORACLE_H OME/sqlpatch/</pre> <p data-bbox="829 405 1471 533">Alternatively, you can use a workaround by running the following command on the CDB and PDB:</p> <pre data-bbox="829 569 1507 688">@?/javavm/install/update_javavm_db.s ql</pre> <p data-bbox="829 728 1495 762">Then run the following command on the PDB:</p> <pre data-bbox="829 800 1507 953">sql&gt; alter session set container=vis; @?/javavm/install/update_javav m_db.sql</pre> <p data-bbox="829 993 1170 1026">Now run the test again:</p> <pre data-bbox="829 1064 1507 1184">SQL&gt; select dbms_java.get_jdk_ version() from dual;</pre>

## Related resources

- [Working with Amazon RDS Custom](#) (Amazon RDS documentation)
- [Amazon RDS Custom for Oracle – New Control Capabilities in Database Environment](#) (AWS News blog)
- [Integrate Amazon RDS Custom for Oracle with Amazon EFS](#) (AWS Database blog)
- [Migrating Oracle E-Business Suite on AWS](#) (AWS whitepaper)
- [Oracle E-Business Suite architecture on AWS](#) (AWS whitepaper)
- [Set up an HA/DR architecture for Oracle E-Business Suite on Amazon RDS Custom with an active standby database](#) (AWS Prescriptive Guidance)

## Additional information

### Maintenance operations

#### *Patching Oracle E-Business Suite database home with new patches*

As the bin volume (/rdsdbbin) is an out-of-place upgrade, the contents of the bin volume are dropped during the [CEV upgrade](#). Therefore, you have to create a copy of the appsutil directory before you perform any upgrades by using CEV.

On the source Amazon RDS Custom instance, before you upgrade the CEV, take a backup of \$ORACLE\_HOME/appsutil.

**Note:** This example uses an NFS volume. However, you can use a copy to Amazon Simple Storage Service (Amazon S3) instead.

1. Make a directory to store appsutil on the source Amazon RDS Custom instance:

```
$ mkdir /RMAN/appsutil.preupgrade
```

2. Tar and copy to the Amazon EFS volume:

```
$ tar cvf /RMAN/appsutil.preupgrade appsutil
```

3. Verify that the tar file exists:

```
$ bash-4.2$ ls -l /RMAN/appsutil.preupgrade
-rw-rw-r-- 1 rdsdb rdsdb 622981120 Feb  8 20:16 appsutil.tar
```

4. Upgrade to the latest CEV (prerequisite CEV is already created) by following the instructions in [Upgrading an RDS Custom DB](#) instance in the Amazon RDS documentation).

You can also patch directly by using OPATCH. See the [Requirements and considerations for RDS Custom for Oracle Upgrades](#) section of the Amazon RDS documentation.

**Note:** The IP address of the host machine does not change during the CEV patching process. This process performs an out-of-place upgrade, and during startup a new bin volume is attached on the same instance.

# Migrate Oracle PeopleSoft to Amazon RDS Custom

Created by Gaurav Gupta (AWS)

<b>Environment:</b> Production	<b>Source:</b> Amazon EC2	<b>Target:</b> Amazon RDS Custom
<b>R Type:</b> Replatform	<b>Workload:</b> Oracle	<b>Technologies:</b> Migration; Infrastructure; Databases
<b>AWS services:</b> Amazon RDS; Amazon S3; AWS Secrets Manager; Amazon EFS		

## Summary

[Oracle PeopleSoft](#) is an enterprise resource planning (ERP) solution for enterprise-wide processes. PeopleSoft has a three-tier architecture: client, application, and database. PeopleSoft can be run on [Amazon Relational Database Service \(Amazon RDS\)](#). Now, you can also run PeopleSoft on [Amazon RDS Custom](#), which provides access to the underlying operating system.

[Amazon RDS Custom for Oracle](#) is a managed database service for legacy, custom, and packaged applications that require access to the underlying operating system and database environment. When you migrate your Oracle database to Amazon RDS Custom, Amazon Web Services (AWS) can manage backup tasks and high availability, while you can focus on maintaining your PeopleSoft application and functionality. For key factors to consider for a migration, see [Oracle database migration strategies](#) in AWS Prescriptive Guidance.

This pattern focuses on the steps to migrate a PeopleSoft database on Amazon Elastic Compute Cloud (Amazon EC2) to Amazon RDS Custom by using an Oracle Recovery Manager (RMAN) backup. It uses an [Amazon Elastic File System \(Amazon EFS\)](#) shared file system between the EC2 instance and Amazon RDS Custom, although you can also use Amazon FSx or any shared drive. The pattern uses an RMAN full backup (sometimes referred to as a level 0 backup).

## Prerequisites and limitations

### Prerequisites

- An Oracle version 19C source database that is running on Amazon EC2 with Oracle Linux 7, Oracle Linux 8, Red Hat Enterprise Linux (RHEL) 7, or RHEL 8. In the examples for this pattern, the source database name is FSDM092, but this isn't a requirement.

**Note:** You can also use this pattern with on-premises Oracle source databases. You must have the appropriate network connectivity between the on-premises network and a virtual private cloud (VPC).

- A PeopleSoft 9.2 demo instance.
- A single PeopleSoft application tier. However, you can adapt this pattern to work with multiple application tiers.
- Amazon RDS Custom configured with at least 8 GB of swap space.

## Limitations

This pattern doesn't support the following configurations:

- Setting the database ARCHIVE\_LAG\_TARGET parameter to a value outside the 60–7200 range
- Disabling the DB instance log mode (NOARCHIVELOG)
- Turning off the Amazon Elastic Block Store (Amazon EBS) optimized attribute of the EC2 instance
- Modifying the original EBS volumes attached to the EC2 instance
- Adding new EBS volumes or changing the volume type from gp2 to gp3
- Changing the extension format for the LOG\_ARCHIVE\_FORMAT parameter (requires \*.arc)
- Multiplexing or changing the control file location and name (it has to be /rdsdbdata/db/\*DBNAME\*/controlfile/control-01.ctl)

For additional information about these and other unsupported configurations, see the [Amazon RDS documentation](#).

## Product versions

For Oracle Database versions and instance classes supported by Amazon RDS Custom, see [Requirements and limitations for Amazon RDS Custom for Oracle](#).

## Architecture

### Target technology stack

- Application Load Balancer
- Amazon EFS
- Amazon RDS Custom for Oracle
- AWS Secrets Manager
- Amazon Simple Storage Service (Amazon S3)

## Target architecture

The following architecture diagram represents a PeopleSoft system running in a single [Availability Zone](#) on AWS. The application tier is accessed through an [Application Load Balancer](#). Both the application and the databases are in private subnets, and the Amazon RDS Custom and Amazon EC2 database instance use an Amazon EFS shared file system to store and access the RMAN backup files. Amazon S3 is used for creating the custom RDS Oracle engine and for storing the redo logs metadata.

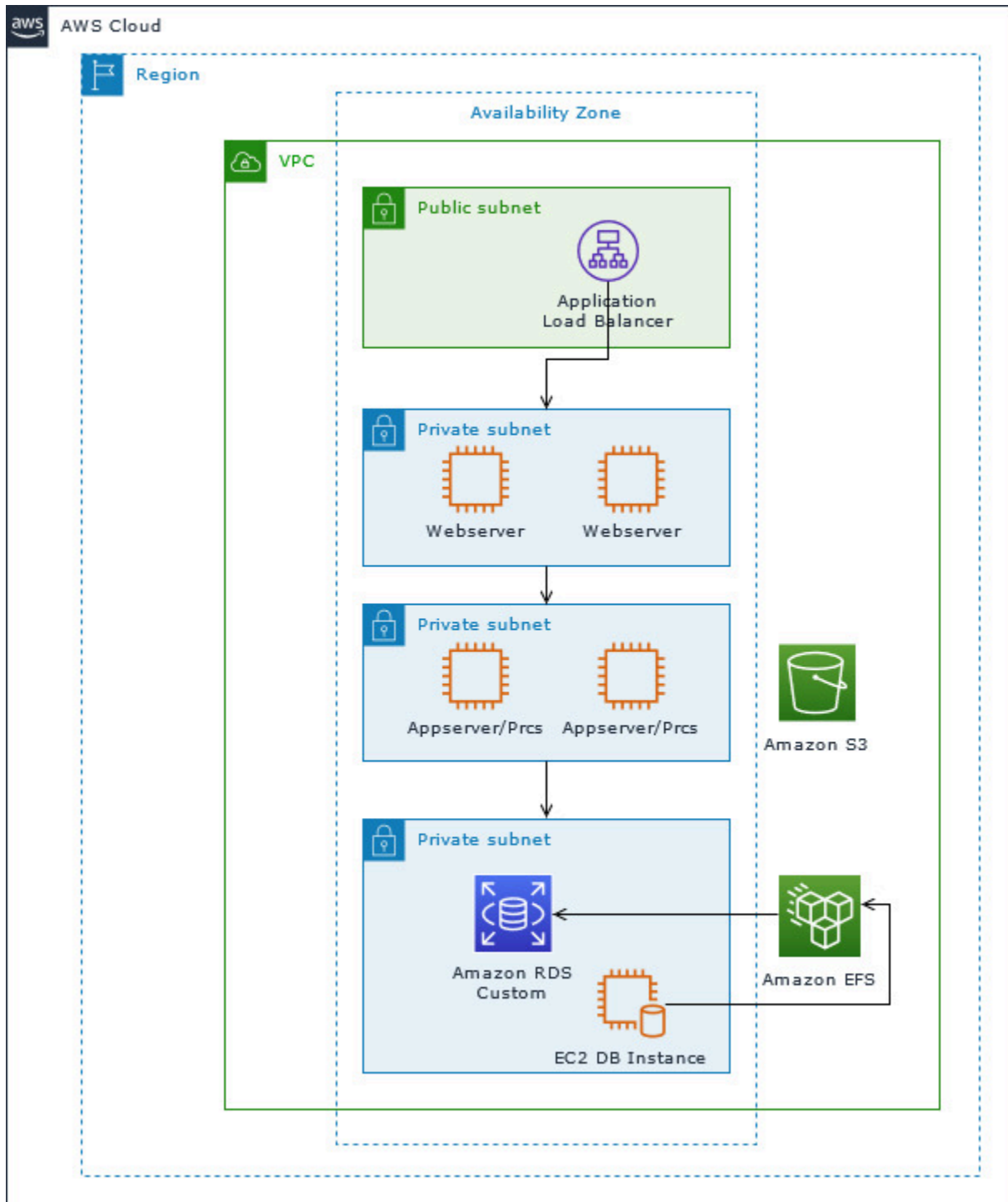

## Tools

## Tools

## AWS services

- [Amazon RDS Custom for Oracle](#) is a managed database service for legacy, custom, and packaged applications that require access to the underlying operating system and database environment. It automates database administration tasks, such as backups and high availability.
- [Amazon Elastic File System \(Amazon EFS\)](#) helps you create and configure shared file systems in the AWS Cloud. This pattern uses an Amazon EFS shared file system to store and access the RMAN backup files.
- [AWS Secrets Manager](#) helps you replace hardcoded credentials in your code, including passwords, with an API call to Secrets Manager to retrieve the secret programmatically. In this pattern, you retrieve the database user passwords from Secrets Manager to create the RDSADMIN and ADMIN users and to change the sys and system passwords.
- [Amazon Simple Storage Service \(Amazon S3\)](#) is a cloud-based object storage service that helps you store, protect, and retrieve any amount of data.
- [Elastic Load Balancing \(ELB\)](#) distributes incoming application or network traffic across multiple targets. For example, you can distribute traffic across Amazon Elastic Compute Cloud (Amazon EC2) instances, containers, and IP addresses in one or more Availability Zones. This pattern uses an Application Load Balancer.

### *Other tools*

- Oracle Recovery Manager (RMAN) provides backup and recovery support for Oracle databases. This pattern uses RMAN to perform a hot backup of the source Oracle database on Amazon EC2 that is restored on Amazon RDS Custom.

## **Best practices**

- For database initialization parameters, customize the standard pfile that's provided by the Amazon RDS Custom DB instance for PeopleSoft instead of using the spfile from the Oracle source database. This is because white spaces and comments cause issues when creating read replicas in Amazon RDS Custom. For more information about database initialization parameters, see Oracle Support Note 1100831.1 (requires an [Oracle Support](#) account).
- Amazon RDS Custom uses Oracle automatic memory management by default. If you want to use the Hugemem kernel, you can configure Amazon RDS Custom to use automatic shared memory management instead.
- Leave the `memory_max_target` parameter enabled by default. The framework uses this in the background to create read replicas.

- Enable Oracle Flashback Database. This feature is useful when reinstating the standby in failover (not switchover) testing scenarios.

## Epics

### Set up the DB instance and file system

Task	Description	Skills required
Create the DB instance.	<p>In the Amazon RDS console, create an Amazon RDS Custom for Oracle DB instance with a DB name called FSDMO92 (or your source database name).</p> <p>For instructions, see <a href="#">Working with Amazon RDS Custom</a> in the AWS documentation and the <a href="#">Amazon RDS Custom for Oracle – New Control Capabilities in Database Environment</a> blog post. This ensures that the database name is set to the same name as the source database. (If kept blank, the EC2 instance and database name will be set to ORCL.)</p>	DBA

### Perform an RMAN full backup of the source Amazon EC2 database

Task	Description	Skills required
Create a backup script.	Create an RMAN backup script to back up the database to	DBA



Task	Description	Skills required
	<p>the Amazon EFS file system that you mounted (/efs in the following example). You can use the example code or run one of your existing RMAN scripts.</p> <pre data-bbox="592 520 1031 1848"> #!/bin/bash Dt=`date +%Y%m%d-%H%M` BACKUP_LOG="rman-\${ORACLE_SID}-\${Dt}" export TAGDATE=`date +%Y%m%d%H%M`; LOGPATH=/u01/scripts/logs rman target / &gt;&gt;   \$LOGPATH/rman-\${ORACLE_SID}-\${Dt} &lt;&lt; EOF SQL "ALTER SYSTEM SWITCH LOGFILE"; SQL "ALTER SESSION SET NLS_DATE_FORMAT='D.D.MM.YYYY HH24:MI:SS'"; RUN {   ALLOCATE CHANNEL ch11   TYPE DISK MAXPIECESIZE   5G;   ALLOCATE CHANNEL ch12   TYPE DISK MAXPIECESIZE   5G;   BACKUP AS COMPRESSED   BACKUPSET FULL DATABASE   FORMAT '/efs/rman_backup/FSCM/%d_%T_%s_%p_FULL' ;   SQL "ALTER SYSTEM ARCHIVE LOG CURRENT"; </pre>	

Task	Description	Skills required
	<pre> BACKUP FORMAT '/efs/ rman_backup/FSCM/%d_ %T_%s_%p_ARCHIVE ' ARCHIVELOG ALL DELETE ALL INPUT ; BACKUP CURRENT CONTROLFILE FORMAT '/ efs/rman_backup/FSCM/ %d_%T_%s_%p_CONTROL ' ; } EXIT; EOF </pre>	
Run the backup script.	<p>To run the RMAN backup script, log in as the Oracle Home User, and run the script.</p> <pre> \$ chmod a+x rman_backup.sh \$ ./rman_backup.sh &amp; </pre>	DBA

Task	Description	Skills required
<p>Check for errors and note the name of the backup file.</p>	<p>Check the RMAN log file for errors. If everything looks fine, list the backup of the control file by running the following command.</p> <pre data-bbox="594 489 1029 768"> RMAN&gt; list backup of controlfile;  using target database control file instead of recovery catalog </pre> <p>Note the name of the output file.</p> <pre data-bbox="594 926 1029 1852"> List of Backup Sets =====  BS Key   Type LV Size         Device Type Elapsed Time Completion Time -----  - -----  12      Full   21.58M         DISK           00:00:01         13-JUL-22         BP Key: 12         Status: AVAILABLE         Compressed: NO   Tag:         TAG20220713T150155         Piece Name: /         efs/rman_backup/F         SCM/FSDM092_202207         13_12_1_CONTROL         Control File Included:         Ckp SCN: 165591599 </pre>	<p>DBA</p>

Task	Description	Skills required
	<p data-bbox="613 212 946 279">85898 Ckp time: 13-JUL-22</p> <p data-bbox="591 344 1019 663">You will use the backup control file <code>/efs/rman_backup/FSCM/FSDMO92_20220713_12_1_CONTROL</code> when you restore the database on Amazon RDS Custom.</p>	

### Shut down the source application tier

Task	Description	Skills required
Shut down the application.	<p data-bbox="591 947 946 1171">To shut down the source application tier, use the <code>psadmin</code> utility or the <code>psadmin</code> command line utility.</p> <ol data-bbox="591 1220 946 1346" style="list-style-type: none"> <li data-bbox="591 1220 946 1346">1. To shut down the webserver, run the following command.</li> </ol> <pre data-bbox="646 1388 1029 1545">psadmin -w shutdown -d "webserver domain name"</pre> <ol data-bbox="591 1562 1029 1688" style="list-style-type: none"> <li data-bbox="591 1562 1029 1688">2. To shut down the application server, run the following command.</li> </ol> <pre data-bbox="646 1730 1029 1887">psadmin -c shutdown -d "application server domain name"</pre>	DBA, PeopleSoft Administrator

Task	Description	Skills required
	<p>3. To shut down the process scheduler, run the following command.</p> <pre>psadmin -p stop -d "process scheduler domain name"</pre>	

### Configure the target Amazon RDS Custom database

Task	Description	Skills required
Install the nfs-utils rpm package.	<p>To install the nfs-utils rpm package, run the following command.</p> <pre>\$ yum install -y nfs-utils</pre>	DBA
Mount the EFS storage.	<p>Get the Amazon EFS mount command from the Amazon EFS console page. Mount the EFS file system on the Amazon RDS instance by using a Network File System (NFS) client.</p> <pre>sudo mount -t nfs4 -o nfsvers=4.1,rsize=1048576,wsize=1048576,hard,timeo=600,retrans=2,noresvport fs-xxxxxxxxx.efs.eu-west-1.amazonaws.com:/ /efs</pre>	DBA

Task	Description	Skills required
	<pre>sudo mount -t nfs4 -o nfsvers=4.1,rsize= 1048576,wsize=1048 576,hard,timeo=600 ,retrans=2,noresvp ort fs-xxxxxxxxx.efs. eu-west-1.amazonaw s.com:/ /efs</pre>	

## Drop the starter database and create the directories to store the database files

Task	Description	Skills required
Pause automation mode.	<p>You have to pause <a href="#">automation mode</a> on your Amazon RDS Custom DB instance before you proceed with the next steps, to make sure that automation doesn't interfere with the RMAN restore activity.</p> <p>You can pause the automation by using the AWS console or the AWS Command Line Interface (AWS CLI) command (make sure that you have <a href="#">configured the AWS CLI</a> first).</p> <pre>aws rds modify-db- instance \ --db-instance-id entifier peoplesoft- fscm-92 \ --automation-mode all- paused \</pre>	DBA

Task	Description	Skills required
	<pre data-bbox="597 210 1026 386">--resume-full-automation-mode-minute 360 \ --region eu-west-1</pre> <p data-bbox="591 424 1000 793">When you specify the duration of the pause, make sure that you leave enough time for the RMAN restore. This depends on the size of the source database, so modify the 360 value accordingly.</p> <p data-bbox="591 835 1023 1062">Also, make sure that the total time of the paused automation does not overlap with the backup or maintenance window of the database.</p>	

Task	Description	Skills required
Create and modify the parameter file for PeopleSoft	<p>To create and modify the pfile for PeopleSoft, use the standard pfile created with the Amazon RDS Custom DB instance. Add the parameters you need for PeopleSoft.</p> <ol style="list-style-type: none"><li>1. Switch to <code>rds_user rdsdb</code> by running the following command.</li></ol> <pre data-bbox="630 709 1029 793">\$ sudo su - rdsdb</pre> <ol style="list-style-type: none"><li>2. Log in to SQL*Plus on the starter database, and create the pfile by running the following command.</li></ol> <pre data-bbox="630 1024 1029 1142">SQL&gt; create pfile from spfile;</pre> <p>This creates the pfile in <code>\$ORACLE_HOME/dbs</code> .</p> <ol style="list-style-type: none"><li>3. Make a backup of this pfile.</li><li>4. Edit the pfile to add or update PeopleSoft parameters.</li></ol> <pre data-bbox="630 1507 1029 1835">*._gby_hash_aggregation_enabled=false  *._unnest_subquery=false  *.nls_language='AMERICAN'</pre>	DBA



Task	Description	Skills required
	<pre> *.nls_length_sem antics='CHAR'  *.nls_territ ory='AMERICA'  *.open_cursors=1000  *.db_files=1200  *.undo_tablespace=' UNDOTBS1' </pre> <p>PeopleSoft related parameters can be found in <a href="#">Oracle Support</a> Note 1100831.1.</p> <p>5. Remove the spfile reference from the pfile.</p> <pre> *.spfile='/rdsdbbi n/oracle/dbs/spfil eFSDM092.ora' </pre>	
Drop the starter database.	<p>To drop the existing Amazon RDS Custom database, use the following code.</p> <pre> \$ sqlplus / as sysdba SQL&gt; shutdown immediate ; SQL&gt; startup mount exclusive restrict; SQL&gt; drop database; SQL&gt; exit </pre>	

Task	Description	Skills required
<p>Restore the Amazon RDS Custom database from the backup.</p>	<p>Restore the database by using the following script. The script will first restore the control file and then restore the entire database from the backup pieces stored on the EFS mount.</p> <pre data-bbox="594 583 1027 1875"> #!/bin/bash Dt=`date +%Y%m%d-%H%M` BACKUP_LOG="rman-\${ORACLE_SID}-\${Dt}" export TAGDATE=`date +%Y%m%d%H%M`; LOGPATH=/irdsdbdata/scripts/logs rman target / &gt;&gt;   \$LOGPATH/rman-\${ORACLE_SID}-\${Dt} &lt;&lt; EOF restore controlfile from "/efs/iman_backup/FSCM/FSDM092_20220713_12_1_CONTROL"; alter database mount; run { set newname for database to '/irdsdbdata/db/FSDM092_A/datafile/%f_%b'; SET NEWNAME FOR TEMPFILE 1 TO '/irdsdbdata/db/FSDM092_A/datafile/%f_%b'; RESTORE DATABASE; SWITCH DATAFILE ALL; SWITCH TEMPFILE ALL; RECOVER DATABASE; </pre>	<p>DBA</p>

Task	Description	Skills required
	<pre>} EOF sqlplus / as sysdba &gt;&gt; \$LOGPATH/iman-#{ORACLE_SID}-\$Dt&lt;&lt;-EOF ALTER DATABASE RENAME FILE '/u01/psoft/db/oradata/FSDM092/redo01.log' TO '/rdsdbdata/db/FSDM092_A/onlineolog/redo01.log'; ALTER DATABASE RENAME FILE '/u01/psoft/db/oradata/FSDM092/redo02.log' TO '/rdsdbdata/db/FSDM092_A/onlineolog/redo02.log'; ALTER DATABASE RENAME FILE '/u01/psoft/db/oradata/FSDM092/redo03.log' TO '/rdsdbdata/db/FSDM092_A/onlineolog/redo03.log'; alter database clear unarchived logfile group 1; alter database clear unarchived logfile group 2; alter database clear unarchived logfile group 3; alter database open resetlogs; EXIT EOF</pre>	

## Retrieve passwords from Secrets Manager, create users, and change passwords

Task	Description	Skills required
Retrieve the password from Secrets Manager.	<p>You can perform this step by using the AWS console or the AWS CLI. The following steps show instructions for the console.</p> <ol style="list-style-type: none"><li>1. Sign in to the AWS Management Console and open the Amazon RDS console.</li><li>2. In the navigation pane, choose <b>Databases</b>, and then select the Amazon RDS database.</li><li>3. Choose the <b>Configuration</b> tab, and note the resource ID for the instance. It will be in the format db-<code>&lt;ID&gt;</code> (for example, db-73GJNH LGDNZND0XNWXSECUW6 LE ).</li><li>4. Open the Secrets Manager console.</li><li>5. Choose the secret that has the same name as do-not-delete-custom-<code>&lt;resource_id&gt;</code> , where <code>resource-id</code> refers to the resource ID that you noted in step 3.</li><li>6. Choose <b>Retrieve secret value</b>.</li></ol>	DBA

Task	Description	Skills required
	This password will be same for the sys, system, rdsadmin, and admin users.	

Task	Description	Skills required
Create the RDSADMIN user.	<p>RDSADMIN is the database user for monitoring and orchestrating the Amazon RDS Custom DB instance. Because the starter database was dropped and the target database was restored from the source using RMAN, you must recreate this user after the restore operation to make sure that Amazon RDS Custom monitoring works as expected. You also must create a separate profile and tablespace for the RDSADMIN user.</p> <ol style="list-style-type: none"><li>1. Enter the following commands at a SQL prompt.</li></ol> <pre data-bbox="630 1192 1029 1787">SQL&gt; set echo on       feedback on serverout       on SQL&gt; @?/rdbms/admin/ utlpwdmg.sql SQL&gt; ALTER PROFILE       DEFAULT       LIMIT       FAILED_LOGIN_       ATTEMPTS UNLIMITED       PASSWORD_LIFE_TIME       UNLIMITED       PASSWORD_VERIFY_F       UNCTION NULL;</pre>	DBA

Task	Description	Skills required
	<p>2. Create the profile RDSADMIN.</p> <pre> SQL&gt; set echo on       feedback on serverout       on SQL&gt; alter session set       "_oracle_script"=true; SQL&gt; CREATE PROFILE       RDSADMIN       LIMIT       COMPOSITE_LIMIT       UNLIMITED       SESSIONS_PER_USER       UNLIMITED       CPU_PER_SESSION       UNLIMITED       CPU_PER_CALL       UNLIMITED       LOGICAL_READS_PER       _SESSION UNLIMITED       LOGICAL_READS_PER       _CALL UNLIMITED       IDLE_TIME UNLIMITED       CONNECT_TIME       UNLIMITED       PRIVATE_SGA       UNLIMITED       FAILED_LOGIN_ATTE       MPTS 10       PASSWORD_LIFE_TIME       UNLIMITED       PASSWORD_REUSE_TIME       UNLIMITED       PASSWORD_REUSE_MAX       UNLIMITED       PASSWORD_VERIFY_F       UNCTION NULL       PASSWORD_LOCK_TIME       86400/86400           </pre>	

Task	Description	Skills required
	<pre>PASSWORD_GRACE_TIME 604800/86400;</pre> <p>3. Create the RDSADMIN tablespace.</p> <pre>SQL&gt; CREATE BIGFILE TABLESPACE rdsadmin '/rdsdbdata/db/FSD M092_A/datafile/rd sadmin.dbf' DATAFILE SIZE 7M AUTOEXTEND ON NEXT 1m LOGGING ONLINE PERMANENT BLOCKSIZE 8192 EXTENT MANAGEMEN T LOCAL AUTOALLOCATE DEFAULT NOCOMPRES S SEGMENT SPACE MANAGEMENT AUTO;</pre> <p>4. Create the RDSADMIN user. Replace the RDSADMIN password with the password you obtained earlier from Secrets Manager.</p> <pre>SQL&gt; CREATE USER rdsadmin IDENTIFIED BY xxxxxxxxxxxx DEFAULT TABLESPACE rdsadmin TEMPORARY TABLESPACE TEMP profile rdsadmin ;</pre> <p>5. Grant privileges to RDSADMIN.</p>	



Task	Description	Skills required
	<pre>SQL&gt; GRANT "CONNECT" TO RDSADMIN WITH ADMIN OPTION; SQL&gt; GRANT "RESOURCE " TO RDSADMIN WITH ADMIN OPTION; SQL&gt; GRANT "DBA" TO RDSADMIN; SQL&gt; GRANT "SELECT_C ATALOG_ROLE" TO RDSADMIN WITH ADMIN OPTION; SQL&gt; GRANT ALTER SYSTEM TO RDSADMIN; SQL&gt; GRANT UNLIMITED TABLESPACE TO RDSADMIN; SQL&gt; GRANT SELECT ANY TABLE TO RDSADMIN; SQL&gt; GRANT ALTER DATABASE TO RDSADMIN; SQL&gt; GRANT ADMINISTER DATABASE TRIGGER TO RDSADMIN; SQL&gt; GRANT ANY OBJECT PRIVILEGE TO RDSADMIN WITH ADMIN OPTION; SQL&gt; GRANT INHERIT ANY PRIVILEGES TO RDSADMIN; SQL&gt; ALTER USER RDSADMIN DEFAULT ROLE ALL;</pre> <p>6. Set the SYS, SYSTEM, and DBSNMP user profiles to RDSADMIN.</p>	

Task	Description	Skills required
	<pre>SQL&gt; set echo on       feedback on serverout       on SQL&gt; alter user SYS       profile RDSADMIN; SQL&gt; alter user SYSTEM       profile RDSADMIN; SQL&gt; alter user DBSNMP       profile RDSADMIN;</pre>	
Create the master user.	<p>Because the starter database was dropped and the target database was restored from the source by using RMAN, you must recreate the master user. In this example, the master user name is admin.</p> <pre>SQL&gt; create user       admin identified by       &lt;password&gt;; SQL&gt; grant dba to admin</pre>	DBA

Task	Description	Skills required
Change the system passwords .	<p>Change the system passwords by using the password you retrieved from Secrets Manager.</p> <pre>SQL&gt; alter user   sys identified by   xxxxxxxxxxxx; SQL&gt; alter user   system identified by   xxxxxxxxxxxx;</pre> <p>If you don't change these passwords, Amazon RDS Custom displays the error message, "The database monitoring user or user credentials have changed."</p>	DBA

## Configure the TNS entries for Amazon RDS Custom and PeopleSoft

Task	Description	Skills required
Configure the tnsnames file.	<p>To connect to the database from the application tier, configure the <code>tnsnames.ora</code> file so you can connect to the database from the application tier. In the following example, you can see that there is a soft link to the <code>tnsnames.ora</code> file, but the file is empty by default.</p>	DBA

Task	Description	Skills required
	<pre data-bbox="609 226 1015 1081">\$ cd /rdsdbbin/oracle/network/admin \$ ls -ltr -rw-r--r-- 1 rdsdb database 1536 Feb 14 2018 shrept.lst lrwxrwxrwx 1 rdsdb database 30 Apr 5 13:19 listener.ora - &gt; /rdsbdbdata/config/ listener.ora lrwxrwxrwx 1 rdsdb database 28 Apr 5 13:19 sqlnet.ora - &gt; /rdsbdbdata/config/ sqlnet.ora lrwxrwxrwx 1 rdsdb database 30 Apr 5 13:19 tnsnames.ora - &gt; /rdsbdbdata/config/ tnsnames.ora</pre> <ol data-bbox="592 1123 1031 1837" style="list-style-type: none"><li>1. Create the <code>tnsnames.ora</code> entry. Because of the way Amazon RDS automation parses the files, you have to make sure that the entry doesn't contain any white spaces, comments, or extra lines. Otherwise, you might run into issues when using some of the APIs, such as <a href="#">as create-db-instance-read-replica</a>.</li><li>2. Replace the port, host, and SID in accordance with your PeopleSoft</li></ol>	

Task	Description	Skills required
	<p>database requirements. Use the following code as an example.</p> <pre data-bbox="630 380 1029 856">\$ vi tnsnames.ora  FSDM092=(DESCRIPTION = (ADDRESS_ LIST = (ADDRESS = (PROTOCOL = TCP)(HOST = x.x.x.x)(PORT = 1521))) (CONNECT_ DATA = (SERVER = DEDICATED) (SID = FSDM092)))</pre> <p>3. To confirm that the PeopleSoft database can be reached, run the following command.</p> <pre data-bbox="630 1087 1029 1856">\$ tnsping FSDM092  TNS Ping Utility for Linux: Version 19.0.0.0.0 - Production on 14- JUL-2022 10:16:45  Copyright (c) 1997, 2021, Oracle. All rights reserved.  Used parameter files: /rdsdbbin/oracle/net work/admin/sqlnet. ora  Used TNSNAMES adapter to resolve the alias</pre>	

Task	Description	Skills required
	<pre>Attempting to contact (DESCRIPT ION = (ADDRESS_ LIST = (ADDRESS = (PROTOCOL = TCP)(HOST = x.x.x.x)(PORT = 1521))) (CONNECT_ DATA = (SERVER = DEDICATED) (SID = FSDM092))) OK (0 msec)</pre>	

## Create the spfile softlink

Task	Description	Skills required
Create the spfile softlink.	<ol style="list-style-type: none"> <li data-bbox="592 951 1031 1182">1. To create spfile in the location <code>/rdsdbdata/admin/FSDM092/pfile</code> , run the following command. <div data-bbox="630 1220 1027 1457" style="border: 1px solid #ccc; border-radius: 10px; padding: 10px; margin: 10px 0;"> <pre>SQL&gt; create spfile='/ rdsdbdata/admin/FS DM092/pfile/spfile FSDM092.ora' from pfile;</pre> </div> </li> <li data-bbox="592 1472 1031 1602">2. Navigate to <code>\$ORACLE_HOME/dbs</code> , and create a soft link for the spfile. <div data-bbox="630 1640 1027 1837" style="border: 1px solid #ccc; border-radius: 10px; padding: 10px; margin: 10px 0;"> <pre>ln -s '/rdsdbdata/ admin/FSDM092/pfile/ spfileFSDM092.ora' spfileFSDM092.ora</pre> </div> </li> </ol>	DBA

Task	Description	Skills required
	3. After this file is created, you can shut down and start the database by using the spfile.	

## Perform post-migration steps

Task	Description	Skills required
Validate the schema, connections, and maintenance tasks.	To finalize the migration, perform the following tasks. <ul style="list-style-type: none"><li>• Gather schema statistics.</li><li>• Ensure that the PeopleSoft application tier can connect to the new Amazon RDS Custom database.</li><li>• Set up your backup and maintenance schedules.</li></ul>	DBA

## Related resources

- [Working with Amazon RDS Custom](#)
- [Amazon RDS Custom for Oracle – New Control Capabilities in Database Environment](#) (blog post)
- [Integrate Amazon RDS Custom for Oracle with Amazon EFS](#) (blog post)
- [Configuring Amazon RDS as an Oracle PeopleSoft Database](#) (AWS whitepaper)

# Migrate Oracle ROWID functionality to PostgreSQL on AWS

Created by Rakesh Raghav (AWS) and Ramesh Pathuri (AWS)

<b>Environment:</b> PoC or pilot	<b>Source:</b> Oracle Database	<b>Target:</b> PostgreSQL database on AWS
<b>R Type:</b> Replatform	<b>Workload:</b> Oracle	<b>Technologies:</b> Migration; Databases
<b>AWS services:</b> Amazon Aurora; Amazon RDS; AWS SCT; AWS CLI		

## Summary

This pattern describes options for migrating the ROWID pseudocolumn functionality in Oracle Database to a PostgreSQL database in Amazon Relational Database Service (Amazon RDS) for PostgreSQL, Amazon Aurora PostgreSQL-Compatible Edition, or Amazon Elastic Compute Cloud (Amazon EC2).

In an Oracle database, the ROWID pseudocolumn is a physical address of a row in a table. This pseudocolumn is used to uniquely identify a row even if the primary key isn't present on a table. PostgreSQL has a similar pseudocolumn called `ctid`, but it cannot be used as a ROWID. As explained in the [PostgreSQL documentation](#), `ctid` might change if it's updated or after every VACUUM process.

There are three ways you can create the ROWID pseudocolumn functionality in PostgreSQL:

- Use a primary key column instead of ROWID to identify a row in a table.
- Use a logical primary/unique key (which might be a composite key) in the table.
- Add a column with auto-generated values and make it a primary/unique key to mimic ROWID.

This pattern walks you through all three implementations and describes the advantages and disadvantages of each option.



## Prerequisites and limitations

### Prerequisites

- An active AWS account
- Procedural Language/PostgreSQL (PL/pgSQL) coding expertise
- Source Oracle Database
- An Amazon RDS for PostgreSQL or Aurora PostgreSQL-Compatible cluster, or an EC2 instance to host the PostgreSQL database

### Limitations

- This pattern provides workarounds for the ROWID functionality. PostgreSQL doesn't provide an equivalent to ROWID in Oracle Database.

### Product versions

- PostgreSQL 11.9 or later

## Architecture

### Source technology stack

- Oracle Database

### Target technology stack

- Aurora PostgreSQL-Compatible, Amazon RDS for PostgreSQL, or an EC2 instance with a PostgreSQL database

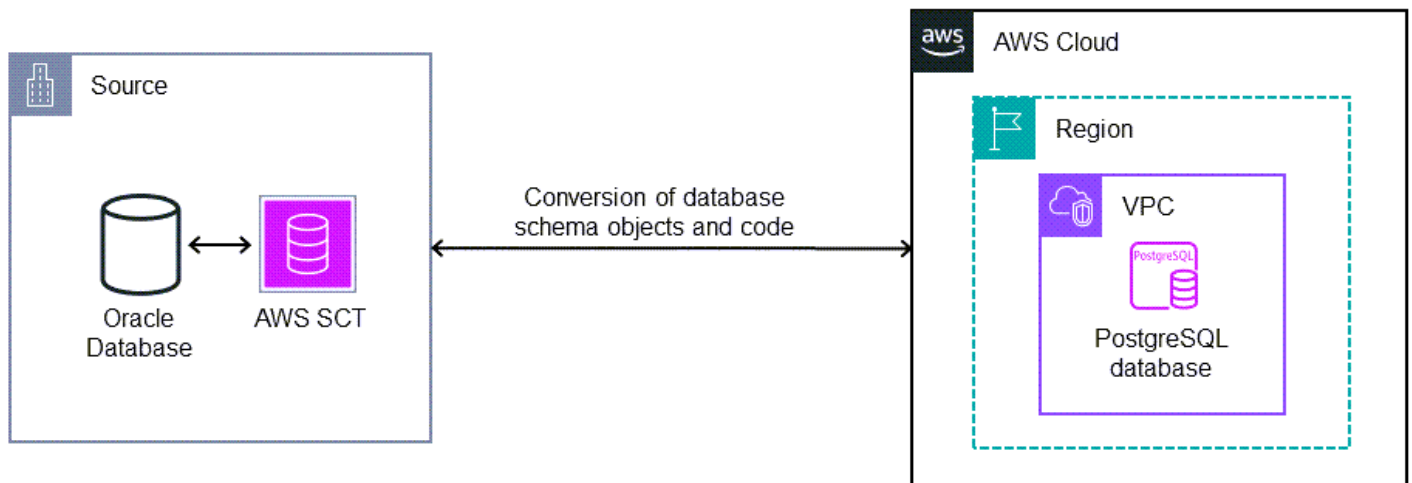

## Implementation options

There are three options to work around the lack of ROWID support in PostgreSQL, depending on whether your table has a primary key or unique index, a logical primary key, or an identity attribute. Your choice depends on your project timelines, your current migration phase, and dependencies on application and database code.

Option	Description	Advantages	Disadvantages
<b>Primary key or unique index</b>	If your Oracle table has a primary key, you can use the attributes of this key to uniquely identify a row.	<ul style="list-style-type: none"> <li>No dependency on proprietary database features.</li> <li>Minimal impact on performance, because primary key fields are indexed.</li> </ul>	<ul style="list-style-type: none"> <li>Requires changes to application and database code that relies on ROWID to switch to primary key fields.</li> </ul>
<b>Logical primary/unique key</b>	If your Oracle table has a logical primary key, you can use the attributes of this key to uniquely identify a row. A logical primary key consists of an	<ul style="list-style-type: none"> <li>No dependency on proprietary database features.</li> </ul>	<ul style="list-style-type: none"> <li>Requires changes to application and database code that relies on ROWID to switch to primary key fields.</li> </ul>

attribute or a set of attributes that can uniquely identify a row, but it isn't enforced on the database through a constraint.

- Significant impact on performance if the attributes of the logical primary key aren't indexed. However, you can add a unique index to prevent performance issues.

### Identity attribute

if your Oracle table doesn't have a primary key, you can create an additional field as GENERATED ALWAYS AS IDENTITY. This attribute generates a unique value whenever data is inserted into the table, so it can be used to uniquely identify a row for Data Manipulation Language (DML) operations.

- No dependency on proprietary database features.
- PostgreSQL database populates the attribute and maintains its uniqueness.
- Requires changes to application and database code that relies on ROWID to switch to identity attribute.
- Significant impact on performance if the additional field isn't indexed. However, you can add an index to prevent performance issues.

## Tools

- [Amazon Relational Database Service \(Amazon RDS\) for PostgreSQL](#) helps you set up, operate, and scale a PostgreSQL relational database in the AWS Cloud.
- [Amazon Aurora PostgreSQL-Compatible Edition](#) is a fully managed, ACID-compliant relational database engine that helps you set up, operate, and scale PostgreSQL deployments.

- [AWS Command Line Interface \(AWS CLI\)](#) is an open-source tool that helps you interact with AWS services through commands in your command-line shell. In this pattern, you can use the AWS CLI to run SQL commands through **pgAdmin**.
- [pgAdmin](#) is an open-source management tool for PostgreSQL. It provides a graphical interface that helps you create, maintain, and use database objects.
- [AWS Schema Conversion Tool \(AWS SCT\)](#) supports heterogeneous database migrations by automatically converting the source database schema and a majority of the custom code to a format that's compatible with the target database.

## Epics

### Identify the source tables

Task	Description	Skills required
Identify Oracle tables that use the ROWID attribute.	<p>Use the AWS Schema Conversion Tool (AWS SCT) to identify Oracle tables that have ROWID functionality. For more information, see the <a href="#">AWS SCT documentation</a>.</p> <p>—or—</p> <p>In Oracle, use the <code>DBA_TAB_COLUMNS</code> view to identify tables that have a ROWID attribute. These fields might be used to store alphanumeric 10-byte characters. Determine the usage and convert these to a VARCHAR field if appropriate.</p>	DBA or developer
Identify code that references these tables.	Use AWS SCT to generate a migration assessment report to identify procedures	DBA or developer

Task	Description	Skills required
	<p>affected by ROWID. For more information, see the <a href="#">AWS SCT documentation</a>.</p> <p>—or—</p> <p>In the source Oracle database, use the text field of the <code>dba_source</code> table to identify objects that use ROWID functionality.</p>	

## Determine primary key usage

Task	Description	Skills required
<p>Identify tables that don't have primary keys.</p>	<p>In the source Oracle database, use <code>DBA_CONSTRAINTS</code> to identify tables that don't have primary keys. This information will help you determine the strategy for each table. For example:</p> <pre data-bbox="594 1346 1029 1801"> select dt.* from dba_tables dt where not exists (select 1                     from all_constraints ct                     where ct.owner = Dt.owner and ct.table_name = Dt.table_name </pre>	<p>DBA or developer</p>

Task	Description	Skills required
	<pre> and ct.constraint_type = 'P' ) and dt.owner = '{schema}' </pre>	

## Identify and apply the solution

Task	Description	Skills required
Apply changes for tables that have a defined or logical primary key.	Make the application and database code changes shown in the <a href="#">Additional information</a> section to use a unique primary key or a logical primary key to identify a row in your table.	DBA or developer
Add an additional field to tables that don't have a defined or logical primary key.	Add an attribute of type GENERATED ALWAYS AS IDENTITY. Make the application and database code changes shown in the <a href="#">Additional information</a> section.	DBA or developer
Add an index if necessary.	Add an index to the additional field or logical primary key to improve SQL performance.	DBA or developer

## Related resources

- [PostgreSQL CTID](#) (PostgreSQL documentation)
- [Generated Columns](#) (PostgreSQL documentation)

- [ROWID Pseudocolumn](#) (Oracle documentation)

## Additional information

The following sections provide Oracle and PostgreSQL code examples to illustrate the three approaches.

### Scenario 1: Using a primary unique key

In the following examples, you create the table `testrowid_s1` with `emp_id` as the primary key.

*Oracle code:*

```
create table testrowid_s1 (emp_id integer, name varchar2(10), CONSTRAINT testrowid_pk
PRIMARY KEY (emp_id));
INSERT INTO testrowid_s1(emp_id,name) values (1,'empname1');
INSERT INTO testrowid_s1(emp_id,name) values (2,'empname2');
INSERT INTO testrowid_s1(emp_id,name) values (3,'empname3');
INSERT INTO testrowid_s1(emp_id,name) values (4,'empname4');
commit;
```

```
SELECT rowid,emp_id,name FROM testrowid_s1;
```

ROWID	EMP_ID	NAME
AAAF3pAAAAAAAM0AAA	1	empname1
AAAF3pAAAAAAAM0AAB	2	empname2
AAAF3pAAAAAAAM0AAC	3	empname3
AAAF3pAAAAAAAM0AAD	4	empname4

```
UPDATE testrowid_s1 SET name = 'Ramesh' WHERE rowid = 'AAAF3pAAAAAAAM0AAB' ;
commit;
```

```
SELECT rowid,emp_id,name FROM testrowid_s1;
```

ROWID	EMP_ID	NAME
AAAF3pAAAAAAAM0AAA	1	empname1
AAAF3pAAAAAAAM0AAB	2	Ramesh
AAAF3pAAAAAAAM0AAC	3	empname3
AAAF3pAAAAAAAM0AAD	4	empname4

*PostgreSQL code:*

```
CREATE TABLE public.testrowid_s1
```

```
(
  emp_id integer,
  name character varying,
  primary key (emp_id)
);

insert into public.testrowid_s1 (emp_id,name) values
(1,'empname1'),(2,'empname2'),(3,'empname3'),(4,'empname4');

select emp_id,name from testrowid_s1;
emp_id | name
-----+-----
      1 | empname1
      2 | empname2
      3 | empname3
      4 | empname4

update testrowid_s1 set name = 'Ramesh' where emp_id = 2 ;

select emp_id,name from testrowid_s1;
emp_id | name
-----+-----
      1 | empname1
      3 | empname3
      4 | empname4
      2 | Ramesh
```

## Scenario 2: Using a logical primary key

In the following examples, you create the table `testrowid_s2` with `emp_id` as the logical primary key.

*Oracle code:*

```
create table testrowid_s2 (emp_id integer, name varchar2(10) );
INSERT INTO testrowid_s2(emp_id,name) values (1,'empname1');
INSERT INTO testrowid_s2(emp_id,name) values (2,'empname2');
INSERT INTO testrowid_s2(emp_id,name) values (3,'empname3');
INSERT INTO testrowid_s2(emp_id,name) values (4,'empname4');
commit;

SELECT rowid,emp_id,name FROM testrowid_s2;
ROWID          EMP_ID NAME
```



```

-----
AAAF3rAAAAAAAMeAAA      1 empname1
AAAF3rAAAAAAAMeAAB      2 empname2
AAAF3rAAAAAAAMeAAC      3 empname3
AAAF3rAAAAAAAMeAAD      4 empname4

UPDATE testrowid_s2 SET name = 'Ramesh' WHERE rowid = 'AAAF3rAAAAAAAMeAAB' ;
commit;

SELECT rowid,emp_id,name FROM testrowid_s2;
ROWID          EMP_ID NAME
-----
AAAF3rAAAAAAAMeAAA      1 empname1
AAAF3rAAAAAAAMeAAB      2 Ramesh
AAAF3rAAAAAAAMeAAC      3 empname3
AAAF3rAAAAAAAMeAAD      4 empname4

```

### PostgreSQL code:

```

CREATE TABLE public.testrowid_s2
(
    emp_id integer,
    name character varying
);

insert into public.testrowid_s2 (emp_id,name) values
(1,'empname1'),(2,'empname2'),(3,'empname3'),(4,'empname4');

select emp_id,name from testrowid_s2;
 emp_id |  name
-----+-----
      1 | empname1
      2 | empname2
      3 | empname3
      4 | empname4

update testrowid_s2 set name = 'Ramesh' where emp_id = 2 ;

select emp_id,name from testrowid_s2;
 emp_id |  name
-----+-----
      1 | empname1
      3 | empname3

```

```
4 | empname4
2 | Ramesh
```

### Scenario 3: Using an identity attribute

In the following examples, you create the table `testrowid_s3` with no primary key and by using an identity attribute.

*Oracle code:*

```
create table testrowid_s3 (name varchar2(10));
INSERT INTO testrowid_s3(name) values ('empname1');
INSERT INTO testrowid_s3(name) values ('empname2');
INSERT INTO testrowid_s3(name) values ('empname3');
INSERT INTO testrowid_s3(name) values ('empname4');
commit;

SELECT rowid,name FROM testrowid_s3;
ROWID          NAME
-----
AAAF3sAAAAAAAMmAAA empname1
AAAF3sAAAAAAAMmAAB empname2
AAAF3sAAAAAAAMmAAC empname3
AAAF3sAAAAAAAMmAAD empname4

UPDATE testrowid_s3 SET name = 'Ramesh' WHERE rowid = 'AAAF3sAAAAAAAMmAAB' ;
commit;

SELECT rowid,name FROM testrowid_s3;
ROWID          NAME
-----
AAAF3sAAAAAAAMmAAA empname1
AAAF3sAAAAAAAMmAAB Ramesh
AAAF3sAAAAAAAMmAAC empname3
AAAF3sAAAAAAAMmAAD empname4
```

*PostgreSQL code:*

```
CREATE TABLE public.testrowid_s3
(
    rowid_seq bigint generated always as identity,
    name character varying
);
```

```
insert into public.testrowid_s3 (name) values
('empname1'),('empname2'),('empname3'),('empname4');
```

```
select rowid_seq,name from testrowid_s3;
```

```
rowid_seq | name
-----+-----
          1 | empname1
          2 | empname2
          3 | empname3
          4 | empname4
```

```
update testrowid_s3 set name = 'Ramesh' where rowid_seq = 2 ;
```

```
select rowid_seq,name from testrowid_s3;
```

```
rowid_seq | name
-----+-----
          1 | empname1
          3 | empname3
          4 | empname4
          2 | Ramesh
```

# Migrate Oracle Database error codes to an Amazon Aurora PostgreSQL-Compatible database

*Created by Sai Parthasaradhi (AWS) and Veeranjanyulu Grandhi (AWS)*

<b>Environment:</b> PoC or pilot	<b>Source:</b> Oracle	<b>Target:</b> PostgreSQL
<b>R Type:</b> Replatform	<b>Workload:</b> Oracle	<b>Technologies:</b> Migration; Databases
<b>AWS services:</b> Amazon Aurora		

## Summary

This pattern shows how to migrate Oracle Database error codes to an [Amazon Aurora PostgreSQL-Compatible Edition](#) database by using a predefined metadata table.

Oracle Database error codes don't always have a corresponding PostgreSQL error code. This difference in error codes can make it difficult to configure the processing logic of the procedures or functions in the target PostgreSQL architecture.

You can simplify the process by storing the source and target database error codes that are meaningful to your PL/pgSQL program in a metadata table. Then, configure the table to flag valid Oracle Database error codes and map them to their PostgreSQL equivalents before continuing with the remaining process logic. If the Oracle Database error code isn't in the metadata table, the process exits with the exception. Then, you can manually review the error details and add the new error code to the table if your program requires it.

By using this configuration, your Amazon Aurora PostgreSQL-Compatible database can handle errors in the same way that your source Oracle database does.

**Note:** Configuring a PostgreSQL database to handle Oracle Database error codes correctly usually requires changes to the database and application code.

## Prerequisites and limitations

### Prerequisites

- An active AWS account
- A source Oracle Database with instance and listener services up and running
- An Amazon Aurora PostgreSQL-Compatible cluster that's up and running
- Familiarity with Oracle Database
- Familiarity with PostgreSQL databases

## Architecture

The following diagram shows an example Amazon Aurora PostgreSQL-Compatible database workflow for data error code validation and handling:

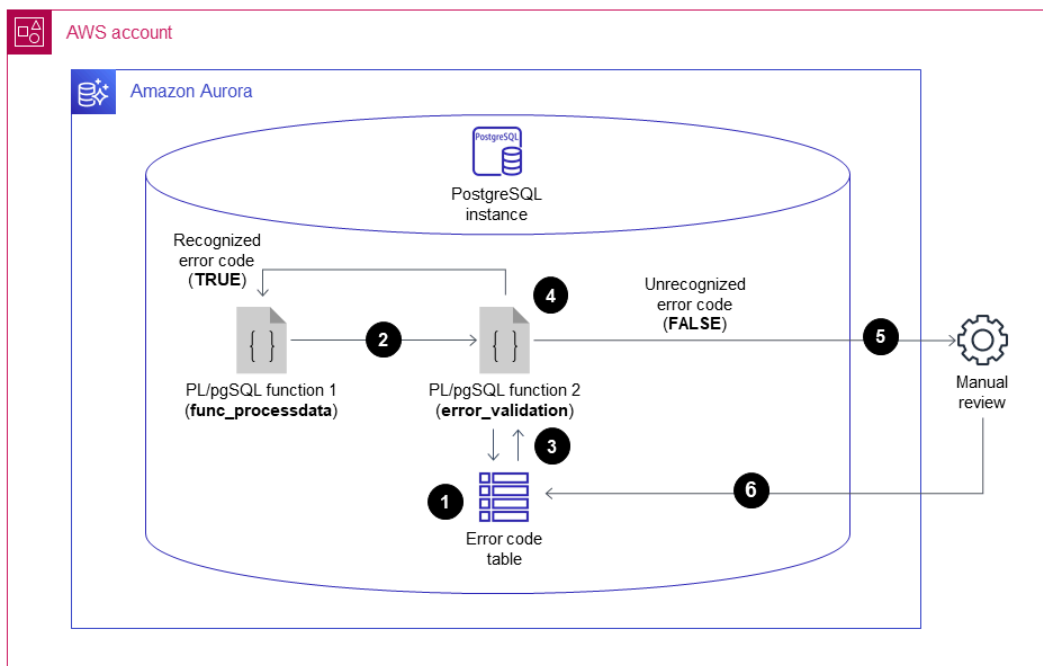

The diagram shows the following workflow:

1. A table holds Oracle Database error codes and classifications and their equivalent PostgreSQL error codes and classifications. The table includes a **valid\_error** column that classifies if specific, predefined error codes are valid or not.
2. When a PL/pgSQL function (**func\_processdata**) throws an exception, it invokes a second PL/pgSQL function (**error\_validation**).

3. The **error\_validation** function accepts the Oracle Database error code as an input argument. Then, the function checks the incoming error code against the table to see if the error is included in the table.
4. If the Oracle Database error code is included in the table, then the **error\_validation** function returns a **TRUE** value and the process logic continues. If the error code isn't included in the table, then the function returns a **FALSE** value, and the process logic exits with an exception.
5. When the function returns a **FALSE** value, then the error details are manually reviewed by the application's functional lead to determine its validity.
6. The new error code is then either manually added to the table or not. If the error code is valid and added to the table, then the **error\_validation** function returns a **TRUE** value the next time the exception occurs. If the error code isn't valid, and the process must fail when the exception occurs, then the error code isn't added to the table.

## Technology stack

- Amazon Aurora PostgreSQL
- pgAdmin
- Oracle SQL Developer

## Tools

- [Amazon Aurora PostgreSQL-Compatible Edition](#) is a fully managed, ACID-compliant relational database engine that helps you set up, operate, and scale PostgreSQL deployments.
- [pgAdmin](#) is an open-source administration and development tool for PostgreSQL. It provides a graphical interface that simplifies the creation, maintenance, and use of database objects.
- [Oracle SQL Developer](#) is a free, integrated development environment that simplifies the development and management of Oracle Database in both traditional and cloud deployments.

## Epics

### Migrate Oracle Database error codes to your Amazon Aurora PostgreSQL-Compatible database

Task	Description	Skills required
<p>Create a table in the Amazon Aurora PostgreSQL-Compatible database.</p>	<p>Run the following PostgreSQL <a href="#">CREATE TABLE</a> command:</p> <pre data-bbox="592 541 1026 1140"> (     source_error_code     numeric NOT NULL,      target_error_code     character varying NOT     NULL,      valid_error     character varying(1)     NOT NULL  ); </pre>	<p>PostgreSQL Developer , Oracle, RDS/Aurora for PostgreSQL</p>
<p>Add PostgreSQL error codes and their corresponding Oracle Database error codes to the table.</p>	<p>Run the PostgreSQL <a href="#">INSERT</a> command to add the required error code values to the <b>error_codes</b> table.</p> <p>The PostgreSQL error codes must use the character varying data type (<b>SQLSTATE</b> value). The Oracle error codes must use the numeric data type (<b>SQLCODE</b> value).</p> <p><b>Example Insert statements:</b></p>	<p>PostgreSQL Developer , Oracle, RDS/Aurora for PostgreSQL</p>

Task	Description	Skills required
<p>Create a PL/pgSQL function to validate error codes.</p>	<pre data-bbox="597 226 1024 604"> insert into error_codes values (-1817,'2007','Y'); insert into error_codes values (-1816,'2007','Y'); insert into error_codes values (-3114,'08006','N');</pre> <p data-bbox="597 646 1024 1014"><b>Note:</b> If you're catching Oracle-specific Java database connectivity (JDBC) exceptions, you must replace those exceptions with either generic cross-database exceptions or switch to PostgreSQL-specific exceptions.</p> <p data-bbox="597 1056 1024 1287">Create a PL/pgSQL function by running the PostgreSQL <a href="#">CREATE FUNCTION</a> command. Make sure that the function does the following:</p> <ul data-bbox="597 1329 1024 1759" style="list-style-type: none"> <li>• Accepts the Oracle error codes thrown by a program.</li> <li>• Checks if error codes are present in the <b>error_codes</b> table.</li> <li>• Returns <b>TRUE</b> or <b>FALSE</b> value, based on if the error code is present in the metadata table or not.</li> </ul>	<p>PostgreSQL Developer, Oracle, RDS/Aurora for PostgreSQL</p>



Task	Description	Skills required
Manually review new error codes as they're recorded by the PL/pgSQL function.	<p>Manually review the new error codes.</p> <p>If a new error code is valid for your use case, add it to the <b>error_codes</b> table by running the PostgreSQL <b>INSERT</b> command.</p> <p>-or-</p> <p>If a new error code isn't valid for your use case, don't add it to the table. The process logic will continue to fail and exit with exception when the error occurs.</p>	PostgreSQL Developer , Oracle, RDS/Aurora for PostgreSQL

## Related resources

[Appendix A. PostgreSQL Error Codes](#) (PostgreSQL documentation)

[Database error messages](#) (Oracle Database documentation)

# Migrate Redis workloads to Redis Enterprise Cloud on AWS

Created by Antony Prasad Thevaraj (AWS) and Srinivas Pendyala (Redis)

<b>Environment:</b> Production	<b>Source:</b> On-premises (Redis or other) database	<b>Target:</b> Redis Enterprise Cloud on AWS
<b>R Type:</b> Replatform	<b>Workload:</b> Open-source	<b>Technologies:</b> Migration; Databases
<b>AWS services:</b> AWS DMS; Amazon S3		

## Summary

This pattern discusses the high-level process for migrating Redis workloads to Redis Enterprise Cloud on Amazon Web Services (AWS). It describes the migration steps, provides information about the selection of tools available, and discusses the advantages, disadvantages, and steps for using each tool. Optionally, if you require additional help in migrating workloads from Redis, you can engage Redis Professional Services.

If you run Redis OSS or Redis Enterprise Software on premises, you're familiar with the significant administrative overhead and operational complexity of maintaining your Redis databases in your data center. By migrating your workloads to the cloud, you can significantly reduce this operational burden and take advantage of [Redis Enterprise Cloud](#), which is a fully hosted database as a service (DBaaS) offering from Redis. This migration helps increase your business agility, improves application reliability, and reduces overall costs while you gain access to the newest Redis Enterprise Cloud on AWS features such as 99.999% availability, architectural simplicity, and scale.

There are potential applications for Redis Enterprise Cloud in the financial services, retail, healthcare, and gaming sectors, as well as in use cases that require solutions for fraud detection, real-time inventory, claims processing, and session management. You can use Redis Enterprise Cloud to connect to your AWS resources—for example, to an application server that is running on Amazon Elastic Compute Cloud (Amazon EC2) instances, or to a microservice that is deployed as an AWS Lambda service.

## Prerequisites and limitations

### Assumptions

- You are currently operating an on-premises database system that you want to migrate to the cloud.
- You have identified the migration requirements for your workloads, including:
  - Data consistency requirements
  - Infrastructure and system environment requirements
  - Data mapping and transformation requirements
  - Functional testing requirements
  - Performance testing requirements
  - Validation requirements
  - Defined cutover strategy
- You have assessed timelines and cost estimates required for the migration.
- Your requirements take into consideration the scope of the work and the systems and databases you have identified to be part of the migration.
- You have identified the stakeholders along with their roles and responsibilities in a responsible, accountable, consulted, informed (RACI) matrix.
- You have received the necessary agreement and approvals from all stakeholders.

### Cost

Depending on the technical specifications of your existing source database (for example, memory sizing, throughput, and total data size), a Redis solutions architect can size the target system on Redis Enterprise Cloud. For general pricing information, see [Redis Pricing](#) on the Redis website.

### People and skills

The migration process involves the following roles and responsibilities.

Role	Description	Skills required
<b>Migration solutions architect</b>	A technical architect who has expertise in defining,	Technical and application-level understanding of source and target systems; experienc

	planning, and implementing migration strategies	e with migrating workloads to the cloud
<b>Data architect</b>	A technical architect who has broad experience in defining, implementing, and delivering data solutions for a wide variety of databases	Data modeling for structured and unstructured data, deep understanding and experience in implementing databases for an enterprise
<b>Redis solutions architect</b>	A technical architect who can help architect an optimally sized Redis cluster for the appropriate use case	Expertise in architecting and deploying Redis solutions for a wide variety of use cases
<b>Cloud solutions architect</b>	A technical architect who has a deeper understanding of cloud solutions, especially on AWS	Expertise in architecting solutions for the cloud; workload migration and application modernization experience
<b>Enterprise architect</b>	A technical architect who has a complete understanding of the technical landscape at your organization, who has a shared vision for the future roadmap, and who practices and establishes standardized architectural best practices across all teams in your organization	Software architecture certifications such as TOGAF, foundational software engineering skills, and solutions architecture and enterprise architecture expertise

**IT or DevOps engineer**

An engineer who is responsible for creating and maintaining the infrastructure, including monitoring the infrastructure for issues, performing maintenance tasks, and making updates as needed.

Strong understanding of various technologies, including operating systems, networking, and cloud computing; familiarity with programming languages such as Python, Bash, and Ruby, as well as tools such as Docker, Kubernetes, and Ansible

**Architecture****Migration options**

The following diagram shows options for migrating your on-premises (Redis-based or other) data sources to AWS. It shows several migration tools that you can choose from, such as exporting Redis Database (RDB) files to Amazon Simple Storage Service (Amazon S3), using the Redis replication feature, or using AWS DMS.

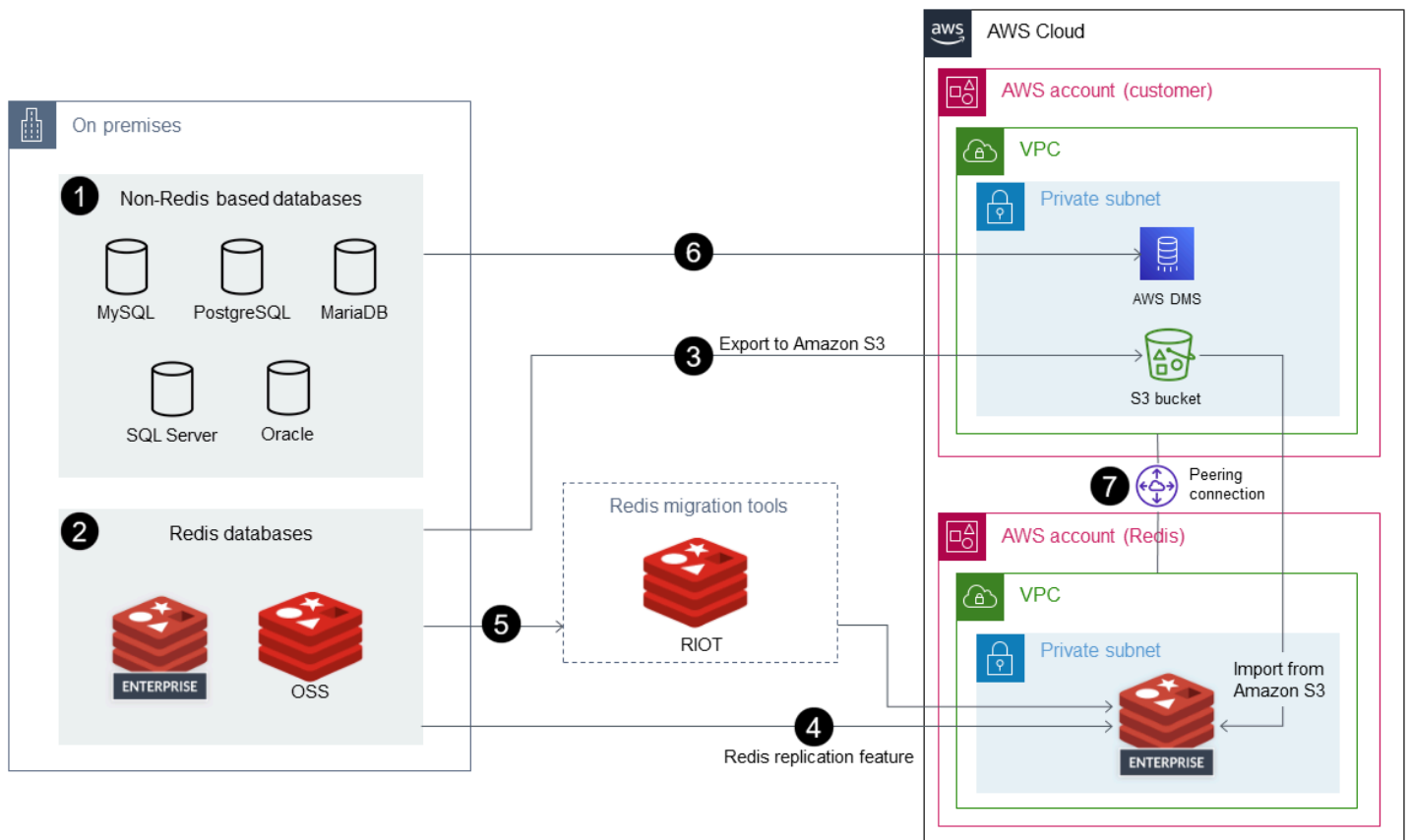

1. On-premises data sources: Databases that aren't based on Redis, such as MySQL, PostgreSQL, Oracle, SQL Server, or MariaDB.
2. On-premises data sources: Redis protocol-based databases such as Redis OSS and Redis Enterprise Software.
3. The simplest way to migrate data from Redis-based databases is to export RDB files and import them into the target Redis Enterprise Cloud on AWS.
4. Alternatively, you can migrate the data from source to target by using the replication feature (`ReplicaOf`) in Redis.
5. If your data migration requirements include transformation of data, you can employ Redis Input/Output Tools (RIOT) to migrate the data.
6. Alternatively, you can use AWS Data Migration Service (AWS DMS) to migrate the data from SQL-based databases.
7. You must use virtual private cloud (VPC) peering for AWS DMS to migrate the data successfully into the target Redis Enterprise Cloud on AWS.

## Target architecture

The following diagram shows a typical deployment architecture for Redis Enterprise Cloud on AWS and illustrates how it can be used with key AWS services.

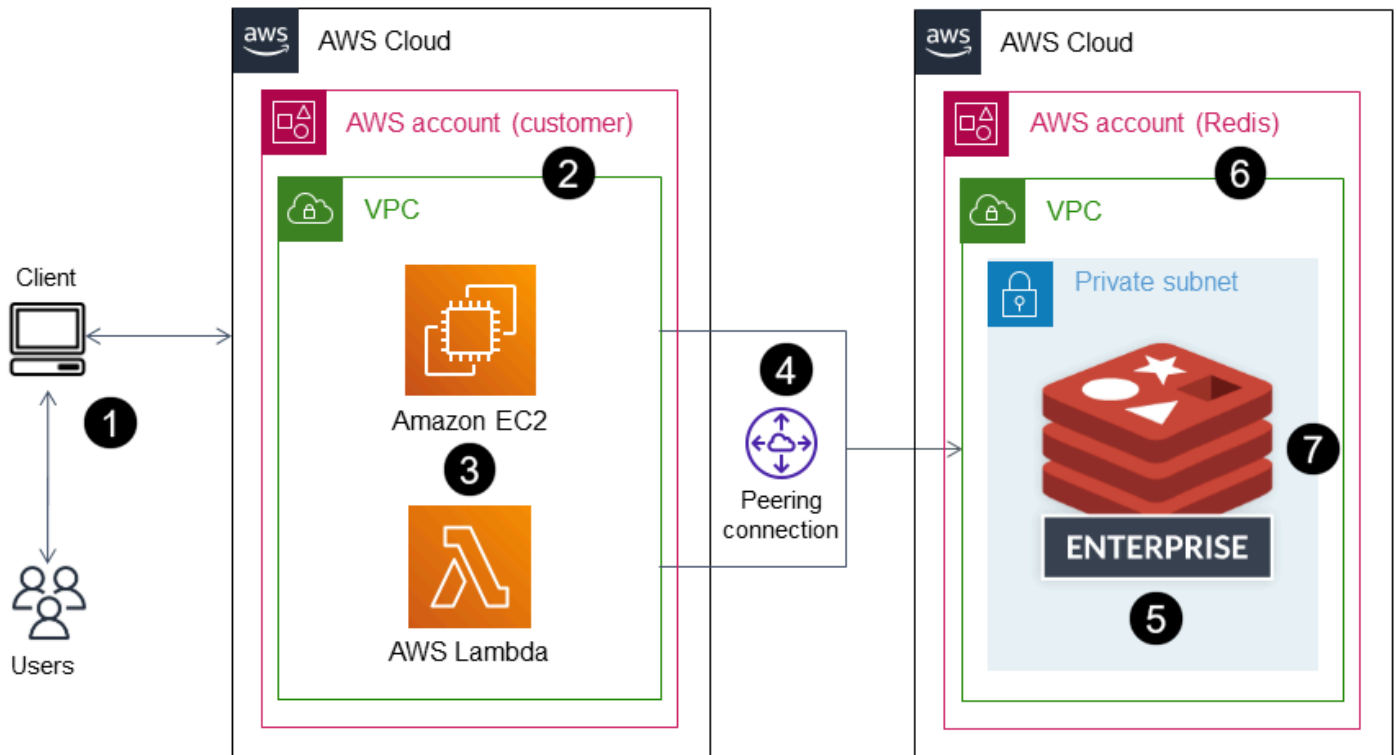

1. You can connect to the business applications that are backed by Redis Enterprise Cloud on AWS.
2. You can run business applications in your own AWS account, in a VPC within that account.
3. You can use Redis Enterprise Cloud database endpoints to connect to your applications. Examples include an application server running on EC2 instances, a microservice deployed as an AWS Lambda service, an Amazon Elastic Container Service (Amazon ECS) application, or an Amazon Elastic Kubernetes Service (Amazon EKS) application.
4. Business applications running in your VPC require a VPC peer connection to the Redis Enterprise Cloud VPC. This enables the business applications to connect securely over private endpoints.
5. Redis Enterprise Cloud on AWS is an in-memory NoSQL database platform deployed as a DBaaS on AWS and is fully managed by Redis.
6. Redis Enterprise Cloud is deployed within a VPC in a standard AWS account that is created by Redis.
7. For security reasons, Redis Enterprise Cloud is deployed in a private subnet that can be accessed at both private and public endpoints. We recommend that you connect your client applications

to Redis on private endpoints. If you plan to use a public endpoint, we strongly recommend that you [enable TLS](#) to encrypt the data between your client applications and Redis Enterprise Cloud.

The Redis migration methodology aligns with the AWS migration methodology, which is illustrated in [Mobilize your organization to accelerate large-scale migrations](#) on the AWS Prescriptive Guidance website.

## Automation and scale

The environment setup tasks for the migration can be automated through AWS Landing Zone and infrastructure as code (IaC) templates for automation and scale. These are discussed in the [Epics](#) section of this pattern.

## Tools

Based on your data migration requirements, you can choose from a selection of technological options to migrate your data to Redis Enterprise Cloud on AWS. The following table describes and compares these tools.

Tool	Description	Advantages	Disadvantages
<a href="#">RDB export</a> and <a href="#">import</a>	<p>You export the data from the source (for example, Redis OSS or Redis Enterprise Software) database in the form of RDB files. If your database is provided through a Redis OSS Cluster, you export each master shard to an RDB.</p> <p>You then import all the RDB files in one step. If your source database is based</p>	<ul style="list-style-type: none"> <li>• Simple.</li> <li>• Works with any Redis-based solution that can export data in RDB format as a source (including Redis OSS and Redis Enterprise Software).</li> <li>• Achieves data consistency with a simple process.</li> </ul>	<ul style="list-style-type: none"> <li>• Doesn't address data transformation requirements or support logical database merges.</li> <li>• Time-consuming for larger datasets.</li> <li>• No delta migration support can lead to longer downtime.</li> </ul>



on an OSS Cluster but your target database isn't using the OSS Cluster API, you have to change your application source code to use a standard Redis client library.

Data transformation requirements or logical database merges require a more complex process, which is explained under *Logical database merge* later in this table.

## [Redis replication feature](#) (active-passive)

You can continuously replicate data from a Redis OSS, Enterprise Software, or Enterprise Cloud database to a Redis Enterprise Cloud database. After the initial synchronization, the Redis replication feature (ReplicaOf ) performs a delta migration, which means that there's nearly no observed application downtime.

The Redis replication feature is intended to be used in an active-passive way. The target is assumed to be passive and gets fully resynchronized (flushed and synchronized from the source database) . Therefore, switching between the source and the target is somewhat more complicated.

It's possible to replicate from a Redis OSS Cluster to a

- Supports continuous replication (initial data load followed by deltas).
- Nearly no downtime (depends on replication lag).
- Achieves data consistency.
- Only one site is intended to be active, so switching between sites is more complicated.
- Supports a maximum of 32 master shards when you migrate from an OSS Cluster.

standard clustered Redis Enterprise Cloud database by specifying all the master shards of the OSS Cluster as sources. However, the Redis replication feature allows a maximum of 32 source databases.

## [AWS DMS](#)

You can use AWS DMS to migrate data from any supported source database to a target Redis data store with minimal downtime. For more information, see [Using Redis as a target for AWS DMS](#) in the AWS DMS documentation.

- Supports the migration of both NoSQL and SQL data sources.
- Works well with other AWS services.
- Supports live migration and change data capture (CDC) use cases.
- Redis key-values cannot contain special characters such as %.
- Doesn't support the migration of data that has special characters in rows or in field names.
- Doesn't support full large binary object (LOB) mode.

## Logical database merge

Special database merge requirements might require a custom data migration solution. For example, you might have four logical databases (SELECT 0..3) in Redis OSS, but you might want to use a single database endpoint instead of moving the data to multiple Redis Enterprise Cloud databases. Redis Enterprise doesn't support selectable logical databases, so you would have to transform the source database's physical data model. For example, you could map each database index to a prefix (0 to usr, 1 to cmp, and so on), and then use a migration script or an extract, transform, and load (ETL) tool to output an RDB file, which you can then import into the target database.

- Granular control on shaping the data during migration to the target system by using custom scripts.
- If you decide not to complete the migration, rollback can be very challenging, especially if newer data has to be rolled back to source systems.
- Cost to build can be high if the goal is to build a one-off solution for a one-time migration.
- Maintenance costs for code, infrastructure, development time, and other areas can be high if migration requirements change frequently.

In addition, you can use the following tools and services from AWS.

Assessment and discovery tools:

- [AWS Application Discovery Service](#)
- [Migration Evaluator](#)

Application and server migration tools:

- [AWS Application Migration Service](#)

[Database migration tools:](#)

- [AWS Schema Conversion Tool \(AWS SCT\)](#)
- [AWS Database Migration Service \(AWS DMS\)](#)

[Data migration tools:](#)

- [AWS Storage Gateway](#)
- [AWS DataSync](#)
- [AWS Direct Connect](#)
- [AWS Snowball](#)
- [Amazon Data Firehose](#)

Migration management:

- [AWS Migration Hub](#)

AWS Partner solutions:

- [AWS Migration Competency Partners](#)

## Epics

### Complete discovery and assessment tasks

Task	Description	Skills required
Identify workloads.	<p>Identify the suitable candidate workloads that you want to migrate. Consider the following before you choose a workload for migration:</p> <ul style="list-style-type: none"><li>• What is the business value in migrating or not migrating this workload?</li><li>• Is there a contingency plan if this workload doesn't successfully migrate to the target system?</li></ul> <p>Ideally, choose a workload that has maximum business impact with minimum risks involved. Keep the overall process iterative and migrate in small increments.</p>	Data architect, Business champions, Migration project sponsors
Identify data sources and requirements; design data model.	Redis runs a workshop to accelerate discovery and to define migration planning for the project. As a part of this workshop, Redis teams identify the data sources and source data model requirements, and analyze how these can be remodeled in Redis Enterprise Cloud.	Redis solutions architect

Task	Description	Skills required
	<p>The Redis migration team (Professional Services) performs a detailed data model design exercise with your organization. As a part of this exercise, the Redis team:</p> <ul style="list-style-type: none"><li>• Identifies target Redis data structures.</li><li>• Defines the data mapping strategy.</li><li>• Documents the migration approach and recommendations.</li><li>• Reviews and finalizes the data model with the stakeholders.</li></ul>	

Task	Description	Skills required
Identify the characteristics of the source database.	<p>Identify the Redis product that is used in the source and target environments. For example:</p> <ul style="list-style-type: none"><li>• Is the source database an OSS Cluster database, a standalone Redis database, or a Redis Enterprise database?</li><li>• Will the target database be a Redis Enterprise standard database or an OSS Cluster-compatible database?</li><li>• What are the implications concerning the application source code?</li></ul>	Data architect
Gather current system SLA and other sizing metrics.	Determine the current service-level agreements (SLAs) expressed in terms of throughput (operations per second), latency, overall memory size per database, and high availability (HA) requirements.	Data architect



Task	Description	Skills required
Identify the characteristics of the target system.	<p>Determine the answers to these questions:</p> <ul style="list-style-type: none"><li>• How much data has to be migrated?</li><li>• How long does it take to migrate the given amount of data?</li><li>• What are the downtime requirements for the migration? Is it acceptable for your service or application to be unavailable for a specific period? If so, for how long?</li><li>• How consistent should the migrated data be? Can the target database be in a slightly inconsistent (outdated) state?</li><li>• Does data have to be transformed before it is loaded to the target database? (For example, you might want to convert selectable DB indexes to prefixes before migration.)</li><li>• Is the source database reachable from the target database's host (for example, from a peer VPC or from a public endpoint using encryption)?</li></ul>	Data architect, Redis solutions architect (optional)

Task	Description	Skills required
	<ul style="list-style-type: none"><li>• Complete a data sizing and Redis Cluster sizing exercise with a Redis technical architect.</li><li>• Identify networking requirements, infrastructure requirements, software versions, and software licensing, and procure any components before the migration.</li><li>• Are there any security concerns associated with the transfer of this data?</li></ul>	
Identify dependencies.	Identify the upstream and downstream dependencies of the current system to be migrated. Make sure that the migration work is in alignment with other dependent system migrations. For example, if you're planning to migrate other business applications from on premises to the AWS Cloud, identify these applications and align them based on project goals, timelines, and stakeholders.	Data architect, enterprise architect

Task	Description	Skills required
Identify migration tools.	<p>Depending on your data migration requirements (such as source data or downtime requirements), you can use any of the tools described previously in the <a href="#">Tools</a> section. In addition, you can use:</p> <ul style="list-style-type: none"><li>• Bidirectional (active-active) replication by using CRDB deployment.</li><li>• Custom export/import scripts (for example, by using DUMP/RESTORE commands).</li><li>• Additional export/import tools and helper tools such as <a href="#">RIOT</a>, <a href="#">ECstats2</a>, or ETL tools.</li><li>• IaC tools such as Terraform or AWS CloudFormation templates.</li></ul>	Migration solutions architect, Redis solutions architect
Create a contingency plan.	Establish a contingency plan to roll back, in case you encounter problems during migration.	Project management, Technical teams, including architect

## Complete security and compliance tasks

Task	Description	Skills required
Secure the Redis administration console.	To secure the administration console, follow the instructions in the <a href="#">Redis documentation</a> .	IT infrastructure administrator
Secure the Redis database.	See the following pages in the Redis documentation to: <ul style="list-style-type: none"> <li>• <a href="#">Define role-based access control</a>.</li> <li>• <a href="#">Define network security</a>.</li> <li>• <a href="#">Enable TLS</a>.</li> </ul>	
Secure Redis Cloud APIs.	When you <a href="#">enable the API</a> , you can <a href="#">manage the API keys</a> for all owners of your Redis Cloud account. For an overview of the security features of the API, see the <a href="#">API authentication documentation</a> on the Redis website.	IT infrastructure administrator

## Set up the new environment

Task	Description	Skills required
Set up a new environment on AWS.	This task includes: <ul style="list-style-type: none"> <li>• <a href="#">AWS Landing Zone</a> setup activities. The landing zone supports: <ul style="list-style-type: none"> <li>• Multi-account deployments</li> </ul> </li> </ul>	IT or DevOps engineer

Task	Description	Skills required
	<ul style="list-style-type: none"><li>• Minimum security baseline</li><li>• Automated way to provision new accounts with a security baseline and ISV prerequisites (networking, security configuration, and so on)</li><li>• Notifications, centralized logging, and monitoring</li><li>• ISV software configuration activities. This includes configurations that need to be included in the migration, such as product and workload settings and changes.</li><li>• IaC activities such as configuring or customizing AWS CloudFormation or Terraform templates.</li></ul>	

Task	Description	Skills required
Deploy the migration architecture.	<ol style="list-style-type: none"><li>1. Set up Redis Enterprise Cloud on AWS.</li><li>2. Install migration tools such as RIOT or AWS DMS. See the <a href="#">Tools</a> section for a list of available tools.</li><li>3. Establish connectivity between the application, migration, and database layers.</li><li>4. Create a sample workload that can flow through each layer and migrate a small set of sample data.</li></ol> <p>You are now ready to run the actual data migration pipelines and test them.</p>	IT or DevOps engineer

## Set up networking

Task	Description	Skills required
Establish connectivity.	<p>Establish connectivity between the on-premises infrastructure and AWS Cloud resources. Use security groups, AWS Direct Connect, and other resources to achieve this functionality. For more information, see <a href="#">Connect Your Data Center to AWS</a> on the AWS website.</p>	IT or DevOps engineer

Task	Description	Skills required
Set up VPC peering.	Establish VPC peering between the VPCs that run business applications (or the EC2 instances that run migration tools or the AWS DMS replication server) and the VPC that runs Redis Enterprise Cloud. For instructions, see <a href="#">Get started with Amazon VPC</a> in the Amazon VPC documentation, and <a href="#">Enable VPC peering</a> in the Redis documentation.	IT or DevOps engineer

## Migrate data

Task	Description	Skills required
Choose a data migration tool.	<p>Review the table in the <a href="#">Tools</a> section to see descriptions, advantages, and disadvantages of these tools:</p> <ul style="list-style-type: none"> <li>• RDS export and import</li> <li>• Redis replication feature (ReplicaOf )</li> <li>• AWS DMS</li> <li>• Logical database merge</li> </ul> <p>The following rows describe the data migration tasks associated with each tool.</p>	Migration solutions architect

Task	Description	Skills required
Option 1: Use RDB export and import.	<ol style="list-style-type: none"><li data-bbox="592 226 1027 457">1. Disconnect the source: Stop the traffic on the source database (for example, by disconnecting business applications).</li><li data-bbox="592 478 1027 604">2. Export: Export the source database's data as an RDB file.</li><li data-bbox="592 625 1027 951">3. Stage: Upload the data to a location that is accessible to the Redis Enterprise Cloud instances on AWS (for example, you can upload them to an S3 bucket or FTP server).</li><li data-bbox="592 972 1027 1192">4. Import: Import the RDB files (by listing them all in one import step) to your Redis Enterprise Cloud target database.</li><li data-bbox="592 1213 1027 1434">5. Cut over: Move to the target database (for example, by connecting your application connect to it).</li></ol> <p data-bbox="592 1518 1027 1602">For more information, see the <a href="#">Redis documentation</a>.</p>	Migration solutions architect, Redis solutions architect



Task	Description	Skills required
Option 2: Use the Redis replication feature (active-passive).	<ol style="list-style-type: none"><li data-bbox="592 226 1027 405">1. Connect database: Establish a <code>ReplicaOf</code> link between the source and target databases.</li><li data-bbox="592 426 1027 657">2. Run an initial sync: Wait until the initial synchronization between the source and target databases is complete.</li><li data-bbox="592 678 1027 909">3. Disconnect the source: Stop the traffic on the source database (for example, by disconnecting the application).</li><li data-bbox="592 930 1027 1056">4. Run delta replication: Wait until the delta is replicated on the target database.</li><li data-bbox="592 1077 1027 1266">5. Cut over: Move to the target database (for example, by connecting your application to it).</li><li data-bbox="592 1287 1027 1455">6. Delete: Remove the <code>ReplicaOf</code> link between the source and target databases.</li></ol> <p data-bbox="592 1528 1027 1612">For more information, see the <a href="#">Redis documentation</a>.</p>	Migration solutions architect, Redis solutions architect

Task	Description	Skills required
Option 3: Use AWS DMS.	<ol style="list-style-type: none"><li data-bbox="591 226 1027 594">1. Set up an AWS DMS replication instance: This instance performs all migration processes. For instructions: <a href="#">Working with an AWS DMS replication instance</a> in the AWS DMS documentation.</li><li data-bbox="591 615 1027 1077">2. Define the source database: Define the source endpoint. Test the connectivity between the source endpoint and the AWS DMS replication server. For instructions: <a href="#">Creating source and target endpoints</a> in the AWS DMS documentation.</li><li data-bbox="591 1098 1027 1287">3. Set up the target database: Set up Redis Enterprise Cloud on AWS and set up the database to migrate to.</li><li data-bbox="591 1308 1027 1856">4. Define the target database: Define the target endpoint. Make sure that <a href="#">VPC peering</a> is established between the VPC where AWS DMS is running and the VPC that hosts Redis Enterprise Cloud on AWS. Test the connectivity between the AWS DMS replication server and the target database.</li></ol>	Migration solutions architect, Redis solutions architect

Task	Description	Skills required
	<p>5. Create an AWS DMS task: Create a task or a set of tasks to define the tables and replication processes you want to use to migrate the data. For instructions: <a href="#">Working with AWS DMS tasks</a> in the AWS DMS documentation.</p> <p>6. Migrate: Migrate the data by running the AWS DMS task.</p> <p>7. Cut over: Move to the target database (for example, by connecting your application to it).</p>	
Option 4: Use logical database merge.	This option involves using a migration script or ETL tool that can transform the source database's physical data model and generating an RDB file. Redis Professional Services can help with this step, if needed.	Migration solutions architect, Redis solutions architect

## Migrate your application

Task	Description	Skills required
Align project management timelines and goals.	Align the migration project goals, milestones, and timelines of the application	Project management

Task	Description	Skills required
	layer with that of the Redis data migration project.	
Align testing activities.	After the application layer is migrated and modernized in the AWS Cloud, point the application layer to the newly migrated Redis Enterprise Cloud on AWS for testing.	Testing

## Test

Task	Description	Skills required
Implement test plans.	Run the data migration routines and the scripts that were developed during the implementation phase in a testing environment, per test requirements, at your site.	Testing
Test data quality.	Test data quality after you migrate the data.	Testing
Test functionality.	Test data queries and the application layer to ensure that the application is performing at the same level as in the source system.	Testing

## Cut over

Task	Description	Skills required
Make the cutover decision.	After all application-level and database-level testing is complete, the executive leadership team and stakeholders make the final decision regarding whether to cut over to the new environment on AWS based on the final results confirmed by the testing teams.	Project management, Business champions
Cut over to the AWS Cloud.	When you have confirmed that everything is in place, point the application layer to the newly migrated data and point clients to the new application layer that is running based on the new Redis Enterprise Cloud system on AWS.	IT or DevOps engineer, Data architect, Migration solutions architect, Redis solutions architect

## Related resources

### Redis resources

- [Redis Enterprise Cloud documentation](#)
- [RIOT](#) tool (GitHub repository)
- [Terraform Provider](#) (download)

### AWS resources

- [Demo migrations](#)
- [AWS Partner Solutions](#)
- [Documentation](#)
- [Blog posts](#)
- [White papers](#)
- [Tutorials and videos](#)
- [AWS cloud migration](#)
- [AWS Prescriptive Guidance](#)

## Additional information

For standard security requirements for migrating Redis workloads to the AWS Cloud, see the [Best Practices for Security, Identity, and Compliance](#) on the AWS website, and the [Redis Trust Center](#) on the Redis website.

# Migrate SAP ASE on Amazon EC2 to Amazon Aurora PostgreSQL-Compatible using AWS SCT and AWS DMS

Created by Amit Kumar (AWS) and Ankit Gupta (AWS)

<b>Environment:</b> PoC or pilot	<b>Source:</b> SAP ASE	<b>Target:</b> Aurora PostgreSQL-Compatible
<b>R Type:</b> Replatform	<b>Workload:</b> SAP	<b>Technologies:</b> Migration; Databases
<b>AWS services:</b> AWS DMS; AWS SCT		

## Summary

This pattern describes how to migrate an SAP Adaptive Server Enterprise (SAP ASE) database that is hosted on an Amazon Elastic Compute Cloud (Amazon EC2) instance to Amazon Aurora PostgreSQL-Compatible Edition by using AWS Schema Conversion Tool (AWS SCT) and AWS Database Migration Service (AWS DMS). The pattern focuses on both data definition language (DDL) conversions for stored objects and data migration.

Aurora PostgreSQL-Compatible supports online transaction processing (OLTP) workloads. This managed service provides configurations that automatically scale on demand. It can automatically start up, shut down, scale up, or scale down your database based on your application's needs. You can run your database in the cloud without managing any database instances. Aurora PostgreSQL-Compatible provides a cost-effective option for infrequent, intermittent, or unpredictable workloads.

The migration process consists of two main phases:

- Converting the database schema by using AWS SCT
- Migrating the data by using AWS DMS

Detailed instructions for both phases are provided in the *Epics* section. For information about troubleshooting issues that are specific to using AWS DMS with SAP ASE databases, see [Troubleshooting issues with SAP ASE](#) in the AWS DMS documentation.

## Prerequisites and limitations

### Prerequisites

- An active AWS account
- A source SAP ASE database on an EC2 instance with server, database, and listener services up and running
- A target Aurora PostgreSQL-Compatible database

### Limitations

- The port number for connections must be 5432.
- The [huge\\_pages](#) feature is on by default but can be modified.
- Point-in-time recovery (PITR) granularity is 5 minutes.
- Cross-Region replication is currently not available.
- The maximum storage size for an Aurora database is 128 TiB.
- You can create up to 15 read replicas.
- The table size limit is constrained only by the size of the Aurora cluster volume, so the maximum table size for an Aurora PostgreSQL-Compatible DB cluster is 32 TiB. We recommend that you follow best practices for table design, such as partitioning large tables.

### Product versions

- Source database: AWS DMS currently supports SAP ASE 15, 15.5, 15.7, and 16.x. See the [AWS DMS User Guide](#) for the latest information about SAP ASE version support.
- Target database: PostgreSQL 9.4 and later (for version 9.x), 10.x, 11.x, 12.x, 13.x, and 14.x. See the [AWS DMS User Guide](#) for the latest supported PostgreSQL versions.
- Amazon Aurora 1.x or later. For the latest information, see [Aurora PostgreSQL-Compatible releases and engine versions](#) in the Aurora documentation.

## Architecture

### Source technology stack

- SAP ASE database running on Amazon EC2



## Target technology stack

- Aurora PostgreSQL-Compatible database

## Migration architecture

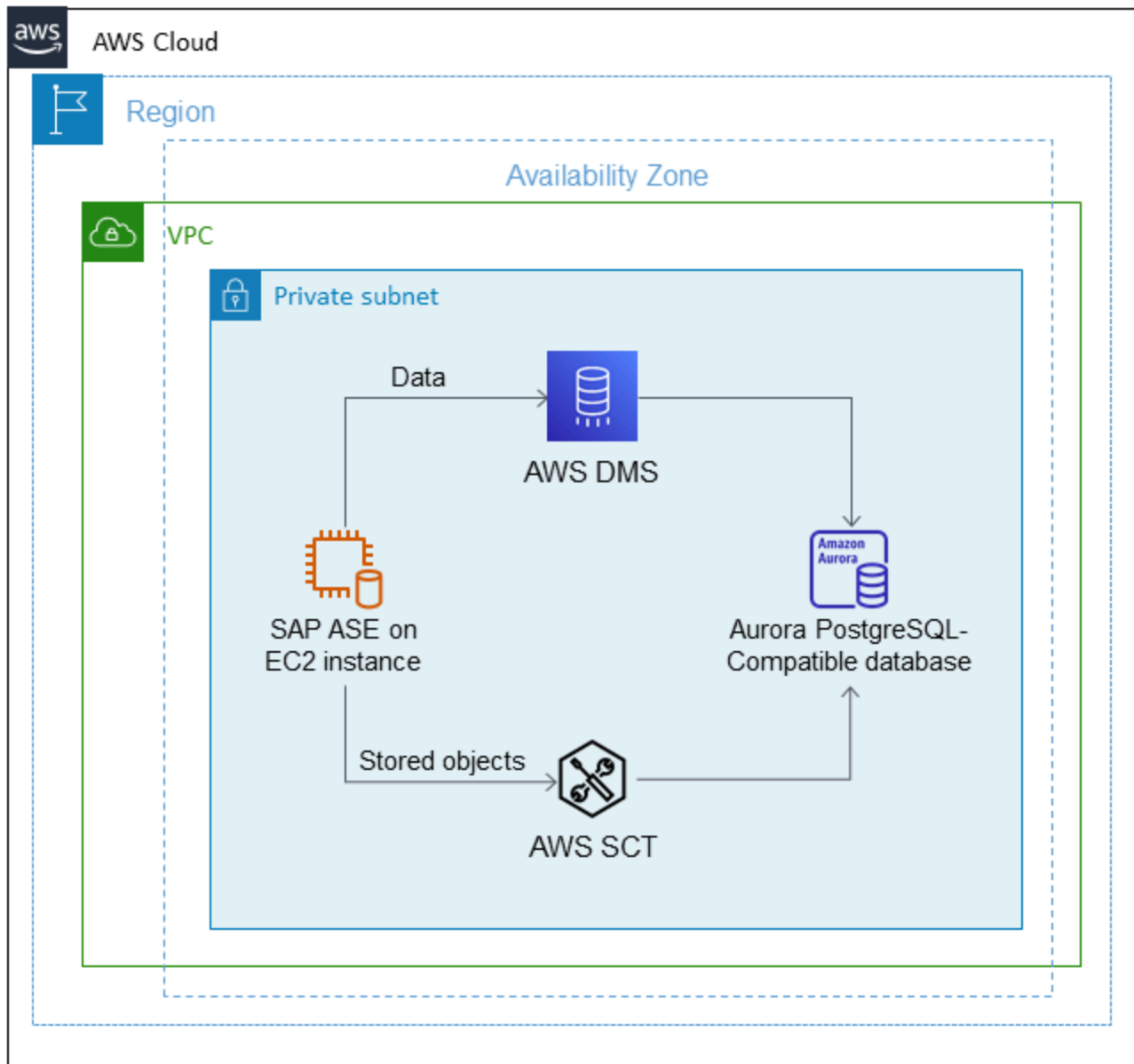

## Tools

- [Amazon Aurora PostgreSQL-Compatible Edition](#) is a fully managed, ACID-compliant relational database engine that helps you set up, operate, and scale PostgreSQL deployments.

- [AWS Schema Conversion Tool \(AWS SCT\)](#) supports heterogeneous database migrations by automatically converting the source database schema and most of the custom code to a format that's compatible with the target database.
- [AWS DMS](#) supports several different source and target databases. For more information, see [Sources for Data Migration](#) and [Targets for Data Migration](#) in the AWS DMS documentation. For the most comprehensive version and feature support, we recommend that you use the latest version of AWS DMS.

## Epics

### Set up the environment

Task	Description	Skills required
Configure network access in the source EC2 instance.	<p>Set up security groups in the EC2 instance that hosts your source SAP ASE database.</p> <p>For instructions, see <a href="#">Amazon EC2 security groups for Linux instances</a> in the Amazon EC2 documentation.</p>	Systems administrator
Create your target Aurora PostgreSQL-Compatible DB cluster.	<p>Install, configure, and launch an Aurora PostgreSQL-Compatible cluster for your target database.</p> <p>For more information, see <a href="#">Creating an Amazon Aurora DB cluster</a> in the Aurora documentation.</p>	DBA
Set up authorization for the target DB cluster.	Set up security groups and firewalls for the target database.	DBA, Systems administrator

Task	Description	Skills required
	For instructions, see <a href="#">Creating an Amazon Aurora DB cluster</a> in the Aurora documentation.	

## Convert your database schema with AWS SCT

Task	Description	Skills required
Launch AWS SCT.	<p>Launch AWS SCT by following the instructions in the <a href="#">AWS SCT documentation</a>.</p> <p>AWS SCT provides a project-based user interface to automatically convert the database schema of your SAP ASE source database into a format that's compatible with your target Aurora PostgreSQL L-Compatible DB instance.</p>	DBA
Create AWS SCT endpoints.	<p>Create endpoints for the source SAP ASE and target PostgreSQL databases.</p> <p>For instructions, see the <a href="#">AWS SCT documentation</a>.</p>	DBA
Create an assessment report.	<p>Create a database migration assessment report to evaluate the migration and detect any incompatible objects and functions.</p> <p>For instructions, see the <a href="#">AWS SCT documentation</a>.</p>	DBA

Task	Description	Skills required
Convert the schema.	Convert the database schema by following the instructions in the <a href="#">AWS SCT documentation</a> .	DBA
Validate database objects.	<p>If AWS SCT cannot convert a database object, it will identify its name and other details. You must convert these objects manually.</p> <p>To identify these mismatches, follow the instructions in the AWS blog post <a href="#">Validate database objects after migrating from SAP ASE to Amazon RDS for PostgreSQL or Amazon Aurora PostgreSQL</a>.</p>	DBA

## Analyze the AWS DMS migration

Task	Description	Skills required
Validate the source and target database versions.	<p>Check the SAP ASE database versions for compatibility with AWS DMS.</p> <p>For more information, see <a href="#">Sources for AWS DMS</a> and <a href="#">Targets for AWS DMS</a> in the AWS DMS documentation.</p>	DBA
Identify the requirements for the storage type and capacity.	Choose the appropriate storage capacity for the	DBA, Systems administrator

Task	Description	Skills required
	target database based on the size of your source database.	
Choose the instance type, capacity, and other features of the replication instance.	<p>Choose the instance type, capacity, storage features, and network features that meet your requirements.</p> <p>For guidance, see <a href="#">Choosing the right AWS DMS replication instance for your migration</a> in the AWS DMS documentation.</p>	DBA, Systems administrator
Identify network access security requirements.	<p>Identify the network access security requirements for the source and target databases.</p> <p>Follow the guidance in <a href="#">Setting up a network for a replication instance</a> in the AWS DMS documentation.</p>	DBA, Systems administrator

## Migrate the data

Task	Description	Skills required
Migrate the data by creating a migration task in AWS DMS.	<p>To migrate data, create a task and follow the instructions in the <a href="#">AWS DMS documentation</a>.</p> <p>We recommend that you use the latest version of AWS DMS for the most comprehensive version and feature support.</p>	DBA

Task	Description	Skills required
Validate the data.	To validate that your data was migrated accurately from the source database to the target database, follow the <a href="#">data validation guidelines</a> provided in the AWS DMS documentation.	DBA

## Migrate the application

Task	Description	Skills required
Identify the application migration strategy.	Choose one of the <a href="#">seven strategies (7Rs)</a> for migrating applications to the cloud.	DBA, App owner, Systems administrator
Follow the application migration strategy.	Complete the database tasks identified by the application team, including updating DNS connection details for the target database and updating dynamic queries.	DBA, App owner, Systems administrator

## Cut over to the target database

Task	Description	Skills required
Switch the application clients over to the new infrastructure.	Switch the connection from the source database to the target database.  For more information, see the <a href="#">Cut over</a> section of	DBA, App owner, Systems administrator

Task	Description	Skills required
	the <i>Migration strategy for relational databases</i> .	

## Close the project

Task	Description	Skills required
Shut down the temporary AWS resources.	<p>Terminate all migration tasks, replication instances , endpoints, and other AWS SCT and AWS DMS resources.</p> <p>For more information, see the <a href="#">AWS DMS documentation</a>.</p>	DBA, Systems administrator
Review and validate the project documents.	Validate all the steps in the project documentation to ensure that all tasks have been completed successfully.	DBA, App owner, Systems administrator
Close the project.	Close the migration project and provide any feedback.	DBA, App owner, Systems administrator

## Related resources

### References

- [Enable encrypted connections for PostgreSQL DB instances in Amazon RDS](#) (AWS Prescriptive Guidance)
- [Transport PostgreSQL databases between two Amazon RDS DB instances using pg\\_transport](#) (AWS Prescriptive Guidance)
- [Amazon Aurora pricing](#)
- [Best practices with Amazon Aurora PostgreSQL-Compatible Edition](#) (Amazon Aurora documentation)

- [AWS SCT documentation](#)
- [AWS DMS documentation](#)
- [Using an SAP ASE Database as a Source for AWS DMS](#)

### **Tutorials and videos**

- [Getting Started with AWS Database Migration Service](#)
- [AWS Database Migration Service \(video\)](#)



# Migrate Windows SSL certificates to an Application Load Balancer using ACM

Created by Chandra Sekhar Yaratha (AWS) and Igor Kovalchuk (AWS)

<b>Environment:</b> Production	<b>Source:</b> Windows web application	<b>Target:</b> Application Load Balancer on AWS
<b>R Type:</b> Replatform	<b>Workload:</b> Microsoft	<b>Technologies:</b> Migration; Management & governance; Web & mobile apps
<b>AWS services:</b> Elastic Load Balancing (ELB); AWS Certificate Manager (ACM)		

## Summary

The pattern provides guidance for using AWS Certificate Manager (ACM) to migrate existing Secure Sockets Layer (SSL) certificates from websites that are hosted on on-premises servers or Amazon Elastic Compute Cloud (Amazon EC2) instances on Microsoft Internet Information Services (IIS). The SSL certificates can then be used with Elastic Load Balancing on AWS.

SSL protects your data, affirms your identity, provides better search engine rankings, helps meet Payment Card Industry Data Security Standard (PCI DSS) requirements, and improves customer trust. Developers and IT teams that manage these workloads want their web applications and infrastructure, including the IIS server and Windows Server, to remain compliant with their baseline policies.

This pattern covers manually exporting existing SSL certificates from Microsoft IIS, converting them from Personal Information Exchange (PFX) format to the Private Enhanced Mail (PEM) format that ACM supports, and then importing them into ACM in your AWS account. It also describes how to create an Application Load Balancer for your application and configure the Application Load Balancer to use your imported certificates. HTTPS connections are then terminated on the Application Load Balancer, and you don't need further configuration overhead on the web server. For more information, see [Create an HTTPS listener for your Application Load Balancer](#).

Windows servers use .pfx or .p12 files to contain the public key file (SSL certificate) and its unique private key file. The Certificate Authority (CA) provides you with your public key file. You use your server to generate the associated private key file where the certificate signing request (CSR) was created.

## Prerequisites and limitations

### Prerequisites

- An active AWS account
- A virtual private cloud (VPC) on AWS with at least one private and one public subnet in each Availability Zone used by your targets
- IIS version 8.0 or later running on Windows Server 2012 or later
- A web application running on IIS
- Administrator access to the IIS server

## Architecture

### Source technology stack

- IIS web server implementation with SSL to ensure that data is transmitted securely in an encrypted connection (HTTPS)

### Source architecture

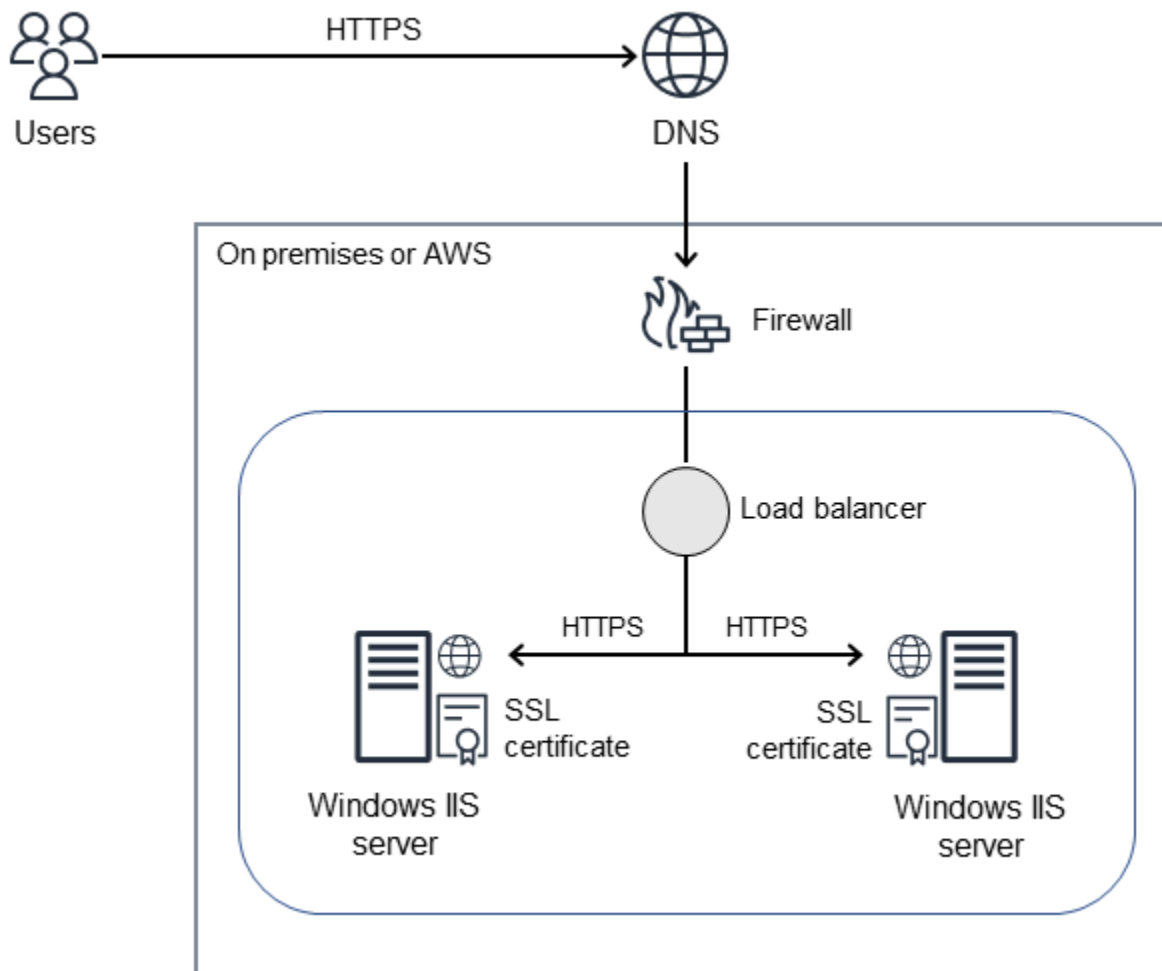

### Target technology stack

- ACM certificates in your AWS account
- An Application Load Balancer configured to use imported certificates
- Windows Server instances in the private subnets

### Target architecture

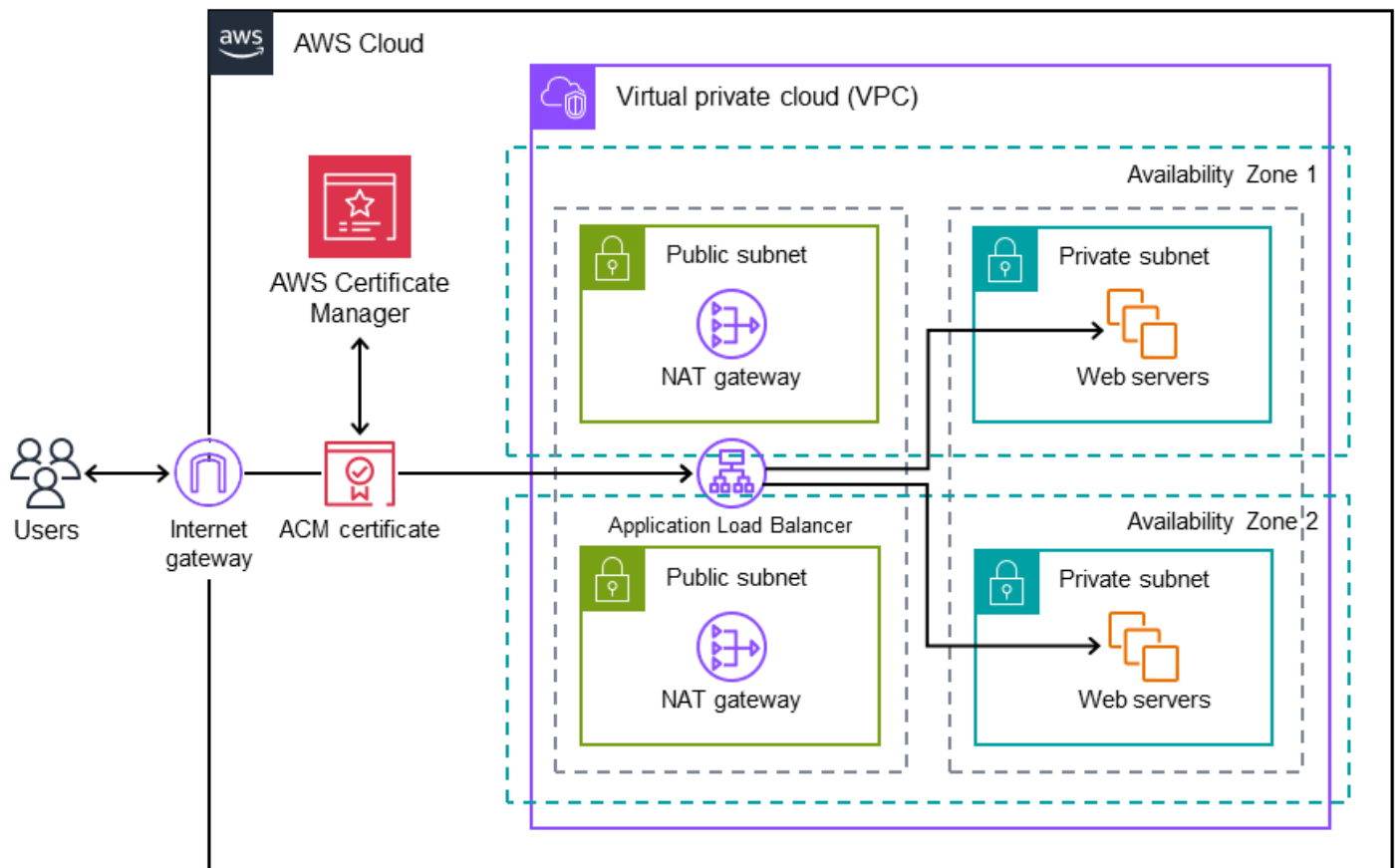

## Tools

- [AWS Certificate Manager \(ACM\)](#) helps you create, store, and renew public and private SSL/TLS X.509 certificates and keys that protect your AWS websites and applications.
- [Elastic Load Balancing \(ELB\)](#) distributes incoming application or network traffic across multiple targets. For example, you can distribute traffic across EC2 instances, containers, and IP addresses in one or more Availability Zones.

## Best practices

- Enforce traffic redirects from HTTP to HTTPS.
- Configure security groups for your Application Load Balancer properly to allow inbound traffic only to specific ports.
- Launch your EC2 instances in different Availability Zones to ensure high availability.
- Configure your application's domain to point to the Application Load Balancer's DNS name instead of its IP address.

- Make sure that the Application Load Balancer has application-layer [health checks](#) configured.
- Configure the threshold for health checks.
- Use [Amazon CloudWatch](#) to monitor the Application Load Balancer.

## Epics

### Export a .pfx file

Task	Description	Skills required
Export the .pfx file from Windows Server.	<p>To export the SSL certificate as a .pfx file from the on-premises IIS manager in Windows Server:</p> <ol style="list-style-type: none"> <li>1. Choose <b>Start, Administrative, Internet Information Services (IIS) Manager</b>.</li> <li>2. Select the server name, and under <b>Security</b>, double-click <b>Server Certificates</b>.</li> <li>3. Choose the certificate that you want to export, and then choose <b>Export</b>.</li> <li>4. In the <b>Export Certificate</b> box, choose a location, path, and name for your .pfx file.</li> <li>5. Specify and confirm a password for your .pfx file.</li> </ol> <p><b>Note:</b> You need this password when you install the .pfx file.</p> <ol style="list-style-type: none"> <li>6. Choose OK.</li> </ol>	Systems administrator

Task	Description	Skills required
	Your .pfx file should now be saved to the location and path you specified.	

## Convert the PFX-encoded certificate to PEM format

Task	Description	Skills required
Download and install the OpenSSL toolkit.	<ol style="list-style-type: none"> <li>1. Download and install <a href="#">Win32/Win64 OpenSSL</a> from the Shining Light Productions website.</li> <li>2. Add the location of the OpenSSL binaries to your system PATH variable, so the binaries can be available for command-line use.</li> </ol>	Systems administrator
Convert the PFX-encoded certificate to PEM format.	<p>The following steps convert the PFX-encoded, signed certificate file into three files in PEM format:</p> <ul style="list-style-type: none"> <li>• <code>cert-file.pem</code> contains the SSL/TLS certificate for the resource.</li> <li>• <code>privatekey.pem</code> contains the private key of the certificate with no password protection.</li> <li>• <code>ca-chain.pem</code> contains the root certificate of the CA.</li> </ul>	Systems administrator

Task	Description	Skills required
	<p>To convert the PFX encoded certificate:</p> <ol style="list-style-type: none"><li>1. Run Windows PowerShell.</li><li>2. Use the following command to extract the private key of the certificate from the PFX file. Enter the certificate password when prompted.</li></ol> <pre data-bbox="634 709 1029 905">openssl pkcs12 -in &lt;filename&gt;.pfx -nocerts -out withpw-privatekey.pem</pre> <p>The command generates a PEM-encoded private key file named <code>privatekey.pem</code>. Enter a passphrase to protect the private key file when prompted.</p> <ol style="list-style-type: none"><li>3. Run the following command to remove the passphrase. When prompted, provide the passphrase that you created in step 2.</li></ol> <pre data-bbox="634 1549 1029 1745">openssl rsa -in withpw-privatekey.pem -out privatekey.pem</pre>	

Task	Description	Skills required
	<p>If the command is successful, it displays the message “writing RSA key.”</p> <p>4. Use the following command to transfer the certificate from the PFX file to a PEM file.</p> <pre data-bbox="634 579 1029 779">openssl pkcs12 -in   &lt;file_name&gt;.pfx -   clcerts -nokeys -out   cert-file.pem</pre> <p>This creates a PEM-encoded certificate file named <code>cert-file.pem</code> . If the command is successful, it displays the message “MAC verified OK.”</p> <p>5. Create a CA chain file from the PFX file. The following command creates a CA chain file named <code>ca-chain.pem</code> .</p> <pre data-bbox="634 1377 1029 1577">openssl pkcs12 -in   &lt;file_name&gt;.pfx -   cacerts -nokeys -chain   -out ca-chain.pem</pre> <p>If the command is successful, it displays the message “MAC verified OK.”</p>	



## Import a certificate into ACM

Task	Description	Skills required
Prepare to import the certificate.	On the <a href="#">ACM console</a> , choose <b>Import a certificate</b> .	Cloud administrator
Provide the certificate body.	For <b>Certificate body</b> , paste the PEM-encoded certificate that you want to import.  For more information about the commands and steps described in this and other tasks in this epic, see <a href="#">Importing a certificate</a> in the ACM documentation.	Cloud administrator
Provide the certificate private key.	For <b>Certificate private key</b> , paste the PEM-encoded, unencrypted private key that matches the certificate's public key.	Cloud administrator
Provide the certificate chain.	For <b>Certificate chain</b> , paste the PEM-encoded certificate chain, which is stored in the <code>CertificateChain.pem</code> file.	Cloud administrator
Import the certificate.	Choose <b>Review and import</b> . Confirm that the information about your certificate is correct, and then choose <b>Import</b> .	Cloud administrator

## Create an Application Load Balancer

Task	Description	Skills required
Create and configure the load balancer and listeners.	Follow the instructions in the <a href="#">Elastic Load Balancing documentation</a> to configure a target group, register targets, and create an Application Load Balancer and listener. Add a second listener (HTTPS) for port 443.	Cloud administrator

## Troubleshooting

Issue	Solution
Windows PowerShell doesn't recognize the OpenSSL command even after you add it to the system path.	<p>Check <code>\$env:path</code> to make sure that it includes the location of the OpenSSL binaries.</p> <p>If it doesn't, run the following command in PowerShell:</p> <pre>\$env:path = \$env:path + ";C:\OpenSSL-Win64\bin"</pre>

## Related resources

### Importing a certificate into ACM

- [ACM console](#)
- [Certificate and key format for importing](#)
- [Importing a certificate](#)
- [AWS Certificate Manager User Guide](#)

## Creating an Application Load Balancer

- [Create an Application Load Balancer](#)
- [Application Load Balancer User Guide](#)

# Migrate a messaging queue from Microsoft Azure Service Bus to Amazon SQS

Created by Nisha Gambhir (AWS)

<b>R Type:</b> Replatform	<b>Source:</b> Applications using Azure Service Bus queues	<b>Target:</b> Amazon SQS
<b>Created by:</b> AWS	<b>Environment:</b> PoC or pilot	<b>Technologies:</b> Web & mobile apps; Migration
<b>Workload:</b> Microsoft	<b>AWS services:</b> Amazon SQS	

## Summary

This pattern describes how to migrate a .NET Framework or .NET Core web or console application from using the Microsoft Azure Service Bus queue messaging platform to Amazon Simple Queue Service (Amazon SQS).

Applications use messaging services to send data to, and receive data from, other applications. These services help build decoupled, highly scalable microservices, distributed systems, and serverless applications in the cloud.

Azure Service Bus queues are part of a broader Azure messaging infrastructure that supports queuing and publish/subscribe messaging.

Amazon SQS is a fully managed message queuing service that enables you to decouple and scale microservices, distributed systems, and serverless applications. Amazon SQS eliminates the complexity and overhead associated with managing and operating message-oriented middleware, and enables developers to focus on differentiating work. Using Amazon SQS, you can send, store, and receive messages between software components at any volume, without losing messages or requiring other services to be available.

## Prerequisites and limitations

### Prerequisites

- An active AWS account

- A .NET Framework or .NET Core web or console application that uses Azure Service Bus queues (sample code attached)

## Product versions

- .NET Framework 3.5 or later, or .NET Core 1.0.1, 2.0.0, or later

## Architecture

### Source technology stack

- A .NET (Core or Framework) web or console application that uses an Azure Service Bus queue to send messages

### Target technology stack

- Amazon SQS

## Tools

### Tools

- Microsoft Visual Studio

## Code

To create an AWS Identity and Access management (IAM) policy for Amazon SQS:

1. Sign in to the AWS Management Console and open the IAM console at <https://console.aws.amazon.com/iam/>.
2. In the navigation pane on the left, choose **Policies**, and then choose **Create policy**.
3. Choose the **JSON** tab, and paste the following code:

```
{
  "Version": "2012-10-17",
  "Statement": [
```

```

{
  "Sid": "VisualEditor0",
  "Effect": "Allow",
  "Action": [
    "sqs:DeleteMessage",
    "sqs:GetQueueUrl",
    "sqs:ChangeMessageVisibility",
    "sqs:SendMessageBatch",
    "sqs:ReceiveMessage",
    "sqs:SendMessage",
    "sqs:GetQueueAttributes",
    "sqs:ListQueueTags",
    "sqs:ListDeadLetterSourceQueues",
    "sqs:DeleteMessageBatch",
    "sqs:PurgeQueue",
    "sqs>DeleteQueue",
    "sqs>CreateQueue",
    "sqs:ChangeMessageVisibilityBatch",
    "sqs:SetQueueAttributes"
  ],
  "Resource": "arn:aws:sqs:*:<AccountId>:*"
},
{
  "Sid": "VisualEditor1",
  "Effect": "Allow",
  "Action": "sqs:ListQueues",
  "Resource": "*"
}
]
}

```

4. Choose **Review policy**, type a name, and then choose **Create policy**.

5. Attach the newly created policy to your existing IAM role or create a new role.

## Epics

### Set up Amazon SQS in AWS

Task	Description	Skills required
Create an IAM policy for Amazon SQS.	Create the IAM policy that will provide access to Amazon	System engineer

Task	Description	Skills required
	SQS. See the Code section for a sample policy.	
Create an AWS profile.	Create a new profile by running the AWS Tools for PowerShell command <code>Set-AWSCredential</code> . This command stores your access key and secret key in your default credentials file under the profile name you specify. Link the Amazon SQS policy you created earlier with this account. Keep the AWS access key ID and secret access key. These will be required in the next steps.	System engineer
Create an SQS queue.	You can create a standard queue or a first in, first out (FIFO) queue. For instructions, see the link in the References section.	System engineer

## Revise your .NET application code

Task	Description	Skills required
Install AWS Toolkit for Visual Studio.	This toolkit is an extension for Microsoft Visual Studio and makes it easier for you to build and deploy .NET applications in AWS. For installation and usage	Application developer

Task	Description	Skills required
	instructions, see the link in the References section.	
Install the AWSSDK.SQS NuGet package.	You can install AWSSDK.SQS by choosing "Manage NuGet Package" in Visual Studio or by running the command "Install-Package AWSSDK.SQS".	Application developer
Create an AWSCredentials object in your .NET application.	The sample application in the attachment shows how to create a BasicAWSCredentials object, which inherits from AWSCredentials. You can use the access key ID and secret access key from earlier, or let the object pick these from the .aws folder as part of the user profile at run time.	Application developer
Create an SQS client object.	Create an SQS client object (AmazonSQSClient) for .NET Framework. This is part of the Amazon.SQS namespace. This object is required instead of IQueueClient, which is part of the Microsoft.Azure.ServiceBus namespace.	Application developer
Call the SendMessageAsync method to send messages to the SQS queue.	Change the code that sends the message to the queue to use the amazonSqsClient.SendMessageAsync method. For details, see the attached code sample.	Application developer



Task	Description	Skills required
Call the <code>ReceiveMessageAsync</code> method to receive messages from the SQS queue.	Change the code that receives the message to use the <code>amazonSqsClient.ReceiveMessageAsync</code> method. For details, see the attached code sample.	Application developer
Call the <code>DeleteMessageAsync</code> method to delete messages from the SQS queue.	To delete messages, change the code from the <code>queueClient.CompleteAsync</code> method to the <code>amazonSqsClient.DeleteMessageAsync</code> method. For details, see the attached code sample.	Application developer

## Related resources

- [AWS SDK for .NET Developer Guide](#)
- [Messaging Using Amazon SQS](#)
- [Creating and Using an Amazon SQS Queue with the AWS SDK for .NET](#)
- [Send an Amazon SQS Message](#)
- [Receive a Message from an Amazon SQS Queue](#)
- [Delete a Message from an Amazon SQS Queue](#)
- [AWS Toolkit for Visual Studio](#)

## Additional information

This pattern includes two sample applications (see the attachments section):

- **AzureSbTestApp** includes code that uses the Azure Service Bus queue.
- **AmazonSqsTestApp** uses Amazon SQS. This is a console application that uses .NET Core 2.2 and includes examples for sending and receiving messages.

Notes:

- `queueClient` is an object of `IQueueClient`, which is part of the `Microsoft.Azure.ServiceBus` namespace (included in the `Microsoft.Azure.ServiceBus` NuGet package).
- `amazonSqsClient` is an object of `AmazonSQSClient`, which is part of the `Amazon.SQS` namespace (included in the `AWSSDK.SQS` NuGet package).
- Depending upon where the code is running, say if its running on EC2, the role needs to have permission to write into the SQS Queue.

## Attachments

To access additional content that is associated with this document, unzip the following file:

[attachment.zip](#)

# Migrate an Oracle JD Edwards EnterpriseOne database to AWS by using Oracle Data Pump and AWS DMS

Created by Thanigaivel Thirumalai (AWS)

<b>Environment:</b> Production	<b>Source:</b> Oracle JD Edwards EnterpriseOne	<b>Target:</b> Amazon RDS for Oracle
<b>R Type:</b> Replatform	<b>Workload:</b> Oracle	<b>Technologies:</b> Migration; Databases
<b>AWS services:</b> Amazon RDS; AWS DMS		

## Summary

You can migrate and run your JD Edwards EnterpriseOne database on [Amazon Relational Database Service \(Amazon RDS\)](#). When you migrate your database to Amazon RDS, AWS can take care of backup tasks and high availability setup, so you can concentrate on maintaining your EnterpriseOne application and its functionality. For a comprehensive list of key factors to consider during the migration process, see [Oracle database migration strategies](#) in AWS Prescriptive Guidance.

There are multiple ways to migrate an EnterpriseOne database, including:

- Using Oracle Universal Batch Engine (UBE) R98403 for schema and table creation, and using AWS Database Migration Service (AWS DMS) for migration
- Using DB native tools for schema and table creation and using AWS DMS for migration
- Using DB native tools for the migration of existing data (full load) and using AWS DMS for change data capture (CDC) tasks

This pattern covers the third option. It explains how to migrate your on-premises EnterpriseOne databases to Amazon RDS for Oracle by using Oracle Data Pump with [AWS DMS](#) and its CDC feature.

[Oracle JD Edwards EnterpriseOne](#) is an enterprise resource planning (ERP) solution for organizations that manufacture, construct, distribute, service, or manage products or physical assets. JD Edwards EnterpriseOne supports various hardware, operating systems, and database platforms.

When you migrate critical ERP applications such as JD Edwards EnterpriseOne, minimizing downtime is key. AWS DMS minimizes downtime by supporting both full load and continuous replication from the source database to the target database. AWS DMS also provides real-time monitoring and logging for the migration, which can help you identify and resolve any issues that could cause downtime.

When you replicate changes with AWS DMS, you must specify a time or system change number (SCN) as the starting point for reading changes from the database logs. It's crucial to keep these logs accessible on the server for a designated amount of time (we recommend 15 days) to ensure that AWS DMS has access to these changes.

## Prerequisites and limitations

### Prerequisites

- An Amazon RDS for Oracle database provisioned in your AWS Cloud environment as the target database. For instructions, see the [Amazon RDS documentation](#).
- An EnterpriseOne database that's running on premises or on an Amazon Elastic Compute Cloud (Amazon EC2) instance on AWS.

**Note:** This pattern is designed for migrating from on premises to AWS, but it was tested by using an EnterpriseOne database on an EC2 instance. If you plan to migrate from your on-premises environment, you must configure the appropriate network connectivity.

- Schema details. Identify which Oracle database schema (for example, DV920) you plan to migrate for EnterpriseOne. Before you start the migration process, gather the following details about the schema:
  - Schema size
  - The number of objects per object type
  - The number of invalid objects

### Limitations

- You have to create any schemas you want on the target Amazon RDS for Oracle database—AWS DMS doesn't create these for you. (The [Epics](#) section describes how to use Data Pump to export and import schemas.) The schema name must already exist for the target Oracle database. Tables from the source schema are imported to the user or the schema, and AWS DMS uses the administrator or system account to connect to the target instance. To migrate multiple schemas, you can create multiple replication tasks. You can also migrate data to different schemas on a target instance. To do this, use schema transformation rules on the AWS DMS table mappings.
- This pattern has been tested with a demo dataset. We recommend that you validate compatibility for your dataset and customization.
- This pattern uses an EnterpriseOne database that's running on Microsoft Windows. However, you can use the same process with other operating systems that are supported by AWS DMS.

## Architecture

The following diagram shows a system that's running EnterpriseOne on an Oracle database as the source database, and an Amazon RDS for Oracle database as the target database. The data is exported from the source Oracle database and imported into the target Amazon RDS for Oracle database by using Oracle Data Pump, and replicated for CDC updates by using AWS DMS.

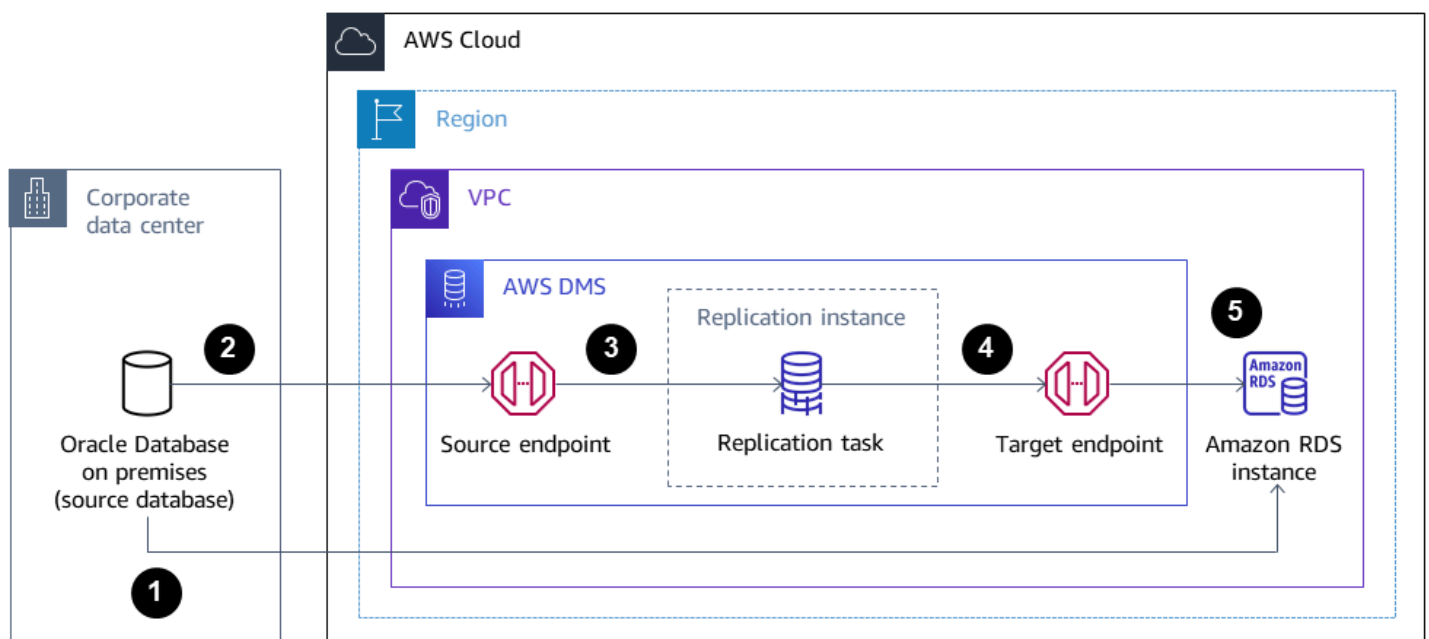

1. Oracle Data Pump extracts data from the source database, and the data is sent to the Amazon RDS for Oracle database target.
2. CDC data is sent from the source database to a source endpoint in AWS DMS.

3. From the source endpoint, the data is sent to the AWS DMS replication instance, where the replication task is performed.
4. After the replication task is complete, the data is sent to the target endpoint in AWS DMS.
5. From the target endpoint, the data is sent to the Amazon RDS for Oracle database instance.

## Tools

### AWS services

- [AWS Database Migration Service \(AWS DMS\)](#) helps you migrate data stores into the AWS Cloud or between combinations of cloud and on-premises setups.
- [Amazon Relational Database Service \(Amazon RDS\) for Oracle](#) helps you set up, operate, and scale an Oracle relational database in the AWS Cloud.

### Other services

- [Oracle Data Pump](#) helps you move data and metadata from one database to another at high speed.

## Best practices

### Migrating LOBs

If your source database contains large binary objects (LOBs) that need to be migrated to the target database, AWS DMS provides the following options:

- **Full LOB mode** – AWS DMS migrates all the LOBs from the source to the target database regardless of their size. Although the migration is slower than the other modes, the advantage is that data isn't truncated. For better performance, you can create a separate task on the new replication instance to migrate the tables that have LOBs that are larger than a few megabytes.
- **Limited LOB mode** – You specify the maximum size of LOB column data, which allows AWS DMS to pre-allocate resources and apply the LOBs in bulk. If the size of the LOB columns exceeds the size that is specified in the task, AWS DMS truncates the data and sends warnings to the AWS DMS log file. You can improve performance by using limited LOB mode if your LOB data size is within the limited LOB size.
- **Inline LOB mode** – You can migrate LOBs without truncating the data or slowing the performance of your task by replicating both small and large LOBs. First, specify a value for the

`InLineLobMaxSize` parameter, which is available only when full LOB mode is set to `true`. The AWS DMS task transfers the small LOBs inline, which is more efficient. Then, AWS DMS migrates the large LOBs by performing a lookup from the source table. However, inline LOB mode works only during the full load phase.

## Generating sequence values

During the AWS DMS CDC process, incremental sequence numbers aren't replicated from the source database. To avoid discrepancies in sequence values, you must generate the most recent sequence value from the source for all sequences, and apply it to the target Amazon RDS for Oracle database.

## AWS Secrets Manager

To help manage your credentials, we recommend that you follow the instructions in the blog post [Manage your AWS DMS endpoint credentials with AWS Secrets Manager](#).

## Performance

- **Replication instances** – For guidance on choosing the best instance size, see [Selecting the best size for a replication instance](#) in the AWS DMS documentation.
- **Connectivity options** – To avoid latency issues, we recommend that you choose the right connectivity option. AWS Direct Connect provides the shortest path to AWS resources, because it is a dedicated connection between your corporate data centers and AWS. While in transit, your network traffic remains on the AWS global network and never goes over the internet. This reduces the chance of hitting bottlenecks or unexpected increases in latency when compared with using VPN or the public internet.
- **Network bandwidth** – To optimize performance, verify that your network throughput is fast. If you are using a VPN tunnel between your on-premises source database and AWS DMS, ensure that the bandwidth is sufficient for your workload.
- **Task parallelism** – You can speed up data replication by loading multiple tables in parallel during full load. This pattern uses of RDBMS endpoints, so this option applies only to the full load process. Task parallelism is controlled by the `MaxFullLoadSubTasks` parameter, which determines how many full load sub-tasks are run in parallel. By default, this parameter is set to 8, which means that eight tables (if selected in table mapping) are loaded together during full mode. You can adjust this parameter in the full-load task settings section of the JSON script for the task.

- **Table parallelism** – AWS DMS also enables you to load a single large table by using multiple parallel threads. This is particularly useful for Oracle source tables that have billions of records as well as multiple partitions and subpartitions. If the source table isn't partitioned, you can use column boundaries for parallel loads.
- **Split loads** – When you split loads across multiple tasks or AWS DMS instances, remember transaction boundaries when you capture changes.

## Epics

### Use Oracle Data Pump to export the EnterpriseOne schema

Task	Description	Skills required
Generate the SCN.	<p>When the source database is active and in use by the EnterpriseOne application, initiate the data export with Oracle Data Pump. You must first generate a system change number (SCN) from the source database for both data consistency during the export with Oracle Data Pump and as a starting point for CDC in AWS DMS.</p> <p>To generate the current SCN from your source database, use the following SQL statement:</p> <pre data-bbox="594 1608 1027 1885">SQL&gt; select current_scn       from v\$database;  CURRENT_SCN -----       30009727</pre>	DBA



Task	Description	Skills required
	<p>Save the generated SCN. You will use the SCN when you export the data and to create the AWS DMS replication task.</p>	
Create the parameter file.	<p>To create a parameter file for exporting the schema, you can use the following code.</p> <pre data-bbox="597 604 1026 957">directory=DMS_DATA _PUMP_DIR logfile=export_dms.log dumpfile=export_dms_data.dmp schemas=&lt;schema name&gt; flashback_scn=&lt;SCN from previous command&gt;</pre> <p><b>Note:</b> You can also define your own DATA_PUMP_DIR by using the following commands, based on your requirements.</p> <pre data-bbox="597 1264 1026 1696">SQL&gt; CREATE OR REPLACE   DIRECTORY DMS_DATA_   PUMP_DIR AS '&lt;Directory for dump&gt;'; Directory created.  SQL&gt; GRANT READ, WRITE   ON DIRECTORY DMS_DATA_   PUMP_DIR TO SYSTEM; Grant succeeded.</pre>	DBA

Task	Description	Skills required
Export the schema.	<p>To perform the export, use the expdp utility as follows:</p> <pre data-bbox="592 346 1027 1831"> C:\Users\Administr ator&gt;expdp system/ *****@&lt;DB Name&gt;   PARFILE='&lt;Path to PAR file create above&gt;'  Export: Release   19.0.0.0.0 - Productio n on *** **   **.**. ** Version 19.3.0.0.0  Copyright (c) 1982,   2019, Oracle and/or   its affiliates. All   rights reserved.  Connected to: Oracle   Database 19c Standard   Edition 2 Release   19.0.0.0.0 - Productio n Starting "SYSTEM". "SYS_EXPORT_SCHEMA _02": system/** *****@&lt;DB Name&gt;PARF ILE='E:\exp_dms_da tapump.par' Processing object type   SCHEMA_EXPORT/TABLE/ TABLE_DATA Processing object type   SCHEMA_EXPORT/TABL E/INDEX/STATISTICS/ INDEX_STATISTICS Processing object type   SCHEMA_EXPORT/TABL </pre>	DBA

Task	Description	Skills required
	<p>E/STATISTICS/TABLE _STATISTICS Processing object type SCHEMA_EXPORT/STAT ISTICS/MARKER Processing object type SCHEMA_EXPORT/USER Processing object type SCHEMA_EXPORT/ROLE _GRANT Processing object type SCHEMA_EXPORT/DEFA ULT_ROLE Processing object type SCHEMA_EXPORT/TABL ESPACE_QUOTA Processing object type SCHEMA_EXPORT/PRE_ SCHEMA/PROCACT_SCHEMA Processing object type SCHEMA_EXPORT/TABLE/ TABLE Processing object type SCHEMA_EXPORT/TABL E/GRANT/OWNER_GRANT/ OBJECT_GRANT Processing object type SCHEMA_EXPORT/TABLE/ INDEX/INDEX Processing object type SCHEMA_EXPORT/TABLE/ CONSTRAINT/CONSTRAINT . . exported "&lt;Schema Name&gt;". "&lt;Table Name&gt;"</p> <p>228.9 MB 496397 rows</p> <p>Master table "SYSTEM". "SYS_EXPORT_SCHEMA _02" successfully loaded/unloaded</p>	

Task	Description	Skills required
	<pre> ***** ***** ***** ***** **** Dump file set for SYSTEM.SYS_EXPORT_ SCHEMA_02 is: E:\DMSDUMP\EXPORT_ DMS_DATA.DMP Job "SYSTEM"."SYS_EXPO RT_SCHEMA_02" successfully completed at *** ** * **.*.* **** elapsed 0 00:01:57                     </pre>	

### Use Oracle Data Pump to import the EnterpriseOne schema

Task	Description	Skills required
<p>Transfer the dump file to the target instance.</p>	<p>To transfer your files by using the DBMS_FILE_TRANSFER utility, you need to create a database link from the source database to the Amazon RDS for Oracle instance. After the link is established, you can use the utility to transfer the Data Pump files directly to the Amazon RDS instance.</p> <p>Alternatively, you can transfer the Data Pump files to <a href="#">Amazon Simple Storage Service (Amazon S3)</a> and then import them into the Amazon RDS for Oracle instance. For</p>	<p>DBA</p>

Task	Description	Skills required
	<p>more information about this option, see the <a href="#">Additional information</a> section.</p> <p>To create a database link ORARDSDB that connects to the Amazon RDS master user at the target DB instance, run the following commands on the source database:</p> <pre>sqlplus / as sysdba  SQL*Plus: Release 19.0.0.0.0 on *** *** ** **:**:** **** Version 19.3.0.0.0  Copyright (c) 1982, 2019, Oracle. All rights reserved.  Connected to: Oracle Database 19c Standard Edition 2 Release 19.0.0.0.0 Version 19.3.0.0.0  SQL&gt; create database link orardsdb connect to admin identifie d by "*****" using '(DESCRIPTION = (ADDRESS = (PROTOCOL = TCP)(HOST = orcl.**** **.us-east-1.rds.a mazonaws.com)(PORT = 1521))(CONNECT_DATA = (SERVER = DEDICATED</pre>	

Task	Description	Skills required
	<pre>) (SERVICE_NAME = orcl)))';  Database link created.  SQL&gt;</pre>	
Test the database link.	<p>Test the database link to make sure that you can connect to the Amazon RDS for Oracle target database by using sqlplus.</p> <pre>SQL&gt; select name from v \$database@orardsdb;  NAME ----- ORCL</pre>	DBA

Task	Description	Skills required
Transfer the dump file to the target database.	<p>To copy the dump file over to the Amazon RDS for Oracle database, you can either use the default DATA_PUMP_DIR directory or you can create your own directory by using the following code, which has to run on the target Amazon RDS instance:</p> <pre data-bbox="592 682 1027 1081">exec rdsadmin.rdsadmin_ util.create_direct ory(p_directory_name =&gt; 'DMS_TARGET_PUMP_D IR');  PL/SQL procedure successfully completed .</pre> <p>The following script copies a dump file named EXPORT_DMS_DATA.DMP from the source instance to a target Amazon RDS for Oracle database by using the database link named orardsdb. You must run the script on the source database instance.</p> <pre data-bbox="592 1619 1027 1871">BEGIN DBMS_FILE_TRANSFER.PU T_FILE( source_directory_ob ject =&gt; 'DMS_DATA _PUMP_DIR',</pre>	DBA

Task	Description	Skills required
	<pre> source_file_name =&gt;   'EXPORT_DMS_DATA.D MP', destination_directory_ object =&gt; 'DMS_TARG ET_PUMP_DIR', destination_file_name =&gt; 'EXPORT_DMS_DATA.D MP', destination_database =&gt; 'orardsdb'); END;  PL/SQL procedure successfully completed . </pre>	
<p>List the dump file in the target database.</p>	<p>After the PL/SQL procedure is complete, you can list the data dump file in the Amazon RDS for Oracle database by using the following code:</p> <pre> select * from table (rdsadmin.rds_file _util.listdir(p_di rectory =&gt; 'DMS_TARG ET_PUMP_DIR')); </pre>	<p>DBA</p>



Task	Description	Skills required
Create JDE-specific users in the target Instance.	<p>Create a JD Edwards profile and role by using these commands in the target instance:</p> <pre>SQL&gt; CREATE PROFILE "JDEPROFILE" LIMIT IDLE_TIME 15; Profile created.  SQL&gt; CREATE ROLE "JDE_ROLE"; Role created.  SQL&gt; CREATE ROLE "JDEADMIN"; CREATE ROLE "JDEUSER"; Role created. Role created.</pre> <p>Grant the required permissions to the role:</p> <pre>SQL&gt; GRANT CREATE ANY SEQUENCE TO JDE_ROLE; GRANT DROP ANY SEQUENCE TO JDE_ROLE; GRANT CREATE ANY TRIGGER TO JDE_ROLE; GRANT DROP ANY TRIGGER TO JDE_ROLE;</pre>	DBA, JDE CNC

Task	Description	Skills required
Create tablespaces in the target instance.	<p>Create the required tablespaces in the target instance by using the following commands for the schemas that are involved in this migration:</p> <pre data-bbox="597 537 1027 936">SQL&gt; CREATE TABLESPACE &lt;Tablespace Name for Tables&gt;; Tablespace created.  SQL&gt; CREATE TABLESPACE &lt;Tablespace Name for Indexes&gt;; Tablespace created.</pre>	DBA, JDE CNC

Task	Description	Skills required
Initiate the import on the target database.	<p>Before you start the import process, set up the roles, schemas, and tablespaces on the target Amazon RDS for Oracle database by using the data dump file.</p> <p>To perform the import, access the target database with the Amazon RDS primary user account, and use the connection string name in the <code>tnsnames.ora</code> file, which includes the Amazon RDS for Oracle Database <code>tns-entry</code>. If necessary, you can include a remap option to import the data dump file into a different tablespace or under a different schema name.</p> <p>To start the import, use the following code:</p> <pre data-bbox="594 1367 1027 1604">impdp admin@orardsdb directory=DMS_TARG ET_PUMP_DIR logfile=i mport.log dumpfile= EXPORT_DMS_DATA.DMP</pre> <p>To ensure a successful import, check the import log file for any errors, and review details such as object count, row count, and invalid objects. If</p>	DBA

Task	Description	Skills required
	there are any invalid objects, recompile them. Additionally, compare the source and target database objects to confirm that they match.	

## Provision an AWS DMS replication instance with the source and target endpoints

Task	Description	Skills required
Download the template.	Download the AWS CloudFormation <a href="#">DMS_instance.yaml</a> template to provision the AWS DMS replication instance and its source and target endpoints.	Cloud administrator, DBA
Start the stack creation.	<ol style="list-style-type: none"> <li>1. Sign in to the AWS Management Console, and open the AWS CloudFormation console at <a href="https://console.aws.amazon.com/cloudformation">https://console.aws.amazon.com/cloudformation</a>.</li> <li>2. Choose <b>Create stack</b>.</li> <li>3. For <b>Specify template</b>, choose <b>Upload a template file</b>.</li> <li>4. Choose <b>Choose file</b>.</li> <li>5. Choose the <code>DMS_instance.yaml</code> file.</li> <li>6. Choose <b>Next</b>.</li> </ol>	Cloud administrator, DBA
Specify the parameters.	<ol style="list-style-type: none"> <li>1. For <b>Stack name</b>, enter your stack name.</li> </ol>	Cloud administrator, DBA

Task	Description	Skills required
	<p>2. For <b>AWS DMS Instance Parameters</b>, enter the following parameters:</p> <ul style="list-style-type: none"><li>• <b>DMSInstanceType</b> – Choose the required instance for the AWS DMS replication instance, based on your business needs.</li><li>• <b>DMSStorageSize</b> – Enter the storage size for the AWS DMS instance, based on the size of your migration.</li></ul> <p>3. For <b>Source Oracle Database Configuration</b>, enter the following parameters:</p> <ul style="list-style-type: none"><li>• <b>SourceOracleEndpointID</b> – The source Oracle database server name</li><li>• <b>SourceOracleDatabaseName</b> – The source database service name or session ID (SID) as applicable</li><li>• <b>SourceOracleUserName</b> – The source database username (the default is system)</li><li>• <b>SourceOracleDBPassword</b> – The source</li></ul>	

Task	Description	Skills required
	<p>database username's password</p> <ul style="list-style-type: none"> <li>• <b>SourceOracleDBPort</b> – The source database port</li> </ul> <p>4. For <b>Target RDS for Oracle Database Configuration</b>, enter the following parameters:</p> <ul style="list-style-type: none"> <li>• <b>TargetRDSOracleEndpointID</b> – The target RDS database endpoint</li> <li>• <b>TargetRDSOracleDatabaseName</b> – The target RDS database name</li> <li>• <b>TargetRDSOracleUsername</b> – The target RDS username</li> <li>• <b>TargetRDSOracleDBPassword</b> – The target RDS password</li> <li>• <b>TargetOracleDBPort</b> – The target RDS database port</li> </ul> <p>5. For <b>VPC, Subnet and Security Group Configuration</b>, enter the following parameters:</p> <ul style="list-style-type: none"> <li>• <b>VPCID</b> – The VPC for the replication instance</li> <li>• <b>VPCSecurityGroupID</b> – The VPC security group for the replication instance</li> </ul>	

Task	Description	Skills required
	<ul style="list-style-type: none"><li>• <b>DMSSubnet1</b> – The subnet for Availability Zone 1</li><li>• <b>DMSSubnet2</b> – The subnet for Availability Zone 2</li></ul> <p>6. Choose <b>Next</b>.</p>	
Create the stack.	<ol style="list-style-type: none"><li>1. On the <b>Configure stack options</b> page, for <b>Tags</b>, enter any optional values.</li><li>2. Choose <b>Next</b>.</li><li>3. On the <b>Review</b> page, verify the details, and then choose <b>Submit</b>.</li></ol> <p>The provisioning should complete in approximately 5–10 minutes. It is complete when the AWS CloudFormation Stacks page shows <b>CREATE_COMPLETE</b>.</p>	Cloud administrator, DBA

Task	Description	Skills required
Set up the endpoints.	<ol style="list-style-type: none"> <li>1. Open the AWS DMS console at <a href="https://console.aws.amazon.com/dms/v2/">https://console.aws.amazon.com/dms/v2/</a>.</li> <li>2. For <b>Resource management</b>, choose <b>Replication instances</b>, and then review the replication instances.</li> <li>3. For <b>Resource management</b>, choose <b>Endpoints</b>, and then review the endpoints.</li> </ol>	Cloud administrator, DBA
Test connectivity.	After the source and target endpoints shows the status as <b>Active</b> , test the connectivity. Choose <b>Run test</b> for each endpoint (source and target) to make sure that the status shows as successful.	Cloud administrator, DBA

### Create an AWS DMS replication task for live replication

Task	Description	Skills required
Create the replication task.	<p>Create the AWS DMS replication task by using the following steps:</p> <ol style="list-style-type: none"> <li>1. Open the AWS DMS console at <a href="https://console.aws.amazon.com/dms/v2/">https://console.aws.amazon.com/dms/v2/</a>.</li> <li>2. In the navigation pane, under <b>Migrate Data</b>,</li> </ol>	Cloud administrator, DBA



Task	Description	Skills required
	<p>choose <b>Database migration task</b>.</p> <ol style="list-style-type: none"><li>3. In the <b>Task configuration</b> box, for <b>Task identifier</b>, enter your task identifier.</li><li>4. For <b>Replication instance</b>, choose the DMS replication instance that you created.</li><li>5. For <b>Source database endpoint</b>, choose your source endpoint.</li><li>6. For <b>Target database endpoint</b>, choose your target Amazon RDS for Oracle database.</li><li>7. For <b>Migration type</b>, choose <b>Replicate data changes only</b>. If you receive a message that supplemental logging needs to be turned on, follow the instructions in the <a href="#">Troubleshooting</a> section.</li><li>8. In the <b>Task settings</b> box, choose <b>Specify log sequence number</b>.</li><li>9. For <b>System change number</b>, enter the Oracle database SCN that you generated from the source Oracle database.</li><li>10. Choose <b>Enable validation</b>.</li></ol>	

Task	Description	Skills required
	<p>11 Choose <b>Enable CloudWatch Logs</b>.</p> <p>By activating this feature, you can validate the data and <a href="#">Amazon CloudWatch logs</a> to review the AWS DMS replication instance logs.</p> <p>12 Under <b>Selection rules</b>, complete the following:</p> <ul style="list-style-type: none"><li>• For <b>Schema</b>, choose <b>Enter a schema</b>.</li><li>• For <b>Schema name</b>, enter the JDE Schema name (for example: <b>DV920</b>).</li><li>• For <b>Table name</b>, enter %.</li><li>• For <b>Action</b>, choose <b>Include</b>.</li></ul> <p>13 Choose <b>Create task</b>.</p> <p>After you create the task, AWS DMS migrates ongoing changes to the Amazon RDS for Oracle database instance from the SCN that you provided under CDC start mode. You can also verify the migration by reviewing the CloudWatch logs.</p>	

Task	Description	Skills required
Repeat the replication task.	Repeat the previous steps to create replication tasks for other JD Edwards schemas that are part of the migration.	Cloud administrator, DBA, JDE CNC administrator

## Validate the database schema on the target Amazon RDS for Oracle database

Task	Description	Skills required
Validate the data transfer.	<p>After the AWS DMS task starts, you can check the <b>Table statistics</b> tab on the <b>Tasks</b> page to see the changes made to the data.</p> <p>You can monitor the status of ongoing replication in the console on the <b>Database migration tasks</b> page.</p> <p>For more information, see <a href="#">AWS DMS data validation</a>.</p>	Cloud administrator, DBA

## Cut over

Task	Description	Skills required
Stop replication.	Discontinue the replication procedure and stop the source application services.	Cloud administrator, DBA
Launch the JD Edwards application.	Launch the target JD Edwards presentation and logic tier application on AWS, and	DBA, JDE CNC administrator

Task	Description	Skills required
	<p>direct it to the Amazon RDS for Oracle database.</p> <p>When you access the application, you should notice that all connections are now established with the Amazon RDS for Oracle database.</p>	
Turn off the source database.	After you confirm that there are no more connections, you can turn the source database off.	DBA

## Troubleshooting

Issue	Solution
You receive a warning message to enable <a href="#">supplemental logging</a> in the source database for on-going replication	<p>Enter these commands to enable supplemental logging:</p> <pre>SQL&gt; ALTER DATABASE ADD SUPPLEMENTAL LOG DATA (ALL) COLUMNS; SQL&gt; ALTER DATABASE ADD SUPPLEMENTAL LOG DATA (PRIMARY KEY) COLUMNS; SQL&gt; ALTER DATABASE ADD SUPPLEMENTAL LOG DATA (UNIQUE) COLUMNS; SQL&gt; ALTER DATABASE ADD SUPPLEMENTAL LOG DATA (FOREIGN KEY) COLUMNS; SQL&gt; ALTER DATABASE ADD SUPPLEMENTAL LOG DATA (PRIMARY KEY) COLUMNS; SQL&gt; ALTER DATABASE ADD SUPPLEMENTAL LOG DATA (UNIQUE) COLUMNS;</pre>
AWS DMS has supplemental logging turned off.	Supplemental logging is turned off by default in AWS DMS. To turn it on for a source Oracle endpoint:

Issue	Solution
	<ol style="list-style-type: none"><li>1. Sign in to the AWS Management Console and open the AWS DMS console at <a href="https://console.aws.amazon.com/dms/v2/">https://console.aws.amazon.com/dms/v2/</a>.</li><li>2. Choose <b>Endpoints</b>.</li><li>3. Choose the Oracle source endpoint that you want to add supplemental logging to.</li><li>4. Choose <b>Modify</b>.</li><li>5. Choose <b>Advanced</b>, and then add the following code to the <b>Extra connection attributes</b> text box:<pre>addSupplementalLogging=Y</pre></li><li>6. Choose <b>Modify</b>.</li></ol>
<p>Supplemental logging isn't enabled at the CDB level.</p>	<ol style="list-style-type: none"><li>1. Enter this command:<pre>SQL&gt; alter session set container = CDB\$ROOT;  Session altered.</pre></li><li>2. Repeat the steps to enable supplemental logging.</li></ol>
<p>You receive the error message: "Test Endpoint failed: Application-Status: 1020912, Application-Message: LogMiner is not supported in Oracle PDB environment Endpoint initialization failed."</p>	<p>If you encounter this error message, you can use Binary Reader instead of LogMiner.</p> <p>Under <b>Endpoint settings</b>, add this line to the extra connection attributes for your source database:<pre>useLogMinerReader=N;useBfile=Y;</pre></p>

## Related resources

- [Getting started with AWS Database Migration Service](#)
- [Best Practices for AWS Database Migration Service](#)
- [Migrating Oracle Databases to the AWS Cloud](#)
- [AWS Database Migration Service resource type reference for AWS CloudFormation](#)
- [Manage your AWS DMS endpoint credentials with AWS Secrets Manager](#)
- [Troubleshooting migration tasks in AWS Database Migration Service](#)
- [Best practices for AWS Database Migration Service](#)

## Additional information

### Transfer files using Amazon S3

To transfer the files to Amazon S3, you can use the AWS CLI or the Amazon S3 console. After you transfer the files to Amazon S3, you can use the Amazon RDS for Oracle instance to import the Data Pump files from Amazon S3.

If you choose to transfer the dump file using Amazon S3 integration as an alternate method, perform the follow steps:

1. Create an S3 bucket.
2. Export the data from the source database using Oracle Data Pump.
3. Upload the Data Pump files to the S3 bucket.
4. Download the Data Pump files from the S3 bucket to the target Amazon RDS for Oracle database.
5. Perform the import using the Data Pump files.

**Note:** To transfer large data files between S3 and RDS instances, we recommend that you use the [Amazon S3 Transfer Acceleration](#) feature.

# Migrate an Oracle PeopleSoft database to AWS by using AWS DMS

*Created by sampath kathirvel (AWS)*

<b>Environment:</b> Production	<b>Source:</b> Oracle PeopleSoft	<b>Target:</b> Amazon RDS for Oracle
<b>R Type:</b> Replatform	<b>Workload:</b> Oracle	<b>Technologies:</b> Migration; Databases
<b>AWS services:</b> AWS DMS; Amazon RDS		

## Summary

[Oracle PeopleSoft](#) is an enterprise resource planning (ERP) solution for enterprise-wide processes. PeopleSoft has a three-tier architecture: client, application, and database. PeopleSoft can be run on [Amazon Relational Database Service \(Amazon RDS\)](#).

If you migrate your Oracle database to Amazon RDS, Amazon Web Services (AWS) can take care of backup tasks and high availability, leaving you free to concentrate on maintaining your PeopleSoft application and its functionality. For a comprehensive list of key factors to consider during the migration process, see [Oracle database migration strategies](#) in AWS Prescriptive Guidance.

This pattern provides a solution for migrating your on-premises Oracle databases to Amazon RDS for Oracle using Oracle Data Pump with [AWS Database Migration Service \(AWS DMS\)](#) and its change data capture (CDC) feature.

When migrating critical ERP applications such as Oracle PeopleSoft, minimizing the downtime is key. AWS DMS minimizes downtime by supporting both full load and continuous replication from the source database to the target database. AWS DMS also provides real-time monitoring and logging of the migration, which can help you to identify and resolve any issues that could cause downtime.

When replicating changes with AWS DMS, you must specify a time or system change number (SCN) as the starting point for AWS DMS to read changes from the database logs. It's crucial to keep these logs accessible on the server for a designated amount of time to ensure that AWS DMS has access to these changes.

## Prerequisites and limitations

### Prerequisites

- Provisioned Amazon RDS for Oracle database in your AWS Cloud environment as the target database.
- An Oracle PeopleSoft database running on premises or on Amazon Elastic Compute Cloud (Amazon EC2) in the AWS Cloud.

**Note:** This pattern is designed for migrating from on premises to AWS, but it was tested by using Oracle Database on an Amazon EC2 instance. For migrating from on premises, you will need to configure the appropriate network connectivity.

- Schema details. When migrating an Oracle PeopleSoft application to Amazon RDS for Oracle, it is necessary to identify which Oracle database schema (for example, SYSADM) to migrate. Before starting the migration process, gather the following details about the schema:
  - Size
  - The number of objects per object type
  - The number of invalid objects.

This information will aid in the migration process.

### Limitations

- This scenario has been tested only with the PeopleSoft DEMO database. It hasn't been tested with a large dataset.

### Architecture

The following diagram shows an instance running an Oracle database as the source database and an Amazon RDS for Oracle database as the target database. The data is exported and imported from the source Oracle database to the target Amazon RDS for Oracle database using Oracle Data Pump and replicated for CDC changes using AWS DMS.



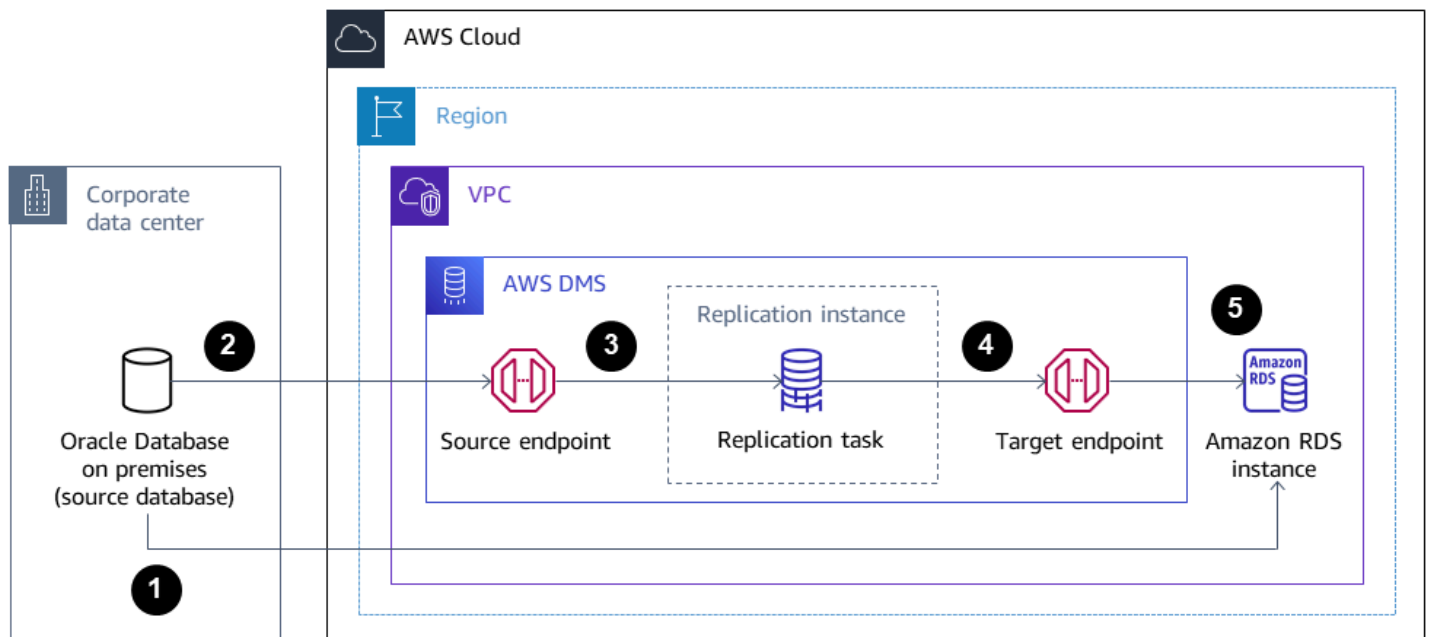

1. The initial step involves extracting data from the source database by using Oracle Data Pump, followed by sending it to the Amazon RDS for Oracle database target.
2. Data is sent from the source database to a source endpoint in AWS DMS.
3. From the source endpoint, the data is sent to the AWS DMS replication instance, where the replication task is performed.
4. After the replication task is completed, the data is sent to the target endpoint in AWS DMS.
5. From the target endpoint, the data is sent to the Amazon RDS for Oracle database instance.

## Tools

### AWS services

- [AWS Database Migration Service \(AWS DMS\)](#) helps you migrate data stores into the AWS Cloud or between combinations of cloud and on-premises setups.
- [Amazon Relational Database Service \(Amazon RDS\) for Oracle](#) helps you set up, operate, and scale an Oracle relational database in the AWS Cloud.

### Other services

- [Oracle Data Pump](#) helps you move data and metadata from one database to another at high speeds.

## Best practices

### Migrating LOBs

If your source database contains large binary objects (LOBs) that need to be migrated to the target database, AWS DMS provides the following options:

- **Full LOB mode** – AWS DMS migrates all the LOBs from the source to the target database regardless of their size. Although the migration is slower, the advantage is that data isn't truncated. For better performance, you can create a separate task on the new replication instance to migrate the tables that have LOBs larger than a few megabytes.
- **Limited LOB mode** – You specify the maximum size of LOB column data, which allows AWS DMS to pre-allocate resources and apply the LOBs in bulk. If the size of the LOB columns exceeds the size that is specified in the task, AWS DMS truncates the data and sends warnings to the AWS DMS log file. You can improve performance by using Limited LOB mode if your LOB data size is within the Limited LOB size.
- **Inline LOB mode** – You can migrate LOBs without truncating the data or slowing the performance of your task by replicating both small and large LOBs. First, specify a value for the `InlineLobMaxSize` parameter, which is available only when Full LOB mode is set to true. The AWS DMS task transfers the small LOBs inline, which is more efficient. Then, AWS DMS migrates the large LOBs by performing a lookup from the source table. However, Inline LOB mode works only during the full load phase.

### Generating sequence values

Keep in mind that during the change data capture process with AWS DMS, incremental sequence numbers are not replicated from the source database. To avoid discrepancies in sequence values, you must generate the most recent sequence value from the source for all sequences, and apply it to the target Amazon RDS for Oracle database.

### Credential management

To help secure your AWS resources, we recommend following the [best practices](#) for AWS Identity and Access Management (IAM).

## Epics

### Provision an AWS DMS replication instance with the source and target endpoints

Task	Description	Skills required
Download the template.	Download the <a href="#">DMS_instance.yaml</a> AWS CloudFormation template to provision the AWS DMS replication instance and its source and target endpoints.	Cloud administrator, DBA
Start the stack creation.	<ol style="list-style-type: none"> <li>1. On the AWS Management Console, choose <b>CloudFormation</b>.</li> <li>2. Choose <b>Create stack</b>.</li> <li>3. For <b>Specify template</b>, choose <b>Upload a template file</b>.</li> <li>4. Choose <b>Choose file</b>.</li> <li>5. Choose the <code>DMS_instance.yaml</code> file.</li> <li>6. Choose <b>Next</b>.</li> </ol>	Cloud administrator, DBA
Specify the parameters.	<ol style="list-style-type: none"> <li>1. For <b>Stack name</b>, enter your stack name.</li> <li>2. Under <b>AWS DMS Instance Parameters</b>, enter the following parameters: <ul style="list-style-type: none"> <li>• <b>DMSInstanceType</b> – Choose the required instance for the AWS DMS replication instance, based on your business needs.</li> </ul> </li> </ol>	Cloud administrator, DBA

Task	Description	Skills required
	<ul style="list-style-type: none"> <li>• <b>DMSStorageSize</b> – Enter the storage size for the AWS DMS instance, based on the size of your migration.</li> </ul> <p>3. Under <b>Source Oracle Database Configuration</b>, enter the following parameters:</p> <ul style="list-style-type: none"> <li>• <b>SourceOracleEndpointID</b> – The source Oracle database server name</li> <li>• <b>SourceOracleDatabaseName</b> – The source database service name or session ID (SID) as applicable</li> <li>• <b>SourceOracleUserName</b> – The source database username (the default is system)</li> <li>• <b>SourceOracleDBPassword</b> – The source database username's password</li> <li>• <b>SourceOracleDBPort</b> – The source database port</li> </ul> <p>4. Under <b>Target RDS for Oracle Database Configuration</b>, enter the following parameters:</p>	

Task	Description	Skills required
	<ul style="list-style-type: none"> <li>• <b>TargetRDSOracleEndPointID</b> – The target RDS database endpoint</li> <li>• <b>TargetRDSOracleDatabaseName</b> – The target RDS database name</li> <li>• <b>TargetRDSOracleUsername</b> – The target RDS username</li> <li>• <b>TargetRDSOracleDBPassword</b> – The target RDS password</li> <li>• <b>TargetOracleDBPort</b> – The target RDS database port</li> </ul> <p>5. Under <b>VPC, Subnet and Security Group Configuration</b>, enter the following parameters:</p> <ul style="list-style-type: none"> <li>• <b>VPCID</b> – The VPC for the replication instance</li> <li>• <b>VPCSecurityGroupID</b> – The VPC security group for the replication instance</li> <li>• <b>DMSSubnet1</b> – The subnet for Availability Zone 1</li> <li>• <b>DMSSubnet2</b> – The subnet for Availability Zone 2</li> </ul> <p>6. Choose <b>Next</b>.</p>	

Task	Description	Skills required
Create the stack.	<ol style="list-style-type: none"> <li>1. On the <b>Configure stack options</b> page, for <b>Tags</b>, enter any optional values.</li> <li>2. Choose <b>Next</b>.</li> <li>3. On the <b>Review</b> page, verify the details, and then choose <b>Submit</b>.</li> </ol> <p>The provisioning should complete in approximately 5–10 minutes. It is complete when the AWS CloudFormation Stacks page shows <b>CREATE_COMPLETE</b>.</p>	Cloud administrator, DBA
Set up the endpoints.	<ol style="list-style-type: none"> <li>1. From the AWS Management Console, choose <b>Database Migration Services</b>.</li> <li>2. Under Resource management, choose <b>Replication instances</b>.</li> <li>3. Under Resource management, choose <b>Endpoints</b>.</li> </ol>	Cloud administrator, DBA
Test connectivity.	<p>After the source and target endpoints shows status as Active, test the connectivity. Choose <b>Run test</b> for each endpoint (source and target) to make sure that the status shows as successful.</p>	Cloud administrator, DBA

## Export the PeopleSoft schema from the on-premises Oracle database by using Oracle Data Pump

Task	Description	Skills required
Generate the SCN.	<p>When the source database is active and in use by the application, initiate the data export with Oracle Data Pump. You must first generate a system change number (SCN) from the source database for both data consistency during the export with Oracle Data Pump and as a starting point for change data capture in AWS DMS.</p> <p>To generate the current SCN from your source database, enter the following SQL statement.</p> <pre data-bbox="594 1199 1027 1717">SQL&gt; select name from v \$database; SQL&gt; select name from v \$database; NAME ----- PSFTDMO SQL&gt; SELECT current_s cn FROM v\$database; CURRENT_SCN ----- 23792008</pre>	DBA

Task	Description	Skills required
	and for creating the AWS DMS replication task.	



Task	Description	Skills required
Create the parameter file.	<p>To create a parameter file for exporting the schema, you can use the following code.</p> <pre data-bbox="597 394 1027 869">\$ cat exp_datapmp.par userid=system/***** directory=DATA_P UMP_DIR logfile=export_dms_ sample_user.log dumpfile=export_dms_ sample_data_%U.dmp schemas=SYSADM flashback_scn=237920 08</pre> <p><b>Note:</b> You can also define your own DATA_PUMP_DIR by using the following commands, based on your requirements.</p> <pre data-bbox="597 1171 1027 1854">SQL&gt; CREATE OR REPLACE   DIRECTORY DATA_PUMP   _DIR AS '/opt/oracle/   product/19c/dbhome_1/   dmsdump/'; Directory created. SQL&gt; GRANT READ, WRITE   ON DIRECTORY DATA_PUMP   _DIR TO system; Grant succeeded. SQL&gt; SQL&gt; SELECT owner,   directory_name,   directory_path FROM   dba_directories WHERE   directory_name='DA   TA_PUMP_DIR';</pre>	DBA



Task	Description	Skills required
Export the schema.	<p>To perform the export, use the expdp utility.</p> <pre data-bbox="592 346 1031 1837"> \$ expdp parfile=e xp_datapmp.par ..... .. Transferring the dump file with DBMS_FILE _TRANSFER to Target: . . exported "SYSADM". "PS_XML_TEMPLT_LNG" 6.320 KB 0 rows . . exported "SYSADM". "PS_XML_TEMPLT_LNK" 6.328 KB 0 rows . . exported "SYSADM". "PS_XML_XLATDEF_LNG" 6.320 KB 0 rows . . exported "SYSADM". "PS_XML_XLATITM_LNG" 7.171 KB 0 rows . . exported "SYSADM". "PS_XPQRYRUNCNTL" 7.601 KB 0 rows . . exported "SYSADM". "PS_XPQRYRUNPARAM" 7.210 KB 0 rows . . exported "SYSADM". "PS_YE_AMOUNTS" 9.351 KB 0 rows . . exported "SYSADM". "PS_YE_DATA" 16.58 KB 0 rows . . exported "SYSADM". "PS_YE_EE" 6.75 KB 0 rows . . exported "SYSADM". "PS_YE_W2CP_AMOUNTS" 9.414 KB 0 rows </pre>	DBA

Task	Description	Skills required
	<pre> . . exported "SYSADM". "PS_YE_W2CP_DATA"  20.94 KB 0 rows . . exported "SYSADM". "PS_YE_W2C_AMOUNTS"  10.27 KB 0 rows . . exported "SYSADM". "PS_YE_W2C_DATA" 20.95 KB 0 rows . . exported "SYSADM". "PS_ZBD_JOBCODE_TBL"  14.60 KB 0 rows . . exported "SYSADM". "PTGRANTTBL" 5.468 KB  0 rows Master table "SYSTEM". "SYS_EXPORT_SCHEMA _01" successfully loaded/unloaded ** Dump file set for SYSTEM.SYS_EXPORT_ SCHEMA_01 is: /opt/oracle/pr oduct/19c/dbhome_1 /dmsdump/export_dm s_sample_data_01.dmp Job "SYSTEM"."SYS_EXPO RT_SCHEMA_01" successfully completed at Mon Dec 19 20:13:57 2022 elapsed 0 00:38:22 </pre>	

## Import the PeopleSoft schema into the Amazon RDS for Oracle database by using Oracle Data Pump

Task	Description	Skills required
Transfer the dump file to the target instance.	<p>To transfer your files using <code>DBMS_FILE_TRANSFER</code> , you need to create a database link from the source database to the Amazon RDS for Oracle instance. After the link is established, you can use the utility to transfer the Data Pump files directly to the RDS instance.</p> <p>Alternatively, you can transfer the Data Pump files to <a href="#">Amazon Simple Storage Service (Amazon S3)</a> and then import them into the Amazon RDS for Oracle instance. For more information about this option, see the Additional information section.</p> <p>To create a database link <code>ORARDSDB</code> that connects to the Amazon RDS master user at the target DB instance, run the following commands on the source database.</p> <pre>\$sqlplus / as sysdba \$ SQL&gt; create database link orardsdb connect to admin identified by "*****" using '(DESCRIP</pre>	DBA

Task	Description	Skills required
	<pre> TION = (ADDRESS =   (PROTOCOL = TCP)(HOST     = testpsft.*****.u s-west-2.ids.amazo naws.com)(PORT =   1521))(CONNECT_DATA   = (SERVER = DEDICATED ) (SERVICE_NAME =   orcl)))'; Database link created.                     </pre>	
<p>Test the database link.</p>	<p>Test the database link to make sure that you can connect using sqlplus to the Amazon RDS for Oracle target database.</p> <pre> SQL&gt; SQL&gt; select name from v \$database@orardsdb; NAME ----- ORCL SQL&gt;                     </pre>	<p>DBA</p>

Task	Description	Skills required
Transfer the dump file to the target database.	<p>To copy the dump file over to Amazon RDS for Oracle database, you can either use the default DATA_PUMP_DIR directory or you can create your own directory using the following code.</p> <pre data-bbox="594 583 1029 825">exec rdsadmin.rdsadmin_ util.create_direct ory(p_directory_name =&gt; 'TARGET_PUMP_DIR') ;</pre> <p>The following script copies a dump file named <code>export_dms_sample_data_01.dmp</code> from the source instance to a target Amazon RDS for Oracle database using the database link named <code>orardsdb</code>.</p> <pre data-bbox="594 1268 1029 1833">\$ sqlplus / as sysdba SQL&gt; BEGIN DBMS_FILE_TRANSFER .PUT_FILE( source_directory _object =&gt; 'DATA_PUM P_DIR', source_file_name =&gt; 'export_dms_sample _data_01.dmp', destination_directory _object =&gt; 'TARGET_P UMP_DIR',</pre>	DBA

Task	Description	Skills required
	<pre>destination_file_name =&gt; 'export_dms_sample _data_01.dmp', destination_database =&gt; 'orardsdb' ); END; / PL/SQL procedure successfully completed .</pre>	
List the dump file in the target database.	<p>After the PL/SQL procedure is completed, you can list the data dump file in the Amazon RDS for Oracle database by using the following code.</p> <pre>SQL&gt; select * from table (rdsadmin.rds_file _util.listdir(p_di rectory =&gt; 'TARGET_P UMP_DIR'));</pre>	DBA



Task	Description	Skills required
Initiate the import on the target database.	<p>Before you start the import process, set up the roles, schemas, and tablespaces on the target Amazon RDS for Oracle database by using the data dump file.</p> <p>To perform the import, access the target database with the Amazon RDS master user account, and use the connection string name in the <code>tnsnames.ora</code> file, which includes the Amazon RDS for Oracle Database <code>tns-entry</code>. If necessary, you can include a remap option to import the data dump file into a different tablespace or under a different schema name.</p> <p>To start the import, use the following code.</p> <pre data-bbox="594 1367 1027 1646">impdp admin@orardsdb   directory=TARGET_P   UMP_DIR logfile=i   mport.log dumpfile=   export_dms_sample_   data_01.dmp</pre> <p>To ensure a successful import, check the import log file for any errors, and review details such as object count, row</p>	DBA

Task	Description	Skills required
	count, and invalid objects. If there are any invalid objects, recompile them. Additionally, compare the source and target database objects to confirm that they match.	

### Create an AWS DMS replication task using CDC to perform live replication

Task	Description	Skills required
Create the replication task.	<p>Create the AWS DMS replication task by using the following steps:</p> <ol style="list-style-type: none"> <li>1. On the AWS DMS console, under <b>Conversion &amp; migration</b>, choose <b>Database migration task</b>.</li> <li>2. Under <b>Task configuration</b>, for <b>Task identifier</b>, enter your task identifier.</li> <li>3. For <b>Replication instance</b>, choose the DMS replication instance that you created.</li> <li>4. For <b>Source database endpoint</b>, choose your source endpoint.</li> <li>5. For <b>Target database endpoint</b>, choose your target Amazon RDS for Oracle database.</li> <li>6. For <b>Migration type</b>, choose <b>Replicate data</b></li> </ol>	Cloud administrator, DBA

Task	Description	Skills required
	<p><b>changes only.</b> If you receive a message that supplemental logging needs to be turned on, follow the instructions in the <i>Additional information</i> section.</p> <p>7. Under <b>Task settings</b>, select <b>Specify log sequence number</b>.</p> <p>8. For <b>System change number</b>, enter the Oracle database SCN that you generated from the source Oracle database.</p> <p>9. Choose <b>Enable validation</b>.</p> <p>10 Choose <b>Enable CloudWatch Logs</b>.</p> <p>By activating this feature, you can validate the data and <a href="#">Amazon CloudWatch</a> logs to review the AWS DMS replication instance logs.</p> <p>11 Under <b>Selection rules</b>, complete the following:</p> <ul style="list-style-type: none"> <li>• For <b>Schema</b>, choose <b>Enter a schema</b>.</li> <li>• For <b>Schema name</b>, enter <b>SYSADM</b>.</li> <li>• For <b>Table name</b>, enter <b>%</b>.</li> </ul>	

Task	Description	Skills required
	<ul style="list-style-type: none"> <li>• For <b>Action</b>, choose <b>Include</b>.</li> </ul> <p>12 Under <b>Transformation rules</b>, complete the following:</p> <ul style="list-style-type: none"> <li>• For <b>Target</b>, choose <b>Table</b>.</li> <li>• For <b>Scheme name</b>, choose <b>Enter a schema</b>.</li> <li>• For <b>Schema name</b>, enter <b>SYSADM</b>.</li> <li>• For <b>Action</b>, choose <b>Rename to</b>.</li> </ul> <p>13 Choose <b>Create task</b>.</p> <p>After you create the task, it migrates the CDC to the Amazon RDS for Oracle database instance from the SCN that you provided under CDC start mode. You can also verify by reviewing the CloudWatch logs.</p>	

### Validate the database schema on the target Amazon RDS for Oracle database

Task	Description	Skills required
Validate the data transfer.	After the AWS DMS task starts, you can check the <b>Table statistics</b> tab on the <b>Tasks</b> page to see the changes made to the data.	Cloud administrator, DBA

Task	Description	Skills required
	<p>You can monitor the status of ongoing replication in the console on the <b>Database migration tasks</b> page.</p> <p>For more information, see <a href="#">AWS DMS data validation</a>.</p>	

## Cut over

Task	Description	Skills required
Stop replication.	Discontinue the replication procedure and halt the source application services.	Cloud administrator, DBA
Launch the PeopleSoft middle tier.	<p>Launch the target PeopleSoft middle tier application in AWS, and direct it to the recently migrated Amazon RDS for Oracle database.</p> <p>When you access the application, you should notice that all app connections are now established with the Amazon RDS for Oracle database.</p>	DBA, PeopleSoft administrator
Turn off the source database.	After you confirm that there are no more connections to the source database, it can be turned off.	DBA

## Related resources

- [Getting started with AWS Database Migration Service](#)
- [Best Practices for AWS Database Migration Service](#)
- [Migrating Oracle Databases to the AWS Cloud](#)

## Additional information

### Transfer files using Amazon S3

To transfer the files to Amazon S3, you can use the AWS CLI or the Amazon S3 console. After you transfer the files to Amazon S3, you can use the Amazon RDS for Oracle instance to import the Data Pump files from Amazon S3.

If you choose to transfer the dump file using Amazon S3 integration as an alternate method, perform the follow steps:

1. Create an S3 bucket.
2. Export the data from the source database using Oracle Data Pump.
3. Upload the Data Pump files to the S3 bucket.
4. Download the Data Pump files from the S3 bucket to the target Amazon RDS for Oracle database.
5. Perform the import using the Data Pump files.

**Note:** To transfer large data files between S3 and RDS instances, it is recommended to use the Amazon S3 Transfer Acceleration feature.

### Activate supplemental logging

If you receive a warning message to enable [supplemental logging](#) in the source database for on-going replication, use the following steps.

```
SQL> ALTER DATABASE ADD SUPPLEMENTAL LOG DATA (ALL) COLUMNS;  
SQL> ALTER DATABASE ADD SUPPLEMENTAL LOG DATA (PRIMARY KEY) COLUMNS;  
SQL> ALTER DATABASE ADD SUPPLEMENTAL LOG DATA (UNIQUE) COLUMNS;  
SQL> ALTER DATABASE ADD SUPPLEMENTAL LOG DATA (FOREIGN KEY) COLUMNS;  
SQL> ALTER DATABASE ADD SUPPLEMENTAL LOG DATA (PRIMARY KEY) COLUMNS  
SQL> ALTER DATABASE ADD SUPPLEMENTAL LOG DATA (UNIQUE) COLUMNS;
```



# Migrate an on-premises MySQL database to Amazon RDS for MySQL

Created by Lorenzo Mota (AWS)

<b>Environment:</b> PoC or pilot	<b>Source:</b> On-premises MySQL database	<b>Target:</b> Amazon RDS for MySQL
<b>R Type:</b> Replatform	<b>Workload:</b> Open-source	<b>Technologies:</b> Migration; Databases
<b>AWS services:</b> AWS DMS; Amazon RDS		

## Summary

This pattern provides guidance for migrating an on-premises MySQL database to Amazon Relational Database Service (Amazon RDS) for MySQL. The pattern discusses the use of AWS Database Migration Service (AWS DMS) or native MySQL tools such as **mysqldump** for a full database migration. This pattern is primarily for DBAs and solution architects. It can be used in small or large projects as a testing procedure (we recommend at least one testing cycle) or as a final migration procedure.

## Prerequisites and limitations

### Prerequisites

- An active AWS account
- A MySQL source database in an on-premises data center

### Limitations

- Database size limit: [64 TB](#)

### Product versions



- MySQL versions 5.5, 5.6, 5.7, 8.0. For the latest list of supported versions, see [MySQL on Amazon RDS](#) in the AWS documentation. If you're using AWS DMS, see also [Using a MySQL-Compatible Database as a Target for AWS DMS](#) for MySQL versions currently supported by AWS DMS.

## Architecture

### Source technology stack

- An on-premises MySQL database

### Target technology stack

- An Amazon RDS DB instance running MySQL

### Target architecture

The following diagram shows the target Amazon RDS for MySQL implementation after migration.

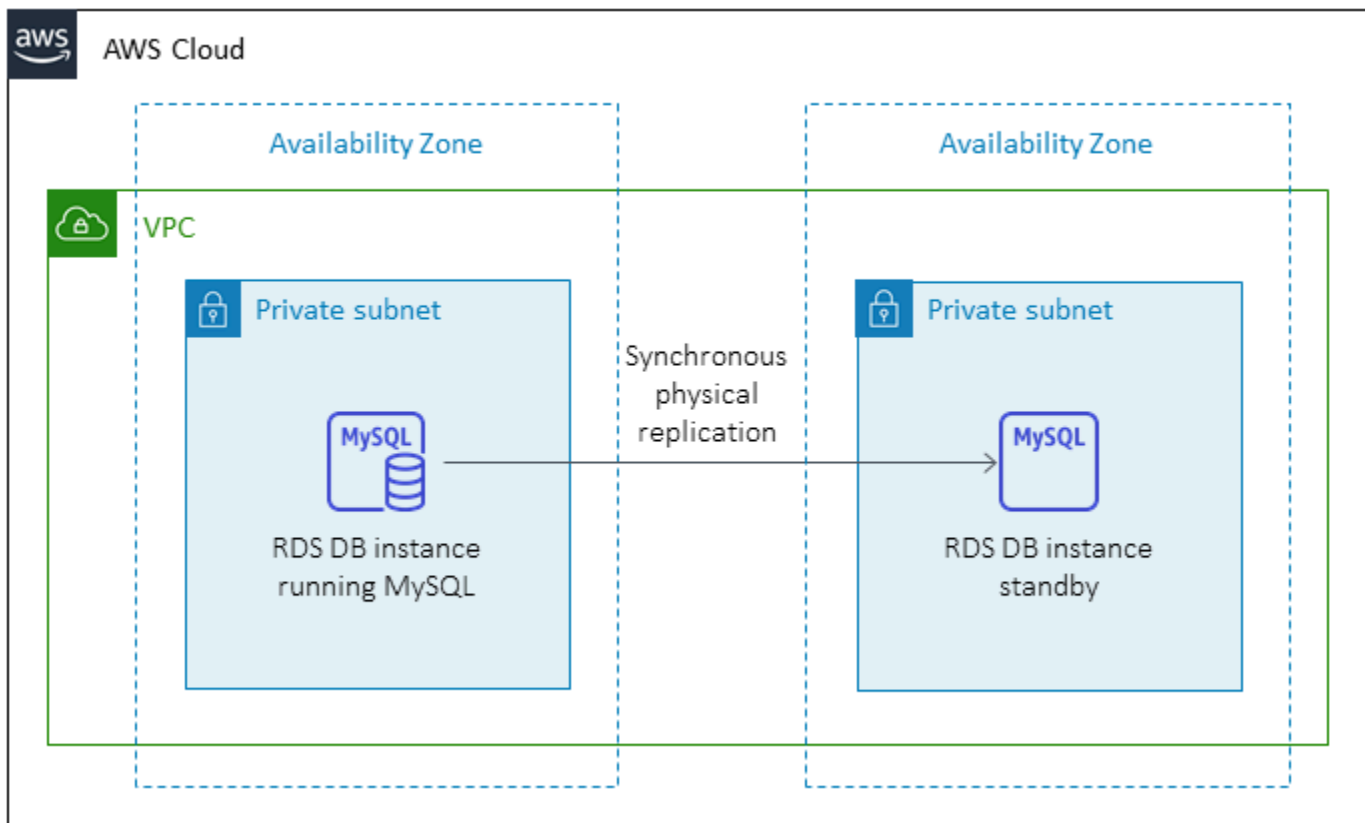

## AWS data migration architecture

## Using AWS DMS:

The following diagram shows the data migration architecture when you use AWS DMS to send full and incremental changes until cutover. The network connection from on premises to AWS depends on your requirements and is out of scope for this pattern.

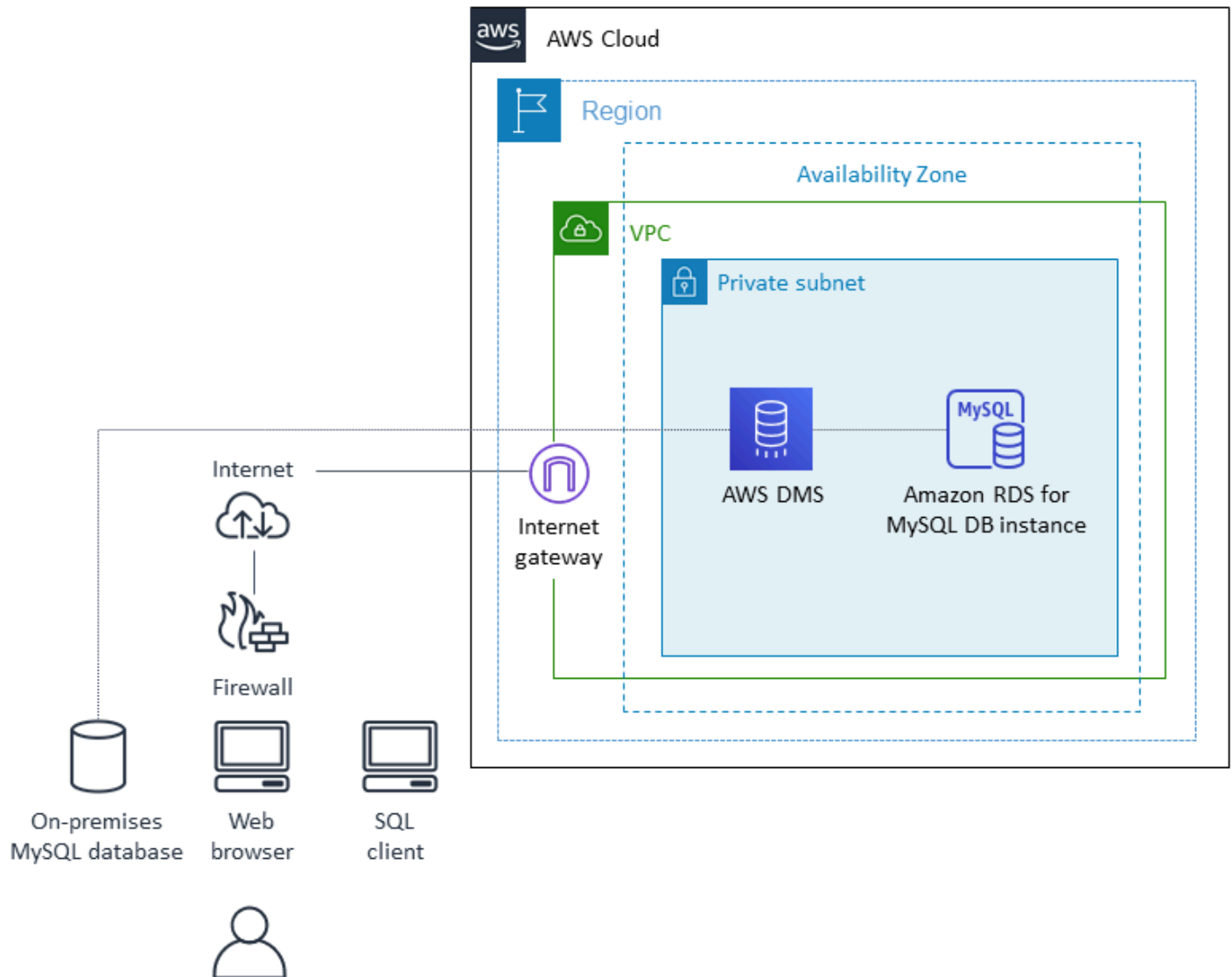

## Using native MySQL tools:

The following diagram shows the data migration architecture when you use native MySQL tools. The export dump files are copied to Amazon Simple Storage Service (Amazon S3) and imported into the Amazon RDS for MySQL database in AWS before the cutover. The network connection from on premises to AWS depends on your requirements and is out of scope for this pattern.

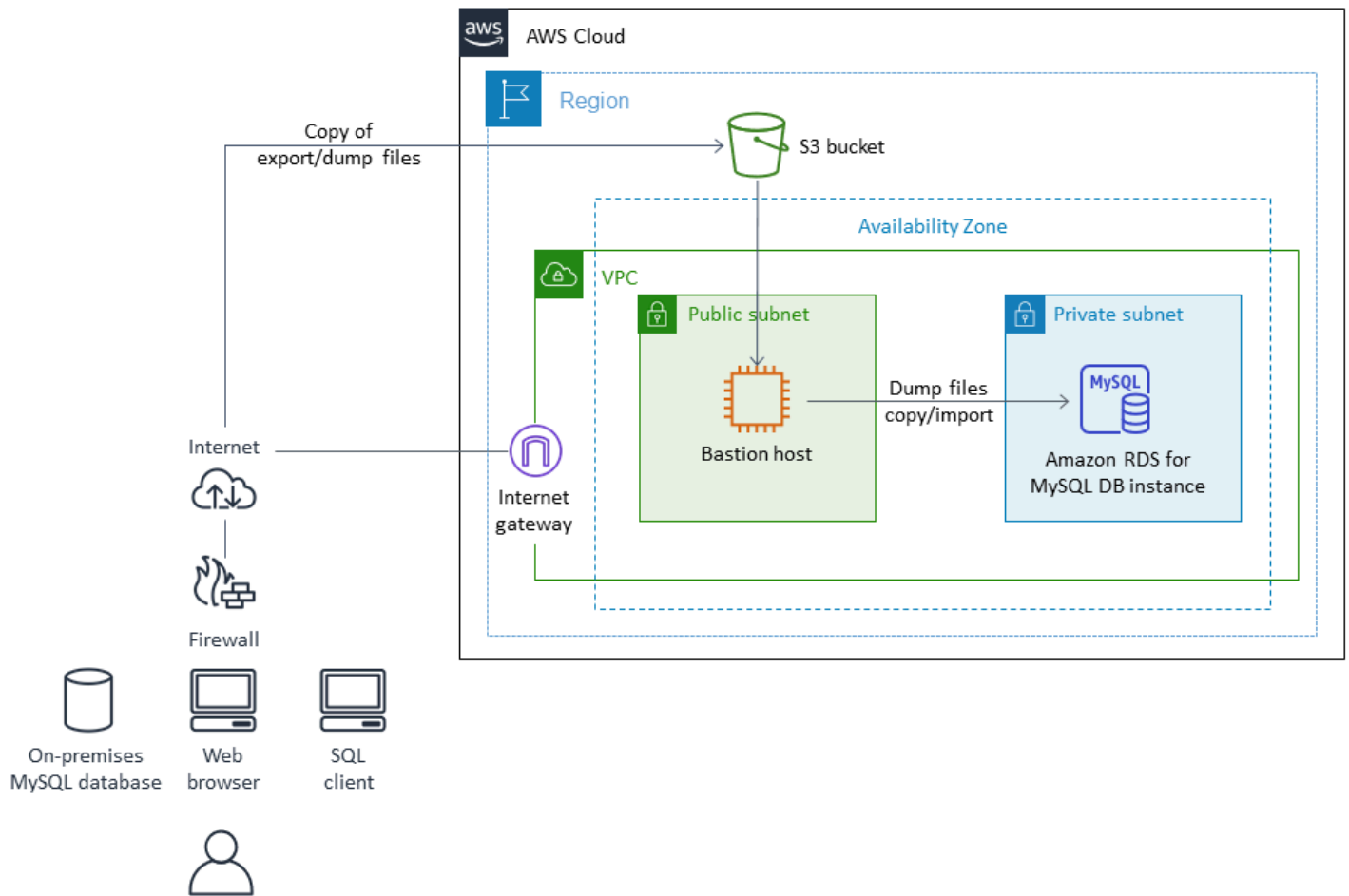

## Notes:

- Depending on downtime requirements and the size of the database, using AWS DMS or a change data capture (CDC) tool minimizes cutover time. AWS DMS can help reduce cutover time to the new target to a minimum (typically minutes). An offline strategy with **mysqldump** can suffice if the size of the database and network latency allow for a short window. (We recommend testing to get an approximate time.)
- Usually a CDC strategy such as AWS DMS requires more monitoring and complexity than offline options.

## Tools

- AWS services:** [AWS Database Migration Service \(AWS DMS\)](#) helps you migrate data stores to the AWS Cloud or between combinations of cloud and on-premises setups. For information about MySQL source and target databases supported by AWS DMS, see [Migrating MySQL-Compatible](#)

[Databases to AWS](#). If your source database isn't supported by AWS DMS, you must choose another method to migrate your data.

- **Native MySQL tools:** [mysqldump](#)
- **Third-party tools:** [Percona XtraBackup](#)

## Epics

### Plan the migration

Task	Description	Skills required
Validate database versions.	Validate the source and target database versions.	DBA
Identify hardware requirements.	Identify the hardware requirements for the target server.	DBA, Systems administrator
Identify storage requirements.	Identify storage requirements (such as storage type and capacity) for the target database.	DBA, Systems administrator
Choose the instance type.	Choose the target instance type based on capacity, storage features, and networking features.	DBA, Systems administrator
Identify network access requirements.	Identify the security requirements for network access for the source and target databases.	DBA, Systems administrator
Identify unsupported objects.	Identify unsupported objects (if any) and determine the migration effort.	DBA

Task	Description	Skills required
Identify dependencies.	Identify any dependencies on remote databases.	DBA
Determine the application migration strategy.	Determine the strategy for migrating client applications.	DBA, App owner, Systems administrator

## Configure the infrastructure

Task	Description	Skills required
Create a virtual private cloud (VPC).	Configure route tables, internet gateway, NAT gateways, and subnets. For more information, see <a href="#">VPCs and Amazon RDS</a> in the Amazon RDS documentation.	Systems administrator
Create security groups.	Configure ports and CIDR ranges or specific IPs depending on your requirements. The default port for MySQL is 3306. For more information, see <a href="#">Controlling access with security groups</a> in the Amazon RDS documentation.	Systems administrator
Configure and start an Amazon RDS for MySQL DB instance.	For instructions, see <a href="#">Creating an Amazon RDS DB instance</a> in the Amazon RDS documentation. Check for supported versions.	Systems administrator

## Migrate data – option 1 (using native tools)

Task	Description	Skills required
Use native MySQL tools or third-party tools to migrate database objects and data.	<p>For instructions, see the documentation for MySQL tools such as <a href="#">mysqldump</a> and <a href="#">Percona XtraBackup</a> (for physical migration).</p> <p>For more information about options, see the blog post <a href="#">Migration options for MySQL to Amazon RDS for MySQL or Amazon Aurora MySQL</a>.</p>	DBA

## Migrate data – option 2 (using AWS DMS)

Task	Description	Skills required
Migrate data with AWS DMS.	For instructions, see the <a href="#">AWS DMS documentation</a> .	DBA

## Perform preliminary tasks before cutover

Task	Description	Skills required
Fix object count discrepancies.	Collect object counts from the source database and new target database. Fix discrepancies in the target database.	DBA
Check dependencies.	Check whether dependencies (links) to and from other databases are valid and work as expected.	DBA

Task	Description	Skills required
Perform tests.	If this is a testing cycle, perform query testing, gather metrics, and fix issues.	DBA

## Cut over

Task	Description	Skills required
Switch to the target database.	Switch client applications to the new infrastructure.	DBA, App owner, Systems administrator
Provide testing support.	Provide support for functional application testing.	DBA

## Close the project

Task	Description	Skills required
Shut down resources.	Shut down the temporary AWS resources you created for the migration.	DBA, Systems administrator
Validate project documents.	Review and validate the project documents.	DBA, App owner, Systems administrator
Gather metrics.	Gather metrics such as time to migrate, percentage of manual versus automated effort, cost savings, and so on.	DBA, App owner, Systems administrator
Close out the project.	Close out the project and provide feedback.	DBA, App owner, Systems administrator
Decommission the source database.	When all migration and cutover tasks are complete,	DBA, Systems administrator

Task	Description	Skills required
	decommission the on-premises database.	

## Related resources

### References

- [Migration strategy for relational databases](#)
- [AWS DMS website](#)
- [AWS DMS documentation](#)
- [Amazon RDS documentation](#)
- [Amazon RDS pricing](#)
- [Amazon VPC and Amazon RDS](#)
- [Amazon RDS Multi-AZ deployments](#)
- [Migrate on-premises MySQL databases to Aurora MySQL using Percona XtraBackup, Amazon EFS, and Amazon S3](#)
- [Amazon RDS DB instance storage](#)

### Tutorials

- [Getting Started with AWS DMS](#)
- [Getting Started with Amazon RDS](#)



# Migrate an on-premises Microsoft SQL Server database to Amazon RDS for SQL Server

Created by Henrique Lobao (AWS), Jonathan Pereira Cruz (AWS), and Vishal Singh (AWS)

<b>Environment:</b> PoC or pilot	<b>Source:</b> Microsoft SQL Server	<b>Target:</b> Amazon RDS for SQL Server
<b>R Type:</b> Replatform	<b>Workload:</b> Microsoft	<b>Technologies:</b> Migration; Databases

**AWS services:** Amazon RDS

## Summary

This pattern provides guidance for migrating from an on-premises Microsoft SQL Server database to Amazon Relational Database Service (Amazon RDS) for SQL Server. It describes two options for migration: using AWS Data Migration Service (AWS DMS) or using native Microsoft SQL Server tools such as Copy Database Wizard.

## Prerequisites and limitations

### Prerequisites

- An active AWS account
- A source Microsoft SQL Server database in an on-premises data center

### Limitations

- Database size limit: 16 TB

### Product versions

- SQL Server 2014-2019, Enterprise, Standard, Workgroup, and Developer editions. For the latest list of supported versions and features, see [Microsoft SQL Server on Amazon RDS](#) in the AWS documentation. If you're using AWS DMS, see also [Using a Microsoft SQL Server Database as a Target for AWS DMS](#) for SQL Server versions supported by AWS DMS.

## Architecture

### Source technology stack

- An on-premises Microsoft SQL Server database

### Target technology stack

- An Amazon RDS for SQL Server DB instance

### Source and target architecture

*Using AWS DMS:*

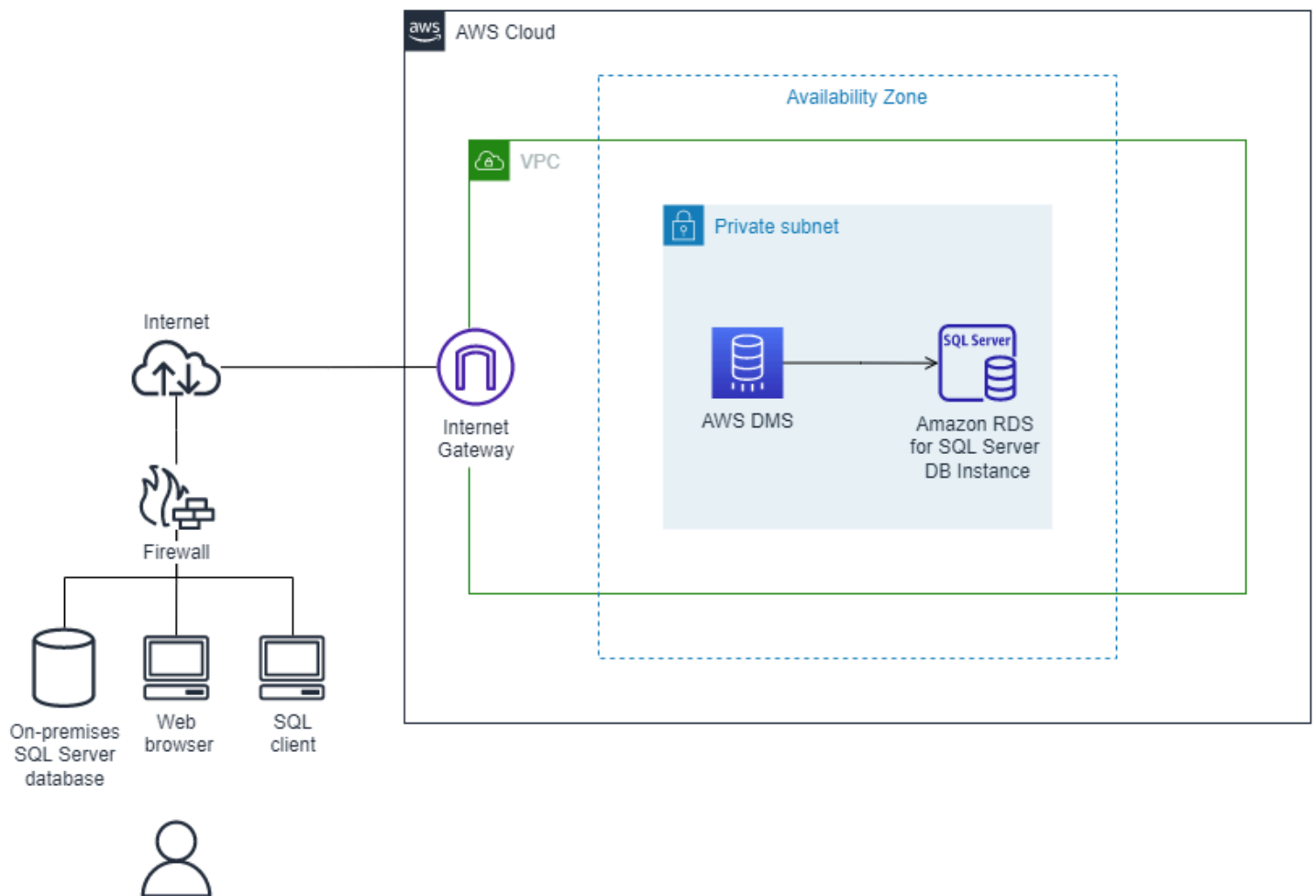

*Using native SQL Server tools:*

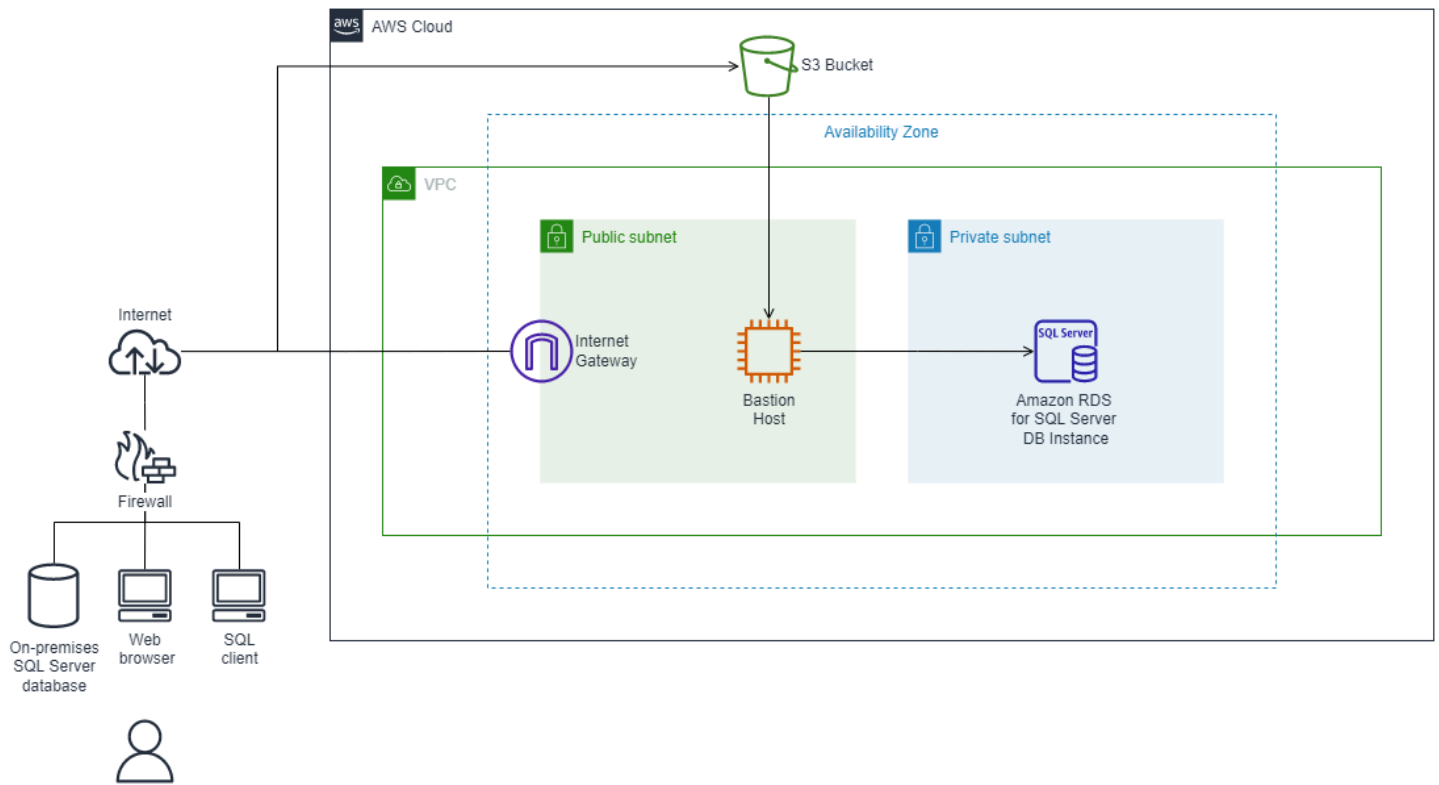

## Tools

- [AWS DMS](#) supports several types of source and target databases. For details, see [AWS DMS Step-by-Step Walkthroughs](#). If AWS DMS doesn't support the source database, select another method for migrating the data.
- Native Microsoft SQL Server tools include backup and restore, Copy Database Wizard, copy and attach database.

## Epics

### Plan the migration

Task	Description	Skills required
Validate the source and target database version and engine.		DBA

Task	Description	Skills required
Identify the hardware requirements for the target server instance.		DBA, Systems administrator
Identify the storage requirements (storage type and capacity).		DBA, Systems administrator
Choose the proper instance type based on capacity, storage features, and network features.		DBA, Systems administrator
Identify the network access security requirements for source and target databases.		DBA, Systems administrator
Identify the application migration strategy.		DBA, Systems administrator

## Configure the infrastructure

Task	Description	Skills required
Create a virtual private cloud (VPC).		Systems administrator
Create security groups.		Systems administrator
Configure and start an Amazon RDS DB instance.		DBA, Systems administrator

## Migrate data - option 1

Task	Description	Skills required
Use native SQL Server tools or third-party tools to migrate database objects and data.		DBA

## Migrate data - option 2

Task	Description	Skills required
Migrate data with AWS DMS.		DBA

## Migrate the application

Task	Description	Skills required
Follow the application migration strategy.		DBA, App owner, Systems administrator

## Cut over

Task	Description	Skills required
Switch the application clients over to the new infrastructure.		DBA, App owner, Systems administrator

## Close the project

Task	Description	Skills required
Shut down the temporary AWS resources.		DBA, Systems administrator
Review and validate the project documents.		DBA, App owner, Systems administrator
Gather metrics such as time to migrate, percentage of manual versus automated tasks, and cost savings.		DBA, App owner, Systems administrator
Close out the project and provide feedback.		DBA, App owner, Systems administrator

## Related resources

### References

- [Deploying Microsoft SQL Server on Amazon Web Services](#)
- [AWS DMS website](#)
- [Amazon RDS Pricing](#)
- [Microsoft Products on AWS](#)
- [Microsoft Licensing on AWS](#)
- [Microsoft SQL Server on AWS](#)
- [Using Windows Authentication with a Microsoft SQL Server DB Instance](#)
- [Amazon RDS Multi-AZ Deployments](#)

### Tutorials and videos

- [Getting Started with AWS DMS](#)
- [Getting Started with Amazon RDS](#)
- [AWS DMS \(video\)](#)

- [Amazon RDS \(video\)](#)

# Migrate data from Microsoft Azure Blob to Amazon S3 by using Rclone

Created by Suhas Basavaraj (AWS), Aidan Keane (AWS), and Corey Lane (AWS)

<b>Environment:</b> PoC or pilot	<b>Source:</b> Microsoft Azure storage container	<b>Target:</b> Amazon S3 bucket
<b>R Type:</b> Replatform	<b>Workload:</b> Microsoft	<b>Technologies:</b> Migration; Storage & backup
<b>AWS services:</b> Amazon S3		

## Summary

This pattern describes how to use [Rclone](#) to migrate data from Microsoft Azure Blob object storage to an Amazon Simple Storage Service (Amazon S3) bucket. You can use this pattern to perform a one-time migration or an ongoing synchronization of the data. Rclone is a command-line program written in Go and is used to move data across various storage technologies from cloud providers.

## Prerequisites and limitations

### Prerequisites

- An active AWS account
- Data stored in Azure Blob container service

## Architecture

### Source technology stack

- Azure Blob storage container

### Target technology stack

- Amazon S3 bucket
- Amazon Elastic Compute Cloud (Amazon EC2) Linux instance



## Architecture

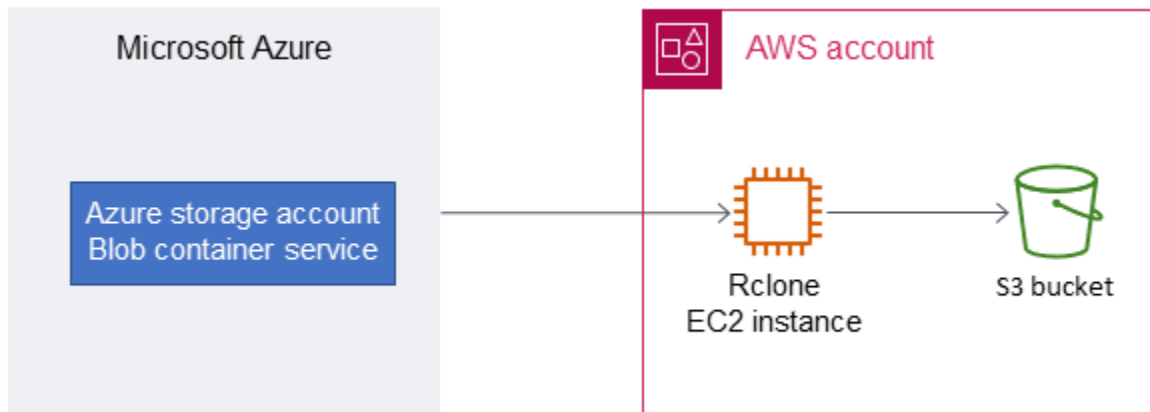

## Tools

- [Amazon Simple Storage Service \(Amazon S3\)](#) is a cloud-based object storage service that helps you store, protect, and retrieve any amount of data.
- [Rclone](#) is an open-source command-line program inspired by **rsync**. It is used to manage files across many cloud storage platforms.

## Best practices

When you migrate data from Azure to Amazon S3, be mindful of these considerations to avoid unnecessary costs or slow transfer speeds:

- Create your AWS infrastructure in the same geographical Region as the Azure storage account and Blob container—for example, AWS Region us-east-1 (N. Virginia) and Azure region East US.
- Avoid using NAT Gateway if possible, because it accrues data transfer fees for both ingress and egress bandwidth.
- Use a [VPC gateway endpoint for Amazon S3](#) to increase performance.
- Consider using an AWS Graviton2 (ARM) processor-based EC2 instance for lower cost and higher performance over Intel x86 instances. Rclone is heavily cross-compiled and provides a precompiled ARM binary.

## Epics

### Prepare AWS and Azure cloud resources

Task	Description	Skills required
Prepare a destination S3 bucket.	<a href="#">Create a new S3 bucket</a> in the appropriate AWS Region or choose an existing bucket as the destination for the data you want to migrate.	AWS administrator
Create an IAM instance role for Amazon EC2.	<a href="#">Create a new AWS Identity and Access Management (IAM) role for Amazon EC2.</a> This role gives your EC2 instance write access to the destination S3 bucket.	AWS administrator
Attach a policy to the IAM instance role.	Use the IAM console or AWS Command Line Interface (AWS CLI) to create an inline policy for the EC2 instance role that allows write access permissions to the destination S3 bucket. For an example policy, see the <a href="#">Additional information</a> section.	AWS administrator
Launch an EC2 instance.	Launch an Amazon Linux EC2 instance that is configured to use the newly created IAM service role. This instance will also need access to Azure public API endpoints through the internet.	AWS administrator

Task	Description	Skills required
	<p><b>Note:</b> Consider using <a href="#">AWS Graviton-based EC2 instances</a> to lower costs. Rclone provides ARM-compiled binaries.</p>	
Create an Azure AD service principal.	Use the Azure CLI to create an Azure Active Directory (Azure AD) service principal that has read-only access to the source Azure Blob storage container . For instructions, see the <a href="#">Additional information</a> section. Store these credentials on your EC2 instance to the location <code>~/azure-principal.json</code> .	Cloud administrator, Azure

## Install and configure Rclone

Task	Description	Skills required
Download and install Rclone.	Download and install the Rclone command-line program. For installation instructions, see the <a href="#">Rclone installation documentation</a> .	General AWS, Cloud administrator
Configure Rclone.	Copy the following <code>rclone.conf</code> sample file. Replace <code>AZStorageAccount</code> with your Azure Storage account name and <code>us-east-1</code> with the AWS Region where your S3 bucket	General AWS, Cloud administrator

Task	Description	Skills required
	<p>is located. Save this file to the location <code>~/.config/rclone/rclone.conf</code> on your EC2 instance.</p> <pre data-bbox="597 428 1026 982">[AZStorageAccount] type = azureblob account = AZStorageAccount service_principal_file = azure-principal.json  [s3] type = s3 provider = AWS env_auth = true region = us-east-1</pre>	

Task	Description	Skills required
Verify Rclone configuration.	<p>To confirm that Rclone is configured and permissions are working properly, verify that Rclone can parse your configuration file and that objects inside your Azure Blob container and S3 bucket are accessible. See the following for example validation commands.</p> <ul style="list-style-type: none"><li>• List the configured remotes in the configuration file. This will ensure that your configuration file is being parsed correctly. Review the output to make sure that it matches your <code>rclone.conf</code> file.</li></ul> <pre data-bbox="625 1142 1029 1302">rclone listremotes AZStorageAccount: s3:</pre> <ul style="list-style-type: none"><li>• List the Azure Blob containers in the configured account. Replace <code>AZStorageAccount</code> with the storage account name that you used in the <code>rclone.conf</code> file.</li></ul> <pre data-bbox="625 1675 1029 1877">rclone lsd AZStorage Account: 2020-04-29 08:29:26 docs</pre>	General AWS, Cloud administrator

Task	Description	Skills required
	<ul style="list-style-type: none"><li data-bbox="592 214 1024 485">• List the files in the Azure Blob container. Replace docs in this command with an actual Blob container name in your Azure storage account.</li></ul> <pre data-bbox="625 520 1024 720">rclone ls AZStorage Account:docs 824884 administr ator-en.a4.pdf</pre> <ul style="list-style-type: none"><li data-bbox="592 737 959 814">• List the buckets in your AWS account.</li></ul> <pre data-bbox="625 856 1024 1331">[root@ip-10-0-20-157 ~]# rclone lsd s3: 2022-03-07 01:44:40     examplebu cket-01 2022-03-07 01:45:16     examplebu cket-02 2022-03-07 02:12:07     examplebu cket-03</pre> <ul style="list-style-type: none"><li data-bbox="592 1348 935 1425">• List the files in the S3 bucket.</li></ul> <pre data-bbox="625 1467 1024 1707">[root@ip-10-0-20-1 57 ~]# rclone ls s3:examplebucket-01 template0.yaml template1.yaml</pre>	

## Migrate data using Rclone

Task	Description	Skills required
<p>Migrate data from your containers.</p>	<p>Run the Rclone <a href="#">copy</a> or <a href="#">sync</a> command.</p> <p><b>Example: copy</b></p> <p>This command copies data from the source Azure Blob container to the destination S3 bucket.</p> <pre data-bbox="594 751 1027 953">rclone copy AZStorage Account:blob-container s3:examplebucket-01</pre> <p><b>Example: sync</b></p> <p>This command synchronizes data between the source Azure Blob container and the destination S3 bucket.</p> <pre data-bbox="594 1283 1027 1484">rclone sync AZStorage Account:blob-container s3:examplebucket-01</pre> <p><b>Important:</b> When you use the <b>sync</b> command, data that isn't present in the source container will be deleted from the destination S3 bucket.</p>	<p>General AWS, Cloud administrator</p>
<p>Synchronize your containers.</p>	<p>After the initial copy is complete, run the Rclone</p>	<p>General AWS, Cloud administrator</p>

Task	Description	Skills required
	<b>sync</b> command for ongoing migration so that only new files that are missing from the destination S3 bucket will be copied.	
Verify that data has been migrated successfully.	To check that data was successfully copied to the destination S3 bucket, run the Rclone <a href="#">lsd</a> and <a href="#">ls</a> commands.	General AWS, Cloud administrator

## Related resources

- [Amazon S3 User Guide](#) (AWS documentation)
- [IAM roles for Amazon EC2](#) (AWS documentation)
- [Creating a Microsoft Azure Blob container](#) (Microsoft Azure documentation)
- [Rclone commands](#) (Rclone documentation)

## Additional information

### Example role policy for EC2 instances

This policy gives your EC2 instance read and write access to a specific bucket in your account. If your bucket uses a customer managed key for server-side encryption, the policy might need additional access to AWS Key Management Service (AWS KMS) .

```
{
  "Version": "2012-10-17",
  "Statement": [
    {
      "Effect": "Allow",
      "Action": [
        "s3:ListBucket",
        "s3:DeleteObject",
        "s3:GetObject",
        "s3:PutObject",
```



```

        "s3:PutObjectAcl"
    ],
    "Resource": [
        "arn:aws:s3:::BUCKET_NAME/*",
        "arn:aws:s3:::BUCKET_NAME"
    ]
},
{
    "Effect": "Allow",
    "Action": "s3:ListAllMyBuckets",
    "Resource": "arn:aws:s3:::*"
}
]
}

```

## Creating a read-only Azure AD service principal

An Azure service principal is a security identity that is used by customer applications, services, and automation tools to access specific Azure resources. Think of it as a user identity (login and password or certificate) with a specific role and tightly controlled permissions to access your resources. To create a read-only service principal to follow least privilege permissions and protect data in Azure from accidental deletions, follow these steps:

1. Log in to your Microsoft Azure cloud account portal and launch Cloud Shell in PowerShell or use the Azure Command-Line Interface (CLI) on your workstation.
2. Create a service principal and configure it with [read-only](#) access to your Azure Blob storage account. Save the JSON output of this command to a local file called `azure-principal.json`. The file will be uploaded to your EC2 instance. Replace the placeholder variables that are shown in braces (`{` and `}`) with your Azure subscription ID, resource group name, and storage account name.

```

az ad sp create-for-rbac `
--name AWS-Rclone-Reader `
--role "Storage Blob Data Reader" `
--scopes /subscriptions/{Subscription ID}/resourceGroups/{Resource Group Name}/
providers/Microsoft.Storage/storageAccounts/{Storage Account Name}

```

# Migrate from Couchbase Server to Couchbase Capella on AWS

Created by Battulga Purevragchaa (AWS), Mark Gamble, and Saurabh Shanbhag (AWS)

<b>Environment:</b> Production	<b>Source:</b> Couchbase Server	<b>Target:</b> Couchbase Capella
<b>R Type:</b> Replatform	<b>Workload:</b> All other workloads	<b>Technologies:</b> Migration; Analytics; Databases

## Summary

Couchbase Capella is a fully managed, NoSQL database as a service (DBaaS) for mission-critical applications (for example, user profiles or online catalogs and inventory management). Couchbase Capella manages your DBaaS workload in a Couchbase-managed Amazon Web Services (AWS) account. Capella makes it easy to run and manage multiple-cluster, multiple-AWS Region, multicloud, and hybrid-cloud replication within a single interface.

Couchbase Capella helps you instantly scale your Couchbase Server applications, helping you create multi-node clusters in minutes. Couchbase Capella supports all Couchbase Server features, including [SQL++](#), [Full Text Search](#), [Eventing Service](#), and [Analytics Service](#). It also removes the need to manage installations, upgrades, backups, and general database maintenance.

This pattern describes the steps and best practices for migrating a self-managed [Couchbase Server](#) environment to the AWS Cloud. The pattern provides a repeatable process for migrating data and indexes from Couchbase Server clusters, running either on premises or in the cloud, to Couchbase Capella. Using these steps helps you avoid issues during your migration and speeds up your overall migration process.

This pattern provides the following two migration options:

- **Option 1** is appropriate if you have fewer than 50 indexes to migrate.
- **Option 2** is appropriate if you have more than 50 indexes to migrate.

You can also [set up sample data](#) on your self-managed Couchbase Server to follow along with the migration guide.

If you choose migration **option 2**, or if you are using scopes or collections other than the default value, you must use the example configuration file, which is in the *Additional information* section.

## Prerequisites and limitations

### Prerequisites

- An existing Couchbase Capella paid account. You can also create a [Couchbase Capella account on AWS](#) and use the Couchbase Capella free trial, and then upgrade to a paid account to configure your cluster for the migration.. To start with the trial version, follow the instructions in [Getting Started with Couchbase Capella](#).
- An existing self-managed Couchbase Server environment either on premises or deployed on a cloud service provider.
- For migration option 2, Couchbase Shell and a configuration file. To create the configuration file, you can use the example file that's in the *Additional information* section.
- Familiarity with administering Couchbase Server and Couchbase Capella.
- Familiarity with opening TCP ports and running commands in a command line interface (CLI).

The migration process also requires the roles and expertise described in the following table.

Role	Expertise	Responsibilities
Couchbase administrator	<ul style="list-style-type: none"> <li>• Familiarity with Couchbase Server and Couchbase Capella</li> <li>• Basic command line knowledge is helpful but not required</li> </ul>	<ul style="list-style-type: none"> <li>• Couchbase Server and Capella–specific tasks</li> </ul>
Systems administrator, IT administrator	<ul style="list-style-type: none"> <li>• Familiarity with the self-managed Couchbase Server system environment and administration</li> </ul>	<ul style="list-style-type: none"> <li>• Opening ports and determining IP addresses on self-managed Couchbase Server cluster nodes</li> </ul>

### Limitations

- This pattern is used to migrate data, indexes, and [Couchbase Full Text Search](#) indexes from Couchbase Server to Couchbase Capella on AWS. The pattern doesn't apply to migrating [Couchbase Eventing Service](#), or to [Couchbase Analytics](#).
- Couchbase Capella is available in multiple AWS Regions. For up-to-date information on the Regions that Capella supports, see [Amazon Web Services](#) in the Couchbase documentation.

## Product versions

- [Couchbase Server \(Community or Enterprise\) Edition version 5.x or later](#)

## Architecture

### Source technology stack

- Couchbase Server

### Target technology stack

- Couchbase Capella

### Target architecture

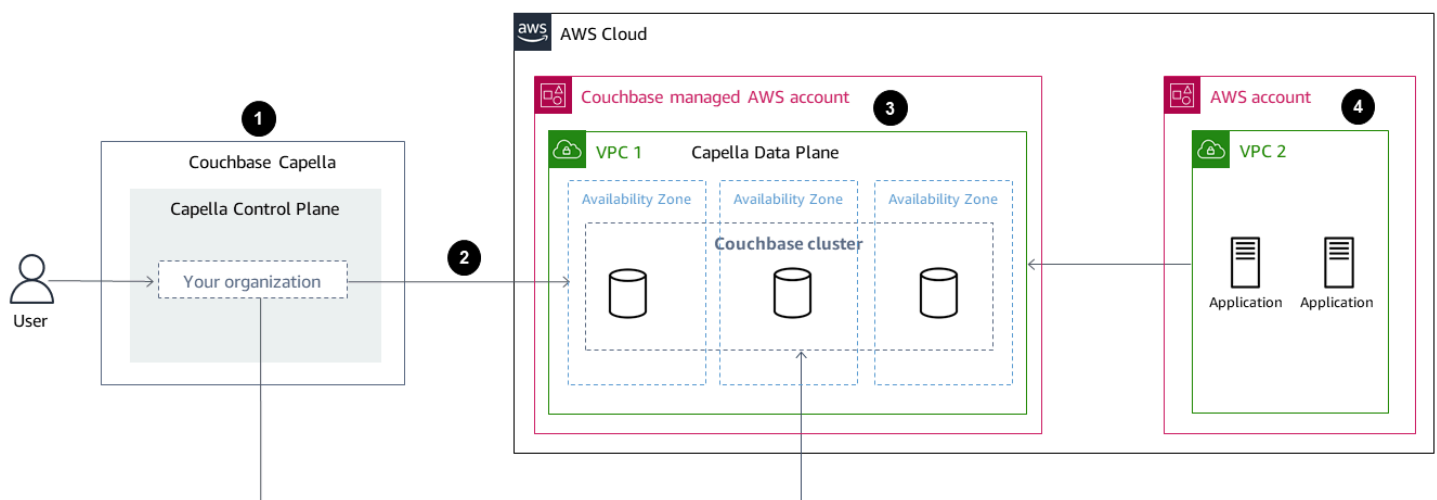

1. You access Couchbase Capella by using the **Capella Control Plane**. You can use the Capella Control Plane to do the following:
  - Control and monitor your account.

- Manage clusters and data, indexes, users and groups, access permissions, monitoring, and events.
2. Clusters are created.
  3. The **Capella Data Plane** is in the Couchbase-managed AWS account. After you create a new cluster, Couchbase Capella deploys it across multiple Availability Zones in the selected AWS Region.
  4. You can develop and deploy Couchbase applications in a VPC in your AWS account. Typically, this VPC accesses the Capella Data Plane through [VPC peering](#).

## Tools

- [Couchbase Cross Data Center Replication \(XDCR\)](#) helps replicate data across clusters that are located in different cloud providers and different data centers. It is used to migrate data into Couchbase Capella from self-managed Couchbase Server clusters.

**Note:** XDCR cannot be used with Couchbase Server Community Edition to migrate to Couchbase Capella. Instead, you can use [cbexport](#). For more information, see the *Migrate data from Community Edition* epic.

- [Couchbase Shell](#) is a command line shell for Couchbase Server and Couchbase Capella to access local and remote Couchbase clusters. In this pattern, Couchbase Shell is used to migrate indexes.
- [cbexport](#) is a Couchbase utility for exporting data from Couchbase cluster. Included in [Couchbase Server CLI tools](#).

## Epics

### Prepare the migration

Task	Description	Skills required
Evaluate the size of the self-managed Couchbase Server cluster.	Log in to the <a href="#">Couchbase Web Console</a> for Couchbase Server, and assess your self-managed cluster's nodes and buckets.	Couchbase administrator

Task	Description	Skills required
	<ol style="list-style-type: none"><li data-bbox="592 212 1015 338">1. To show a list of cluster nodes, choose the <b>Servers</b> tab in the navigation bar.</li><li data-bbox="592 365 974 541">2. Record the number of nodes, and then choose each node on the list to display its properties.</li><li data-bbox="592 569 1015 695">3. Record the memory and storage for each individual node.</li><li data-bbox="592 722 1031 1037">4. Choose the <b>Buckets</b> tab in the navigation bar, and then choose each bucket in the list to display its properties. Record the RAM quota and conflict resolution setting for each bucket.</li></ol> <p data-bbox="592 1115 1015 1388">You will use your self-managed Couchbase Server cluster configurations as a general guide for sizing and configuring the target cluster on Couchbase Capella.</p> <p data-bbox="592 1436 1015 1562">For help with a more detailed Couchbase Capella sizing exercise, <a href="#">contact Couchbase</a>.</p>	

Task	Description	Skills required
Record Couchbase Service distribution on the self-managed Couchbase Server cluster.	<ol style="list-style-type: none"> <li>1. On the Couchbase Web Console, choose the <b>Servers</b> tab to display the list of cluster nodes.</li> <li>2. Choose each node to display its properties and then record the Couchbase Service distribution for each node (<a href="#">Data Service</a>, <a href="#">Query Service</a>, <a href="#">Index Service</a>, <a href="#">Search Service</a>, <a href="#">Analytics Service</a>, and <a href="#">Eventing Service</a>).</li> </ol>	Couchbase administrator
Record the IP addresses of the self-managed Couchbase Server cluster nodes.	<p>(Ignore this step if you are using Community Edition.)</p> <p>Record the IP address for each node in your cluster. They will be added to the allow list on your Couchbase Capella cluster later.</p>	Couchbase administrator, Systems administrator

## Deploy and configure resources on Couchbase Capella

Task	Description	Skills required
Choose a template.	<ol style="list-style-type: none"> <li>1. Log in to your Couchbase Capella Control Plane, choose the <b>Dashboard</b> tab or the <b>Clusters</b> tab in the main navigation, and then choose <b>Create Cluster</b>.</li> <li>2. Using the information that you recorded from</li> </ol>	Couchbase administrator

Task	Description	Skills required
	<p>the evaluation of your self-managed Couchbase Server cluster, choose the cluster template that meets the configuration's requirements. If you don't find an appropriate template, choose <b>Custom Template</b> in the <b>Cluster Sizing</b> editor.</p>	
Choose and configure the nodes.	<p>Choose and configure the nodes to match your self-managed Couchbase Server cluster environment, including the number of nodes, services distribution, compute or RAM, and storage.</p> <p>Couchbase Capella uses <a href="#">multidimensional scaling</a> best practices. Services and nodes can be chosen only according to deployment best practices. This might mean that you can't exactly match your self-managed Couchbase Server cluster's configurations.</p>	Couchbase administrator



Task	Description	Skills required
Deploy the cluster.	<p>Choose a support zone and support package, and then deploy the cluster. For detailed steps and instructions, see <a href="#">Create a cluster</a> in the Couchbase documentation.</p> <p><b>Important:</b> If you are using the Couchbase Capella free trial, you must convert it to a paid account before beginning your migration. To convert your account, open the <b>Billing</b> section of the Couchbase Capella Control Plane, and then choose <b>Add Activation ID</b>. The Activation ID is sent to your billing contact email address after you complete a purchase agreement with Couchbase Sales, or after you make a purchase through <a href="#">AWS Marketplace</a>.</p>	Couchbase administrator

Task	Description	Skills required
Create a database credential user.	<p>A database credential user is specific to a cluster and consists of a user name, password, and a set of bucket privileges. This user is required for creating buckets and accessing bucket data.</p> <p>In the Couchbase Capella Control Plane, create a database credential for the new cluster by following the instructions in <a href="#">Configure database credentials</a> in the Couchbase Capella documentation.</p> <p><b>Note:</b> An organization user needs organizational role credentials assigned to them if they want to access bucket data on a particular cluster, either remotely or through the Couchbase Capella UI. This is separate from database credentials, which are typically used by apps and integrations. Creating the organizational user allows you to create and manage the target buckets on your Couchbase Capella cluster.</p>	Couchbase administrator

Task	Description	Skills required
<p>If using migration option 2, install Couchbase Shell.</p>	<p>You can install Couchbase Shell on any system that has network access to both your self-managed Couchbase Server and the Couchbase Capella clusters. For more information, see <a href="#">Install Couchbase Shell version 1.0.0-beta.5</a> in the Couchbase Shell documentation.</p> <p>Confirm that Couchbase Shell is installed by <a href="#">testing a connection to your self-managed cluster</a> in a command line terminal.</p>	<p>Couchbase administrator, Systems administrator</p>

Task	Description	Skills required
Allow IP addresses.	<ol style="list-style-type: none"><li data-bbox="592 226 1008 405">1. In the Couchbase Capella Control Plane, choose <b>Clusters</b>, and then choose your target cluster.</li><li data-bbox="592 426 1003 699">2. Choose the <b>Connect</b> tab for the cluster, and record the connection endpoint for your cluster that is listed under <b>Manage Allowed IP</b>.</li><li data-bbox="592 720 1024 1789">3. To add the IP address for the system where you installed Couchbase Shell and the IP address of your self-managed Couchbase Server cluster instances as allowed IP addresses, do the following:<ol style="list-style-type: none"><li data-bbox="630 1119 963 1245">a. Under <b>Wide Area Network</b>, choose <b>Manage Allowed IP</b>.</li><li data-bbox="630 1266 1019 1539">b. Choose <b>Add Allowed IP</b>, enter the IP address for the system where you installed Couchbase Shell, and then choose <b>Add IP</b>.</li><li data-bbox="630 1560 1024 1789">c. Repeat the previous step to add the IP address of your self-managed Couchbase Server cluster instance.</li></ol></li></ol>	Couchbase administrator, Systems administrator

Task	Description	Skills required
	For more information about allowed IP addresses , see <a href="#">Configure allowed IP addresses</a> in the Couchbase documentation.	

Task	Description	Skills required
Configure certificates.	<ol style="list-style-type: none"><li data-bbox="592 226 1015 405">1. To download the root certificate for your cluster, under <b>Root Certificate</b>, choose <b>Download</b>.</li><li data-bbox="592 426 974 653">2. Save the root certificate using the .pem file extension in a folder on the system that will run Couchbase Shell.</li><li data-bbox="592 674 1015 993">3. Next, log in to your self-managed Couchbase Server Web Console, choose <b>Security</b> in the left navigation bar, and then choose the <b>Certificates</b> tab.</li><li data-bbox="592 1014 1015 1623">4. Copy the root certificate for your self-managed Couchbase Server cluster and save it as a .pem file to the same folder where you saved the root certificate file for your Couchbase Capella cluster. For more information about the root certificate, see <a href="#">Root certificate in the Couchbase Server documentation</a>.</li></ol>	Couchbase administrator, Systems administrator

Task	Description	Skills required
Create the configuration file for Couchbase Shell.	<p>Create a configuration dotfile in the Couchbase Shell installation's home directory (for example, <code>/&lt;HOME_DIRECTORY&gt;/ .cbsh/ configuration</code> ). For more information, see <a href="#">Config dotfiles</a> in the Couchbase documentation.</p> <p>Add connection properties for the source and target clusters to the configuration file. You can use the example configuration file that's in the <i>Additional information</i> section and edit the settings for your clusters.</p> <p>Save the configuration file with the updated settings to the <code>.cbsh</code> folder (for example, <code>/&lt;HOME_DIRECTORY&gt;/ .cbsh/ configuration</code> ).</p>	Couchbase administrator, Systems administrator

Task	Description	Skills required
Create target buckets.	<p>For each source bucket, create one target bucket in your Couchbase Capella cluster by following the instructions in <a href="#">Create a bucket</a> in the Couchbase documentation.</p> <p>Your target bucket configurations must match the bucket names, memory settings, and conflict resolution settings of the buckets in your self-managed Couchbase Server cluster.</p>	Couchbase administrator



Task	Description	Skills required
Create scopes and collections.	<p>Every bucket contains a default scope and collection with the keyspaces <code>_default._default</code> . If you are using any other keyspaces for your scope and collection, you must create identical keyspaces in the target Capella cluster.</p> <ol style="list-style-type: none"><li>1. Open the command line terminal on the system where you installed Couchbase Shell.</li><li>2. To start Couchbase Shell, run the following command. <pre>./cbsh</pre></li><li>3. For each bucket that you want to migrate, create scopes and collections in the Capella cluster by running the following commands. Make sure that you replace <code>&lt;BUCKET_NAME&gt;</code> with the name of the bucket that you want to migrate. <pre>scopes --clusters "On-Prem-Cluster" --bucket &lt;BUCKET_NAME&gt;   select scope   where scope !</pre></li></ol>	Couchbase administrator

Task	Description	Skills required
	<pre data-bbox="609 212 1011 940">= "_default"   each {  it  scopes create \$it.scope --clusters "Capella-Cluster" } collections --clusters "On-Prem-Cluster" --bucket &lt;BUCKET_NAME&gt;   select scope collection   where \$it.scope != "_default"   where \$it.collection != "_default"   each {  it  collections create \$it.collection --clusters "Capella-Cluster" -- bucket &lt;BUCKET_NAME&gt; -- scope \$it.scope }</pre>	

## Migrate the data from Enterprise Edition

Task	Description	Skills required
<p>Open TCP ports on the self-managed Couchbase Server cluster nodes.</p>	<p>Make sure that the appropriate ports are open for XDCR communication on the self-managed Couchbase Server cluster's nodes. For more information, see the <a href="#">Couchbase Server ports documentation</a>.</p>	<p>Couchbase administrator, Systems administrator</p>
<p>If you are using Couchbase Server Enterprise Edition, set up Couchbase XDCR.</p>	<ol style="list-style-type: none"> <li>In the Couchbase Capella Control Plane main navigation, choose <b>Clusters</b>, and then choose</li> </ol>	<p>Couchbase administrator</p>

Task	Description	Skills required
	<p>the target cluster for migration.</p> <ol style="list-style-type: none"><li data-bbox="591 310 1027 401">2. Under <b>Root Certificate</b>, choose <b>Copy</b>.</li><li data-bbox="591 422 1027 646">3. Log in to your self-managed Couchbase Server Web Console, and in the main navigation, choose <b>XDCR</b>. Then choose <b>Add Remote</b>.</li><li data-bbox="591 667 1027 1766">4. Enter the following settings:<ul style="list-style-type: none"><li data-bbox="630 772 1027 905">• <b>Cluster Name</b> – A name for the Capella cluster connection</li><li data-bbox="630 926 1027 1108">• <b>IP/Hostname</b> – The connection endpoint for your Couchbase Capella cluster</li><li data-bbox="630 1129 1027 1312">• <b>Username for Remote Cluster</b> – The database user for your Couchbase Capella cluster</li><li data-bbox="630 1333 1027 1516">• <b>Password</b> – The database user password for your Couchbase Capella cluster</li><li data-bbox="630 1537 1027 1614">• <b>Enable Secure Connection</b> – Selected</li><li data-bbox="630 1635 1027 1766">• <b>Full (TLS encrypt password and data)</b> – Selected</li></ul></li><li data-bbox="591 1787 1027 1875">5. Paste the Capella cluster root certificate you copied</li></ol>	

Task	Description	Skills required
	earlier, and then choose <b>Save</b> .	
Start Couchbase XDCR.	<ol style="list-style-type: none"> <li>In your self-managed Couchbase Server Web Console, choose <b>XDCR</b> in the main navigation, and then choose <b>Add Replication</b>.</li> <li>Enter the following settings: <ul style="list-style-type: none"> <li><b>Replicate From Bucket</b> – Select the source bucket for migration.</li> <li><b>Remote Bucket</b> – Enter the target bucket name.</li> <li><b>Remote Cluster</b> – Select the target cluster you created earlier.</li> </ul> </li> <li>Choose <b>Save Replication</b>. The replication process should begin within a few seconds.</li> </ol>	Couchbase administrator

### Migrate the indexes by using option 1

Task	Description	Skills required
Migrate self-managed cluster indexes to Couchbase Capella.	<b>Important:</b> We recommend this process if you have fewer than 50 indexes to migrate. If you have more than 50 indexes to migrate,	Couchbase administrator, Systems administrator

Task	Description	Skills required
	<p>we recommend that you use migration option 2.</p> <ol style="list-style-type: none"><li>1. On the Couchbase Web Console, choose <b>Indexes</b>.</li><li>2. In the list of indexes, choose the first index that you want to migrate. The index definition is then displayed.</li><li>3. Copy the index definition by using the CREATE statement, but don't copy WITH { "defer_build":true } .</li></ol> <p>For example, from the following example index definition, you would copy only CREATE INDEX `cityindex` ON `travel-sample`(`city`) .</p> <pre>CREATE INDEX `cityindex` ON `travel-sample`(`city`) WITH { "defer_build":true }</pre> <ol style="list-style-type: none"><li>4. In the Couchbase Capella Control Plane, choose <b>Clusters</b>, and then choose the target cluster.</li><li>5. On the Tools dropdown list, choose <b>Query</b></li></ol>	

Task	Description	Skills required
	<p><b>Workbench.</b> Paste the CREATE statement that you copied earlier into the <b>Query Editor</b>, and then choose <b>Execute</b>. This creates and builds the index.</p> <p>6. To confirm that the index is created, choose <b>Indexes</b> from the <b>Tools</b> dropdown list. The list shows that the index was created and built.</p> <p>7. Repeat this process for each index that must be migrated.</p>	

## Migrate the indexes by using option 2

Task	Description	Skills required
Migrate the index definitions.	<p><b>Important:</b> We recommend this process if you have more than 50 indexes to migrate. If you have fewer than 50 indexes to migrate, we recommend that you use migration option 1.</p> <p>1. Open the command line terminal on the system where you installed Couchbase Shell.</p>	Couchbase administrator, Systems administrator

Task	Description	Skills required
	<p>2. To start Couchbase Shell, run the following command.</p> <pre>./cbsh</pre> <p>3. To connect to the self-managed Couchbase Server cluster, run the following command.</p> <pre>cb-env cluster On-Prem-Cluster</pre> <p>4. To migrate index definitions from the self-managed Couchbase Server cluster to the Couchbase Capella cluster, run the following command for each bucket that you want to migrate. Make sure that you replace &lt;BUCKET_NAME&gt; with the bucket name that corresponds to the indexes that you want to migrate. This migration option requires that your target bucket names are identical to the source bucket names.</p> <pre>query indexes -- definitions   where   bucket =~ &lt;BUCKET_NAME&gt;  get definition   each {  it </pre>	

Task	Description	Skills required
	<pre>query \$it --clusters Capella-Cluster }</pre>	



Task	Description	Skills required
Build the index definitions.	<ol style="list-style-type: none"><li data-bbox="591 226 1024 405">1. To switch context to the Couchbase Capella cluster, run the following command: <pre data-bbox="634 443 1029 562">cb-env cluster Capella-Cluster</pre></li><li data-bbox="591 575 1024 1041">2. To build the index definitions that were migrated to the Couchbase Capella cluster, run the following command, replacing &lt;BUCKET_NAME&gt; with the bucket name that corresponds to the indexes that you want to build. <pre data-bbox="634 1079 1029 1841">query 'SELECT RAW CONCAT("BUILD INDEX ON ", k , "(['", CONCAT2 ("','", inames), "']);") FROM system:indexes AS s LET bid = CONCAT("`", s.bucket_id, "`"), sid = CONCAT("`", s.scope_id, "`"), kid = CONCAT("`", s.keyspace_id, "`"), k = NVL2(bid, CONCAT2(".", bid, sid, kid), kid) WHERE s.namespa ce_id = "default" AND s.bucket_id = "' GROUP BY k LETTING</pre></li></ol>	Couchbase administrator, Systems administrator

Task	Description	Skills required
	<pre data-bbox="634 212 985 485"> inames = ARRAY_AGG (s.name) FILTER (WHERE s.state = 'deferred') HAVING ARRAY_LENGTH(iname s) &gt; 0;'   each {   it  query \$it } </pre> <p data-bbox="591 520 971 554">3. Repeat for each bucket.</p>	

## Migrate full-text search indexes

Task	Description	Skills required
<p data-bbox="112 850 540 978">Migrate self-managed cluster full-text search indexes to Couchbase Capella.</p>	<ol data-bbox="591 850 1013 1770" style="list-style-type: none"> <li data-bbox="591 850 980 932">1. In the Couchbase Web Console, choose <b>Search</b>.</li> <li data-bbox="591 953 1013 1415">2. In the list of full-text search (FTS) indexes, choose the first FTS index that you want to migrate, choose <b>Show index definition JSON</b>, and choose <b>Copy to Clipboard</b>. Make a note of the <b>index name</b> and the <b>bucket</b> it belongs to.</li> <li data-bbox="591 1436 997 1625">3. In the Couchbase Capella Control Plane, choose <b>Clusters</b> and then choose the target cluster.</li> <li data-bbox="591 1646 971 1770">4. On the Tools dropdown list, choose <b>Full Text Search</b>.</li> </ol>	<p data-bbox="1066 850 1433 884">Couchbase administrator</p>

Task	Description	Skills required
	<ol style="list-style-type: none"> <li>5. Choose <b>Import Index</b>, and paste the FTS index definition.</li> <li>6. Enter the <b>Index Name</b>, select the correct <b>Bucket</b>, as noted on the self-managed cluster, and then choose <b>Create</b>.</li> <li>7. Repeat this process for each FTS index that must be migrated.</li> </ol>	

## Migrate data from Couchbase Community Edition

Task	Description	Skills required
Export data from self-managed Couchbase Server Community Edition.	<p>Encrypted XDCR is not available in Couchbase Community Edition. You can export data from Couchbase Community Edition and then manually import the data into Couchbase Capella.</p> <p>To export data from the source bucket, use <code>cbexport</code> at the command line.</p> <p>The following command is provided as an example.</p> <pre data-bbox="592 1696 1029 1871">cbexport json \ --cluster localhost \ --bucket &lt;SOURCE BUCKET NAME&gt; \</pre>	Couchbase administrator

Task	Description	Skills required
	<pre data-bbox="613 212 1010 663">--format lines \ --username &lt;USERNAME&gt; \ --password &lt;PASSWORD&gt; \ --include-key cbkey \ --scope-field cbscope \ --collection-field   cbcoll \ --output cbexporte d_data.json</pre> <p data-bbox="591 701 1029 1024">Note that <code>cbkey</code>, <code>cbscope</code>, <code>cbcoll</code>, and <code>cbexporte d_data.json</code> are arbitrary labels. They will be referenced later in the process, so if you choose to name them differently, make note of it.</p>	

Task	Description	Skills required
Import data into Couchbase Capella.	<ol style="list-style-type: none"><li>1. In the Couchbase Capella Control Plane, choose <b>Clusters</b>, and then choose the target cluster.</li><li>2. In the <b>Tools</b> dropdown list, choose <b>Import</b>. This will open a wizard with the following six steps:<ol style="list-style-type: none"><li>a. <b>Bucket</b> – Choose the target bucket.</li><li>b. <b>File</b> – Choose <b>JSON</b>, choose <b>Lines</b>, and then choose <b>Using your web browser</b>. If you have a large amount of data, you can explore the <b>Manually</b> option. Select the file created by cbexport.</li><li>c. <b>Collections</b> – Choose <b>Custom Collection Mapping</b>.  If your Community Edition database does not use scopes or collections, or it uses only <b>_default</b>, you can choose the <b>Select Single Collection</b> option instead.  For <b>Collection Mapping Expression</b>, enter</li></ol></li></ol>	Couchbase administrator

Task	Description	Skills required
	<p><code>%cbscope%.%cbcoll%</code> . To verify that this expression works correctly, you can paste example data, such as the following.</p> <pre data-bbox="669 520 1029 758">{ "cbscope": "inventory", "cbcoll": "landmark", "cbkey": "landmark_3991" }</pre>	

- d. **Key** – Choose **Customer Generation**. (If you don't care about preserving the keys of the data you're importing, you can select **Automatically Generated UUID** instead and proceed to step 5.) For **Key Name Generator Expression**, enter `%cbkey%`. To verify that this expression works correctly, paste some example data.
- e. **Configurations** – Choose **Ignore fields**, and enter `cbscope,cbcoll,cbkey`. These fields contain transitory information that does not need to be in the target bucket after an import. Leave

Task	Description	Skills required
	<p>the other settings at their defaults.</p> <p>f. <b>Import</b> – Review, and choose <b>Import</b> when you're ready. Wait for the upload and data import.</p> <p>For large files, Couchbase Capella supports command line import using cURL. You can explore Import options in more detail at <a href="#">Import data</a> in the Couchbase Capella documentation.</p>	

## Test and verify the migration

Task	Description	Skills required
Verify data migration.	<ol style="list-style-type: none"> <li>In the Couchbase Capella Control Plane, choose <b>Clusters</b>, and then choose the target cluster in your cluster list.</li> <li>Choose the <b>Buckets</b> tab for your target cluster. Verify that the number of <b>Items</b> (documents) in the target bucket matches the number of items in the source bucket.</li> </ol>	Couchbase administrator

Task	Description	Skills required
	<ol style="list-style-type: none"> <li>3. In the target cluster, in the <b>Tools</b> dropdown list, choose <b>Documents</b>. Verify that all documents were migrated.</li> <li>4. (Optional) After all data is migrated, you can shut down the replication by deleting it. For more information, see <a href="#">Delete a replication</a> in the Couchbase documentation.</li> </ol>	
Verify index migration.	In the Couchbase Capella Control Plane, in the <b>Tools</b> dropdown list for your target cluster, choose <b>Indexes</b> . Verify that the indexes are migrated and built.	Couchbase administrator
Verify query results.	<ol style="list-style-type: none"> <li>1. In the Couchbase Capella Control Plane, in the <b>Tools</b> dropdown list for your target cluster, choose <b>Query Workbench</b>.</li> <li>2. Run a sample N1QL query or a query used in your application. Make sure that you receive the same results as when you run the query in your self-managed Couchbase Server cluster.</li> </ol>	Couchbase administrator



Task	Description	Skills required
Verify full-text search results (applicable if you migrated FTS indexes).	<ol style="list-style-type: none"><li>1. In the Couchbase Capella Control Plane, in the <b>Tools</b> dropdown list for your target cluster, choose <b>Full Text Search</b>.</li><li>2. Select an FTS index by choosing its name.</li><li>3. Choose <b>Search</b>.</li><li>4. Enter a sample search query, and choose <b>Search</b>.</li><li>5. Verify that the results are the same as when you run the search on your self-managed cluster.</li></ol>	Couchbase administrator

## Related resources

### Prepare the migration

- [Get started with the Couchbase Capella free trial](#)
- [Cloud provider requirements for Couchbase Capella](#)
- [Couchbase Capella sizing guidelines](#)

### Migrate the data and indexes

- [Couchbase XDCR](#)
- [Couchbase Shell documentation](#)

### Couchbase Capella SLAs and support

- [Couchbase Capella service-level agreements \(SLAs\)](#)
- [Couchbase Capella Service support policy](#)

## Additional information

The following code is an example [configuration file for Couchbase Shell](#).

```
Version = 1

[[clusters]]
identifier = "On-Prem-Cluster"
hostnames = ["<SELF_MANAGED_COUCHBASE_CLUSTER>"]
default-bucket = "travel-sample"
username = "<SELF_MANAGED_ADMIN>"
password = "<SELF_MANAGED_ADMIN_PWD>"
tls-cert-path = "/<ABSOLUTE_PATH_TO_SELF_MANAGED_ROOT_CERT>"
data-timeout = "2500ms"
connect-timeout = "7500ms"
query-timeout = "75s"

[[clusters]]
identifier = "Capella-Cluster"
hostnames = ["<COUCHBASE_CAPELLA_ENDPOINT>"]
default-bucket = "travel-sample"
username = "<CAPELLA_DATABASE_USER>"
password = "<CAPELLA_DATABASE_USER_PWD>"
tls-cert-path = "/<ABSOLUTE_PATH_TO_COUCHBASE_CAPELLA_ROOT_CERT>"
data-timeout = "2500ms"
connect-timeout = "7500ms"
query-timeout = "75s"
```

Before you save the configuration file, use the following table to make sure that you added your own source and target cluster information.

<SELF_MANAGED_COUCHBASE_CLUSTER>	Use the IP address for your self-managed Couchbase Server cluster.
<SELF_MANAGED_ADMIN>	Use the administrator user for your self-managed Couchbase Server cluster.

---

<ABSOLUTE_PATH_TO_SELF_MANGED_ROOT_CERT>	Use the absolute path to the saved root certificate file for your self-managed Couchbase Server cluster.
<COUCHBASE_CAPELLA_ENDPOINT>	Use the connection endpoint for your Couchbase Capella cluster.
<CAPELLA_DATABASE_USER>	Use the database user for your Couchbase Capella cluster.
<CAPELLA_DATABASE_USER_PWD>	Use the database user password for your Couchbase Capella cluster.
<ABSOLUTE_PATH_TO_COUCHBASE_CAPELLA_ROOT_CERT>	Use the absolute path to the saved root certificate file for your Couchbase Capella cluster.

# Migrate from IBM WebSphere Application Server to Apache Tomcat on Amazon EC2

Created by Neal Ardeljan (AWS) and Afroz Khan (AWS)

<b>Environment:</b> Production	<b>Source:</b> Applications	<b>Target:</b> Apache Tomcat on an Amazon EC2 instance
<b>R Type:</b> Replatform	<b>Workload:</b> IBM; Open-source	<b>Technologies:</b> Migration; Web & mobile apps
<b>AWS services:</b> Amazon EC2		

## Summary

This pattern walks you through the steps for migrating from an on-premises Red Hat Enterprise Linux (RHEL) 6.9 or later system that's running IBM WebSphere Application Server (WAS) to RHEL 8 running Apache Tomcat on an Amazon Elastic Compute Cloud (Amazon EC2) instance.

The pattern can be applied to the following source and target versions:

- WebSphere Application Server 7.x to Apache Tomcat 8 (with Java 7 or later)
- WebSphere Application Server 8.x to Apache Tomcat 8 (with Java 7 or later)
- WebSphere Application Server 8.5.5.x to Apache Tomcat 9 (with Java 8 or later)
- WebSphere Application Server 8.5.5.x to Apache Tomcat 10 (with Java 8 or later)

## Prerequisites and limitations

### Prerequisites

- An active AWS account
- Source Java code, with the following assumptions:
  - Uses the Java Development Kit (JDK) version of Java 7 or later
  - Uses the Spring or Apache Struts framework

- Doesn't use the Enterprise Java Beans (EJB) framework or any other WebSphere server functionality that's not readily available for Tomcat
- Primarily uses servlets or Java Server Pages (JSPs)
- Uses Java Database Connectivity (JDBC) connectors to connect to databases
- Source IBM WebSphere Application Server version 7.x or higher
- Target Apache Tomcat version 8.5 or higher

## Architecture

### Source technology stack

- A web application built using the Apache Struts Model-View-Controller (MVC) framework
- A web application running on IBM WebSphere Application Server version 7.x or 8.x
- A web application that uses a Lightweight Directory Access Protocol (LDAP) connector to connect to an LDAP directory (iPlanet/eTrust)
- An application that uses IBM Tivoli Access Manager (TAM) connectivity to update the TAM user password (in the present implementation, applications use PD.jar)

### On-premises databases

- Oracle Database 21c (21.0.0.0)
- Oracle Database 19c (19.0.0.0)
- Oracle Database 12c Release 2 (12.2.0.1)
- Oracle Database 12c Release 1 (12.1.0.2)

### Target technology stack

- Apache Tomcat version 8 (or later) running on RHEL on an EC2 instance
- Amazon Relational Database Service (Amazon RDS) for Oracle

For more information about the Oracle versions supported by Amazon RDS, see the [Amazon RDS for Oracle](#) website.

### Target architecture

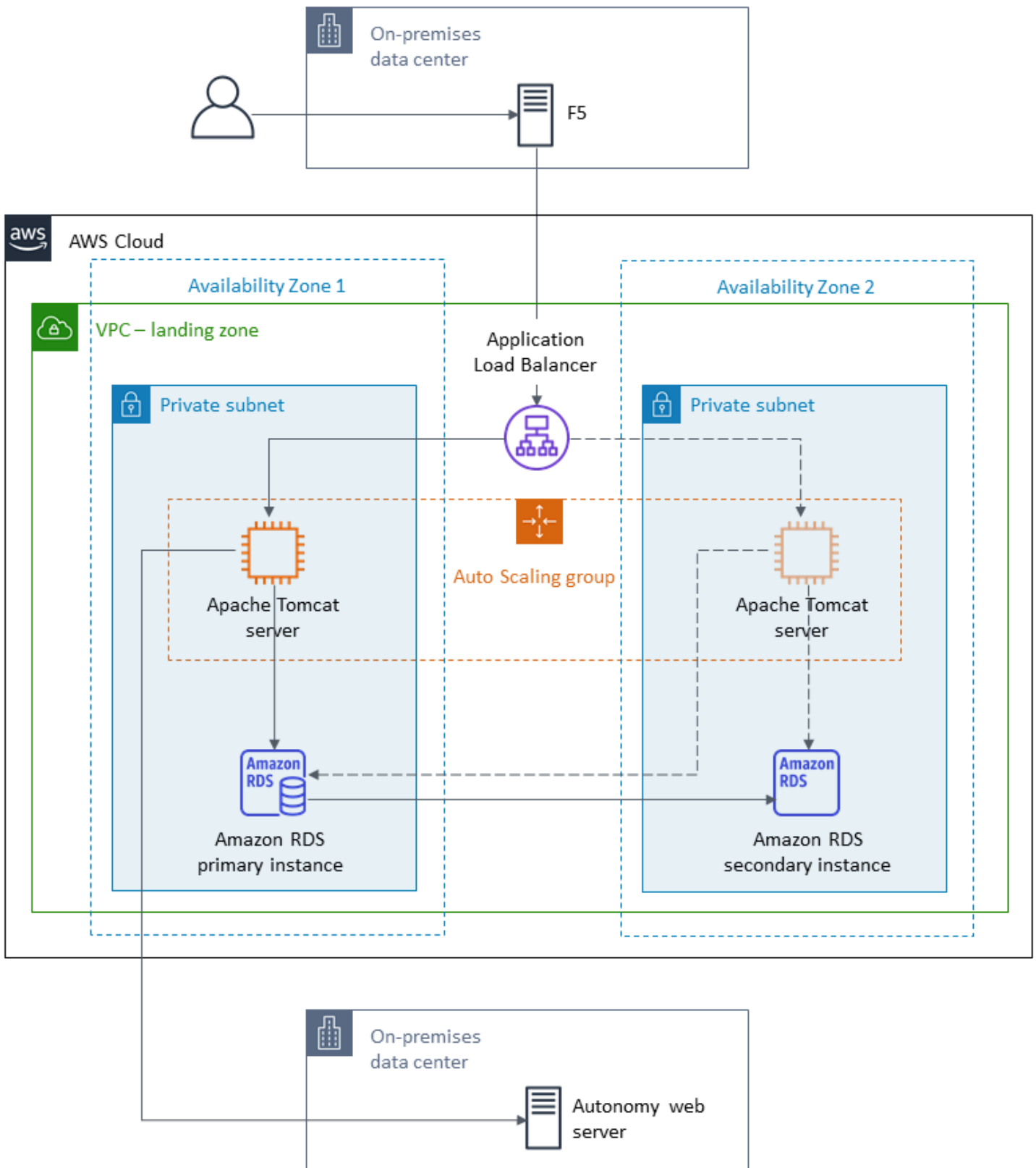

## Tools

- Application tier: Rebuilding Java application into a WAR file.
- Database tier: Oracle native backup and restore.
- Apache Tomcat migration tool for Jakarta EE. This tool takes a web application written for Java EE 8 that runs on Apache Tomcat 9 and converts it automatically to run on Apache Tomcat 10, which implements Jakarta EE 9.

## Epics

### Plan the migration

Task	Description	Skills required
Complete the application discovery, current state footprint, and performance baseline.		BA, Migration Lead
Validate the source and target database versions.		DBA
Identify the hardware requirements for the target server EC2 instance.		DBA, SysAdmin
Identify storage requirements (storage type and capacity).		DBA, SysAdmin
Choose the proper EC2 instance type based on capacity, storage features, and network features.		DBA, SysAdmin
Identify the network access security requirements for the source and target databases.		DBA, SysAdmin

Task	Description	Skills required
Identify the application migration strategy and tooling.		DBA, Migration Lead
Complete the migration design and migration guide for the application.		Build Lead, Migration Lead
Complete the application migration runbook.		Build Lead, Cutover Lead, Testing Lead, Migration Lead

### Configure the infrastructure

Task	Description	Skills required
Create a virtual private cloud (VPC).		SysAdmin
Create the security groups.		SysAdmin
Configure and start Amazon RDS for Oracle.		DBA, SysAdmin

### Migrate data

Task	Description	Skills required
Create or obtain access to the endpoints to fetch the database backup files.		DBA
Use the native database engine or a third-party tool to migrate database objects and data.	For details, see "Migrating database objects and data" in the <i>Additional information</i> section.	DBA



## Migrate the application

Task	Description	Skills required
Lodge the change request (CR) for migration.		Cutover Lead
Obtain the CR approval for migration.		Cutover Lead
Follow the application migration strategy per the application migration runbook.	For details, see "Setting up the application tier" in the <i>Additional information</i> section.	DBA, Migration Engineer, App owner
Upgrade the application (if necessary).		DBA, Migration Engineer, App owner
Complete the functional, non-functional, data validation, SLA, and performance tests.		Testing Lead, App Owner, App Users

## Cut over

Task	Description	Skills required
Obtain signoff from the application owner or business owner.		Cutover Lead
Switch the application clients to the new infrastructure.		DBA, Migration Engineer, App owner

## Close the project

Task	Description	Skills required
Shut down temporary AWS resources.		DBA, Migration Engineer, SysAdmin
Review and validate the project documents.		Migration Lead
Gather metrics such as time to migrate, percentage of manual versus automated tasks, and cost savings.		Migration Lead
Close out the project and provide feedback.		Migration Lead, App Owner

## Related resources

### References

- [Apache Tomcat 10.0 documentation](#)
- [Apache Tomcat 9.0 documentation](#)
- [Apache Tomcat 8.0 documentation](#)
- [Apache Tomcat 8.0 installation guide](#)
- [Apache Tomcat JNDI documentation](#)
- [Amazon RDS for Oracle website](#)
- [Amazon RDS pricing](#)
- [Oracle and Amazon Web Services](#)
- [Oracle on Amazon RDS](#)
- [Amazon RDS Multi-AZ Deployments](#)

### Tutorials and videos

- [Getting Started with Amazon RDS](#)

## Additional information

### Migrating database objects and data

For example, if you're using native Oracle backup/restore utilities:

1. Create the Amazon Simple Storage Service (Amazon S3) backup for database backup files (optional).
2. Back up the Oracle DB data to the network shared folder.
3. Log in to the migration staging server to map the network share folder.
4. Copy data from the network share folder to the S3 bucket.
5. Request an Amazon RDS Multi-AZ deployment for Oracle.
6. Restore the on-premises database backup to Amazon RDS for Oracle.

### Setting up the application tier

1. Install Tomcat 8 (or 9/10) from the Apache Tomcat website.
2. Package the application and shared libraries into a WAR file.
3. Deploy the WAR file in Tomcat.
4. Monitor the start log to Linux `cat` any missing shared libraries from WebSphere.
5. Watch the start record to Linux `cat` any WebSphere-specific deployment descriptor extensions.
6. Collect any missing dependent Java libraries from the WebSphere server.
7. Amend WebSphere-specific deployment descriptor elements with Tomcat-compatible equivalents.
8. Rebuild the WAR file with the dependent Java libraries and updated deployment descriptors.
9. Update the LDAP configuration, database configuration, and test connections (see [Realm Configuration HOW-TO](#) and [JNDI Datasource HOW-TO](#) in the Apache Tomcat documentation).
10. Test the installed application against the restored Amazon RDS for Oracle database.
11. Create an Amazon Machine Image (AMI) for Linux from the EC2 instance.
12. Launch the completed architecture with the Application Load Balancer and Auto Scaling group.
13. Update the URLs (by using the WebSEAL junction) to point to the Application Load Balancer.
14. Update the configuration management database (CMDB).



# Migrate from IBM WebSphere Application Server to Apache Tomcat on Amazon EC2 with Auto Scaling

Created by Kevin Yung (AWS) and Afroz Khan (AWS)

<b>R Type:</b> Replatform	<b>Source:</b> Applications	<b>Target:</b> Apache Tomcat on an Amazon EC2 instance with Auto Scaling enabled
<b>Created by:</b> AWS	<b>Environment:</b> PoC or pilot	<b>Technologies:</b> Web & mobile apps; Migration
<b>Workload:</b> Open-source; IBM	<b>AWS services:</b> Amazon EC2	

## Summary

This pattern provides guidance for migrating a Java application from IBM WebSphere Application Server to Apache Tomcat on an Amazon Elastic Compute Cloud (Amazon EC2) instance with Amazon EC2 Auto Scaling enabled.

By using this pattern, you can achieve:

- A reduction in IBM licensing costs
- High availability using Multi-AZ deployment
- Improved application resiliency with Amazon EC2 Auto Scaling

## Prerequisites and limitations

### Prerequisites

- Java applications (version 7.x or 8.x) should be developed in LAMP stacks.
- The target state is to host Java applications on Linux hosts. This pattern has been successfully implemented in a Red Hat Enterprise Linux (RHEL) 7 environment. Other Linux distributions can follow this pattern, but the configuration of the Apache Tomcat distribution should be referenced.

- You should understand the Java application's dependencies.
- You must have access to the Java application source code to make changes.

## Limitations and replatforming changes

- You should understand the enterprise archive (EAR) components and verify that all libraries are packaged in the web component WAR files. You need to configure the [Apache Maven WAR Plugin](#) and produce WAR file artifacts.
- When using Apache Tomcat 8, there is a known conflict between `javax.servlet-api.jar` and the application package built-in jar files. To resolve this issue, delete `javax.servlet-api.jar` from the application package.
- You must configure WEB-INF/resources located in the *classpath* of the [Apache Tomcat configuration](#). By default, the JAR libraries are not loaded in the directory. Alternatively, you can deploy all the resources under `src/main/resources`.
- Check for any hard-coded context roots within the Java application, and update the new [context root of Apache Tomcat](#).
- To set JVM runtime options, you can create the configuration file `setenv.sh` in the Apache Tomcat bin folder; for example, `JAVA_OPTS`, `JAVA_HOME`, etc.
- Authentication is configured at the container level and is set up as a realm in Apache Tomcat configurations. Authentication is established for any of the following three realms:
  - [JDBC Database Realm](#) looks up users in a relational database accessed by the JDBC driver.
  - [DataSource Database Realm](#) looks up users in a database that is accessed by JNDI.
  - [JNDI Directory Realm](#) looks up users in the Lightweight Directory Access Protocol (LDAP) directory that is accessed by the JNDI provider. The look-ups require:
    - LDAP connection details: user search base, search filter, role base, role filter
    - The key JNDI Directory Realm: Connects to LDAP, authenticates users, and retrieves all groups in which a user is a member
- Authorization: In the case of a container with a role-based authorization that checks the authorization constraints in `web.xml`, web resources must be defined and compared to the roles defined in the constraints. If LDAP doesn't have group-role mapping, you must set the attribute `<security-role-ref>` in `web.xml` to achieve group-role mapping. To see an example of a configuration document, see the [Oracle documentation](#).
- Database connection: Create a resource definition in Apache Tomcat with an Amazon Relational Database Service (Amazon RDS) endpoint URL and connection details. Update the application

code to reference a DataSource by using JNDI lookup. An existing DB connection defined in WebSphere would not work, as it uses WebSphere's JNDI names. You can add a <resource-ref> entry in web.xml with the JNDI name and DataSource type definition. To see a sample configuration document, see the [Apache Tomcat documentation](#).

- Logging: By default, Apache Tomcat logs to the console or to a log file. You can enable realm-level tracing by updating *logging.properties* (see [Logging in Tomcat](#)). If you are using Apache Log4j to append logs to a file, you must download tomcat-juli and add it to the *classpath*.
- Session management: If you are retaining IBM WebSEAL for application load balancing and session management, no change is required. If you are using an Application Load Balancer or Network Load Balancer on AWS to replace the IBM WebSEAL component, you must set up session management by using an Amazon ElastiCache instance with a Memcached cluster and set up Apache Tomcat to use [open-source session management](#).
- If you are using the IBM WebSEAL forward proxy, you must set up a new Network Load Balancer on AWS. Use the IPs provided by the Network Load Balancer for WebSEAL junction configurations.
- SSL configuration: We recommend that you use Secure Sockets Layer (SSL) for end-to-end communications. To set up an SSL server configuration in Apache Tomcat, follow the instructions in the [Apache Tomcat documentation](#).

## Architecture

### Source technology stack

- IBM WebSphere Application Server

### Target technology stack

- The architecture uses [Elastic Load Balancing \(version 2\)](#). If you are using IBM WebSEAL for Identify management and load balancing, you can select a Network Load Balancer on AWS to integrate with the IBM WebSEAL reverse proxy.
- Java applications are deployed to an Apache Tomcat application server, which runs on an EC2 instance in an [Amazon EC2 Auto Scaling group](#). You can set up a [scaling policy](#) based on Amazon CloudWatch metrics such as CPU utilization.
- If you're retiring the use of IBM WebSEAL for load balancing, you can use [Amazon ElastiCache for Memcached](#) for session management.

- For the back-end database, you can deploy [High Availability \(Multi-AZ\) for Amazon RDS](#) and select a database engine type.

## Target architecture

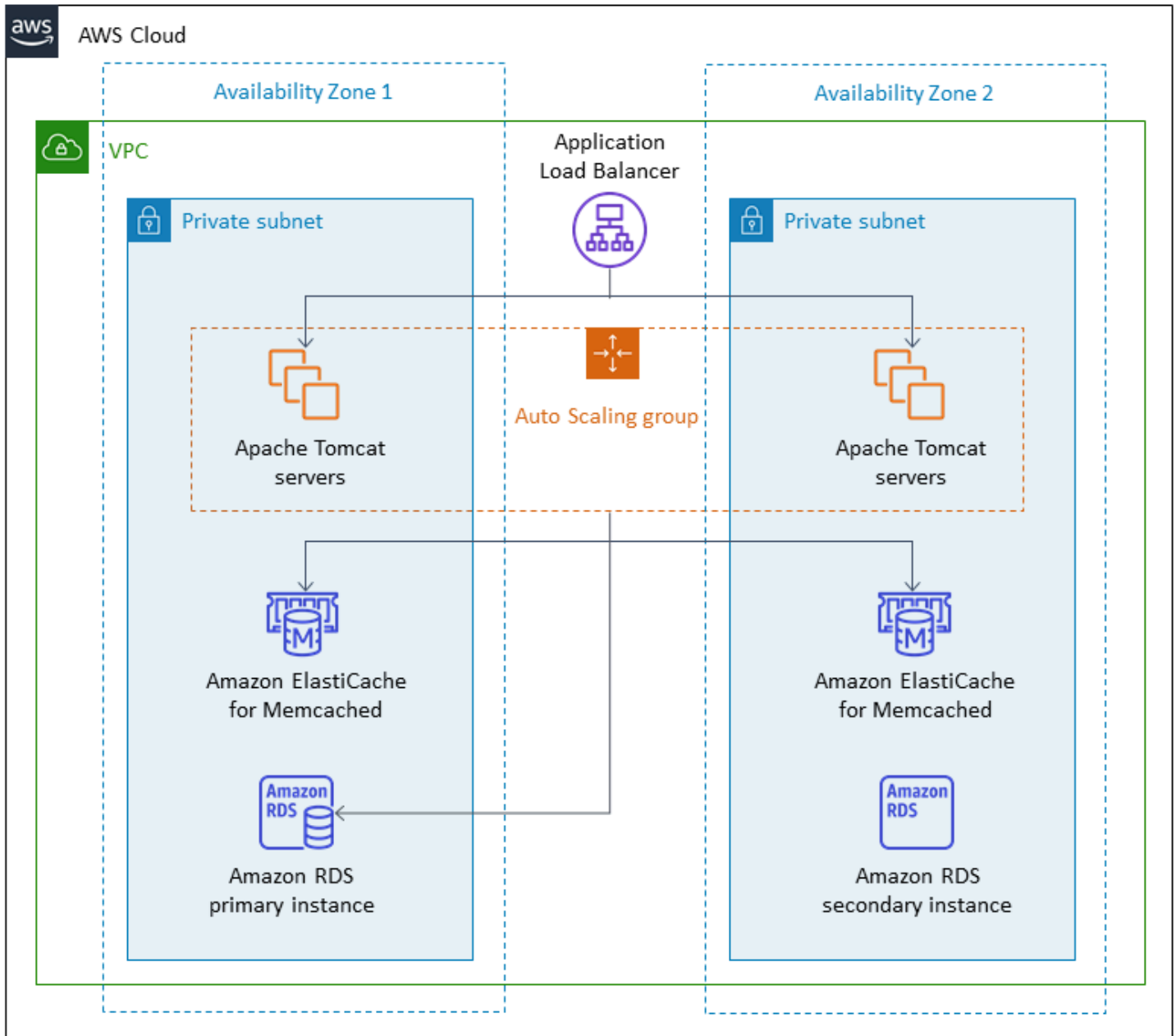

## Tools

- [AWS CloudFormation](#)



- [AWS Command Line Interface \(AWS CLI\)](#)
- Apache Tomcat (version 7.x or 8.x)
- RHEL 7 or Centos 7
- [Amazon RDS Multi-AZ deployment](#)
- [Amazon ElastiCache for Memcached](#) (optional)

## Epics

### Set up the VPC

Task	Description	Skills required
Create a virtual private cloud (VPC).		
Create subnets.		
Create routing tables if necessary.		
Create network access control lists (ACLs).		
Set up AWS Direct Connect or a corporate VPN connection.		

### Replatform the application

Task	Description	Skills required
Refactor the application build Maven configuration to generate the WAR artifacts.		

Task	Description	Skills required
Refactor the application dependency data sources in Apache Tomcat.		
Refactor the application source codes to use JNDI names in Apache Tomcat.		
Deploy the WAR artifacts into Apache Tomcat.		
Complete application validations and tests.		

## Configure the network

Task	Description	Skills required
Configure the corporate firewall to allow the connection to dependency services.		
Configure the corporate firewall to allow end-user access to Elastic Load Balancing on AWS.		

## Create the application infrastructure

Task	Description	Skills required
Create and deploy the application on an EC2 instance.		
Create an Amazon ElastiCache for Memcached cluster for session management.		
Create an Amazon RDS Multi-AZ instance for the backend database.		
Create SSL certificates and import them into AWS Certificate Manager (ACM).		
Install SSL certificates on load balancers.		
Install SSL certificates for Apache Tomcat servers.		
Complete application validations and tests.		

## Cut over

Task	Description	Skills required
Shut down the existing infrastructure.		
Restore the database from production to Amazon RDS.		

Task	Description	Skills required
Cut over the application by making DNS changes.		

## Related resources

### References

- [Apache Tomcat 7.0 documentation](#)
- [Apache Tomcat 7.0 installation guide](#)
- [Apache Tomcat JNDI documentation](#)
- [Amazon RDS Multi-AZ Deployments](#)
- [Amazon ElastiCache for Memcached](#)

### Tutorials and videos

- [Getting Started with Amazon RDS](#)

# Migrate a .NET application from Microsoft Azure App Service to AWS Elastic Beanstalk

*Created by Raghavender Madamshitti (AWS)*

<b>Environment:</b> PoC or pilot	<b>Source:</b> Applications	<b>Target:</b> AWS Elastic Beanstalk
<b>R Type:</b> Replatform	<b>Workload:</b> Microsoft	<b>Technologies:</b> Migration; Web & mobile apps

## Summary

This pattern describes how to migrate a .NET web application hosted on Microsoft Azure App Service to AWS Elastic Beanstalk. There are two ways to migrate applications to Elastic Beanstalk:

- **Use AWS Toolkit for Visual Studio** - This plugin for the Microsoft Visual Studio IDE provides the easiest and most straightforward way to deploy custom .NET applications to AWS. You can use this approach to deploy .NET code directly to AWS and to create supporting resources, such as Amazon Relational Database Service (Amazon RDS) for SQL Server databases, directly from Visual Studio.
- **Upload and deploy to Elastic Beanstalk** - Each Azure App Service includes a background service called Kudu, which is useful for capturing memory dumps and deployment logs, viewing configuration parameters, and accessing deployment packages. You can use the Kudu console to access Azure App Service content, extract the deployment package, and then upload the package to Elastic Beanstalk by using the upload and deploy option in the Elastic Beanstalk console.

This pattern describes the second approach (uploading your application to Elastic Beanstalk through Kudu). The pattern also uses the following AWS services: AWS Elastic Beanstalk, Amazon Virtual Private Cloud (Amazon VPC), Amazon CloudWatch, Amazon Elastic Compute Cloud (Amazon EC2) Auto Scaling, Amazon Simple Storage Service (Amazon S3), and Amazon Route 53.

The .NET web application is deployed to AWS Elastic Beanstalk, which runs in an Amazon EC2 Auto Scaling Group. You can set up a scaling policy based on Amazon CloudWatch metrics such as CPU utilization. For a database, you can use Amazon RDS in a Multi-AZ environment, or Amazon DynamoDB, depending on your application and business requirements.

## Prerequisites and limitations

### Prerequisites

- An active AWS account
- A .NET web application running in Azure App Service
- Permission to use the Azure App Service Kudu console

### Product versions

- .NET Core (x64) 1.0.1, 2.0.0, or later, or .NET Framework 4.x, 3.5 (see [.NET on Windows Server platform history](#))
- Internet Information Services (IIS) version 8.0 or later, running on Windows Server 2012 or later
- .NET 2.0 or 4.0 Runtime.

## Architecture

### Source technology stack

- Application developed using .NET Framework 3.5 or later, or .NET Core 1.0.1, 2.0.0, or later, and hosted on Azure App Service (web app or API app)

### Target technology stack

- AWS Elastic Beanstalk running in an Amazon EC2 Auto Scaling group

### Migration architecture

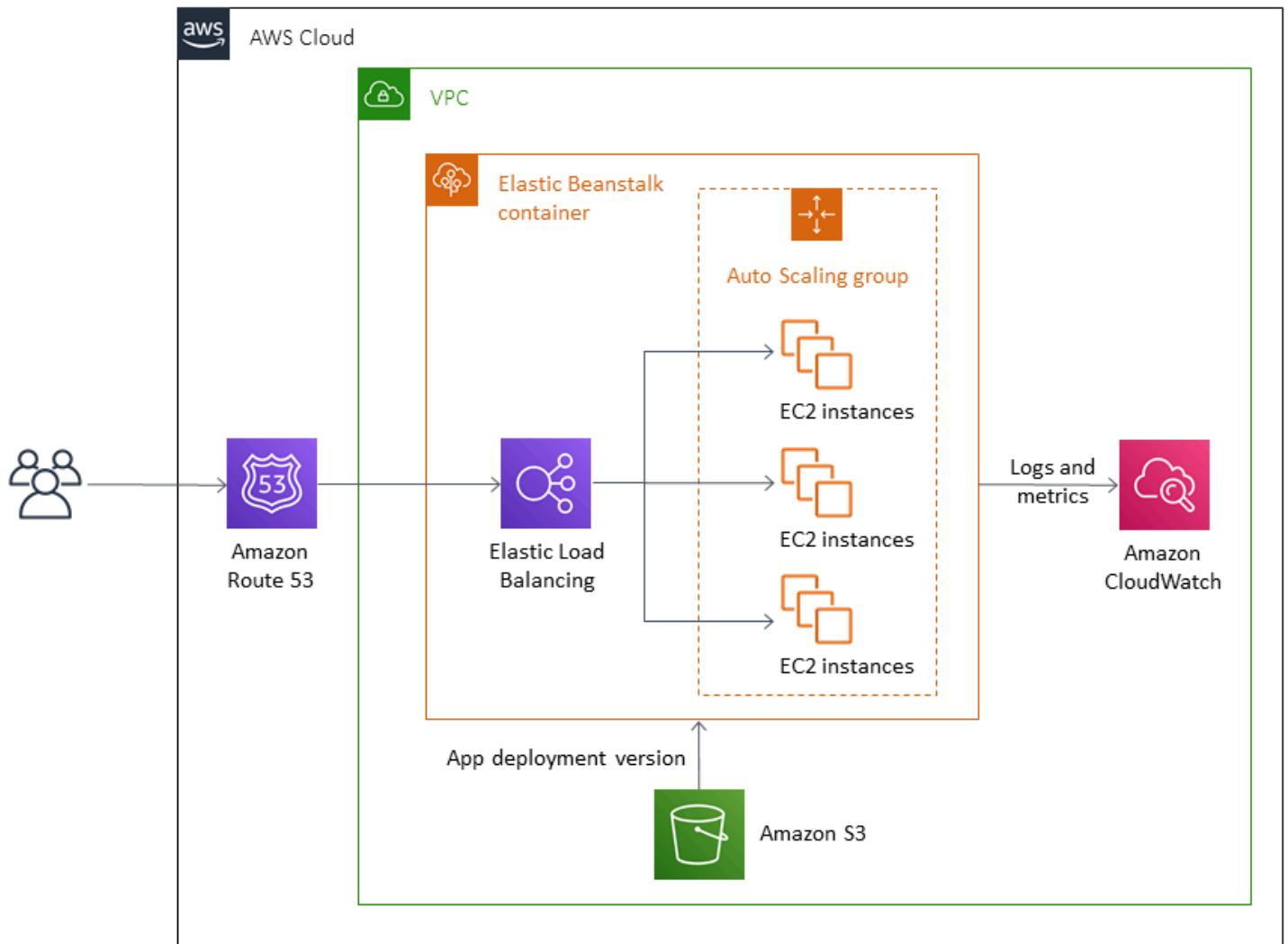

## Deployment workflow

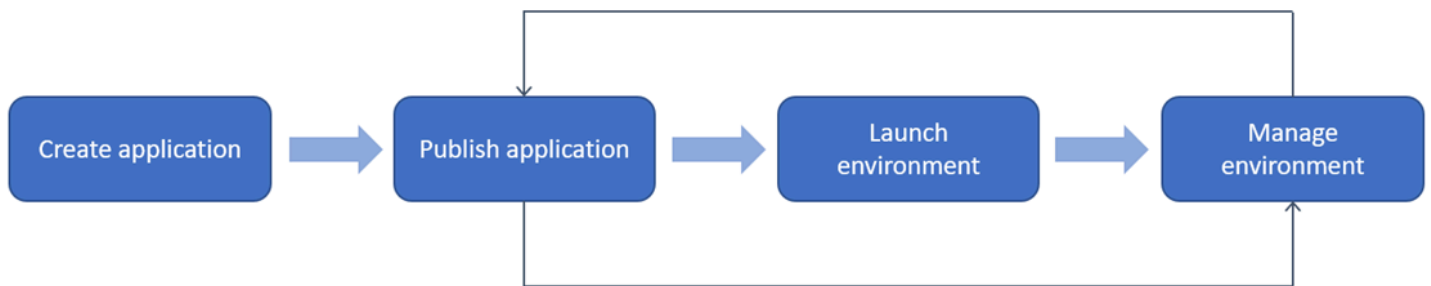

## Tools

### Tools

- .NET Core or .NET Framework

- C#
- IIS
- Kudu console

## AWS services and features

- [AWS Elastic Beanstalk](#) – Elastic Beanstalk is an easy-to-use service for deploying and scaling .NET web applications. Elastic Beanstalk automatically manages capacity provisioning, load balancing, and auto scaling.
- [Amazon EC2 Auto Scaling group](#) – Elastic Beanstalk includes an Auto Scaling group that manages the Amazon EC2 instances in the environment. In a single-instance environment, the Auto Scaling group ensures that there is always one instance running. In a load-balanced environment, you can configure the group with a range of instances to run, and Amazon EC2 Auto Scaling adds or removes instances as needed, based on load.
- [Elastic Load Balancing](#) – When you enable load balancing in AWS Elastic Beanstalk, it creates a load balancer that distributes traffic among the EC2 instances in the environment.
- [Amazon CloudWatch](#) – Elastic Beanstalk automatically uses Amazon CloudWatch to provide information about your application and environment resources. Amazon CloudWatch supports standard metrics, custom metrics, and alarms.
- [Amazon Route 53](#) – Amazon Route 53 is a highly available and scalable cloud Domain Name System (DNS) web service. You can use Route 53 alias records to map custom domain names to AWS Elastic Beanstalk environments.

## Epics

### Set up a VPC

Task	Description	Skills required
Set up a virtual private cloud (VPC).	In your AWS account, create a VPC with the required information.	System administrator
Create subnets.	Create two or more subnets in your VPC.	System administrator



Task	Description	Skills required
Create a route table.	Create a route table, based on your requirements.	System administrator

## Set up Elastic Beanstalk

Task	Description	Skills required
Access the Azure App Service Kudu console.	Access Kudu through the Azure portal by navigating to the App Service dashboard, and then choosing <b>Advanced Tools, Go</b> . Or, you can modify the Azure App Service URL as follows: <code>https://&lt;appservicename&gt;.sc m.azurewebsites.net</code> .	App developer, System administrator
Download the deployment package from Kudu.	Navigate to Windows PowerShell by choosing the <b>DebugConsole</b> option. This will open the Kudo console. Go to the <code>wwwroot</code> folder and download it. This will download the Azure App Service deployment package as a zip file. For an example, see the attachment.	App developer, System administrator
Create a package for Elastic Beanstalk.	Unzip the deployment package that you downloaded from Azure App Service. Create a JSON file called <code>aws-windows-deployment-manifest.json</code>	App developer, System administrator

Task	Description	Skills required
	<p>(this file is required only for .NET Core applications). Create a zip file that includes <code>aws-windows-deployment-manifest.json</code> and the Azure App Service deployment package file. For an example, see the attachment.</p>	
Create a new Elastic Beanstalk application.	Open the Elastic Beanstalk console. Choose an existing application or create a new application.	App developer, System administrator
Create the environment.	<p>In the Elastic Beanstalk console <b>Actions</b> menu, choose <b>Create environment</b>. Select the web server environment and .NET/IIS platform. For application code, choose <b>Upload</b>. Upload the zip file that you prepared for Elastic Beanstalk, and then choose <b>Create Environment</b>.</p>	App developer, System administrator
Configure Amazon CloudWatch.	By default, basic CloudWatch monitoring is enabled. If you want to change the configuration, in the Elastic Beanstalk wizard, choose the published application, and then choose <b>Monitoring</b> .	System administrator

Task	Description	Skills required
Verify that the deployment package is in Amazon S3.	When the application environment has been created, you can find the deployment package in the S3 bucket.	App developer, System administrator
Test the application.	When the environment has been created, use the URL provided in the Elastic Beanstalk console to test the application.	System administrator

## Related resources

- [AWS Elastic Beanstalk concepts](#) (Elastic Beanstalk documentation)
- [Getting Started with .NET on Elastic Beanstalk](#) (Elastic Beanstalk documentation)
- [Kudu console](#) (GitHub)
- [Using “Kudu” to Manage Azure Web Apps](#) (GS Lab article)
- [Custom ASP.NET Core Elastic Beanstalk Deployments](#) (AWS Toolkit for Visual Studio user guide)
- [Elastic Load Balancing documentation](#)
- [AWS Elastic Beanstalk Supported Platforms](#) (Elastic Beanstalk documentation)
- [Deploy a Web Application to AWS](#) (C# Corner article)
- [Scaling the Size of Your Auto Scaling Group](#) (Amazon EC2 documentation)
- [High Availability \(Multi-AZ\) for Amazon RDS](#) (Amazon RDS documentation)

## Additional information

### Notes

- If you are migrating an on-premises or Azure SQL Server database to Amazon RDS, you must update the database connection details as well.
- For testing purposes, a sample demo application is attached.

## Attachments

To access additional content that is associated with this document, unzip the following file:  
[attachment.zip](#)

# Migrate a self-hosted MongoDB environment to MongoDB Atlas on the AWS Cloud

Created by Suresh Veeragoni (AWS)

<b>Source:</b> MongoDB	<b>Target:</b> MongoDB Atlas on AWS	<b>R Type:</b> Replatform
<b>Environment:</b> Production	<b>Technologies:</b> Migration; Analytics; Databases	<b>Workload:</b> All other workloads
<b>AWS services:</b> Amazon EC2; Amazon VPC		

## Summary

This pattern describes the steps for migrating from a self-managed MongoDB environment (including MongoDB Community Server, Enterprise Server, Enterprise Advanced, mLab, or any managed MongoDB cluster) to MongoDB Atlas on the Amazon Web Services (AWS) Cloud. It uses the [Atlas Live Migration Service](#) to help accelerate the data migration from MongoDB to MongoDB Atlas.

The pattern accompanies the guide [Migrating from MongoDB to MongoDB Atlas on the AWS Cloud](#) on the AWS Prescriptive Guidance website. It provides the implementation steps for the migration.

The pattern is intended for AWS Service Integrator Partners (SI Partners) and AWS users.

## Prerequisites and limitations

### Prerequisites

- A source MongoDB environment to migrate to MongoDB Atlas

### Expertise

- This pattern requires familiarity with MongoDB, MongoDB Atlas, and AWS services. For more information, see [Roles and responsibilities](#) in the guide *Migrating from MongoDB to MongoDB Atlas on the AWS Cloud* on the AWS Prescriptive Guidance website.

## Product versions

- MongoDB version 2.6 or later

## Architecture

For MongoDB Atlas reference architectures that support different usage scenarios, see [MongoDB Atlas reference architectures on AWS](#) in the guide *Migrating from MongoDB to MongoDB Atlas on the AWS Cloud* on the AWS Prescriptive Guidance website.

## Tools

- [Atlas Live Migration Service](#) – A free MongoDB utility that helps migrate databases to Atlas. This service keeps the source database in sync with the destination database until cutover. When you're ready to cut over, you stop your application instances, point them to the destination Atlas cluster, and restart them.

## Epics

### Discovery and assessment

Task	Description	Skills required
Determine the cluster size.	Estimate the working set size by using the information from <code>db.stats()</code> for the total index space. Assume that a percentage of your data space will be accessed frequently. Or, you can estimate your memory requirements based on your own assumptions. This task should take approximately one week. For more information and examples for this and the other stories in this epic,	MongoDB DBA, Application architect

Task	Description	Skills required
	see the links in the “Related resources” section.	
Estimate network bandwidth requirements.	To estimate your network bandwidth requirements, multiply the average document size by the number of documents served per second. Consider the maximum traffic that any node on your cluster will bear as the basis. To calculate downstream data transfer rates from your cluster to client applications, use the sum of the total documents returned over a period of time. If your applications read from secondary nodes, divide this number of total documents by the number of nodes that can serve read operations. To find the average document size for a database, use the <code>db.stats().avgObjSize</code> command. This task will typically take one day.	MongoDB DBA
Select the Atlas tier.	Follow the instructions in the MongoDB documentation to select the correct Atlas cluster tier.	MongoDB DBA

Task	Description	Skills required
Plan for application cutover.		MongoDB DBA, Application architect

## Set up a new MongoDB Atlas environment on AWS

Task	Description	Skills required
Create a new MongoDB Atlas cluster on AWS.	In MongoDB Atlas, choose “Build a Cluster” to display the “Create New Cluster” dialog box. Select AWS as the cloud provider.	MongoDB DBA
Select Regions and global cluster configuration.	Select from the list of available AWS Regions for your Atlas cluster. Configure global clusters if required.	MongoDB DBA
Select the cluster tier.	Select your preferred cluster tier. Your tier selection determines factors such as memory, storage, and IOPS specification.	MongoDB DBA
Configure additional cluster settings.	Configure additional cluster settings such as MongoDB version, backup, and encryption options. For more information about these options, see the links in the “Related resources” section.	MongoDB DBA



## Configure security and compliance

Task	Description	Skills required
Configure the access list.	To connect to the Atlas cluster, you must add an entry to the project's access list. Atlas uses Transport Layer Security (TLS) / Secure Sockets Layer (SSL) to encrypt the connections to the virtual private cloud (VPC) for your database. To set up the access list for the project and for more information about the stories in this epic, see the links in the "Related resources" section.	MongoDB DBA
Authenticate and authorize users.	You must create and authenticate the database users who will access the MongoDB Atlas clusters. To access clusters in a project, users must belong to that project, and they can belong to multiple projects.	MongoDB DBA
Create custom roles.	(Optional) Atlas supports creating custom roles in cases where the built-in Atlas database user privileges don't cover your desired set of privileges.	MongoDB DBA
Set up VPC peering.	(Optional) Atlas supports VPC peering with other	MongoDB DBA

Task	Description	Skills required
	AWS, Azure, or Google Cloud Platform (GCP) VPCs.	
Set up an AWS PrivateLink endpoint.	(Optional) You can set up private endpoints on AWS by using AWS PrivateLink.	MongoDB DBA
Enable two-factor authentication.	(Optional) Atlas supports two-factor authentication (2FA) to help users control access to their Atlas accounts.	MongoDB DBA
Set up user authentication and authorization with LDAP.	(Optional) Atlas supports performing user authentication and authorization with Lightweight Directory Access Protocol (LDAP).	MongoDB DBA
Set up unified AWS access.	(Optional) Some Atlas features, including Atlas Data Lake and encryption at rest using customer key management, use AWS Identity and Access Management (AWS IAM) roles for authentication.	MongoDB DBA
Set up encryption at rest using AWS KMS.	(Optional) Atlas supports using AWS Key Management System (AWS KMS) to encrypt storage engines and cloud provider backups.	MongoDB DBA

Task	Description	Skills required
Set up client-side field-level encryption.	(Optional) Atlas supports client-side field level encryption, including automatic encryption of fields.	MongoDB DBA

## Migrate data

Task	Description	Skills required
Launch your target replica set in MongoDB Atlas.	Launch your target replica set in MongoDB Atlas. In Atlas Live Migration Service, choose "I'm ready to migrate."	MongoDB DBA
Add the Atlas Live Migration Service to the access list in your AWS source cluster.	This helps prepare the source environment to connect to the target Atlas cluster.	MongoDB DBA
Validate your AWS credentials with Atlas Live Migration Service.	Choose "Start migration ." When the "Prepare to Cutover" button turns green, perform the cutover. Review Atlas cluster performance metrics.	MongoDB DBA

## Configure operational integration

Task	Description	Skills required
Connect to the MongoDB Atlas cluster.		Application developer
Interact with cluster data.		Application developer

Task	Description	Skills required
Monitor your clusters.		MongoDB DBA
Back up and restore cluster data.		MongoDB DBA

## Related resources

### Migration guide

- [Migrating from MongoDB to MongoDB Atlas on the AWS Cloud](#)

### Discovery and assessment

- [Memory](#)
- [Sizing example with Atlas sample data sets](#)
- [Sizing example for mobile applications](#)
- [Network Traffic](#)
- [Cluster Auto-Scaling](#)
- [Atlas sizing template](#)

### Configuring security and compliance

- [Configure IP Access List Entries](#)
- [Configure database users](#)
- [Atlas User Access](#)
- [Configure Custom Roles](#)
- [Database User Privileges](#)
- [Set up a Network Peering Connection](#)
- [Set up a Private Endpoint](#)
- [Two Factor Authentication](#)
- [Set up User Authentication and Authorization with LDAP](#)
- [Atlas Data Lake](#)

- [Encryption at Rest using Customer Key Management](#)
- [Using IAM roles](#)
- [Client-Side Field Level Encryption](#)
- [Automatic Client-Side Field Level Encryption](#)
- [MongoDB Atlas Security](#)
- [MongoDB Trust Center](#)
- [Security Features and Setup](#)

## Setting up a new MongoDB Atlas environment on AWS

- [Cloud Providers and Regions](#)
- [Global Clusters](#)
- [Cluster Tier](#)
- [Additional Cluster Settings](#)
- [Get Started with Atlas](#)
- [Atlas User Access](#)
- [Clusters](#)

## Migrating data

- [Monitor Your Cluster](#)

## Integrating operations

- [Connect to a Cluster](#)
- [Perform CRUD Operations in Atlas](#)
- [Monitor Your Cluster](#)
- [Backup and Restore Cluster Data](#)

# Migrate from Oracle WebLogic to Apache Tomcat (TomEE) on Amazon ECS

Created by Anya Epishcheva (AWS) and Harshad Gohil (AWS)

<b>R Type:</b> Replatform	<b>Source:</b> Containers	<b>Target:</b> Apache Tomcat (TomEE) on Amazon ECS
<b>Created by:</b> AWS	<b>Environment:</b> PoC or pilot	<b>Technologies:</b> Containers & microservices; Migration
<b>Workload:</b> Oracle	<b>AWS services:</b> Amazon ECS	

## Summary

This pattern discusses the steps for migrating an on-premises Oracle Solaris SPARC system running Oracle WebLogic to a Docker container-based installation running [Apache TomEE](#) (Apache Tomcat with added container support) with Amazon Elastic Container Service (Amazon ECS).

For information about migrating databases that are associated with the applications you are migrating from Oracle WebLogic to Tomcat, see the database migration patterns in this catalog.

## Best practices

Steps for migrating Java and Java Enterprise Edition (Java EE) web applications vary, depending on the number of container-specific resources used by the application. Spring-based applications are typically easier to migrate, because they have a small number of dependencies on the deployment container. In contrast, Java EE applications that use Enterprise JavaBeans (EJBs) and managed container resources such as thread pools, Java Authentication and Authorization Service (JAAS), and Container-Managed Persistence (CMP) require more effort.

Applications developed for Oracle Application Server frequently use the Oracle Identity Management suite. Customers migrating to open-source application servers frequently choose to re-implement identity and access management using SAML-based federation. Others use Oracle HTTP Server Webgate for cases when migrating from the Oracle Identity Management suite isn't an option.

Java and Java EE web applications are great candidates for deployment on AWS services that are Docker-based, such as AWS Fargate and Amazon ECS. Customers frequently choose a Docker image with the latest version of the target application server (such as TomEE) and the Java Development Kit (JDK) pre-installed. They install their applications on top of the base Docker image, publish it in their Amazon Elastic Container Registry (Amazon ECR) registry, and use it for scalable deployment of their applications on AWS Fargate or Amazon ECS.

Ideally, application deployment is elastic; that is, the number of application instances scales in or out, depending on traffic or workload. This means that application instances need to come online or be terminated to adjust capacity for demand.

When moving a Java application to AWS, consider making it stateless. This is a key architectural principle of the AWS Well-Architected Framework that will enable horizontal scaling using containerization. For example, most Java-based web applications store user-session information locally. To survive application instance termination due to automatic scaling in Amazon Elastic Compute Cloud (Amazon EC2) or for other reasons, user-session information should be stored globally so that web application users can continue to work seamlessly and transparently without reconnecting or relogging into a web application. There are several architectural options for this approach, including Amazon ElastiCache for Redis, or storing session state in a global database. Application servers such as TomEE have plugins, which enable session storage and management via Redis, databases, and other global data stores.

Use a common, centralized logging and debugging tool that is easily integrated with Amazon CloudWatch and AWS X-Ray. Migration provides an opportunity to improve application lifecycle capabilities. For example, you might want to automate the build process so that changes are easily made using a continuous integration and continuous delivery (CI/CD) pipeline. This may require changes to the application so that it can be deployed without any downtime.

## Prerequisites and limitations

### Prerequisites

- An active AWS account
- Source Java code and JDK
- Source application built with Oracle WebLogic
- Defined solution for identity and access management (SAML or Oracle Webgate)
- Defined solution for application session management (moving like-for-like or with Amazon ElastiCache, or making the application stateless if needed)

- Understanding if the team needs to refactor J2EE-specific libraries for portability to Apache TomEE (see [Java EE 7 Implementation Status](#) on the Apache website)
- Hardened TomEE image based on your security requirements
- Container image with pre-installed target TomEE
- Application remediation agreed and implemented if needed (for example, logging debug build, authentication)

## Product versions

- Oracle WebLogic OC4J, 9i, 10g
- Tomcat 7 (with Java 1.6 or later)

## Architecture

### Source technology stack

- Web application built using Oracle WebLogic
- Web application using Oracle Webgate or SAML authentication
- Web applications connected to Oracle Database version 10g and later

### Target technology stack

- TomEE (Apache Tomcat with added container support) running on Amazon ECS (see also [Deploying Java Web Applications](#) and [Java Microservices on Amazon ECS](#))
- Amazon Relational Database Service (Amazon RDS) for Oracle; for Oracle versions supported by Amazon RDS, see [Amazon RDS for Oracle](#)

### Target architecture



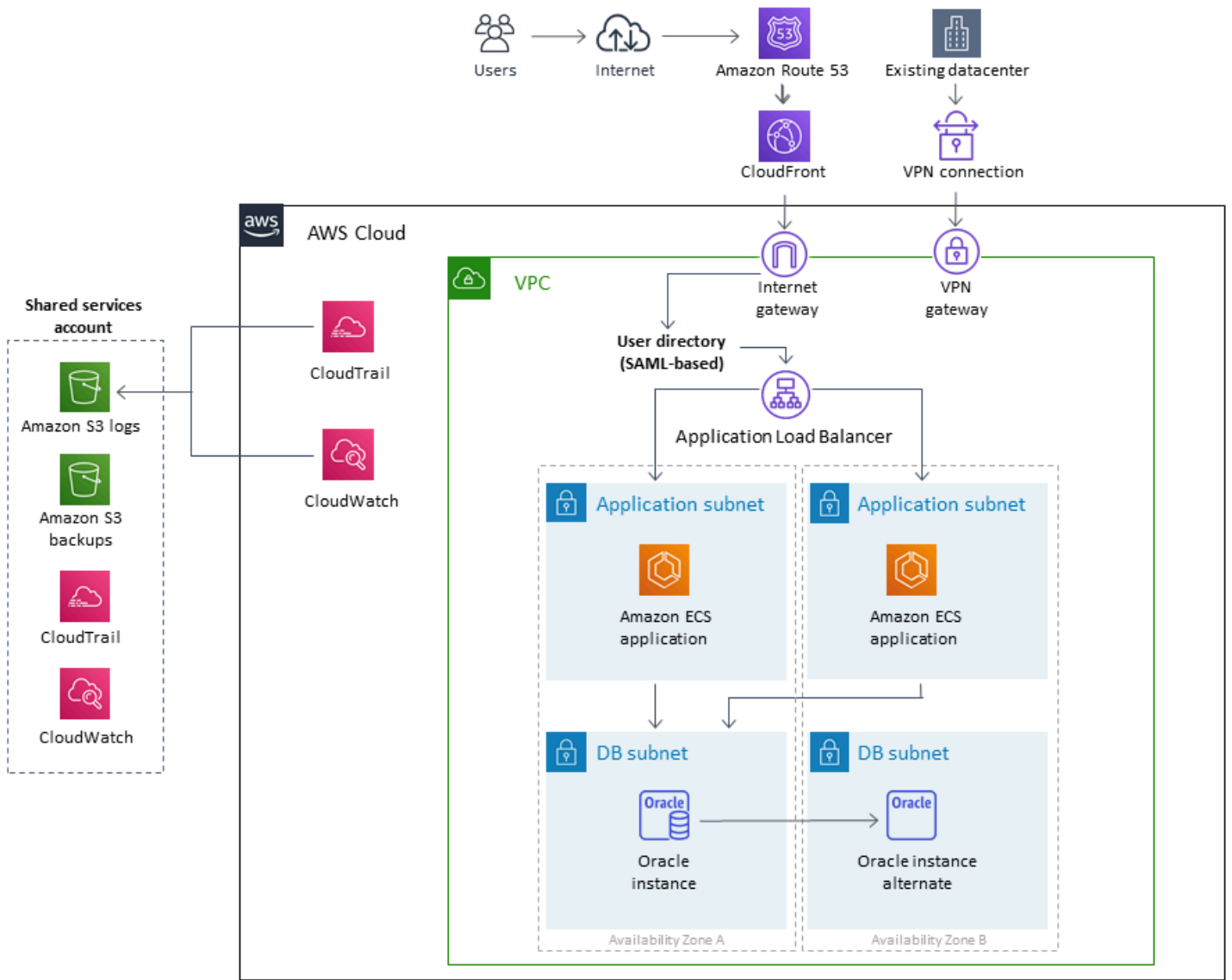

## Tools

To operate on TomEE, a Java application must be rebuilt into a .war file. In some cases, application changes may be required to operate the application on TomEE; you should check to make sure that the necessary configuration options and environment properties are defined correctly.

Also, Java Naming and Directory Interface (JNDI) lookups and JavaServer Pages (JSP) namespaces should be defined correctly. Consider checking file names used by the application to avoid naming collisions with built-in T libraries. For example, persistence.xml is a file name used by the Apache OpenJPA framework (which is bundled with OpenEJB in TomEE) for configuration purposes. The persistence.xml file in PUI contains Spring framework bean declarations.

TomEE version 7.0.3 and later (Tomcat 8.5.7 and later) returns an HTTP 400 response (bad request) for raw (unencoded) URLs with special characters. The server response appears as a blank page to the end-user. Earlier versions of TomEE and Tomcat allowed the use of certain unencoded special characters in URLs; however, it's considered unsafe, as stated on the [CVE-2016-6816 website](#). To resolve the URL encoding issue, the URLs passed to the browser directly via JavaScript must be encoded with the **encodeURIComponent()** method instead of being used as raw strings.

After you deploy the .war file in TomEE, monitor *start log* to *Linux cat* for any missing shared libraries and Oracle-specific extensions to add missing components from Tomcat libraries.

## General procedure

- Configure the application on TomEE.
- Identify and reconfigure application server-specific configuration files and resources from source to target format.
- Identify and reconfigure JNDI resources.
- Adjust EJB namespace and lookups to the format required by the target application server (if applicable).
- Reconfigure JAAS application container-specific security roles and principle mappings (if applicable).
- Package the application and shared libraries into a .war file.
- Deploy the .war file in TomEE by using the Docker container provided.
- Monitor *start log* to identify any missing shared library and deployment descriptor extensions. If any are found, go back to the first task.
- Test the installed application against the restored Amazon RDS database.
- Launch the complete architecture with a load balancer and Amazon ECS cluster by following the instructions in [Deploy Docker Containers](#).
- Update the URLs to point to the load balancer.
- Update the configuration management database (CMDB).

## Epics

### Plan the migration

Task	Description	Skills required
Perform application discovery (current state footprint and performance baseline).		BA, Migration Lead
Validate source and target database versions and engines.		DBA
Validate the source and target application design (identity and session management).		DBA, Migration Engineer, App owner
Identify hardware and storage requirements for the target server instance.		DBA, SysAdmin
Choose the proper instance type based on capacity, storage features, and network features.		DBA, SysAdmin
Identify network access security requirements for the source and target databases.		DBA, SysAdmin
Identify application migration strategy and tooling.		DBA, Migration Lead
Complete the migration design and migration guide for the application.		Build Lead, Migration Lead

Task	Description	Skills required
Complete the application migration runbook.		Build Lead, Cutover Lead, Testing Lead, Migration Lead

## Configure the infrastructure

Task	Description	Skills required
Create a virtual private cloud (VPC).		SysAdmin
Create security groups.		SysAdmin
Configure and start the Amazon RDS DB instance.		DBA, SysAdmin
Configure Amazon ECS deployment.		SysAdmin
Package your application as a Docker image.		SysAdmin
Push the image to the Amazon ECR registry (or skip this step and push it to the Amazon ECS cluster).		SysAdmin
Configure the task definition for the application and Amazon ECS service options.		SysAdmin
Configure your cluster, review security settings, and set AWS Identity and Access Management (IAM) roles.		SysAdmin

Task	Description	Skills required
Launch your setup and run tests according to your application migration runbook.		SysAdmin

## Migrate data

Task	Description	Skills required
Get your security assurance team's permission to move production data to AWS.		DBA, Migration Engineer, App owner
Create and obtain access to endpoints to fetch database backup files.		DBA
Use the native database engine or third-party tools to migrate database objects and data.		DBA
Run necessary tests from the application migration runbook to confirm successful data migration.		DBA, Migration Engineer, App owner

## Migrate the application

Task	Description	Skills required
Create a change request (CR) for migration.		Cutover Lead

Task	Description	Skills required
Obtain CR approval for migration.		Cutover Lead
Follow the application migration strategy from the application migration runbook.		DBA, Migration Engineer, App owner
Upgrade the application (if required).		DBA, Migration Engineer, App owner
Complete functional, non-functional, data validation, SLA, and performance tests.		Testing Lead, App Owner, App Users

### Cut over

Task	Description	Skills required
Obtain signoff from the application or business owner.		Cutover Lead
Run a table topic exercise to walk through all the steps of the cutover runbook.		DBA, Migration Engineer, App owner
Switch application clients to the new infrastructure.		DBA, Migration Engineer, App owner

### Close the project

Task	Description	Skills required
Shut down temporary AWS resources.		DBA, Migration Engineer, SysAdmin

Task	Description	Skills required
Review and validate the project documents.		Migration Lead
Gather metrics around time to migrate, % of manual vs. tool, cost savings, etc.		Migration Lead
Close out the project and provide feedback.		Migration Lead, App Owner

## Related resources

### References

- [Apache Tomcat 7.0 documentation](#)
- [Apache Tomcat 7.0 installation guide](#)
- [Apache Tomcat JNDI documentation](#)
- [Apache TomEE documentation](#)
- [Amazon RDS for Oracle](#)
- [Amazon RDS pricing](#)
- [Oracle and AWS](#)
- [Oracle on Amazon RDS documentation](#)
- [Amazon RDS Multi-AZ deployments](#)
- [Getting started with Amazon ECS](#)
- [Getting started with Amazon RDS](#)

### Tutorials and videos

- [Best Practices for Running Oracle Databases on Amazon RDS](#) (re:Invent 2018 presentation)

# Migrate an Oracle database from Amazon EC2 to Amazon RDS for Oracle using AWS DMS

*Created by Chethan Gangadharaiah (AWS) and Brian motzer (AWS)*

<b>R Type:</b> Replatform	<b>Source:</b> Databases: Relational	<b>Target:</b> Amazon RDS for Oracle
<b>Created by:</b> AWS	<b>Environment:</b> PoC or pilot	<b>Technologies:</b> Databases; Migration
<b>Workload:</b> Oracle	<b>AWS services:</b> Amazon EC2; Amazon RDS	

## Summary

This pattern describes the steps for migrating an Oracle database on Amazon Elastic Compute Cloud (Amazon EC2) to Amazon Relational Database Service (Amazon RDS) for Oracle by using AWS Database Migration Service (AWS DMS). The pattern also uses Oracle SQL Developer or SQL\*Plus to connect to your Oracle DB instance, and includes an AWS CloudFormation template that automates some of the tasks.

Migrating to Amazon RDS for Oracle enables you to focus on your business and applications while Amazon RDS takes care of database administration tasks such as provisioning databases, backup and recovery, security patches, version upgrades, and storage management.

## Prerequisites and limitations

### Prerequisites

- An active AWS account
- An Amazon Machine Image (AMI) for Oracle Database on Amazon EC2

### Product versions

- AWS DMS supports Oracle versions 11g (version 11.2.0.3.v1 and later), 12c, and 18c for Amazon RDS instance databases for the Enterprise, Standard, Standard One, and Standard Two editions.



For the latest information about supported versions, see [Using an Oracle Database as a Target for AWS DMS](#) in the AWS documentation. (The attached AWS CloudFormation templates use Oracle version 12c as the source database.)

- Oracle SQL Developer 4.0.3

## Architecture

### Source architecture

- Oracle Database on Amazon EC2

### Target architecture

- Amazon RDS for Oracle

### Migration architecture

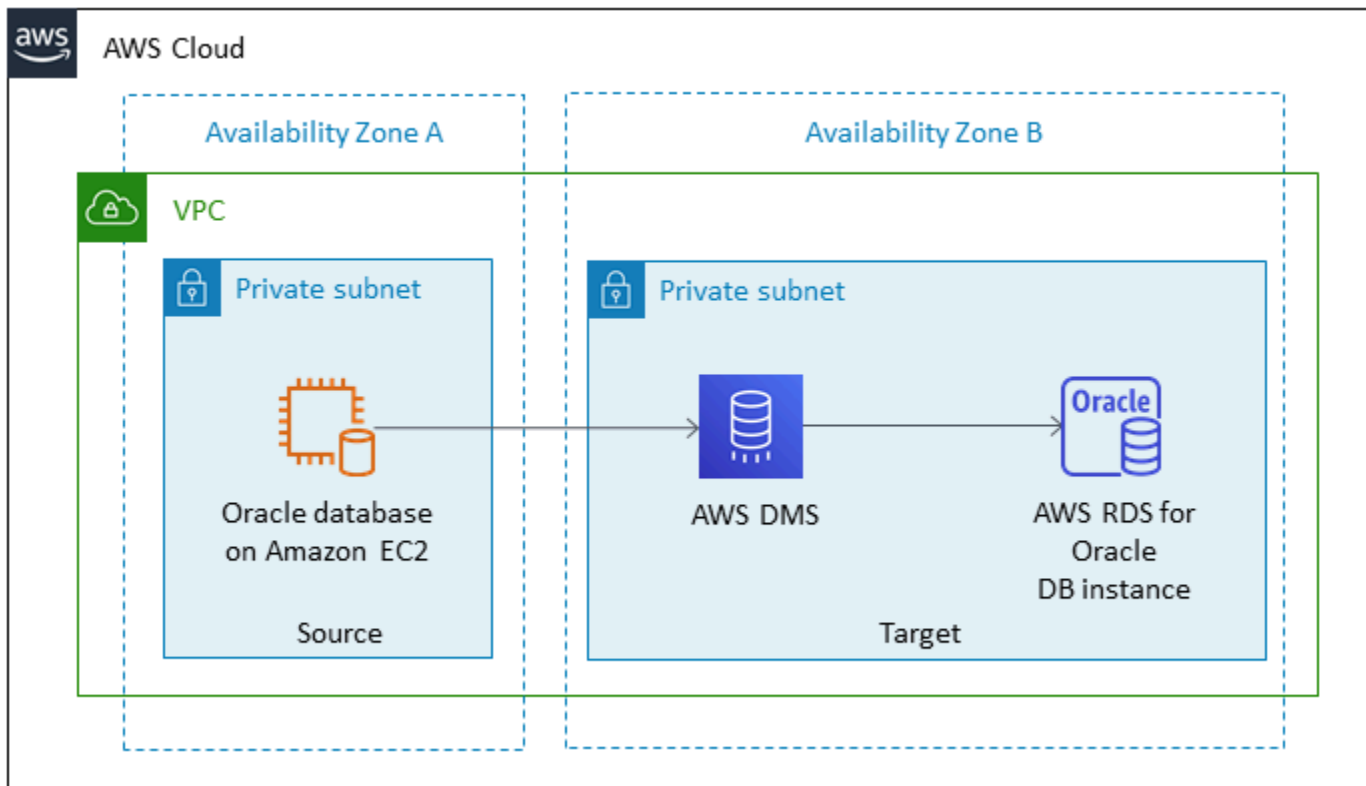

## Tools

- [AWS DMS](#) – AWS Database Migration Service (AWS DMS) helps you migrate databases to AWS quickly and securely. It supports both homogeneous and heterogeneous migrations. For information about the Oracle database versions and editions that are supported, see [Using an Oracle Database as a Source for AWS DMS](#) and [Using an Oracle Database as a Target for AWS DMS](#) in the AWS documentation.
- **Oracle SQL Developer or SQL \*Plus** – These tools enable you to connect to the Amazon RDS for Oracle DB instance.

## Epics

### Set up your target database

Task	Description	Skills required
Create an Amazon RDS for Oracle DB instance.	Sign in to the AWS Management Console and open the Amazon RDS console at <a href="https://console.aws.amazon.com/rds/">https://console.aws.amazon.com/rds/</a> . Create an Oracle DB instance by selecting the appropriate engine, template, database credentials setting, instance type, storage, Multi-AZ settings, virtual private cloud (VPC) and configuration, login credentials, and additional settings for the Oracle database. For instructions, view the links in the "Related resources" section. Or use the AWS CloudFormation template (Create_RDS.yaml) in the attachment to create	Developer

Task	Description	Skills required
	the Amazon RDS for Oracle DB instance.	
Connect to Amazon RDS and grant privileges to the Oracle user.	Modify the security group to open the appropriate ports to connect from the local machine and the AWS DMS replication instance. When you configure connectivity, make sure that the "Publicly accessible" option is selected so you can connect to the database from outside the VPC. Connect to Amazon RDS with Oracle SQL Developer or SQL *Plus by using the login credentials, create an AWS DMS user, and provide the required privileges to the AWS DMS user to modify the database.	Developer

### Configure the security group of the source EC2 instance

Task	Description	Skills required
Check if the Oracle database is up and running.	Use Secure Shell (SSH) to connect to the EC2 instance, and try connecting to the Oracle database by using SQL *Plus.	Developer
Modify the security group.	Modify the security group of the EC2 instance to open appropriate ports, so you	Developer

Task	Description	Skills required
	can connect from your local machine and the AWS DMS replication instance.	

## Set up AWS DMS

Task	Description	Skills required
Create an AWS DMS replication instance.	In AWS DMS, create a replication instance in the same VPC as your Amazon RDS for Oracle DB instance. Specify the name and description for the replication instance, choose the instance class and replication engine version (use the default), choose the VPC in which you created the Amazon RDS DB instance, set Multi-AZ settings if required, allocate storage, specify the Availability Zone, and configure additional settings. Alternatively, you can use the AWS CloudFormation template (DMS.yaml) in the attachment to implement this step.	DBA
Connect to the source and target database endpoints.	Create the source and target database endpoints by specifying the endpoint identifier, engine, server, port, login credentials, and extra connection attributes. For the	DBA

Task	Description	Skills required
	<p>source server, use the public DNS of the EC2 instance that's hosting the Oracle database. For the target server, use the endpoint of Amazon RDS for Oracle. Run a test to verify that the source and target connections are working. Alternatively, you can use the AWS CloudFormation template (DMS.yaml) in the attachment to implement this step.</p>	
Create an AWS DMS task.	<p>Create an AWS DMS task to migrate data from the source endpoint to the target endpoint, to set up replication between the source and destination endpoint, or both. When creating the AWS DMS task, specify the replication instance, source endpoint, target endpoint, migration type (data only, replication only, or both), table mapping, and filter. Run the AWS DMS task, monitor the task, check the table statistics, and check logs in Amazon CloudWatch. Alternatively, you can use the AWS CloudFormation template (DMS.yaml) in the attachment to implement this step.</p>	DBA

## Related resources

- [Creating an Amazon RDS DB instance](#)
- [Connecting to a DB Instance Running the Oracle Database Engine](#)
- [AWS DMS documentation](#)
- [AWS DMS Step-by-Step Walkthroughs](#)
- [Migrating Oracle Databases to the AWS Cloud](#)

## Attachments

To access additional content that is associated with this document, unzip the following file:  
[attachment.zip](#)

# Migrate an on-premises Oracle database to Amazon OpenSearch Service using Logstash

Created by Aditya Goteti (AWS)

<b>Environment:</b> PoC or pilot	<b>Source:</b> Oracle Database	<b>Target:</b> Amazon OpenSearch Service
<b>R Type:</b> Replatform	<b>Workload:</b> Oracle	<b>Technologies:</b> Migration; Databases
<b>AWS services:</b> Amazon OpenSearch Service		

## Summary

This pattern describes how to move data from an on-premises Oracle database to Amazon OpenSearch Service using Logstash. It includes architectural considerations and some required skill sets and recommendations. The data can be from a single table or from multiple tables in which a full-text search will need to be performed.

OpenSearch Service can be configured within a virtual private cloud (VPC), or it can be placed publicly with IP-based restrictions. This pattern describes a scenario where OpenSearch Service is configured within a VPC. Logstash is used to collect the data from the Oracle database, parse it to JSON format, and then feed the data into OpenSearch Service.

## Prerequisites and limitations

### Prerequisites

- An active AWS account
- Java 8 (required by Logstash 6.4.3)
- Connectivity between the on-premises database servers and Amazon Elastic Compute Cloud (Amazon EC2) instances in a VPC, established using AWS Virtual Private Network (AWS VPN)
- A query to retrieve the required data to be pushed to OpenSearch Service from the database
- Oracle Java Database Connectivity (JDBC) drivers

## Limitations

- Logstash cannot identify records that are hard-deleted from the database

## Product versions

- Oracle Database 12c
- OpenSearch Service 6.3
- Logstash 6.4.3

## Architecture

### Source technology stack

- On-premises Oracle database
- On-premises AWS VPN

### Target technology stack

- VPC
- EC2 instance
- OpenSearch Service
- Logstash
- NAT Gateway (for operating system updates on EC2 instances and to install Java 8, Logstash, and plugins)

### Data migration architecture



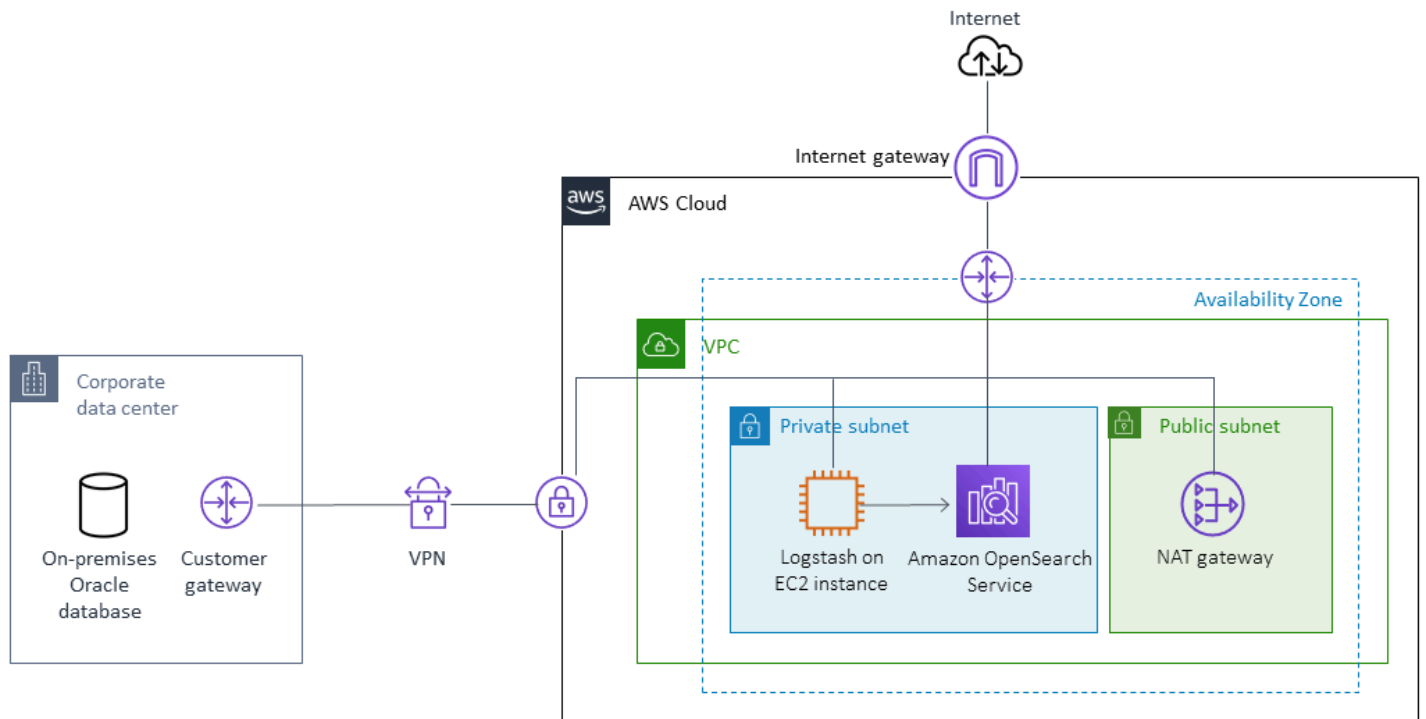

## Tools

- Logstash 6.4.3
- JDBC input plugin ([download and more information](#))
- Logstash output plugin ([logstash-output-amazon\\_es](#))
- Oracle JDBC drivers

## Epics

### Plan the migration

Task	Description	Skills required
Identify the size of the source data.	The size of the source data is one of the parameters that you use to determine the number of shards to be configured in an index.	DBA, Database developer

Task	Description	Skills required
Analyze the data types of each column and corresponding data.	OpenSearch Service dynamically maps the data type when a previously unseen field is found in the document. If there are any specific data types or formats (for example, date fields) that need to be explicitly declared, identify the fields and define the mapping for those fields during index creation.	App owner, Developer, Database developer
Determine if there are any columns with primary or unique keys.	To avoid duplication of records in Amazon OpenSearch Service during updates or inserts, you need to configure the <code>document_id</code> setting in the output section of the <code>amazon_es</code> plugin (for example, <code>document_id =&gt; "%{customer_id}"</code> where <code>customer_id</code> is a primary key).	App owner, Developer

Task	Description	Skills required
Analyze the number and frequency of new records added; check how frequently the records are deleted.	This task is required to understand the growth rate of source data. If data is intensively read and insertions are rare, you can have a single index. If new records are inserted frequently and there are no deletions, the shard size can easily exceed the recommended maximum size of 50 GB. In this case, you can dynamically create an index by configuring index patterns in Logstash and in the code where you can access it by using an alias.	App owner, Developer
Determine how many replicas are required.		App owner, Developer
Determine the number of shards to be configured on the index.		App owner, Developer
Identify the instance types for dedicated master nodes, data nodes, and the EC2 instance.	For more information, see the <a href="#">Related resources</a> section.	App owner, Developer
Determine the number of dedicated master nodes and data nodes required.	For more information, see the <a href="#">Related resources</a> section.	

## Migrate data

Task	Description	Skills required
Launch an EC2 instance.	Launch an EC2 instance within the VPC to which AWS VPN is connected.	Amazon VPC constructs, AWS VPN
Install Logstash on the EC2 instance.		Developer
Install the Logstash plugins.	Install the required Logstash plugins <code>jdbc-input</code> and <code>logstash-output-amazon_es</code> .	Developer
Configure Logstash.	Create the Logstash keystore to store sensitive information such as AWS Secrets Manager keys and database credentials, and then place the references in a Logstash configuration file.	Developer
Configure the dead letter queue and persistent queue.	By default, when Logstash encounters an event that it cannot process because the data contains a mapping error or some other issue, the Logstash pipeline either hangs or drops the unsuccessful event. To protect against data loss in this situation, you can configure Logstash to write unsuccessful events to a dead letter queue instead of dropping them. To protect against data loss	Developer

Task	Description	Skills required
	<p>during abnormal termination, Logstash has a persistent queue feature that will store the message queue on disk. Persistent queues provide the data durability in Logstash.</p>	
Create the Amazon OpenSearch Service domain.	<p>Create the Amazon OpenSearch Service domain with an access policy that doesn't require signing requests with AWS Identity and Access Management (IAM) credentials. The Amazon OpenSearch Service domain must be created within the same VPC. You should also select the instance types and set the number of dedicated and master nodes based on your analysis.</p>	Developer
Configure the required Amazon OpenSearch Service logs.	<p>For more information, see the <a href="#">OpenSearch Service documentation</a>.</p>	
Create the index.		Developer

Task	Description	Skills required
Start Logstash.	Run Logstash as a background service. Logstash runs the configured SQL query, pulls the data, converts it to JSON format, and feeds it to OpenSearch Service. For the initial load, do not configure the scheduler in the Logstash configuration file.	Developer

Task	Description	Skills required
Check documents.	<p>Check the number of documents on the index and whether all documents are present in the source database. During initial load, they are added to the index and used to stop Logstash.</p> <p>Change the Logstash configuration to add a scheduler that runs at a fixed interval depending on client requirements, and restart Logstash. Logstash will pick only the records that were updated or added after the last run, and the last run timestamp is stored in the file that is configured with the property <code>last_run_metadata_path =&gt; "/usr/share/logstash/.logstash_jdbc_last_run"</code> in the Logstash configuration file.</p>	Developer

## Related resources

- [Recommended CloudWatch Alarms](#)
- [Dedicated Amazon OpenSearch Service Master Nodes](#)
- [Sizing Amazon OpenSearch Service Domains](#)
- [Logstash documentation](#)

- [JDBC input plugin](#)
- [Logstash output plugin](#)
- [Amazon OpenSearch Service website](#)



# Migrate an on-premises Oracle database to Amazon RDS for Oracle

Created by Baji Shaik (AWS) and Pavan Pusuluri (AWS)

<b>Environment:</b> PoC or pilot	<b>Source:</b> Databases: Relational	<b>Target:</b> Amazon RDS for Oracle
<b>R Type:</b> Replatform	<b>Workload:</b> Oracle	<b>Technologies:</b> Migration; Databases
<b>AWS services:</b> Amazon RDS; AWS DMS		

## Summary

This pattern describes the steps for migrating on-premises Oracle databases to Amazon Relational Database Service (Amazon RDS) for Oracle. As part of the migration process, you create a migration plan and consider important factors about your target database infrastructure based on your source database. You can choose one of two migration options based on your business requirements and use case:

- **AWS Database Migration Service (AWS DMS)** – You can use AWS DMS to migrate databases to the AWS Cloud quickly and securely. Your source database remains fully operational during the migration, which minimizes downtime to applications that rely on the database. You can reduce migration time by using AWS DMS to create a task that captures ongoing changes after you complete an initial full-load migration through a process called [change data capture \(CDC\)](#). For more information, see [Migrate from Oracle to Amazon RDS with AWS DMS](#) in the AWS documentation.
- **Native Oracle tools** – You can migrate databases by using native Oracle tools, such as Oracle and [Data Pump Export](#) and [Data Pump Import](#) with [Oracle GoldenGate](#) for CDC. You can also use native Oracle tools such as the original [Export utility](#) and original [Import utility](#) to reduce the full-load time.

## Prerequisites and limitations

### Prerequisites

- An active AWS account
- An on-premises Oracle database
- An Amazon RDS Oracle database (DB) instance

## Limitations

- Database size limit: 64 TB

## Product versions

- Oracle versions 11g (versions 11.2.0.3.v1 and later) and up to 12.2 and 18c. For the latest list of supported versions and editions, see [Amazon RDS for Oracle](#) in the AWS documentation. For Oracle versions supported by AWS DMS, see [Using an Oracle database as a source for AWS DMS](#) in the AWS DMS documentation.

## Architecture

### Source technology stack

- On-premises Oracle databases

### Target technology stack

- Amazon RDS for Oracle

### Source and target architecture

The following diagram shows how to migrate an on-premises Oracle database to Amazon RDS for Oracle by using AWS DMS.

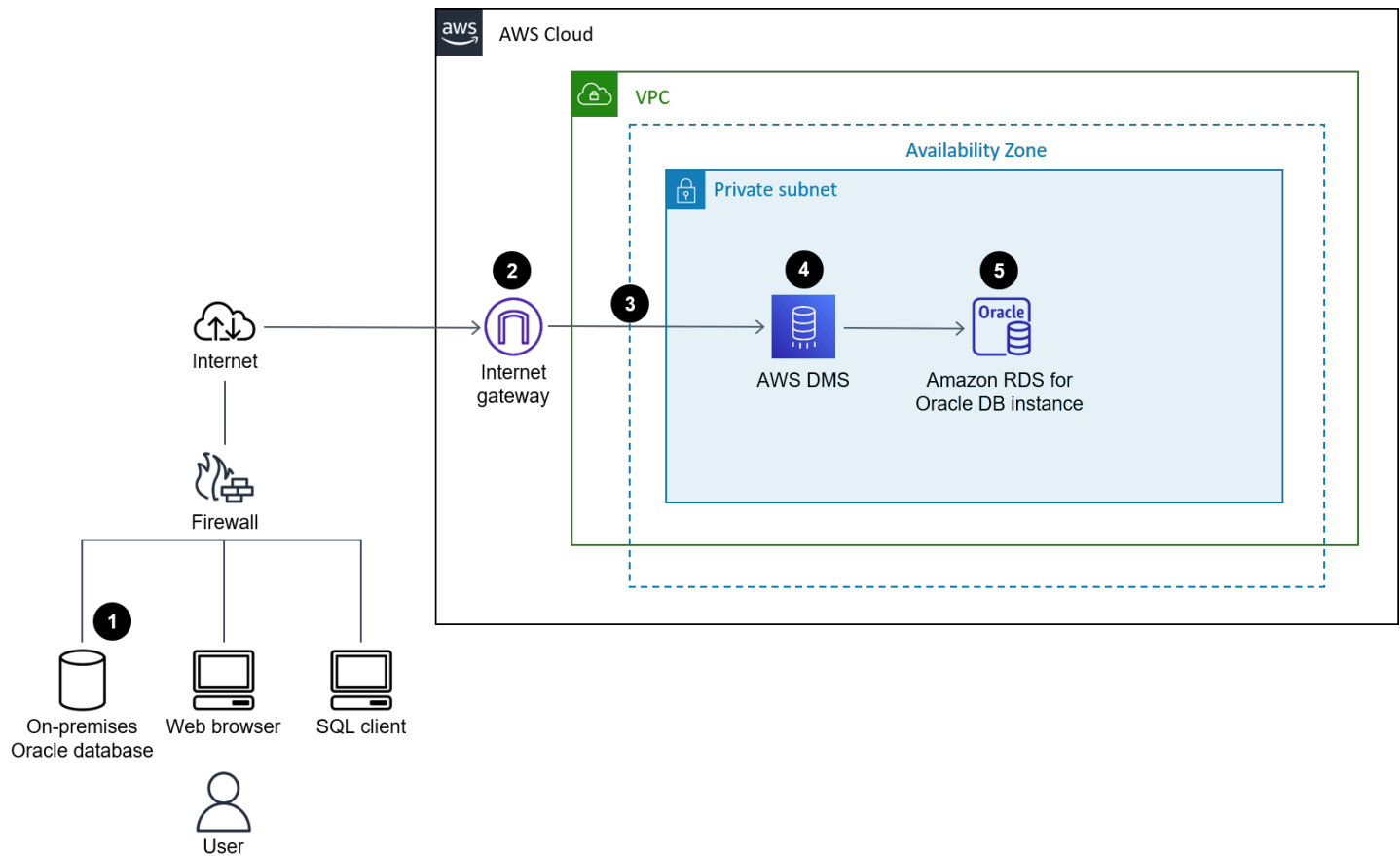

The diagram shows the following workflow:

1. Create or use an existing database user, grant the required [AWS DMS permissions](#) to that user, turn on [ARCHIVELOG mode](#), and then set up [supplemental logging](#).
2. Configure the internet gateway between the on-premises and AWS network.
3. Configure [source and target endpoints](#) for AWS DMS.
4. Configure [AWS DMS replication tasks](#) to migrate the data from the source database to the target database.
5. Complete the post-migration activities on the target database.

The following diagram shows how to migrate an on-premises Oracle database to Amazon RDS for Oracle by using native Oracle tools.

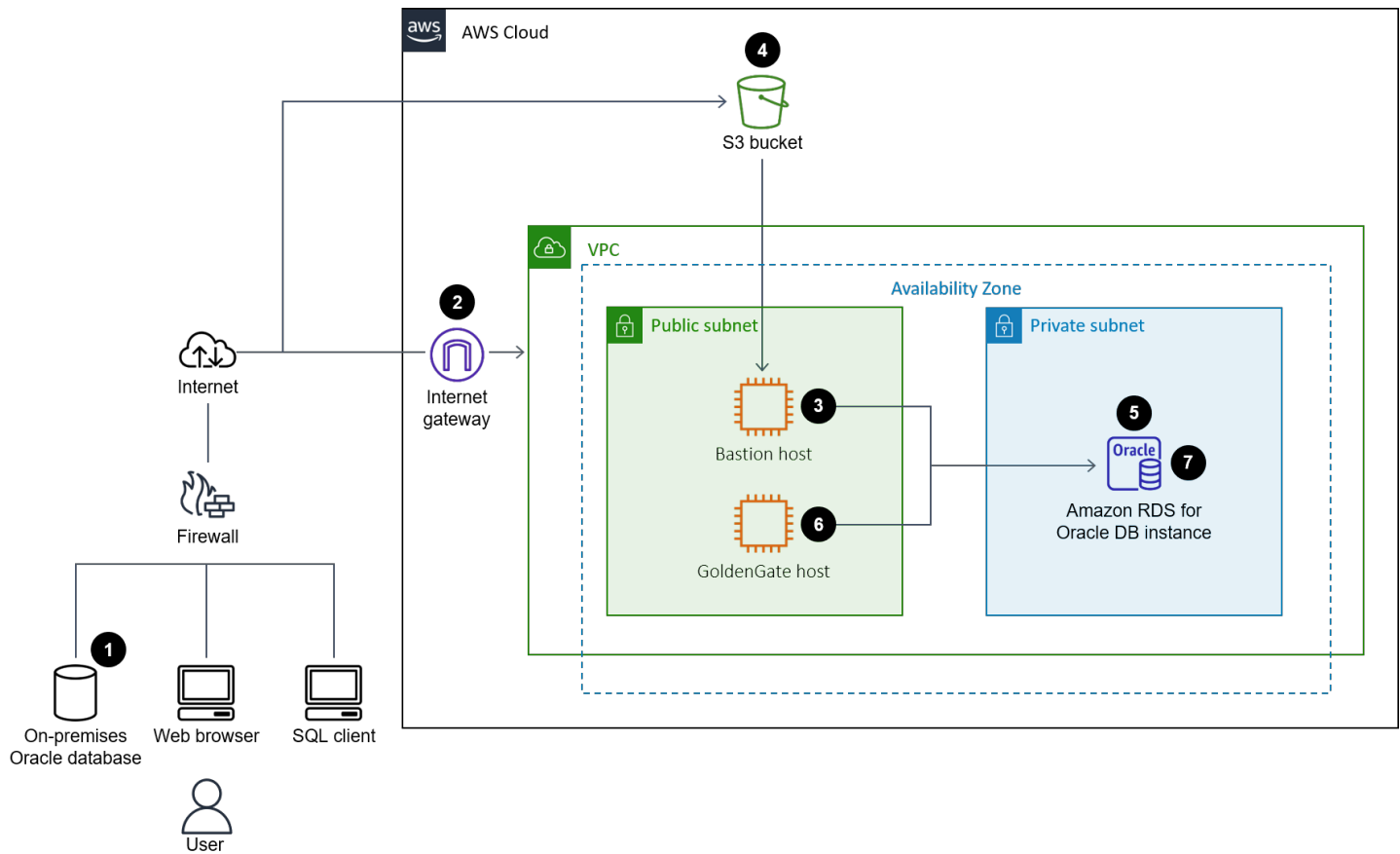

The diagram shows the following workflow:

1. Create or use an existing database user and grant the required permissions to back up the Oracle database by using Oracle Export (`exp`) and Import (`imp`) utilities.
2. Configure the internet gateway between the on-premises and AWS network.
3. Configure the Oracle client on the [Bastion](#) host to take the backup database.
4. Upload the backup database to an Amazon Simple Storage Service (Amazon S3) bucket.
5. Restore the database backup from Amazon S3 to an Amazon RDS for Oracle database.
6. Configure Oracle GoldenGate for CDC.
7. Complete the post-migration activities on the target database.

## Tools

- [AWS Database Migration Service \(AWS DMS\)](#) helps you migrate data stores into the AWS Cloud or between combinations of cloud and on-premises setups.

- Native Oracle tools help you perform a homogeneous migration. You can use [Oracle Data Pump](#) to migrate data between your source and target databases. This pattern uses Oracle Data Pump to perform the full load from the source database to the target database.
- [Oracle GoldenGate](#) helps you perform logical replication between two or more databases. This pattern uses GoldenGate to replicate the delta changes after the initial load by using Oracle Data Pump.

## Epics

### Plan the migration

Task	Description	Skills required
Create project documents and record database details.	<ol style="list-style-type: none"> <li>1. Document your migration goals, migration requirements, key project stakeholders, project milestones, project deadlines, key metrics, migration risks, and risk mitigation plans.</li> <li>2. Document critical information about your source database, including RAM, IOPS, and CPUs. You will later use this information to determine the appropriate target DB instance.</li> <li>3. Validate the versions of your source and target databases.</li> </ol>	DBA
Identify storage requirements.	Identify and document your storage requirements, including the following:	DBA, SysAdmin

Task	Description	Skills required
	<ol style="list-style-type: none"> <li>1. Calculate the storage allocated for the source DB instance.</li> <li>2. Gather the historical growth metrics from the source DB instance.</li> <li>3. Forecast future growth for the target DB instance.</li> </ol> <p><b>Note:</b> For <a href="#">General Purpose (gp2) SSD volumes</a>, you get three IOPS per 1 GB of storage. Allocate storage by calculating the total number of read and write IOPS on the source database.</p>	
Choose the proper instance type based on compute requirements.	<ol style="list-style-type: none"> <li>1. Determine the compute requirements of the target DB instance.</li> <li>2. Identify performance issues.</li> <li>3. Consider the factors for determining the appropriate instance type: <ul style="list-style-type: none"> <li>• CPU utilization of the source DB instance</li> <li>• IOPS (read and write) for the source DB instance</li> <li>• Memory footprint on the source DB instance</li> </ul> </li> </ol>	SysAdmin

Task	Description	Skills required
Identify network access security requirements.	<ol style="list-style-type: none"><li>1. Identify and document the network access security requirements for your source and target databases.</li><li>2. Configure the appropriate security groups for enabling the application to communicate with the database.</li></ol>	DBA, SysAdmin
Identify the application migration strategy.	<ol style="list-style-type: none"><li>1. Determine and document the migration cutover strategy.</li><li>2. Determine and document your application's recovery time objective (RTO) and recovery point objective (RPO), and then plan for the cutover accordingly.</li></ol>	DBA, SysAdmin, App owner

Task	Description	Skills required
Identify migration risks.	<p>Assess the database and document migration specific risks and mitigations. For example:</p> <ul style="list-style-type: none"> <li>Identify no-logging tables and highlight the risk of data loss in the event of recovery.</li> <li>Extract the source database users and privileges, and highlight the conflicts with Amazon RDS privileges.</li> <li>Review the alert log for any Oracle-specific errors and warnings.</li> <li>Identify the supported and unsupported features of the target DB instance.</li> <li>Review the deprecated features of the target DB version engine.</li> </ul>	DBA

## Configure the infrastructure

Task	Description	Skills required
Create a VPC.	<a href="#">Create a new Amazon Virtual Private Cloud (Amazon VPC)</a> for the target DB instance.	SysAdmin
Create security groups.	<a href="#">Create a security group</a> in your new VPC to allow	SysAdmin



Task	Description	Skills required
	inbound connections to the DB instance.	
Create an Amazon RDS for Oracle DB instance.	<a href="#">Create the target DB instance</a> with the new VPC and security group, and then start the instance.	SysAdmin

### Option 1 - Use native Oracle or third-party tools to migrate data

Task	Description	Skills required
Prepare the source database.	<ol style="list-style-type: none"> <li><a href="#">Create a Data Pump directory</a> or use an existing one.</li> <li>Create a migration user and <a href="#">grant permissions</a> to perform the Data Pump extract.</li> <li>Extract roles, users, and tablespaces from the source database as a SQL script.</li> <li>Transfer the extracted Data Pump dump to the target DB instance data pump directory.</li> </ol>	DBA, SysAdmin
Prepare the target database.	<ol style="list-style-type: none"> <li>Confirm that all the database options (for example, text and Java) are installed or enabled on the target Amazon RDS for Oracle DB instance.</li> </ol>	DBA, SysAdmin

Task	Description	Skills required
	<ol style="list-style-type: none"><li>2. Create a Data Pump directory or use an existing one.</li><li>3. Create a migration user and grant permissions to perform the Data Pump import.</li><li>4. Create the required tablespaces, users, and roles on the target DB instance.</li><li>5. Import the transferred Data Pump export dump to the target database.</li><li>6. Create any indexes excluded during import or object creation.</li><li>7. Create any constraints excluded during import.</li><li>8. Validate or recompile invalid objects.</li><li>9. Rebuild the invalid indexes.</li><li>10. Validate the database object counts between the source and the target databases.</li><li>11. Resolve any discrepancies found between object counts.</li></ol>	

## Option 2 - Use AWS DMS to migrate data

Task	Description	Skills required
Prepare the data.	<ol style="list-style-type: none"><li>1. Clean the data in the source database.</li><li>2. <a href="#">Create a replication instance.</a></li><li>3. <a href="#">Create a source endpoint and target endpoint.</a></li><li>4. Identify the number of tables and objects to be migrated.</li></ol>	DBA
Migrate the data.	<ol style="list-style-type: none"><li>1. Drop foreign key constraints and triggers on the target database.</li><li>2. Drop secondary indexes on the target database.</li><li>3. <a href="#">Configure AWS DMS full-load task settings</a> from the source database to the target database.</li><li>4. Enable foreign keys.</li><li>5. <a href="#">Enable AWS DMS CDC</a> to replicate ongoing changes.</li><li>6. Enable triggers.</li><li>7. Update the sequences.</li><li>8. Validate the source and target data.</li></ol>	DBA

## Cut over to the target database

Task	Description	Skills required
Switch the application clients to the new infrastructure.	<ol style="list-style-type: none"> <li>1. Stop all application services and client connections pointing to Oracle.</li> <li>2. Run the AWS DMS tasks.</li> <li>3. Set up a rollback task (for example, reverse CDC from the Amazon RDS database to the on-premises Oracle database).</li> <li>4. Validate the data.</li> <li>5. Start the application services on the new target database by configuring Amazon Route 53 to the new Amazon RDS for Oracle DB instance.</li> <li>6. Add Amazon CloudWatch monitoring to your new Amazon RDS for Oracle DB instance.</li> </ol>	DBA, SysAdmin, App owner
Implement your rollback plan.	<ol style="list-style-type: none"> <li>1. Stop all application services pointing to the Amazon RDS for Oracle DB instance.</li> <li>2. Roll back the changes to the source on-premises Oracle database by using an AWS DMS task.</li> <li>3. Stop the AWS DMS tasks running from the on-</li> </ol>	DBA, App owner

Task	Description	Skills required
	<p>premises Oracle database to the Amazon RDS for Oracle database.</p> <p>4. Configure the applications back on the source Oracle database.</p> <p>5. Confirm the rollback deployment is complete.</p>	

### Close out the migration project

Task	Description	Skills required
Clean up resources.	Shut down or remove the temporary AWS resources, such as the AWS DMS replication instance and S3 bucket.	DBA, SysAdmin
Review project documents.	Review your migration planning documents and goals, and then confirm that you completed all required migration steps.	DBA, SysAdmin, App owner
Gather metrics.	Record key migration metrics, including how long it took to complete the migration, the percentage of manual vs. tool-based tasks, cost savings, and other relevant metrics.	DBA, SysAdmin, App owner
Close out the project.	Close out the migration project and capture feedback about the effort.	DBA, SysAdmin, App owner

## Related resources

### References

- [Strategies for Migrating Oracle Databases to AWS](#) (AWS whitepaper)
- [AWS Database Migration Service](#) (AWS DMS documentation)
- [Amazon RDS Pricing](#) (Amazon RDS documentation)

### Tutorials and videos

- [Getting Started with AWS Database Migration Service](#) (AWS DMS documentation)
- [Amazon RDS resources](#) (Amazon RDS documentation)
- [AWS Database Migration Service \(DMS\)](#) (YouTube)

# Migrate an on-premises Oracle database to Amazon RDS for Oracle using Oracle Data Pump

Created by Mohan Annam (AWS) and Brian motzer (AWS)

<b>Environment:</b> PoC or pilot	<b>Source:</b> Databases: Relational	<b>Target:</b> Amazon RDS for Oracle
<b>R Type:</b> Replatform	<b>Workload:</b> Oracle	<b>Technologies:</b> Migration; Databases
<b>AWS services:</b> Amazon RDS		

## Summary

This pattern describes how to migrate an Oracle database from an on-premises data center to an Amazon Relational Database Service (Amazon RDS) for Oracle DB instance by using Oracle Data Pump.

The pattern involves creating a data dump file from the source database, storing the file in an Amazon Simple Storage Service (Amazon S3) bucket, and then restoring the data to an Amazon RDS for Oracle DB instance. This pattern is useful when you encounter limitations using AWS Database Migration Service (AWS DMS) for the migration.

## Prerequisites and limitations

### Prerequisites

- An active AWS account
- The required permissions to create roles in AWS Identity and Access Management (IAM) and for an Amazon S3 multipart upload
- The required permissions to export data from the source database
- AWS Command Line Interface (AWS CLI) [installed](#) and [configured](#)

### Product versions

- Oracle Data Pump is available only for Oracle Database 10g Release 1 (10.1) and later versions.

## Architecture

### Source technology stack

- On-premises Oracle databases

### Target technology stack

- Amazon RDS for Oracle
- SQL client (Oracle SQL Developer)
- An S3 bucket

### Source and target architecture

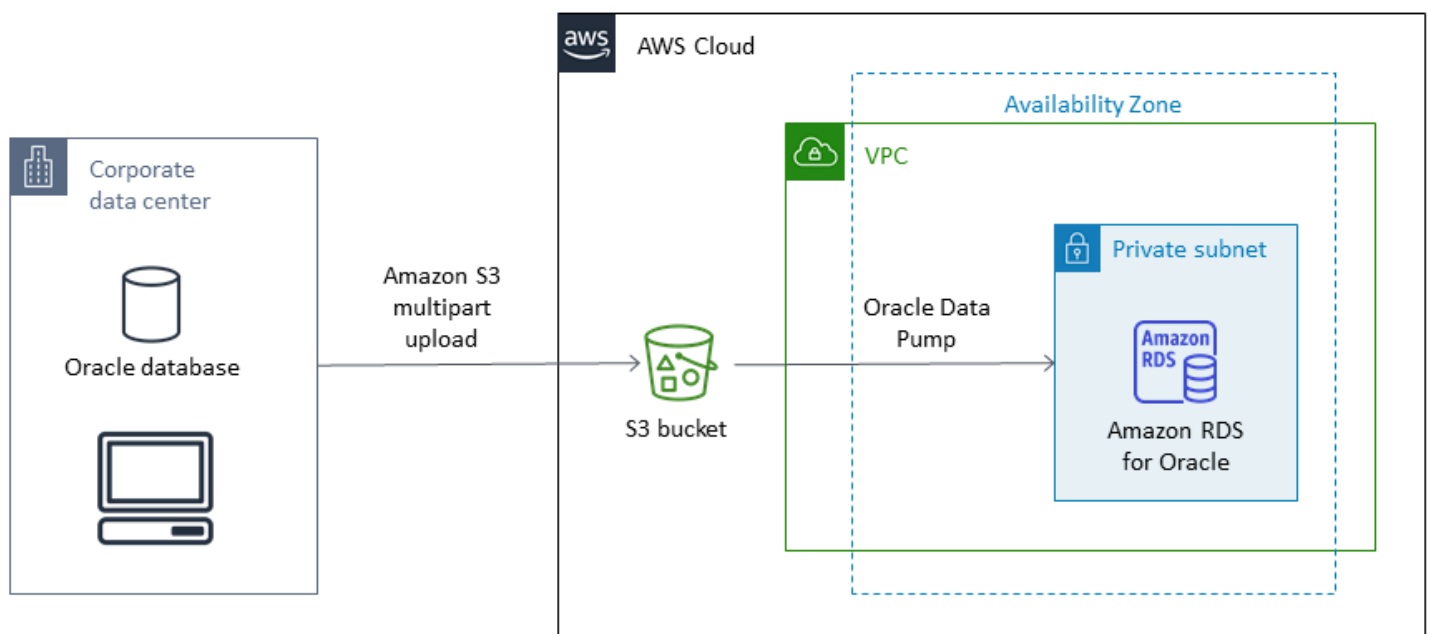

## Tools

### AWS services

- [AWS Identity and Access Management \(IAM\)](#) helps you securely manage access to your AWS resources by controlling who is authenticated and authorized to use them. In this pattern, IAM



is used to create the roles and policies necessary for migrating data from Amazon S3 to Amazon RDS for Oracle.

- [Amazon Relational Database Service \(Amazon RDS\) for Oracle](#) helps you set up, operate, and scale an Oracle relational database in the AWS Cloud.
- [Amazon Simple Storage Service \(Amazon S3\)](#) is a cloud-based object storage service that helps you store, protect, and retrieve any amount of data.

## Other tools

- [Oracle Data Pump](#) helps you move data and metadata from one database to another at high speeds. In this pattern, Oracle Data Pump is used to export the data dump (.dmp) file to the Oracle server, and to import it into Amazon RDS for Oracle. For more information, see [Importing data into Oracle on Amazon RDS](#) in the Amazon RDS documentation.
- [Oracle SQL Developer](#) is an integrated development environment that simplifies the development and management of Oracle databases in both traditional and cloud-based deployments. It interacts with both the on-premises Oracle database and Amazon RDS for Oracle to run the SQL commands required for exporting and importing data.

## Epics

### Create an S3 bucket

Task	Description	Skills required
Create the bucket.	To create the S3 bucket, follow the instructions in the <a href="#">AWS documentation</a> .	AWS systems administrator

### Create the IAM role and assign policies

Task	Description	Skills required
Configure IAM permissions.	To configure permissions, follow the instructions in the <a href="#">AWS documentation</a> .	AWS systems administrator

## Create the target Amazon RDS for Oracle DB instance and associate the Amazon S3 integration role

Task	Description	Skills required
Create the target Amazon RDS for Oracle DB instance.	To create the Amazon RDS for Oracle instance, follow the instructions in the <a href="#">AWS documentation</a> .	AWS systems administrator
Associate the role with the DB instance.	To associate the role with the instance, follow the instructions in the <a href="#">AWS documentation</a> .	DBA

## Create the database user on the target database

Task	Description	Skills required
Create the user.	<p>Connect to the target Amazon RDS for Oracle database from Oracle SQL Developer or SQL*Plus, and run the following SQL command to create the user to import the schema into.</p> <pre>create user SAMPLE_SC HEMA identified by &lt;PASSWORD&gt;; grant create session, resource to &lt;USER NAME&gt;; alter user &lt;USER NAME&gt; quota 100M on users;</pre>	DBA

## Create the export file from the source Oracle database

Task	Description	Skills required
Create a data dump file.	<p>To create a dump file named <code>sample.dmp</code> in the <code>DATA_PUMP_DIR</code> directory for exporting the <code>SAMPLE_SCHEMA</code> user, use the following script.</p> <pre data-bbox="592 636 1027 1885">DECLARE     hdl NUMBER; BEGIN     hdl := dbms_data pump.open(operation =&gt; 'EXPORT',              job_mode =&gt; 'SCHEMA',              job_name =&gt; NULL);      dbms_datapump.add_ file( handle =&gt; hdl,          filename =&gt; 'sample.dmp',          directory =&gt; 'DATA_PUMP_DIR',          filetype =&gt; dbms_datapump.ku\$_ file_type_dump_file);      dbms_datapump.add_ file(handle =&gt; hdl,          filename =&gt; 'export.log',</pre>	DBA

Task	Description	Skills required
	<pre data-bbox="613 247 964 919">           directory =&gt;           'DATA_PUMP_DIR',            filetype =&gt;           dbms_datapump.ku\$_           file_type_log_file);            dbms_datapump.meta           data_filter(hdnl,           'SCHEMA_EXPR', 'IN           ('SAMPLE_SCHEMA'           )');            dbms_datapump.star           t_job(hdnl);           END;           /         </pre> <p data-bbox="591 982 1003 1159">Review the export details by reviewing the <code>export.log</code> file in your local <code>DATA_PUMP_DIR</code> directory.</p>	

### Upload the dump file to the S3 bucket

Task	Description	Skills required
<p data-bbox="110 1453 496 1583">Upload the data dump file from the source to the S3 bucket.</p>	<p data-bbox="591 1453 925 1537">Using AWS CLI, run the following command.</p> <pre data-bbox="613 1591 932 1709">           aws s3 cp sample.dmp           s3://&lt;bucket_created_epic_1&gt;/         </pre>	<p data-bbox="1068 1453 1133 1486">DBA</p>

## Download the export file from the S3 bucket to the RDS instance

Task	Description	Skills required
Download the data dump file to Amazon RDS	<p>To copy the dump file <code>sample.dmp</code> from the S3 bucket to the Amazon RDS for Oracle database, run the following SQL command. In this example, the <code>sample.dmp</code> file is downloaded from the S3 bucket <code>my-s3-integration1</code> to the Oracle directory <code>DATA_PUMP_DIR</code>. Make sure that you have sufficient disk space allocated to your RDS instance to accommodate both the database and the export file.</p> <pre data-bbox="594 1073 1027 1751">-- If you want to download all the files in the S3 bucket remove the p_s3_prefix line.  SELECT rdsadmin. rdsadmin_s3_tasks. download_from_s3(     p_bucket_name =&gt; 'my-s3-integration ',     p_s3_prefix =&gt; 'sample.dmp',     p_directory_name =&gt; 'DATA_PUMP_DIR') AS TASK_ID FROM DUAL;</pre> <p>The previous command outputs a task ID. To review</p>	AWS systems administrator

Task	Description	Skills required
	<p>the status of the download by reviewing the data in the task ID, run the following command.</p> <pre data-bbox="594 426 1029 743">SELECT text FROM   table(rdsadmin.rds     _file_util.read_text_file('BDUMP','d     btask-&lt;task_id&gt;.log'));</pre> <p>To see the files in the DATA_PUMP_DIR directory, run the following command.</p> <pre data-bbox="594 951 1029 1425">SELECT filename,   type, filesize/1024   /1024 size_megs   ,to_char(mtime, 'DD   -MON-YY HH24:MI:SS')   timestamp   FROM TABLE(rdsadmin.rds     _file_util.listdir     (p_directory =&gt;     upper('DATA_PUMP_D     IR')))) order by 4;</pre>	

## Import the dump file into the target database

Task	Description	Skills required
Restore the schema and data to Amazon RDS.	To import the dump file into the sample_schema database schema, run the	DBA

Task	Description	Skills required
	<p>following SQL command from SQL Developer or SQL*Plus.</p> <pre>DECLARE hdnl NUMBER; BEGIN  hdnl := DBMS_DATA PUMP.OPEN( operation =&gt; 'IMPORT', job_mode =&gt; 'SCHEMA', job_name= &gt;&gt;null);  DBMS_DATAPUMP.ADD_ FILE( handle =&gt; hdnl, filename =&gt; 'sample.d mp', directory =&gt; 'DATA_PUMP_DIR', filetype =&gt; dbms_data pump.ku\$_file_type _dump_file);  DBMS_DATAPUMP.ADD_FILE ( handle =&gt; hdnl, filename =&gt; 'import.l og', directory =&gt; 'DATA_PUMP_DIR', filetype =&gt; dbms_data pump.ku\$_file_type _log_file);  DBMS_DATAPUMP. METADATA_FILTER(hd nl, 'SCHEMA_EXPR', ' IN ('SAMPLE_SCHEMA' )');  DBMS_DATAPUMP.START_J OB(hdnl);  END;</pre>	

Task	Description	Skills required
	<p>/</p> <p>To see the log file from the import, run the following command.</p> <pre>SELECT text FROM   table(rdsadmin.rds _file_util.read_text_file('DATA_PUMP _DIR', 'import.log'));</pre>	

### Remove the dump file from the DATA\_PUMP\_DIR directory

Task	Description	Skills required
List and clean up the export files.	<p>List and remove the export files in the DATA_PUMP_DIR directory, run the following commands.</p> <pre>-- List the files SELECT filename, type, filesize/1024 /1024 size_megs ,to_char(mtime, 'DD -MON-YY HH24:MI:SS') timestamp FROM TABLE(rdsadmin.rds _file_util.listdir (p_directory =&gt; upper('DATA_PUMP_D IR')))) order by 4;</pre> <pre>-- Remove the files</pre>	AWS systems administrator



Task	Description	Skills required
	<pre>EXEC UTL_FILE. REMOVE('DATA_PUMP _DIR', 'sample.dmp'); EXEC UTL_FILE.REMOVE(' DATA_PUMP_DIR', 'im port.log');</pre>	

## Related resources

- [Amazon S3 integration](#)
- [Create a DB instance](#)
- [Importing data into Oracle on Amazon RDS](#)
- [Amazon S3 documentation](#)
- [IAM documentation](#)
- [Amazon RDS documentation](#)
- [Oracle Data Pump documentation](#)
- [Oracle SQL Developer](#)

# Migrate from PostgreSQL on Amazon EC2 to Amazon RDS for PostgreSQL using pglogical

Created by Rajesh Madiwale (AWS)

<b>Environment:</b> PoC or pilot	<b>Source:</b> Amazon EC2	<b>Target:</b> Amazon RDS for PostgreSQL
<b>R Type:</b> Replatform	<b>Workload:</b> Open-source	<b>Technologies:</b> Migration; Databases
<b>AWS services:</b> Amazon RDS		

## Summary

This pattern outlines steps for migrating a PostgreSQL database (version 9.5 and later) from Amazon Elastic Compute Cloud (Amazon EC2) to Amazon Relational Database Service (Amazon RDS) for PostgreSQL by using the PostgreSQL **pglogical** extension. Amazon RDS now supports the pglogical extension for PostgreSQL version 10.

## Prerequisites and limitations

### Prerequisites

- Choose the right type of Amazon RDS instance. For more information, see [Amazon RDS Instance Types](#).
- Make sure that the source and target versions of PostgreSQL are the same.
- Install and integrate the [pglogical extension with PostgreSQL](#) on Amazon EC2.

### Product versions

- PostgreSQL version 10 and later on Amazon RDS, with the features supported on Amazon RDS (see [PostgreSQL on Amazon RDS](#) in the AWS documentation). This pattern was tested by migrating PostgreSQL 9.5 to PostgreSQL version 10 on Amazon RDS, but it also applies to later versions of PostgreSQL on Amazon RDS.

## Architecture

### Data migration architecture

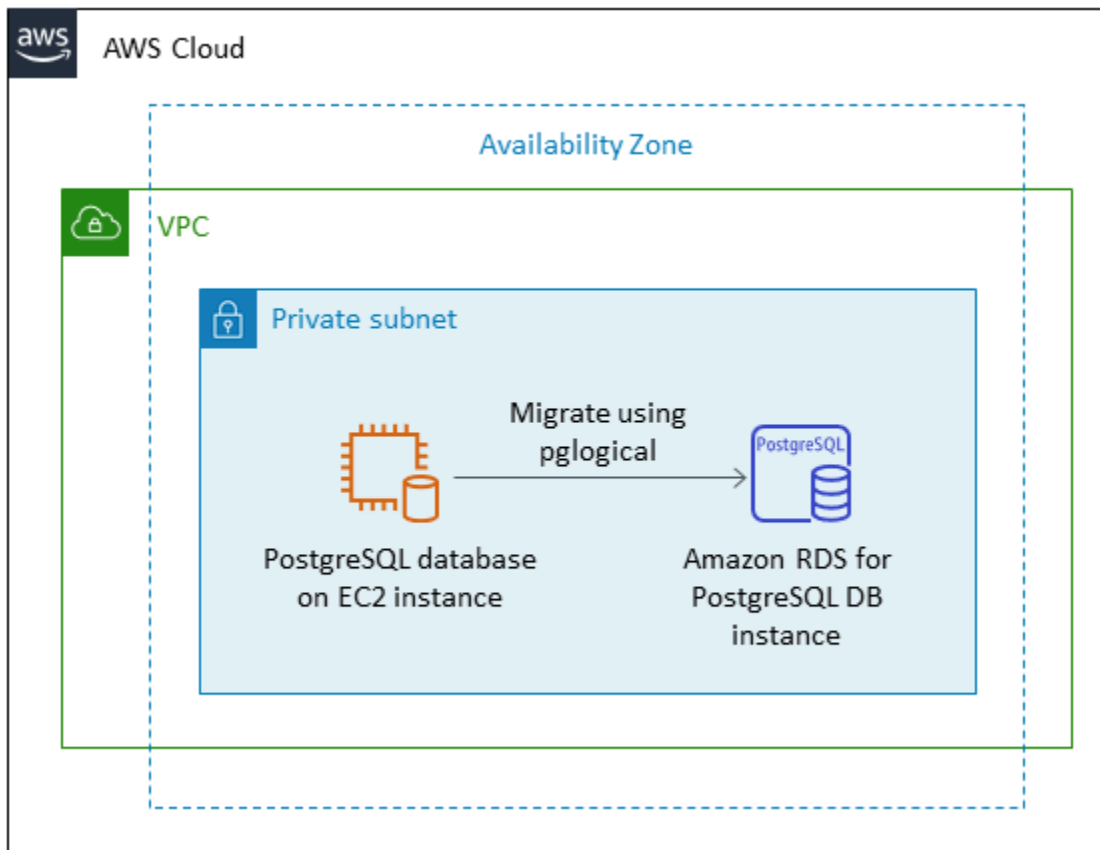

### Tools

- [pglogical](#) extension
- PostgreSQL native utilities: [pg\\_dump](#) and [pg\\_restore](#)

### Epics

#### Migrate data by using the pglogical extension

Task	Description	Skills required
Create an Amazon RDS PostgreSQL DB instance.	Set up a PostgreSQL DB instance in Amazon RDS. For instructions, see the	DBA

Task	Description	Skills required
	<a href="#">Amazon RDS for PostgreSQL documentation.</a>	
Obtain a schema dump from the source PostgreSQL database and restore it into the target PostgreSQL database.	<ol style="list-style-type: none"><li>1. Use the <a href="#">pg_dump</a> utility with the -s option to generate a schema file from the source database.</li><li>2. Use the <a href="#">psql</a> utility with the -f option to load the schema into the target database.</li></ol>	DBA
Turn on logical decoding.	In the Amazon RDS DB parameter group, set the <code>rds.logical_replication</code> static parameter to 1. For instructions, see the <a href="#">Amazon RDS documentation.</a>	DBA

Task	Description	Skills required
Create the pglogical extension on the source and target databases.	<ol style="list-style-type: none"><li data-bbox="591 226 1027 359">1. Create the pglogical extension on the source PostgreSQL database: <pre data-bbox="634 401 1027 669">psql -h &lt;amazon-ec2-endpoint&gt; -d target-dbname -U target-dbuser -c "create extension pglogical ;"</pre></li><li data-bbox="591 688 1027 821">2. Create the pglogical extension on the target PostgreSQL database: <pre data-bbox="634 863 1027 1131">psql -h &lt;amazon-rds-endpoint&gt; -d source-dbname -U source-dbuser -c "create extension pglogical ;"</pre></li></ol>	DBA
Create a publisher on the source PostgreSQL database.	<p data-bbox="591 1171 1027 1205">To create a publisher, run:</p> <pre data-bbox="607 1247 1027 1719">psql -d dbname -p 5432 &lt;&lt;EOF SELECT pglogical .create_node( node_name := 'provider1', dsn := 'host=&lt;ec2-endpoint&gt; port=5432 dbname=source-dbname user=source-dbuser' ); EOF</pre>	DBA

Task	Description	Skills required
Create a replication set, add tables and sequences.	<p>To create a replication set on the source PostgreSQL database, and to add tables and sequences to the replication set, run:</p> <pre data-bbox="597 491 1026 890">psql -d dbname -p 5432 &lt;&lt;EOF SELECT pglogical .replication_set_a dd_all_tables('default', '{public} '::text[],synchronize_data := true); EOF</pre>	DBA
Create a subscriber.	<p>To create a subscriber on the target PostgreSQL database, run:</p> <pre data-bbox="597 1094 1026 1688">psql -h &lt;rd endpoint&gt; -d target-database - U target-database-user &lt;&lt;EOF SELECT pglogical .create_node( node_name := 'subscriber1', dsn := 'host=&lt;rd endpoint&gt; port=5432 database=target-database password=postgres user=target-database-user' ); EOF</pre>	DBA

Task	Description	Skills required
Create a subscription.	<p>To create a subscription on the target PostgreSQL database, run:</p> <pre>psql -h &lt;rds-endpoint&gt; -d target -U postgres &lt;&lt;EOF SELECT pglogical .create_subscription( subscription_name := 'subscription1', replication_sets := array['default'], provider_dsn := 'host=&lt;ec2-endpoint&gt; port=5432 dbname=&lt;source-database-database-name&gt; password=&lt;password&gt; user=source-database-user' );</pre>	DBA

## Validate your data

Task	Description	Skills required
Check source and target databases.	Check the source and target databases to confirm that data is being replicated successfully. You can perform basic validation by using <code>select count(1)</code> from the source and target tables.	DBA

## Related resources

- [Amazon RDS](#)

- [Logical replication for PostgreSQL on Amazon RDS](#) (Amazon RDS documentation)
- [pglogical](#) (GitHub repository)
- [Limitations of pglogical](#) (GitHub repository README file)
- [Migrating PostgreSQL from on-premises or Amazon EC2 to Amazon RDS using logical replication](#) (AWS Database blog)



# Migrate an on-premises PostgreSQL database to Aurora PostgreSQL

Created by Baji Shaik (AWS) and Jitender Kumar (AWS)

<b>Environment:</b> PoC or pilot	<b>Source:</b> On-premises PostgreSQL database	<b>Target:</b> Aurora PostgreSQL-Compatible
<b>R Type:</b> Replatform	<b>Workload:</b> Open-source	<b>Technologies:</b> Migration; Databases
<b>AWS services:</b> Amazon Aurora; AWS DMS		

## Summary

Amazon Aurora PostgreSQL-Compatible Edition combines the performance and availability of high-end commercial databases with the simplicity and cost-effectiveness of open-source databases. Aurora provides these benefits by scaling storage across three Availability Zones in the same AWS Region, and supports up to 15 read replica instances for scaling out read workloads and providing high availability within a single Region. By using an Aurora global database, you can replicate PostgreSQL databases in up to five Regions for remote read access and disaster recovery in the event of a Region failure. This pattern describes the steps for migrating an on-premises PostgreSQL source database to an Aurora PostgreSQL-Compatible database. The pattern includes two migration options: using AWS Data Migration Service (AWS DMS) or using native PostgreSQL tools (such as [pg\\_dump](#), [pg\\_restore](#), and [psql](#)) or third-party tools.

The steps described in this pattern also apply to target PostgreSQL databases on Amazon Relational Database Service (Amazon RDS) and Amazon Elastic Compute Cloud (Amazon EC2) instances.

## Prerequisites and limitations

### Prerequisites

- An active AWS account
- A PostgreSQL source database in an on-premises data center

- [An Aurora PostgreSQL-Compatible DB instance](#) or an [Amazon RDS for PostgreSQL DB instance](#)

## Limitations

- Database size limits are 64 TB for Amazon RDS for PostgreSQL and 128 TB for Aurora PostgreSQL-Compatible.
- If you're using the AWS DMS migration option, review [AWS DMS limitations on using a PostgreSQL database as a source](#).

## Product versions

- For PostgreSQL major and minor version support in Amazon RDS, see [Amazon RDS for PostgreSQL updates](#) in the Amazon RDS documentation.
- For PostgreSQL support in Aurora, see [Amazon Aurora PostgreSQL updates](#) in the Aurora documentation.
- If you're using the AWS DMS migration option, see [supported PostgreSQL versions](#) in the AWS DMS documentation.

## Architecture

### Source technology stack

- On-premises PostgreSQL database

### Target technology stack

- Aurora PostgreSQL-Compatible DB instance

### Source architecture

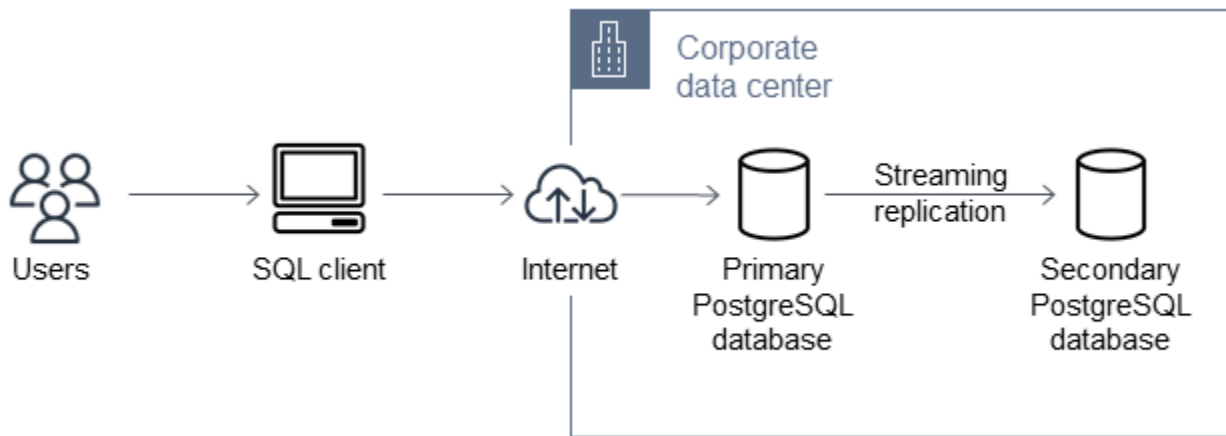

## Target architecture

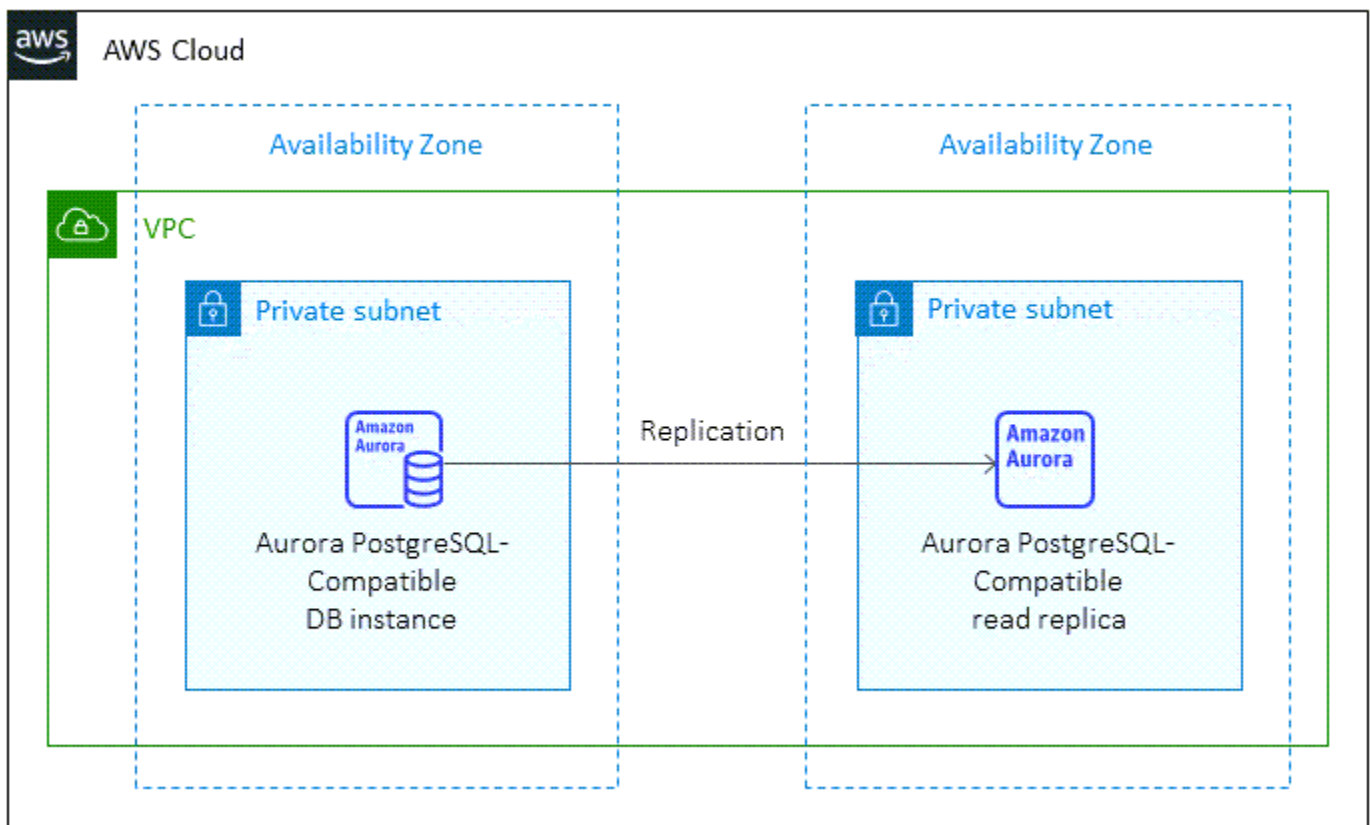

## Data migration architecture

### Using AWS DMS

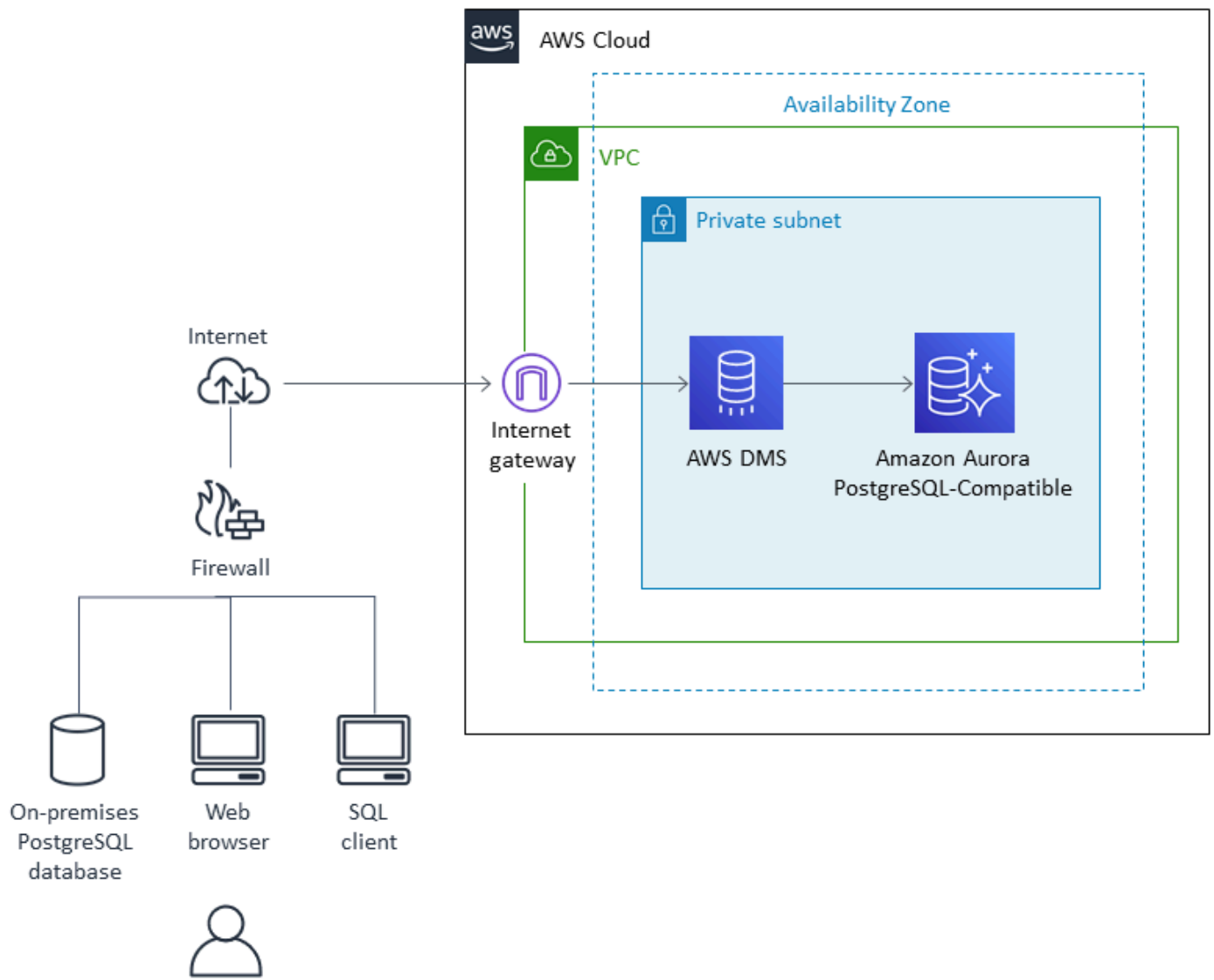

*Using native PostgreSQL tools*

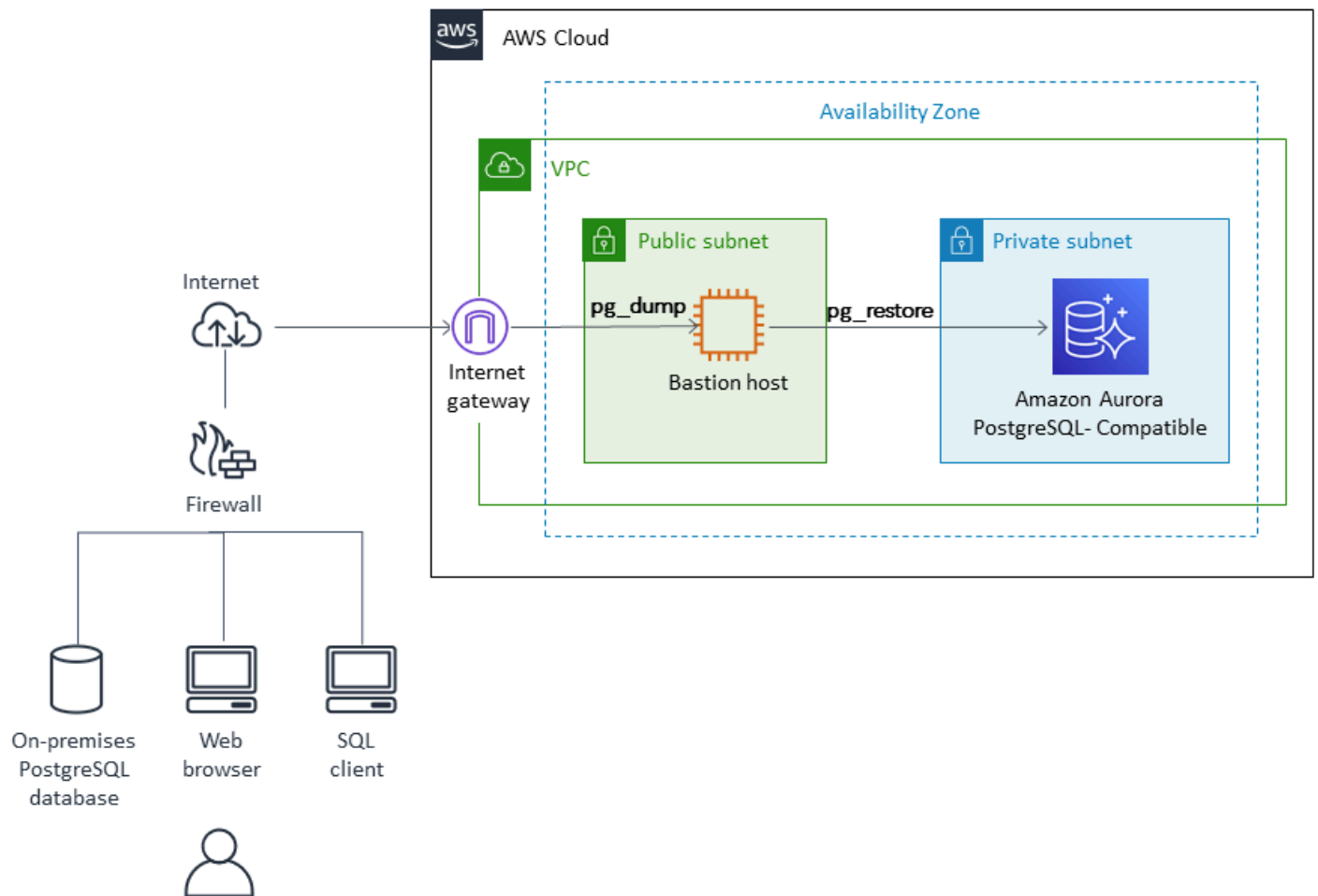

## Tools

- [AWS Database Migration Service \(AWS DMS\)](#) helps you migrate data stores into the AWS Cloud or between combinations of cloud and on-premises configurations. This service supports different sources and target databases. For information about how to validate the PostgreSQL source and target database versions and editions supported for use with AWS DMS, see [Using a PostgreSQL database as an AWS DMS source](#). We recommend that you use the latest version of AWS DMS for the most comprehensive version and feature support.
- Native PostgreSQL tools include [pg\\_dump](#), [pg\\_restore](#), and [psql](#).

## Epics

### Analyze the migration

Task	Description	Skills required
Validate the source and target database versions.	If you are using AWS DMS, make sure that you're using a <a href="#">supported version of PostgreSQL</a> .	DBA
Identify the storage type and capacity requirements.	<ol style="list-style-type: none"> <li>1. Calculate the storage allocated for the source database instance.</li> <li>2. Gather the historical growth metrics for the source database instance.</li> <li>3. Anticipate the future growth forecast for the target database instance.</li> <li>4. Allocate storage by calculating the total number of read and write IOPS on the source database. A General Purpose SSD (gp2) volume provides 3 IOPS for each 1 GB of storage.</li> </ol>	DBA, Systems administrator
Choose the proper instance type, capacity, storage features, and network features.	Determine the compute requirements of the target database instance. Review known performance issues that might need additional attention. Consider the following factors to	DBA, Systems administrator

Task	Description	Skills required
	<p>determine the appropriate instance type:</p> <ul style="list-style-type: none"><li>• CPU utilization of the source database instance</li><li>• IOPS (read and write operations) for the source database instance</li><li>• Memory footprint on the source database instance</li></ul> <p>For more information, see <a href="#">Aurora DB instance classes</a> in the Aurora documentation.</p>	
Identify the network access security requirements for the source and target databases.	Determine the appropriate security groups that would enable the application to talk to the database.	DBA, Systems administrator
Identify the application migration strategy.	<ul style="list-style-type: none"><li>• Determine the migration cutover strategy based on the complexity of your application.</li><li>• Determine the recovery time objective (RTO) and recovery point objective (RPO) for the application, and plan for the cutover accordingly.</li></ul>	DBA, App owner, Systems administrator

## Configure the infrastructure

Task	Description	Skills required
Create a VPC.	Create a new virtual private cloud (VPC) for the target database instance.	Systems administrator
Create security groups.	Create a security group within the VPC (as determined in the previous epic) to allow inbound connections to the database instance.	Systems administrator
Configure and start the Aurora DB cluster.	Create the target database instance with the new VPC and security group and start the instance.	Systems administrator

## Migrate data – option 1 (using AWS DMS)

Task	Description	Skills required
Complete pre-migration steps.	<ol style="list-style-type: none"> <li>1. Clean up the data in the source database.</li> <li>2. <a href="#">Create a replication instance.</a></li> <li>3. <a href="#">Create source and target endpoints.</a></li> <li>4. Identify the number of available tables and objects to be migrated.</li> </ol>	DBA
Complete migration steps.	<ol style="list-style-type: none"> <li>1. Drop foreign key constraints and triggers on the target database.</li> </ol>	DBA



Task	Description	Skills required
	<ol style="list-style-type: none"> <li>2. Drop secondary indexes on the target database.</li> <li>3. Use a <a href="#">full-load task</a> to migrate data from the source to the target database.</li> <li>4. Enable foreign keys.</li> <li>5. If you're using <a href="#">flash-cut migration</a> and your application requires minimal downtime, enable <a href="#">change data capture</a> (CDC) to replicate ongoing changes</li> <li>6. Enable triggers.</li> <li>7. Update sequences.</li> <li>8. Validate the source and target data.</li> </ol>	
Validate data.	To ensure that your data was migrated accurately from the source to the target, follow the <a href="#">data validation steps</a> in the AWS DMS documentation.	DBA

### Migrate data – option 2 (using pg\_dump and pg\_restore)

Task	Description	Skills required
Prepare the source database.	<ol style="list-style-type: none"> <li>1. Create a directory to store pg_dump backup if it doesn't already exist.</li> </ol>	DBA

Task	Description	Skills required
	<ol style="list-style-type: none"><li>2. Create a migration user that has permissions to run <code>pg_dump</code> on database objects.</li><li>3. Connect to the EC2 instance and run <code>pg_dump</code> backup.</li></ol> <p>For more information, see the <a href="#">pg_dump</a> documentation and the <a href="#">walkthrough</a> in the AWS DMS documentation.</p>	
Prepare the target database.	<ol style="list-style-type: none"><li>1. Create a migration user that has permissions to use <code>pg_restore</code> on database objects.</li><li>2. Import the database dump by using <code>pg_restore</code>.</li></ol> <p>For more information, see the <a href="#">pg_restore</a> documentation and the <a href="#">walkthrough</a> in the AWS DMS documentation.</p>	DBA
Validate data.	<ol style="list-style-type: none"><li>1. Compare the database object counts between the source and the target databases.</li><li>2. Resolve any discrepancies found between object counts.</li></ol>	DBA

## Migrate the application

Task	Description	Skills required
Follow the application migration strategy.	Implement the application migration strategy that you created in the first epic.	DBA, App owner, Systems administrator

## Cut over to the target database

Task	Description	Skills required
Switch the application clients over to the new infrastructure.	<ol style="list-style-type: none"><li>1. Stop all application services and client connections that point to the on-premises PostgreSQL database.</li><li>2. <a href="#">Run the AWS DMS tasks.</a></li><li>3. Set up a rollback task (reverse CDC from Aurora PostgreSQL-Compatible to the on-premises PostgreSQL database) if needed.</li><li>4. <a href="#">Validate data.</a></li><li>5. Start the application services on the new target by <a href="#">configuring Amazon Route 53</a> to the new Aurora PostgreSQL-Compatible DB instance.</li><li>6. Add <a href="#">Amazon CloudWatch</a> and <a href="#">Performance Insights</a> monitoring on your new Aurora PostgreSQL-Compatible DB instance.</li></ol>	DBA, App owner, Systems administrator

Task	Description	Skills required
If you need to roll back the migration.	<ol style="list-style-type: none"> <li>1. Stop all application services that point to the Aurora PostgreSQL-Compatible database.</li> <li>2. Roll back the changes to the source on-premises PostgreSQL database by using the AWS DMS task you created in the previous story.</li> <li>3. Stop the AWS DMS tasks running from the on-premises PostgreSQL database to the Aurora PostgreSQL-Compatible database.</li> <li>4. Configure the application so that it points back to the source on-premises PostgreSQL database.</li> <li>5. Confirm that all rollback deployment is complete.</li> </ol>	DBA, App owner

## Close the project

Task	Description	Skills required
Shut down resources.	Shut down the temporary AWS resources.	DBA, Systems administrator
Validate documents.	Review and validate the project documents.	DBA, App owner, Systems administrator

Task	Description	Skills required
Gather metrics.	Gather metrics around time to migrate, percent of manual versus tool cost savings, and so on.	DBA, App owner, Systems administrator
Close the project.	Close the project and provide any feedback.	DBA, App owner, Systems administrator

## Related resources

### References

- [AWS Data Migration Service](#)
- [VPCs and Amazon Aurora](#)
- [Amazon Aurora pricing](#)
- [Using a PostgreSQL database as an AWS DMS source](#)
- [How to create an AWS DMS replication instance](#)
- [How to create source and target endpoints using AWS DMS](#)

### Additional resources

- [Getting Started with AWS DMS](#)
- [Data migration step-by-step walkthroughs](#)
- [Amazon Aurora resources](#)

# Migrate an on-premises Microsoft SQL Server database to Microsoft SQL Server on Amazon EC2 running Linux

Created by Tirumala Dasari (AWS)

<b>Environment:</b> PoC or pilot	<b>Source:</b> Databases: Relational	<b>Target:</b> Amazon EC2 Linux with Microsoft SQL Server
<b>R Type:</b> Replatform	<b>Workload:</b> Microsoft	<b>Technologies:</b> Migration; Databases
<b>AWS services:</b> Amazon EC2		

## Summary

This pattern describes how to migrate from an on-premises Microsoft SQL Server database running on Microsoft Windows, to Microsoft SQL Server on an Amazon Elastic Compute Cloud (Amazon EC2) Linux instance by using backup and restore utilities.

## Prerequisites and limitations

### Prerequisites

- An active AWS account
- Amazon EC2 Linux AMI (Amazon Machine Image) with Microsoft SQL Server
- AWS Direct Connect between on-premises Windows and Microsoft SQL Server on the Linux EC2 instance

## Architecture

### Source technology stack

- On-premises Microsoft SQL Server database

### Target technology stack

- Linux EC2 instance with a Microsoft SQL Server database

## Database migration architecture

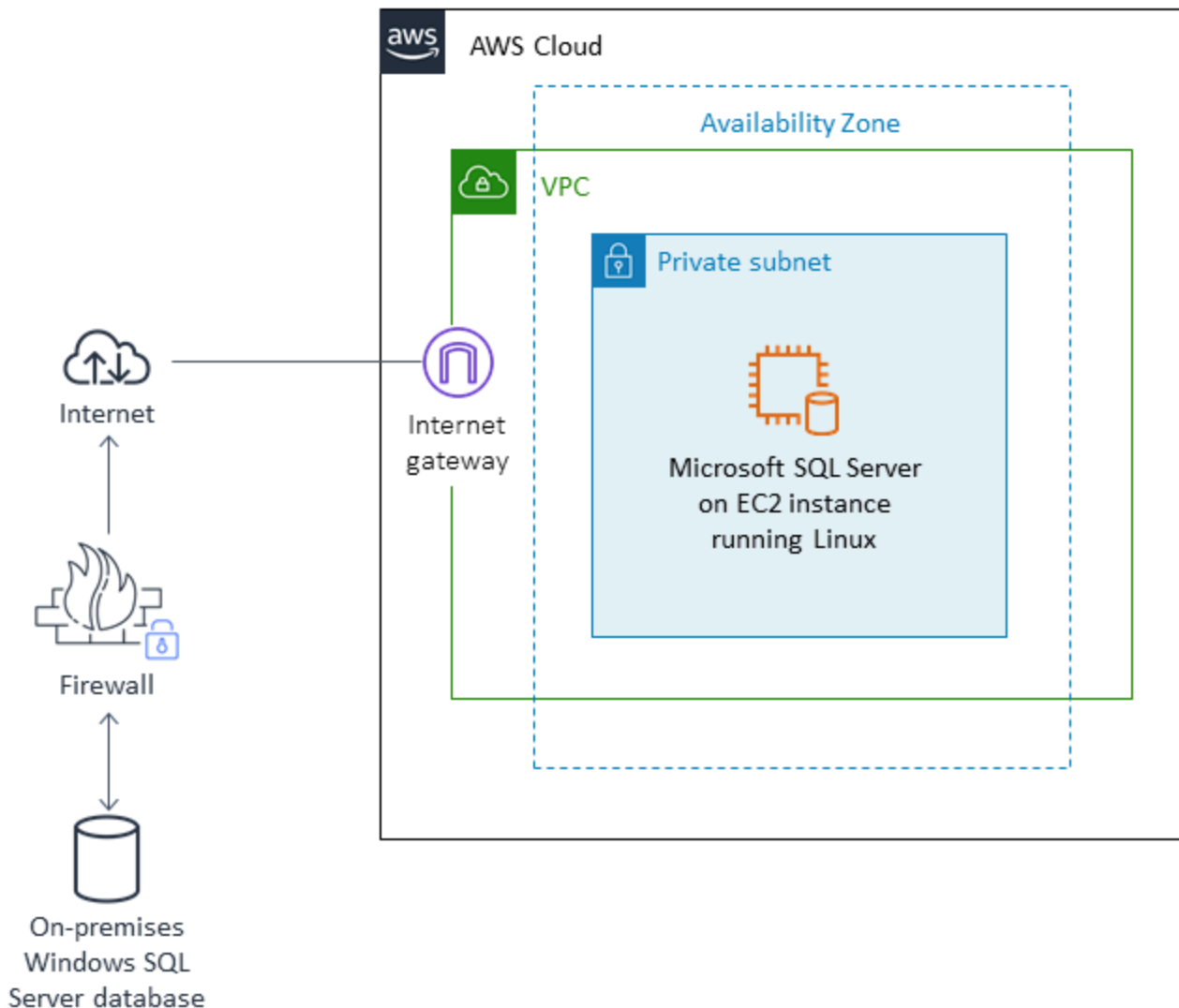

## Tools

- **WinSCP** - This tool enables Windows users to easily share files with Linux users.
- **Sqlcmd** - This command-line utility lets you submit T-SQL statements or batches to local and remote instances of SQL Server. The utility is extremely useful for repetitive database tasks such as batch processing or unit testing.

## Epics

### Prepare the EC2 Linux instance with SQL Server

Task	Description	Skills required
Select an AMI that provides the Linux operating system and includes Microsoft SQL Server.		Sysadmin
Configure the AMI to create an EC2 instance.		Sysadmin
Create inbound and outbound rules for security groups.		Sysadmin
Configure the Linux EC2 instance for a Microsoft SQL Server database.		DBA
Create users and provide permissions as in the source database.		Appowner, DBA
Install SQL Server tools and the sqlcmd utility on the Linux EC2 instance.		DBA

### Back up the database and move backup file to Linux EC2 instance

Task	Description	Skills required
Back up the on-premises SQL Server database.		DBA
Install WinSCP on Microsoft SQL Server.		DBA



Task	Description	Skills required
Move the backup file to the Linux EC2 instance running Microsoft SQL Server.		DBA

### Restore the database on Linux EC2 instance running SQL Server

Task	Description	Skills required
Restore the database from the database backup file by using the sqlcmd utility.		DBA
Validate database objects and data.		Developer, Test engineer

### Cut over from Windows SQL Server to Windows SQL Server on Linux EC2 instance

Task	Description	Skills required
Validate database objects and data.		Developer, Test engineer
Cut over from the on-premises Microsoft SQL Server database to the Linux EC2 instance running Microsoft SQL Server.		DBA

### Related resources

- [How to configure SQL Server 2017 on Amazon Linux and Ubuntu AMIs](#)
- [Installation of SQL tools on a Linux instance](#)

- [Backup and restoration from an on-premises Microsoft SQL Server database to Microsoft SQL Server on a Linux EC2 instance](#)

# Migrate an on-premises Microsoft SQL Server database to Amazon RDS for SQL Server using linked servers

Created by Kevin Yung (AWS), Vishal Singh (AWS), and Viqash Adwani (AWS)

<b>R Type:</b> Replatform	<b>Source:</b> Databases: Relational	<b>Target:</b> Amazon RDS for Microsoft SQL Server
<b>Created by:</b> AWS	<b>Environment:</b> Production	<b>Technologies:</b> Databases; Migration
<b>Workload:</b> Microsoft	<b>AWS services:</b> Amazon RDS	

## Summary

Linked servers enable Microsoft SQL Server to run SQL statements on other instances of database servers. This pattern describes how you can migrate your on-premises Microsoft SQL Server database to Amazon Relational Database Service (Amazon RDS) for Microsoft SQL Server to achieve lower cost and higher availability. Currently, Amazon RDS for Microsoft SQL Server doesn't support connections outside an Amazon Virtual Private Cloud (Amazon VPC) network.

You can use this pattern to achieve the following objectives:

- To migrate Microsoft SQL Server to Amazon RDS for Microsoft SQL Server without breaking linked server capabilities.
- To prioritize and migrate linked Microsoft SQL Server in different waves.

## Prerequisites and limitations

### Prerequisites

- Check whether [Microsoft SQL Server on Amazon RDS](#) supports the features you require.
- Make sure that you can use either [Amazon RDS for Microsoft SQL Server with default collations or collations set over database levels](#).

## Architecture

### Source technology stack

- On-premises databases (Microsoft SQL Server)

### Target technology stack

- Amazon RDS for SQL Server

### Source state architecture

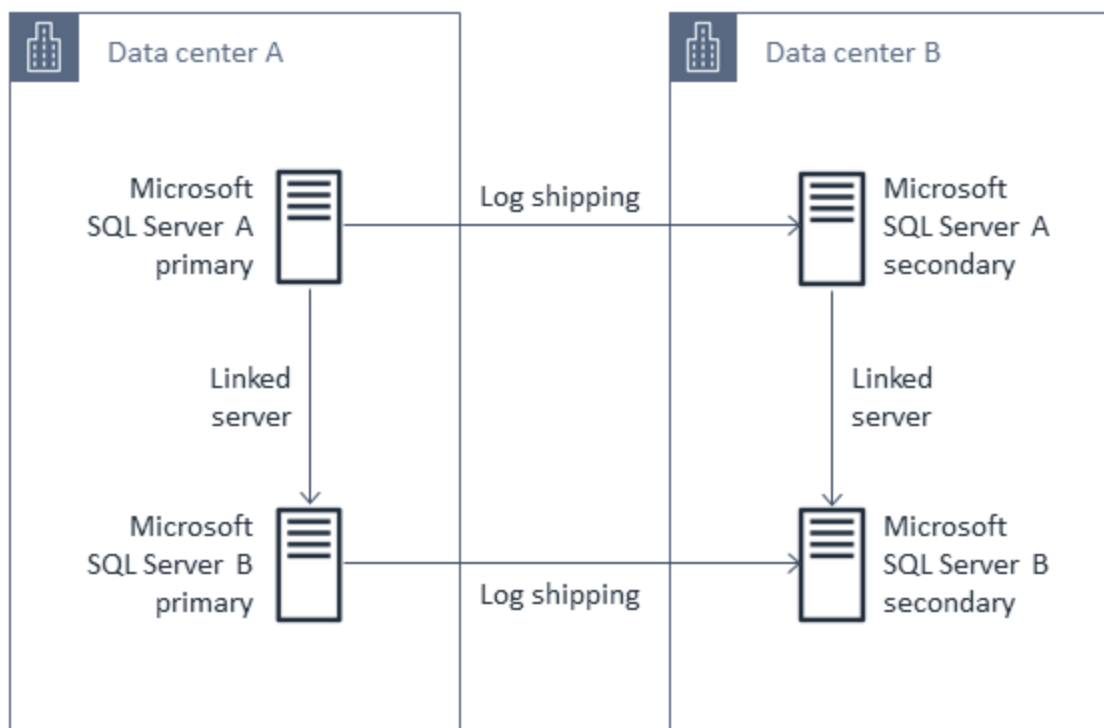

## Target state architecture

In the target state, you migrate Microsoft SQL Server to Amazon RDS for Microsoft SQL Server by using linked servers. This architecture uses a Network Load Balancer to proxy the traffic from Amazon RDS for Microsoft SQL Server to on-premises servers running Microsoft SQL Server. The following diagram shows the reverse proxy capability for the Network Load Balancer.

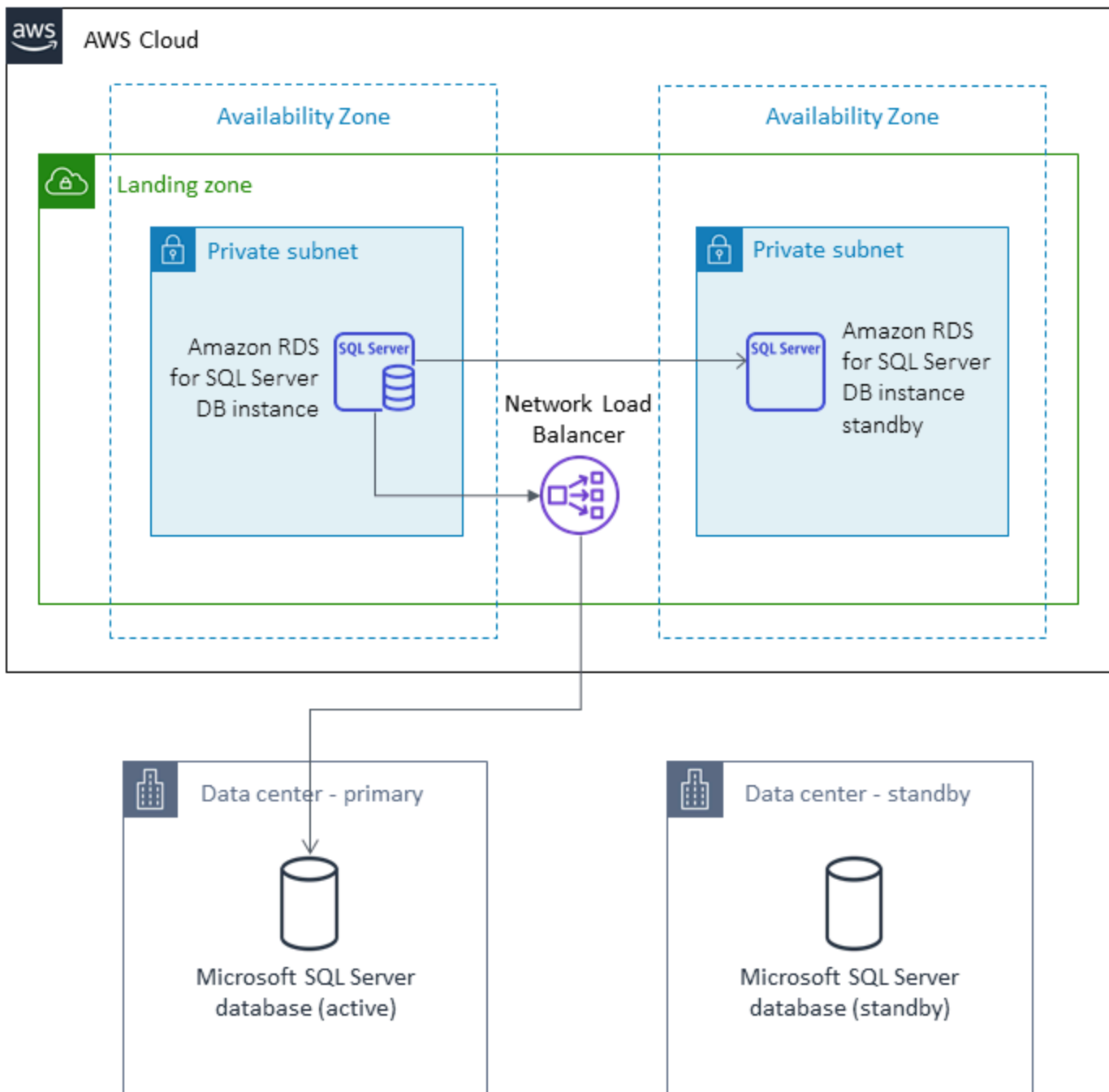

## Tools

- AWS CloudFormation
- Network Load Balancer
- Amazon RDS for SQL Server in multiple Availability Zones (Multi-AZs)
- AWS Database Migration Service (AWS DMS)

## Epics

### Create a landing zone VPC

Task	Description	Skills required
Create the CIDR allocation.		AWS SysAdmin
Create a virtual private cloud (VPC).		AWS SysAdmin
Create the VPC subnets.		AWS SysAdmin
Create the subnet access control lists (ACLs).		AWS SysAdmin
Create the subnet route tables.		AWS SysAdmin
Create a connection with AWS Direct Connect or AWS Virtual Private Network (VPN).		AWS SysAdmin

### Migrate the database to Amazon RDS

Task	Description	Skills required
Create an Amazon RDS for Microsoft SQL Server DB instance.		AWS SysAdmin

Task	Description	Skills required
Create an AWS DMS replication instance.		AWS SysAdmin
Create the source and target database endpoints in AWS DMS.		AWS SysAdmin
Create the migration task and set continuous replication to ON after a full load.		AWS SysAdmin
Request a firewall change to allow Amazon RDS for Microsoft SQL Server to access the on-premises SQL Server databases.		AWS SysAdmin
Create a Network Load Balancer.		AWS SysAdmin
Create a target group that targets the database servers in your data center	We recommend that you use hostnames in the target setup to incorporate data center (DC) failover events.	AWS SysAdmin

Task	Description	Skills required
Run the SQL statement for linked server setup.	Run the SQL statements for adding a linked server by using the Microsoft SQL management tool against the Amazon RDS for Microsoft SQL Server DB instance. In the SQL statement, set @datasrc to use the Network Load Balancer hostname. Add linked server login credentials by using the Microsoft SQL management tool against the Amazon RDS for Microsoft SQL Server DB instance.	AWS SysAdmin
Test and validate the SQL Server functions.		AWS SysAdmin
Create a cutover.		AWS SysAdmin

## Related resources

- [Common Management Tasks for Microsoft SQL Server on Amazon RDS](#)
- [Collations and Character Sets for Microsoft SQL Server](#)
- [Network Load Balancer documentation](#)
- [Implement Linked Servers with Amazon RDS for Microsoft SQL Server \(blog post\)](#)



# Migrate an on-premises Microsoft SQL Server database to Amazon RDS for SQL Server using native backup and restore methods

Created by Tirumala Dasari (AWS), David Queiroz (AWS), and Vishal Singh (AWS)

<b>Environment:</b> PoC or pilot	<b>Source:</b> On-premises SQL Server database	<b>Target:</b> Amazon RDS for SQL Server
<b>R Type:</b> Replatform	<b>Workload:</b> Microsoft	<b>Technologies:</b> Migration; Databases; Operating systems
<b>AWS services:</b> Amazon RDS; Amazon S3		

## Summary

This pattern describes how to migrate an on-premises Microsoft SQL Server database to an Amazon Relational Database Service (Amazon RDS) for SQL Server DB instance (homogeneous migration). The migration process is based on native SQL Server backup and restore methods. It uses SQL Server Management Studio (SSMS) to create a database backup file, and an Amazon Simple Storage Service (Amazon S3) bucket to store the backup file before restoring it in Amazon RDS for SQL Server.

## Prerequisites and limitations

### Prerequisites

- An active AWS account.
- AWS Identity and Access Management (IAM) role policies to access the S3 bucket and the Amazon RDS for SQL Server DB instance.

### Limitations

- The process described in this pattern migrates only the database. SQL logins or database users, including any SQL Server Agent jobs, aren't migrated because they require additional steps.

## Product versions

- SQL Server 2012-2017. For the latest list of supported versions and features, see [Microsoft SQL Server on Amazon RDS](#) in the AWS documentation.

## Architecture

### Source technology stack

- An on-premises Microsoft SQL Server database

### Target technology stack

- Amazon RDS for SQL Server DB instance

### Data migration architecture

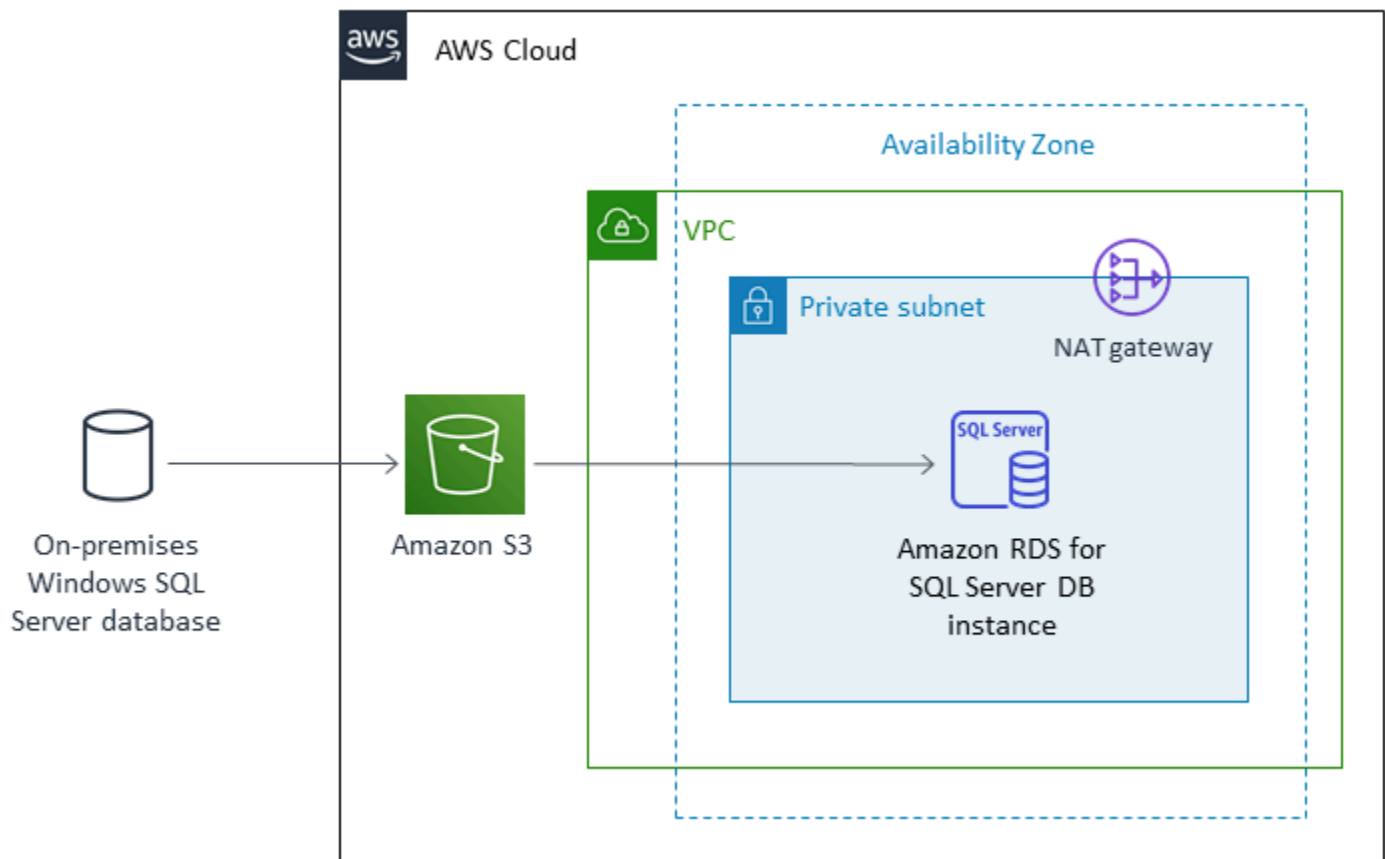

## Tools

- Microsoft SQL Server Management Studio (SSMS) is an integrated environment for managing SQL Server infrastructure. It provides a user interface and a group of tools with rich script editors that interact with SQL Server.

## Epics

### Create an Amazon RDS for SQL Server DB instance

Task	Description	Skills required
Select SQL Server as the database engine in Amazon RDS for SQL Server.		DBA
Choose the SQL Server Express Edition.		DBA
Specify database details.	For more information about creating a DB instance, see the <a href="#">Amazon RDS documentation</a> .	DBA, App owner

### Create a backup file from the on-premises SQL Server database

Task	Description	Skills required
Connect to the on-premises SQL Server database through SSMS.		DBA
Create a backup of the database.	For instructions, see the <a href="#">SSMS documentation</a> .	DBA, App owner

## Upload the backup file to Amazon S3

Task	Description	Skills required
Create a bucket in Amazon S3.	For more information, see the <a href="#">Amazon S3 documentation</a> .	DBA
Upload the backup file to the S3 bucket.	For more information, see the <a href="#">Amazon S3 documentation</a> .	SysOps administrator

## Restore the database in Amazon RDS for SQL Server

Task	Description	Skills required
Add the option group to Amazon RDS.	<ol style="list-style-type: none"> <li>1. Open the Amazon RDS console at <a href="https://console.aws.amazon.com/rds/">https://console.aws.amazon.com/rds/</a>.</li> <li>2. In the navigation pane, choose <b>Option groups</b>, <b>Create group</b>.</li> <li>3. Complete the information for the option group, and then choose <b>Create</b>.</li> <li>4. Add the SQLSERVER_BACKUP_RESTORE option to the option group, and then choose <b>Add option</b>.</li> </ol> <p>For more information, see the <a href="#">Amazon RDS documentation</a>.</p>	SysOps administrator
Restore the database.	<ol style="list-style-type: none"> <li>1. Connect to Amazon RDS for SQL Server through SSMS.</li> </ol>	DBA

Task	Description	Skills required
	2. Call the <code>msdb.dbo.rds_restore_database</code> stored procedure to restore the database.	

## Validate the target database

Task	Description	Skills required
Validate objects and data.	<p>Validate the objects and data between the source database and Amazon RDS for SQL Server.</p> <p><b>Note:</b> This task migrates the database only. Logins and jobs will not be migrated.</p>	App owner, DBA

## Cut over

Task	Description	Skills required
Redirect application traffic.	After validation, redirect application traffic to the Amazon RDS for SQL Server DB instance.	App owner, DBA

## Related resources

- [Amazon S3 documentation](#)
- [Amazon RDS for SQL Server documentation](#)
- [Options for the Microsoft SQL Server Database Engine](#)

# Migrate a Microsoft SQL Server database to Aurora MySQL by using AWS DMS and AWS SCT

Created by Mark Szalkiewicz (AWS) and Pavan Pusuluri (AWS)

<b>R Type:</b> Replatform	<b>Source:</b> Databases: Relational	<b>Target:</b> Amazon Aurora MySQL
<b>Created by:</b> AWS	<b>Environment:</b> PoC or pilot	<b>Technologies:</b> Databases; Migration
<b>Workload:</b> Microsoft	<b>AWS services:</b> Amazon Aurora	

## Summary

This pattern describes how to migrate a Microsoft SQL Server database that is either on premises or on an Amazon Elastic Compute Cloud (Amazon EC2) instance to Amazon Aurora MySQL. The pattern uses AWS Database Migration Service (AWS DMS) and AWS Schema Conversion Tool (AWS SCT) for data migration and schema conversion.

## Prerequisites and limitations

### Prerequisites

- An active AWS account
- A Microsoft SQL Server source database in an on-premises data center or on an EC2 instance
- Java Database Connectivity (JDBC) drivers for AWS SCT connectors, installed on either a local machine or an EC2 instance where AWS SCT is installed

### Limitations

- Database size limit: 64 TB

### Product versions

- Microsoft SQL Server 2008, 2008R2, 2012, 2014, 2016, and 2017 for the Enterprise, Standard, Workgroup, and Developer editions. The Web and Express editions aren't supported by AWS DMS. For the latest list of supported versions, see [Using a Microsoft SQL Server Database as a Source for AWS DMS](#). We recommend that you use the latest version of AWS DMS for the most comprehensive version and feature support. For information about Microsoft SQL Server versions supported by AWS SCT, see the [AWS SCT documentation](#).
- MySQL versions 5.5, 5.6, and 5.7. For the latest list of supported versions, see [Using a MySQL-Compatible Database as a Target for AWS DMS](#).

## Architecture

### Source technology stack

One of the following:

- An on-premises Microsoft SQL Server database
- A Microsoft SQL Server database on an EC2 instance

### Target technology stack

- Aurora MySQL

### Data migration architecture

- From a Microsoft SQL Server database running in the AWS Cloud

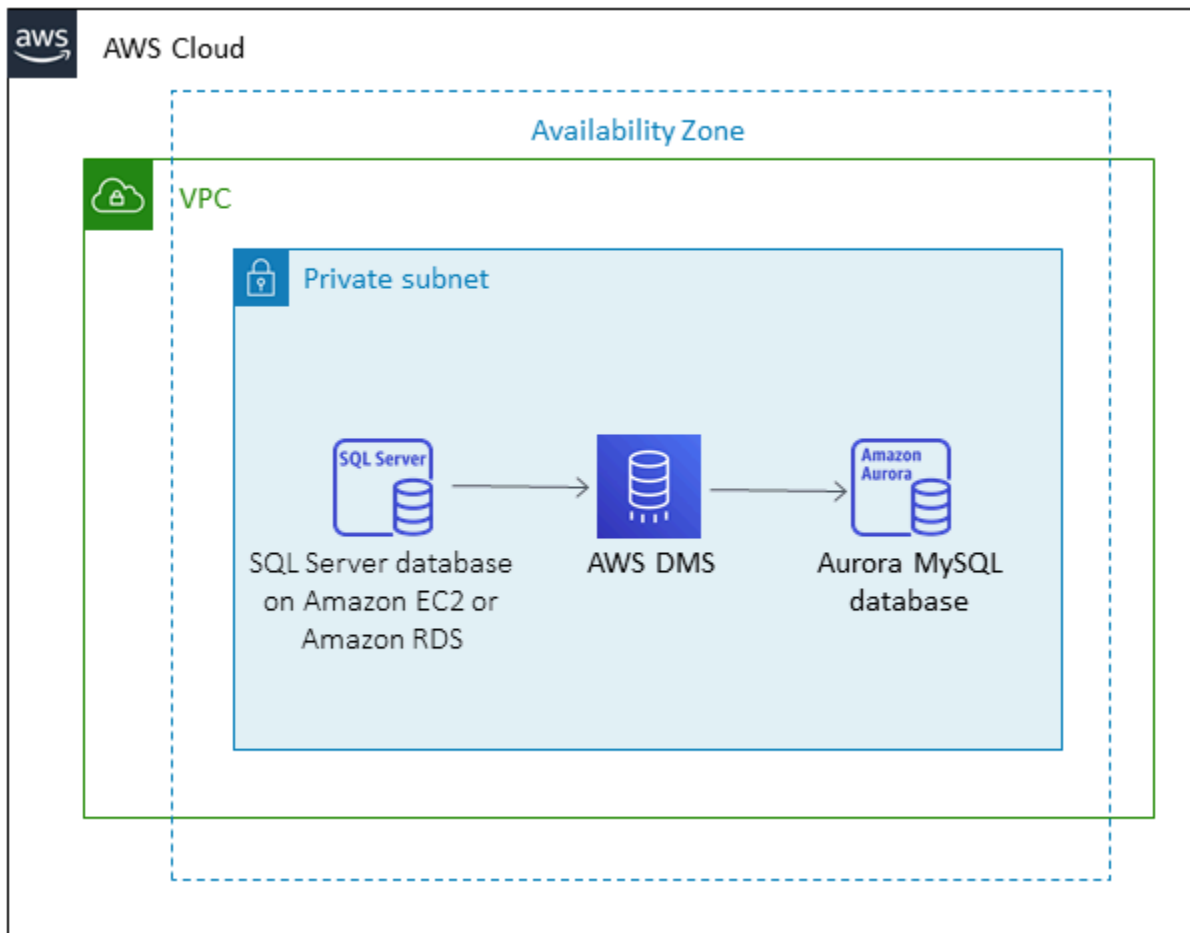

- From a Microsoft SQL Server database running in an on-premises data center



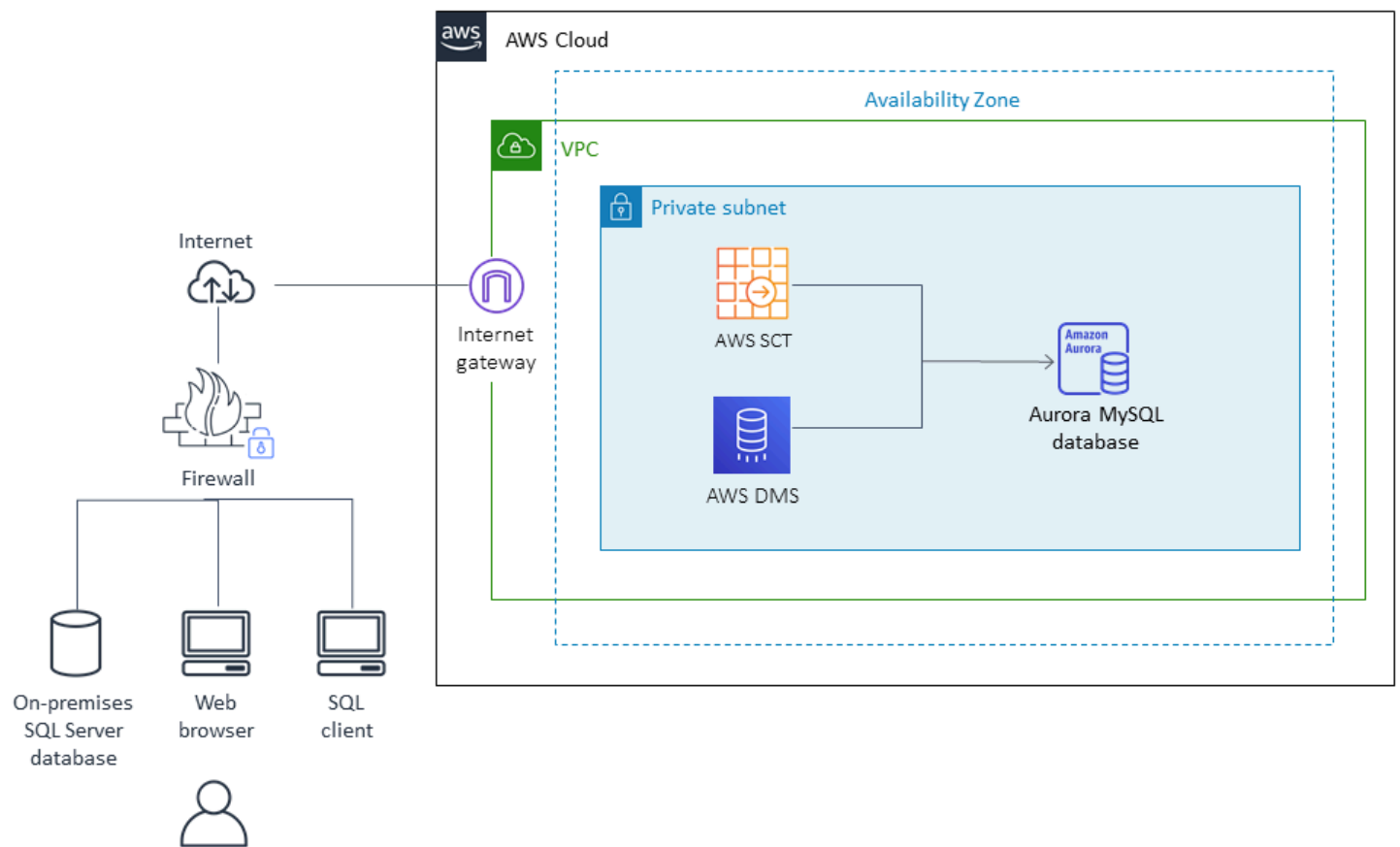

## Tools

- **AWS DMS** - [AWS Data Migration Service](#) (AWS DMS) helps you migrate your data to and from widely used commercial and open-source databases, including Oracle, SQL Server, MySQL, and PostgreSQL. You can use AWS DMS to migrate your data into the AWS Cloud, between on-premises instances (through an AWS Cloud setup), or between combinations of cloud and on-premises setups.
- **AWS SCT** - [AWS Schema Conversion Tool](#) (AWS SCT) makes heterogeneous database migrations easy by automatically converting the source database schema and a majority of the custom code to a format compatible with the target database.

## Epics

### Prepare for the migration

Task	Description	Skills required
Validate the source and target database version and engine.		DBA
Create an outbound security group for the source and target databases.		SysAdmin
Create and configure an EC2 instance for AWS SCT, if required.		DBA
Download the latest version of AWS SCT and associated drivers.		DBA
Add and validate the prerequisite users and grants in the source database.		DBA
Create an AWS SCT project for the workload and connect to the source database.		DBA
Generate an assessment report and evaluate feasibility.		DBA

## Prepare the target database

Task	Description	Skills required
Create a target Amazon RDS DB instance, using Amazon Aurora as the database engine.		DBA
Extract the list of users, roles, and grants from the source.		DBA
Map the existing database users to the new database users.		App owner
Create users in the target database.		DBA
Apply roles from the previous step to the target database.		DBA
Review the database options, parameters, network files, and database links in the source database, and then evaluate their applicability to the target database.		DBA
Apply any relevant settings to the target.		DBA

## Transfer objects

Task	Description	Skills required
Configure AWS SCT connectivity to the target database.		DBA

Task	Description	Skills required
Convert the schema using AWS SCT.	AWS SCT automatically converts the source database schema and most of the custom code to a format that is compatible with the target database. Any code that the tool cannot convert automatically is clearly marked so that you can convert it yourself.	DBA
Review the generated SQL report and save any errors and warnings.		DBA
Apply automated schema changes to the target or save them as a .sql file.		DBA
Validate that AWS SCT created the objects on the target.		DBA
Manually rewrite, reject, or redesign any items that failed to convert automatically.		DBA
Apply the generated role and user grants and review any exceptions.		DBA

## Migrate the data

Task	Description	Skills required
Determine the migration method.		DBA
Create a replication instance from the AWS DMS console.	For detailed information on using AWS DMS, see the links in the "Related resources" section.	DBA
Create the source and target endpoints.		DBA
Create a replication task.		DBA
Start the replication task and monitor the logs.		DBA

## Migrate the application

Task	Description	Skills required
Use AWS SCT to analyze and convert the SQL items within the application code.	When you convert your database schema from one engine to another, you also need to update the SQL code in your applications to interact with the new database engine instead of the old one. You can view, analyze, edit, and save the converted SQL code. For detailed information on using AWS SCT, see the links in the "Related resources" section.	App owner

Task	Description	Skills required
Create the new application servers on AWS.		App owner
Migrate the application code to the new servers.		App owner
Configure the application server for the target database and drivers.		App owner
Fix any code that's specific to the source database engine in the application.		App owner
Optimize the application code for the target engine.		App owner

## Cut over

Task	Description	Skills required
Apply any new users, grants, and code changes to the target.		DBA
Lock the application for any changes.		App owner
Validate that all changes were propagated to the target database.		DBA
Point the new application server to the target database.		App owner
Recheck everything.		App owner

Task	Description	Skills required
Go live.		App owner

## Close the project

Task	Description	Skills required
Shut down the temporary AWS resources (AWS DMS replication instance and EC2 instance used for AWS SCT).		DBA, App owner
Update feedback on the AWS DMS process for internal teams.		DBA, App owner
Revise the AWS DMS process and improve the template if necessary.		DBA, App owner
Review and validate the project documents.		DBA, App owner
Gather metrics around time to migrate, percent of manual versus tool cost savings, and so on.		DBA, App owner
Close the project and provide any feedback.		DBA, App owner

## Related resources

### References

- [AWS DMS User Guide](#)

- [AWS SCT User Guide](#)
- [Amazon Aurora Pricing](#)

## **Tutorials and videos**

- [Getting Started with AWS Database Migration Service](#)
- [Getting Started with the AWS Schema Conversion Tool](#)
- [Amazon RDS resources](#)
- [AWS DMS Step-by-Step Walkthroughs](#)



# Migrate an on-premises MariaDB database to Amazon RDS for MariaDB using native tools

Created by Shyam Sunder Rakhecha (AWS)

<b>Environment:</b> PoC or pilot	<b>Source:</b> Databases: Relational	<b>Target:</b> Amazon RDS for MariaDB
<b>R Type:</b> Replatform	<b>Workload:</b> Open-source	<b>Technologies:</b> Migration; Databases

## Summary

This pattern provides guidance for migrating an on-premises MariaDB database to Amazon Relational Database Service (Amazon RDS) for MariaDB by using native tools. If you have MySQL tools installed, you can use **mysql** and **mysqldump**. If you have MariaDB tools installed, you can use **mariadb** and **mariadb-dump**. MySQL and MariaDB tools have the same origin, but there are minor differences in MariaDB version 10.6 and later.

## Prerequisites and limitations

### Prerequisites

- An active AWS account
- A MariaDB source database in an on-premises data center

### Limitations

- Database size limit: 64 TB

### Product versions

- MariaDB versions 10.0-10.6 (for the latest list of supported versions, see [MariaDB on Amazon RDS](#) in the AWS documentation)

## Architecture

### Source technology stack

- MariaDB database in an on-premises data center

### Target technology stack

- Amazon RDS for MariaDB DB instance

### Target architecture

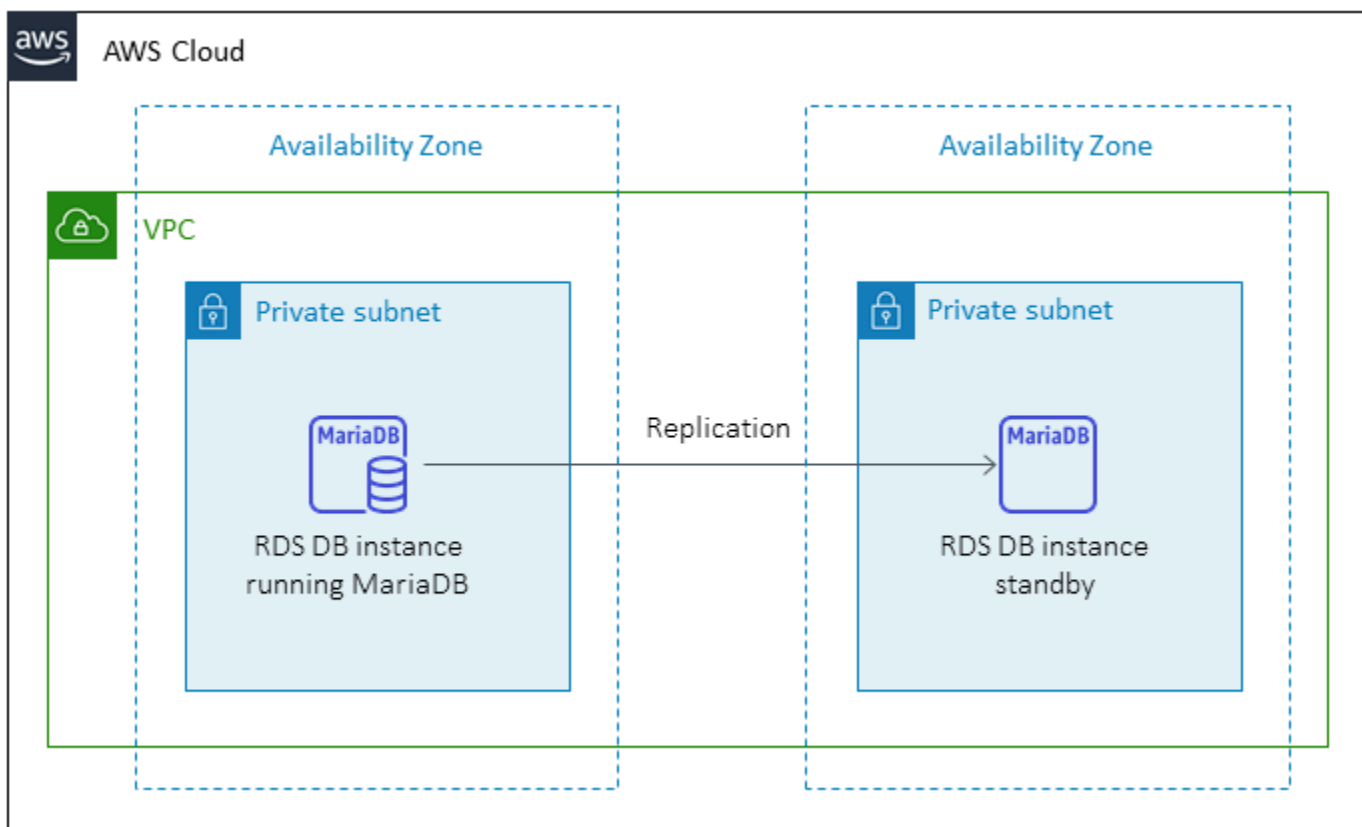

### Data migration architecture

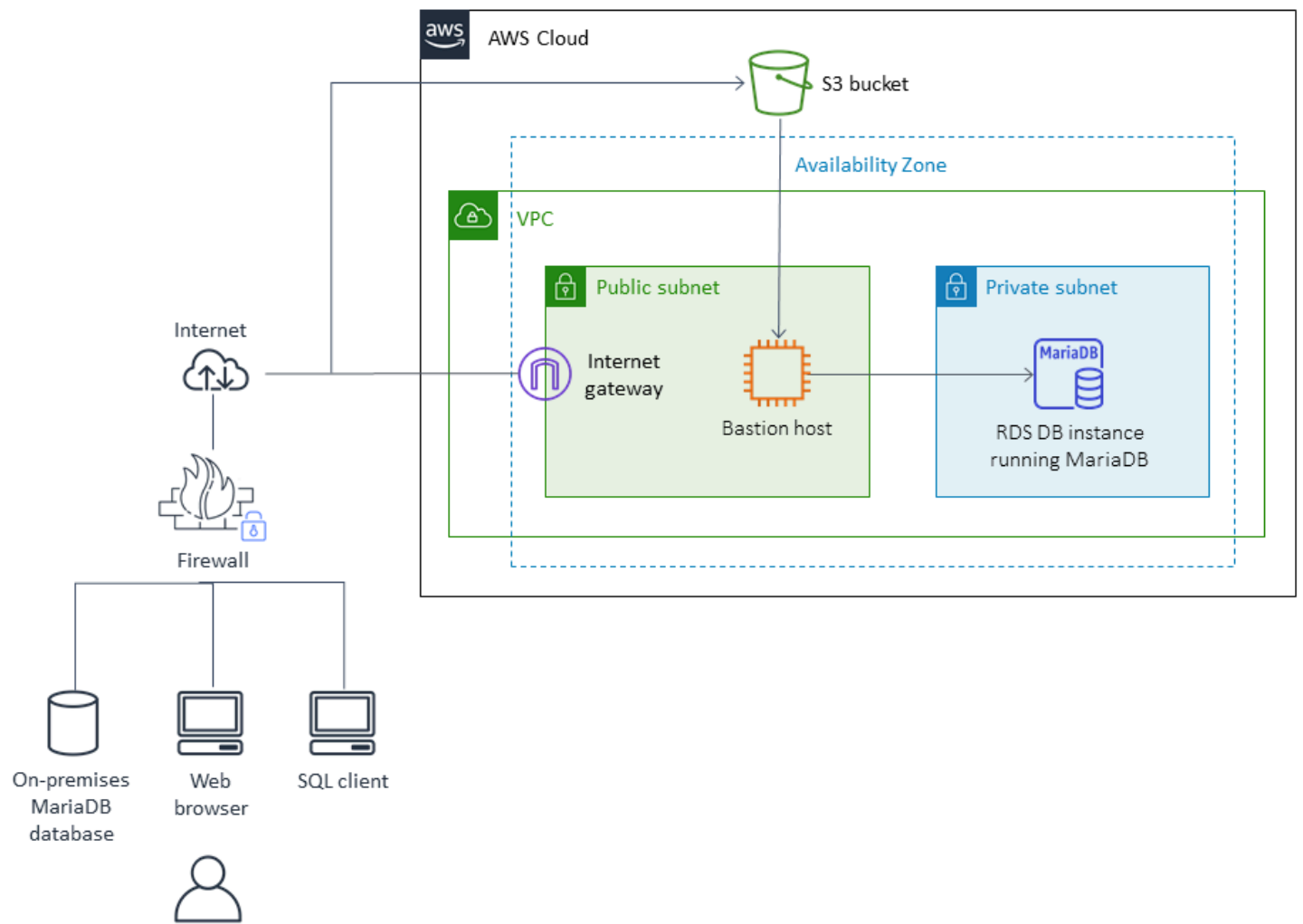

## Tools

- Native MySQL tools: **mysql** and **mysqldump**
- Native MariaDB tools: **mariadb** and **mariadb-dump**

## Epics

### Plan the migration

Task	Description	Skills required
Validate source and target database versions and engines.		DBA

Task	Description	Skills required
Identify hardware requirements for the target server instance.		DBA, Systems administrator
Identify storage requirements (storage type and capacity).		DBA, Systems administrator
Choose the proper instance type based on capacity, storage features, and network features.		DBA, Systems administrator
Identify the network access security requirements for source and target databases.		DBA, Systems administrator
Identify the application migration strategy.		DBA, App owner, Systems administrator

## Configure the infrastructure

Task	Description	Skills required
Create a virtual private cloud (VPC).		Systems administrator
Create security groups.		Systems administrator
Configure and start an Amazon RDS DB instance running MariaDB.		Systems administrator

## Migrate data

Task	Description	Skills required
Use native tools to migrate database objects and data.	In the source database, use <b>mysqldump</b> or <b>mariadb-dump</b> to create an output file that contains database objects and data. In the target database, use <b>mysql</b> or <b>mariadb</b> to restore the data.	DBA
Validate the data.	Check the source and target databases to confirm that the data migration was successful.	DBA

## Migrate the application

Task	Description	Skills required
Follow the application migration strategy.		DBA, App owner, Systems administrator

## Cut over

Task	Description	Skills required
Switch the application clients over to the new infrastructure.		DBA, App owner, Systems administrator

## Close the project

Task	Description	Skills required
Shut down the temporary AWS resources.		Systems administrator
Review and validate the project documents.		DBA, App owner, Systems administrator
Gather metrics around time to migrate, cost savings provided by tools, and so on.		DBA, App owner, Systems administrator
Close out the project and provide feedback.		DBA, App owner, Systems administrator

## Related resources

### Amazon RDS references

- [Amazon RDS for MariaDB](#)
- [Amazon Virtual Private Cloud VPCs and Amazon RDS](#)
- [Amazon RDS Multi-AZ Deployments](#)
- [Amazon RDS Pricing](#)

### MySQL and MariaDB references

- [mariadb-dump/mysqldump](#)
- [mysql Command-line Client](#)

### Tutorials and videos

- [Getting Started with Amazon RDS](#)

# Migrate an on-premises MySQL database to Aurora MySQL

Created by Vinod Kumar Sadu (AWS) and Igor Obradovic (AWS)

<b>Environment:</b> Production	<b>Source:</b> On-premises MySQL database	<b>Target:</b> Amazon Aurora MySQL-Compatible Edition
<b>R Type:</b> Replatform	<b>Workload:</b> Open-source	<b>Technologies:</b> Migration; Databases
<b>AWS services:</b> AWS DMS		

## Summary

This pattern explains how to migrate an on-premises MySQL source database to Amazon Aurora MySQL-Compatible Edition. It describes two options for migration: using AWS Database Migration Service (AWS DMS) or using native MySQL tools such as **mysqldbcopy** and **mysqldump**.

## Prerequisites and limitations

### Prerequisites

- An active AWS account
- A source MySQL database in an on-premises data center

### Limitations

- Database size limit: 64 TB

### Product versions

- MySQL versions 5.7 and 8.0. For the latest list of supported versions, see [Amazon Aurora versions](#) in the AWS documentation. If you're using AWS DMS, see also [Using a MySQL-Compatible Database as a Target for AWS DMS](#) for MySQL versions supported by AWS DMS.

## Architecture

### Source technology stack

- An on-premises MySQL database

### Target technology stack

- Amazon Aurora MySQL-Compatible Edition

### Target architecture

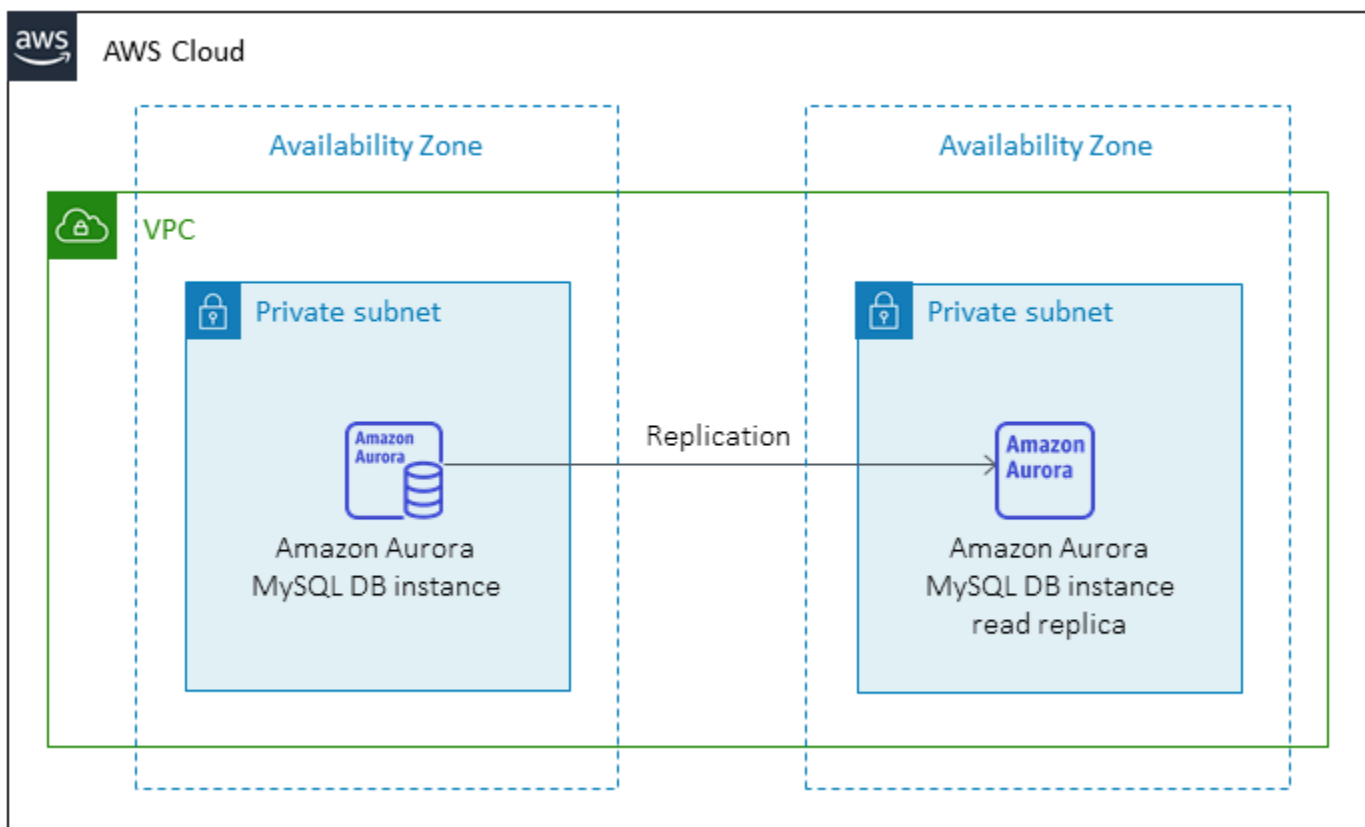

### Data migration architecture

*Using AWS DMS:*



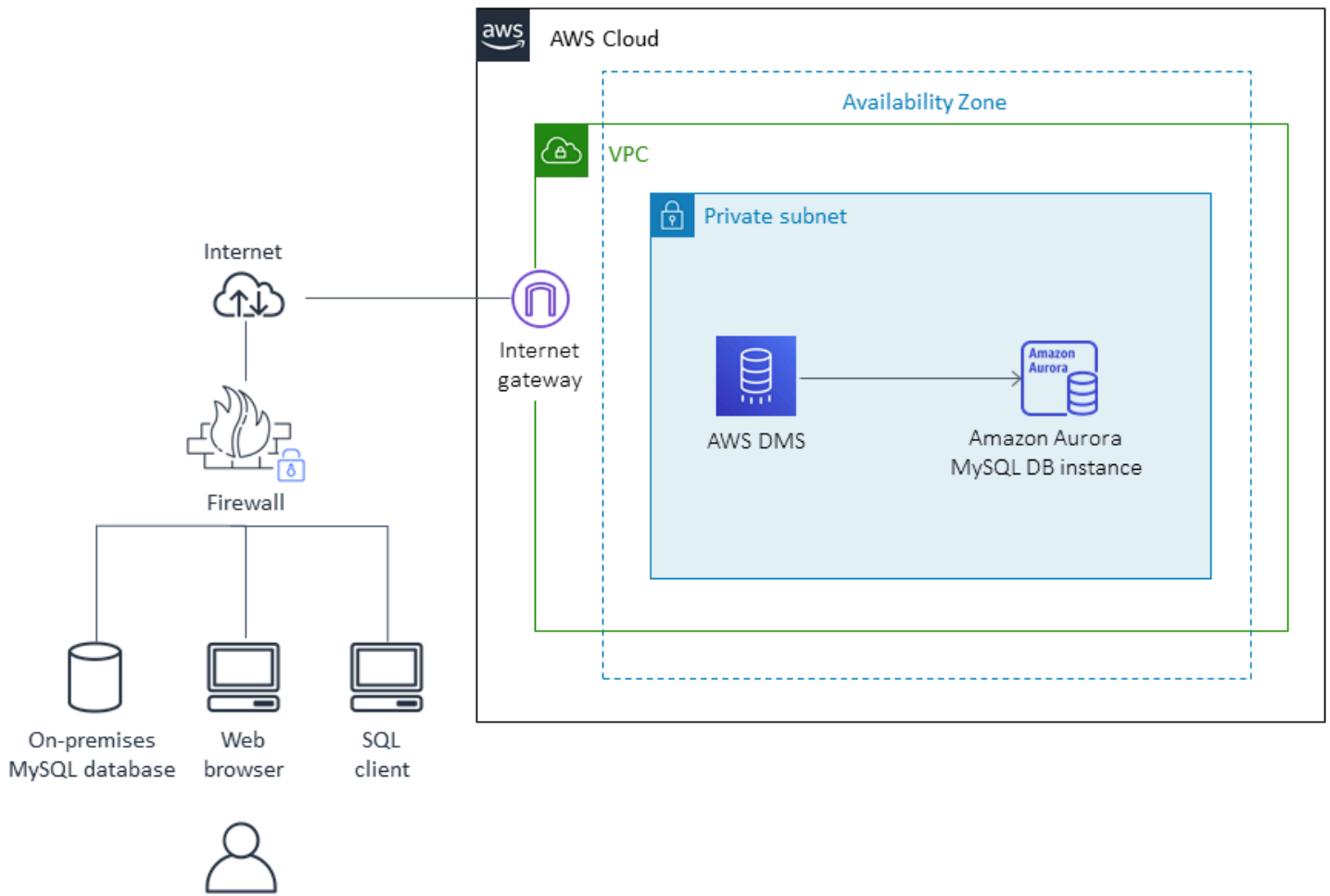

*Using native MySQL tools:*

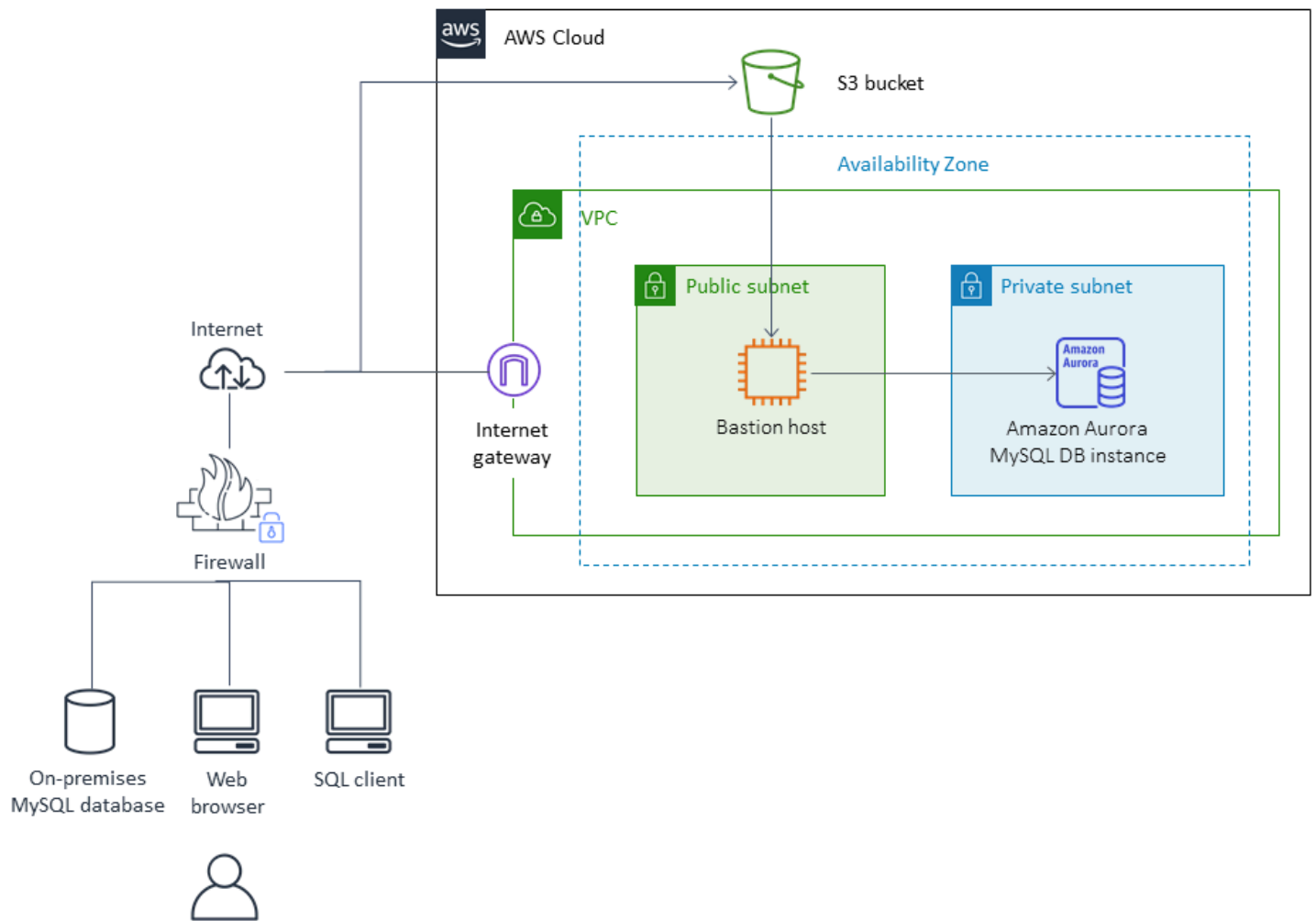

## Tools

- [AWS Database Migration Service \(AWS DMS\)](#) supports several source and target databases. For information about MySQL source and target databases supported by AWS DMS, see [Migrating MySQL-Compatible Databases to AWS](#). We recommend that you use the latest version of AWS DMS for the most comprehensive version and feature support.
- [mysqldbcopy](#) is a MySQL utility that copies a MySQL database on a single server or between servers.
- [mysqldump](#) is a MySQL utility that creates a dump file from a MySQL database for backup or migration purposes.

## Epics

### Plan the migration

Task	Description	Skills required
Validate the source and target database version and engine.		DBA
Identify hardware requirements for the target server instance.		DBA, Systems administrator
Identify storage requirements (storage type and capacity).		DBA, Systems administrator
Choose proper instance type based on capacity, storage features, and network features.		DBA, Systems administrator
Identify the network access security requirements for source and target databases.		DBA, Systems administrator
Identify the application migration strategy.		DBA, App owner, Systems administrator

### Configure the infrastructure

Task	Description	Skills required
Create a virtual private cloud (VPC).		Systems administrator
Create security groups.		Systems administrator

Task	Description	Skills required
Configure and start an Aurora MySQL-Compatible DB cluster.		Systems administrator

### Migrate data - option 1

Task	Description	Skills required
Use native MySQL tools or third-party tools to migrate database objects and data.	For instructions, see the documentation for MySQL tools such as <a href="#">mysqldbcopy</a> and <a href="#">mysqldump</a> .	DBA

### Migrate data - option 2

Task	Description	Skills required
Migrate data with AWS DMS.	For instructions, see <a href="#">Using a MySQL-compatible database as a source</a> and <a href="#">Using a MySQL-compatible database as a target</a> in the AWS DMS documentation.	DBA

### Migrate the application

Task	Description	Skills required
Follow the application migration strategy.		DBA, App owner, Systems administrator

## Cut over

Task	Description	Skills required
Switch the application clients over to the new infrastructure.		DBA, App owner, Systems administrator

## Close the project

Task	Description	Skills required
Shut down temporary AWS resources.		DBA, Systems administrator
Review and validate the project documents.		DBA, App owner, Systems administrator
Gather metrics around time to migrate, % of manual vs. tool, cost savings, etc.		DBA, App owner, Systems administrator
Close out the project and provide feedback.		

## Related resources

### References

- [Migrating Your Databases to Amazon Aurora](#)
- [AWS DMS website](#)
- [AWS DMS documentation](#)
- [Amazon Aurora Pricing](#)
- [Creating and connecting to an Aurora MySQL DB cluster](#)
- [Amazon Virtual Private Cloud VPCs and Amazon RDS](#)
- [Amazon Aurora documentation](#)

## Tutorials and videos

- [Getting Started with AWS DMS](#)
- [Getting Started with Amazon Aurora](#)

# Migrate on-premises MySQL databases to Aurora MySQL using Percona XtraBackup, Amazon EFS, and Amazon S3

Created by Rohan Jamadagni (AWS), sajith menon (AWS), and Udayasimha Theepireddy (AWS)

<b>Source:</b> On-premises	<b>Target:</b> Aurora MySQL	<b>R Type:</b> Replatform
<b>Environment:</b> Production	<b>Technologies:</b> Databases; Migration	<b>Workload:</b> Open-source
<b>AWS services:</b> Amazon S3; Amazon Aurora; Amazon EFS		

## Summary

This pattern describes how to migrate large, on-premises MySQL databases efficiently to Amazon Aurora MySQL by using Percona XtraBackup. Percona XtraBackup is an open-source, non-blocking backup utility for MySQL-based servers. The pattern shows how to use Amazon Elastic File System (Amazon EFS) to reduce the time to upload the backup to Amazon Simple Storage Service (Amazon S3) and to restore the backup to Amazon Aurora MySQL. The pattern also provides details on how to make incremental Percona backups to minimize the number of binary logs to be applied to the target Aurora MySQL database.

## Prerequisites and limitations

### Prerequisites

- An active AWS account
- Permissions to create AWS Identity and Access Management (IAM) roles and policies
- Network connectivity between the on-premises MySQL database and the virtual private cloud (VPC) on AWS

### Limitations

- The source servers must be Linux-based systems that can install a Network File System (NFS) client (nfs-utils/nfs-common).

- The S3 bucket used for uploading backup files supports server-side encryption (SSE-S3/SSE-KMS) only.
- Amazon S3 limits the size of the backup files to 5 TB. If your backup file exceeds 5 TB, you can split it into multiple, smaller files.
- The number of source files uploaded to the S3 bucket cannot exceed one million files.
- The pattern supports Percona XtraBackup full backup and incremental backup only. It doesn't support partial backups that use `--tables`, `--tables-exclude`, `--tables-file`, `--databases`, `--databases-exclude`, or `--databases-file`.
- Aurora doesn't restore users, functions, stored procedures, or time zone information from the source MySQL database.

### Product versions

- The source database must be MySQL version 5.5, 5.6, or 5.7.
- For MySQL 5.7, you must use Percona XtraBackup 2.4.
- For MySQL 5.6 and 5.6, you must use Percona XtraBackup 2.3 or 2.4.

## Architecture

### Source technology stack

- Linux-based operating system
- MySQL server
- Percona XtraBackup

### Target technology stack

- Amazon Aurora
- Amazon S3
- Amazon EFS

### Target architecture



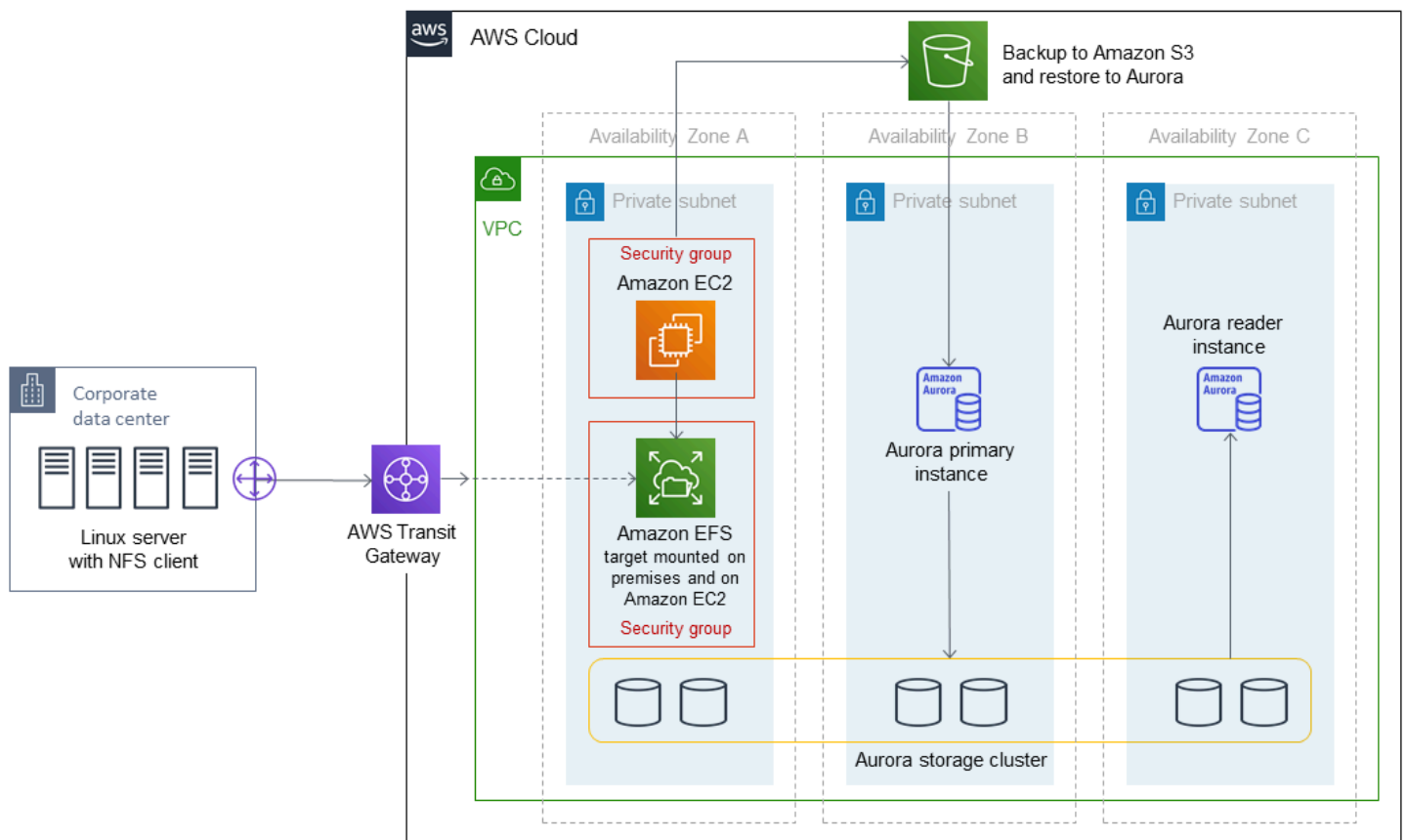

## Tools

### AWS services

- [Amazon Aurora](#) is a fully managed relational database engine that makes it simple and cost-effective to set up, operate, and scale MySQL deployments. Aurora MySQL is a drop-in replacement for MySQL.
- [Amazon Elastic File System \(Amazon EFS\)](#) helps you create and configure shared file systems in the AWS Cloud.
- [Amazon Simple Storage Service \(Amazon S3\)](#) is a cloud-based object storage service that helps you store, protect, and retrieve any amount of data.

### Other tools

- [Percona XtraBackup](#) is an open-source utility that performs streaming, compressed, and incremental backups of MySQL databases without disrupting or blocking your databases.

## Epics

### Create an Amazon EFS file system

Task	Description	Skills required
Create a security group to associate with Amazon EFS mount targets.	Create a security group in the VPC that is configured with a VPN attachment to the on-premises database over AWS Transit Gateway. For more information about the commands and steps described in this and other stories, see the links in the "Related resources" section at the end of this pattern.	AWS DevOps/database administrator
Edit the security group rules.	Add an inbound rule, using type NFS, port 2049, and the IP range of the on-premises database server as the source. By default, the outbound rule allows all the traffic to leave. If this is not the case, add an outbound rule to open a connection for the NFS port. Add two more inbound rules: port 2049 (source: security group ID of this same security group) and port 22 (source: IP range from where you will connect to an EC2 instance).	AWS DevOps/database administrator
Create a file system.	In the mount targets, use the VPC and security group you created in the previous story. Choose the throughput	AWS DevOps/database administrator

Task	Description	Skills required
	mode and performance based on the I/O requirements of the on-premises database. Optionally, enable encryption at rest.	

## Mount the file system

Task	Description	Skills required
Create an IAM instance profile role to be associated with an EC2 instance.	Create an IAM role that has permissions to upload and access objects in Amazon S3. Choose the S3 bucket where the backup will be stored as a policy resource.	AWS DevOps
Create an EC2 instance.	Launch an Linux-based EC2 instance and attach the IAM instance profile role that you created in the previous step, and the security group you created earlier.	AWS DevOps
Install the NFS client.	Install the NFS client on the on-premises database server and on the EC2 instance. For installation instructions, see the "Additional information" section.	DevOps
Mount the Amazon EFS file system.	Mount the Amazon EFS file system on premises and on the EC2 instance. On each server, create a directory	DevOps

Task	Description	Skills required
	for storing the backup, and mount the file system by using the mount target endpoint. For an example, see the "Additional information" section.	

## Make a backup of the MySQL source database

Task	Description	Skills required
Install Percona XtraBackup.	Install Percona XtraBackup 2.3 or 2.4 (depending on the version of your MySQL database) on the on-premises database server. For installation links, see the "Related resources" section.	Database administrator
Count the schemas and tables in the source database.	Gather and note the number of schemas and objects in the source MySQL database. You will use these counts to validate the Aurora MySQL database after migration.	Database administrator
(Optional) Note the latest binary log sequence from the source database.	Perform this step if you want to establish binary log replication between the source database and Aurora MySQL to minimize downtime. log-bin must be enabled, and server_id must be unique. Note the current binary log sequence from the	Database administrator

Task	Description	Skills required
	<p>source database, just before initiating a backup. Perform this step just before full backup if you're planning to use only full backup. If you're planning to make incremental backups after a full backup, perform this step just before the final incremental backup that you will restore on the Aurora MySQL DB instance.</p>	
<p>Start a full backup of the source MySQL database.</p>	<p>Make a full backup of the MySQL source database using Percona XtraBackup. For example commands for full and incremental backups, see the "Additional information" section.</p>	<p>Database administrator</p>

Task	Description	Skills required
(Optional) Make incremental backups using Percona XtraBackup.	<p>Incremental backups can be used to reduce the amount of binary logs you need to apply to sync the source database with Aurora MySQL. Large-size and transaction-heavy databases might generate a large number of binary logs during backups. By taking incremental backups and storing them on a shared Amazon EFS file system, you can significantly reduce the time for backing up and uploading your database. For details, see the "Additional information" section. Continue to make incremental backups until you're ready to begin the migration process to Aurora.</p>	Database administrator

Task	Description	Skills required
Prepare backups.	In this step, transactional logs are applied to the backup for transactions that were in flight during the backup. Continue to apply transactional logs (--apply-log-only) to each incremental backup to merge the backups, except for the last backup. For examples, see the "Additional information" section. After this step, the complete, merged backup will be in ~/<efs_mount_name>/fullbackup.	Database administrator
Zip and split the final merged backup.	After you prepare the final, merged backup, use tar, zip, and split commands to create smaller zipped files of the backup. For examples, see the "Additional information" section.	Database administrator

### Restore the backup to an Aurora MySQL DB cluster

Task	Description	Skills required
Upload the backup to Amazon S3.	The Amazon EFS file system where the backup files are stored is mounted on both the on-premises database and an EC2 instance, so the backup files are readily	AWS DevOps

Task	Description	Skills required
	<p>available to the EC2 instance. Connect to the EC2 instance by using Secure Shell (SSH) and upload the zipped backup files to a new or existing S3 bucket; for example: <code>aws s3 sync ~/&lt;efs_mount_name&gt;/fullbackup s3://&lt;bucket_name&gt;/fullbackup</code>. For additional details, see the links in the "Related resources" section.</p>	
Create a service role for Aurora to access Amazon S3.	Create an IAM role with trust "rds.amazonaws.com" and a policy that will enable Aurora to access the S3 bucket where the backup files are stored. The required permissions are ListBucket, GetObject, and GetObjectVersion.	AWS DevOps



Task	Description	Skills required
Create the networking configuration for Aurora.	Create a cluster DB subnet group with at least two Availability Zones and a subnet route table configuration that allows outbound connectivity to the source database. Create a security group that allows outbound connections to the on-premises database, and allows administrators to connect to the Aurora DB cluster. For more information, see the links in the "Related resources" section.	AWS DevOps/database administrator
Restore the backup to an Aurora MySQL DB cluster.	Restore your data from the backup that you uploaded to Amazon S3. Specify the MySQL version of your source database, provide the S3 bucket name and folder path prefix where you uploaded the backup file (for example, "fullbackup" for the examples in the "Additional information" section), and provide the IAM role you created to authorize Aurora to access Amazon S3.	AWS DevOps/database administrator

Task	Description	Skills required
Validate the Aurora MySQL database.	Validate the count of schema and objects in the restored Aurora DB cluster against the count you obtained from the source database.	Database administrator
Set up binlog replication.	Use the binary log sequence that you noted earlier, before making the last backup that was restored to the Aurora DB cluster. Create a replication user on the source database, and follow the instructions in the "Additional information" section to provide the appropriate privileges, to enable replication on Aurora, and to confirm that the replication is in sync.	AWS DevOps/database administrator

## Related resources

### Creating an Amazon EFS file system

- [Creating a security group](#) (Amazon VPC documentation)
- [Transit gateway VPN attachments](#) (Amazon VPC documentation)
- [Scaling VPN throughput using AWS Transit Gateway](#) (Networking & Content Delivery blog)
- [Creating an Amazon EFS file system](#) (Amazon EFS documentation)
- [Creating mount targets](#) (Amazon EFS documentation)
- [Encrypting data at rest](#) (Amazon EFS documentation)

### Mounting the file system

- [IAM roles for Amazon EC2](#) (Amazon EC2 documentation)

- [Launching an Amazon EC2 Linux instance](#) (Amazon EC2 documentation)
- [Installing the NFS client](#) (Amazon EFS documentation)
- [Mounting the Amazon EFS file system on your on-premises client](#) (Amazon EFS documentation)
- [Mounting EFS File Systems](#) (Amazon EFS documentation)

## Making a backup of the MySQL source database

- [Installing Percona XtraBackup 2.3](#) (Percona XtraBackup documentation)
- [Installing Percona XtraBackup 2.4](#) (Percona XtraBackup documentation)
- [Setting the replication master configuration](#) (MySQL documentation)
- [Migrating data from an external MySQL database to an Aurora MySQL DB cluster](#) (Aurora documentation)
- [Incremental backup](#) (Percona XtraBackup documentation)

## Restoring the backup to Amazon Aurora MySQL

- [Creating a bucket](#) (Amazon S3 documentation)
- [Connecting to your Linux instance using SSH](#) (Amazon Ec2 documentation)
- [Configuring the AWS CLI](#) (AWS CLI documentation)
- [sync command](#) (AWS CLI command reference)
- [Creating an IAM policy to access Amazon S3 resources](#) (Aurora documentation)
- [DB cluster prerequisites](#) (Aurora documentation)
- [Working with DB subnet groups](#) (Aurora documentation)
- [Creating a VPC security group for a private DB instance](#) (Aurora documentation)
- [Restoring an Aurora MySQL DB cluster from an S3 bucket](#) (Aurora documentation)
- [Setting up replication with MySQL or another Aurora DB cluster](#) (Aurora documentation)
- [mysql.rds\\_set\\_external\\_master procedure](#) (MySQL on Amazon RDS SQL reference)
- [mysql.rds\\_start\\_replication procedure](#) (MySQL on Amazon RDS SQL reference)

## Additional references

- [Migrating data from an external MySQL database to an Aurora MySQL DB cluster](#) (Aurora documentation)

- [MySQL server downloads](#) (Oracle website)

## Tutorials and videos

- [Migrating MySQL data to an Aurora MySQL DB cluster using Amazon S3](#) (AWS Knowledge Center)
- [Amazon EFS setup and mount](#) (video)

## Additional information

### Installing an NFS client

- If you are using Red Hat or a similar Linux operating system, use the command:

```
$ sudo yum -y install nfs-utils
```

- If you are using Ubuntu or a similar Linux operating system, use the command:

```
$ sudo apt-get -y install nfs-common
```

For more information, see the [walkthrough](#) in the Amazon EFS documentation.

### Mounting the Amazon EFS file system

Use the commands:

```
mkdir ~/<efs_mount_name>  
$ sudo mount -t nfs -o  
nfsvers=4.1,rsize=1048576,wsize=1048576,hard,timeo=600,retrans=2,noresvport mount-  
target-IP:/ ~/<efs_mount_name>
```

For more information, see the [walkthrough](#) and [Mounting EFS File Systems](#) in the Amazon EFS documentation.

### Making backups of the MySQL source database

#### *Full backups*

Use a command like the following, which takes the backup, zips it, and splits it into smaller chunks of 1 GB each:

```
xtrabackup --backup --user=dbuser --password=<password> --binlog-info=AUTO --stream=tar
--target-dir=~/<efs_mount_name>/fullbackup | gzip - | split -d --bytes=1024MB - ~/
<efs_mount_name>/fullbackup/backup.tar.gz &
```

If you're planning to make subsequent incremental backups after the full backup, do not zip and split the backup. Instead, use a command similar to the following:

```
xtrabackup --backup --user=dbuser --password=<password> --target-dir=~/
<efs_mount_name>/fullbackup/
```

### *Incremental backups*

Use the full backup path for the `--incremental-basedir` parameter; for example:

```
xtrabackup --backup --user=dbuser --password=<password> --target-dir=~/
<efs_mount_name>/incremental/backupdate --incremental-basedir=~/<efs_mount_name>/
fullbackup
```

where *basedir* is the path to the full backup and the `xtrabackup_checkpoints` file.

For more information about making backups, see [Migrating Data from an External MySQL Database to an Amazon Aurora MySQL DB Cluster](#) in the Aurora documentation.

### **Preparing backups**

To prepare a full backup:

```
xtrabackup --prepare --apply-log-only --target-dir=~/<efs_mount_name>/fullbackup
```

To prepare an incremental backup:

```
xtrabackup --prepare --apply-log-only --target-dir=~/<efs_mount_name>/fullbackup --
incremental-dir=~/<efs_mount_name>/incremental/06062020
```

To prepare the final backup:

```
xtrabackup --prepare --target-dir=~/<efs_mount_name>/fullbackup --incremental-dir=~/  
<efs_mount_name>/incremental/06072020
```

For more information, see [Incremental backups](#) in the Percona XtraBackup documentation.

## Zipping and splitting the merged backup

To zip the merged backup at ~/<efs\_mount\_name>/fullbackup:

```
tar -zcvf <backupfilename.tar.gz> ~/<efs_mount_name>/fullbackup
```

To split the backup:

```
split -d -b1024M --verbose <backupfilename.tar.gz> <backupfilename.tar.gz>
```

## Setting up binlog replication

To create a replication user on the source database and provide the appropriate privileges:

```
CREATE USER 'repl_user'@' ' IDENTIFIED BY ''; GRANT REPLICATION CLIENT, REPLICATION  
SLAVE ON *.* TO 'repl_user'@' ';
```

To enable replication on Aurora by connecting to the Aurora DB cluster, enable binary logs in the DB cluster parameter group. Set `binlog_format = mixed` (mixed mode is preferred). This change requires that you restart the instance to apply the update.

```
CALL mysql.rds_set_external_master ('sourcedbinstanceIP', sourcedbport, 'repl_user',  
'', 'binlog_file_name', binlog_file_position, 0); CALL mysql.rds_start_replication;
```

To confirm that the replication is in sync:

```
SHOW Slave Status \G;
```

The **Seconds behind master** field shows how far behind Aurora is from the on-premises database.

# Migrate on-premises Java applications to AWS using AWS App2Container

Created by Dhananjay Karanjkar (AWS)

<b>Environment:</b> PoC or pilot	<b>Source:</b> Applications	<b>Target:</b> Containerized application deployed on Amazon ECS
<b>R Type:</b> Replatform	<b>Workload:</b> Open-source	<b>Technologies:</b> Migration; Web & mobile apps
<b>AWS services:</b> Amazon EC2 Container Registry; Amazon ECS		

## Summary

AWS App2Container (A2C) is a command line tool that helps transform existing applications running in virtual machines into containers, without needing any code changes. A2C discovers applications running on a server, identifies dependencies, and generates relevant artifacts for seamless deployment to Amazon Elastic Container Service (Amazon ECS) and Amazon Elastic Kubernetes Service (Amazon EKS).

This pattern provides the steps for remotely migrating on-premises Java applications deployed on an application server to AWS Fargate or Amazon EKS by using App2Container through the worker machine.

The worker machine can be used in the following use cases:

- Docker installation is not allowed or not available on the application servers where the Java applications are running.
- You must manage the migration of multiple applications deployed on different physical or virtual servers.

## Prerequisites and limitations

### Prerequisites

- An application server with a Java application running on a Linux server
- A worker machine with a Linux operating system
- A worker machine with at least 20 GB of available disk space

### Limitations

- Not all applications are supported. For more information, see [Supported applications for Linux](#).

## Architecture

### Source technology stack

- Java applications running on Linux server

### Target technology stack

- AWS CodeBuild
- AWS CodeCommit
- AWS CodeDeploy
- AWS CodePipeline
- Amazon Elastic Container Registry
- AWS Fargate

### Target architecture



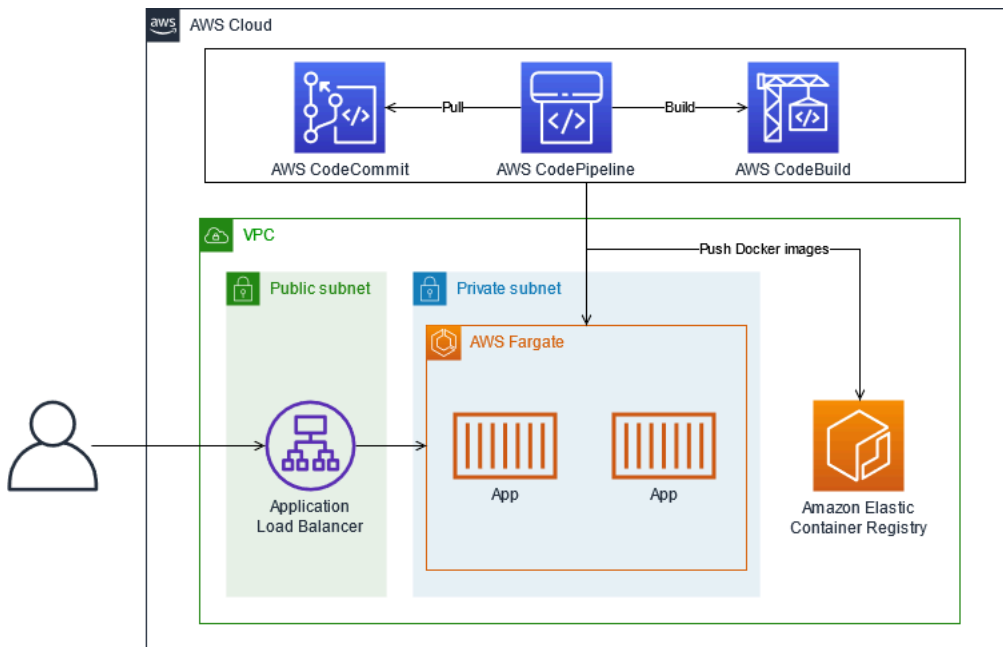

## Tools

### Tools

- [AWS App2Container](#) – AWS App2Container (A2C) is a command line tool to help you lift and shift applications that run in your on-premises data centers or on virtual machines, so that they run in containers that are managed by Amazon ECS or Amazon EKS.
- [AWS CodeBuild](#) – AWS CodeBuild is a fully managed build service in the cloud. CodeBuild compiles your source code, runs unit tests, and produces artifacts that are ready to deploy.
- [AWS CodeCommit](#) – AWS CodeCommit is a version control service hosted by Amazon Web Services that you can use to privately store and manage assets (such as documents, source code, and binary files) in the cloud.
- [AWS CodePipeline](#) – AWS CodePipeline is a continuous delivery service you can use to model, visualize, and automate the steps required to release your software.
- [Amazon ECS](#) – Amazon Elastic Container Service (Amazon ECS) is a highly scalable, fast container management service that for running, stopping, and managing containers on a cluster.
- [Amazon ECR](#) – Amazon Elastic Container Registry (Amazon ECR) is an AWS managed container image registry service that is secure, scalable, and reliable.
- [Amazon EKS](#) – Amazon Elastic Kubernetes Service (Amazon EKS) is a managed service that you can use to run Kubernetes on AWS without needing to install, operate, and maintain your own Kubernetes control plane or nodes.

- [AWS Fargate](#) – AWS Fargate is a technology that you can use with Amazon ECS to run containers without having to manage servers or clusters of Amazon Elastic Compute Cloud (Amazon EC2) instances. With Fargate, you no longer have to provision, configure, or scale clusters of virtual machines to run containers.

## Epics

### Set up credentials

Task	Description	Skills required
Create a secret to access the application server.	To access the application server remotely from the worker machine, create a secret in AWS Secrets Manager. For your secret, you can use either the SSH private key or the Certificate and the SSH private key. For more information, see <a href="#">Manage secrets for AWS App2Container</a> .	DevOps, Developer

### Set up the worker machine

Task	Description	Skills required
Install the tar file.	Run <code>sudo yum install -y tar</code> .	DevOps, Developer
Install the AWS CLI.	To install the Amazon Command Line Interface (AWS CLI), run <code>curl "https://awscli.amazonaws.com/awscli-exe-linux-x86_64</code> .	DevOps, Developer

Task	Description	Skills required
	<pre>zip" -o "awscliv2.zip" .  Unzip awscliv2.zip .  Run sudo ./aws/install .</pre>	
Install App2Container.	<p>Run the following commands:</p> <pre>curl -o AWSApp2Container-installer-linux.tar.gz https://app2container-release-us-east-1.s3.us-east-1.amazonaws.com/latest/linux/AWSApp2Container-installer-linux.tar.gz  sudo tar xvf AWSApp2Container-installer-linux.tar.gz  sudo ./install.sh</pre>	DevOps, Developer
Configure the profiles.	<p>To configure the AWS default profile, run <code>sudo aws configure</code> .</p> <p>To configure the named AWS default profile, run <code>sudo aws configure --profile &lt;profile name&gt;</code>.</p>	DevOps, Developer

Task	Description	Skills required
Install Docker.	Run the following commands.  <pre>sudo yum install -y docker  sudo systemctl enable docker &amp; sudo systemctl restart docker</pre>	

Task	Description	Skills required
Initialize App2Container.	<p>To initialize App2Container, you need the following information:</p> <ul style="list-style-type: none"><li>• <code>workspace</code> : To store application containerization artifacts. We recommend providing a directory path that has at least 20 GB of free disk space.</li><li>• <code>awsProfile</code> : AWS profile configured on the server. This is required to upload artifacts to Amazon S3, run the <code>containerize</code> command, and generate AWS artifacts for deployment on Amazon ECS or Amazon EKS.</li><li>• <code>s3Bucket</code>: To extract and store AWS artifacts.</li><li>• <code>metricsReportPermission</code> : To collect and store metrics reported.</li><li>• <code>dockerContentTrust</code> : To sign the Docker image.</li></ul> <p>Run <code>sudo app2container init</code>.</p>	DevOps, Developer

## Configure the worker machine

Task	Description	Skills required
Configure the worker machine to remotely connect and run App2Container commands on the application server.	<p>To configure the worker machine, the following information is required:</p> <ul style="list-style-type: none"> <li>• <code>Server FQDN</code>: The fully qualified domain name of the application server.</li> <li>• <code>Server IP address</code>: The IP address of the application server. Either the FQDN or the IP address is sufficient.</li> <li>• <code>SecretARN</code> : The Amazon Resource Name (ARN) of the secret that is used to connect to the application server and is stored in Secrets Manager.</li> <li>• <code>AuthMethod</code> : The key or cert authentication method.</li> </ul> <p>Run <code>sudo app2container remote configure .</code></p>	DevOps, Developer

## Discover, analyze, and extract applications on the worker machine

Task	Description	Skills required
Discover the on-premises Java applications.	To remotely discover all the applications running on the	Developer, DevOps

Task	Description	Skills required
	<p>application server, run the following command.</p> <pre>sudo app2container remote inventory -- target &lt;FQDN/IP of App server&gt;</pre> <p>This command generates a list of deployed applications in <code>inventory.json</code>.</p>	
Analyze the discovered applications.	<p>To remotely analyze each application by using the application-id obtained in the inventory stage, run the following command.</p> <pre>sudo app2container remote analyze -- application-id &lt;java- app-id&gt; --target &lt;FQDN/IP of App Server&gt;</pre> <p>This generates <code>analysis.json</code> file in the workspace location. After this file is generated, you can alter the containerization parameters based on your needs.</p>	Developer, DevOps

Task	Description	Skills required
Extract the analyzed applications.	<p>To generate an application archive for the analyzed application, remotely run the following command, which will generate the tar bundle in the workspace location.</p> <pre>sudo app2container remote extract -- application-id &lt;application id&gt; -- target &lt;FQDN/IP of App Server&gt;</pre> <p>Extracted artifacts can be generated on the local worker machine.</p>	Developer, DevOps

### Containerize the extracted artifacts on the worker machine

Task	Description	Skills required
Containerize the extracted artifacts.	<p>Containerize the artifacts extracted in the previous step by running the following command.</p> <pre>sudo app2container containerize --input- archive &lt;tar bundle location on worker machine&gt;</pre>	Developer, DevOps
Finalize the target.	To finalize the target, open <code>deployment.json</code> ,	Developer, DevOps



Task	Description	Skills required
	<p>which is created when the <code>containerize</code> command runs. To specify AWS Fargate as the target, set <code>createEcsArtifacts</code> to <code>true</code>. To set Amazon EKS as the target, set <code>createEksArtifacts</code> to <code>true</code>.</p>	

## Generate and provision AWS artifacts

Task	Description	Skills required
<p>Generate AWS deployment artifacts on the worker machine.</p>	<p>To generate deployment artifacts, run the following command.</p> <pre>sudo app2container generate app-deployment --application-id &lt;application id&gt;</pre> <p>This generates the <code>ecs-master.yml</code> AWS CloudFormation template in the workspace.</p>	DevOps
<p>Provision the artifacts.</p>	<p>To further provision the generated artifacts, deploy the AWS CloudFormation template by running the following command.</p> <pre>aws cloudformation deploy --template-</pre>	DevOps

Task	Description	Skills required
	<pre>file &lt;path to ecs- master.yml&gt; --capabil ities CAPABILIT Y_NAMED_IAM --stack- name &lt;application id&gt;-ECS</pre>	
Generate the pipeline.	Modify <code>pipeline.json</code> , which was created in the previous story, based on your needs. Then run the <code>generate pipeline</code> command to generate the pipeline deployment artifacts.	DevOps

## Related resources

- [What is App2Container?](#)
- [AWS App2Container blog post](#)
- [AWS CLI configuration basics](#)
- [Docker basics for Amazon ECS](#)
- [Docker commands](#)

# Migrate shared file systems in an AWS large migration

Created by Amit Rudraraju (AWS), Sam Apa (AWS), Bheemeswararao Balla (AWS), Wally Lu (AWS), and Sanjeev Prakasam (AWS)

<b>Environment:</b> Production	<b>Source:</b> On-premises shared file system	<b>Target:</b> Amazon EFS or Amazon FSx
<b>R Type:</b> Replatform	<b>Workload:</b> All other workloads	<b>Technologies:</b> Migration; Storage & backup
<b>AWS services:</b> AWS DataSync; Amazon EFS; Amazon FSx for Windows File Server; Amazon FSx for NetApp ONTAP		

## Summary

Migrating 300 or more servers is considered a *large migration*. The purpose of a large migration is to migrate workloads from their existing, on-premises data centers to the AWS Cloud, and these projects typically focus on application and database workloads. However, shared file systems require focused attention and a separate migration plan. This pattern describes the migration process for shared file systems and provides best practices for migrating them successfully as part of a large migration project.

A *shared file system (SFS)*, also known as a *network* or *clustered* file system, is a file share that is mounted to multiple servers. Shared file systems are accessed through protocols such as Network File System (NFS), Common Internet File System (CIFS), or Server Message Block (SMB).

These systems are not migrated with standard migration tools such as AWS Application Migration Service because they are neither dedicated to the host being migrated nor represented as a block device. Although most host dependencies are migrated transparently, the coordination and management of the dependent file systems must be handled separately.

You migrate shared file systems in the following phases: discover, plan, prepare, cut over, and validate. Using this pattern and the attached workbooks, you migrate your shared file system to an AWS storage service, such as Amazon Elastic File System (Amazon EFS), Amazon FSx for NetApp

ONTAP, or Amazon FSx for Windows File Server. To transfer the file system, you can use AWS DataSync or a third-party tool, such as NetApp SnapMirror.

**Note:** This pattern is part of an AWS Prescriptive Guidance series about [large migrations to the AWS Cloud](#). This pattern includes best practices and instructions for incorporating SFSs into your wave plans for servers. If you are migrating one or more shared file systems outside of a large migration project, see the data transfer instructions in the AWS documentation for [Amazon EFS](#), [Amazon FSx for Windows File Server](#), and [Amazon FSx for NetApp ONTAP](#).

## Prerequisites and limitations

### Prerequisites

Prerequisites can vary depending on your source and target shared file systems and your use case. The following are the most common:

- An active AWS account.
- You have completed application portfolio discovery for your large migration project and started developing wave plans. For more information, see [Portfolio playbook for AWS large migrations](#).
- Virtual private clouds (VPCs) and security groups that allow ingress and egress traffic between the on-premises data center and your AWS environment. For more information, see [Network-to-Amazon VPC connectivity options](#) and [AWS DataSync network requirements](#).
- Permissions to create AWS CloudFormation stacks or permissions to create Amazon EFS or Amazon FSx resources. For more information, see the [CloudFormation documentation](#), [Amazon EFS documentation](#), or [Amazon FSx documentation](#).
- If you're using AWS DataSync to perform the migration, you need the following permissions:
  - Permissions for AWS DataSync to send logs to an AWS CloudWatch Logs log group. For more information, see [Allowing DataSync to upload logs to CloudWatch log groups](#).
  - Permissions to access the CloudWatch Logs log group. For more information, see [Overview of managing access permissions to your CloudWatch Logs resources](#).
  - Permissions to create agents and tasks in DataSync. For more information, see [Required IAM permissions for using AWS DataSync](#).

### Limitations

- This pattern is designed to migrate SFSs as part of a large migration project. It includes best practices and instructions for incorporating SFSs into your wave plans for migrating applications. If you are migrating one or more shared file systems outside of a large migration project, see the data transfer instructions in the AWS documentation for [Amazon EFS](#), [Amazon FSx for Windows File Server](#), and [Amazon FSx for NetApp ONTAP](#).
- This pattern is based on commonly used architectures, services, and migration patterns. However, large migration projects and strategies can vary between organizations. You might need to customize this solution or the provided workbooks based on your requirements.

## Architecture

### Source technology stack

One or more of the following:

- Linux (NFS) file server
- Windows (SMB) file server
- NetApp storage array
- Dell EMC Isilon storage array

### Target technology stack

One or more of the following:

- Amazon Elastic File System
- Amazon FSx for NetApp ONTAP
- Amazon FSx for Windows File Server

### Target architecture

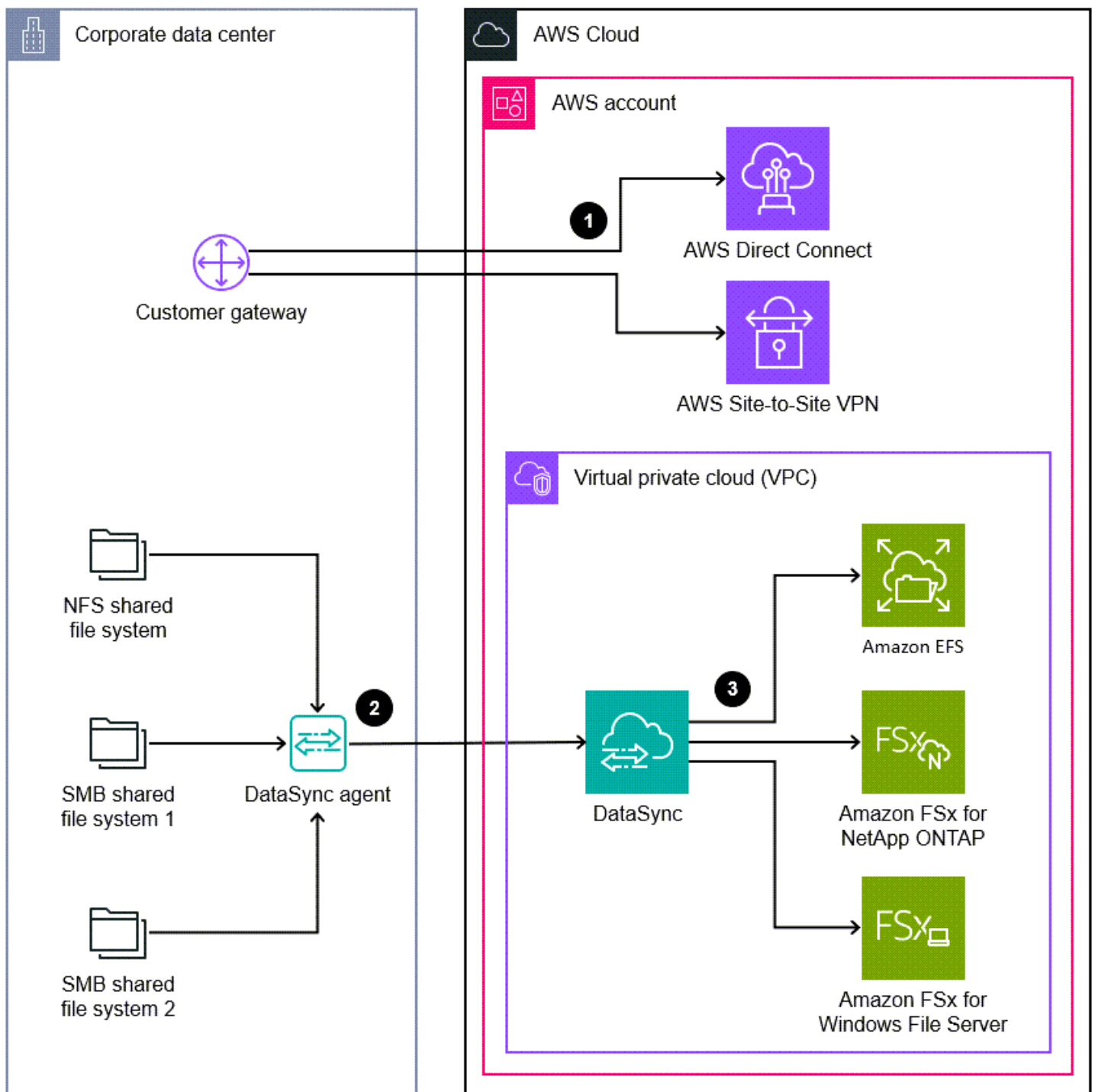

The diagram shows the following process:

1. You establish a connection between the on-premises data center and the AWS Cloud by using an AWS service such as AWS Direct Connect or AWS Site-to-Site VPN.
2. You install the DataSync agent in the on-premises data center.

3. According to your wave plan, you use DataSync to replicate data from the source shared file system to the target AWS file share.

## Migration phases

The following image shows the phases and high-level steps for migrating an SFS in a large migration project.

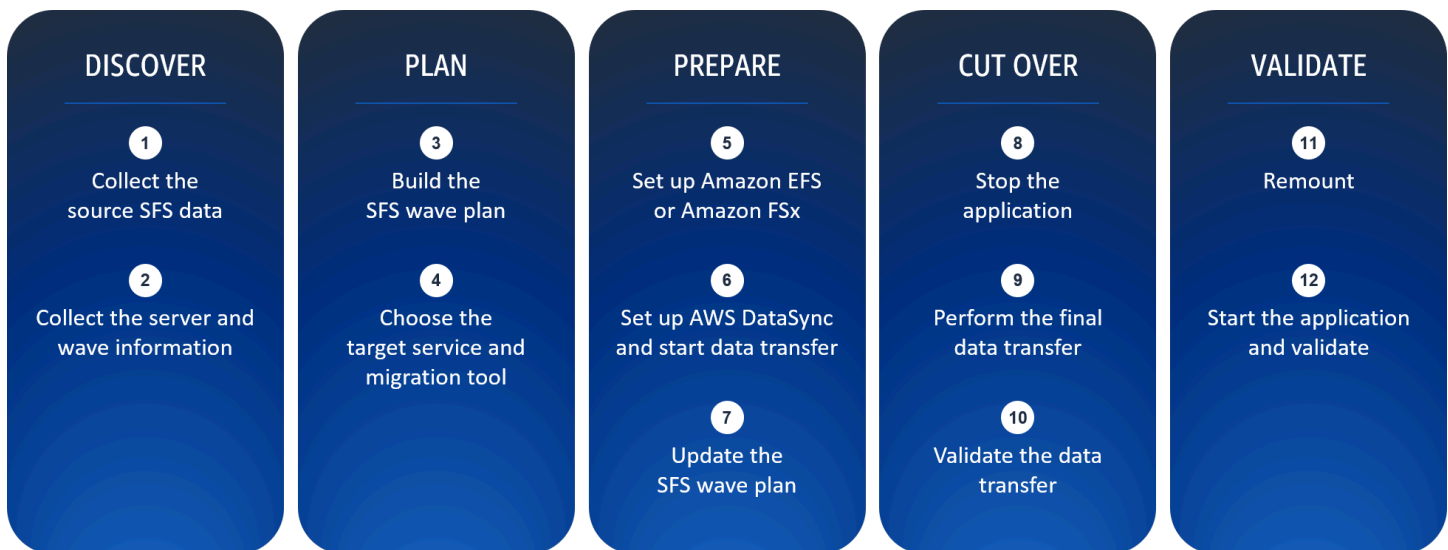

The [Epics](#) section of this pattern contains detailed instructions for how to complete the migration and use the attached workbooks. The following is a high-level overview of the steps in this phased approach.

### Phase

### Steps

#### Discover

1. Using a discovery tool, you collect data about the shared file system, including servers, mount points, and IP addresses.
2. Using a configuration management database (CMDB) or your migration tool, you collect details about the server, including information about the migration wave, environment, application owner, IT service management (ITSM) service name, organizational unit, and application ID.

- Plan**
- Using the collected information about the SFSs and the servers, create the SFS wave plan.
  - Using the information in the build worksheet, for each SFS, choose a target AWS service and a migration tool.
- Prepare**
- Set up the target infrastructure in Amazon EFS, Amazon FSx for NetApp ONTAP, or Amazon FSx for Windows File Server.
  - Set up the data transfer service, such as DataSync, and then start the initial data sync. When the initial sync is complete, you can set up reoccurring syncs to run on a schedule.
  - Update the SFS wave plan with information about the target file share, such as the IP address or path.
- Cut over**
- Stop applications that actively access the source SFS.
  - In the data transfer service, perform a final data sync.
  - When the sync is complete, validate that it was completely successfully by reviewing the log data in CloudWatch Logs.
- Validate**
- On the servers, change the mount point to the new SFS path.
  - Restart and validate the applications.

## Tools

### AWS services



- [Amazon CloudWatch Logs](#) helps you centralize the logs from all your systems, applications, and AWS services so you can monitor them and archive them securely.
- [AWS DataSync](#) is an online data transfer and discovery service that helps you move files or object data to, from, and between AWS storage services.
- [Amazon Elastic File System \(Amazon EFS\)](#) helps you create and configure shared file systems in the AWS Cloud.
- [Amazon FSx](#) provides file systems that support industry-standard connectivity protocols and offer high availability and replication across AWS Regions.

## Other tools

- [SnapMirror](#) is a NetApp data replication tool that replicates data from specified source volumes or [qtrees](#) to target volumes or qtrees, respectively. You can use this tool to migrate a NetApp source file system to Amazon FSx for ONTAP.
- [Robocopy](#), which is short for *Robust File Copy*, is a command-line directory and command for Windows. You can use this tool to migrate a Windows source file system to Amazon FSx for Windows File Server.

## Best practices

### Wave planning approaches

When planning waves for your large migration project, consider latency and application performance. When the SFS and dependent applications are operating in different locations, such as one in the cloud and one in the on-premises data center, this can increase latency and affect application performance. The following are the available options when creating wave plans:

1. **Migrate the SFS and all dependent servers within the same wave** – This approach prevents performance issues and minimizes rework, such as reconfiguring mount points multiple times. It is recommended when very low latency is required between the application and the SFS. However, wave planning is complex, and the goal is typically to remove variables from dependency groupings, not add to them. In addition, this approach isn't recommended if many servers access the same SFS because it makes the wave too large.
2. **Migrate the SFS after the last dependent server has been migrated** – For example, if an SFS is accessed by multiple servers and those servers are scheduled to migrate in waves 4, 6, and 7, schedule the SFS to migrate in wave 7.

This approach is often the most logical for large migrations and is recommended for latency-sensitive applications. It reduces costs associated with data transfer. It also minimizes the period of latency between the SFS and higher-tier (such as production) applications because higher-tier applications are typically scheduled to migrate last, after development and QA applications.

However, this approach still requires discovery, planning, and agility. You might need to migrate the SFS in an earlier wave. Confirm that the applications can withstand the additional latency for the period of time between the first dependent wave and the wave containing the SFS. Conduct a discovery session with the application owners and migrate the application in same wave the most latency-sensitive application. If performance issues are discovered after migrating a dependent application, be prepared to pivot quickly to migrate the SFS as quickly as possible.

- 3. Migrate the SFS at the end of the large migration project** – This approach is recommended if latency is not a factor, such as when the data in the SFS is infrequently accessed or not critical to application performance. This approach streamlines the migration and simplifies cutover tasks.

You can blend these approaches based on the latency-sensitivity of the application. For example, you can migrate latency-sensitive SFSs by using approaches 1 or 2 and then migrate the rest of the SFSs by using approach 3.

### Choosing an AWS file system service

AWS offers several cloud services for file storage. Each offers different benefits and limitations for performance, scale, accessibility, integration, compliance, and cost optimization. There are some logical default options. For example, if your current on-premises file system is operating Windows Server, then Amazon FSx for Windows File Server is the default choice. Or if the on-premises file system is operating NetApp ONTAP, then Amazon FSx for NetApp ONTAP is the default choice. However, you might choose a target service based on the requirements of your application or to realize other cloud operating benefits. For more information, see [Choosing the right AWS file storage service for your deployment](#) (AWS Summit presentation).

### Choosing a migration tool

Amazon EFS and Amazon FSx support use of AWS DataSync to migrate shared file systems to the AWS Cloud. For more information about supported storage systems and services, benefits, and use cases, see [What is AWS DataSync](#). For an overview of the process of using DataSync to transfer your files, see [How AWS DataSync transfers work](#).

There are also several third-party tools that are available, including the following:

- If you choose Amazon FSx for NetApp ONTAP, you can use NetApp SnapMirror to migrate the files from the on-premises data center to the cloud. SnapMirror uses block-level replication, which can be faster than DataSync and reduce the duration of the data transfer process. For more information, see [Migrating to FSx for ONTAP using NetApp SnapMirror](#).
- If you choose Amazon FSx for Windows File Server, you can use Robocopy to migrate files to the cloud. For more information, see [Migrating existing files to FSx for Windows File Server using Robocopy](#).

## Epics

### Discover

Task	Description	Skills required
Prepare the SFS discovery workbook.	<ol style="list-style-type: none"> <li>1. Download the workbooks in the <a href="#">Attachments</a> section of this pattern. This contains two files, <b>SFS-Discovery-Workbook.xlsx</b> and <b>SFS-Wave-Plan-Workbook.xlsx</b>.</li> <li>2. Open the <b>SFS-Discovery-Workbook</b> file in Microsoft Excel.</li> <li>3. On the <b>Dashboard</b> worksheet, do the following: <ul style="list-style-type: none"> <li>• In column <b>A</b>, update the environment name.</li> <li>• In column <b>B</b>, update the order of the environments to put them in order of lowest (1) priority to highest priority.</li> </ul> </li> </ol>	Migration engineer, Migration lead

Task	Description	Skills required
	<ul style="list-style-type: none"><li>• In columns <b>D–E</b>, update the wave schedule.</li><li>• In columns <b>C</b> and <b>K</b>, update the AWS account names.</li><li>• In column <b>L</b>, update the VPC IDs.</li><li>• In columns <b>M–O</b>, update the subnet IDs.</li></ul> <ol style="list-style-type: none"><li>4. Review the rest of the workbook template and update any other values necessary for your organization or use case.</li><li>5. Save the workbook.</li></ol>	

Task	Description	Skills required
Collect information about the source SFS.	<ol style="list-style-type: none"><li>Using your preferred discovery tool, identify all of the SFS mounts across all of the applicable storage devices, Linux servers, and Windows servers. Typically, you need to collect the following information:<ul style="list-style-type: none"><li>Client devices</li><li>Client IP address</li><li>SFS details</li><li>Mount point</li></ul><p><b>Note:</b> You can add mount point details to your migration runbook for remounting the SFS after the migration.</p></li><li>Open the <b>SFS-Discovery-Workbook</b> file.</li><li>On the <b>Wave-Sheet</b> worksheet, do the following:<ul style="list-style-type: none"><li>In the <b>Server location (D)</b> column, in the formula, confirm that the format of the CIDR range for the on-premises source works for your range. For example, if your CIDR</li></ul></li></ol>	Migration engineer, Migration lead

Task	Description	Skills required
	<p>range is <code>10.0.0.0/8</code> , enter <code>10.*.*.*</code>.</p> <ul style="list-style-type: none"><li>• In the <b>SFS location (E)</b> column, in the formula, confirm that the format of the CIDR range for the target VPC works for your range. For example, if your CIDR range is <code>176.16.0.0/16</code> , enter <code>176.16.*.*</code> .</li></ul> <p>4. On the <b>SFS-Data</b> worksheet, do the following:</p> <ul style="list-style-type: none"><li>• In the <b>Server name (A)</b> column, enter the name of the server where the SFS is mounted.</li><li>• In the <b>SFS path (B)</b> column, enter the name of the SFS.</li><li>• In the <b>IP address (C)</b> column, enter the IP address of the server.</li><li>• Add any other relevant information that you collected during discovery, such as the mount point and SFS size. You can use this data later to modify the wave planning calculations.</li></ul>	

Task	Description	Skills required
	5. Save the workbook.	

Task	Description	Skills required
Collect information about the servers.	<ol style="list-style-type: none"><li>Using your CMDB or the data recorded in your migration tool, identify all of the following information about the servers that have SFS mounts:<ul style="list-style-type: none"><li>Server name</li><li>IP address</li><li>Wave</li><li>Organizational unit (OU)</li><li>Server environment, such as DEV, QA, or PROD</li><li>Application name</li><li>Application owner and contact information</li></ul></li><li>Open the <b>SFS-Discovery-Workbook</b> file.</li><li>On the <b>Server-Data</b> worksheet, in columns <b>A–H</b>, enter the information that you collected about the source servers. Note the following:<ul style="list-style-type: none"><li>In the <b>Wave # (C)</b> column, enter the wave name (such as Wave1), out-of-scope (OOS), or Retire.</li><li>If the <b>App owner contact (H)</b> column, verify the email address is correct. This email</li></ul></li></ol>	Migration engineer, Migration lead



Task	Description	Skills required
	<p>address is automatically generated based on the name you provided in the <b>App owner (G)</b> column. If necessary, manually update the value to reflect the correct email address.</p> <ul style="list-style-type: none"> <li>• Don't modify columns <b>I–J</b>, which contain formulas.</li> </ul> <p>4. Save the workbook.</p>	

## Plan

Task	Description	Skills required
Build the SFS wave plan.	<ol style="list-style-type: none"> <li>1. Open the <b>SFS-Discovery-Workbook</b> file.</li> <li>2. Verify all of the information collected in the discovery phase is accurate and current.</li> <li>3. On the <b>Wave-Sheet</b> worksheet, filter the <b>SFS wave (K)</b> column on the value 1. This is a list of all SFSs in the first wave.</li> </ol> <p><b>Note:</b> A value of 0 in this column indicates that the SFS is out of scope of the migration. This might be because the SFS is already</p>	Build lead, Cutover lead, Migration engineer, Migration lead

Task	Description	Skills required
	<p>hosted on AWS or because the servers that access the share are out of scope of the migration.</p> <ol style="list-style-type: none"><li data-bbox="592 415 1019 730">4. Verify that you want to migrate these SFSs in this wave. For more information about how to assign SFSs to waves, see <i>Wave planning approaches</i> in the <a href="#">Best Practices</a> section.</li><li data-bbox="592 751 1019 982">5. Select and copy the cells containing the filtered values. Do not copy the header row containing the column titles.</li><li data-bbox="592 1003 1019 1129">6. Open the <b>SFS-Wave-Plan-Workbook</b> file that you previously downloaded.</li><li data-bbox="592 1150 1019 1276">7. On the <b>Export-from-Discovery</b> worksheet, select cell <b>A2</b>.</li><li data-bbox="592 1297 1019 1339">8. Paste the copied data.</li><li data-bbox="592 1360 1019 1486">9. Save the <b>SFS-Discovery-Workbook</b> and <b>SFS-Wave-Plan-Workbook</b> files.</li></ol>	

Task	Description	Skills required
Choose the target AWS service and migration tool.	<ol style="list-style-type: none"><li>1. In the <b>SFS-Wave-Plan-Workbook</b> file, on the <b>Exported-from-Discovery</b> worksheet, select and copy the values in the <b>Old path (C)</b> column.</li><li>2. On the <b>Build-Wave</b> worksheet, select cell <b>A2</b>.</li><li>3. Paste the copied data. Columns B–M in this worksheet automatically update to reflect other data associated with this path.</li><li>4. Remove any duplicate values in column <b>A</b>. For instructions, see <a href="#">Remove duplicate values</a> (Microsoft Support website).</li><li>5. In the <b>Target pattern or service (F)</b> column, review the recommended target AWS service and update as needed. For more information, see <i>Choosing an AWS file system service</i> in the <a href="#">Best practices</a> section of this pattern.</li><li>6. In the <b>Migration method (G)</b> column, review the recommended migration tool and update as needed. For more</li></ol>	Migration engineer, Migration lead

Task	Description	Skills required
	<p>information, see <i>Choosing a migration tool</i> in the <a href="#">Best practices</a> section of this pattern.</p> <p>7. Save the <b>SFS-Discovery-Workbook</b> file. You have finished creating a wave plan for this wave.</p> <p>8. Repeat these instructions to prepare a wave plan for each wave. Because wave plans are subject to change during the migration, we recommend that you plan no more than 5 waves in advance.</p>	

## Prepare

Task	Description	Skills required
Set up the target file system.	<p>According to the details recorded in your wave plan, set up the target file systems in the target AWS account, VPC, and subnets. For instructions, see the following AWS documentation:</p> <ul style="list-style-type: none"> <li>• <a href="#">Amazon EFS</a></li> <li>• <a href="#">Amazon FSx for NetApp ONTAP</a></li> </ul>	Migration engineer, Migration lead, AWS administrator

Task	Description	Skills required
	<ul style="list-style-type: none"><li data-bbox="592 212 993 296">• <a href="#">Amazon FSx for Windows File Server</a></li></ul>	

Task	Description	Skills required
Set up the migration tool and transfer data.	<ol style="list-style-type: none"><li data-bbox="591 226 1027 499">1. If you're using AWS DataSync, configure logging for DataSync tasks. For instructions, see <a href="#">Logging your AWS DataSync task activities</a>.</li><li data-bbox="591 520 1027 1816">2. Set up the migration tool and perform an initial data transfer according to the instructions for your selected tool:<ul style="list-style-type: none"><li data-bbox="630 772 1027 1003">• For Amazon EFS, see the following:<ul style="list-style-type: none"><li data-bbox="662 877 1027 1003">• <a href="#">Transfer files to Amazon EFS using AWS DataSync</a></li></ul></li><li data-bbox="630 1024 1027 1465">• For Amazon FSx for ONTAP, see the following:<ul style="list-style-type: none"><li data-bbox="662 1182 1027 1308">• <a href="#">Migrating to FSx for ONTAP using NetApp SnapMirror</a></li><li data-bbox="662 1329 1027 1465">• <a href="#">Migrating to FSx for ONTAP using AWS DataSync</a></li></ul></li><li data-bbox="630 1486 1027 1816">• For Amazon FSx for Windows File Server, see the following:<ul style="list-style-type: none"><li data-bbox="662 1644 1027 1816">• <a href="#">Migrating existing files to FSx for Windows File Server using AWS DataSync</a></li></ul></li></ul></li></ol>	AWS administrator, Cloud administrator, Migration engineer, Migration lead

Task	Description	Skills required
	<ul style="list-style-type: none"><li>• <a href="#">Migrating existing files to FSx for Windows File Server using Robocopy</a></li></ul> <p>3. Changes to the source SFS might occur during or after the initial transfer. Set up recurring data transfers between the source and target file systems to keep data synchronized:</p> <ul style="list-style-type: none"><li>• If you're using DataSync, see <a href="#">Scheduling your AWS DataSync task</a>. DataSync transfers only the modified or new files in the source SFS.</li><li>• If you're using a third-party tool, see the documentation for your selected tool.</li></ul>	

Task	Description	Skills required
Update the wave plan.	<ol style="list-style-type: none"><li>1. Open the <b>SFS-Wave-Plan-Workbook</b> file for the current wave.</li><li>2. On the <b>Build-Wave</b> worksheet, in the <b>New path IP address (N)</b> column, enter the IP address of the target file system. Do one of the following to locate the IP address:<ul style="list-style-type: none"><li>• For FSx for Windows File Server, on the Amazon FSx console, choose <b>File systems</b>, choose your file system, and then view the <b>Network &amp; Security</b> section.</li><li>• For FSx for ONTAP, see <a href="#">Mounting volumes</a>.</li><li>• For Amazon EFS, see <a href="#">Mounting with an IP address</a>.</li></ul></li><li>3. In the <b>New path (O)</b> column, enter the new mount path. The mount path is the DNS name of the file system. Do one of the following to locate the mount path:<ul style="list-style-type: none"><li>• For FSx for Windows File Server, on the Amazon FSx console, choose <b>File</b></li></ul></li></ol>	Migration engineer, Migration lead



Task	Description	Skills required
	<p><b>systems</b>, choose your file system, and then choose <b>Attach</b>.</p> <ul style="list-style-type: none"><li>• For FSx for ONTAP, see the <b>File system details</b> page. For instructions, see <a href="#">Mounting volumes</a>.</li><li>• For Amazon EFS, see <a href="#">Gather Information</a>.</li></ul> <p>4. On the <b>Remount-Summary</b> worksheet, confirm that the <b>New path (C)</b> and <b>New path IP address (D)</b> columns reflect the updated values.</p> <p>5. Confirm that your organization has prepared runbooks for remounting the Linux and Windows file systems after cutover. For general instructions, see the following:</p> <ul style="list-style-type: none"><li>• <a href="#">Mounting EFS file systems</a></li><li>• <a href="#">Accessing FSx for Windows File Server file shares</a></li><li>• <a href="#">Mounting FSx for ONTAP volumes</a></li></ul> <p>6. If any dependent servers are not included in this wave, record them on the <b>App-Team-Communica</b></p>	

Task	Description	Skills required
	<p><b>tion</b> worksheet. Inform the respective application or server owners because they might not be included in the standard wave communications.</p> <p>7. If SFSs are removed from the wave after completing the wave plan, track these on the <b>Descoped</b> worksheet.</p>	

## Cut over

Task	Description	Skills required
Stop applications.	<p>If applications or clients are actively performing read and write operations in the source SFS, stop them before you perform the final data sync. For instructions, see the application documentation or your internal processes for stopping read and write activities. For example, see <a href="#">Start or Stop the Web Server (IIS 8)</a> (Microsoft documentation) or <a href="#">Managing system services with systemctl</a> (Red Hat documentation).</p>	App owner, App developer

Task	Description	Skills required
Perform the final data transfer.	<ol style="list-style-type: none"><li data-bbox="592 226 1026 695">1. In the migration tool, manually run a final data transfer task or job to synchronize the target file system with the source SFS. For instructions, see <a href="#">Starting your DataSync task</a> or see the documentation for your selected third-party migration tool.</li><li data-bbox="592 716 1026 1087">2. Wait for the data transfer task to complete. For more information, see <a href="#">AWS Monitoring AWS DataSync activity with Amazon CloudWatch</a> and <a href="#">Monitoring your DataSync task from the command line</a>.</li></ol>	Migration engineer, Migration lead

Task	Description	Skills required
Validate the data transfer.	<p>If you're using AWS DataSync, do the following to validate the final data transfer completed successfully:</p> <ol style="list-style-type: none"><li>1. In the AWS DataSync console, make a note of the task and execution ID, such as <code>task-0000-exec-1111</code> .</li><li>2. Navigate to the <b>Task Logging</b> section of the DataSync task.</li><li>3. Choose the <b>CloudWatch log group</b> link.</li><li>4. In the logs, search for the task and execution ID.</li><li>5. Make note of any transfer errors. For more information, see <a href="#">Common Errors</a> in the DataSync documentation.</li><li>6. Validate the following:<ul style="list-style-type: none"><li>• Compare the file lists from the source and target SFSs to confirm that all data has been transferred</li><li>• Compare the file access permissions between the source and target SFSs.</li></ul></li></ol>	Migration engineer, Migration lead

Task	Description	Skills required
	If you're using a third-party tool, see the data transfer validation instructions in the documentation for the selected migration tool.	

## Validate

Task	Description	Skills required
Remount the file system and validate application function and performance.	<ol style="list-style-type: none"><li>1. If dependent servers were migrated in this wave, in the <b>SFS-Wave-Plan-Workbook</b> file, on the <b>Remount-Summary</b> worksheet, enter the new IP address of the server in the <b>New server IP address (F)</b> column.</li><li>2. On all servers, update the mount point for the file system from the old path to the new path. Use your organization's runbook for remounting previously discussed in the <i>Prepare</i> phase.</li><li>3. Confirm that the file system is mounted properly and accessible by checking the mounts and verifying files are present. The infrastructure team typically performs these activities.</li></ol>	AWS systems administrator, App owner

Task	Description	Skills required
	4. Restart the applications and engage the application owners or QA team to complete functional and performance testing on the application, as needed for the application.	

## Troubleshooting

Issue	Solution
Cell values in Microsoft Excel don't update.	Copy the formulas in the sample rows by dragging the fill handle. For more information, see instructions for <a href="#">Windows</a> or for <a href="#">Mac</a> (Microsoft Support website).

## Related resources

### AWS documentation

- [AWS DataSync documentation](#)
- [Amazon EFS documentation](#)
- [Amazon FSx documentation](#)
- [Large migrations to the AWS Cloud](#)
  - [Guide for AWS large migrations](#)
  - [Portfolio playbook for AWS large migrations](#)

## Troubleshooting

- [Troubleshooting AWS DataSync issues](#)
- [Troubleshooting Amazon EFS](#)
- [Troubleshooting Amazon FSx for Windows File Server](#)

- [Troubleshooting Amazon FSx for NetApp ONTAP](#)

## Attachments

To access additional content that is associated with this document, unzip the following file:

[attachment.zip](#)

# Migrate an Oracle database to Amazon RDS for Oracle by using Oracle GoldenGate flat file adapters

Created by Dhairya Jindani (AWS) and Baji Shaik (AWS)

<b>Environment:</b> PoC or pilot	<b>Source:</b> An Oracle database (on-premises or on an EC2 instance)	<b>Target:</b> Amazon RDS for Oracle
<b>R Type:</b> Replatform	<b>Workload:</b> Oracle	<b>Technologies:</b> Migration; Analytics; Databases
<b>AWS services:</b> Amazon RDS		

## Summary

Oracle GoldenGate is a real-time data capture and replication service for heterogeneous databases and IT environments. However, this service doesn't currently support Amazon Relational Database Service (Amazon RDS) for Oracle. For a list of supported databases, see [Oracle GoldenGate for Heterogeneous Databases](#) (Oracle documentation). This pattern describes how to use Oracle GoldenGate and Oracle GoldenGate flat file adapters to generate flat files from the source Oracle database, which can be on-premises or on an Amazon Elastic Compute Cloud (Amazon EC2) instance. You can then import those flat files to an Amazon RDS for Oracle database instance.

In this pattern, you use Oracle GoldenGate to extract the trail files from your source Oracle database. The data pump copies the trail files to an integration server, which is an EC2 instance. On the integration server, Oracle GoldenGate uses the flat file adapter to generate a series of sequential flat files based on the transactional data capture of the trail files. Oracle GoldenGate formats the data as either delimiter-separated values or length-delimited values. You then use Oracle SQL\*Loader to import the flat files into the target Amazon RDS for Oracle database instance.

## Target audience

This pattern is intended for those who have experience with and knowledge of an Oracle GoldenGate's fundamental building blocks. For more information, see [Overview of the Oracle GoldenGate Architecture](#) (Oracle documentation).



## Prerequisites and limitations

### Prerequisites

- An active Amazon Web Services (AWS) account.
- An Oracle GoldenGate license.
- A separate license for an Oracle GoldenGate adapter.
- A source Oracle database, either running on-premises or on an EC2 instance.
- An EC2 Linux instance that is used as the integration server. For more information, see [Get started with Amazon EC2 Linux instances](#) (Amazon EC2 documentation).
- A target Amazon RDS for Oracle database instance. For more information, see [Creating an Oracle DB instance](#) (Amazon RDS documentation).

### Product versions

- Oracle Database Enterprise Edition version 10g, 11g, 12c, or later
- Oracle GoldenGate version 12.2.0.1.1 or later

## Architecture

### Source technology stack

An Oracle database (on premises or on an EC2 instance)

### Target technology stack

Amazon RDS for Oracle

### Source and target architecture

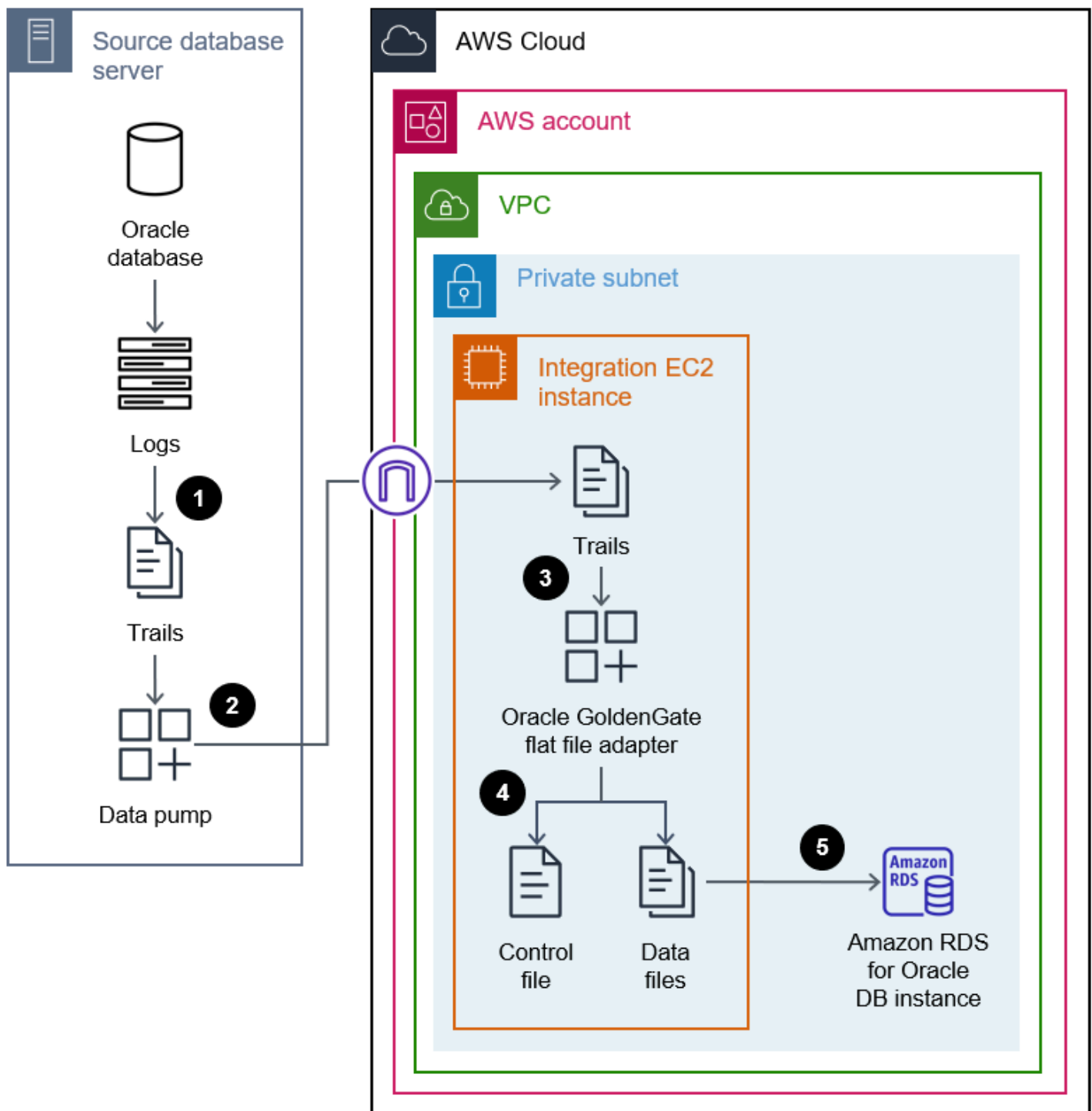

1. Oracle GoldenGate extracts trails from the source database logs.
2. The data pump extracts the trails and migrates them to an integration server.
3. The Oracle GoldenGate flat file adapter reads the trails, source definitions, and extract parameters.

4. You exit the extraction, which generates a control file and flat data files.
5. You migrate the flat data files to an Amazon RDS for Oracle database instance in the AWS Cloud.

## Tools

### AWS services

- [Amazon Elastic Compute Cloud \(Amazon EC2\)](#) provides scalable computing capacity in the AWS Cloud. You can launch as many virtual servers as you need and quickly scale them up or down.
- [Amazon Relational Database Service \(Amazon RDS\)](#) for Oracle helps you set up, operate, and scale an Oracle relational database in the AWS Cloud.

### Other services

- [Oracle GoldenGate](#) is a service that helps you to replicate, filter, and transform data from one database to another heterogeneous database or to another target topology, such as flat files.
- [Oracle GoldenGate application adapters](#) enable Oracle GoldenGate to produce a series of sequential flat files and control files from transactional data captured in the trail files of a source database. These adapters are widely used for extract, transform, and load (ETL) operations in data warehouse applications and proprietary or legacy applications. Oracle GoldenGate performs this capture and applies it in near real-time across heterogeneous databases, platforms, and operating systems. The adapters support different formats for the output files, such as CSV or Apache Parquet. You can load these generated files in order to load the data into different heterogeneous databases.

## Epics

### Set up Oracle GoldenGate on the source database server

Task	Description	Skills required
Download Oracle GoldenGate.	On the source database server, download Oracle GoldenGate version 12.2.0.1.1 or later. For instructions, see <a href="#">Downloading</a>	DBA

Task	Description	Skills required
	<a href="#">Oracle GoldenGate</a> (Oracle documentation).	
Install Oracle GoldenGate.	For instructions, see <a href="#">Installing Oracle GoldenGate</a> (Oracle documentation).	DBA
Set up Oracle GoldenGate.	For instructions, see <a href="#">Preparing the Database for Oracle GoldenGate</a> (Oracle documentation).	DBA

### Set up Oracle GoldenGate on the integration server

Task	Description	Skills required
Download Oracle GoldenGate.	On the integration server, download Oracle GoldenGate version 12.2.0.1.1 or later. For instructions, see <a href="#">Downloading Oracle GoldenGate</a> (Oracle documentation).	DBA
Install Oracle GoldenGate.	Create directories, set up the manager process, and create the defgen file for a heterogeneous environment. For instructions, see <a href="#">Installing Oracle GoldenGate</a> (Oracle documentation).	DBA

## Change the Oracle GoldenGate data capture configuration

Task	Description	Skills required
Prepare the Oracle GoldenGate adapters.	<p>On the integration server, set up the Oracle GoldenGate adapter software. Do the following:</p> <ol style="list-style-type: none"><li>1. From <a href="#">Oracle Software Delivery Cloud</a>, download <b>ggs_Adapters_Linux_x64.zip</b>.</li><li>2. Unzip <b>ggs_Adapters_Linux_x64.zip</b>.</li><li>3. Run the following command to install the adapters.</li></ol> <pre>tar -xvf ggs_Adapters_Linux_x64.tar</pre>	DBA
Configure the data pump.	<p>On the source server, configure the data pump to transfer the trail file from the source server to the integration server. Create the data pump parameter file and trails file directory. For instructions, see <a href="#">Configuring the Flat File Adapter</a> (Oracle documentation).</p>	DBA

## Generate and migrate the flat files

Task	Description	Skills required
Generate the flat files.	Create the extract file and control file, and then start the extraction process on the integration server. This extracts the database changes and writes the source database to the flat files. For instructions, see <a href="#">Using the Flat File Adapter</a> (Oracle documentation).	DBA
Load the flat files to the target database.	Load the flat files into the target Amazon RDS for Oracle database instance. For more information, see <a href="#">Importing using Oracle SQL*Loader</a> (Amazon RDS documentation).	DBA

## Troubleshooting

Issue	Solution
The Oracle GoldenGate flat file adapter generates an error.	For a description of the adapter errors, see <a href="#">Locating Error Messages</a> (Oracle documentation). For troubleshooting instructions, see <a href="#">Troubleshooting the Flat File Adapter</a> (Oracle documentation).

## Related resources

- [Installing Oracle GoldenGate](#) (Oracle documentation)

- [Configuring Oracle GoldenGate](#) (Oracle documentation)
- [Understanding Oracle GoldenGate Adapters](#) (Oracle documentation)
- [Configuring the Flat File Adapter](#) (Oracle documentation)

# Change Python and Perl applications to support database migration from Microsoft SQL Server to Amazon Aurora PostgreSQL-Compatible Edition

Created by Dwarika Patra (AWS) and Deepesh Jayaprakash (AWS)

<b>Environment:</b> PoC or pilot	<b>Source:</b> SQL Server	<b>Target:</b> Aurora PostgreSQL-Compatible
<b>R Type:</b> Replatform	<b>Workload:</b> Microsoft; Open-source	<b>Technologies:</b> Migration; Databases
<b>AWS services:</b> Amazon Aurora		

## Summary

This pattern describes changes to application repositories that might be required when you migrate databases from Microsoft SQL Server to Amazon Aurora PostgreSQL-Compatible Edition. The pattern assumes that these applications are Python-based or Perl-based, and provides separate instructions for these scripting languages.

Migrating SQL Server databases to Aurora PostgreSQL-Compatible involves schema conversion, database object conversion, data migration, and data loading. Because of the differences between PostgreSQL and SQL Server (relating to data types, connection objects, syntax, and logic), the most difficult migration task involves making the necessary changes to the code base so that it works correctly with PostgreSQL.

For a Python-based application, connection objects and classes are scattered throughout the system. Also, the Python code base might use multiple libraries to connect to the database. If the database connection interface changes, the objects that run the application's inline queries also require changes.

For a Perl-based application, changes involve connection objects, database connection drivers, static and dynamic inline SQL statements, and how the application handles complex dynamic DML queries and results sets.



When you migrate your application, you can also consider possible enhancements on AWS, such as replacing the FTP server with Amazon Simple Storage Service (Amazon S3) access.

The application migration process involves the following challenges:

- Connection objects. If connection objects are scattered in the code with multiple libraries and function calls, you might have to find a generalized way to change them to support PostgreSQL.
- Error or exception handling during record retrieval or updates. If you have conditional create, read, update, and delete (CRUD) operations on the database that return variables, results sets, or data frames, any errors or exceptions might result in application errors with cascading effects. These should be handled carefully with proper validations and save points. One such save point is to call large inline SQL queries or database objects inside `BEGIN . . . EXCEPTION . . . END` blocks.
- Controlling transactions and their validation. These includes manual and automatic commits and rollbacks. The PostgreSQL driver for Perl requires you to always explicitly set the auto-commit attribute.
- Handling dynamic SQL queries. This requires a strong understanding of the query logic and iterative testing to ensure that queries work as expected.
- Performance. You should ensure that code changes don't result in degraded application performance.

This pattern explains the conversion process in detail.

## Prerequisites and limitations

### Prerequisites

- Working knowledge of Python and Perl syntax.
- Basic skills in SQL Server and PostgreSQL.
- Understanding of your existing application architecture.
- Access to your application code, SQL Server database, and PostgreSQL database.
- Access to Windows or Linux (or other Unix) development environment with credentials for developing, testing, and validating application changes.
- For a Python-based application, standard Python libraries that your application might require, such as **Pandas** to handle data frames, and **psycopg2** or **SQLAlchemy** for database connections.

- For a Perl-based application, required Perl packages with dependent libraries or modules. The Comprehensive Perl Archive Network (CPAN) module can support most application requirements.
- All required dependent customized libraries or modules.
- Database credentials for read access to SQL Server and read/write access to Aurora.
- PostgreSQL to validate and debug application changes with services and users.
- Access to development tools during application migration such as Visual Studio Code, Sublime Text, or **pgAdmin**.

## Limitations

- Some Python or Perl versions, modules, libraries, and packages aren't compatible with the cloud environment.
- Some third-party libraries and frameworks used for SQL Server cannot be replaced to support PostgreSQL migration.
- Performance variations might require changes to your application, to inline Transact-SQL (T-SQL) queries, database functions, and stored procedures.
- PostgreSQL supports lowercase names for table names, column names, and other database objects.
- Some data types, such as UUID columns, are stored in lowercase only. Python and Perl applications must handle such case differences.
- Character encoding differences must be handled with the correct data type for the corresponding text columns in the PostgreSQL database.

## Product versions

- Python 3.6 or later (use the version that supports your operating system)
- Perl 5.8.3 or later (use the version that supports your operating system)
- Aurora PostgreSQL-Compatible Edition 4.2 or later (see [details](#))

## Architecture

### Source technology stack

- Scripting (application programming) language: Python 2.7 or later, or Perl 5.8

- Database: Microsoft SQL Server version 13
- Operating system: Red Hat Enterprise Linux (RHEL) 7

### Target technology stack

- Scripting (application programming) language: Python 3.6 or later, or Perl 5.8 or later
- Database: Aurora PostgreSQL-Compatible 4.2
- Operating system: RHEL 7

### Migration architecture

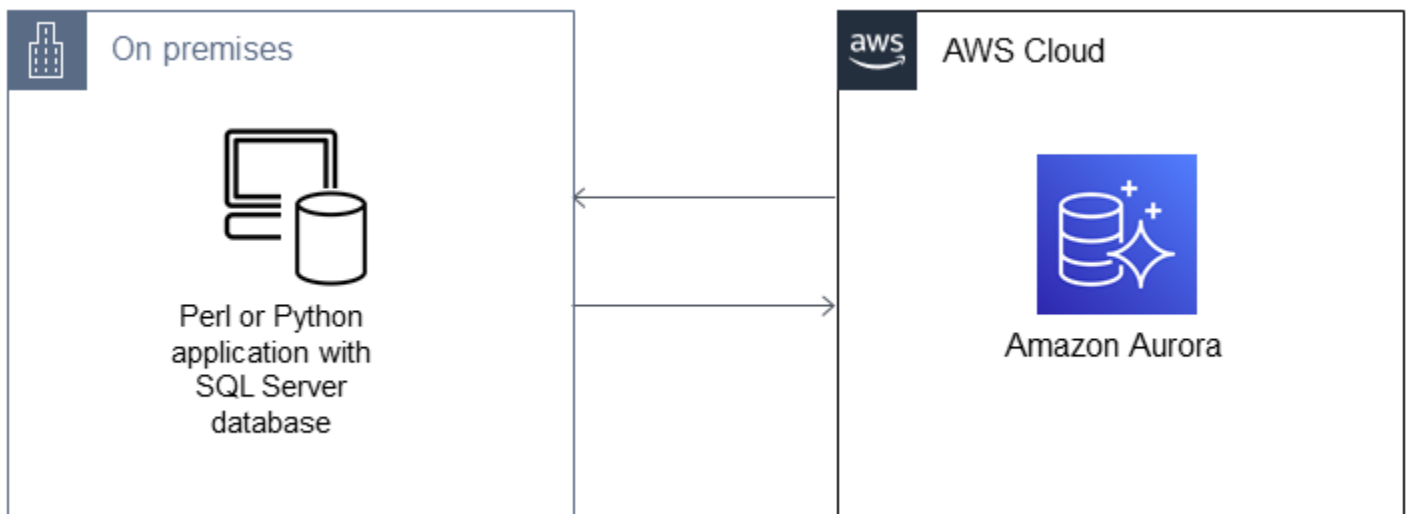

## Tools

### AWS services and tools

- [Aurora PostgreSQL-Compatible Edition](#) is a fully managed, PostgreSQL-compatible, and ACID-compliant relational database engine that combines the speed and reliability of high-end commercial databases with the cost-effectiveness of open-source databases. Aurora PostgreSQL is a drop-in replacement for PostgreSQL and makes it easier and more cost-effective to set up, operate, and scale your new and existing PostgreSQL deployments.
- [AWS Command Line Interface \(AWS CLI\)](#) is an open-source tool that enables you to interact with AWS services by using commands in your command-line shell.

### Other tools

- [Python](#) and PostgreSQL database connection libraries such as [psycopg2](#) and [SQLAlchemy](#)
- [Perl](#) and its [DBI modules](#)
- [PostgreSQL interactive terminal](#) (psql)

## Epics

### Migrate your application repository to PostgreSQL – high-level steps

Task	Description	Skills required
Follow these code conversion steps to migrate your application to PostgreSQL.	<ol style="list-style-type: none"> <li>1. Set database-specific ODBC drivers and libraries for PostgreSQL. For example, you can use one of the CPAN modules for Perl and <b>pyodbc</b>, <b>psycopg2</b>, or <b>SQLAlchemy</b> for Python.</li> <li>2. Convert database objects by using these libraries to connect to Aurora PostgreSQL-Compatible.</li> <li>3. Apply code changes in existing application modules to get compatible T-SQL statements.</li> <li>4. Rewrite database-specific function calls and stored procedures in application code.</li> <li>5. Handle changes to your application's variables and their data types that are used for inline SQL queries.</li> </ol>	App developer

Task	Description	Skills required
	<ol style="list-style-type: none"><li data-bbox="592 212 1031 338">6. Handle incompatible database-specific functions .</li><li data-bbox="592 365 1031 541">7. Complete end-to-end testing of converted application code for database migration.</li><li data-bbox="592 569 1031 745">8. Compare results from Microsoft SQL Server against the application you migrated to PostgreSQL.</li><li data-bbox="592 772 1031 949">9. Perform application performance benchmarking between Microsoft SQL Server and PostgreSQL.</li><li data-bbox="592 976 1031 1152">10. Revise stored procedures or inline T-SQL statements called by the application to improve performance.</li></ol> <p data-bbox="592 1220 1031 1396">The following epics provide detailed instructions for some of these conversion tasks for Python and Perl applications.</p>	

Task	Description	Skills required
Use a checklist for each step of the migration.	<p>Add the following to your checklist for each step of application migration, including the final step:</p> <ul style="list-style-type: none"><li>• Review PostgreSQL documentation to ensure that all your changes are compatible with the PostgreSQL standard.</li><li>• Check for integer and floating values for columns.</li><li>• Identify the number of rows inserted, updated, and extracted, along with the column names and date/time stamps. You can use a diff utility or write a script to automate these checks.</li><li>• Complete performance checks for large inline SQL statements, and check the overall performance of the application.</li><li>• Check for correct error handling for database operations and graceful program exit by using multiple try/catch blocks.</li><li>• Check to ensure that proper logging processes are in place.</li></ul>	App developer

## Analyze and update your application – Python code base

Task	Description	Skills required
Analyze your existing Python code base.	<p>Your analysis should include the following to facilitate the application migration process:</p> <ul style="list-style-type: none"><li>• Identify all connection objects in the code.</li><li>• Identify all incompatible inline SQL queries (such as T-SQL statements and stored procedures) and analyze required changes.</li><li>• Review the documentation for your code and track the control flow to understand code functionality. This will be helpful later when you test the application for performance or load comparisons.</li><li>• Understand the purpose of the application so you can test it effectively after database conversion. Most Python applications that are candidates for conversion with database migrations are either feeds that load data from other sources into database tables, or extractors that retrieve data from the tables and transform them into</li></ul>	App developer

Task	Description	Skills required
	different output formats (such as CSV, JSON, or flat files) that are suitable for creating reports or for making API calls to perform validations.	



Task	Description	Skills required
Convert your database connections to support PostgreSQL.	<p>Most Python applications use the <b>pyodbc</b> library to connect with SQL Server databases as follows.</p> <pre data-bbox="597 443 1027 1354">import pyodbc .... try:     conn_string =     "Driver=ODBC Driver 17     for SQL     Server;UID={};PWD=     {};Server={};Datab     ase={}".format     (conn_user, conn_pass     word,     conn_server,     conn_database)     conn = pyodbc.co     nnect(conn_string)     cur = conn.cursor()     result = cur.execu     te(query_string)     for row in result:     print (row) except Exception as e:     print(str(e))</pre> <p>Convert the database connection to support PostgreSQL as follows.</p> <pre data-bbox="597 1562 1027 1852">import pyodbc import psycopg2 .... try:     conn_string =     'postgresql+psycop     g2://'+</pre>	App developer

Task	Description	Skills required
	<pre>conn_user+':'+conn _password+'@'+conn _server+'/' +conn_d atabase conn = pyodbc.co nnect(conn_string, connect_args={'opt ions': '-csearch_pa th=dbo'}) cur = conn.cursor() result = cur.execu te(query_string) for row in result: print (row) except Exception as e: print(str(e))</pre>	

Task	Description	Skills required
Change inline SQL queries to PostgreSQL.	<p>Convert your inline SQL queries to a PostgreSQL-compatible format. For example, the following SQL Server query retrieves a string from a table.</p> <pre data-bbox="594 537 1029 1411">dtype = "type1" stm = '''SELECT TOP 1 searchcode FROM TypesTable (NOLOCK) WHERE code=''' + ''' + str(dtype) + ''' # For Microsoft SQL Server Database Connection engine = create_en gine('mssql+pyodbc :///?odbc_connect=%s' % urllib.parse.quote _plus(conn_string) , connect_args={'con nect_timeout':logi n_timeout}) conn = engine_connect() rs = conn.execute(stm) for row in rs:     print(row)</pre> <p>After conversion, the PostgreSQL-compatible inline SQL query looks like the following.</p> <pre data-bbox="594 1667 1029 1837">dtype = "type1" stm = '''SELECT searchcode FROM TypesTable</pre>	App developer

Task	Description	Skills required
	<pre>WHERE code='' + '''' +   str(dtype) + '' LIMIT   1" # For PostgreSQL Database Connection engine = create_en gine('postgres+psy copg2://%s' %conn_str ing, connect_a rgs={'connect_time out':login_timeout}) conn = engine.connect() rs = conn.execute(stm) for row in rs:     print(row)</pre>	

Task	Description	Skills required
Handle dynamic SQL queries.	<p>Dynamic SQL can be present in one script or in multiple Python scripts. Earlier examples showed how to use Python's string replace function to insert variables for constructing dynamic SQL queries. An alternate approach is to append the query string with variables wherever applicable.</p> <p>In the following example, the query string is constructed on the fly based on the values returned by a function.</p> <pre data-bbox="597 999 1026 1314">query = ""SELECT id from equity e join issues i on e.permId=i.permId where e.id"" query += get_id_filter(ids) + " e.id is NOT NULL"</pre> <p>These types of dynamic queries are very common during application migration . Follow these steps to handle dynamic queries:</p> <ul style="list-style-type: none"><li>• Check the overall syntax (for example, the syntax for the SELECT statement with a JOIN clause).</li></ul>	App developer

Task	Description	Skills required
	<ul style="list-style-type: none"><li>• Verify all variables or column names used in the query, such as <code>i</code> and <code>id</code>.</li><li>• Check the functions, arguments, and return values used in the query (for example, <code>get_id_filter</code> and its argument <code>ids</code>).</li></ul>	

Task	Description	Skills required
Handle results sets, variables, and data frames.	<p>For Microsoft SQL Server, you use Python methods such as <code>fetchone()</code> or <code>fetchall()</code> to retrieve the results set from the database. You can also use <code>fetchmany(size)</code> and specify the number of records to return from the results set. To do this, you can use the <b>pyodbc</b> connection object as shown in the following example.</p> <p><b>pyodbc (Microsoft SQL Server)</b></p> <pre>import pyodbc server = 'tcp:myserver.database.windows.net' database = 'exampledb' username = 'exampleuser' password = 'examplepassword' conn = pyodbc.connect('DRIVER={ODBC Driver 17 for SQL Server};SERVER='+server+';DATABASE='+database+';UID='+username+';PWD='+password) cursor = conn.cursor() cursor.execute("SELECT * FROM ITEMS") row = cursor.fetchone() while row:</pre>	App developer

Task	Description	Skills required
	<pre data-bbox="592 205 1031 346">print(row[0]) row = cursor.fe tchone()</pre> <p data-bbox="592 388 1031 945">In Aurora, to perform similar tasks such as connecting to PostgreSQL and fetching results sets, you can use either <b>psycopg2</b> or <b>SQLAlchemy</b>. These Python libraries provide the connection module and cursor object to traverse through the PostgreSQL database records, as shown in the following example.</p> <p data-bbox="592 987 1031 1071"><b>psycopg2 (Aurora PostgreSQL-Compatible)</b></p> <pre data-bbox="592 1102 1031 1875">import psycopg2 query = "SELECT * FROM ITEMS;" //Initialize variables host=dbname=user= password=port=sslm ode=connect_timeou t="" connstring = "host='{h ost}' dbname='{ dbname}' user='{user}' \ password='{passw ord}' port='{port}' ".format(host=host , dbname=dbname, \ user=user, password= password, port=port)</pre>	



Task	Description	Skills required
	<pre>conn = psycopg2. connect(connstring) cursor = conn.cursor() cursor.execute(query) column_names =     [column[0] for column     in cursor.description     ] print("Column Names: ",     column_names) print("Column values: " for row in cursor:     print("itemid :",         row[0])         print("itemdescript ion :", row[1])         print("it emprice :", row[3]))</pre> <p><b>SQLAlchemy (Aurora PostgreSQL-Compatible)</b></p> <pre>from sqlalchemy import     create_engine from pandas import     DataFrame conn_string = 'postgres ql://core:database @localhost:5432/ex ampledatabase' engine = create_en gine(conn_string) conn = engine.co nnect() dataid = 1001 result = conn.exec ute("SELECT * FROM     ITEMS") df = DataFrame (result.fetchall())</pre>	

Task	Description	Skills required
	<pre>df.columns = result.keys() df = pd.DataFrame() engine.connect() df = pd.read_sql_query(     sql_query, engine,     coerce_float=False) print("df=", df)</pre>	
Test your application during and after migration.	<p>Testing the migrated Python application is an ongoing process. Because the migration includes connection object changes (<b>psycopg2</b> or <b>SQLAlchemy</b>), error handling, new features (data frames), inline SQL changes, bulk copy functionalities (bcp instead of COPY) and similar changes, it must be tested carefully during and after application migration. Check for:</p> <ul style="list-style-type: none"><li>• Error conditions and handling</li><li>• Any record mismatches after migration</li><li>• Record updates or deletions</li><li>• Time required to run the application</li></ul>	App developer

## Analyze and update your application – Perl code base

Task	Description	Skills required
Analyze your existing Perl code base.	<p>Your analysis should include the following to facilitate the application migration process. You should identify:</p> <ul style="list-style-type: none"><li>• Any INI or configuration-based code</li><li>• Database-specific standard Open Database Connectivity (ODBC) Perl drivers or any customized drivers</li><li>• Code changes required for inline and T-SQL queries</li><li>• Interactions among various Perl modules (for example, a single Perl ODBC connection object that is called or used by multiple functional components)</li><li>• Dataset and results set handling</li><li>• External, dependent Perl libraries</li><li>• Any APIs that are used in the application</li><li>• Perl version compatibility and driver compatibility with Aurora PostgreSQL-Compatible</li></ul>	App developer

Task	Description	Skills required
Convert the connections from the Perl application and DBI module to support PostgreSQL.	<p>Perl-based applications generally use the Perl DBI module, which is a standard database access module for the Perl programming language. You can use the same DBI module with different drivers for SQL Server and PostgreSQL.</p> <p>For more information about required Perl modules, installations, and other instructions, see the <a href="#">DBD::Pg documentation</a>. The following example connects to Aurora PostgreSQL-Compatible at <code>exampletest-aurorapg-database-cluster-sampleclusture.us-east-.rds.amazonaws.com</code>.</p> <pre data-bbox="597 1285 1026 1816">#!/usr/bin/perl use DBI; use strict; my \$driver = "Pg"; my \$hostname = "exampletest-aurorapg-database-sampleclusture.us-east.rds.amazonaws.com"; my \$dsn = "DBI:\$driver:dbname = \$hostname;host = 127.0.0.1;port = 5432";</pre>	App developer

Task	Description	Skills required
	<pre>my \$username = "postgres"; my \$password = "pass123"; ; \$dbh = DBI-&gt;connect("dbi:Pg:dbname=\$hostname;host=\$hostname;port=\$port;options=\$options",     \$username,     \$password,     {AutoCommit =&gt; 0, RaiseError =&gt; 1, PrintError =&gt; 0} );</pre>	

Task	Description	Skills required
Change Inline SQL queries to PostgreSQL.	<p>Your application might have inline SQL queries with SELECT, DELETE, UPDATE, and similar statements that include query clauses that PostgreSQL doesn't support. For example, query keywords such as TOP and NOLOCK aren't supported in PostgreSQL. The following examples show how you can handle TOP, NOLOCK, and Boolean variables.</p> <p>In SQL Server:</p> <pre data-bbox="594 951 1029 1430">\$sqlStr = \$sqlStr . "WHERE a.student _id in (SELECT TOP \$numofRecords c_student_id \ FROM active_student_rec ord b WITH (NOLOCK) \ INNER JOIN student_c ontributor c WITH (NOLOCK) on c.contrib utor_id = b.c_st)</pre> <p>For PostgreSQL, convert to:</p> <pre data-bbox="594 1539 1029 1831">\$sqlStr = \$sqlStr . "WHERE a.student _id in (SELECT TOP \$numofRecords c_student_id \ FROM active_student_rec ord b INNER JOIN</pre>	App developer

Task	Description	Skills required
	<pre>student_contributor c \ on c.contributor_id = b.c_student_contr_id WHERE b_current_1 is true \ LIMIT \$numofRecords)"</pre>	

Task	Description	Skills required
Handle dynamic SQL queries and Perl variables.	<p>Dynamic SQL queries are SQL statements that are built at application runtime. These queries are constructed dynamically when the application is running, depending on certain conditions, so the full text of the query isn't known until runtime. An example is a financial analytics application that analyzes the top 10 shares on a daily basis, and these shares change every day. The SQL tables are created based on top performers, and the values aren't known until runtime.</p> <p>Let's say that the inline SQL queries for this example are passed to a wrapper function to get the results set in a variable, and then a variable uses a condition to determine whether the table exists:</p> <ul style="list-style-type: none"><li>• If the table exists, don't create it; do some processing.</li><li>• If the table doesn't exist, create the table and also do some processing.</li></ul>	App developer



Task	Description	Skills required
	<p>Here's an example of variable handling, followed by the SQL Server and PostgreSQL queries for this use case.</p> <pre data-bbox="597 426 1024 1020">my \$tableexists = db_read( arg 1,   \$sql_qry, undef,   'writer'); my \$table_already_exists = \$tableexists-&gt;[0]{table_exists}; if (\$table_already_exists){   # do some thing } else {   # do something else }</pre> <p>SQL Server:</p> <pre data-bbox="597 1136 1024 1367">my \$sql_qry = "SELECT OBJECT_ID('\$backen dTable', 'U') table_exi sts", undef, 'writer') ";</pre> <p>PostgreSQL:</p> <pre data-bbox="597 1482 1024 1713">my \$sql_qry = "SELECT TO_REGCLASS('\$back endTable', 'U') table_exists", undef, 'writer)";</pre> <p>The following example uses a Perl variable in</p>	

Task	Description	Skills required
	<p>inline SQL, which runs a SELECT statement with a JOIN to fetch the primary key of the table and position of the key column.</p> <p>SQL Server:</p> <pre>my \$sql_qry = "SELECT column_name', character_maxi mum_length \ FROM INFORMATION_SCHEMA .COLUMNS \ WHERE TABLE_SCH EMA='\$example_sche maInfo' \ AND TABLE_NAME='\$examp le_table' \ AND DATA_TYPE IN ('varchar', 'nvarchar ar');";</pre> <p>PostgreSQL:</p> <pre>my \$sql_qry = "SELECT c1.column_name, c1.ordinal_position \ FROM information_schema .key_column_usage AS c LEFT \ JOIN information_schema .table_constraints AS t1 \ ON t1.constraint_name = c1.constraint_name \ WHERE t1.table_name = \$example_schemaInf o.'\$example_table' \</pre>	

Task	Description	Skills required
	<pre>AND t1.constraint_type = 'PRIMARY KEY' ;";</pre>	

## Make additional changes to your Perl-based or Python-based application to support PostgreSQL

Task	Description	Skills required
Convert additional SQL Server constructs to PostgreSQL.	<p>The following changes apply to all applications, regardless of programming language.</p> <ul style="list-style-type: none"> <li>• Qualify database objects that your application uses with new and appropriate schema names.</li> <li>• Handle <a href="#">LIKE</a> operators for case-sensitive matching with the <a href="#">collation feature in PostgreSQL</a>.</li> <li>• Handle unsupported database specific functions such as DATEDIFF, DATEADD, GETDATE, CONVERT, and CAST operators. For equivalent PostgreSQL-compatible functions, see <i>Native or built-in SQL functions</i> in the <a href="#">Additional information</a> section.</li> <li>• Handle Boolean values in comparison statements.</li> </ul>	App developer

Task	Description	Skills required
	<ul style="list-style-type: none"> <li>• Handle return values from functions. These could be record sets, data frames, variables, and Boolean values. Handle these according to the requirements of your application and to support PostgreSQL.</li> <li>• Handle anonymous blocks (such as <code>BEGIN TRAN</code>) with new, user-defined PostgreSQL functions.</li> <li>• Convert bulk inserts for rows. The PostgreSQL equivalent of the SQL Server bulk copy (bcp) utility, which is called from inside the application, is <code>COPY</code>.</li> <li>• Convert column concatenation operators. SQL Server uses <code>+</code> for string concatenation, but PostgreSQL uses <code>  </code>.</li> </ul>	

## Improve performance

Task	Description	Skills required
Take advantage of AWS services to make performance enhancements.	When you migrate to the AWS Cloud, you can refine your application and database design to take advantage of AWS services. For example,	App developer, Cloud architect

Task	Description	Skills required
	<p>if the queries from your Python application, which is connected to an Aurora PostgreSQL-Compatible database server, is taking more time than your original Microsoft SQL Server queries, you could consider creating a feed of historical data directly to an Amazon Simple Storage Service (Amazon S3) bucket from the Aurora server, and use Amazon Athena-based SQL queries to generate reports and analytic data queries for your user dashboards.</p>	

## Related resources

- [Perl](#)
- [Perl DBI Module](#)
- [Python](#)
- [psycopg2](#)
- [SQLAlchemy](#)
- [Bulk Copy - PostgreSQL](#)
- [Bulk Copy - Microsoft SQL Server](#)
- [PostgreSQL](#)
- [Working with Amazon Aurora PostgreSQL](#)

## Additional information

Both Microsoft SQL Server and Aurora PostgreSQL-Compatible are ANSI SQL-complaint. However, you should still be aware of any incompatibilities in syntax, column data types, native database-specific functions, bulk inserts, and case sensitivity when you migrate your Python or Perl application from SQL Server to PostgreSQL.

The following sections provide more information about possible inconsistencies.

### Data type comparison

Data type changes from SQL Server to PostgreSQL can lead to significant differences in the resulting data that applications operate on. For a comparison of data types, see the table on the [Sqlines website](#).

### Native or built-in SQL functions

The behavior of some functions differs between SQL Server and PostgreSQL databases. The following table provides a comparison.

Microsoft SQL Server	Description	PostgreSQL
CAST	Converts a value from one data type to another.	PostgreSQL type :: operator
GETDATE()	Returns the current database system date and time, in a YYYY-MM-DD hh:mm:ss.mmm format.	CLOCK_TIMESTAMP
DATEADD	Adds a time/date interval to a date.	INTERVAL expression
CONVERT	Converts a value to a specific data format.	TO_CHAR
DATEDIFF	Returns the difference between two dates.	DATE_PART
TOP	Limits the number of rows in a SELECT results set.	LIMIT/FETCH

## Anonymous blocks

A structured SQL query is organized into sections such as declaration, executables, and exception handling. The following table compares the Microsoft SQL Server and PostgreSQL versions of a simple anonymous block. For complex anonymous blocks, we recommend that you call a custom database function within your application.

### Microsoft SQL Server

```
my $sql_qry1=
my $sql_qry2 =
my $sqlqry = "BEGIN TRAN
$sql_qry1 $sql_qry2
if @@error !=0 ROLLBACK
TRAN
else COMMIT TRAN";
```

### PostgreSQL

```
my $sql_qry1=
my $sql_qry2 =
my $sql_qry = " DO \$$
BEGIN
$header_sql $content_sql
END
\$$";
```

## Other differences

- **Bulk inserts of rows:** The PostgreSQL equivalent of the [Microsoft SQL Server bcp utility](#) is [COPY](#).
- **Case sensitivity:** Column names are case-sensitive in PostgreSQL, so you have to convert your SQL Server column names to lowercase or uppercase. This becomes a factor when you extract or compare data, or place column names in results sets or variables. The following example identifies columns where values might be stored in uppercase or lowercase.

```
my $sql_qry = "SELECT $record_id FROM $exampleTable WHERE LOWER($record_name) =
\'failed transaction\'";
```

- **Concatenation:** SQL Server uses + as an operator for string concatenation, whereas PostgreSQL uses ||.
- **Validation:** You should test and validate inline SQL queries and functions before you use them in application code for PostgreSQL.

- **ORM Library inclusion** : You can also look for including or replace existing database connection library with Python ORM libraries such as [SQLAlchemy](#) and [PynomoDB](#). This will help to easily query and manipulate data from a database using an object-oriented paradigm.



# Migration patterns by workload

## Topics

- [IBM](#)
- [Microsoft](#)
- [N/A](#)
- [Open-source](#)
- [Oracle](#)
- [SAP](#)

## IBM

- [Migrate a Db2 database from Amazon EC2 to Aurora MySQL-Compatible by using AWS DMS](#)
- [Migrate Db2 for LUW to Amazon EC2 by using log shipping to reduce outage time](#)
- [Migrate Db2 for LUW to Amazon EC2 with high availability disaster recovery](#)
- [Migrate from IBM Db2 on Amazon EC2 to Aurora PostgreSQL-Compatible using AWS DMS and AWS SCT](#)
- [Migrate from IBM WebSphere Application Server to Apache Tomcat on Amazon EC2](#)

## Microsoft

- [Accelerate the discovery and migration of Microsoft workloads to AWS](#)
- [Change Python and Perl applications to support database migration from Microsoft SQL Server to Amazon Aurora PostgreSQL-Compatible Edition](#)
- [Create AWS CloudFormation templates for AWS DMS tasks using Microsoft Excel and Python](#)
- [Export a Microsoft SQL Server database to Amazon S3 by using AWS DMS](#)
- [Ingest and migrate EC2 Windows instances into an AWS Managed Services account](#)
- [Migrate a messaging queue from Microsoft Azure Service Bus to Amazon SQS](#)
- [Migrate a Microsoft SQL Server database from Amazon EC2 to Amazon DocumentDB by using AWS DMS](#)
- [Migrate a Microsoft SQL Server database to Aurora MySQL by using AWS DMS and AWS SCT](#)
- [Migrate a .NET application from Microsoft Azure App Service to AWS Elastic Beanstalk](#)
- [Migrate an on-premises Microsoft SQL Server database to Amazon EC2](#)
- [Migrate an on-premises Microsoft SQL Server database to Amazon RDS for SQL Server](#)
- [Migrate an on-premises Microsoft SQL Server database to Amazon RDS for SQL Server using linked servers](#)
- [Migrate an on-premises Microsoft SQL Server database to Amazon RDS for SQL Server using native backup and restore methods](#)
- [Migrate an on-premises Microsoft SQL Server database to Amazon Redshift using AWS DMS](#)
- [Migrate an on-premises Microsoft SQL Server database to Amazon Redshift using AWS SCT data extraction agents](#)
- [Migrate an on-premises Microsoft SQL Server database to Microsoft SQL Server on Amazon EC2 running Linux](#)
- [Migrate data from Microsoft Azure Blob to Amazon S3 by using Rclone](#)
- [Migrate Windows SSL certificates to an Application Load Balancer using ACM](#)
- [Rehost on-premises workloads in the AWS Cloud: migration checklist](#)
- [Set up Multi-AZ infrastructure for a SQL Server Always On FCI by using Amazon FSx](#)

**N/A**

- [Create an approval process for firewall requests during a rehost migration to AWS](#)

## Open-source

- [Create application users and roles in Aurora PostgreSQL-Compatible](#)
- [Migrate an on-premises MariaDB database to Amazon RDS for MariaDB using native tools](#)
- [Migrate an on-premises MySQL database to Amazon EC2](#)
- [Migrate an on-premises MySQL database to Amazon RDS for MySQL](#)
- [Migrate an on-premises MySQL database to Aurora MySQL](#)
- [Migrate an on-premises PostgreSQL database to Aurora PostgreSQL](#)
- [Migrate from IBM WebSphere Application Server to Apache Tomcat on Amazon EC2 with Auto Scaling](#)
- [Migrate from Oracle GlassFish to AWS Elastic Beanstalk](#)
- [Migrate from PostgreSQL on Amazon EC2 to Amazon RDS for PostgreSQL using pglogical](#)
- [Migrate on-premises Java applications to AWS using AWS App2Container](#)
- [Migrate on-premises MySQL databases to Aurora MySQL using Percona XtraBackup, Amazon EFS, and Amazon S3](#)
- [Migrate Oracle external tables to Amazon Aurora PostgreSQL-Compatible](#)
- [Migrate Redis workloads to Redis Enterprise Cloud on AWS](#)
- [Restart the AWS Replication Agent automatically without disabling SELinux after rebooting a RHEL source server](#)
- [Transport PostgreSQL databases between two Amazon RDS DB instances using pg\\_transport](#)

# Oracle

- [Configure links between Oracle Database and Aurora PostgreSQL-Compatible](#)
- [Convert VARCHAR2\(1\) data type for Oracle to Boolean data type for Amazon Aurora PostgreSQL](#)
- [Emulate Oracle DR by using a PostgreSQL-compatible Aurora global database](#)
- [Incrementally migrate from Amazon RDS for Oracle to Amazon RDS for PostgreSQL using Oracle SQL Developer and AWS SCT](#)
- [Load BLOB files into TEXT by using file encoding in Aurora PostgreSQL-Compatible](#)
- [Migrate Amazon RDS for Oracle to Amazon RDS for PostgreSQL in SSL mode by using AWS DMS](#)
- [Migrate Amazon RDS for Oracle to Amazon RDS for PostgreSQL with AWS SCT and AWS DMS using AWS CLI and AWS CloudFormation](#)
- [Migrate an Amazon RDS for Oracle database to another AWS account and AWS Region using AWS DMS for ongoing replication](#)
- [Migrate an Amazon RDS for Oracle DB instance to another VPC](#)
- [Migrate an on-premises Oracle database to Amazon EC2 by using Oracle Data Pump](#)
- [Migrate an on-premises Oracle database to Amazon OpenSearch Service using Logstash](#)
- [Migrate an on-premises Oracle database to Amazon RDS for MySQL using AWS DMS and AWS SCT](#)
- [Migrate an on-premises Oracle database to Amazon RDS for Oracle](#)
- [Migrate an on-premises Oracle database to Amazon RDS for Oracle by using direct Oracle Data Pump Import over a database link](#)
- [Migrate an on-premises Oracle database to Amazon RDS for Oracle using Oracle Data Pump](#)
- [Migrate an on-premises Oracle database to Amazon RDS for PostgreSQL by using an Oracle bystander and AWS DMS](#)
- [Migrate an on-premises Oracle database to Oracle on Amazon EC2](#)
- [Migrate an Oracle database from Amazon EC2 to Amazon RDS for MariaDB using AWS DMS and AWS SCT](#)
- [Migrate an Oracle database from Amazon EC2 to Amazon RDS for Oracle using AWS DMS](#)
- [Migrate an Oracle database to Amazon DynamoDB using AWS DMS](#)
- [Migrate an Oracle database to Amazon RDS for Oracle by using Oracle GoldenGate flat file adapters](#)
- [Migrate an Oracle Database to Amazon Redshift using AWS DMS and AWS SCT](#)

- [Migrate an Oracle database to Aurora PostgreSQL using AWS DMS and AWS SCT](#)
- [Migrate an Oracle JD Edwards EnterpriseOne database to AWS by using Oracle Data Pump and AWS DMS](#)
- [Migrate an Oracle partitioned table to PostgreSQL by using AWS DMS](#)
- [Migrate an Oracle PeopleSoft database to AWS by using AWS DMS](#)
- [Migrate data from an on-premises Oracle database to Aurora PostgreSQL](#)
- [Migrate from Amazon RDS for Oracle to Amazon RDS for MySQL](#)
- [Migrate from Oracle 8i or 9i to Amazon RDS for PostgreSQL using materialized views and AWS DMS](#)
- [Migrate from Oracle 8i or 9i to Amazon RDS for PostgreSQL using SharePlex and AWS DMS](#)
- [Migrate from Oracle Database to Amazon RDS for PostgreSQL by using Oracle GoldenGate](#)
- [Migrate from Oracle on Amazon EC2 to Amazon RDS for MySQL using AWS DMS and AWS SCT](#)
- [Migrate from Oracle to Amazon DocumentDB using AWS DMS](#)
- [Migrate from Oracle WebLogic to Apache Tomcat \(TomEE\) on Amazon ECS](#)
- [Migrate function-based indexes from Oracle to PostgreSQL](#)
- [Migrate legacy applications from Oracle Pro\\*C to ECPG](#)
- [Migrate Oracle CLOB values to individual rows in PostgreSQL on AWS](#)
- [Migrate Oracle Database error codes to an Amazon Aurora PostgreSQL-Compatible database](#)
- [Migrate Oracle E-Business Suite to Amazon RDS Custom](#)
- [Migrate Oracle native functions to PostgreSQL using extensions](#)
- [Migrate Oracle PeopleSoft to Amazon RDS Custom](#)
- [Migrate Oracle ROWID functionality to PostgreSQL on AWS](#)
- [Migrate Oracle SERIALLY\\_REUSABLE pragma packages into PostgreSQL](#)
- [Migrate virtual generated columns from Oracle to PostgreSQL](#)
- [Set up Oracle UTL\\_FILE functionality on Aurora PostgreSQL-Compatible](#)
- [Validate database objects after migrating from Oracle to Amazon Aurora PostgreSQL](#)

## SAP

- [Migrate an on-premises SAP ASE database to Amazon EC2](#)
- [Migrate from SAP ASE to Amazon RDS for SQL Server using AWS DMS](#)
- [Migrate SAP ASE on Amazon EC2 to Amazon Aurora PostgreSQL-Compatible using AWS SCT and AWS DMS](#)
- [Reduce homogeneous SAP migration cutover time by using Application Migration Service](#)



## More patterns

- [Access AWS services from IBM z/OS by installing the AWS CLI](#)
- [Assess application readiness for migration to the AWS Cloud by using CAST Highlight](#)
- [Assess query performance for migrating SQL Server databases to MongoDB Atlas on AWS](#)
- [Automate cross-Region failover and failback by using DR Orchestrator Framework](#)
- [Build an advanced mainframe file viewer in the AWS Cloud](#)
- [Configure a data center extension to VMware Cloud on AWS using Hybrid Linked Mode](#)
- [Connect to Application Migration Service data and control planes over a private network](#)
- [Containerize mainframe workloads that have been modernized by Blu Age](#)
- [Convert JSON Oracle queries into PostgreSQL database SQL](#)
- [Convert the Teradata NORMALIZE temporal feature to Amazon Redshift SQL](#)
- [Convert the Teradata RESET WHEN feature to Amazon Redshift SQL](#)
- [Copy Amazon DynamoDB tables across accounts using AWS Backup](#)
- [Deploy a Cassandra cluster on Amazon EC2 with private static IPs to avoid rebalancing](#)
- [Deploy multiple-stack applications using AWS CDK with TypeScript](#)
- [Emulate Oracle RAC workloads using custom endpoints in Aurora PostgreSQL](#)
- [Estimate the Amazon RDS engine size for an Oracle database by using AWR reports](#)
- [Generate data insights by using AWS Mainframe Modernization and Amazon Q in QuickSight](#)
- [Handle anonymous blocks in Dynamic SQL statements in Aurora PostgreSQL](#)
- [Handle overloaded Oracle functions in Aurora PostgreSQL-Compatible](#)
- [Identify duplicate container images automatically when migrating to an Amazon ECR repository](#)
- [Integrate VMware vRealize Network Insight with VMware Cloud on AWS](#)
- [Migrate Amazon RDS for Oracle DB instances to other accounts that use AMS](#)
- [Migrate an on-premises Apache Kafka cluster to Amazon MSK by using MirrorMaker](#)
- [Migrate Apache Cassandra workloads to Amazon Keyspaces by using AWS Glue](#)
- [Migrate from Oracle 8i or 9i to Amazon RDS for Oracle using SharePlex and AWS DMS](#)
- [Migrate Hadoop data to Amazon S3 by using WANdisco LiveData Migrator](#)
- [Migrate Oracle functions and procedures that have more than 100 arguments to PostgreSQL](#)
- [Migrate Oracle OUT bind variables to a PostgreSQL database](#)
- [Migrate RHEL BYOL systems to AWS License-Included instances by using AWS MGN](#)

- [Migrate SAP HANA to AWS using SAP HSR with the same hostname](#)
- [Migrate SQL Server to AWS using distributed availability groups](#)
- [Migrate VMs to VMware Cloud on AWS by using HCX OS Assisted Migration](#)
- [Modernize mainframe online printing workloads on AWS by using Micro Focus Enterprise Server and LRS VPSX/MFI](#)
- [Modernize mainframe output management on AWS by using OpenText Micro Focus Enterprise Server and LRS PageCenterX](#)
- [Modify HTTP headers when you migrate from F5 to an Application Load Balancer on AWS](#)
- [Resolve connection errors after migrating Microsoft SQL Server to the AWS Cloud](#)
- [Send logs from VMware Cloud on AWS to Splunk by using VMware Aria Operations for Logs](#)
- [Set up a CI/CD pipeline for database migration by using Terraform](#)
- [Set up disaster recovery for Oracle JD Edwards EnterpriseOne with AWS Elastic Disaster Recovery](#)
- [Simplify private certificate management by using AWS Private CA and AWS RAM](#)
- [Transfer large-scale Db2 z/OS data to Amazon S3 in CSV files](#)

# Modernization

## Topics

- [Analyze and visualize software architecture in CAST Imaging](#)
- [Assess application readiness for migration to the AWS Cloud by using CAST Highlight](#)
- [Automatically archive items to Amazon S3 using DynamoDB TTL](#)
- [Build a Micro Focus Enterprise Server PAC with Amazon EC2 Auto Scaling and Systems Manager](#)
- [Build a multi-tenant serverless architecture in Amazon OpenSearch Service](#)
- [Deploy multiple-stack applications using AWS CDK with TypeScript](#)
- [Automate deployment of nested applications using AWS SAM](#)
- [Implement SaaS tenant isolation for Amazon S3 by using an AWS Lambda token vending machine](#)
- [Implement the serverless saga pattern by using AWS Step Functions](#)
- [Manage on-premises container applications by setting up Amazon ECS Anywhere with the AWS CDK](#)
- [Modernize ASP.NET Web Forms applications on AWS](#)
- [Run event-driven and scheduled workloads at scale with AWS Fargate](#)
- [Tenant onboarding in SaaS architecture for the silo model using C# and AWS CDK](#)
- [Decompose monoliths into microservices by using CQRS and event sourcing](#)
- [More patterns](#)

# Analyze and visualize software architecture in CAST Imaging

Created by Arpita Sinha (Cast Software) and James Hurrell (Cast Software)

**Environment:** Production

**Technologies:** Modernization

**Workload:** All other workloads

## Summary

This pattern shows how you can use CAST Imaging to navigate a complex software system visually and perform a precise analysis of the software structure. By using CAST Imaging in this way, you can make more informed decisions about your application's architecture, especially for modernization purposes.

To view your application's architecture in CAST Imaging, you must first onboard your application's source code through the CAST Console. The console then publishes your application's data to CAST Imaging, where you can visualize and navigate your application architecture layer by layer.

## Prerequisites and limitations

### Prerequisites

- An active AWS account
- The [Amazon Machine Image \(AMI\) for CAST Imaging](#)
- An Amazon Elastic Compute Cloud (Amazon EC2) instance that includes the following (a memory optimized **r5.xlarge** Amazon EC2 instance is recommended):
  - 4 vCPU
  - 32 GB RAM
  - 500 GB minimum General Purpose solid state drive (SSD) (gp3) volume
- CAST Console and CAST Imaging license keys (to get the required license keys, contact CAST at [aws.contact-me@castsoftware.com](mailto:aws.contact-me@castsoftware.com))
- The complete source code of the application that you want to analyze in compressed (.zip) format
- Microsoft Edge, Mozilla Firefox, or Google Chrome

## Architecture

The following diagram shows an example workflow for onboarding an application's source code through the CAST Console and then viewing it in CAST Imaging:

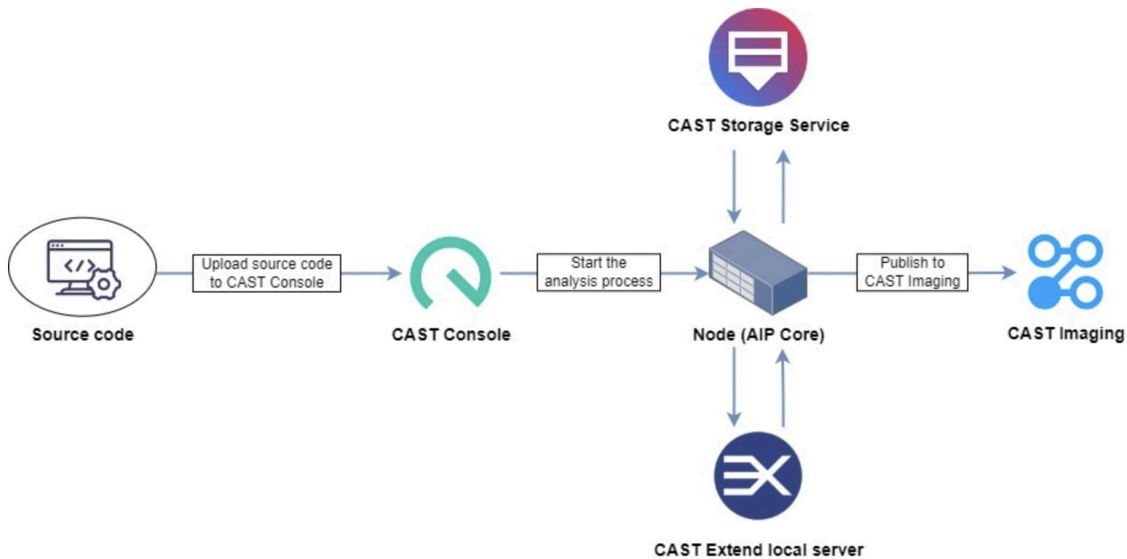

The diagram shows the following workflow:

1. CAST generates application source code metadata by reverse-engineering front-end, middleware, and back-end code.
2. The application data that is generated by CAST is automatically imported into CAST Imaging, where it can be visualized and analyzed.

Here's a snapshot of how this process works:

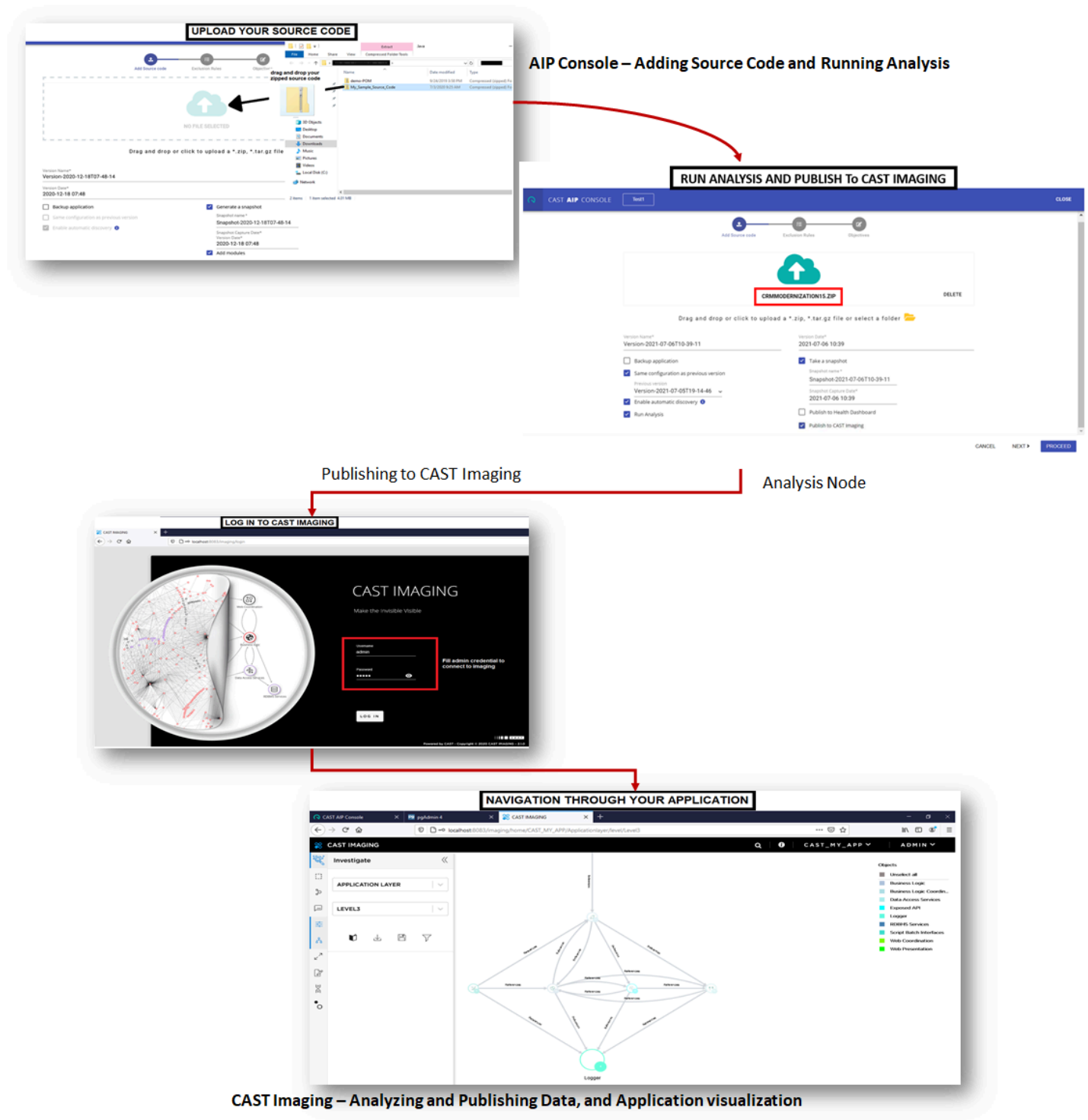

CAST Imaging – Analyzing and Publishing Data, and Application visualization

## Tools

- [CAST Imaging](#) is a browser-based application that helps you view and navigate your software system visually, so you can make informed decisions about its architecture.

- [CAST Console](#) is a browser-based application that helps you configure, run, and manage CAST AIP analyses.

**Note:** CAST Imaging and CAST Console are included in the AMI for CAST Imaging.

## Epics

### Set up the CAST Imaging environment

Task	Description	Skills required
Run the initial CAST Console configuration.	<ol style="list-style-type: none"> <li>1. Open your web browser and connect to the CAST Console by entering the following URL: <b>http://localhost:8081</b></li> <li>2. When prompted, enter your <b>CAST Console license key</b>. Then, choose <b>Next</b>.</li> <li>3. Review the configuration settings. If no changes are needed, choose <b>Save and Finish</b>.</li> </ol>	Software architects, Developers, Technical leaders
Run the initial CAST Imaging configuration.	<ol style="list-style-type: none"> <li>1. Open your web browser and connect to CAST Imaging by entering the following URL: <b>http://localhost:8083</b></li> <li>2. When prompted, log in by entering <b>admin</b> for both the username and password.</li> <li>3. When prompted, enter your <b>CAST Imaging license key</b>. Then,</li> </ol>	Software architects, Developers, Technical leaders

Task	Description	Skills required
	choose <b>Update</b> to save the key.	
Configure CAST Extend local server.	<p>(Optional) By default, CAST Extend local server is configured to function in offline mode. If this is acceptable, no additional configuration is necessary . However, if you prefer to configure CAST Extend local server in online/proxy mode with a direct connection to CAST Extend, follow these steps.</p> <p><b>Note:</b> For CAST Extend credentials, see the <a href="#">CAST Extend registration page</a>.</p> <ol style="list-style-type: none"><li>1. Use the <b>CAST Extend Admin Center</b> shortcut on the desktop to load your web browser and connect to CAST Extend local server.</li><li>2. Choose the <b>Online</b> option.</li><li>3. Enter your <b>CAST Extend credentials</b> (email and password), and choose <b>Save</b> to complete the process.</li></ol>	Software architects, Developers, Technical leaders



## Onboard your application to CAST Imaging

Task	Description	Skills required
Prepare the source code for your application.	Save your application's source code in a single, compressed .zip file.	Software architects, Developers, Technical leaders
Add your application to the CAST Console.	<ol style="list-style-type: none"> <li>1. Open your web browser and connect to the CAST Console by entering the following URL: <b>http://localhost:8081</b></li> <li>2. When prompted, log in by entering <b>admin</b> for both the username and password.</li> <li>3. Choose <b>Add application</b>. Then, enter the application name and choose <b>Add</b>.</li> </ol>	Software architects, Developers, Technical leaders
Open the source code delivery wizard.	Find the application that you created in the CAST Console. Then, choose <b>Add version</b> .	Software architects, Developers, Technical leaders
Upload the source code for your application.	<p>Do one of the following:</p> <ul style="list-style-type: none"> <li>• Drag and drop the .zip file that contains your application's source code into the source code delivery wizard.</li> <li>–or–</li> <li>• Choose the <b>upload cloud icon</b>. Then, open the .zip file that contains your application's source code.</li> </ul>	Software architects, Developers, Technical leaders

Task	Description	Skills required
Start the analysis process.	<ol style="list-style-type: none"> <li>1. In the delivery wizard, provide the version details and specify the configuration options. For more information, see <a href="#">Standard onboarding for CAST Imaging</a> in the CAST Imaging documentation.</li> <li>2. Make sure that the <b>Publish to CAST Imaging</b> option is selected. Then, choose <b>Proceed</b>.</li> </ol> <p><b>Note:</b> Choosing <b>Proceed</b> starts the analysis process for the source code. The progress window in the CAST Console shows each step of the analysis process, and displays a notification when the analysis is complete.</p>	Software architects, Developers, Technical leaders

### Verify the analysis results and data published to CAST Imaging

Task	Description	Skills required
Check status and logs.	<p>When all analysis actions are complete, verify that there's a <b>success</b> message in the progress window.</p> <p><b>Note:</b> You can check the individual logs for each analysis action immediate</p>	Software architects, Developers, Technical leaders

Task	Description	Skills required
	ly after it's completed. To review the logs for a specific action, choose <b>View log</b> in the <b>Progress</b> window.	
Check the application details.	In the <a href="#">Application details panel</a> , review the details about the analysis results. Make sure to look at the technologies that were discovered and the source code organization.	Software architects, Developers, Technical leaders
Verify and access CAST Imaging.	<ol style="list-style-type: none"> <li>1. In the <b>Application Management</b> pane in the CAST Console, verify that the version status of your application is <a href="#">Imaging processed</a>. A CAST Imaging icon appears.</li> <li>2. Choose the CAST Imaging icon to navigate directly to your application data in CAST Imaging.</li> </ol> <p><b>Note:</b> The <i>Imaging processed</i> status means that the source code has been analyzed and uploaded to your CAST Imaging instance.</p>	Software architects, Developers, Technical leaders

## Start analyzing your application with CAST Imaging

Task	Description	Skills required
Log in to CAST Imaging.	Open Cast Imaging and enter the default admin credentials ( <b>admin/admin</b> ). Your application's data appears.	Software architects, Developers, Technical leaders
Explore your application's data in CAST Imaging.	<p>Start viewing your software architecture by using CAST Imaging features.</p> <p>For a quick tutorial on how to use CAST Imaging's features, choose the <b>Help</b> icon to display the CAST Imaging Helper.</p> <p>For more information, see the <a href="#">CAST Imaging User Guide</a>.</p>	Software architects, Developers, Technical leaders

## Related resources

### CAST Console documentation

- [Login](#)
- [Configuring options via CAST Console](#)

### CAST Imaging documentation

- [Application onboarding for CAST Imaging - prerequisites](#)
- [Add a new application for CAST Imaging](#)
- [Standard onboarding for CAST Imaging – check results](#)
- [Login](#)
- [Configuration options – Admin Center GUI](#)

## More resources on CAST Imaging on AWS

- [Application Modernization to AWS Accelerated by CAST – Technical](#) (AWS PartnerCast webinar, requires free account)
- [Using CAST and AWS Migration Hub Refactor Spaces to Modernize Legacy Applications](#) (AWS blog post)
- [Modernize Applications to AWS Architectures with CAST Imaging](#) (AWS workshop)
- [AWS Marketplace: CAST Imaging](#)
- [All CAST on AWS resources](#)

# Assess application readiness for migration to the AWS Cloud by using CAST Highlight

Created by Greg Rivera (Cast Software)

<b>Environment:</b> Production	<b>Source:</b> Legacy application source code	<b>Target:</b> Refactored application code in AWS
<b>R Type:</b> Re-architect	<b>Workload:</b> IBM; Microsoft; Open-source; Oracle	<b>Technologies:</b> Modernization; Migration; Containers & microservices
<b>AWS services:</b> Amazon RDS; Amazon S3		

## Summary

CAST Highlight is a software as a service (SaaS) solution for performing rapid application portfolio analysis. This pattern describes how to configure and use CAST Highlight to assess the cloud readiness of custom software applications across an organization's IT portfolio, and to plan for modernization or migration to the Amazon Web Services (AWS) Cloud.

CAST Highlight generates insights into an application's cloud readiness, identifies code blockers that need to be removed before a migration, estimates the effort to remove these blockers, and recommends AWS services that individual applications could use after the migration.

This pattern describes the procedure for setting up and using CAST Highlight, which consists of five steps: new user setup, application management, campaign management, source code analysis, and results analysis. You must complete all the steps in the *Epics* section of this pattern to ensure a successful application scan and analysis.

## Prerequisites and limitations

### Prerequisites

- An active CAST Highlight account with Portfolio Manager permissions.

- At least 300 MB free disk space and 4 GB memory on your local computer to install the CAST Highlight Local Agent.
- Microsoft Windows 8 or later.
- Your application source code must be stored in text files that are accessible from the machine where the Local Agent is installed. No source code leaves the premises and all code is locally scanned.

## Architecture

The following diagram illustrates the workflow for using CAST Highlight.

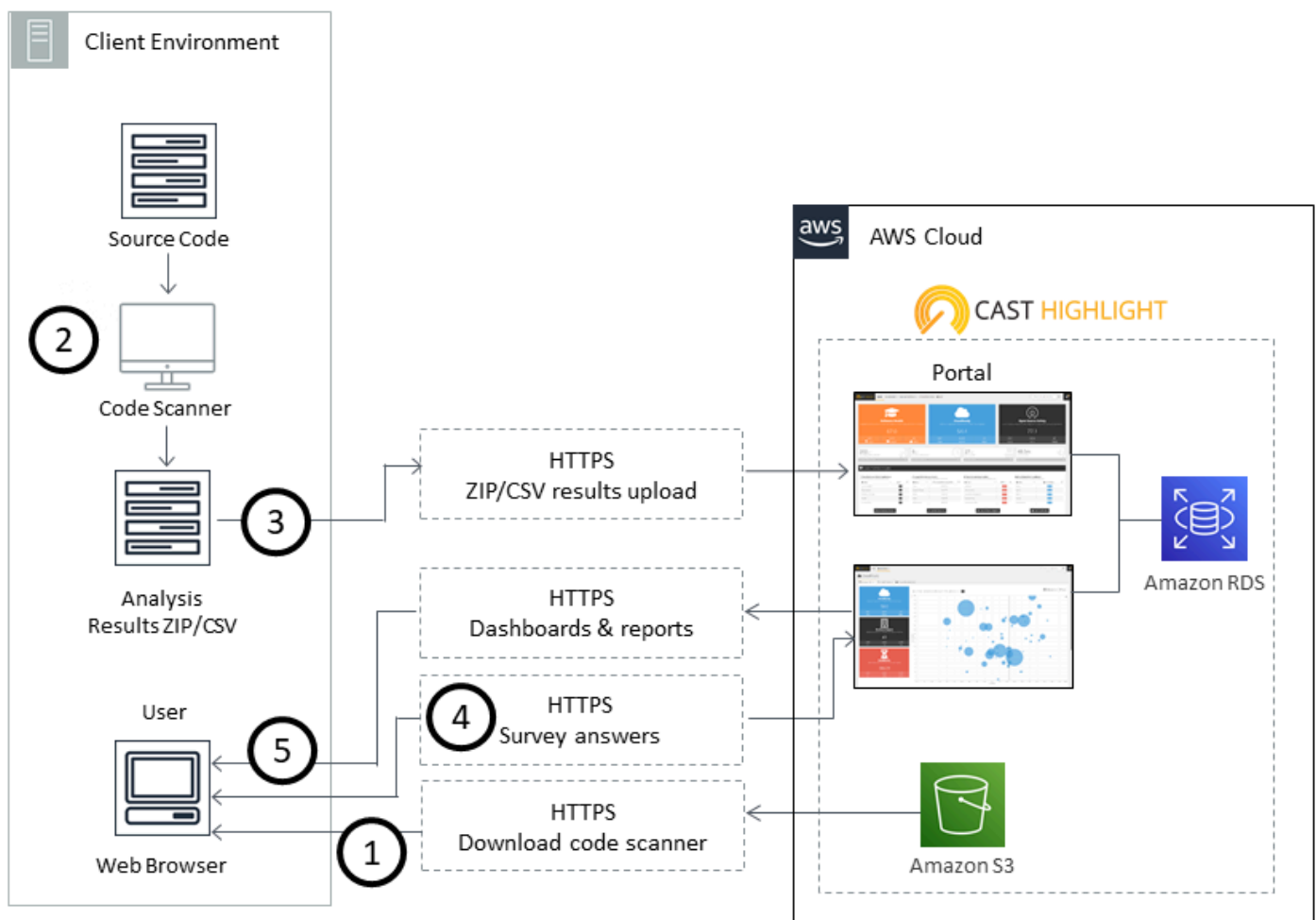

The workflow consists of the following steps:

1. Log in to the CAST Highlight portal, download the Local Agent, and install it on your local computer. Amazon Simple Storage Service (Amazon S3) stores the Local Agent installation package.
2. Scan your source code files and produce a results file.
3. Upload the results file to the CAST Highlight portal. **Important:** No source code is included in the results file.
4. Answer survey questions for each application that you scanned.
5. View the dashboards and reports available in the CAST Highlight portal. Amazon Relational Database Service (Amazon RDS) stores the code scan, analysis results, and the CAST Highlight software data.

## Technology stack

CAST Highlight supports the following technologies to analyze application cloud readiness:

- Java
- COBOL
- C#
- C++
- Clojure
- PHP
- JavaScript
- TypeScript
- Python
- Microsoft Transact-SQL
- VB.Net
- Kotlin
- Scala
- Swift

## Automation and scale

- A [CLI analyzer](#) can be used to automate the CAST Highlight analysis process.



## Tools

No tools are required for this pattern if all the prerequisites are met. However, you can choose to use optional tools, such as source code management (SCM) utilities, code extractors, or other tools to manage your source code files.

## Epics

### New user setup

Task	Description	Skills required
Activate your CAST Highlight account and choose your password.	All first-time CAST Highlight users receive an account activation email. Follow the activation link to activate your CAST Highlight account and enter a password to complete the activation process.	N/A
Log in to the CAST Highlight portal.	The CAST Highlight homepage appears after you enter your new password. Log in to the CAST Highlight portal with your user credentials.	N/A

### Application management

Task	Description	Skills required
Create an application record.	In the CAST Highlight portal, navigate to the <b>Manage Application</b> tab in the <b>Manage Portfolio</b> section. In the <b>Applications</b> tile at	N/A

Task	Description	Skills required
	the top of the screen, choose <b>Add</b> .	
Choose an application name.	Enter a name for your application, and then choose <b>Save</b> . This name is used for your application record in CAST Highlight.	N/A
Repeat the steps for all applications.	Repeat these steps for each application that you want to scan.	N/A

## Campaign management

Task	Description	Skills required
Create a campaign.	CAST Highlight uses “campaign” to describe a set of applications that will be analyzed at a specific time. In the CAST Highlight portal, navigate to the <b>Manage Campaigns</b> tab in the <b>Manage Portfolio</b> section. Choose <b>Create Campaign</b> to launch the campaign creation screen.	N/A
Enter a name and choose a closing date for the campaign.	Enter a name for your campaign and choose a closing date for it.  <b>Important:</b> Contributors cannot submit application	N/A

Task	Description	Skills required
	analysis results after the campaign's closing date.	
Decide to include source code scan, survey answers, and domain and application scope.	<p>Choose one or more of the standard surveys that are used to enhance the source code analysis data with qualitative information. The survey categories are <b>Business impact</b>, <b>Software maintenance effort</b>, <b>CloudReady</b>, <b>Application properties</b>, and <b>Green Impact</b>. Choose the domain and applications that are analyzed during the campaign.</p> <p><b>Important:</b> Make sure that you add all applications you want to scan in the <b>Manage Applications</b> section before you begin the campaign.</p>	N/A
Customize the launch message.	Customize the launch message that will be sent by email to all contributors associated with the applications in the campaign.	N/A
Launch the campaign.	Choose <b>Complete</b> to launch the campaign.	N/A

## Source code analysis

Task	Description	Skills required
Download the CAST Highlight Local Agent.	In the CAST Highlight portal, choose <b>Application Scans</b> and download the Local Agent to your local computer.	N/A
Install the Local Agent.	Launch the CASTHighlightSetup.exe installation program and follow the setup instructions that appear. After the Local Agent is installed, you are ready to analyze your applications.	N/A
Define the scope of the Local Agent code scan.	<p>The code analysis is performed at the file level and doesn't consider the logical links or dependencies among files. All files are considered equal and part of the application.</p> <p>To provide accurate and consistent results, prepare your code scan scope by using the file or folder exclusion features available in the Local Agent.</p>	N/A
Include open-source or COTS packages.	(Optional) If you want to include open-source or commercial off-the-shelf (COTS) packages, make sure they're included in the folders that you're planning	N/A

Task	Description	Skills required
	to scan. Typically, external libraries are grouped in a subfolder called "third-party" or something similar, and the main code is often located in the "src/main" file folder.	
Exclude test classes.	Test classes are typically excluded from the source code analysis because they are generally not part of the compiled application. However, you can choose to include them in the scan if required.	N/A
Exclude SCM, build, and deployment folders.	For more consistent results, you should avoid including SCM, build, or deployment folders (for example, .git or .svn files) in your scan.	N/A
Include dependency files.	If you want insights into frameworks and dependencies whose physical files are not part of the folder you're scanning, then make sure you include the dependency files (such as pom.xml, build.gradle, package.json, or .vcproj files).	N/A
Invoke the Local Agent.	Run the Local Agent on your local Windows machine.	N/A

Task	Description	Skills required
Choose the folder that contains your source code.	<p>Choose the folder that contains your source code. You can add multiple folders to be discovered by the Local Agent. Although the Local Agent does support source discovery through network paths, you should make sure source folders are located on your local machine.</p> <p><b>Important:</b> We recommend running multiple scans if there are more than 10,000 files in your source folders.</p>	N/A
Start file discovery.	<p>On the Local Agent dashboard, choose <b>Discover Files</b>. The Local Agent discovers files in your folders and subfolders, and detects their technologies. You can choose the <b>Cancel</b> button to cancel the discovery at any time.</p> <p>After the file discovery finishes, the Local Agent lists the folders and files that were found. The <b>Technologies</b> column shows associated technologies and file count. The <b>Path</b> column shows the location of the folders and files.</p>	N/A

Task	Description	Skills required
Refine the source code scan configuration.	<p>(Optional) To refine the Local Agent scan, you can deactivate one or more technologies for a specific folder or file. If all technologies are deactivated, your folder or file will be excluded from the scan's scope.</p> <p>To deactivate technologies, choose the yellow label of the technology you want to deactivate. You can also choose the filter icon when hovering over a file or a folder to associate a technology with a specific file or folder. These settings are saved and speed up the discovery process for the folder or file.</p>	N/A
Start source code scan.	After you configure your scan, choose "Scan Files" to begin the scanning process.	N/A

Task	Description	Skills required
Check for green or grey labels.	<p>After the source code scan is complete, a status label is shown at folder and file levels.</p> <p>A green label means that files were correctly scanned with the associated technology.</p> <p>A grey label means that files were not scanned and are excluded. The reason for their exclusion is shown when you hover over the label of each file. Possible reasons for file exclusion include binary files, unreadable files, missing files, external library, encoded files, generated files, syntax errors, content that isn't in the expected language, code that isn't compliant with enough analysis criteria, files that exceed the size limit (10 MB), timeout issues, or unavailability of the analyzer.</p>	N/A
Modify the scan configuration and scan code again.	(Optional) You can modify your scan configuration settings and choose <b>Scan Files</b> to scan the files again.	N/A
Confirm scan results.	Choose <b>Confirm Results</b> if the scan results meet your requirements.	N/A



Task	Description	Skills required
View frameworks and software libraries found by the Local Agent.	<p>View the frameworks and software libraries used or referenced by your applications, and discovered by the Local Agent during the code scan. You can keep or ignore elements from these lists by choosing their individual switch button.</p> <p>Choose <b>Confirm dependencies</b> to proceed.</p> <p><b>Important:</b> If a framework is turned off, it is not listed in the CAST Highlight portal or attached to your application.</p>	N/A

Task	Description	Skills required
Save code scan results.	<p>The Local Agent displays a summary of your code scan results grouped by technology. Choose <b>Save</b> and specify the folder you want the results to be saved to. The Local Agent generates one .zip file per scan, which contains all the analysis results.</p> <p>Depending on the number of distinct technologies and root source folders, the Local Agent automatically generates one or several .csv files with the <b>FolderName.Technology.date.csv</b> naming structure.</p>	N/A
Upload the code scan results to the CAST Highlight portal.	<p>In the CAST Highlight portal, choose the applications you analyzed in the <b>Application Scans</b> section. Choose <b>Upload Results</b> and choose the .csv files. You can also upload the .csv files individually. After each file is uploaded, a record of the upload appears on your screen.</p>	N/A

Task	Description	Skills required
Delete analysis result files, if required.	<p>(Optional) An analysis results file can be deleted at any time during the upload process by choosing the trash can icon.</p> <p><b>Important:</b> Only users with Portfolio Manager privileges or the contributor who uploaded the results can delete the results.</p>	N/A
Answer application survey.	<p>A <b>Survey</b> button appears on applications that require a survey. Choose <b>Survey</b>, answer the questions for each section of the survey, and choose <b>Submit</b> after you finish.</p> <p>The progress of your survey is displayed at the top of your screen. You are able to submit your results after all mandatory information is submitted. However, you can enrich the data in your organization's CAST Highlight instance by answering all the questions.</p>	N/A

Task	Description	Skills required
Submit code scan results.	After you upload all the .csv result files for the application and complete the survey questions, choose <b>Submit</b> in the <b>Application Scans</b> section. This step is required to complete the process and ensure that the results are available in the CAST Highlight portal.	N/A

## Results analysis

Task	Description	Skills required
View CAST Highlight portal homepage.	The CAST Highlight portal homepage includes tiles that have high-level information about your application portfolio, such as software health, CloudReady, and open-source safety scores for your entire portfolio. The homepage also includes the number of onboarded applications. For more information about the CAST Highlight metrics definitions and measurement methodology, see <a href="#">CAST Highlight – Metrics and methodology (Microsoft PowerPoint presentation)</a> .	N/A

Task	Description	Skills required
View the CloudReady dashboard.	Choose the <b>CloudReady</b> tile to open the CloudReady dashboard. This is the primary portfolio-level dashboard for assessing the cloud readiness of your applications. It helps you plan and develop a portfolio roadmap for your cloud migration	N/A

Task	Description	Skills required
View the Portfolio Advisor for Cloud dashboard.	<p>The Portfolio Advisor for Cloud dashboard automatically segments applications into recommended migration categories. Segmentation is based on the technical characteristics of each application. Factors include the source code analysis (cloud readiness, software resiliency, and more) and the business impact, which comes from the survey. In the upper right, choose <b>Compute</b> to generate the initial segmentation recommendations.</p> <p>The bubbles in the charts at the top of the dashboard represent each application in the portfolio, organized by the recommended segmentation. Each application is also listed in a data table below the charts, including relevant metrics for each application.</p> <p>The possible segments that are recommended include:</p> <ul style="list-style-type: none"><li>• <b>Rehost</b> – A recommendation to change the infrastructure configuration of the application in order</li></ul>	N/A

Task	Description	Skills required
	<p>to <i>lift and shift</i> it to the cloud by using an infrastructure as a service (IaaS) solution.</p> <ul style="list-style-type: none"><li data-bbox="592 415 1027 877">• <b>Refactor</b> – A recommendation to perform modest modifications of the application code without changing the architecture or functionality so that it can be migrated by using a container as a service (CaaS) or platform as a service (PaaS) solution.</li><li data-bbox="592 898 1027 1402">• <b>Rearchitect</b> – A recommendation to dramatically modify the application code to improve the health of the application and to prepare it for migration by using a PaaS solution or deploy it as a serverless application by using a function as a service (FaaS) solution.</li><li data-bbox="592 1423 1027 1801">• <b>Rebuild</b> – A recommendation to discard the code of the application and develop it again in the cloud by using a PaaS solution or develop it again as a serverless application by using a FaaS solution.</li></ul>	

Task	Description	Skills required
	<ul style="list-style-type: none"><li>• <b>Retire</b> – A recommendation to discard the application altogether or potentially replace it with a commercial software as a service (SaaS) alternative.</li></ul>	
Modify segmentation recommendations.	<p>In some cases, you might choose to change the segment recommended by CAST Highlight. You can do this by browsing to the application in the data table and selecting a different segment from the drop-down list next to the application name. Then choose <b>Save</b> in the upper right to save your changes.</p> <p>You can also export this data at any time by choosing <b>Export</b> in the upper right.</p>	N/A



Task	Description	Skills required
Choose an application to analyze.	<p>On the Portfolio Advisor for Cloud dashboard, choose an application bubble to analyze that application. Choose the name of the application in the table after the bubble chart to begin the deeper analysis.</p> <p>Different dashboards are available to analyze individual applications, such as <b>Code Insights</b> (software health patterns), <b>Trends</b>, and <b>Software Composition</b> (open-source risks).</p>	N/A

Task	Description	Skills required
Analyze the CloudReady results of an individual application.	<p>Choose the <b>CloudReady</b> tab, which shows the application's overall CloudReady score. This score is a weighted average based on a combination of the CloudReady survey answers and the CloudReady code scan. The answers to the survey questions appear in the table below the tiles.</p> <p>Choose <b>CloudReady Code Scan</b> to view the code scan results. There is a list of CloudReady patterns that the application code was scanned for. This list includes the following columns:</p> <ul style="list-style-type: none"><li>• <b>Cloud Requirement</b> is the specific code pattern.</li><li>• <b>Technology</b> is the pattern's programming language. "Impact" is the pattern's impact on the application (C = code, F = framework, A = architecture).</li><li>• <b>Criticality</b> is the level of importance of addressing this pattern before migrating.</li><li>• <b>Contribution</b> is how this pattern contributes to the overall CloudReady score.</li></ul>	N/A

Task	Description	Skills required
	<p>If the pattern is green, it is a booster and increases the CloudReady score. If the pattern is red, it is a blocker and decreases the CloudReady score. If the pattern has no color, it is a blocker that was not detected and increases the CloudReady score.</p> <ul style="list-style-type: none"> <li>• <b>Roadblocks</b> are the number of individual occurrences of a blocker pattern. Choose the roadblock number to show a list of the source code files where the pattern was detected.</li> <li>• <b>Est. Effort</b> is an estimate of the number of days it will take to remediate the roadblocks in each row.</li> </ul>	
Export data to Microsoft Excel.	(Optional) Choose <b>Export to Excel</b> to export the data for further analysis. The application analysis results data can be used to further analyze the cloud readiness of an application and determine what code must be updated before a migration.	N/A

Task	Description	Skills required
View recommendations.	<p>Choose <b>Recommendations</b> next to <b>CloudReady Code Scan</b> to view the <b>Cloud Service Recommendations</b> screen. This identifies AWS services that the application could adopt based on its characteristics.</p> <p>Repeat this step to view recommendations for all the applications that you analyzed.</p>	N/A

## Related resources

### Campaign management

- [CAST Highlight Foundation Certification Training Section 3: Portfolio Configuration](#) (video)

### Source code analysis

- [CAST Highlight Foundation Certification Training Section 4: Application Analysis](#) (video)

### Other resources

- [CAST Highlight in AWS Marketplace](#)
- [AWS and CAST: Accelerate application modernization](#)
- [CAST Highlight – Documentation, product tutorials, and third-party tools](#)
- [CAST Highlight – Cloud Readiness Product Demo](#) (video)
- [Application Portfolio Modernization with CAST Highlight](#) (AWS workshop)

# Automatically archive items to Amazon S3 using DynamoDB TTL

Created by Tabby Ward (AWS)

**Code repository:** [Archive items to S3 using DynamoDB TTL](#)

**Environment:** PoC or pilot

**Technologies:** Modernization; Databases; Serverless; Storage & backup; Cost management

**Workload:** Open-source

**AWS services:** Amazon S3; Amazon DynamoDB; Amazon Kinesis; AWS Lambda

## Summary

This pattern provides steps to remove older data from an Amazon DynamoDB table and archive it to an Amazon Simple Storage Service (Amazon S3) bucket on Amazon Web Services (AWS) without having to manage a fleet of servers.

This pattern uses Amazon DynamoDB Time to Live (TTL) to automatically delete old items and Amazon DynamoDB Streams to capture the TTL-expired items. It then connects DynamoDB Streams to AWS Lambda, which runs the code without provisioning or managing any servers.

When new items are added to the DynamoDB stream, the Lambda function is initiated and writes the data to an Amazon Data Firehose delivery stream. Firehose provides a simple, fully managed solution to load the data as an archive into Amazon S3.

DynamoDB is often used to store time series data, such as webpage click-stream data or Internet of Things (IoT) data from sensors and connected devices. Rather than deleting less frequently accessed items, many customers want to archive them for auditing purposes. TTL simplifies this archiving by automatically deleting items based on the timestamp attribute.

Items deleted by TTL can be identified in DynamoDB Streams, which captures a time-ordered sequence of item-level modifications and stores the sequence in a log for up to 24 hours. This data can be consumed by a Lambda function and archived in an Amazon S3 bucket to reduce the storage cost. To further reduce the costs, [Amazon S3 lifecycle rules](#) can be created to automatically

transition the data (as soon as it gets created) to lowest-cost [storage classes](#), such as S3 Glacier Instant Retrieval or S3 Glacier Flexible Retrieval, or Amazon S3 Glacier Deep Archive for long-term storage.

## Prerequisites and limitations

### Prerequisites

- An active AWS account.
- [AWS Command Line Interface \(AWS CLI\) 1.7 or later](#), installed and configured on macOS, Linux, or Windows.
- [Python 3.7](#) or later.
- [Boto3](#), installed and configured. If Boto3 is not already installed, run the `python -m pip install boto3` command to install it.

## Architecture

### Technology stack

- Amazon DynamoDB
- Amazon DynamoDB Streams
- Amazon Data Firehose
- AWS Lambda
- Amazon S3

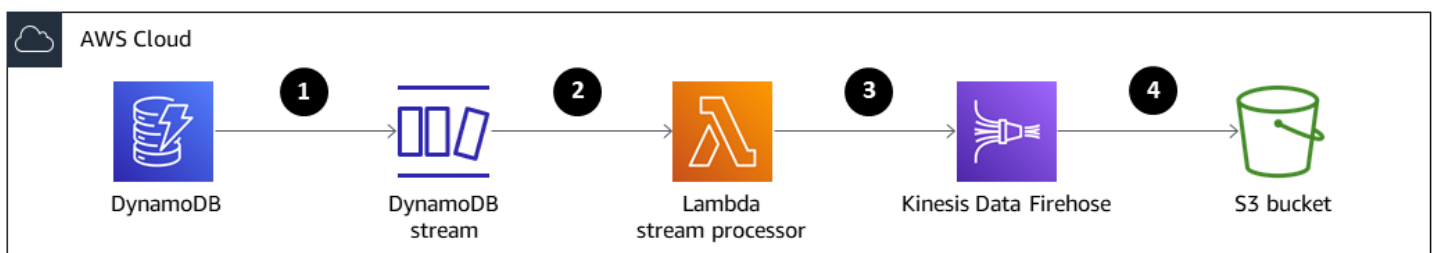

1. Items are deleted by TTL.
2. The DynamoDB stream trigger invokes the Lambda stream processor function.
3. The Lambda function puts records in the Firehose delivery stream in batch format.
4. Data records are archived in the S3 bucket.

## Tools

- [AWS CLI](#) – The AWS Command Line Interface (AWS CLI) is a unified tool to manage your AWS services.
- [Amazon DynamoDB](#) – Amazon DynamoDB is a key-value and document database that delivers single-digit millisecond performance at any scale.
- [Amazon DynamoDB Time to Live \(TTL\)](#) – Amazon DynamoDB TTL helps you define a per-item timestamp to determine when an item is no longer required.
- [Amazon DynamoDB Streams](#) – Amazon DynamoDB Streams captures a time-ordered sequence of item-level modifications in any DynamoDB table and stores this information in a log for up to 24 hours.
- [Amazon Data Firehose](#) – Amazon Data Firehose is the easiest way to reliably load streaming data into data lakes, data stores, and analytics services.
- [AWS Lambda](#) – AWS Lambda runs code without the need to provision or manage servers. You pay only for the compute time you consume.
- [Amazon S3](#) – Amazon Simple Storage Service (Amazon S3) is an object storage service that offers industry-leading scalability, data availability, security, and performance.

## Code

The code for this pattern is available in the GitHub [Archive items to S3 using DynamoDB TTL](#) repository.

## Epics

### Set up a DynamoDB table, TTL , and a DynamoDB stream

Task	Description	Skills required
Create a DynamoDB table.	Use the AWS CLI to create a table in DynamoDB called <code>Reservation</code> . Choose random read capacity unit (RCU) and write capacity unit (WCU), and give your table two attributes: <code>Reservati</code>	Cloud architect, App developer

Task	Description	Skills required
	<p>onID and ReservationDate .</p> <pre data-bbox="594 331 1029 1205">aws dynamodb create-table \ --table-name Reservation \ --attribute-definitions AttributeName=ReservationID,AttributeType=S AttributeName=ReservationDate,AttributeType=N \ --key-schema AttributeName=ReservationID,KeyType=HASH AttributeName=ReservationDate,KeyType=RANGE \ --provisioned-throughput ReadCapacityUnits=100,WriteCapacityUnits=100</pre> <p>ReservationDate is an epoch timestamp that will be used to turn on TTL.</p>	



Task	Description	Skills required
Turn on DynamoDB TTL.	<p>Use the AWS CLI to turn on DynamoDB TTL for the ReservationDate attribute.</p> <pre data-bbox="597 443 1027 800">aws dynamodb update-time-to-live \ --table-name Reservati\ on\ --time-to-live-specification Enabled=true,AttributeName=ReservationDate</pre>	Cloud architect, App developer

Task	Description	Skills required
Turn on a DynamoDB stream.	<p>Use the AWS CLI to turn on a DynamoDB stream for the Reservation table by using the NEW_AND_OLD_IMAGES stream type.</p> <pre data-bbox="594 491 1029 890">aws dynamodb update-table \ --table-name Reservation \ --stream-specification StreamEnabled=true,StreamViewType=NEW_AND_OLD_IMAGES</pre> <p>This stream will contain records for new items, updated items, deleted items, and items that are deleted by TTL. The records for items that are deleted by TTL contain an additional metadata attribute to distinguish them from items that were deleted manually. The <code>userIdentity</code> field for TTL deletions indicates that the DynamoDB service performed the delete action.</p> <p>In this pattern, only the items deleted by TTL are archived, but you could archive only the records where <code>eventName</code> is <code>REMOVE</code> and <code>userIdent</code></p>	Cloud architect, App developer

Task	Description	Skills required
	ity contains principal Id equal to dynamodb.amazonaws.com .	

## Create and configure an S3 bucket

Task	Description	Skills required
Create an S3 bucket.	<p>Use the AWS CLI to create a destination S3 bucket in your AWS Region, replacing us-east-1 with your Region and amzn-s3-demo-destination-bucket with the name of your bucket.</p> <pre>aws s3api create-bucket \   --bucket amzn-s3-demo-destination-bucket \   --region us-east-1</pre> <p>Make sure that your S3 bucket's name is globally unique, because the namespace is shared by all AWS accounts.</p>	Cloud architect, App developer
Create a 30-day lifecycle policy for the S3 bucket.	<ol style="list-style-type: none"> <li>1. Sign in to the AWS Management Console and open the Amazon S3 console.</li> <li>2. Choose the S3 bucket that contains the data from Firehose.</li> </ol>	Cloud architect, App developer

Task	Description	Skills required
	<ol style="list-style-type: none"> <li>3. In the S3 bucket, choose the <b>Management</b> tab, and choose <b>Add lifecycle rule</b>.</li> <li>4. Enter a name for your rule in the <b>Lifecycle rule</b> dialog box, and configure a 30-day lifecycle rule for your bucket.</li> </ol>	

### Create a Firehose delivery stream

Task	Description	Skills required
<p>Create and configure a Firehose delivery stream.</p>	<p>Download and edit the <code>CreateFireHoseToS3.py</code> code example from the GitHub repository.</p> <p>This code is written in Python and shows you how to create a Firehose delivery stream and an AWS Identity and Access Management (IAM) role. The IAM role will have a policy that can be used by Firehose to write to the destination S3 bucket.</p> <p>To run the script, use the following command and command line arguments.</p> <p>Argument 1= <code>&lt;Your_S3_bucket_ARN&gt;</code> , which is the Amazon Resource Name</p>	<p>Cloud architect, App developer</p>

Task	Description	Skills required
	<p>(ARN) for the bucket that you created earlier</p> <p>Argument 2= Your Firehose name (This pilot is using <code>firehose_to_s3_stream</code> .)</p> <p>Argument 3= Your IAM role name (This pilot is using <code>firehose_to_s3</code> .)</p> <pre data-bbox="594 730 1027 968">python CreateFireHoseToS3.py &lt;Your_S3_Bucket_ARN&gt; firehose_to_s3_stream firehose_to_s3</pre> <p>If the specified IAM role does not exist, the script will create an assume role with a trusted relationship policy, as well as a policy that grants sufficient Amazon S3 permission. For examples of these policies, see the <i>Additional information</i> section.</p>	

Task	Description	Skills required
Verify the Firehose delivery stream.	<p>Describe the Firehose delivery stream by using the AWS CLI to verify that the delivery stream was successfully created.</p> <pre>aws firehose describe-delivery-stream --delivery-stream-name firehose_to_s3_stream</pre>	Cloud architect, App developer

## Create a Lambda function to process the Firehose delivery stream

Task	Description	Skills required
Create a trust policy for the Lambda function.	<p>Create a trust policy file with the following information.</p> <pre>{   "Version":   "2012-10-17",   "Statement": [     {       "Effect":       "Allow",       "Principal":       {         "Service":         : "lambda.amazonaws.com"       },       "Action":       "sts:AssumeRole"     }   ] }</pre>	Cloud architect, App developer

Task	Description	Skills required
	This gives your function permission to access AWS resources.	
Create an execution role for the Lambda function.	To create the execution role, run the following code. <pre data-bbox="597 506 1027 747">aws iam create-role   --role-name lambda- ex --assume-role-poli cy-document file://Tr ustPolicy.json</pre>	Cloud architect, App developer

Task	Description	Skills required
Add permission to the role.	<p>To add permission to the role, use the <code>attach-policy-to-role</code> command.</p> <pre data-bbox="594 394 1026 1423">aws iam attach-role-policy --role-name lambda-ex --policy-arn arn:aws:iam::aws:policy/service-role/AWSLambdaBasicExecutionRole aws iam attach-role-policy --role-name lambda-ex --policy-arn arn:aws:iam::aws:policy/service-role/AWSLambdaDynamoDBExecutionRole aws iam attach-role-policy --role-name lambda-ex --policy-arn arn:aws:iam::aws:policy/AmazonKinesisFirehoseFullAccess aws iam attach-role-policy --role-name lambda-ex --policy-arn arn:aws:iam::aws:policy/IAMFullAccess</pre>	Cloud architect, App developer



Task	Description	Skills required
Create a Lambda function.	<p>Compress the <code>LambdaStreamProcessor.py</code> file from the code repository by running the following command.</p> <pre data-bbox="597 491 1026 646">zip function.zip LambdaStreamProcessor.py</pre> <p>When you create the Lambda function, you will need the Lambda execution role ARN. To get the ARN, run the following code.</p> <pre data-bbox="597 953 1026 1066">aws iam get-role \ --role-name lambda-ex</pre> <p>To create the Lambda function, run the following code.</p> <pre data-bbox="597 1276 1026 1837"># Review the environment variables and replace them with your values.  aws lambda create-function --function-name LambdaStreamProcessor \ --zip-file fileb://function.zip --handler LambdaStreamProcessor.handler --runtime python3.8 \ </pre>	Cloud architect, App developer

Task	Description	Skills required
	<pre>--role {Your Lamda Execution Role ARN}\ --environment Variables="{fireho se_name=firehose_t o_s3_stream,bucket _arn = &lt;Your_S3_ bucket_ARN&gt;,iam_ro le_name = firehose_ to_s3, batch_siz e=400}"</pre>	
<p>Configure the Lambda function trigger.</p>	<p>Use the AWS CLI to configure the trigger (DynamoDB Streams), which invokes the Lambda function. The batch size of 400 is to avoid running into Lambda concurrency issues.</p> <pre>aws lambda create-ev ent-source-mapping -- function-name LambdaStr eamProcessor \ --batch-size 400 -- starting-position LATEST \ --event-source-arn &lt;Your Latest Stream ARN From DynamoDB Console&gt;</pre>	<p>Cloud architect, App developer</p>

## Test the functionality

Task	Description	Skills required
<p>Add items with expired timestamps to the Reservation table.</p>	<p>To test the functionality, add items with expired epoch timestamps to the Reservation table. TTL will automatically delete items based on the timestamp.</p> <p>The Lambda function is initiated upon DynamoDB Stream activities, and it filters the event to identify REMOVE activity or deleted items. It then puts records in the Firehose delivery stream in batch format.</p> <p>The Firehose delivery stream transfers items to a destination S3 bucket with the <code>firehose-to-s3-example/year=current year/month=current month/day=current day/hour=current hour/ prefix</code>.</p> <p><b>Important:</b> To optimize data retrieval, configure Amazon S3 with the <code>Prefix</code> and <code>ErrorOutputPrefix</code> that are detailed in the <i>Additional information</i> section.</p>	<p>Cloud architect</p>

## Clean up the resources

Task	Description	Skills required
Delete all resources.	Delete all the resources to ensure that you aren't charged for any services that you aren't using.	Cloud architect, App developer

## Related resources

- [Managing your storage lifecycle](#)
- [Amazon S3 Storage Classes](#)
- [AWS SDK for Python \(Boto3\) documentation](#)

## Additional information

### Create and configure a Firehose delivery stream – Policy examples

*Firehose trusted relationship policy example document*

```
firehose_assume_role = {
    'Version': '2012-10-17',
    'Statement': [
        {
            'Sid': '',
            'Effect': 'Allow',
            'Principal': {
                'Service': 'firehose.amazonaws.com'
            },
            'Action': 'sts:AssumeRole'
        }
    ]
}
```

*S3 permissions policy example*

```
s3_access = {
```

```

    "Version": "2012-10-17",
    "Statement": [
      {
        "Sid": "",
        "Effect": "Allow",
        "Action": [
          "s3:AbortMultipartUpload",
          "s3:GetBucketLocation",
          "s3:GetObject",
          "s3:ListBucket",
          "s3:ListBucketMultipartUploads",
          "s3:PutObject"
        ],
        "Resource": [
          "{your s3_bucket ARN}/*",
          "{Your s3 bucket ARN}"
        ]
      }
    ]
  }
}

```

## Test the functionality – Amazon S3 configuration

The Amazon S3 configuration with the following Prefix and ErrorOutputPrefix is chosen to optimize data retrieval.

### Prefix

```

firehose-to-s3-example/year=! {timestamp: yyyy}/month=! {timestamp:MM}/day=!
{timestamp:dd}/hour=!{timestamp:HH}/

```

Firehose first creates a base folder called `firehose-to-s3-example` directly under the S3 bucket. It then evaluates the expressions `!{timestamp: yyyy}`, `!{timestamp:MM}`, `!{timestamp:dd}`, and `!{timestamp:HH}` to year, month, day, and hour using the Java [DateTimeFormatter](#) format.

For example, an approximate arrival timestamp of 1604683577 in Unix epoch time evaluates to `year=2020`, `month=11`, `day=06`, and `hour=05`. Therefore, the location in Amazon S3, where data records are delivered, evaluates to `firehose-to-s3-example/year=2020/month=11/day=06/hour=05/`.

### ErrorOutputPrefix

```
firehose-3-error-output-base/!{firehose:random-string}/!{firehose:error-output-type}/!  
{timestamp:yyyy/MM/dd}/
```

The `ErrorOutputPrefix` results in a base folder called `firehose-3-error-output-base` directly under the S3 bucket. The expression `!{firehose:random-string}` evaluates to an 11-character random string such as `ztWxkdg3Thg`. The location for an Amazon S3 object where failed records are delivered could evaluate to `firehose-3-error-output-base/ztWxkdg3Thg/processing-failed/2020/11/06/`.

# Build a Micro Focus Enterprise Server PAC with Amazon EC2 Auto Scaling and Systems Manager

Created by Kevin Yung (AWS), Peter Woods (Micro Focus), Abraham Rondon (Micro Focus), and Krithika Palani Selvam (AWS)

**Environment:** Production

**Technologies:** Modernization; CloudNative; DevOps; Infrastructure

## Summary

This pattern introduces a scalable architecture for mainframe applications using [Micro Focus Enterprise Server in Scale-Out Performance and Availability Cluster \(PAC\)](#) and an Amazon Elastic Compute Cloud (Amazon EC2) Auto Scaling group on Amazon Web Services (AWS). The solution is fully automated with AWS Systems Manager and Amazon EC2 Auto Scaling lifecycle hooks. By using this pattern, you can set up your mainframe online and batch applications to achieve high resiliency by automatically scaling in and out based on your capacity demands.

## Prerequisites and limitations

### Prerequisites

- An active AWS account.
- Micro Focus Enterprise Server software and license. For details, contact [Micro Focus sales](#).
- An understanding of the concept of rebuilding and delivering a mainframe application to run in Micro Focus Enterprise Server. For a high-level overview, see [Micro Focus Enterprise Server Data Sheet](#).
- An understanding of the concepts in Micro Focus Enterprise Server scale-out Performance and Availability Cluster. For more information, see the [Micro Focus Enterprise Server documentation](#).
- An understanding of the overall concept of mainframe application DevOps with continuous integration (CI). For an AWS Prescriptive Guidance pattern that was developed by AWS and Micro Focus, see [Mainframe modernization: DevOps on AWS with Micro Focus](#).

### Limitations

- For a list of platforms that are supported by Micro Focus Enterprise Server, see the [Micro Focus Enterprise Server Data Sheet](#).
- The scripts and tests used in this pattern are based on Amazon EC2 Windows Server 2019; other Windows Server versions and operating systems were not tested for this pattern.
- The pattern is based on Micro Focus Enterprise Server 6.0 for Windows; earlier or later releases were not tested in the development of this pattern.

## Product versions

- Micro Focus Enterprise Server 6.0
- Windows Server 2019

## Architecture

In the conventional mainframe environment, you must provision hardware to host your applications and corporate data. To cater for and meet the spikes in seasonal, monthly, quarterly, or even unprecedented or unexpected demands, mainframe users must *scale out* by purchasing additional storage and compute capacity. Increasing the number of storage and compute capacity resources improves overall performance, but the scaling is not linear.

This is not the case when you start adopting an on-demand consumption model on AWS by using Amazon EC2 Auto Scaling and Micro Focus Enterprise Servers. The following sections explain detail how to build a fully automated, scalable mainframe application architecture using Micro Focus Enterprise Server Scale-Out Performance and Availability Cluster (PAC) with an Amazon EC2 Auto Scaling group.

### Micro Focus Enterprise Server automatic scaling architecture

First, it is important to understand the basic concepts of Micro Focus Enterprise Server. This environment provides a mainframe-compatible, x86 deployment environment for applications that have traditionally run on the IBM mainframe. It delivers both online and batch runs and a transaction environment that supports the following:

- IBM COBOL
- IBM PL/I
- IBM JCL batch jobs
- IBM CICS and IMS TM transactions



- Web services
- Common batch utilities, including SORT

Micro Focus Enterprise Server enables mainframe applications to run with minimal changes. Existing mainframe workloads can be moved to x86 platforms and modernized to take advantage of AWS Cloud native extensions for rapid expansion to new markets or geographies.

The AWS Prescriptive Guidance pattern [Mainframe modernization: DevOps on AWS with Micro Focus](#) introduced the architecture to accelerate the development and testing of mainframe applications on AWS using Micro Focus Enterprise Developer and Enterprise Test Server with AWS CodePipeline and AWS CodeBuild. This pattern focuses on the deployment of mainframe applications to the AWS production environment to achieve high availability and resiliency.

In a mainframe production environment, you might have set up IBM Parallel Sysplex in the mainframe to achieve high performance and high availability. To create a scale-out architecture similar to Sysplex, Micro Focus introduced the Performance and Availability Cluster (PAC) to Enterprise Server. PACs support mainframe application deployment onto multiple Enterprise Server regions managed as a single image and scaled out in Amazon EC2 instances. PACs also support predictable application performance and system throughput on demand.

In a PAC, multiple Enterprise Server instances work together as a single logical entity. Failure of one Enterprise Server instance, therefore, will not interrupt business continuity because capacity is shared with other regions while new instances are automatically started using industry standard functionality such as an Amazon EC2 Auto Scaling group. This removes single points of failure, improving resilience to hardware, network, and application issues. Scaled-out Enterprise Server instances can be operated and managed by using the Enterprise Server Common Web Administration (ESCWA) APIs, simplifying the operational maintenance and serviceability of Enterprise Servers.

**Note:** Micro Focus recommends that the [Performance and Availability Cluster \(PAC\)](#) should consist of at least three Enterprise Server regions so that availability is not compromised in the event an Enterprise Server region fails or requires maintenance.

PAC configuration requires a supported relational database management service (RDBMS) to manage the region database, a cross-region database, and optional data store databases. A data store database should be used to managed Virtual Storage Access Method (VSAM) files using the Micro Focus Database File Handler support to improve availability and scalability. Supported RDBMSs include the following:

- Microsoft SQL Server 2009 R2 and later
- PostgreSQL 10.x, including Amazon Aurora PostgreSQL-Compatible Edition
- DB2 10.4 and later

For details of supported RDBMS and PAC requirements, see [Micro Focus Enterprise Server - Prerequisites](#) and [Micro Focus Enterprise Server - Recommended PAC Configuration](#).

The following diagram shows a typical AWS architecture setup for a Micro Focus PAC.

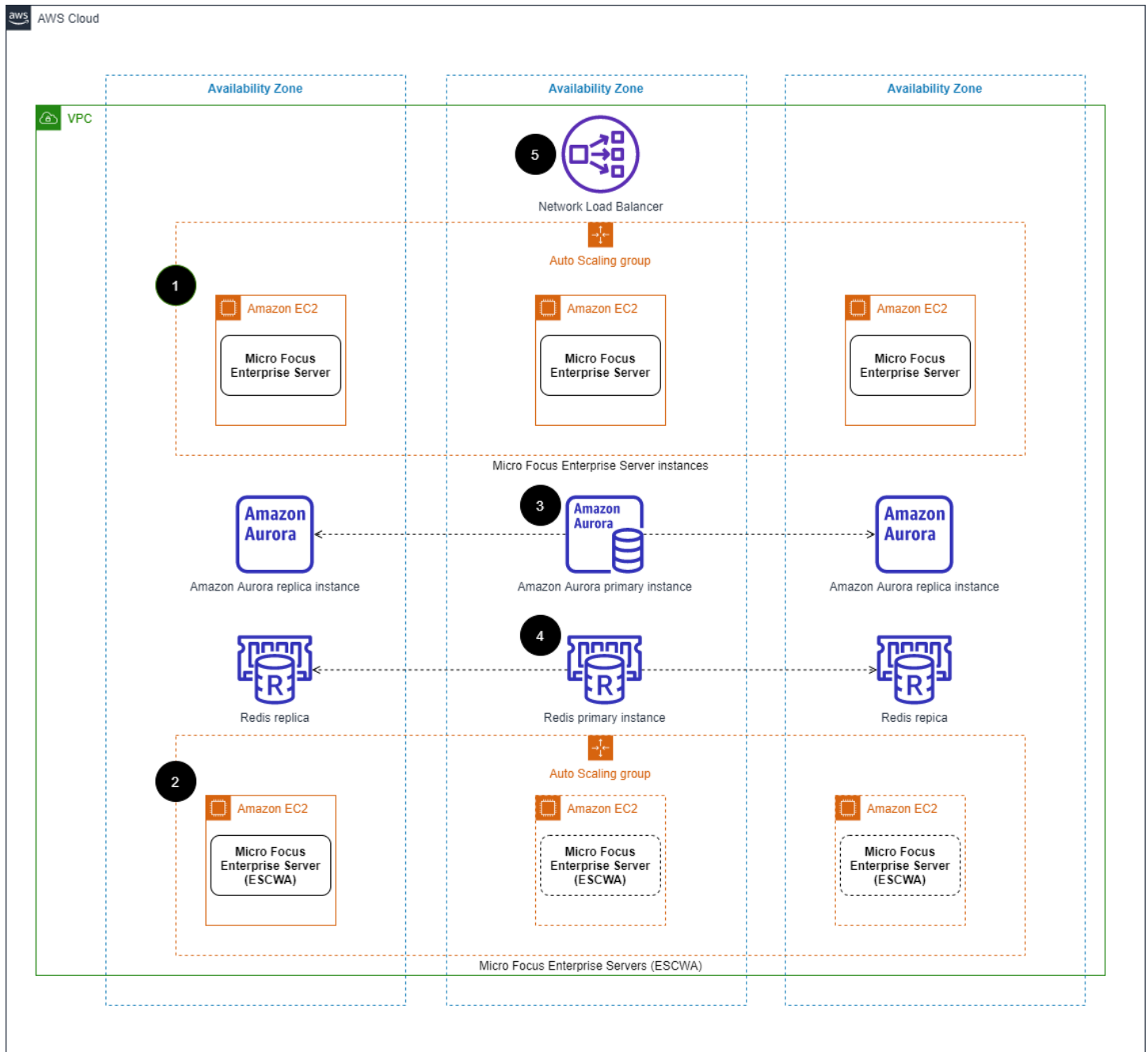

	<b>Component</b>	<b>Description</b>
1	Enterprise Server instances automatic scaling group	Set up an automatic scaling group deployed with Enterprise Server instances in a PAC. The number of instances can be scaled out or in initiated by Amazon CloudWatch alarms using CloudWatch metrics.
2	Enterprise Server ESCWA instances automatic scaling group	Set up an automatic scaling group deployed with Enterprise Server Common Web Administration (ESCWA). ESCWA provides cluster management APIs. The ESCWA servers act as a control plane to add or remove Enterprise Servers and start or stop Enterprise Server regions in the PAC during the Enterprise Server instance automatic scaling events. Because the ESCWA instance is used only for the PAC management, its traffic pattern is predictable, and its automatic scaling desired capacity requirement can be set to 1.
3	Amazon Aurora instance in a Multi-AZ setup	Set up a relational database management system (RDBMS) to host both user and system data files to be shared

across the Enterprise Server instances.

- |   |   |   |
|---|---|---|
| 4 | Amazon ElastiCache for Redis instance and replica | Set up an ElastiCache Redis primary instance and at least one replica to host user data and act as a scale-out repository (SOR) for the Enterprise Server instances . You can configure one or more <a href="#">scale-out repository</a> to store specific types of user data. Enterprise Server uses a Redis NoSQL database as an SOR, <a href="#">a requirement to maintain PAC integrity</a> . |
| 5 | Network Load Balancer                             | Set up a load balancer, providing a hostname for applications to connect to the services provided by Enterprise Server instances (for example, accessing the application through a 3270 emulator).  |

These components form the minimum requirement for a Micro Focus Enterprise Server PAC cluster. The next section covers cluster management automation.

### Using AWS Systems Manager Automation for scaling

After the PAC cluster is deployed on AWS, the PAC is managed through the Enterprise Server Common Web Administration (ESCWA) APIs.

To automate the cluster management tasks during automatic scaling events, you can use Systems Manager Automation runbooks and Amazon EC2 Auto Scaling with Amazon EventBridge. The architecture of these automations is shown in the following diagram.

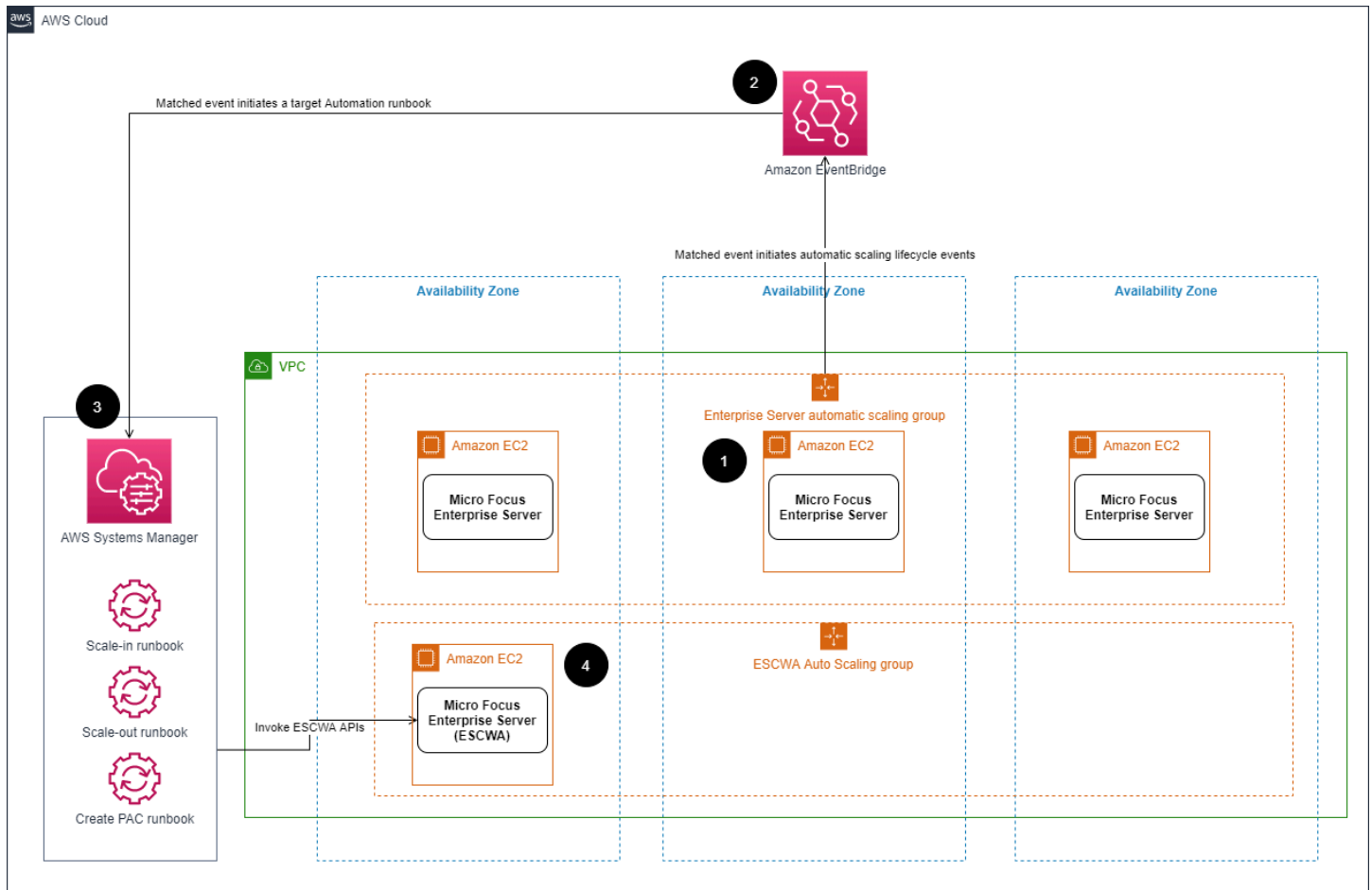

**Component**

**Description**

- |   |                                  |   |
|---|----------------------------------|---|
| 1 | Automatic scaling lifecycle hook | Set up automatic scaling lifecycle hooks and send notifications to Amazon EventBridge when new instances are launched and existing instances are terminated in the automatic scaling group. |
| 2 | Amazon EventBridge               | Set up an Amazon EventBridge rule to route automatic scaling events to Systems Manager Automation runbook targets.  |

3	Automation runbooks	Set up Systems Manager Automation runbooks to run Windows PowerShell scripts and invoke ESCWA APIs to manage the PAC. For examples, see the <i>Additional information</i> section.
4	Enterprise Server ESCWA instance in an automatic scaling group	Set up an Enterprise Server ESCWA instance in an automatic scaling group. The ESCWA instance provides APIs to manage the PAC.

## Tools

- [Micro Focus Enterprise Server](#) – Micro Focus Enterprise Server provides the run environment for applications created with any integrated development environment (IDE) variant of Enterprise Developer.
- [Amazon EC2 Auto Scaling](#) – Amazon EC2 Auto Scaling helps you ensure that you have the correct number of Amazon EC2 instances available to handle the load for your application. You create collections of EC2 instances, called Auto Scaling groups, and specify minimum and maximum numbers of instances.
- [Amazon ElastiCache for Redis](#) – Amazon ElastiCache is a web service for setting up, managing, and scaling a distributed in-memory data store or cache environment in the cloud. It provides a high-performance, scalable, and cost-effective caching solution.
- [Amazon RDS](#) – Amazon Relational Database Service (Amazon RDS) is a web service that makes it easier to set up, operate, and scale a relational database in the AWS Cloud. It provides cost-efficient, resizable capacity for a relational database and manages common database administration tasks.
- [AWS Systems Manager](#) – AWS Systems Manager is an AWS service that you can use to view and control your infrastructure on AWS. Using the Systems Manager console, you can view operational data from multiple AWS services and automate operational tasks across your AWS resources. Systems Manager helps you maintain security and compliance by scanning your

managed instances and reporting on (or taking corrective action on) any policy violations it detects.

## Epics

### Create an Amazon Aurora instance

Task	Description	Skills required
Create an AWS CloudFormation template for an Amazon Aurora instance.	Use the <a href="#">AWS example code snippet</a> to make a CloudFormation template that will create an Amazon Aurora PostgreSQL-Compatible Edition instance.	Cloud architect
Deploy a CloudFormation stack to create the Amazon Aurora instance.	Use the CloudFormation template to create an Aurora PostgreSQL-Compatible instance that has Multi-AZ replication enabled for production workloads.	Cloud architect
Configure database connection settings for Enterprise Server.	Follow the instructions in the <a href="#">Micro Focus documentation</a> to prepare the connection strings and database configuration for Micro Focus Enterprise Server.	Data engineer, DevOps engineer

### Create an Amazon ElastiCache cluster for the Redis instance

Task	Description	Skills required
Create a CloudFormation template for the Amazon	Use the <a href="#">AWS example code snippet</a> to make a CloudForm	Cloud architect

Task	Description	Skills required
ElastiCache cluster for the Redis instance.	ation template that will create an Amazon ElastiCache cluster for the Redis instance.	
Deploy the CloudFormation stack to create an Amazon ElastiCache cluster for the Redis instance.	Create the Amazon ElastiCache cluster for the Redis instance that has Multi-AZ replication enabled for production workloads.	Cloud architect
Configure Enterprise Server PSOR connection settings.	Follow the instructions in the <a href="#">Micro Focus documentation</a> to prepare the PAC Scale-Out Repository (PSOR) connection configuration for Micro Focus Enterprise Server PAC.	DevOps engineer

### Create a Micro Focus Enterprise Server ESCWA automatic scaling group

Task	Description	Skills required
Create a Micro Focus Enterprise Server AMI.	Create an Amazon EC2 Windows Server instance and install the Micro Focus Enterprise Server binary in the EC2 instance. Create an Amazon Machine Image (AMI) of the EC2 instance. For more information, see the <a href="#">Enterprise Server installation documentation</a> .	Cloud architect
Create a CloudFormation template for Enterprise Server ESCWA.	Use the <a href="#">AWS example code snippet</a> to make a template for creating a custom stack of	Cloud architect



Task	Description	Skills required
	Enterprise Server ESCWA in an automatic scaling group.	
Deploy the CloudFormation stack to create an Amazon EC2 scaling group for Enterprise Server ESCWA.	Use the CloudFormation template to deploy the automatic scaling group with the Micro Focus Enterprise Server ESCWA AMI created in the previous story.	Cloud architect

### Create an AWS Systems Manager Automation runbook

Task	Description	Skills required
Create a CloudFormation template for a Systems Manager Automation runbook.	Use the example code snippets in the <i>Additional information</i> section to make a CloudFormation template that will create a Systems Manager Automation runbook for automating PAC creation, Enterprise Server scale in, and Enterprise Server scale out.	Cloud architect
Deploy the CloudFormation stack that contains the Systems Manager Automation runbook.	Use the CloudFormation template to deploy a stack that contains the Automation runbook for PAC creation, Enterprise Server scale in, and Enterprise Server scale out.	Cloud architect

## Create an automatic scaling group for Micro Focus Enterprise Server

Task	Description	Skills required
Create a CloudFormation template for setting up an automatic scaling group for Micro Focus Enterprise Server.	<p>Use the <a href="#">AWS example code snippet</a> to make a CloudFormation template that will create an automatic scaling group. This template will reuse the same AMI that was created for the Micro Focus Enterprise Server ESCWA instance.</p> <p>Then use an <a href="#">AWS example code snippet</a> to create the automatic scaling lifecycle event and set up Amazon EventBridge to filter for scale-out and scale-in events in the same CloudFormation template.</p>	Cloud architect
Deploy the CloudFormation stack for the automatic scaling group for Micro Focus Enterprise Servers.	Deploy the CloudFormation stack that contains the automatic scaling group for Micro Focus Enterprise Servers.	Cloud architect

## Related resources

- [Micro Focus Enterprise Server Performance and Availability Cluster \(PAC\)](#)
- [Amazon EC2 Auto Scaling lifecycle hooks](#)
- [Running automations with triggers using EventBridge](#)

## Additional information

The following scenarios must be automated for scaling in or scaling out the PAC clusters.

### Automation for starting or recreating a PAC

At the start of a PAC cluster, Enterprise Server requires ESCWA to invoke APIs to create a PAC configuration. This starts and adds Enterprise Server regions into the PAC. To create or recreate a PAC, use the following steps:

1. Configure a [PAC Scale-Out Repository \(PSOR\)](#) in ESCWA with a given name.

```
POST /server/v1/config/groups/sors
```

2. Create a PAC with a given name and attach the PSOR to it.

```
POST /server/v1/config/groups/pacs
```

3. Configure the region database and cross-region database if this is the first time you are setting up a PAC.

**Note:** This step uses SQL queries and the Micro Focus Enterprise Suite command line **dbhfadmin** tool to create the database and import initial data.

4. Install the PAC definition into the Enterprise Server regions.

```
POST /server/v1/config/mfds
POST /native/v1/config/groups/pacs/${pac_uid}/install
```

5. Start Enterprise Server regions in the PAC.

```
POST /native/v1/regions/${host_ip}/${port}/${region_name}/start
```

The previous steps can be implemented by using a Windows PowerShell script.

The following steps explain how to build an automation for creating a PAC by reusing the Windows PowerShell script.

1. Create an Amazon EC2 launch template that downloads or creates the Windows PowerShell script as part of the bootstrap process. For example, you can use EC2 user data to download the script from an Amazon Simple Storage Service (Amazon S3) bucket.

2. Create an AWS Systems Manager Automation runbook to invoke the Windows PowerShell script.
3. Associate the runbook to the ESCWA instance by using the instance tag.
4. Create an ESCWA automatic scaling group by using the launch template.

You can use the following example AWS CloudFormation snippet to create the Automation runbook.

*Example CloudFormation snippet for a Systems Manager Automation runbook used for PAC creation*

```
PACInitDocument:
  Type: AWS::SSM::Document
  Properties:
    DocumentType: Command
    Content:
      schemaVersion: '2.2'
      description: Operation Runbook to create Enterprise Server PAC
      mainSteps:
        - action: aws:runPowerShellScript
          name: CreatePAC
          inputs:
            onFailure: Abort
            timeoutSeconds: "1200"
            runCommand:
              - |
                C:\Scripts\PAC-Init.ps1
PacInitAutomation:
  Type: AWS::SSM::Document
  Properties:
    DocumentType: Automation
    Content:
      description: Prepare Micro Focus PAC Cluster via ESCWA Server
      schemaVersion: '0.3'
      assumeRole: !GetAtt SsmAssumeRole.Arn
      mainSteps:
        - name: RunPACInitDocument
          action: aws:runCommand
          timeoutSeconds: 300
          onFailure: Abort
          inputs:
            DocumentName: !Ref PACInitDocument
          Targets:
            - Key: tag:Enterprise Server - ESCWA
```

```
        Values:
          - "true"
PacInitDocumentAssociation:
  Type: AWS::SSM::Association
  Properties:
    DocumentVersion: "$LATEST"
    Name: !Ref PACInitDocument
    Targets:
      - Key: tag:Enterprise Server - ESCWA
        Values:
          - "true"
```

For more information, see [Micro Focus Enterprise Server - Configuring a PAC](#).

## Automation for scaling out with a new Enterprise Server instance

When an Enterprise Server instance is scaled out, its Enterprise Server region must be added to the PAC. The following steps explain how to invoke ESCWA APIs and add the Enterprise Server region into the PAC.

1. Install the PAC definition into the Enterprise Server regions.

```
POST '/server/v1/config/mfds'
POST /native/v1/config/groups/pacs/${pac_uid}/install
```

2. Warm Start the region in the PAC.

```
POST /native/v1/regions/${host_ip}/${port}/${region_name}/start
```

3. Add the Enterprise Server instance to the load balancer by associating the automatic scaling group to the load balancer.

The previous steps can be implemented by using a Windows PowerShell script. For more information, see [Micro Focus Enterprise Server - Configuring a PAC](#).

The following steps can be used to build an event driven automation to add a newly launched Enterprise Server instance into a PAC by reusing the Windows PowerShell script.

1. Create an Amazon EC2 launch template for Enterprise Server instance that provisions an Enterprise Server Region during its bootstrap. For example, you can use the Micro Focus

Enterprise Server command mfd to import a region configuration. For further details and options available for this command, see the [Enterprise Server Reference](#).

2. Create an Enterprise Server automatic scaling group that uses the launch template created in the previous step.
3. Create a Systems Manager Automation runbook to invoke the Windows PowerShell script.
4. Associate the runbook to the ESCWA instance by using the instance tag.
5. Create an Amazon EventBridge rule to filter for the EC2 Instance Launch Successful event for the Enterprise Server automatic scaling group, and create the target to use the Automation runbook.

You can use the following example CloudFormation snippet to create the Automation runbook and the EventBridge rule.

*Example CloudFormation snippet for Systems Manager used for scaling out Enterprise Server instances*

```
ScaleOutDocument:
  Type: AWS::SSM::Document
  Properties:
    DocumentType: Command
    Content:
      schemaVersion: '2.2'
      description: Operation Runbook to Adding MFDS Server into an existing PAC
      parameters:
        MfdsPort:
          type: String
        InstanceIpAddress:
          type: String
          default: "Not-Available"
        InstanceId:
          type: String
          default: "Not-Available"
      mainSteps:
        - action: aws:runPowerShellScript
          name: Add_MFDS
          inputs:
            onFailure: Abort
            timeoutSeconds: "300"
            runCommand:
              - |
```

```

    $ip = "{{InstanceIpAddress}}"
    if ( ${ip} -eq "Not-Available" ) {
        $ip = aws ec2 describe-instances --instance-id {{InstanceId}} --output
text --query "Reservations[0].Instances[0].PrivateIpAddress"
    }
    C:\Scripts\Scale-Out.ps1 -host_ip ${ip} -port {{MfdsPort}}

```

#### PacScaleOutAutomation:

Type: AWS::SSM::Document

#### Properties:

DocumentType: Automation

#### Content:

#### parameters:

#### MfdsPort:

type: String

#### InstanceIpAddress:

type: String

default: "Not-Available"

#### InstanceId:

type: String

default: "Not-Available"

description: Scale Out 1 New Server in Micro Focus PAC Cluster via ESCWA

#### Server

schemaVersion: '0.3'

assumeRole: !GetAtt SsmAssumeRole.Arn

#### mainSteps:

- name: RunScaleOutCommand

action: aws:runCommand

timeoutSeconds: 300

onFailure: Abort

#### inputs:

DocumentName: !Ref ScaleOutDocument

#### Parameters:

InstanceIpAddress: "{{InstanceIpAddress}}"

InstanceId: "{{InstanceId}}"

MfdsPort: "{{MfdsPort}}"

#### Targets:

- Key: tag:Enterprise Server - ESCWA

#### Values:

- "true"

## Automation for scaling in an Enterprise Server instance

Similar to scaling out, when an Enterprise Server instance is *scaled in*, the event EC2 Instance-terminate Lifecycle Action is initiated, and the following process and API calls are needed to remove a Micro Focus Enterprise Server instance from the PAC.

1. Stop the region in the terminating Enterprise Server instance.

```
POST "/native/v1/regions/${host_ip}/${port}/${region_name}/stop"
```

2. Remove the Enterprise Server Instance from the PAC.

```
DELETE "/server/v1/config/mfds/${uid}"
```

3. Send signal to continue terminating the Enterprise Server instance.

The previous steps can be implemented in a Windows PowerShell script. For additional details of this process, see [Micro Focus Enterprise Server document - Administering a PAC](#).

The following steps explain how to build an event-driven automation to terminate an Enterprise Server instance from a PAC by reusing the Windows PowerShell script.

1. Create a Systems Manager Automation runbook to invoke the Windows PowerShell script.
2. Associate the runbook to the ESCWA instance by using the instance tag.
3. Create an automatic scaling group lifecycle hook for EC2 instance termination.
4. Create an Amazon EventBridge rule to filter EC2 Instance-terminate Lifecycle Action event for the Enterprise Server automatic scaling group, and create the target to use the Automation runbook.

You can use the following example CloudFormation template for creating a Systems Manager Automation runbook, lifecycle hook, and EventBridge rule.

*Example CloudFormation snippet for a Systems Manager Automation runbook used for scaling in an Enterprise Server instance*

```
ScaleInDocument:
  Type: AWS::SSM::Document
  Properties:
    DocumentType: Command
    Content:
      schemaVersion: '2.2'
```



```

description: Operation Runbook to Remove MFDS Server from PAC
parameters:
  MfdsPort:
    type: String
  InstanceIpAddress:
    type: String
    default: "Not-Available"
  InstanceId:
    type: String
    default: "Not-Available"
mainSteps:
- action: aws:runPowerShellScript
  name: Remove_MFDS
  inputs:
    onFailure: Abort
    runCommand:
      - |
        $ip = "{{InstanceIpAddress}}"
        if ( ${ip} -eq "Not-Available" ) {
          $ip = aws ec2 describe-instances --instance-id {{InstanceId}} --output
text --query "Reservations[0].Instances[0].PrivateIpAddress"
        }
        C:\Scripts\Scale-In.ps1 -host_ip ${ip} -port {{MfdsPort}}

PacScaleInAutomation:
  Type: AWS::SSM::Document
  Properties:
    DocumentType: Automation
  Content:
    parameters:
      MfdsPort:
        type: String
      InstanceIpAddress:
        type: String
        default: "Not-Available"
      InstanceId:
        type: String
        default: "Not-Available"
    description: Scale In 1 New Server in Micro Focus PAC Cluster via ESCWA Server
    schemaVersion: '0.3'
    assumeRole: !GetAtt SsmAssumeRole.Arn
  mainSteps:
    - name: RunScaleInCommand
      action: aws:runCommand

```

```
timeoutSeconds: "600"
onFailure: Abort
inputs:
  DocumentName: !Ref ScaleInDocument
  Parameters:
    InstanceIpAddress: "{{InstanceIpAddress}}"
    MfdsPort: "{{MfdsPort}}"
    InstanceId: "{{InstanceId}}"
  Targets:
    - Key: tag:Enterprise Server - ESCWA
      Values:
        - "true"
- name: TerminateTheInstance
  action: aws:executeAwsApi
  inputs:
    Service: autoscaling
    Api: CompleteLifecycleAction
    AutoScalingGroupName: !Ref AutoScalingGroup
    InstanceId: "{{ InstanceId }}"
    LifecycleActionResult: CONTINUE
    LifecycleHookName: !Ref ScaleInLifeCycleHook
```

## Automation for an Amazon EC2 automatic scaling trigger

The process of setting up a scaling policy for Enterprise Server instances requires an understanding of the application behavior. In most cases, you can set up target tracking scaling policies. For example, you can use the average CPU utilization as the Amazon CloudWatch metric to set for the automatic scaling policy. For more information, see [Target tracking scaling policies for Amazon EC2 Auto Scaling](#). For applications that have regular traffic patterns, consider using a predictive scaling policy. For more information, see [Predictive scaling for Amazon EC2 Auto Scaling](#).

# Build a multi-tenant serverless architecture in Amazon OpenSearch Service

*Created by Tabby Ward (AWS) and Nisha Gambhir (AWS)*

**Environment:** PoC or pilot

**Technologies:** Modernization; SaaS; Serverless

**Workload:** Open-source

**AWS services:** Amazon OpenSearch Service; AWS Lambda; Amazon S3; Amazon API Gateway

## Summary

Amazon OpenSearch Service is a managed service that makes it easy to deploy, operate, and scale Elasticsearch, which is a popular open-source search and analytics engine. Amazon OpenSearch Service provides free-text search as well as near real-time ingestion and dashboarding for streaming data such as logs and metrics.

Software as a service (SaaS) providers frequently use Amazon OpenSearch Service to address a broad range of use cases, such as gaining customer insights in a scalable and secure way while reducing complexity and downtime.

Using Amazon OpenSearch Service in a multi-tenant environment introduces a series of considerations that affect partitioning, isolation, deployment, and management of your SaaS solution. SaaS providers have to consider how to effectively scale their Elasticsearch clusters with continually shifting workloads. They also need to consider how tiering and noisy neighbor conditions could impact their partitioning model.

This pattern reviews the models that are used to represent and isolate tenant data with Elasticsearch constructs. In addition, the pattern focuses on a simple serverless reference architecture as an example to demonstrate indexing and searching using Amazon OpenSearch Service in a multi-tenant environment. It implements the pool data partitioning model, which shares the same index among all tenants while maintaining a tenant's data isolation. This pattern

uses the following Amazon Web Services (AWS) services: Amazon API Gateway, AWS Lambda, Amazon Simple Storage Service (Amazon S3), and Amazon OpenSearch Service .

For more information about the pool model and other data partitioning models, see the [Additional information](#) section.

## Prerequisites and limitations

### Prerequisites

- An active AWS account
- [AWS Command Line Interface \(AWS CLI\) version 2.x](#), installed and configured on macOS, Linux, or Windows
- [Python version 3.7](#)
- [pip3](#) – The Python source code is provided as a .zip file to be deployed in a Lambda function. If you want to use the code locally or customize it, follow these steps to develop and recompile the source code:
  1. Generate the `requirements.txt` file by running the the following command in the same directory as the Python scripts: `pip3 freeze > requirements.txt`
  2. Install the dependencies: `pip3 install -r requirements.txt`

### Limitations

- This code runs in Python, and doesn't currently support other programming languages.
- The sample application doesn't include AWS cross-Region or disaster recovery (DR) support.
- This pattern is intended for demonstration purposes only. It is not intended to be used in a production environment.

## Architecture

The following diagram illustrates the high-level architecture of this pattern. The architecture includes the following:

- AWS Lambda to index and query the content
- Amazon OpenSearch Service to perform search
- Amazon API Gateway to provide an API interaction with the user

- Amazon S3 to store raw (non-indexed) data
- Amazon CloudWatch to monitor logs
- AWS Identity and Access Management (IAM) to create tenant roles and policies

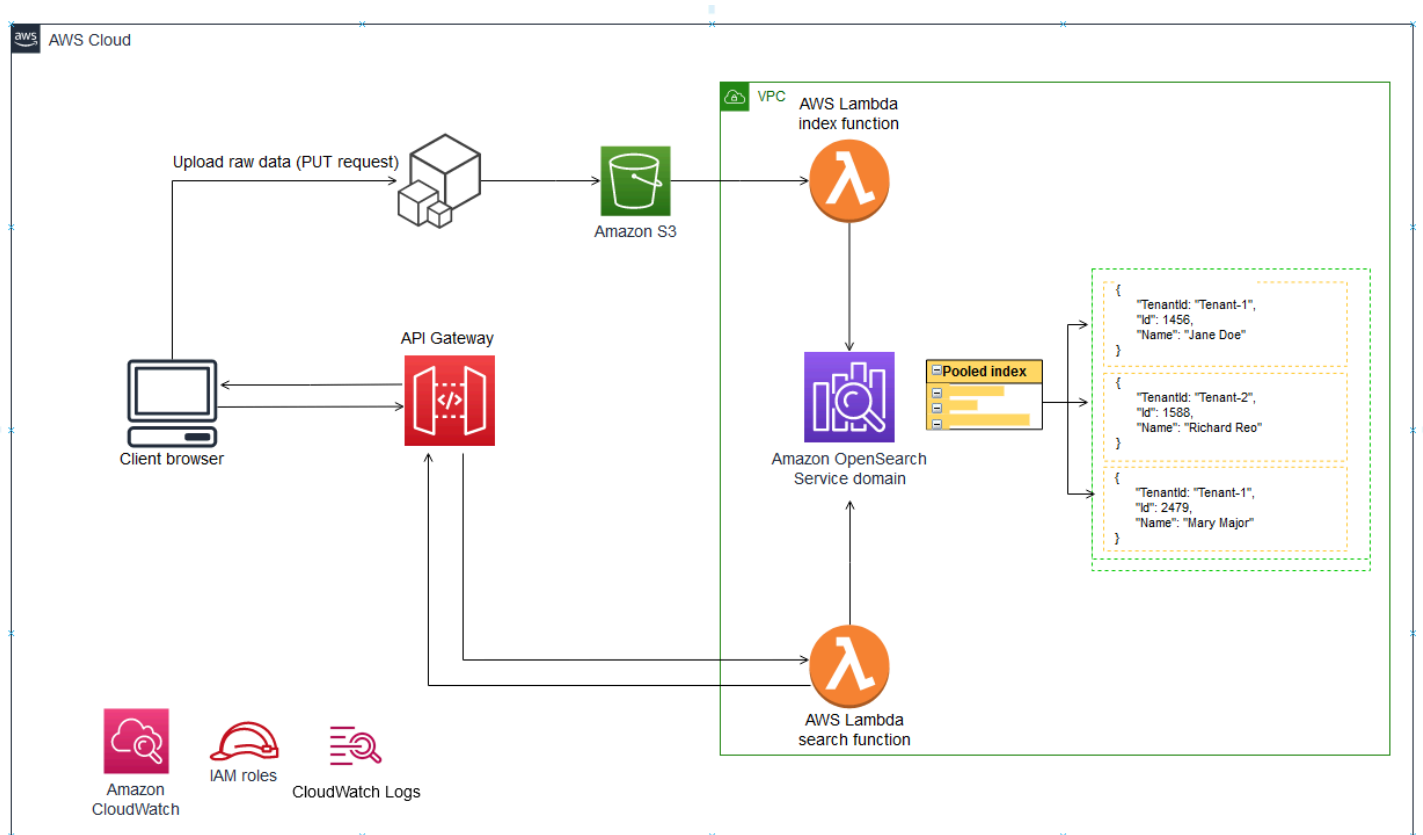

## Automation and scale

For simplicity, the pattern uses AWS CLI to provision the infrastructure and to deploy the sample code. You can create an AWS CloudFormation template or AWS Cloud Development Kit (AWS CDK) scripts to automate the pattern.

## Tools

### AWS services

- [AWS CLI](#) – AWS Command Line Interface (AWS CLI) is a unified tool for managing AWS services and resources by using commands in your command-line shell.

- [AWS Lambda](#) – AWS Lambda is a compute service that lets you run code without provisioning or managing servers. Lambda runs your code only when needed and scales automatically, from a few requests per day to thousands per second.
- [Amazon API Gateway](#) – Amazon API Gateway is an AWS service for creating, publishing, maintaining, monitoring, and securing REST, HTTP, and WebSocket APIs at any scale.
- [Amazon S3](#) – Amazon Simple Storage Service (Amazon S3) is an object storage service that lets you store and retrieve any amount of information at any time, from anywhere on the web.
- [Amazon OpenSearch Service](#) – Amazon OpenSearch Service is a fully managed service that makes it easy for you to deploy, secure, and run Elasticsearch cost-effectively at scale.

## Code

The attachment provides sample files for this pattern. These include:

- `index_lambda_package.zip` – The Lambda function for indexing data in Amazon OpenSearch Service by using the pool model.
- `search_lambda_package.zip` – The Lambda function for searching for data in Amazon OpenSearch Service.
- `Tenant-1-data` – Sample raw (non-indexed) data for Tenant-1.
- `Tenant-2-data` – Sample raw (non-indexed) data for Tenant-2.

**Important:** The stories in this pattern include CLI command examples that are formatted for Unix, Linux, and macOS. For Windows, replace the backslash (\) Unix continuation character at the end of each line with a caret (^).

## Epics

### Create and configure an S3 bucket

Task	Description	Skills required
Create an S3 bucket.	Create an S3 bucket in your AWS Region. This bucket will hold the non-indexed tenant data for the sample	Cloud architect, Cloud administrator

Task	Description	Skills required
	<p>application. Make sure that the S3 bucket's name is globally unique, because the namespace is shared by all AWS accounts.</p> <p>To create an S3 bucket, you can use the AWS CLI <a href="#">create-bucket</a> command as follows:</p> <pre data-bbox="594 646 1029 926">aws s3api create-bucket \   --bucket tenantraw data \   --region &lt;your-AWS-Region&gt;</pre> <p>where <code>tenantrawdata</code> is the S3 bucket name. (You can use any unique name that follows <a href="#">the bucket naming guidelines</a>.)</p>	

## Create and configure an Elasticsearch cluster

Task	Description	Skills required
<p>Create an Amazon OpenSearch Service domain.</p>	<p>Run the AWS CLI <a href="#">create-elasticsearch-domain</a> command to create an Amazon OpenSearch Service domain:</p> <pre data-bbox="594 1703 1029 1879">aws es create-elasticsearch-domain \   --domain-name vpc- cli-example \</pre>	<p>Cloud architect, Cloud administrator</p>

Task	Description	Skills required
	<pre> --elasticsearch-ve rsion 7.10 \ --elasticsearch-cl uster-config InstanceT ype=t3.medium.elas ticsearch,Instance Count=1 \ --ebs-options EBSEnabled=true,Vo lumeType=gp2,Volum eSize=10 \ --domain-endpoint- options "{\"Enfor ceHTTPS\": true}" \ --encryption-at-re st-options "{\"Enabl ed\": true}" \ --node-to-node- encryption-options "{\"Enabled\": true}" \ --advanced-securit y-options "{\"Enabl ed\": true, \"Interna lUserDatabaseEnabled \": true, \   \"MasterUserOption s\": {\"MasterUserName \": \"KibanaUser\", \   \"MasterUserPasswo rd\": \"NewKiba naPassword@123\"}}" \ --vpc-options "{\"SubnetIds\": [\"&lt;subnet-id&gt;\"], \"SecurityGroupIds\": [\"&lt;sg-id&gt;\"]}" \ --access-policies "{\"Version\": \"2012-10-17\", \"Statement\": </pre>	



Task	Description	Skills required
	<pre data-bbox="609 205 1015 661">[ { \"Effect\":   \"Allow\",     \"Principal\":       {\"AWS\": \"*\" },     \"Action\": \"es:*\",     \"Resource\":       \"arn:aws:es:region:account-id:domain/vpc-cli-example/*\"   } ] ]"</pre> <p data-bbox="592 703 1031 1165">The instance count is set to 1 because the domain is for testing purposes. You need to enable fine-grained access control by using the <code>advanced-security-options</code> parameter, because the details cannot be changed after the domain has been created.</p> <p data-bbox="592 1207 1031 1438">This command creates a master user name (<code>KibanaUser</code>) and a password that you can use to log in to the Kibana console.</p> <p data-bbox="592 1480 1031 1753">Because the domain is part of a virtual private cloud (VPC), you have to make sure that you can reach the Elasticsearch instance by specifying the access policy to use.</p>	

Task	Description	Skills required
	For more information, see <a href="#">Launching your Amazon OpenSearch Service domains using a VPC</a> in the AWS documentation.	

Task	Description	Skills required
Set up a bastion host.	<p>Set up a Amazon Elastic Compute Cloud (Amazon EC2) Windows instance as a bastion host to access the Kibana console. The Elasticsearch security group must allow traffic from the Amazon EC2 security group. For instructions, see the blog post <a href="#">Controlling Network Access to EC2 Instances Using a Bastion Server</a>.</p> <p>When the bastion host has been set up, and you have the security group that is associated with the instance available, use the AWS CLI <a href="#">authorize-security-group-ingress</a> command to add permission to the Elasticsearch security group to allow port 443 from the Amazon EC2 (bastion host) security group.</p> <pre data-bbox="597 1430 1027 1751">aws ec2 authorize- security-group-ingress \   --group-id &lt;Security GroupIdElasticSea rch&gt; \   --protocol tcp \   --port 443 \ </pre>	Cloud architect, Cloud administrator

Task	Description	Skills required
	<pre>--source-group &lt;SecurityGroupIdB ashionHostEC2&gt;</pre>	

## Create and configure the Lambda index function

Task	Description	Skills required
Create the Lambda execution role.	<p>Run the AWS CLI <a href="#">create-role</a> command to grant the Lambda index function access to AWS services and resources :</p> <pre>aws iam create-role \   --role-name index-lambda-role \   --assume-role-policy-document file://lambda_assume_role.json</pre> <p>where <code>lambda_assume_role.json</code> is a JSON document in the current folder that grants <code>AssumeRole</code> permissions to the Lambda function, as follows:</p> <pre>{   "Version":     "2012-10-17",   "Statement": [     {       "Effect":         "Allow",</pre>	Cloud architect, Cloud administrator

Task	Description	Skills required
	<pre>        "Principa 1": {     "Service": "lambda.a mazonaws.com"     },     "Action": "sts:AssumeRole"     }   ] }</pre>	

Task	Description	Skills required
Attach managed policies to the Lambda role.	<p>Run the AWS CLI <a href="#">attach-role-policy</a> command to attach managed policies to the role created in the previous step. These two policies give the role permissions to create an elastic network interface and to write logs to CloudWatch Logs.</p> <pre data-bbox="597 680 1026 1478">aws iam attach-role-policy \   --role-name index-lambda-role \   --policy-arn arn:aws:iam::aws:policy/service-role/AWSLambdaBasicExecutionRole  aws iam attach-role-policy \   --role-name index-lambda-role \   --policy-arn arn:aws:iam::aws:policy/service-role/AWSLambdaVPCLessExecutionRole</pre>	Cloud architect, Cloud administrator

Task	Description	Skills required
Create a policy to give the Lambda index function permission to read the S3 objects.	<p>Run the AWS CLI <a href="#">create-policy</a> command to give the Lambda index function <code>s3:GetObject</code> permission to read the objects in the S3 bucket:</p> <pre>aws iam create-policy \   --policy-name s3- permission-policy \   --policy-document file://s3-policy.json</pre> <p>The file <code>s3-policy.json</code> is a JSON document in the current folder that grants <code>s3:GetObject</code> permissions to allow read access to S3 objects. If you used a different name when you created the S3 bucket, provide the correct bucket name in the <code>Resource</code> section in the following:</p> <pre>{   "Version":     "2012-10-17",   "Statement": [     {       "Effect":         "Allow",       "Action":         "s3:GetObject",       "Resource ": "arn:aws:s3:::tena ntrawdata/*"</pre>	Cloud architect, Cloud administrator

Task	Description	Skills required
	<pre>    }   ] }</pre>	
Attach the Amazon S3 permission policy to the Lambda execution role.	<p>Run the AWS CLI <a href="#">attach-role-policy</a> command to attach the Amazon S3 permission policy you created in the previous step to the Lambda execution role:</p> <pre>aws iam attach-role-policy \   --role-name index-lambda-role \   --policy-arn \   &lt;PolicyARN&gt;</pre> <p>where <code>PolicyARN</code> is the Amazon Resource Name (ARN) of the Amazon S3 permission policy. You can get this value from the output of the previous command.</p>	Cloud architect, Cloud administrator



Task	Description	Skills required
Create the Lambda index function.	<p>Run the AWS CLI <a href="#">create-function</a> command to create the Lambda index function, which will access Amazon OpenSearch Service:</p> <pre data-bbox="592 489 1029 1365">aws lambda create-function \   --function-name index-lambda-function \   --zip-file fileb://index_lambda_package.zip \   --handler lambda_index.lambda_handler \   --runtime python3.7 \   --role "arn:aws:iam::account-id:role/index-lambda-role" \   --timeout 30 \   --vpc-config '{"SubnetIds": ["&lt;subnet-id1&gt;", "&lt;subnet-id2&gt;"], "SecurityGroupIds": ["&lt;sg-1&gt;"]}'</pre>	Cloud architect, Cloud administrator

Task	Description	Skills required
Allow Amazon S3 to call the Lambda index function.	<p>Run the AWS CLI <a href="#">add-permission</a> command to give Amazon S3 the permission to call the Lambda index function:</p> <pre>aws lambda add-permission \   --function-name   index-lambda-function \   --statement-id s3-   permissions \   --action lambda:In   vokeFunction \   --principal s3.amazon   aws.com \   --source-arn   "arn:aws:s3:::tena   ntrawdata" \   --source-account   "&lt;account-id&gt;"</pre>	Cloud architect, Cloud administrator

Task	Description	Skills required
<p>Add a Lambda trigger for the Amazon S3 event.</p>	<p>Run the AWS CLI <a href="#">put-bucket-notification-configuration</a> command to send notifications to the Lambda index function when the Amazon S3 ObjectCreated event is detected. The index function runs whenever an object is uploaded to the S3 bucket.</p> <pre data-bbox="594 680 1026 1041">aws s3api put-bucket-notification-configuration \   --bucket tenantraw-data \   --notification-configuration file://s3-trigger.json</pre> <p>The file <code>s3-trigger.json</code> is a JSON document in the current folder that adds the resource policy to the Lambda function when the Amazon S3 ObjectCreated event occurs.</p>	<p>Cloud architect, Cloud administrator</p>

## Create and configure the Lambda search function

Task	Description	Skills required
<p>Create the Lambda execution role.</p>	<p>Run the AWS CLI <a href="#">create-role</a> command to grant the Lambda search function</p>	<p>Cloud architect, Cloud administrator</p>

Task	Description	Skills required
	<p>access to AWS services and resources:</p> <pre>aws iam create-role \   --role-name search-lambda-role \   --assume-role-policy-document file://lambda_assume_role.json</pre> <p>where <code>lambda_assume_role.json</code> is a JSON document in the current folder that grants <code>AssumeRole</code> permissions to the Lambda function, as follows:</p> <pre>{   "Version":     "2012-10-17",   "Statement": [     {       "Effect":         "Allow",       "Principal": {         "Service": "lambda.amazonaws.com"       },       "Action":         "sts:AssumeRole"     }   ] }</pre>	

Task	Description	Skills required
Attach managed policies to the Lambda role.	<p>Run the AWS CLI <a href="#">attach-role-policy</a> command to attach managed policies to the role created in the previous step. These two policies give the role permissions to create an elastic network interface and to write logs to CloudWatch Logs.</p> <pre data-bbox="597 680 1026 1474">aws iam attach-role-policy \   --role-name search-lambda-role \   --policy-arn arn:aws:iam::aws:policy/service-role/AWSLambdaBasicExecutionRole  aws iam attach-role-policy \   --role-name search-lambda-role \   --policy-arn arn:aws:iam::aws:policy/service-role/AWSLambdaVPCLessExecutionRole</pre>	Cloud architect, Cloud administrator

Task	Description	Skills required
<p>Create the Lambda search function.</p>	<p>Run the AWS CLI <a href="#">create-function</a> command to create the Lambda search function, which will access Amazon OpenSearch Service:</p> <pre data-bbox="594 489 1029 1360">aws lambda create-function \   --function-name search-lambda-function \   --zip-file fileb://search_lambda_package.zip \   --handler lambda_search.lambda_handler \   --runtime python3.7 \   --role "arn:aws:iam::account-id:role/search-lambda-role" \   --timeout 30 \   --vpc-config '{"SubnetIds": ["&lt;subnet-id1&gt;", "&lt;subnet-id2&gt;"], "SecurityGroupIds": ["&lt;sg-1&gt;"]}'</pre>	<p>Cloud architect, Cloud administrator</p>

## Create and configure tenant roles

Task	Description	Skills required
<p>Create tenant IAM roles.</p>	<p>Run the AWS CLI <a href="#">create-role</a> command to create two tenant roles that will be used to test the search functionality:</p>	<p>Cloud architect, Cloud administrator</p>

Task	Description	Skills required
	<pre>aws iam create-role \   --role-name Tenant-1- role \   --assume-role-poli cy-document file://as sume-role-policy.json</pre> <pre>aws iam create-role \   --role-name Tenant-2- role \   --assume-role-poli cy-document file://as sume-role-policy.json</pre> <p>The file <code>assume-role-policy.json</code> is a JSON document in the current folder that grants <code>AssumeRole</code> permissions to the Lambda execution role:</p> <pre>{   "Version":     "2012-10-17",   "Statement": [     {       "Effect":         "Allow",       "Principa l": {         "AWS":           "&lt;Lambda execution role for index function&gt;",         "AWS":           "&lt;Lambda execution role for search function&gt;"       },       "Action":         "sts:AssumeRole"</pre>	

Task	Description	Skills required
	<pre>    }   ] }</pre>	



Task	Description	Skills required
Create a tenant IAM policy.	<p>Run the AWS CLI <a href="#">create-policy</a> command to create a tenant policy that grants access to Elasticsearch operations:</p> <pre>aws iam create-policy \   --policy-name tenant- policy \   --policy-document file://policy.json</pre> <p>The file <code>policy.json</code> is a JSON document in the current folder that grants permissions on Elasticsearch:</p> <pre>{   "Version":   "2012-10-17",   "Statement": [     {       "Effect":       "Allow",       "Action": [          "es:ESHttpDelete",          "es:ESHttpGet",          "es:ESHttpHead",          "es:ESHttpPost",          "es:ESHttpPut",          "es:ESHttpPatch"       ],       "Resource": [ </pre>	Cloud architect, Cloud administrator

Task	Description	Skills required
	<pre>                                 "&lt;ARN of Elasticsearch domain created earlier&gt;"                                 ]                                 }                                 ]                                 } </pre>	
<p>Attach the tenant IAM policy to the tenant roles.</p>	<p>Run the AWS CLI <a href="#">attach-role-policy</a> command to attach the tenant IAM policy to the two tenant roles you created in the earlier step:</p> <pre> aws iam attach-role-policy \   --policy-arn   arn:aws:iam::account-id:policy/tenant-policy \   --role-name Tenant-1-role  aws iam attach-role-policy \   --policy-arn   arn:aws:iam::account-id:policy/tenant-policy \   --role-name Tenant-2-role </pre> <p>The policy ARN is from the output of the previous step.</p>	<p>Cloud architect, Cloud administrator</p>

Task	Description	Skills required
Create an IAM policy to give Lambda permissions to assume role.	<p>Run the AWS CLI <a href="#">create-policy</a> command to create a policy for Lambda to assume the tenant role:</p> <pre>aws iam create-policy \   --policy-name assume-tenant-role-policy \   --policy-document file://lambda_policy.json</pre> <p>The file <code>lambda_policy.json</code> is a JSON document in the current folder that grants permissions to AssumeRole :</p> <pre>{   "Version":     "2012-10-17",   "Statement": [     {       "Effect":         "Allow",       "Action":         "sts:AssumeRole",       "Resource": "         &lt;ARN of tenant role created earlier&gt;"     }   ] }</pre> <p>For Resource, you can use a wildcard character to avoid</p>	Cloud architect, Cloud administrator

Task	Description	Skills required
<p>Create an IAM policy to give the Lambda index role permission to access Amazon S3.</p>	<p>creating a new policy for each tenant.</p> <p>Run the AWS CLI <a href="#">create-policy</a> command to give the Lambda index role permission to access the objects in the S3 bucket:</p> <pre>aws iam create-policy \   --policy-name s3-   permission-policy \   --policy-document   file://s3_lambda_p   olicy.json</pre> <p>The file <code>s3_lambda_policy.json</code> is the following JSON policy document in the current folder:</p> <pre>{   "Version":   "2012-10-17",   "Statement": [     {       "Effect":       "Allow",       "Action":       "s3:GetObject",       "Resource ": "arn:aws:s3:::tena ntrawdata/*"     }   ] }</pre>	<p>Cloud architect, Cloud administrator</p>

Task	Description	Skills required
Attach the policy to the Lambda execution role.	<p>Run the AWS CLI <a href="#">attach-role-policy</a> command to attach the policy created in the previous step to the Lambda index and search execution roles you created earlier:</p> <pre>aws iam attach-role-policy \   --policy-arn   arn:aws:iam::account-id:policy/assume-tenant-role-policy \   --role-name index-lambda-role  aws iam attach-role-policy \   --policy-arn   arn:aws:iam::account-id:policy/assume-tenant-role-policy \   --role-name search-lambda-role  aws iam attach-role-policy \   --policy-arn   arn:aws:iam::account-id:policy/s3-permission-policy \   --role-name index-lambda-role</pre> <p>The policy ARN is from the output of the previous step.</p>	Cloud architect, Cloud administrator

## Create and configure a search API

Task	Description	Skills required
Create a REST API in API Gateway.	<p>Run the CLI <a href="#">create-rest-api</a> command to create a REST API resource:</p> <pre data-bbox="594 499 1027 779">aws apigateway create-rest-api \   --name Test-Api \   --endpoint-configuration "{ \"types\   : [\"REGIONAL\"] }"</pre> <p>For the endpoint configuration type, you can specify EDGE instead of REGIONAL to use edge locations instead of a particular AWS Region.</p> <p>Note the value of the <code>id</code> field from the command output. This is the API ID that you will use in subsequent commands.</p>	Cloud architect, Cloud administrator
Create a resource for the search API.	The search API resource starts the Lambda search function with the resource name <code>search</code> . (You don't have to create an API for the Lambda index function, because it runs automatically when objects are uploaded to the S3 bucket.)	Cloud architect, Cloud administrator

Task	Description	Skills required
	<p>1. Run the AWS CLI <a href="#">get-resources</a> command to get the parent ID for the root path:</p> <pre data-bbox="634 380 1029 575">aws apigateway get-resources \   --rest-api-id &lt;API-ID&gt;</pre> <p>Note the value of the ID field. You will use this parent ID in the next command.</p> <pre data-bbox="634 831 1029 1266">{   "items": [     {       "id":       "zpsri964ck",       "path":       "/"     }   ] }</pre> <p>2. Run the AWS CLI <a href="#">create-resource</a> command to create a resource for the search API. For <code>parent-id</code>, specify the ID from the previous command.</p> <pre data-bbox="634 1593 1029 1845">aws apigateway   create-resource \   --rest-api-id &lt;API-ID&gt; \   --parent-id   &lt;Parent-ID&gt; \   --resource-path &lt;Resource-Path&gt;</pre>	

Task	Description	Skills required
	<code>--path-part search</code>	
<p>Create a GET method for the search API.</p>	<p>Run the AWS CLI <a href="#">put-method</a> command to create a GET method for the search API:</p> <pre>aws apigateway put-method \   --rest-api-id &lt;API-ID&gt; \   --resource-id &lt;ID from the previous command output&gt; \   --http-method GET \   --authorization-type "NONE" \   --no-api-key-required</pre> <p>For <code>resource-id</code> , specify the ID from the output of the <code>create-resource</code> command.</p>	<p>Cloud architect, Cloud administrator</p>



Task	Description	Skills required
Create a method response for the search API.	<p>Run the AWS CLI <a href="#">put-method-response</a> command to add a method response for the search API:</p> <pre data-bbox="597 443 1027 997">aws apigateway put-method-response \   --rest-api-id &lt;API-ID&gt; \   --resource-id &lt;ID from the create-resource command output&gt; \   --http-method GET \   --status-code 200 \   --response-headers '{"application/json": "Empty"}'</pre> <p>For <code>resource-id</code>, specify the ID from the output of the earlier <code>create-resource</code> command.</p>	Cloud architect, Cloud administrator

Task	Description	Skills required
Set up a proxy Lambda integration for the search API.	<p>Run the AWS CLI command <a href="#">put-integration</a> command to set up an integration with the Lambda search function:</p> <pre data-bbox="592 441 1031 1276">aws apigateway put-integration \   --rest-api-id &lt;API-ID&gt; \   --resource-id &lt;ID from the create-resource command output&gt; \   --http-method GET \   --type AWS_PROXY \   --integration-http-method GET \   --uri arn:aws:apigateway:region:lambda:path/2015-03-31/functions/arn:aws:lambda:&lt;region&gt;:&lt;account-id&gt;:function:&lt;function-name&gt;/invocations</pre> <p>For <code>resource-id</code>, specify the ID from the earlier <code>create-resource</code> command.</p>	Cloud architect, Cloud administrator

Task	Description	Skills required
Grant API Gateway permission to call the Lambda search function.	<p>Run the AWS CLI <a href="#">add-permission</a> command to give API Gateway permission to use the search function:</p> <pre data-bbox="597 443 1027 1079">aws lambda add-permission \   --function-name   &lt;function-name&gt; \   --statement-id   apigateway-get \   --action lambda:InvokeFunction \   --principal apigateway.amazonaws.com \   --source-arn   "arn:aws:execute-api:&lt;region&gt;:&lt;account-id&gt;:api-id/*/GET/search</pre> <p>Change the source-arn path if you used a different API resource name instead of search.</p>	Cloud architect, Cloud administrator

Task	Description	Skills required
Deploy the search API.	<p>Run the AWS CLI <a href="#">create-deployment</a> command to create a stage resource named dev:</p> <pre data-bbox="594 394 1026 634">aws apigateway create-deployment \   --rest-api-id &lt;API-ID&gt; \   --stage-name dev</pre> <p>If you update the API, you can use the same CLI command to redeploy it to the same stage.</p>	Cloud architect, Cloud administrator

## Create and configure Kibana roles

Task	Description	Skills required
Log in to the Kibana console.	<ol style="list-style-type: none"> <li>Find the link to Kibana on your domain dashboard on the Amazon OpenSearch Service console. The URL is in the form: &lt;domain-endpoint&gt;/_plugin/kibana/ .</li> <li>Use the bastion host you configured in the first epic to access the Kibana console.</li> <li>Log in to the Kibana console by using the master user name and password from the earlier step, when you created</li> </ol>	Cloud architect, Cloud administrator

Task	Description	Skills required
	the Amazon OpenSearch Service domain.  4. When prompted to select a tenant, choose <b>Private</b> .	

Task	Description	Skills required
Create and configure Kibana roles.	<p>To provide data isolation and to make sure that one tenant cannot retrieve the data of another tenant, you need to use document security, which allows tenants to access only documents that contain their tenant ID.</p> <ol style="list-style-type: none"><li>1. On the Kibana console, in the navigation pane, choose <b>Security, Role</b>.</li><li>2. Create a new tenant role.</li><li>3. Set cluster permissions to <code>indices_all</code> , which gives create, read, update, and delete (CRUD) permissions on the Amazon OpenSearch Service index.</li><li>4. Restrict index permissions to the <code>tenant-data</code> index. (The index name should match the name in the Lambda search and index functions.)</li><li>5. Set index permissions to <code>indices_all</code> , to enable users to perform all index-related operations. (You can restrict operations for more granular access, depending on your requirements.)</li></ol>	Cloud architect, Cloud administrator

Task	Description	Skills required
	<p>6. For document-level security, use the following policy to filter documents by tenant ID, to provide data isolation for tenants in a shared index:</p> <pre data-bbox="630 520 1029 957">{   "bool": {     "must": {       "match": {         "TenantId":         "Tenant-1"       }     }   } }</pre> <p>The index name, properties, and values are case-sensitive.</p>	

Task	Description	Skills required
Map users to roles.	<ol style="list-style-type: none"><li>1. Choose the <b>Mapped users</b> tab for the role, and then choose <b>Map users</b>.</li><li>2. In the <b>Backend roles</b> section, specify the ARN of the IAM tenant role that you created earlier, and then choose <b>Map</b>. This maps the IAM tenant role to the Kibana role so that tenant-specific search returns data for that tenant only. For example, if the IAM role name for Tenant-1 is <code>Tenant-1-Role</code>, specify the ARN for <code>Tenant-1-Role</code> (from the <i>Create and configure tenant roles</i> epic) in the <b>Backend roles</b> box for the Tenant-1 Kibana role.</li><li>3. Repeat steps 1 and 2 for Tenant-2.</li></ol> <p>We recommend that you automate the creation of the tenant and Kibana roles at the time of tenant onboarding.</p>	Cloud architect, Cloud administrator



Task	Description	Skills required
Create the tenant-data index.	<p>In the navigation pane, under <b>Management</b>, choose <b>Dev Tools</b>, and then run the following command. This command creates the <code>tenant-data</code> index to define the mapping for the <code>TenantId</code> property.</p> <pre>PUT /tenant-data {   "mappings": {     "properties": {       "TenantId":       { "type": "keyword"}     }   } }</pre>	Cloud architect, Cloud administrator

## Create VPC endpoints for Amazon S3 and AWS STS

Task	Description	Skills required
Create a VPC endpoint for Amazon S3.	<p>Run the AWS CLI <a href="#">create-vpc-endpoint</a> command to create a VPC endpoint for Amazon S3. The endpoint enables the Lambda index function in the VPC to access the Amazon S3 service.</p> <pre>aws ec2 create-vpc- endpoint \   --vpc-id &lt;VPC-ID&gt; \</pre>	Cloud architect, Cloud administrator

Task	Description	Skills required
	<pre data-bbox="594 212 1029 426">--service-name com.amazonaws.us-east-1.s3 \\ --route-table-ids &lt;route-table-ID&gt;</pre> <p data-bbox="594 464 1013 877">For <code>vpc-id</code>, specify the VPC that you're using for the Lambda index function. For <code>service-name</code>, use the correct URL for the Amazon S3 endpoint. For <code>route-table-ids</code>, specify the route table that's associated with the VPC endpoint.</p>	

Task	Description	Skills required
Create a VPC endpoint for AWS STS.	<p>Run the AWS CLI <a href="#">create-vpc-endpoint</a> command to create a VPC endpoint for AWS Security Token Service (AWS STS). The endpoint enables the Lambda index and search functions in the VPC to access the AWS STS service. The functions use AWS STS when they assume the IAM role.</p> <pre data-bbox="597 730 1026 1243">aws ec2 create-vpc-endpoint \   --vpc-id &lt;VPC-ID&gt; \   --vpc-endpoint-type Interface \   --service-name com.amazonaws.us-east-1.sts \   --subnet-id &lt;subnet-ID&gt; \   --security-group-id &lt;security-group-ID&gt;</pre> <p>For <code>vpc-id</code>, specify the VPC that you're using for the Lambda index and search functions. For <code>subnet-id</code>, provide the subnet in which this endpoint should be created. For <code>security-group-id</code>, specify the security group to associate this endpoint with. (It could be the same as the security group Lambda uses.)</p>	Cloud architect, Cloud administrator

## Test multi-tenancy and data isolation

Task	Description	Skills required
<p>Update the Python files for the index and search functions.</p>	<ol style="list-style-type: none"> <li>In the <code>index_lambda_package.zip</code> file, edit the <code>lambda_index.py</code> file to update the AWS account ID, AWS Region, and Elasticsearch endpoint information.</li> <li>In the <code>search_lambda_package.zip</code> file, edit the <code>lambda_search.py</code> file to update the AWS account ID, AWS Region, and Elasticsearch endpoint information.</li> </ol> <p>You can get the Elasticsearch endpoint from the <b>Overview</b> tab of the Amazon OpenSearch Service console. It has the format <code>&lt;AWS-Region&gt;.es.amazonaws.com</code>.</p>	<p>Cloud architect, App developer</p>
<p>Update the Lambda code.</p>	<p>Use the AWS CLI <a href="#">update-function-code</a> command to update the Lambda code with the changes you made to the Python files:</p> <pre>aws lambda update-function-code \</pre>	<p>Cloud architect, App developer</p>

Task	Description	Skills required
<p>Upload raw data to the S3 bucket.</p>	<pre data-bbox="592 205 1027 829"> --function-name index-lambda-function \ --zip-file fileb:// index_lambda_packag e.zip  aws lambda update-fu nction-code \ --function-name search-lambda-func tion \ --zip-file fileb:// search_lambda_packa ge.zip </pre> <p data-bbox="592 861 1027 1186">Use the AWS CLI <a href="#">cp</a> command to upload data for the Tenant-1 and Tenant-2 objects to the <code>tenantrawdata</code> bucket (specify the name of the S3 bucket you created for this purpose):</p> <pre data-bbox="592 1218 1027 1417"> aws s3 cp tenant-1-data s3://tenantrawdata aws s3 cp tenant-2-data s3://tenantrawdata </pre> <p data-bbox="592 1459 1027 1707">The S3 bucket is set up to run the Lambda index function whenever data is uploaded so that the document is indexed in Elasticsearch.</p>	<p>Cloud architect, Cloud administrator</p>

Task	Description	Skills required
<p>Search data from the Kibana console.</p>	<p>On the Kibana console, run the following query:</p> <pre data-bbox="597 346 1027 466">GET tenant-data/_search</pre> <p>This query displays all the documents indexed in Elasticsearch. In this case, you should see two, separate documents for Tenant-1 and Tenant-2.</p>	<p>Cloud architect, Cloud administrator</p>

Task	Description	Skills required
Test the search API from API Gateway.	<ol style="list-style-type: none"><li data-bbox="592 226 1027 499">1. In the API Gateway console, open the search API, choose the GET method inside the search resource, and then choose <b>Test</b>.</li><li data-bbox="592 520 1027 751">2. In the test window, provide the following query string (case-sensitive) for the tenant ID, and then choose <b>Test</b>. <div data-bbox="630 783 1027 867" style="border: 1px solid #ccc; border-radius: 10px; padding: 5px; text-align: center;">TenantId=Tenant-1</div><p data-bbox="630 905 1027 1276">The Lambda function sends a query to Amazon OpenSearch Service that filters the tenant document based on the document-level security. The method returns the document that belongs to Tenant-1.</p></li><li data-bbox="592 1297 1027 1329">3. Change the query string to: <div data-bbox="630 1367 1027 1451" style="border: 1px solid #ccc; border-radius: 10px; padding: 5px; text-align: center;">TenantId=Tenant-2</div><p data-bbox="630 1486 1027 1612">This query returns the document that belongs to Tenant-2.</p></li></ol> <p data-bbox="592 1696 1027 1822">For screen illustrations, see the <a href="#">Additional information</a> section.</p>	Cloud architect, App developer

## Related resources

- [AWS SDK for Python \(Boto3\)](#)
- [AWS Lambda documentation](#)
- [Amazon API Gateway documentation](#)
- [Amazon S3 documentation](#)
- [Amazon OpenSearch Service documentation](#)
  - [Fine-grained access control in Amazon OpenSearch Service](#)
  - [Creating a search application with Amazon OpenSearch Service](#)
  - [Launching your Amazon OpenSearch Service domains within a VPC](#)

## Additional information

### Data partitioning models

There are three common data partitioning models used in multi-tenant systems: silo, pool, and hybrid. The model you choose depends on the compliance, noisy neighbor, operations, and isolation needs of your environment.

#### *Silo model*

In the silo model, each tenant's data is stored in a distinct storage area where there is no commingling of tenant data. You can use two approaches to implement the silo model with Amazon OpenSearch Service: domain per tenant and index per tenant.

- **Domain per tenant** – You can use a separate Amazon OpenSearch Service domain (synonymous with an Elasticsearch cluster) per tenant. Placing each tenant in its own domain provides all the benefits associated with having data in a standalone construct. However, this approach introduces management and agility challenges. Its distributed nature makes it harder to aggregate and assess the operational health and activity of tenants. This is a costly option that requires each Amazon OpenSearch Service domain to have three master nodes and two data nodes for production workloads at the minimum.



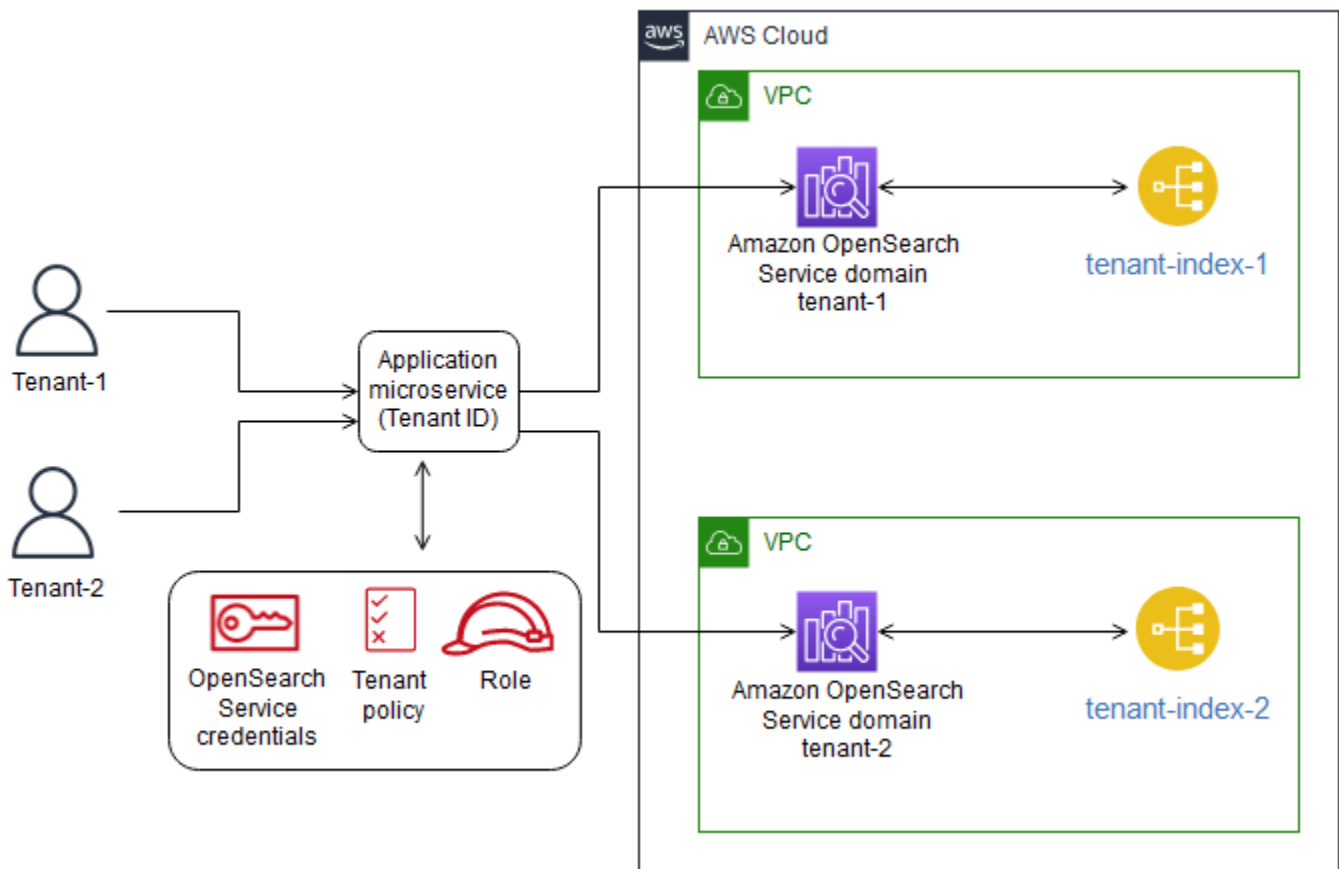

- Index per tenant** – You can place tenant data in separate indexes within an Amazon OpenSearch Service cluster. With this approach, you use a tenant identifier when you create and name the index, by pre-pending the tenant identifier to the index name. The index per tenant approach helps you achieve your silo goals without introducing a completely separate cluster for each tenant. However, you might encounter memory pressure if the number of indexes grows, because this approach requires more shards, and the master node has to handle more allocation and rebalancing.

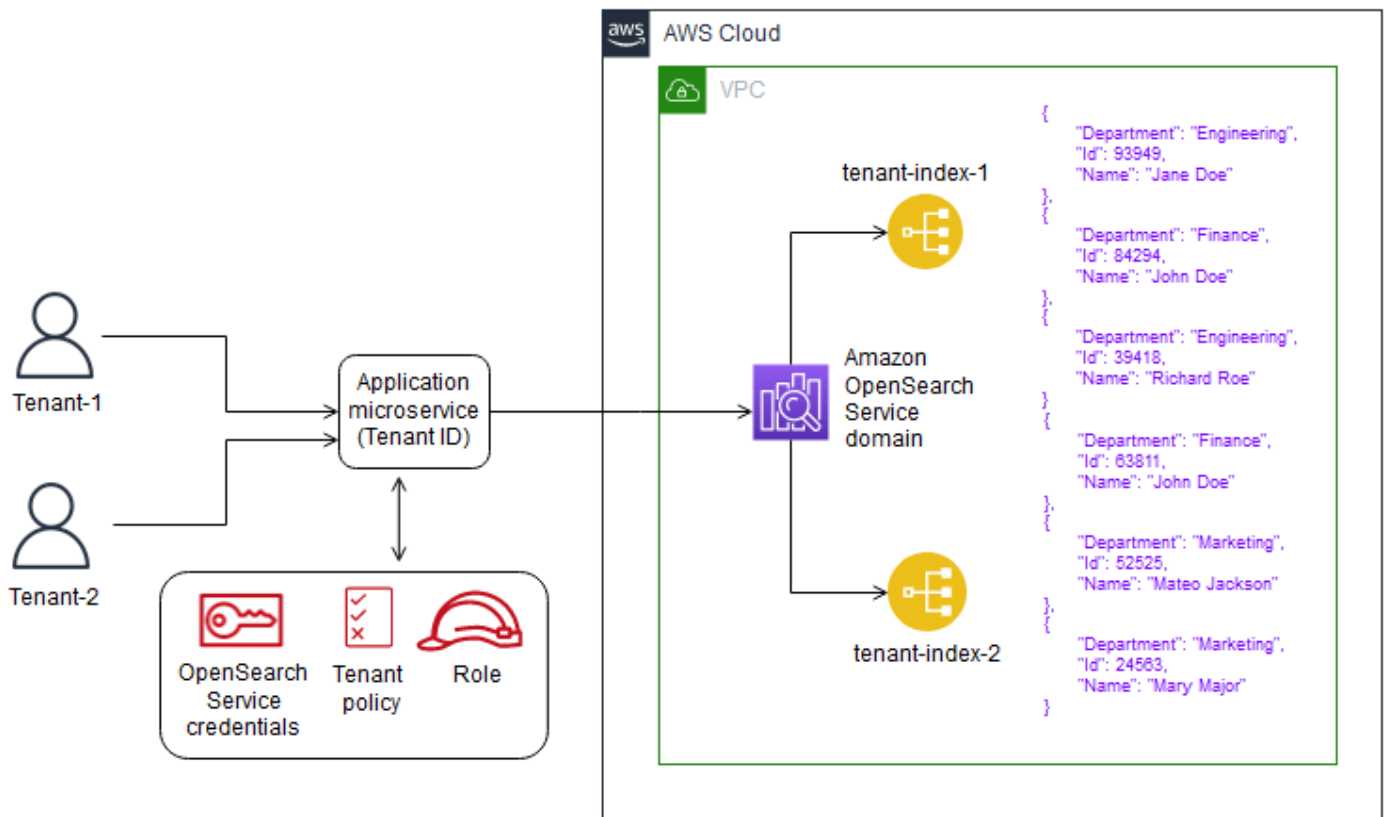

**Isolation in the silo model** – In the silo model, you use IAM policies to isolate the domains or indexes that hold each tenant’s data. These policies prevent one tenant from accessing another tenant’s data. To implement your silo isolation model, you can create a resource-based policy that controls access to your tenant resource. This is often a domain access policy that specifies which actions a principal can perform on the domain’s sub-resources, including Elasticsearch indexes and APIs. With IAM identity-based policies, you can specify *allowed* or *denied* actions on the domain, indexes, or APIs within Amazon OpenSearch Service. The `Action` element of an IAM policy describes the specific action or actions that are allowed or denied by the policy, and the `Principal` element specifies the affected accounts, users, or roles.

The following sample policy grants Tenant-1 full access (as specified by `es : *`) to the sub-resources on the `tenant-1` domain only. The trailing `/*` in the `Resource` element indicates that this policy applies to the domain’s sub-resources, not to the domain itself. When this policy is in effect, tenants are not allowed to create a new domain or modify settings on an existing domain.

```

{
  "Version": "2012-10-17",
  "Statement": [

```

```
{
  "Effect": "Allow",
  "Principal": {
    "AWS": "arn:aws:iam::aws-account-id:user/Tenant-1"
  },
  "Action": "es:*",
  "Resource": "arn:aws:es:Region:account-id:domain/tenant-1/*"
}
```

To implement the tenant per Index silo model, you would need to modify this sample policy to further restrict Tenant-1 to the specified index or indexes, by specifying the index name. The following sample policy restricts Tenant-1 to the `tenant-index-1` index.

```
{
  "Version": "2012-10-17",
  "Statement": [
    {
      "Effect": "Allow",
      "Principal": {
        "AWS": "arn:aws:iam::123456789012:user/Tenant-1"
      },
      "Action": "es:*",
      "Resource": "arn:aws:es:Region:account-id:domain/test-domain/tenant-index-1/*"
    }
  ]
}
```

### *Pool model*

In the pool model, all tenant data is stored in an index within the same domain. The tenant identifier is included in the data (document) and used as the partition key, so you can determine which data belongs to which tenant. This model reduces the management overhead. Operating and managing the pooled index is easier and more efficient than managing multiple indexes. However, because tenant data is commingled within the same index, you lose the natural tenant isolation that the silo model provides. This approach might also degrade performance because of the noisy neighbor effect.

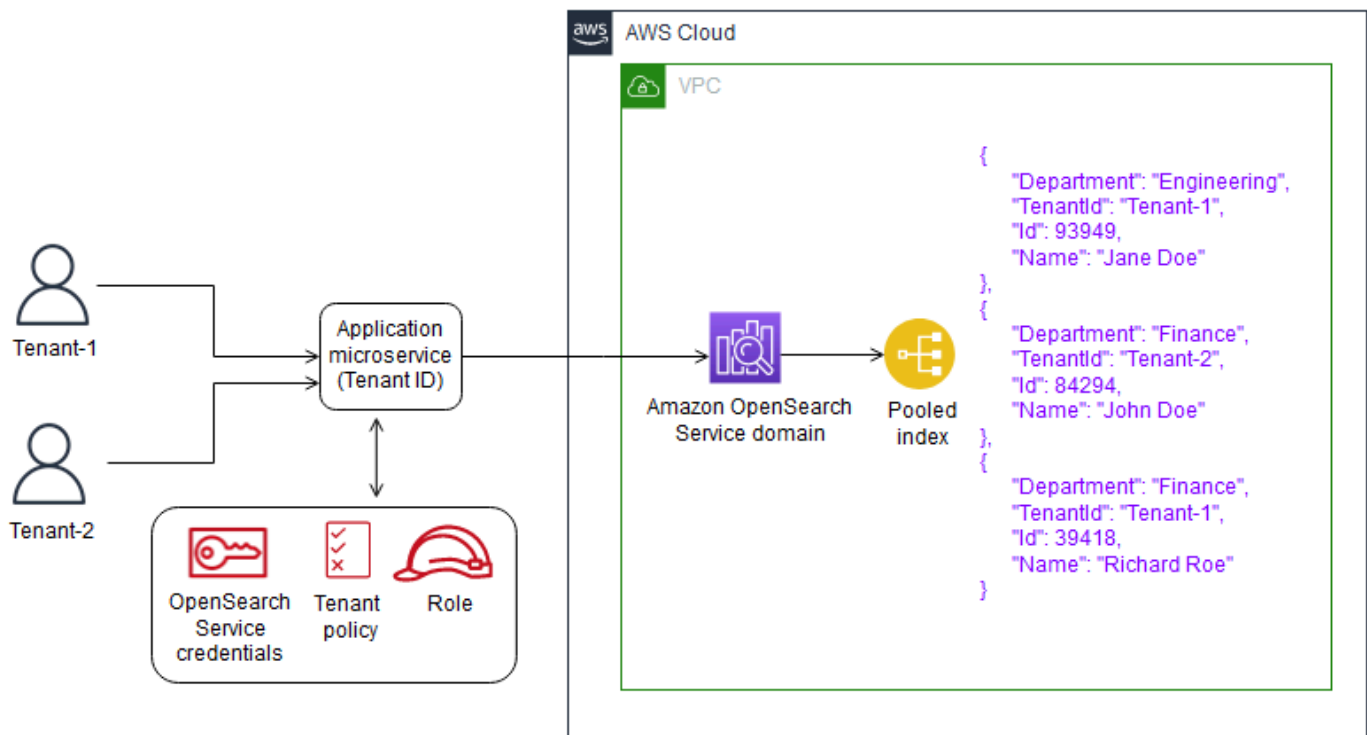

**Tenant isolation in the pool model** – In general, tenant isolation is challenging to implement in the pool model. The IAM mechanism used with the silo model doesn't allow you to describe isolation based on the tenant ID stored in your document.

An alternative approach is to use the [fine-grained access control](#) (FGAC) support provided by the Open Distro for Elasticsearch. FGAC allows you to control permissions at an index, document, or field level. With each request, FGAC evaluates the user credentials and either authenticates the user or denies access. If FGAC authenticates the user, it fetches all roles mapped to that user and uses the complete set of permissions to determine how to handle the request.

To achieve the required isolation in the pooled model, you can use [document-level security](#), which lets you restrict a role to a subset of documents in an index. The following sample role restricts queries to Tenant-1. By applying this role to Tenant-1, you can achieve the necessary isolation.

```

{
  "bool": {
    "must": {
      "match": {
        "tenantId": "Tenant-1"
      }
    }
  }
}

```

```
}
}
```

## Hybrid model

The **hybrid model** uses a combination of the silo and pool models in the same environment to offer unique experiences to each tenant tier (such as free, standard, and premium tiers). Each tier follows the same security profile that was used in the pool model.

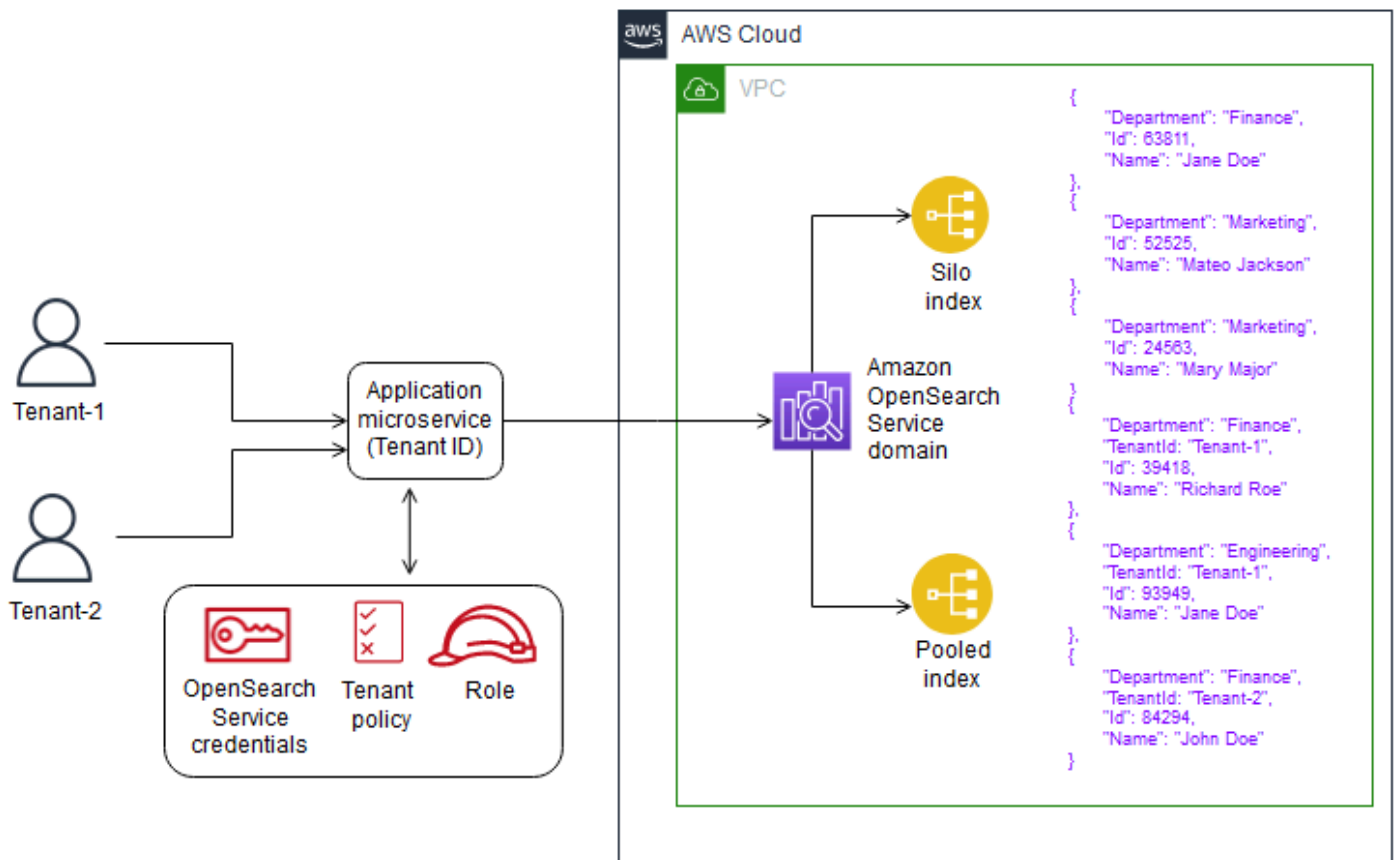

**Tenant isolation in the hybrid model** – In the hybrid model, you follow the same security profile as in the pool model, where using the FGAC security model at the document level provided tenant isolation. Although this strategy simplifies cluster management and offers agility, it complicates other aspects of the architecture. For example, your code requires additional complexity to determine which model is associated with each tenant. You also have to ensure that single-tenant queries don't saturate the entire domain and degrade the experience for other tenants.

## Testing in API Gateway

### Test window for Tenant-1 query

← Method Execution
/search - GET - Method Test

Make a test call to your method. When you make a test call, API Gateway skips authorization and directly invokes your method

**Path**

No path parameters exist for this resource. You can define path parameters by using the syntax `{myPathParam}` in a resource path.

**Query Strings**

**{search}**

**Headers**

**{search}**

Use a colon (:) to separate header name and value, and new lines to declare multiple headers. eg. Accept:application/json.

**Stage Variables**

No [stage variables](#) exist for this method.

**Client Certificate**

No client certificates have been generated.

**Request Body**

Request Body is not supported for GET methods.

**Request:** /search?TenantId=Tenant-1

**Status:** 200

**Latency:** 235 ms

**Response Body**

```

{
  "took": 10,
  "timed_out": false,
  "_shards": {
    "total": 5,
    "successful": 5,
    "skipped": 0,
    "failed": 0
  },
  "hits": {
    "total": {
      "value": 1,
      "relation": "eq"
    },
    "max_score": 2,
    "hits": [
      {
        "_index": "tenant-data",
        "_type": "_doc",
        "_id": "6_5sz3o8ip2qDx7esAAi",
        "_score": 2,
        "_source": {
          "TenantId": "Tenant-1",
          "Id": "TestId-1",
          "Name": "Test Tenant 1"
        }
      }
    ]
  }
}
                
```

Test

### Test window for Tenant-2 query

← Method Execution
/search - GET - Method Test

Make a test call to your method. When you make a test call, API Gateway skips authorization and directly invokes your method

**Path**

No path parameters exist for this resource. You can define path parameters by using the syntax **{myPathParam}** in a resource path.

**Query Strings**

**{search}**

**Headers**

**{search}**

Use a colon (:) to separate header name and value, and new lines to declare multiple headers. eg. Accept:application/json.

**Stage Variables**

No [stage variables](#) exist for this method.

**Client Certificate**

No client certificates have been generated.

**Request Body**

Request Body is not supported for GET methods.

**Request:** /search?TenantId=Tenant-2

**Status:** 200

**Latency:** 891 ms

**Response Body**

```

{
  "took": 166,
  "timed_out": false,
  "_shards": {
    "total": 5,
    "successful": 5,
    "skipped": 0,
    "failed": 0
  },
  "hits": {
    "total": {
      "value": 1,
      "relation": "eq"
    },
    "max_score": 2,
    "hits": [
      {
        "_index": "tenant-data",
        "_type": "_doc",
        "_id": "7P5sz3oBip2qDx7ezAB6",
        "_score": 2,
        "_source": {
          "TenantId": "Tenant-2",
          "Id": "TestId-2",
          "Name": "Test Tenant 2"
        }
      }
    ]
  }
}
          
```

Test

## Attachments

To access additional content that is associated with this document, unzip the following file:  
[attachment.zip](#)

# Deploy multiple-stack applications using AWS CDK with TypeScript

Created by Dr. Rahul Sharad Gaikwad (AWS)

**Environment:** Production

**Technologies:** Modernization; Migration; DevOps

**Workload:** All other workloads

**AWS services:** Amazon API Gateway; AWS Lambda; Amazon Kinesis

## Summary

This pattern provides a step-by-step approach for application deployment on Amazon Web Services (AWS) using AWS Cloud Development Kit (AWS CDK) with TypeScript. As an example, the pattern deploys a serverless real-time analytics application.

The pattern builds and deploys nested stack applications. The parent AWS CloudFormation stack calls the child, or nested, stacks. Each child stack builds and deploys the AWS resources that are defined in the CloudFormation stack. AWS CDK Toolkit, the command line interface (CLI) command `cdk`, is the primary interface for the CloudFormation stacks.

## Prerequisites and limitations

### Prerequisites

- An active AWS account
- Existing virtual private cloud (VPC) and subnets
- AWS CDK Toolkit installed and configured
- A user with administrator permissions and a set of access keys.
- Node.js
- AWS Command Line Interface (AWS CLI)

### Limitations



- Because AWS CDK uses AWS CloudFormation, AWS CDK applications are subject to CloudFormation service quotas. For more information, see [AWS CloudFormation quotas](#).

## Product versions

This pattern has been built and tested using the following tools and versions.

- AWS CDK Toolkit 1.83.0
- Node.js 14.13.0
- npm 7.0.14

The pattern should work with any version of AWS CDK or npm. Note that Node.js versions 13.0.0 through 13.6.0 are not compatible with the AWS CDK.

## Architecture

### Target technology stack

- AWS Amplify Console
- Amazon API Gateway
- AWS CDK
- Amazon CloudFront
- Amazon Cognito
- Amazon DynamoDB
- Amazon Data Firehose
- Amazon Kinesis Data Streams
- AWS Lambda
- Amazon Simple Storage Service (Amazon S3)

### Target architecture

The following diagram shows multiple-stack application deployment using AWS CDK with TypeScript.

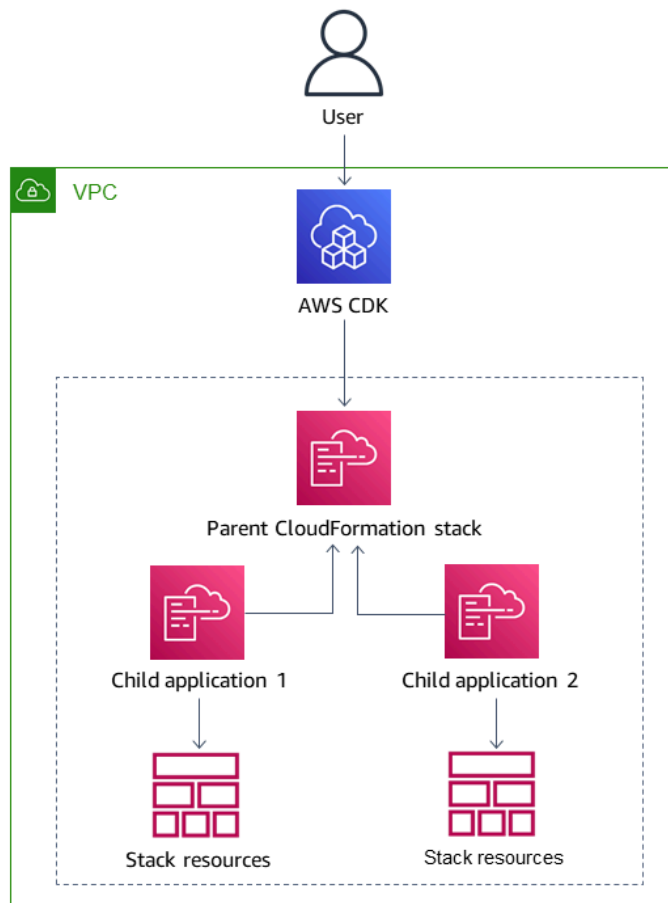

The following diagram shows the architecture of the example serverless real-time application.

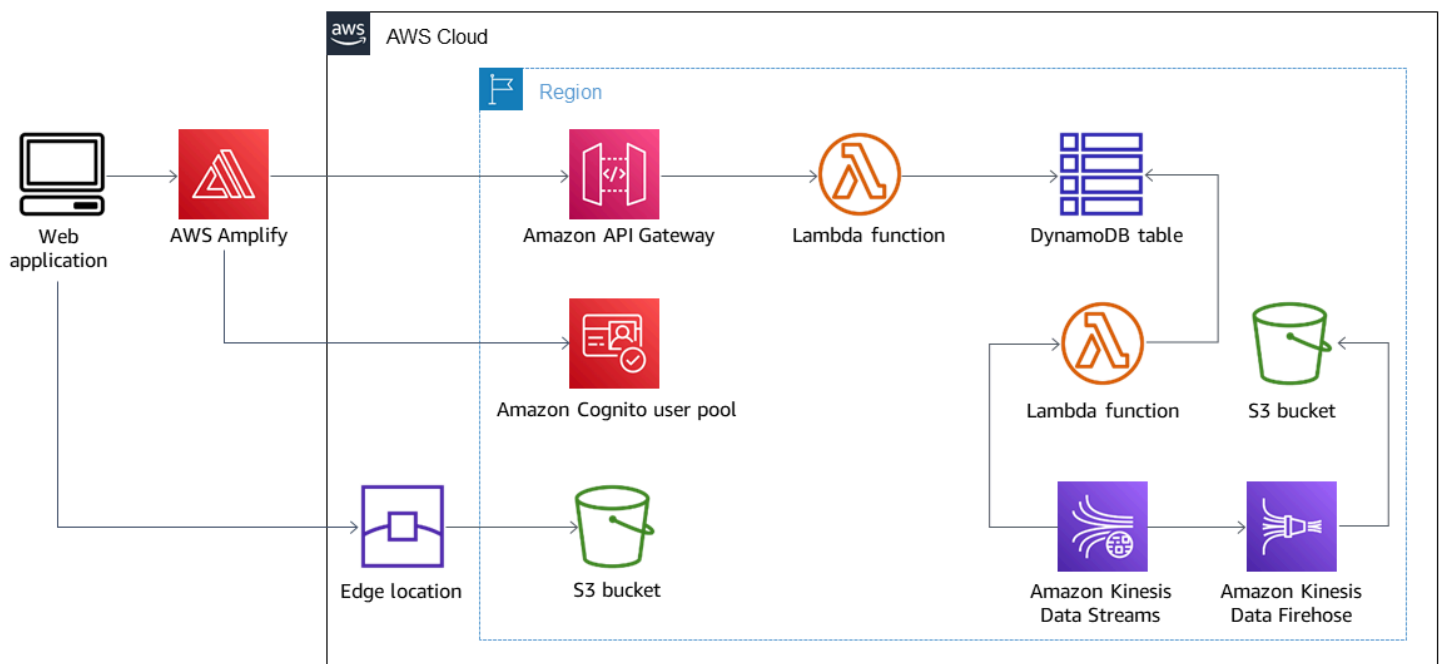

# Tools

## Tools

- [AWS Amplify Console](#) is the control center for fullstack web and mobile application deployments in AWS. Amplify Console hosting provides a git-based workflow for hosting fullstack serverless web apps with continuous deployment. The Admin UI is a visual interface for frontend web and mobile developers to create and manage app backends outside the AWS console.
- [Amazon API Gateway](#) is an AWS service for creating, publishing, maintaining, monitoring, and securing REST, HTTP, and WebSocket APIs at any scale.
- [AWS Cloud Development Kit \(AWS CDK\)](#) is a software development framework that helps you define and provision AWS Cloud infrastructure in code.
- [AWS CDK Toolkit](#) is a command line cloud development kit that helps you interact with your AWS CDK app. The cdk CLI command is the primary tool for interacting with your AWS CDK app. It runs your app, interrogates the application model you defined, and produces and deploys the AWS CloudFormation templates generated by the AWS CDK.
- [Amazon CloudFront](#) is a web service that speeds up distribution of static and dynamic web content, such as .html, .css, .js, and image files. CloudFront delivers your content through a worldwide network of data centers called edge locations for lower latency and improved performance.
- [Amazon Cognito](#) provides authentication, authorization, and user management for your web and mobile apps. Your users can sign in directly or through a third party.
- [Amazon DynamoDB](#) is a fully managed NoSQL database service that provides fast and predictable performance with seamless scalability.
- [Amazon Data Firehose](#) is a fully managed service for delivering real-time [streaming data](#) to destinations such as Amazon S3, Amazon Redshift, Amazon OpenSearch Service, Splunk, and any custom HTTP endpoint or HTTP endpoints owned by supported third-party service providers.
- [Amazon Kinesis Data Streams](#) is a service for collecting and processing large streams of data records in real time.
- [AWS Lambda](#) is a compute service that supports running code without provisioning or managing servers. Lambda runs your code only when needed and scales automatically, from a few requests per day to thousands per second. You pay only for the compute time that you consume—there is no charge when your code is not running.
- [Amazon Simple Storage Service \(Amazon S3\)](#) is a cloud-based object storage service that helps you store, protect, and retrieve any amount of data.

## Code

The code for this pattern is attached.

## Epics

### Install AWS CDK Toolkit

Task	Description	Skills required
Install AWS CDK Toolkit.	To install AWS CDK Toolkit globally, run the following command.  <code>npm install -g aws-cdk</code>	DevOps
Verify the version.	To verify the AWS CDK Toolkit version, run the following command.  <code>cdk --version</code>	DevOps

### Set up AWS credentials

Task	Description	Skills required
Set up credentials.	To set up credentials, run the <code>aws configure</code> command and follow the prompts.  <pre>\$aws configure AWS Access Key ID [None]: AWS Secret Access Key [None]: your_secret_access_key Default region name [None]:</pre>	DevOps

Task	Description	Skills required
	Default output format [None]:	

## Download the project code

Task	Description	Skills required
Download the attached project code.	For more information about the directory and file structure, see the <i>Additional information</i> section.	DevOps

## Bootstrap the AWS CDK environment

Task	Description	Skills required
Bootstrap the environment.	<p>To deploy the AWS CloudFormation template to the account and AWS Region that you want to use, run the following command.</p> <pre>cdk bootstrap &lt;account&gt;/&lt;Region&gt;</pre> <p>For more information, see the <a href="#">AWS documentation</a>.</p>	DevOps

## Build and deploy the project

Task	Description	Skills required
Build the project.	To build the project code, run the <code>npm run build</code> command.	DevOps
Deploy the project.	To deploy the project code, run the <code>cdk deploy</code> command.	

## Verify outputs

Task	Description	Skills required
Verify stack creation.	On the AWS Management Console, choose <b>CloudFormation</b> . In the stacks for the project, verify that a parent stack and two child stacks have been created.	DevOps

## Test the application

Task	Description	Skills required
Send data to Kinesis Data Streams.	Configure your AWS Account to send data to Kinesis Data Streams using Amazon Kinesis Data Generator (KDG). For more information, see <a href="#">Amazon Kinesis Data Generator</a> .	DevOps

Task	Description	Skills required
Create an Amazon Cognito user.	To create an Amazon Cognito user, download the cognito-setup.json CloudFormation template from the <i>Create an Amazon Cognito User</i> section on the <a href="#">Kinesis Data Generator help page</a> . Initiate the template, and then enter your Amazon Cognito <b>Username</b> and <b>Password</b> .  The <b>Outputs</b> tab lists the Kinesis Data Generator URL.	DevOps
Log in to Kinesis Data Generator	To log in to KDG, use the Amazon Cognito credentials that you provided and the Kinesis Data Generator URL.	DevOps
Test the application.	In KDG, in <b>Record template, Template 1</b> , paste the test code from the <i>Additional information</i> section, and choose <b>Send data</b> .	DevOps
Test API Gateway.	After the data has been ingested, test API Gateway by using the GET method to retrieve data.	DevOps

## Related resources

### References

- [AWS Cloud Development Kit](#)

- [AWS CDK on GitHub](#)
- [Working with nested stacks](#)
- [AWS sample example - Serverless real-time analytics](#)

## Additional information

### Directory and file details

This pattern sets up the following three stacks.

- `parent-cdk-stack.ts` – This stack acts as the parent stack and calls the two child applications as nested stacks.
- `real-time-analytics-poc-stack.ts` – This nested stack contains the infrastructure and application code.
- `real-time-analytics-web-stack.ts` – This nested stack contains only the static web application code.

### *Important files and their functionality*

- `bin/real-time-analytics-poc.ts` – Entry point of the AWS CDK application. It loads all stacks defined under `lib/`.
- `lib/real-time-analytics-poc-stack.ts` – Definition of the AWS CDK application's stack (`real-time-analytics-poc`).
- `lib/real-time-analytics-web-stack.ts` – Definition of the AWS CDK application's stack (`real-time-analytics-web-stack`).
- `lib/parent-cdk-stack.ts` – Definition of the AWS CDK application's stack (`parent-cdk`).
- `package.json` – npm module manifest, which includes the application name, version, and dependencies.
- `package-lock.json` – Maintained by npm.
- `cdk.json` – Toolkit for running the application.
- `tsconfig.json` – The project's TypeScript configuration.
- `.gitignore` – List of files that Git should exclude from source control.
- `node_modules` – Maintained by npm; includes the project's dependencies.



The following section of code in the parent stack calls child applications as a nested AWS CDK stacks.

```
import * as cdk from '@aws-cdk/core';
import { Construct, Stack, StackProps } from '@aws-cdk/core';
import { RealTimeAnalyticsPocStack } from './real-time-analytics-poc-stack';
import { RealTimeAnalyticsWebStack } from './real-time-analytics-web-stack';

export class CdkParentStack extends Stack {
  constructor(scope: Construct, id: string, props?: StackProps) {
    super(scope, id, props);

    new RealTimeAnalyticsPocStack(this, 'RealTimeAnalyticsPocStack');
    new RealTimeAnalyticsWebStack(this, 'RealTimeAnalyticsWebStack');
  }
}
```

## Code for testing

```
session={{date.now('YYYYMMDD')}}|sequence={{date.now('x')}}|
reception={{date.now('x')}}|instrument={{random.number(9)}}|
l={{random.number(20)}}|price_0={{random.number({"min":10000,
"max":30000})}}|price_1={{random.number({"min":10000, "max":30000})}}|
price_2={{random.number({"min":10000, "max":30000})}}|
price_3={{random.number({"min":10000, "max":30000})}}|
price_4={{random.number({"min":10000, "max":30000})}}|
price_5={{random.number({"min":10000, "max":30000})}}|
price_6={{random.number({"min":10000, "max":30000})}}|
price_7={{random.number({"min":10000, "max":30000})}}|
price_8={{random.number({"min":10000, "max":30000})}}|
```

## Testing API Gateway

On the API Gateway console, test API Gateway by using the GET method.

APIs > analytics-api (yd8a9e771b) > Resources > /data (I7J7fu) > GET

Resources **Actions** ← Method Execution /data - GET - Method Test

OPTIONS

▼ /data

GET

OPTIONS

Make a test call to your method with the provided input

**Path**

No path parameters exist for this resource. You can define path parameters by using the syntax `{myPathParam}` in a resource path.

**Query Strings**

**{data}**

param1=value1&param2=value2

**Headers**

**{data}**

Use a colon (:) to separate header name and value, and new lines to declare multiple headers. eg. Accept:application/json.

**Stage Variables**

No [stage variables](#) exist for this method.

**Client Certificate**

No client certificates have been generated.

**Request Body**

Request Body is not supported for GET methods.

⚡ Test

**Request:** /data

**Status:** 200

**Latency:** 675 ms

**Response Body**

```
[
  {
    "price_0": 186.41,
    "price_2": 261.36,
    "price_1": 246,
    "price_4": 163.55,
    "price_3": 118.05,
    "price_6": 294.13,
    "price_5": 210.05,
    "l": {
      "s": "20"
    },
    "reception": {
      "N": "1610386090771"
    },
    "price_8": 239.59,
    "price_7": 141.3,
    "instrument": 7,
    "seq": {
      "N": "1610386090771"
    },
    "bsession": {
      "s": "20210111"
    }
  },
  {
    "price_0": 160.87,
    "price_2": 179.34,
    "price_1": 275.48,
    "price_4": 164.5,
    "price_3": 130.64,
```

## Attachments

To access additional content that is associated with this document, unzip the following file: [attachment.zip](#)

# Automate deployment of nested applications using AWS SAM

Created by Dr. Rahul Sharad Gaikwad (AWS), Dmitry Gulin (AWS), Ishwar Chauthaiwale (AWS), and Tabby Ward (AWS)

<b>Code repository:</b> <a href="#">aws-sam-nested-stack-sample</a>	<b>Environment:</b> PoC or pilot	<b>Technologies:</b> Modernization; Serverless; DevOps
<b>Workload:</b> All other workloads	<b>AWS services:</b> AWS Serverless Application Repository	

## Summary

On Amazon Web Services (AWS), AWS Serverless Application Model (AWS SAM) is an open-source framework that provides shorthand syntax to express functions, APIs, databases, and event source mappings. With just a few lines for each resource, you can define the application you want and model it by using YAML. During deployment, SAM transforms and expands the SAM syntax into AWS CloudFormation syntax that you can use to build serverless applications faster.

AWS SAM simplifies the development, deployment, and management of serverless applications on the AWS platform. It provides a standardized framework, faster deployment, local testing capabilities, resource management, seamless Integration with Development Tools, and a supportive community. These features make it a valuable tool for building serverless applications efficiently and effectively.

This pattern uses AWS SAM templates to automate the deployment of nested applications. A nested application is an application within another application. Parent applications call their child applications. These are loosely coupled components of a serverless architecture.

Using nested applications, you can rapidly build highly sophisticated serverless architectures by reusing services or components that are independently authored and maintained but are composed using AWS SAM and the Serverless Application Repository. Nested applications help you to build applications that are more powerful, avoid duplicated work, and ensure consistency and best practices across your teams and organizations. To demonstrate nested applications, the pattern deploys an [example AWS serverless shopping cart application](#).

## Prerequisites and limitations

### Prerequisites

- An active AWS account
- An existing virtual private cloud (VPC) and subnets
- An integrated development environment, such as AWS Cloud9 or Visual Studio Code (for more information, see [Tools to Build on AWS](#))
- Python wheel library installed using pip install wheel, if it's not already installed

### Limitations

- The maximum number of applications that can be nested in a serverless application is 200.
- The maximum number of parameters for a nested application can have 60.

### Product versions

- This solution is built on AWS SAM command line interface (AWS SAM CLI) version 1.21.1, but this architecture should work with later AWS SAM CLI versions.

## Architecture

### Target technology stack

- Amazon API Gateway
- AWS SAM
- Amazon Cognito
- Amazon DynamoDB
- AWS Lambda
- Amazon Simple Queue Service (Amazon SQS) queue

### Target architecture

The following diagram shows how user requests are made to the shopping services by calling APIs. The user's request, including all necessary information, is sent to Amazon API Gateway and the

Amazon Cognito authorizer, which performs authentication and authorization mechanisms for the APIs.

When an item is added, deleted, or updated in DynamoDB, an event is put onto DynamoDB Streams, which in turn initiates a Lambda function. To avoid immediate deletion of old items as part of a synchronous workflow, messages are put onto an SQS queue, which initiates a worker function to delete the messages.

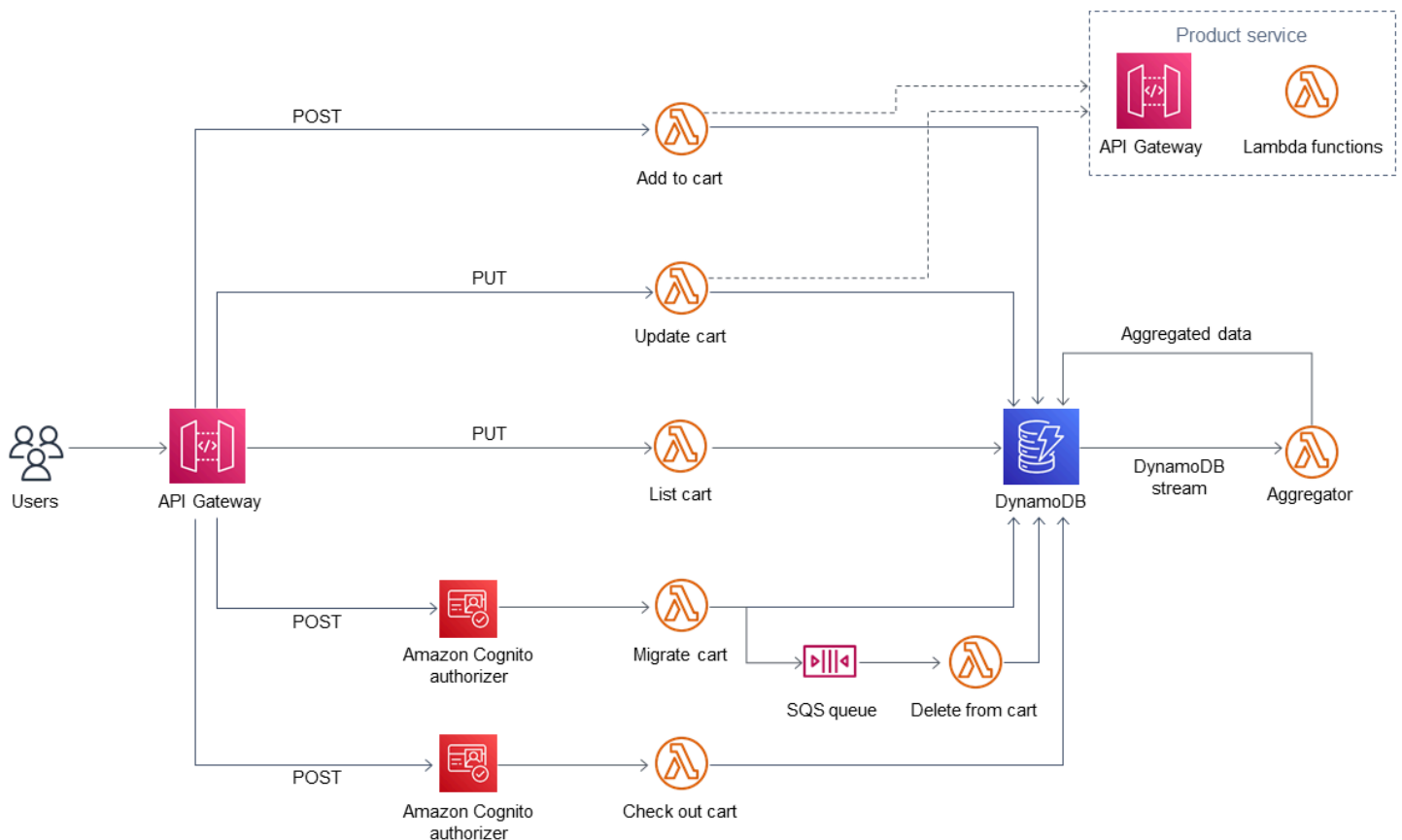

In this solution setup, AWS SAM CLI serves as the interface for AWS CloudFormation stacks. AWS SAM templates automatically deploy nested applications. The parent SAM template calls the child templates, and the parent CloudFormation stack deploys the child stacks. Each child stack builds the AWS resources that are defined in the AWS SAM CloudFormation templates.

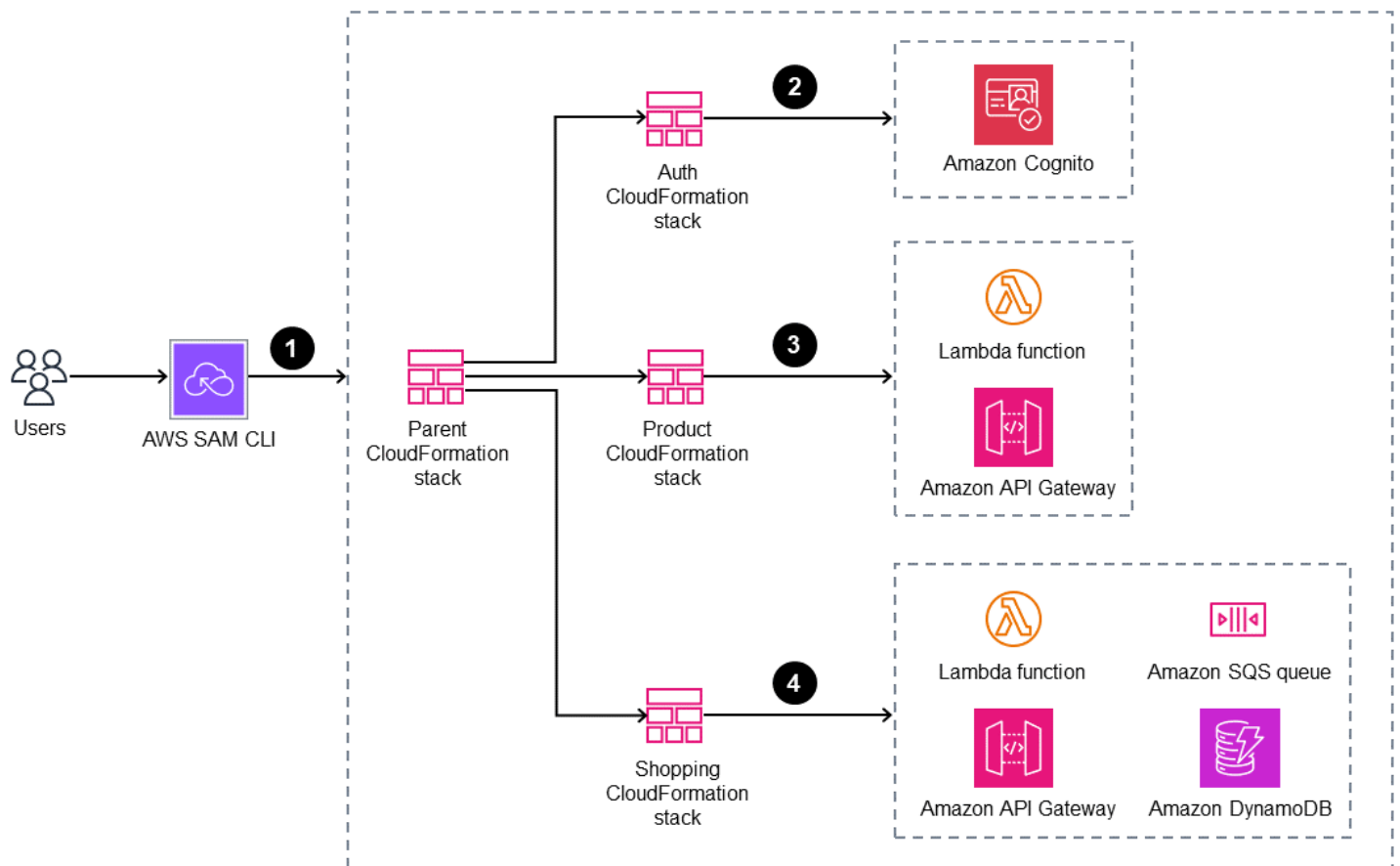

1. Build and deploy the stacks.
2. The Auth CloudFormation stack contains Amazon Cognito.
3. The Product CloudFormation stack contains an Lambda function and Amazon API Gateway
4. The Shopping CloudFormation stack contains a Lambda function, Amazon API Gateway, the SQS queue, and the Amazon DynamoDB database.

## Tools

### Tools

- [Amazon API Gateway](#) helps you create, publish, maintain, monitor, and secure REST, HTTP, and WebSocket APIs at any scale.
- [AWS CloudFormation](#) helps you set up AWS resources, provision them quickly and consistently, and manage them throughout their lifecycle across AWS accounts and Regions.
- [Amazon Cognito](#) provides authentication, authorization, and user management for web and mobile apps.

- [Amazon DynamoDB](#) is a fully managed NoSQL database service that provides fast, predictable, and scalable performance.
- [AWS Lambda](#) is a compute service that helps you run code without needing to provision or manage servers. It runs your code only when needed and scales automatically, so you pay only for the compute time that you use.
- [AWS Serverless Application Model \(AWS SAM\)](#) is an open-source framework that helps you build serverless applications in the AWS Cloud.
- [Amazon Simple Queue Service \(Amazon SQS\)](#) provides a secure, durable, and available hosted queue that helps you integrate and decouple distributed software systems and components.

## Code

The code for this pattern is available in the GitHub [AWS SAM Nested Stack Sample](#) repository.

## Epics

### Install AWS SAM CLI

Task	Description	Skills required
Install AWS SAM CLI.	To install AWS SAM CLI, see the instructions in the <a href="#">AWS SAM documentation</a> .	DevOps engineer
Set up AWS credentials.	To set AWS credentials so that the AWS SAM CLI can make calls to AWS services on your behalf, run the <code>aws configure</code> command and follow the prompts. <pre> \$aws configure AWS Access Key ID [None]: &lt;your_access_key_id&gt; AWS Secret Access Key [None]: your_secret_access_key </pre>	DevOps engineer

Task	Description	Skills required
	<p>Default region name [None]:</p> <p>Default output format [None]:</p> <p>For more information on setting up your credentials, see <a href="#">Authentication and access credentials</a>.</p>	

## Initialize the AWS SAM project

Task	Description	Skills required
Clone the AWS SAM code repository.	<ol style="list-style-type: none"> <li>Clone the <a href="#">aws sam nested stack sample</a> repository for this pattern by entering the following command.           <pre>git clone https://github.com/aws-samples/aws-sam-nested-stack-sample.git</pre> </li> <li>Navigate into the cloned directory by entering the following command.           <pre>cd aws-sam-nested-stack-sample</pre> </li> </ol>	DevOps engineer
Deploy templates to initialize the project.	To initialize the project, run the SAM <code>init</code> command. When prompted to choose a template source, choose	DevOps engineer



Task	Description	Skills required
	Custom Template Location.	

## Compile and build the SAM template code

Task	Description	Skills required
Review the AWS SAM application templates.	<p>Review the templates for the nested applications. This example uses the following nested application templates:</p> <ul style="list-style-type: none"> <li>• <code>auth.yaml</code> – This template sets up authentication-related resources, such as Amazon Cognito and AWS Systems Manager Parameter Store.</li> <li>• <code>product-mock.yaml</code> – This template deploys product-related resources, such as Lambda functions and Amazon API Gateway.</li> <li>• <code>shoppingcart-service.yaml</code> – This template sets up shopping cart-related resources, such as AWS Identity and Access Management (IAM), DynamoDB tables, and Lambda functions.</li> </ul>	DevOps engineer
Review the parent template.	Review the template that will invoke the nested application	DevOps engineer

Task	Description	Skills required
	<p>templates. In this example, the parent template is <code>template.yml</code> . All separate applications are nested in the single parent template <code>template.yml</code> .</p>	
Compile and build the AWS SAM template code.	<p>Using the AWS SAM CLI, run the following command.</p> <pre>sam build</pre>	DevOps engineer

## Deploy the AWS SAM template

Task	Description	Skills required
Deploy the applications.	<p>To launch the SAM template code that creates the nested application CloudFormation stacks and deploys code in the AWS environment, run the following command.</p> <pre>sam deploy --guided -- stack-name shopping- cart-nested-stack -- capabilities CAPABILIT Y_IAM CAPABILIT Y_AUTO_EXPAND</pre> <p>The command will prompt with a few questions. Answer all questions with y.</p>	DevOps engineer

## Verify the deployment

Task	Description	Skills required
Verify the stacks.	<p>To review the AWS CloudFormation stacks and AWS resources that were defined in the AWS SAM templates, do the following:</p> <ol style="list-style-type: none"><li>1. Log in to the AWS Management Console, and navigate to the <b>CloudFormation</b> console.</li><li>2. Verify that the parent and child stacks are listed.</li></ol> <p>In this example, <code>sam-shopping-cart</code> is the parent stack that calls the nested <code>Auth</code>, <code>Product</code> and <code>Shopping</code> stacks.</p> <p>The product stack gives the Product API Gateway URL link as an output.</p>	DevOps engineer

## Related resources

### References

- [AWS Serverless Application Model \(AWS SAM\)](#)
- [AWS SAM on GitHub](#)
- [Serverless Shopping Cart Microservice](#) (AWS example application)

### Tutorials and videos

- [Build a Serverless App](#)
- [AWS Online Tech Talks: Serverless Application Building and Deployments with AWS SAM](#)

## Additional information

After all the code is in place, the example has the following directory structure:

- [sam\\_stacks](#) – This folder contains the shared .py layer. A layer is a file archive that contains libraries, a custom runtime, or other dependencies. With layers, you can use libraries in your function without needing to include them in a deployment package.
- *product-mock-service* – This folder contains all product-related Lambda functions and files.
- *shopping-cart-service* – This folder contains all shopping-related Lambda functions and files.

# Implement SaaS tenant isolation for Amazon S3 by using an AWS Lambda token vending machine

*Created by Tabby Ward (AWS), Sravan Periyathambi (AWS), and Thomas Davis (AWS)*

**Environment:** PoC or pilot

**Technologies:** Modernization

**AWS services:** AWS Identity and Access Management; AWS Lambda; Amazon S3; AWS STS

## Summary

Multitenant SaaS applications must implement systems to ensure that tenant isolation is maintained. When you store tenant data on the same Amazon Web Services (AWS) resource—such as multiple tenants storing data in the same Amazon Simple Storage Service (Amazon S3) bucket—you must ensure that cross-tenant access cannot occur. Token vending machines (TVMs) are one way to provide tenant data isolation. These machines provide a mechanism for obtaining tokens while abstracting the complexity of how these tokens are generated. Developers can use a TVM without having detailed knowledge of how it produces tokens.

This pattern implements a TVM by using AWS Lambda. The TVM generates a token that consists of temporary security token service (STS) credentials that limit access to a single SaaS tenant's data in an S3 bucket.

TVMs, and the code that's provided with this pattern, are typically used with claims that are derived from JSON Web Tokens (JWTs) to associate requests for AWS resources with a tenant-scoped AWS Identity and Access Management (IAM) policy. You can use the code in this pattern as a basis to implement a SaaS application that generates scoped, temporary STS credentials based on the claims provided in a JWT token.

## Prerequisites and limitations

### Prerequisites

- An active AWS account.

- AWS Command Line Interface (AWS CLI) [version 1.19.0 or later](#), installed and configured on macOS, Linux, or Windows. Alternatively, you can use AWS CLI [version 2.1 or later](#).

## Limitations

- This code runs in Java and doesn't currently support other programming languages.
- The sample application does not include AWS cross-Region or disaster recovery (DR) support.
- This pattern demonstrates how a Lambda TVM for a SaaS application can provide scoped tenant access. It is not intended to be used in production environments.

## Architecture

### Target technology stack

- AWS Lambda
- Amazon S3
- IAM
- AWS Security Token Service (AWS STS)

### Target architecture

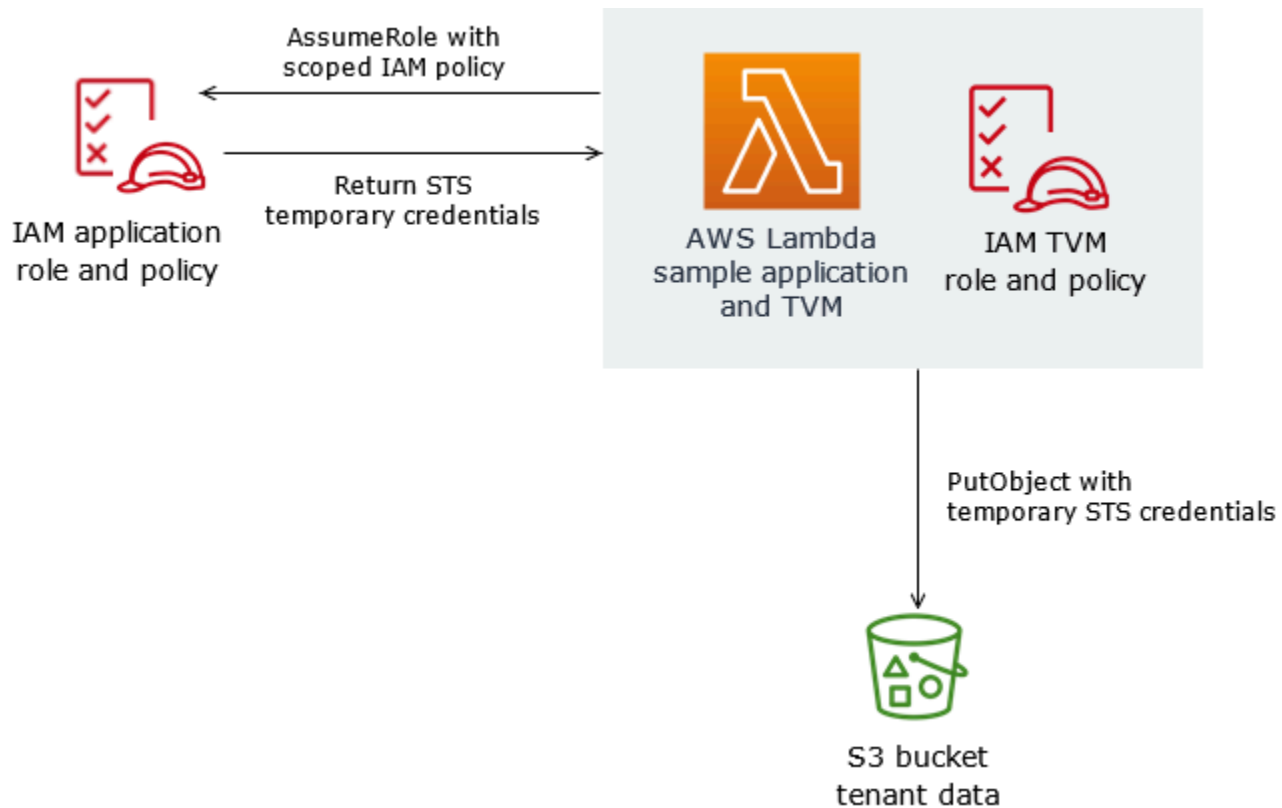

## Tools

### AWS services

- [AWS Command Line Interface \(AWS CLI\)](#) is an open-source tool that helps you interact with AWS services through commands in your command-line shell.
- [AWS Identity and Access Management \(IAM\)](#) helps you securely manage access to your AWS resources by controlling who is authenticated and authorized to use them.
- [AWS Lambda](#) is a compute service that helps you run code without needing to provision or manage servers. It runs your code only when needed and scales automatically, so you pay only for the compute time that you use.
- [AWS Security Token Service \(AWS STS\)](#) helps you request temporary, limited-privilege credentials for users.
- [Amazon Simple Storage Service \(Amazon S3\)](#) is a cloud-based object storage service that helps you store, protect, and retrieve any amount of data.

### Code

The source code for this pattern is available as an attachment and includes the following files:

- `s3UploadSample.jar` provides the source code for a Lambda function that uploads a JSON document to an S3 bucket.
- `tvm-layer.zip` provides a reusable Java library that supplies a token (STS temporary credentials) for the Lambda function to access the S3 bucket and upload the JSON document.
- `token-vending-machine-sample-app.zip` provides the source code used to create these artifacts and compilation instructions.

To use these files, follow the instructions in the next section.

## Epics

### Determine variable values

Task	Description	Skills required
Determine variable values.	<p>The implementation of this pattern includes several variable names that must be used consistently. Determine the values that should be used for each variable, and provide that value when requested in subsequent steps.</p> <p><b>&lt;AWS Account ID&gt;</b> – The 12-digit account ID that is associated with the AWS account you are implementing this pattern in. For information about how to find your AWS account ID, see <a href="#">Your AWS account ID and its alias</a> in the IAM documentation.</p>	Cloud administrator



Task	Description	Skills required
	<p><b>&lt;AWS Region&gt;</b> – The AWS Region that you are implementing this pattern in. For more information on AWS Regions, see <a href="#">Regions and Availability Zones</a> on the AWS website.</p> <p><b>&lt;sample-tenant-name&gt;</b> – The name of a tenant to use in the application. We recommend that you use only alphanumeric characters in this value for simplicity, but you can use any <a href="#">valid name for an S3 object key</a>.</p> <p><b>&lt;sample-tvm-role-name&gt;</b> – The name of the IAM role attached to the Lambda function that runs the TVM and sample application. The role name is a string that consists of uppercase and lowercase alphanumeric characters with no spaces. You can also include any of the following characters: underscore (_), plus sign (+), equal sign (=), comma (,), period (.), at sign (@), and hyphen (-). The role name must be unique within the account.</p>	

Task	Description	Skills required
	<p><b>&lt;sample-app-role-name&gt;</b> – The name of the IAM role that is assumed by the Lambda function when it generates scoped, temporary STS credentials. The role name is a string that consists of uppercase and lowercase alphanumeric characters with no spaces. You can also include any of the following characters: underscore (_), plus sign (+), equal sign (=), comma (,), period (.), at sign (@), and hyphen (-). The role name must be unique within the account.</p> <p><b>&lt;sample-app-function-name&gt;</b> – The name of the Lambda function. This is a string that's up to 64 characters in length.</p> <p><b>&lt;sample-app-bucket-name&gt;</b> – The name of an S3 bucket that must be accessed with permissions that are scoped to a specific tenant. S3 bucket names:</p> <ul style="list-style-type: none"><li>• Must be between 3 and 63 characters long.</li><li>• Must consist of only lowercase letters, numbers, periods (.), and hyphens (-).</li></ul>	

Task	Description	Skills required
	<ul style="list-style-type: none"> <li>• Must begin and end with a letter or number.</li> <li>• Must not be formatted as an IP address (for example, 192.168.5.4).</li> <li>• Must be unique within a partition. A partition is a grouping of Regions. AWS currently has three partitions: <code>aws</code> (Standard Regions), <code>aws-cn</code> (China Regions), and <code>aws-us-gov</code> (AWS GovCloud [US] Regions).</li> </ul>	

## Create an S3 bucket

Task	Description	Skills required
<p>Create an S3 bucket for the sample application.</p>	<p>Use the following AWS CLI command to create an S3 bucket. Provide the <b>&lt;sample-app-bucket-name&gt;</b> value in the code snippet:</p> <pre data-bbox="594 1444 1029 1604">aws s3api create-bucket   --bucket &lt;sample-app-bucket-name&gt;</pre> <p>The Lambda sample application uploads JSON files to this bucket.</p>	<p>Cloud administrator</p>

## Create the IAM TVM role and policy

Task	Description	Skills required
Create a TVM role.	<p>Use one of the following AWS CLI commands to create an IAM role. Provide the <b>&lt;sample-tvm-role-name&gt;</b> value in the command.</p> <p>For macOS or Linux shells:</p> <pre>aws iam create-role \ --role-name &lt;sample-tvm-role-name&gt; \ --assume-role-policy-document '{   "Version":     "2012-10-17",   "Statement": [     {       "Effect":         "Allow",       "Principal": {         "Service": "lambda.amazonaws.com"       },       "Action":         "sts:AssumeRole"     }   ]}'</pre> <p>For the Windows command line:</p> <pre>aws iam create-role ^ --role-name &lt;sample-tvm-role-name&gt; ^</pre>	Cloud administrator

Task	Description	Skills required
	<pre data-bbox="609 210 1015 661">--assume-role-policy-document "{\"Version\": \"2012-10-17\", \"Statement\": [{\"Effect\": \"Allow\", \"Principal\": {\"Service\": \"lambda.amazonaws.com\"}, \"Action\": \"sts:AssumeRole\"}]}"</pre> <p data-bbox="592 703 1031 1071">The Lambda sample application assumes this role when the application is invoked. The capability to assume the application role with a scoped policy gives the code broader permissions to access the S3 bucket.</p>	

Task	Description	Skills required
Create an inline TVM role policy.	<p>Use one of the following AWS CLI commands to create an IAM policy. Provide the <b>&lt;sample-tvm-role-name&gt;</b>, <b>&lt;AWS Account ID&gt;</b>, and <b>&lt;sample-app-role-name&gt;</b> values in the command.</p> <p>For macOS or Linux shells:</p> <pre>aws iam put-role-policy \   --role-name &lt;sample-tvm-role-name&gt; \   --policy-name assume-app-role \   --policy-document '{     "Version":       "2012-10-17",     "Statement": [       {         "Effect":           "Allow",         "Action":           "sts:AssumeRole",         "Resource":           "arn:aws:iam::&lt;AWS Account ID&gt;:role/           &lt;sample-app-role-name&gt;"       }     ]   }'</pre> <p>For the Windows command line:</p> <pre>aws iam put-role-policy ^</pre>	Cloud administrator

Task	Description	Skills required
	<pre data-bbox="597 205 1026 861">--role-name &lt;sample-t vm-role-name&gt; ^ --policy-name assume-ap p-role ^ --policy-documen t "{\"Version\": \"2012-10-17\", \"Statement\": [{\\"Effect\": \\"Allow \", \\"Action\": \"sts:AssumeRole \", \\"Resource\": \"arn:aws:iam::&lt;AW S Account ID&gt;:role/ &lt;sample-app-role-n ame&gt;\"]}]}"</pre> <p data-bbox="597 898 1026 1192">This policy is attached to the TVM role. It gives the code the capability to assume the application role, which has broader permissions to access the S3 bucket.</p>	

Task	Description	Skills required
Attach the managed Lambda policy.	<p>Use the following AWS CLI command to attach the <code>AWSLambdaBasicExecutionRole</code> IAM policy. Provide the <b>&lt;sample-tvm-role-name&gt;</b> value in the command:</p> <pre>aws iam attach-role-policy \   --role-name &lt;sample-tvm-role-name&gt; \   --policy-arn arn:aws:iam::aws:policy/service-role/AWSLambdaBasicExecutionRole</pre> <p>For the Windows command line:</p> <pre>aws iam attach-role-policy ^   --role-name &lt;sample-tvm-role-name&gt; ^   --policy-arn arn:aws:iam::aws:policy/service-role/AWSLambdaBasicExecutionRole</pre> <p>This managed policy is attached to the TVM role to permit Lambda to send logs to Amazon CloudWatch.</p>	Cloud administrator



## Create the IAM application role and policy

Task	Description	Skills required
Create the application role.	<p>Use one of the following AWS CLI commands to create an IAM role. Provide the <b>&lt;sample-app-role-name&gt;</b>, <b>&lt;AWS Account ID&gt;</b>, and <b>&lt;sample-tvm-role-name&gt;</b> values in the command.</p> <p>For macOS or Linux shells:</p> <pre>aws iam create-role \ --role-name &lt;sample-app-role-name&gt; \ --assume-role-policy-document '{   "Version":   "2012-10-17",   "Statement": [     {       "Effect":       "Allow",       "Principal": {         "AWS":         "arn:aws:iam::&lt;AWS Account ID&gt;:role/&lt;sample-tvm-role-name&gt;"       },       "Action":       "sts:AssumeRole"     }   ]}'</pre> <p>For the Windows command line:</p>	Cloud administrator

Task	Description	Skills required
	<pre>aws iam create-role ^ --role-name &lt;sample-a pp-role-name&gt; ^ --assume-role-policy- document "{\"Version \": \"2012-10-17\",  \"Statement\":   [{\"Effect\": \"Allow \", \"Principal\":   {\"AWS\": \"arn:aws :iam::&lt;AWS Account ID&gt;:role/&lt;sample-tvm- role-name&gt;\"}, \"Action \": \"sts:AssumeRole\" }]}"</pre> <p>The Lambda sample applicati on assumes this role with a scoped policy to get tenant- based access to an S3 bucket.</p>	

Task	Description	Skills required
Create an inline application role policy.	<p>Use one of the following AWS CLI commands to create an IAM policy. Provide the <b>&lt;sample-app-role-name&gt;</b> and <b>&lt;sample-app-bucket-name&gt;</b> values in the command.</p> <p>For macOS or Linux shells:</p> <pre>aws iam put-role-policy \   --role-name &lt;sample-app-role-name&gt; \   --policy-name s3-bucket-access \   --policy-document '{     "Version":       "2012-10-17",     "Statement": [       {         "Effect":           "Allow",         "Action": [           "s3:PutObject",           "s3:GetObject",           "s3:DeleteObject"         ],         "Resource":           "arn:aws:s3:::&lt;sample-app-bucket-name&gt;/*"       }     ],     "Effect":       "Allow",</pre>	Cloud administrator

Task	Description	Skills required
	<pre data-bbox="613 212 1010 506">       "Action":         ["s3:ListBucket"],         "Resource       ": "arn:aws:s3:::&lt;sam         ple-app-bucket-name&gt;"         }       ]}'     </pre> <p data-bbox="592 541 987 625">For the Windows command line:</p> <pre data-bbox="613 667 1010 1696"> aws iam put-role-policy ^ --role-name &lt;sample-a pp-role-name&gt; ^ --policy-name s3-bucket -access ^ --policy-documen t "{\"Version\":   \"2012-10-17\",   \"Statement\":     [{\"Effect\": \"Allow   \", \"Action\":     [\"s3:PutObject\",     \"s3:GetObject\",     \"s3&gt;DeleteObject\   \"], \"Resource\":     \"arn:aws:s3:::&lt;sa   mple-app-bucket-na   me&gt;/*\"}, {\"Effect\":     \"Allow\", \"Action\   \": [\"s3:ListBucket   \"], \"Resource\":     \"arn:aws:s3:::&lt;sa   mple-app-bucket-name   \"}]}"     </pre> <p data-bbox="592 1732 1019 1866">This policy is attached to the application role. It provides broad access to objects in the</p>	

Task	Description	Skills required
	S3 bucket. When the sample application assumes the role, these permissions are scoped to a specific tenant with the TVM's dynamically generated policy.	

## Create the Lambda sample application with TVM

Task	Description	Skills required
Download the compiled source files.	Download the <code>s3UploadSample.jar</code> and <code>tvm-layer.zip</code> files, which are included as attachments. The source code used to create these artifacts and compilation instructions are provided in <code>token-vending-machine-sample-app.zip</code> .	Cloud administrator
Create the Lambda layer.	Use the following AWS CLI command to create a Lambda layer, which makes the TVM accessible to Lambda.  <b>Note:</b> If you aren't running this command from the location where you downloaded <code>tvm-layer.zip</code> , provide the correct path to <code>tvm-layer.zip</code> in the <code>--zip-file</code> parameter.	Cloud administrator, App developer

Task	Description	Skills required
	<pre>aws lambda publish-l ayer-version \ --layer-name sample-to ken-vending-machine \ --compatible-runtimes java11 \ --zip-file fileb://t vm-layer.zip</pre> <p>For the Windows command line:</p> <pre>aws lambda publish-l ayer-version ^ --layer-name sample-to ken-vending-machine ^ --compatible-runtimes java11 ^ --zip-file fileb://t vm-layer.zip</pre> <p>This command creates a Lambda layer that contains the reusable TVM library.</p>	

Task	Description	Skills required
Create the Lambda function.	<p>Use the following AWS CLI command to create a Lambda function. Provide the <b>&lt;sample-app-function-name&gt;</b>, <b>&lt;AWS Account ID&gt;</b>, <b>&lt;AWS Region&gt;</b>, <b>&lt;sample-tvm-role-name&gt;</b>, <b>&lt;sample-app-bucket-name&gt;</b>, and <b>&lt;sample-app-role-name&gt;</b> values in the command.</p> <p><b>Note:</b> If you aren't running this command from the location where you downloaded <code>s3UploadSample.jar</code>, provide the correct path to <code>s3UploadSample.jar</code> in the <code>--zip-file</code> parameter.</p> <pre>aws lambda create-function \ --function-name   &lt;sample-app-function-name&gt; \ --timeout 30 \ --memory-size 256 \ --runtime java11 \ --role arn:aws:iam::&lt;AWS Account ID&gt;:role/&lt;sample-tvm-role-name&gt; \ --handler com.amazonaws.s3UploadSample.App \ --zip-file fileb://s3UploadSample.jar \</pre>	Cloud administrator, App developer

Task	Description	Skills required
	<pre>--layers arn:aws:lambda:&lt;AWS Region&gt;:&lt;AWS Account ID&gt;:layer:sample-token-vending-machine:1 \ --environment "Variables={S3_BUCKET=&lt;sample-app-bucket-name&gt;,ROLE=arn:aws:iam::&lt;AWS Account ID&gt;:role/&lt;sample-app-role-name&gt;}"</pre> <p>For Windows command line:</p> <pre>aws lambda create-function ^ --function-name &lt;sample-app-function-name&gt; ^ --timeout 30 ^ --memory-size 256 ^ --runtime java11 ^ --role arn:aws:iam::&lt;AWS Account ID&gt;:role/&lt;sample-tvm-role-name&gt; ^ --handler com.amazon.aws.s3UploadSample.App ^ --zip-file fileb://s3UploadSample.jar ^ --layers arn:aws:lambda:&lt;AWS Region&gt;:&lt;AWS Account ID&gt;:layer:sample-token-vending-machine:1 ^ --environment "Variables={S3_BUCKET=&lt;sample-app-bucket-name&gt;,ROLE=arn:aws:iam</pre>	



Task	Description	Skills required
	<pre data-bbox="613 212 1010 344">::&lt;AWS Account ID&gt;:role/&lt;sample-app-role-name&gt;}"</pre> <p data-bbox="591 386 1019 894">This command creates a Lambda function with the sample application code and the TVM layer attached. It also sets two environment variables: <code>S3_BUCKET</code> and <code>ROLE</code>. The sample application uses these variables to determine the role to assume and the S3 bucket to upload JSON documents to.</p>	

## Test the sample application and TVM

Task	Description	Skills required
Invoke the Lambda sample application.	<p data-bbox="591 1184 1026 1549">Use one of the following AWS CLI commands to start the Lambda sample application with its expected payload. Provide the <b>&lt;sample-app-function-name&gt;</b> and <b>&lt;sample-tenant-name&gt;</b> values in the command.</p> <p data-bbox="591 1598 997 1629">For macOS and Linux shells:</p> <pre data-bbox="613 1692 1010 1879">aws lambda invoke \   --function &lt;sample-app-function-name&gt; \   --invocation-type RequestResponse \</pre>	Cloud administrator, App developer

Task	Description	Skills required
	<pre data-bbox="609 210 1015 462">--payload '{"tenant": "&lt;sample-tenant-name&gt;"}' \ --cli-binary-format raw-in-base64-out response.json</pre> <p data-bbox="592 504 990 577">For the Windows command line:</p> <pre data-bbox="609 630 1015 1092">aws lambda invoke ^ --function &lt;sample-app-function-name&gt; ^ --invocation-type RequestResponse ^ --payload "{\"tenant\": \"&lt;sample-tenant-name&gt;\"}" ^ --cli-binary-format raw-in-base64-out response.json</pre> <p data-bbox="592 1134 1023 1554">This command calls the Lambda function and returns the result in a <code>response.json</code> document. On many Unix-based systems, you can change <code>response.json</code> to <code>/dev/stdout</code> to output the results directly to your shell without creating another file.</p> <p data-bbox="592 1596 1023 1816"><b>Note:</b> Changing the <code>&lt;sample-tenant-name&gt;</code> value in subsequent invocations of this Lambda function alters the location of the JSON</p>	

Task	Description	Skills required
	document and the permissions the token provides.	
View the S3 bucket to see created objects.	Browse to the S3 bucket ( <b>&lt;sample-app-bucket-name&gt;</b> ) that you created earlier. This bucket contains an S3 object prefix with the value of <b>&lt;sample-tenant-name&gt;</b> . Under that prefix, you will find a JSON document named with a UUID. Invoking the sample application multiple times adds more JSON documents.	Cloud administrator

Task	Description	Skills required
View Cloudwatch logs for the sample application.	<p>View the Cloudwatch logs associated with the Lambda function named <b>&lt;sample-app-function-name&gt;</b>. For instructions, see <a href="#">Accessing Amazon CloudWatch logs for AWS Lambda</a> in the AWS Lambda documentation. You can view the tenant-scoped policy generated by the TVM in these logs. This tenant-scoped policy gives permissions for the sample application to the Amazon S3 <b>PutObject</b>, <b>GetObject</b>, <b>DeleteObject</b>, and <b>ListBucket</b> APIs, but only for the object prefix associated with <b>&lt;sample-tenant-name&gt;</b>. In subsequent invocations of the sample application, if you change the <b>&lt;sample-tenant-name&gt;</b>, the TVM updates the scoped policy to correspond to the tenant provided in the invocation payload. This dynamically generated policy shows how tenant-scoped access can be maintained with a TVM in SaaS applications.</p> <p>The TVM functionality is provided in a Lambda layer so that it can be attached to other Lambda functions used</p>	Cloud administrator

Task	Description	Skills required
	<p>by an application without having to replicate the code.</p> <p>For an illustration of the dynamically generated policy, see the <a href="#">Additional information</a> section.</p>	

## Related resources

- [Isolating Tenants with Dynamically Generated IAM Policies](#) (blog post)
- [Applying Dynamically Generated Isolation Policies in SaaS Environment](#) (blog post)
- [AWS SaaS Boost](#) (an open-source reference environment that helps you move your SaaS offering to AWS)

## Additional information

The following Amazon Cloudwatch log shows the dynamically generated policy produced by the TVM code in this pattern. In this screenshot, the **<sample-app-bucket-name>** is DOC-EXAMPLE-BUCKET and the **<sample-tenant-name>** is test-tenant-1. The STS credentials returned by this scoped policy are unable to perform any actions on objects in the S3 bucket except for objects that are associated with the object key prefix test-tenant-1.

```
▼ 2021-07-29T12:57:07.417-04:00 [2021-07-29 16:57:07.376] f5eb7024-ec14-4d2c-9c3c-d69607d61f24 INFO c.a.a.t.
[2021-07-29 16:57:07.376] f5eb7024-ec14-4d2c-9c3c-d69607d61f24 INFO c.a.a.t.TokenVendingMachine -
{
  "Version": "2012-10-17",
  "Statement": [
    {
      "Effect": "Allow",
      "Action": [
        "s3:ListBucket"
      ],
      "Resource": [
        "arn:aws:s3:::DOC-EXAMPLE-BUCKET"
      ],
      "Condition": {
        "StringLike": {
          "s3:prefix": [
            "test-tenant-1",
            "test-tenant-1/",
            "test-tenant-1/*"
          ]
        }
      }
    },
    {
      "Effect": "Allow",
      "Action": [
        "s3:GetObject",
        "s3:PutObject",
        "s3:DeleteObject"
      ],
      "Resource": [
        "arn:aws:s3:::DOC-EXAMPLE-BUCKET/test-tenant-1/*"
      ]
    }
  ]
}
```

## Attachments

To access additional content that is associated with this document, unzip the following file:  
[attachment.zip](#)

# Implement the serverless saga pattern by using AWS Step Functions

*Created by Tabby Ward (AWS), Rohan Mehta (AWS), and Rimpay Tewani (AWS)*

**Environment:** PoC or pilot

**Technologies:** Modernization; Serverless

**Workload:** Open-source

**AWS services:** Amazon API Gateway; Amazon DynamoDB; AWS Lambda; Amazon SNS; AWS Step Functions

## Summary

In a microservices architecture, the main goal is to build decoupled and independent components to promote agility, flexibility, and faster time to market for your applications. As a result of decoupling, each microservice component has its own data persistence layer. In a distributed architecture, business transactions can span multiple microservices. Because these microservices cannot use a single atomicity, consistency, isolation, durability (ACID) transaction, you might end up with partial transactions. In this case, some control logic is needed to undo the transactions that have already been processed. The distributed saga pattern is typically used for this purpose.

The saga pattern is a failure management pattern that helps establish consistency in distributed applications and coordinates transactions between multiple microservices to maintain data consistency. When you use the saga pattern, every service that performs a transaction publishes an event that triggers subsequent services to perform the next transaction in the chain. This continues until the last transaction in the chain is complete. If a business transaction fails, saga orchestrates a series of compensating transactions that undo the changes that were made by the preceding transactions.

This pattern demonstrates how to automate the setup and deployment of a sample application (which handles travel reservations) with serverless technologies such as AWS Step Functions, AWS Lambda, and Amazon DynamoDB. The sample application also uses Amazon API Gateway and

Amazon Simple Notification Service (Amazon SNS) to implement a saga execution coordinator. The pattern can be deployed with an infrastructure as code (IaC) framework such as the AWS Cloud Development Kit (AWS CDK), the AWS Serverless Application Model (AWS SAM), or Terraform.

For more information about the saga pattern and other data persistence patterns, see the guide [Enabling data persistence in microservices](#) on the AWS Prescriptive Guidance website.

## Prerequisites and limitations

### Prerequisites

- An active AWS account.
- Permissions to create an AWS CloudFormation stack. For more information, see [Controlling access](#) in the CloudFormation documentation.
- IaC framework of your choice (AWS CDK, AWS SAM, or Terraform) configured with your AWS account so that you can use the framework CLI to deploy the application.
- NodeJS, used to build the application and run it locally.
- A code editor of your choice (such as Visual Studio Code, Sublime, or Atom).

### Product versions

- [NodeJS version 14](#)
- [AWS CDK version 2.37.1](#)
- [AWS SAM version 1.71.0](#)
- [Terraform version 1.3.7](#)

### Limitations

Event sourcing is a natural way to implement the saga orchestration pattern in a microservices architecture where all components are loosely coupled and don't have direct knowledge of one another. If your transaction involves a small number of steps (three to five), the saga pattern might be a great fit. However complexity increases with the number of microservices and the number of steps.

Testing and debugging can become difficult when you're using this design, because you have to have all services running in order to simulate the transaction pattern.



# Architecture

## Target architecture

The proposed architecture uses AWS Step Functions to build a saga pattern to book flights, book car rentals, and process payments for a vacation.

The following workflow diagram illustrates the typical flow of the travel reservation system. The workflow consists of reserving air travel ("ReserveFlight"), reserving a car ("ReserveCarRental"), processing payments ("ProcessPayment"), confirming flight reservations ("ConfirmFlight"), and confirming car rentals ("ConfirmCarRental") followed by a success notification when these steps are complete. However, if the system encounters any errors in running any of these transactions, it starts to fail backward. For example, an error with payment processing ("ProcessPayment") triggers a refund ("RefundPayment"), which then triggers a cancellation of the rental car and flight ("CancelRentalReservation" and "CancelFlightReservation"), which ends the entire transaction with a failure message.

This pattern deploys separate Lambda functions for each task that is highlighted in the diagram as well as three DynamoDB tables for flights, car rentals, and payments. Each Lambda function creates, updates, or deletes the rows in the respective DynamoDB tables, depending on whether a transaction is confirmed or rolled back. The pattern uses Amazon SNS to send text (SMS) messages to subscribers, notifying them of failed or successful transactions.

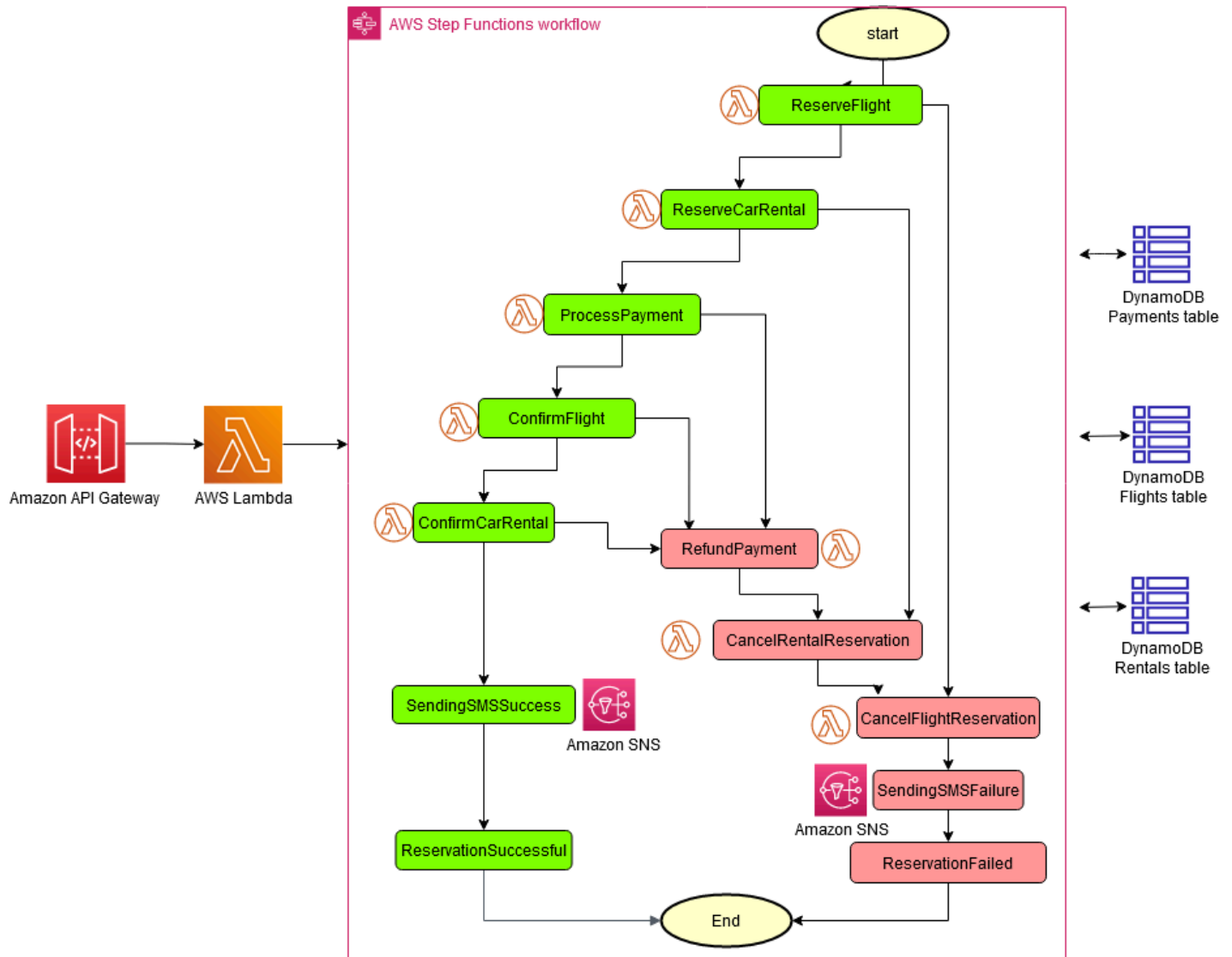

## Automation and scale

You can create the configuration for this architecture by using one of the IaC frameworks. Use one of the following links for your preferred IaC.

- [Deploy with AWS CDK](#)
- [Deploy with AWS SAM](#)
- [Deploy with Terraform](#)

## Tools

### AWS services

- [AWS Step Functions](#) is a serverless orchestration service that lets you combine AWS Lambda functions and other AWS services to build business-critical applications. Through the Step Functions graphical console, you see your application's workflow as a series of event-driven steps.
- [Amazon DynamoDB](#) is a fully managed NoSQL database service that provides fast and predictable performance with seamless scalability. You can use DynamoDB to create a database table that can store and retrieve any amount of data, and serve any level of request traffic.
- [AWS Lambda](#) is a compute service that lets you run code without provisioning or managing servers. Lambda runs your code only when needed and scales automatically, from a few requests per day to thousands per second.
- [Amazon API Gateway](#) is an AWS service for creating, publishing, maintaining, monitoring, and securing REST, HTTP, and WebSocket APIs at any scale.
- [Amazon Simple Notification Service \(Amazon SNS\)](#) is a managed service that provides message delivery from publishers to subscribers.
- [AWS Cloud Development Kit \(AWS CDK\)](#) is a software development framework for defining your cloud application resources by using familiar programming languages such as TypeScript, JavaScript, Python, Java, and C#/.Net.
- [AWS Serverless Application Model \(AWS SAM\)](#) is an open-source framework for building serverless applications. It provides shorthand syntax to express functions, APIs, databases, and event source mappings.

## Code

The code for a sample application that demonstrates the saga pattern, including the IaC template (AWS CDK, AWS SAM, or Terraform), the Lambda functions, and the DynamoDB tables can be found in the following links. Follow the instructions in the first epic to install these.

- [Deploy with AWS CDK](#)
- [Deploy with AWS SAM](#)
- [Deploy with Terraform](#)

# Epics

## Install packages, compile, and build

Task	Description	Skills required
Install the NPM packages.	<p>Create a new directory, navigate to that directory in a terminal, and clone the GitHub repository of your choice from the <i>Code</i> section earlier in this pattern.</p> <p>In the root folder that has the package.json file, run the following command to download and install all Node Package Manager (NPM) packages:</p> <pre>npm install</pre>	Developer, Cloud architect
Compile scripts.	<p>In the root folder, run the following command to instruct the TypeScript transpiler to create all necessary JavaScript files:</p> <pre>npm run build</pre>	Developer, Cloud architect
Watch for changes and recompile.	<p>In the root folder, run the following command in a separate terminal window to watch for code changes, and compile the code when it detects a change:</p>	Developer, Cloud architect

Task	Description	Skills required
	<pre>npm run watch</pre>	
Run unit tests (AWS CDK only).	<p>If you're using the AWS CDK, in the root folder, run the following command to perform the Jest unit tests:</p> <pre>npm run test</pre>	Developer, Cloud architect

## Deploy resources to the target AWS account

Task	Description	Skills required
Deploy the demo stack to AWS.	<p><b>Important:</b> The application is AWS Region-agnostic. If you use a profile, you must declare the Region explicitly in either the <a href="#">AWS Command Line Interface (AWS CLI) profile</a> or through <a href="#">AWS CLI environment variables</a>.</p> <p>In the root folder, run the following command to create a deployment assembly and to deploy it to the default AWS account and Region.</p> <p>AWS CDK:</p> <pre>cdk bootstrap cdk deploy</pre> <p>AWS SAM:</p>	Developer, Cloud architect

Task	Description	Skills required
	<pre>sam build sam deploy --guided</pre> <p><b>Terraform:</b></p> <pre>terraform init terraform apply</pre> <p>This step might take several minutes to complete. This command uses the default credentials that were configured for the AWS CLI.</p> <p>Note the API Gateway URL that is displayed on the console after deployment is complete. You will need this information to test the saga execution flow.</p>	

Task	Description	Skills required
Compare the deployed stack with the current state.	<p>In the root folder, run the following command to compare the deployed stack with the current state after making changes to the source code:</p> <p>AWS CDK:</p> <pre>cdk diff</pre> <p>AWS SAM:</p> <pre>sam deploy</pre> <p>Terraform:</p> <pre>terraform plan</pre>	Developer, Cloud architect

## Test the execution flow

Task	Description	Skills required
Test the saga execution flow.	<p>Navigate to the API Gateway URL that you noted in the earlier step, when you deployed the stack. This URL triggers the state machine to start. For more information about how to manipulate the flow of the state machine by passing different URL parameters, see the <a href="#">Additional information</a> section.</p>	Developer, Cloud architect

Task	Description	Skills required
	<p>To view the results, sign in to the AWS Management Console and navigate to the Step Functions console. Here, you can see every step of the saga state machine. You can also view the DynamoDB table to see the records inserted, updated, or deleted. If you refresh the screen frequently, you can watch the transaction status change from pending to confirmed.</p> <p>You can subscribe to the SNS topic by updating the code in the <code>stateMachine.ts</code> file with your cell phone number to receive SMS messages upon successful or failed reservations. For more information, see <i>Amazon SNS</i> in the <a href="#">Additional information</a> section.</p>	

## Clean up

Task	Description	Skills required
Clean up resources.	To clean up the resources deployed for this application, you can use one of the following commands.	App developer, Cloud architect



Task	Description	Skills required
	<p>AWS CDK:</p> <pre>cdk destroy</pre> <p>AWS SAM:</p> <pre>sam delete</pre> <p>Terraform:</p> <pre>terraform destroy</pre>	

## Related resources

### Technical papers

- [Implementing Microservices on AWS](#)
- [Serverless Application Lens](#)
- [Enabling Data Persistence in Microservices](#)

### AWS service documentation

- [Getting started with the AWS CDK](#)
- [Getting started with AWS SAM](#)
- [AWS Step Functions](#)
- [Amazon DynamoDB](#)
- [AWS Lambda](#)
- [Amazon API Gateway](#)
- [Amazon SNS](#)

### Tutorials

- [Hands-on Workshops for Serverless Computing](#)

## Additional information

### Code

For testing purposes, this pattern deploys API Gateway and a test Lambda function that triggers the Step Functions state machine. With Step Functions, you can control the functionality of the travel reservation system by passing a `run_type` parameter to mimic failures in “ReserveFlight,” “ReserveCarRental,” “ProcessPayment,” “ConfirmFlight,” and “ConfirmCarRental.”

The saga Lambda function (`sagaLambda.ts`) takes input from the query parameters in the API Gateway URL, creates the following JSON object, and passes it to Step Functions for execution:

```
let input = {
  "trip_id": tripID, // value taken from query parameter, default is AWS request ID
  "depart_city": "Detroit",
  "depart_time": "2021-07-07T06:00:00.000Z",
  "arrive_city": "Frankfurt",
  "arrive_time": "2021-07-09T08:00:00.000Z",
  "rental": "BMW",
  "rental_from": "2021-07-09T00:00:00.000Z",
  "rental_to": "2021-07-17T00:00:00.000Z",
  "run_type": runType // value taken from query parameter, default is "success"
};
```

You can experiment with different flows of the Step Functions state machine by passing the following URL parameters:

- **Successful Execution** – `https://{api gateway url}`
- **Reserve Flight Fail** – `https://{api gateway url}?runType=failFlightsReservation`
- **Confirm Flight Fail** – `https://{api gateway url}?runType=failFlightsConfirmation`
- **Reserve Car Rental Fail** – `https://{api gateway url}?runType=failCarRentalReservation`
- **Confirm Car Rental Fail** – `https://{api gateway url}?runType=failCarRentalConfirmation`
- **Process Payment Fail** – `https://{api gateway url}?runType=failPayment`
- **Pass a Trip ID** – `https://{api gateway url}?tripID={by default, trip ID will be the AWS request ID}`

### laC templates

The linked repositories include IaC templates that you can use to create the entire sample travel reservation application.

- [Deploy with AWS CDK](#)
- [Deploy with AWS SAM](#)
- [Deploy with Terraform](#)

## DynamoDB tables

Here are the data models for the flights, car rentals, and payments tables.

Flight Data Model:

```
var params = {
  TableName: process.env.TABLE_NAME,
  Item: {
    'pk' : {S: event.trip_id},
    'sk' : {S: flightReservationID},
    'trip_id' : {S: event.trip_id},
    'id': {S: flightReservationID},
    'depart_city' : {S: event.depart_city},
    'depart_time': {S: event.depart_time},
    'arrive_city': {S: event.arrive_city},
    'arrive_time': {S: event.arrive_time},
    'transaction_status': {S: 'pending'}
  }
};
```

Car Rental Data Model:

```
var params = {
  TableName: process.env.TABLE_NAME,
  Item: {
    'pk' : {S: event.trip_id},
    'sk' : {S: carRentalReservationID},
    'trip_id' : {S: event.trip_id},
    'id': {S: carRentalReservationID},
    'rental': {S: event.rental},
    'rental_from': {S: event.rental_from},
    'rental_to': {S: event.rental_to},
    'transaction_status': {S: 'pending'}
  }
};
```

Payment Data Model:

```
var params = {
  TableName: process.env.TABLE_NAME,
```

```
Item: {
  'pk' : {S: event.trip_id},
  'sk' : {S: paymentID},
  'trip_id' : {S: event.trip_id},
  'id': {S: paymentID},
  'amount': {S: "750.00"}, // hard coded for simplicity as implementing any
monetary transaction functionality is beyond the scope of this pattern
  'currency': {S: "USD"},
  'transaction_status': {S: "confirmed"}
}
};
```

## Lambda functions

The following functions will be created to support the state machine flow and execution in Step Functions:

- **Reserve Flights:** Inserts a record into the DynamoDB Flights table with a `transaction_status` of `pending`, to book a flight.
- **Confirm Flight:** Updates the record in the DynamoDB Flights table, to set `transaction_status` to `confirmed`, to confirm the flight.
- **Cancel Flights Reservation:** Deletes the record from the DynamoDB Flights table, to cancel the pending flight.
- **Reserve Car Rentals:** Inserts a record into the DynamoDB CarRentals table with a `transaction_status` of `pending`, to book a car rental.
- **Confirm Car Rentals:** Updates the record in the DynamoDB CarRentals table, to set `transaction_status` to `confirmed`, to confirm the car rental.
- **Cancel Car Rentals Reservation:** Deletes the record from the DynamoDB CarRentals table, to cancel the pending car rental.
- **Process Payment:** Inserts a record into the DynamoDB Payment table for the payment.
- **Cancel Payment:** Deletes the record from the DynamoDB Payments table for the payment.

## Amazon SNS

The sample application creates the following topic and subscription for sending SMS messages and notifying the customer about successful or failed reservations. If you want to receive text messages while testing the sample application, update the SMS subscription with your valid phone number in the state machine definition file.

AWS CDK snippet (add the phone number in the second line of the following code):

```
const topic = new sns.Topic(this, 'Topic');
topic.addSubscription(new subscriptions.SmsSubscription('+11111111111'));
const snsNotificationFailure = new tasks.SnsPublish(this, 'SendingSMSFailure', {
  topic:topic,
  integrationPattern: sfn.IntegrationPattern.REQUEST_RESPONSE,
  message: sfn.TaskInput.fromText('Your Travel Reservation Failed'),
});

const snsNotificationSuccess = new tasks.SnsPublish(this, 'SendingSMSSuccess', {
  topic:topic,
  integrationPattern: sfn.IntegrationPattern.REQUEST_RESPONSE,
  message: sfn.TaskInput.fromText('Your Travel Reservation is Successful'),
});
```

AWS SAM snippet (replace the +1111111111 strings with your valid phone number):

```
StateMachineTopic11111111111:
  Type: 'AWS::SNS::Subscription'
  Properties:
    Protocol: sms
    TopicArn:
      Ref: StateMachineTopic
    Endpoint: '+11111111111'
  Metadata:
    'aws:sam:path': SamServerlessSagaStack/StateMachine/Topic/+11111111111/Resource
```

Terraform snippet (replace the +1111111111 string with your valid phone number):

```
resource "aws_sns_topic_subscription" "sms-target" {
  topic_arn = aws_sns_topic.topic.arn
  protocol  = "sms"
  endpoint  = "+11111111111"
}
```

## Successful reservations

The following flow illustrates a successful reservation with “ReserveFlight,” “ReserveCarRental,” and “ProcessPayment” followed by “ConfirmFlight” and “ConfirmCarRental.” The customer is notified about the successful booking through SMS messages that are sent to the subscriber of the SNS topic.

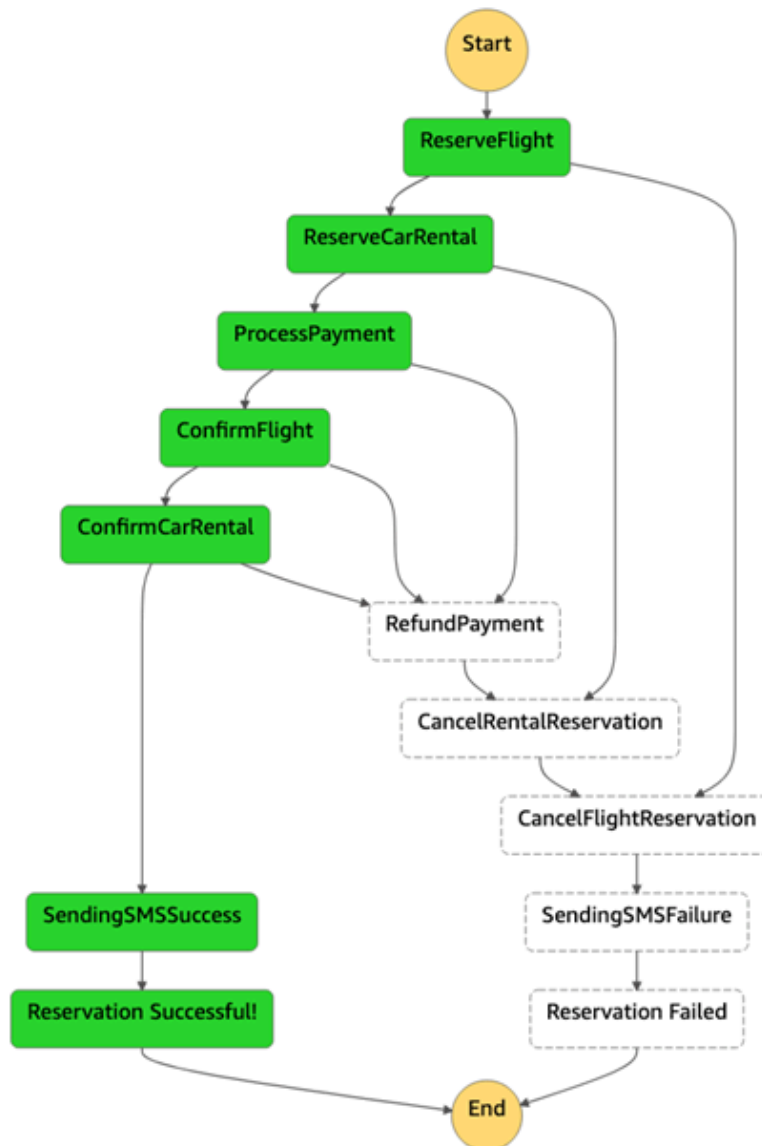

■ In Progress ■ Succeeded ■ Failed ■ Cancelled ■ Caught Error

## Failed reservations

This flow is an example of failure in the saga pattern. If, after booking flights and car rentals, “ProcessPayment” fails, steps are canceled in reverse order. The reservations are released, and the customer is notified of the failure through SMS messages that are sent to the subscriber of the SNS topic.

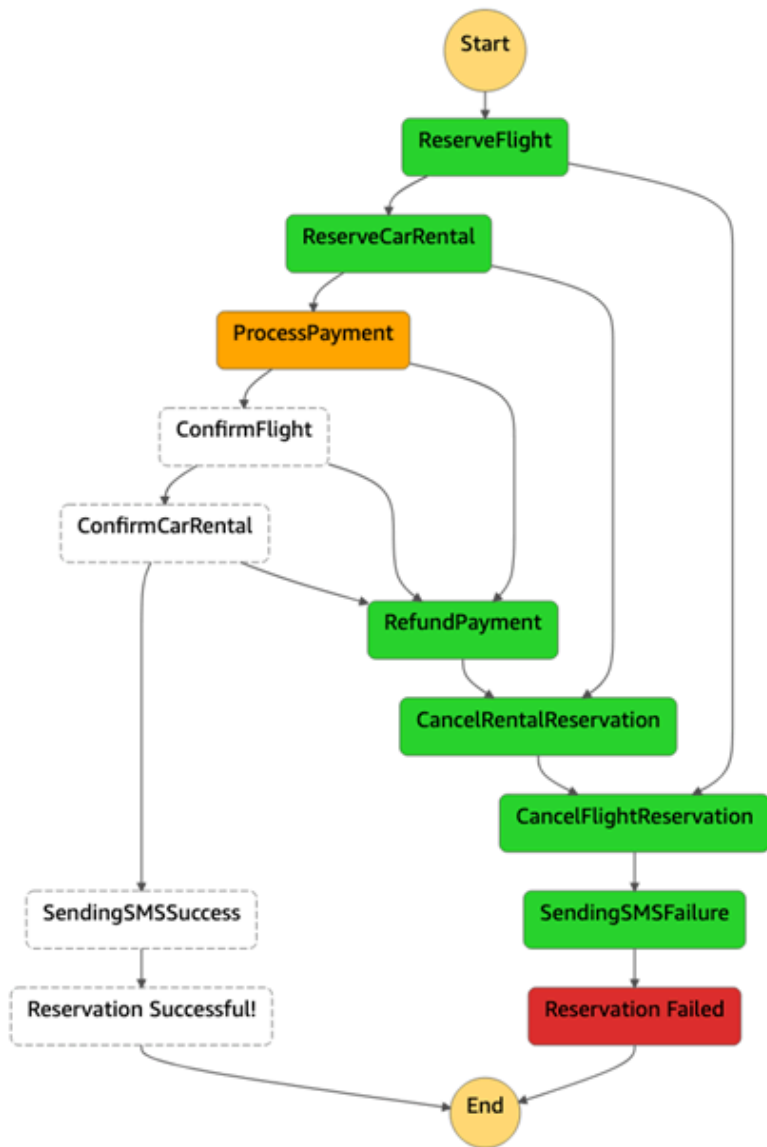

■ In Progress ■ Succeeded ■ Failed ■ Cancelled ■ Caught Error

# Manage on-premises container applications by setting up Amazon ECS Anywhere with the AWS CDK

Created by Dr. Rahul Sharad Gaikwad (AWS)

<b>Code repository:</b> <a href="#">amazon-ec2-s-anywhere-cdk-samples</a>	<b>Environment:</b> PoC or pilot	<b>Technologies:</b> Modernization; Containers & microservices; DevOps; Hybrid cloud; Infrastructure
<b>Workload:</b> All other workloads	<b>AWS services:</b> AWS CDK; Amazon ECS; AWS Identity and Access Management	

## Summary

[Amazon ECS Anywhere](#) is an extension of the Amazon Elastic Container Service (Amazon ECS). You can use ECS Anywhere to deploy native Amazon ECS tasks in an on-premises or customer-managed environment. This feature helps reduce costs and mitigate complex local container orchestration and operations. You can use ECS Anywhere to deploy and run container applications in both on-premises and cloud environments. It removes the need for your team to learn multiple domains and skill sets, or to manage complex software on their own.

This pattern demonstrates the steps to set up ECS Anywhere by using [AWS Cloud Development Kit \(AWS CDK\)](#) stacks.

## Prerequisites and limitations

### Prerequisites

- An active AWS account.
- AWS Command Line Interface (AWS CLI), installed and configured. (See [Installing, updating, and uninstalling the AWS CLI](#) in the AWS CLI documentation.)
- AWS CDK Toolkit, installed and configured. (See [AWS CDK Toolkit](#) in the AWS CDK documentation, and follow the instructions to install version 2 globally.)



- Node package manager (npm), installed and configured for the AWS CDK in TypeScript. (See [Downloading and installing Node.js and npm](#) in the npm documentation.)

## Limitations

- For limitations and considerations, see [External instances \(Amazon ECS Anywhere\)](#) in the Amazon ECS documentation.

## Product versions

- AWS CDK Toolkit version 2
- npm version 7.20.3 or later
- Node.js version 16.6.1 or later

## Architecture

### Target technology stack

- AWS CloudFormation
- AWS CDK
- Amazon ECS Anywhere
- AWS Identity and Access Management (IAM)

### Target architecture

The following diagram illustrates a high-level system architecture of ECS Anywhere setup using the AWS CDK with TypeScript, as implemented by this pattern.

1. When you deploy the AWS CDK stack, it creates a CloudFormation stack on AWS.
2. The CloudFormation stack provisions an Amazon ECS cluster and related AWS resources.
3. To register an external instance with an Amazon ECS cluster, you must install AWS Systems Manager Agent (SSM Agent) on your virtual machine (VM) and register the VM as an AWS Systems Manager managed instance.
4. You must also install the Amazon ECS container agent and Docker on your VM to register it as an external instance with the Amazon ECS cluster.

5. When the external instance is registered and configured with the Amazon ECS cluster, it can run multiple containers on your VM, which is registered as an external instance.

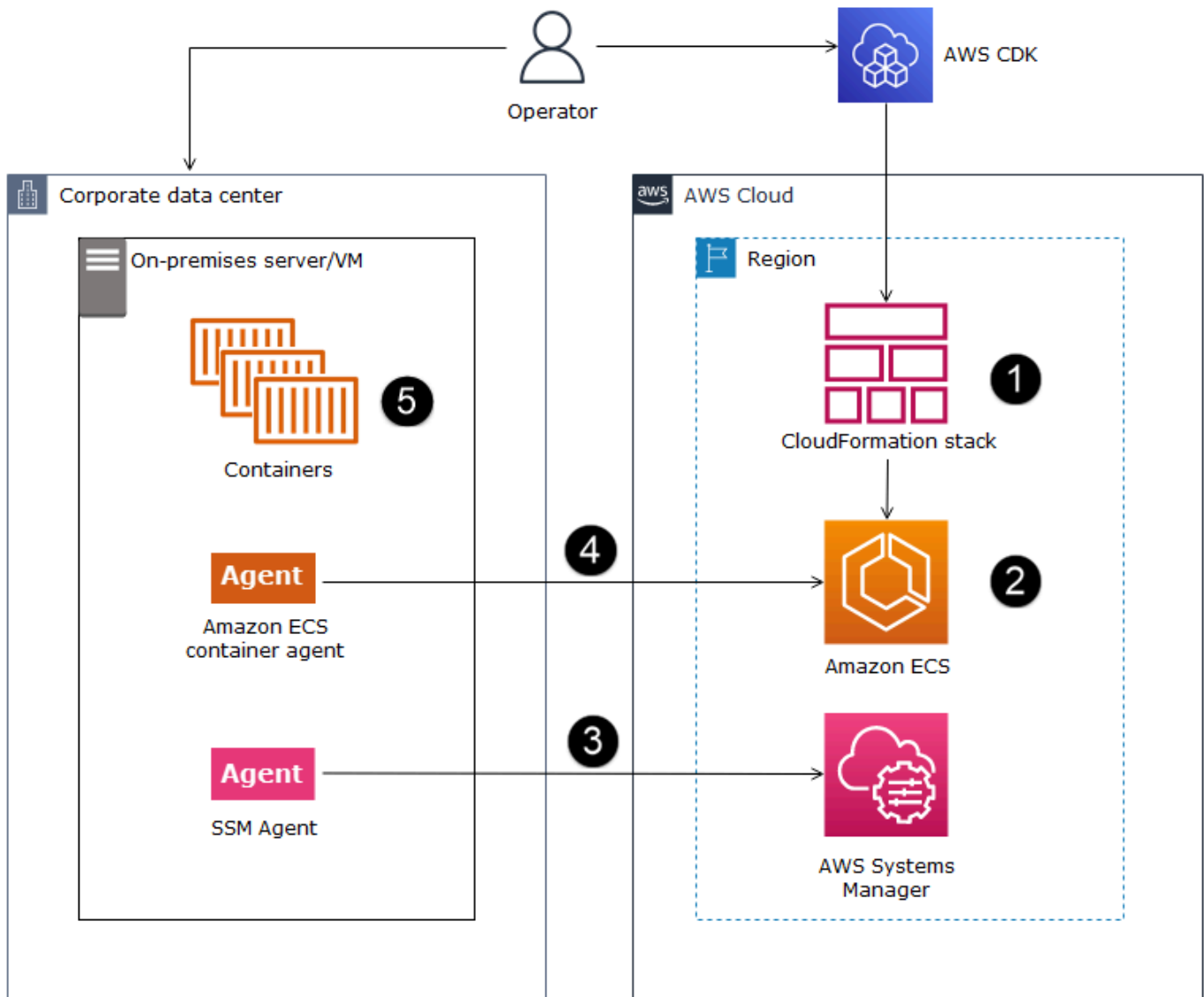

## Automation and scale

The [GitHub repository](#) that is provided with this pattern uses the AWS CDK as an infrastructure as code (IaC) tool to create the configuration for this architecture. AWS CDK helps you orchestrate resources and set up ECS Anywhere.

## Tools

- [AWS Cloud Development Kit \(AWS CDK\)](#) is a software development framework that helps you define and provision AWS Cloud infrastructure in code.
- [AWS Command Line Interface \(AWS CLI\)](#) is an open-source tool that helps you interact with AWS services through commands in your command-line shell.

## Code

The source code for this pattern is available on GitHub, in the [Amazon ECS Anywhere CDK Samples](#) repository. To clone and use the repository, follow the instructions in the next section.

## Epics

### Verify AWS CDK configuration

Task	Description	Skills required
Verify the AWS CDK version.	<p>Verify the version of the AWS CDK Toolkit by running the following command:</p> <pre>cdk --version</pre> <p>This pattern requires AWS CDK version 2. If you have an earlier version of the AWS CDK, follow the instructions in the <a href="#">AWS CDK documentation</a> to update it.</p>	DevOps engineer
Set up AWS credentials.	<p>To set up credentials, run the <code>aws configure</code> command and follow the prompts:</p> <pre>\$aws configure</pre>	DevOps engineer

Task	Description	Skills required
	<p>AWS Access Key ID [None]: &lt;your-access-key-ID&gt;</p> <p>AWS Secret Access Key [None]: &lt;your-secret-access-key&gt;</p> <p>Default region name [None]: &lt;your-Region-name&gt;</p> <p>Default output format [None]:</p>	

## Bootstrap the AWS CDK environment

Task	Description	Skills required
Clone the AWS CDK code repository.	<p>Clone the GitHub code repository for this pattern by using the command:</p> <pre>git clone https://github.com/aws-samples/amazon-ecs-anywhere-cdk-samples.git</pre>	DevOps engineer
Bootstrap the environment.	<p>To deploy the AWS CloudFormation template to the account and AWS Region that you want to use, run the following command:</p> <pre>cdk bootstrap &lt;account-number&gt;/&lt;Region&gt;</pre>	DevOps engineer

Task	Description	Skills required
	For more information, see <a href="#">Bootstrapping</a> in the AWS CDK documentation.	

## Build and deploy the project

Task	Description	Skills required
Install package dependencies and compile TypeScript files.	<p>Install the package dependencies and compile the TypeScript files by running the following commands:</p> <pre>\$cd amazon-ecs-anywhere-cdk-samples \$npm install \$npm fund</pre> <p>These commands install all the packages from the sample repository.</p> <p><b>Important:</b> If you get any errors about missing packages, use one of the following commands:</p> <pre>\$npm ci</pre> <p>—or—</p> <pre>\$npm install -g @aws-cdk/&lt;package_name&gt;</pre>	DevOps engineer

Task	Description	Skills required
	For more information, see <a href="#">npm ci</a> and <a href="#">npm install</a> in the npm documentation.	
Build the project.	To build the project code, run the command: <pre>npm run build</pre> For more information about building and deploying the project, see <a href="#">Your first AWS CDK app</a> in the AWS CDK documentation.	DevOps engineer
Deploy the project.	To deploy the project code, run the command: <pre>cdk deploy</pre>	DevOps engineer
Verify stack creation and output.	Open the AWS CloudFormation console at <a href="https://console.aws.amazon.com/cloudformation">https://console.aws.amazon.com/cloudformation</a> , and choose the EcsAnywhereStack stack. The <b>Outputs</b> tab shows the commands to run on your external VM.	DevOps engineer

## Set up an on-premises machine

Task	Description	Skills required
Set up your VM by using Vagrant.	For demonstration purposes, you can use <a href="#">HashiCorp</a>	DevOps engineer

Task	Description	Skills required
	<p><a href="#">Vagrant</a> to create a VM. Vagrant is an open-source utility for building and maintaining portable virtual software development environments. Create a Vagrant VM by running the <code>vagrant up</code> command from the root directory where Vagrantfile is placed. For more information, see the <a href="#">Vagrant documentation</a>.</p>	

Task	Description	Skills required
Register your VM as an external instance.	<ol style="list-style-type: none"><li data-bbox="591 226 1026 457">1. Log in to the Vagrant VM by using the <code>vagrant ssh</code> command. For more information, see the <a href="#">Vagrant documentation</a>.</li><li data-bbox="591 499 1026 961">2. Create an activation code and ID that you can use to register your VM with AWS Systems Manager and to activate your external instance. The output from this command includes <code>ActivationId</code> and <code>ActivationCode</code> values:<pre data-bbox="591 1003 1026 1234">aws ssm create-activation --iam-role EcsAnywhereInstanceRole   tee ssm-activation.json</pre></li><li data-bbox="591 1276 1026 1360">3. Export the activation ID and code values:<pre data-bbox="591 1402 1026 1633">export ACTIVATION_ID=&lt;activation-ID&gt; export ACTIVATION_CODE=&lt;activation-code&gt;</pre></li><li data-bbox="591 1675 1026 1793">4. Download the installation script to your on-premises server or VM:</li></ol>	DevOps engineer



Task	Description	Skills required
	<pre>curl -o "ecs-anywhere- install.sh" "https:// amazon-ecs-agent.s 3.amazonaws.com/ec s-anywhere-install -latest.sh" &amp;&amp; sudo   chmod +x ecs-anywhere- install.sh</pre> <p>5. Run the installation script on your on-premises server or VM:</p> <pre>sudo ./ecs-anywhere-ins tall.sh \   --cluster test-ecs- anywhere \   --activation-id \$ACTIVATION_ID \   --activation-code \$ACTIVATION_CODE \   --region &lt;Region&gt;</pre> <p>For more information about setting up and registering your VM, see <a href="#">Registering an external instance to a cluster</a> in the Amazon ECS documentation.</p>	

Task	Description	Skills required
Verify the status of ECS Anywhere and the external VM.	To verify whether your virtual box is connected to the Amazon ECS control plane and running, use the following commands: <pre>aws ssm describe-instance-information aws ecs list-container-instances --cluster \$CLUSTER_NAME</pre>	DevOps engineer

## Clean up

Task	Description	Skills required
Clean up and delete resources .	After you walk through this pattern, you should remove the resources you created to avoid incurring any further charges. To clean up, run the command: <pre>cdk destroy</pre>	DevOps engineer

## Related resources

- [Amazon ECS Anywhere Documentation](#)
- [Amazon ECS Anywhere Demo](#)
- [Amazon ECS Anywhere Workshop Samples](#)

# Modernize ASP.NET Web Forms applications on AWS

Created by Vijai Anand Ramalingam (AWS) and Sreelaxmi Pai (AWS)

**Environment:** PoC or pilot

**Technologies:** Modernization; Containers & microservices; DevelopmentAndTesting; Web & mobile apps

**Workload:** Microsoft

**AWS services:** Amazon CloudWatch; Amazon ECS; AWS Systems Manager

## Summary

This pattern describes the steps for modernizing a legacy, monolith ASP.NET Web Forms application by porting it to ASP.NET Core on AWS.

Porting ASP.NET Web Forms applications to ASP.NET Core helps you take advantage of the performance, cost savings, and robust ecosystem of Linux. However, it can be a significant manual effort. In this pattern, the legacy application is modernized incrementally by using a phased approach, and then containerized in the AWS Cloud.

Consider a legacy, monolith application for a shopping cart. Let's assume that it was created as an ASP.NET Web Forms application and consists of .aspx pages with a code-behind (aspx.cs) file. The modernization process consists of these steps:

1. Break the monolith into microservices by using the appropriate decomposition patterns. For more information, see the guide [Decomposing monoliths into microservices](#) on the AWS Prescriptive Guidance website.
2. Port your legacy ASP.NET Web Forms (.NET Framework) application to ASP.NET Core in .NET 5 or later. In this pattern, you use Porting Assistant for .NET to scan your ASP.NET Web Forms application and identify incompatibilities with ASP.NET Core. This reduces the manual porting effort.
3. Redevelop the Web Forms UI layer by using React. This pattern doesn't cover UI redevelopment. For instructions, see [Create a New React App](#) in the React documentation.

4. Redevelop the Web Forms code-behind file (business interface) as an ASP.NET Core web API. This pattern uses NDepend reports to help identify required files and dependencies.
5. Upgrade shared/common projects, such as Business Logic and Data Access, in your legacy application to .NET 5 or later by using Porting Assistant for .NET.
6. Add AWS services to complement your application. For example, you can use [Amazon CloudWatch Logs](#) to monitor, store, and access your application's logs, and [AWS Systems Manager](#) to store your application settings.
7. Containerize the modernized ASP.NET Core application. This pattern creates a Docker file that targets Linux in Visual Studio and uses Docker Desktop to test it locally. This step assumes that your legacy application is already running on an on-premises or Amazon Elastic Compute Cloud (Amazon EC2) Windows instance. For more information, see the pattern [Run an ASP.NET Core web API Docker container on an Amazon EC2 Linux instance](#).
8. Deploy the modernized ASP.NET core application to Amazon Elastic Container Service (Amazon ECS). This pattern doesn't cover the deployment step. For instructions, see the [Amazon ECS Workshop](#).

**Note:** This pattern doesn't cover UI development, database modernization, or container deployment steps.

## Prerequisites and limitations

### Prerequisites

- [Visual Studio](#) or [Visual Studio Code](#), downloaded and installed.
- Access to an AWS account using the AWS Management Console and the AWS Command Line Interface (AWS CLI) version 2. (See the [instructions for configuring the AWS CLI](#).)
- The AWS Toolkit for Visual Studio (see [setup instructions](#)).
- Docker Desktop, [downloaded](#) and installed.
- .NET SDK, [downloaded](#) and installed.
- NDepend tool, [downloaded](#) and installed. To install the NDepend extension for Visual Studio, run `NDepend.VisualStudioExtension.Installer` ([see instructions](#)). You can select Visual Studio 2019 or 2022, depending on your requirements.
- Porting Assistant for .NET, [downloaded](#) and installed.

# Architecture

## Modernizing the shopping cart application

The following diagram illustrates the modernization process for a legacy ASP.NET shopping cart application.

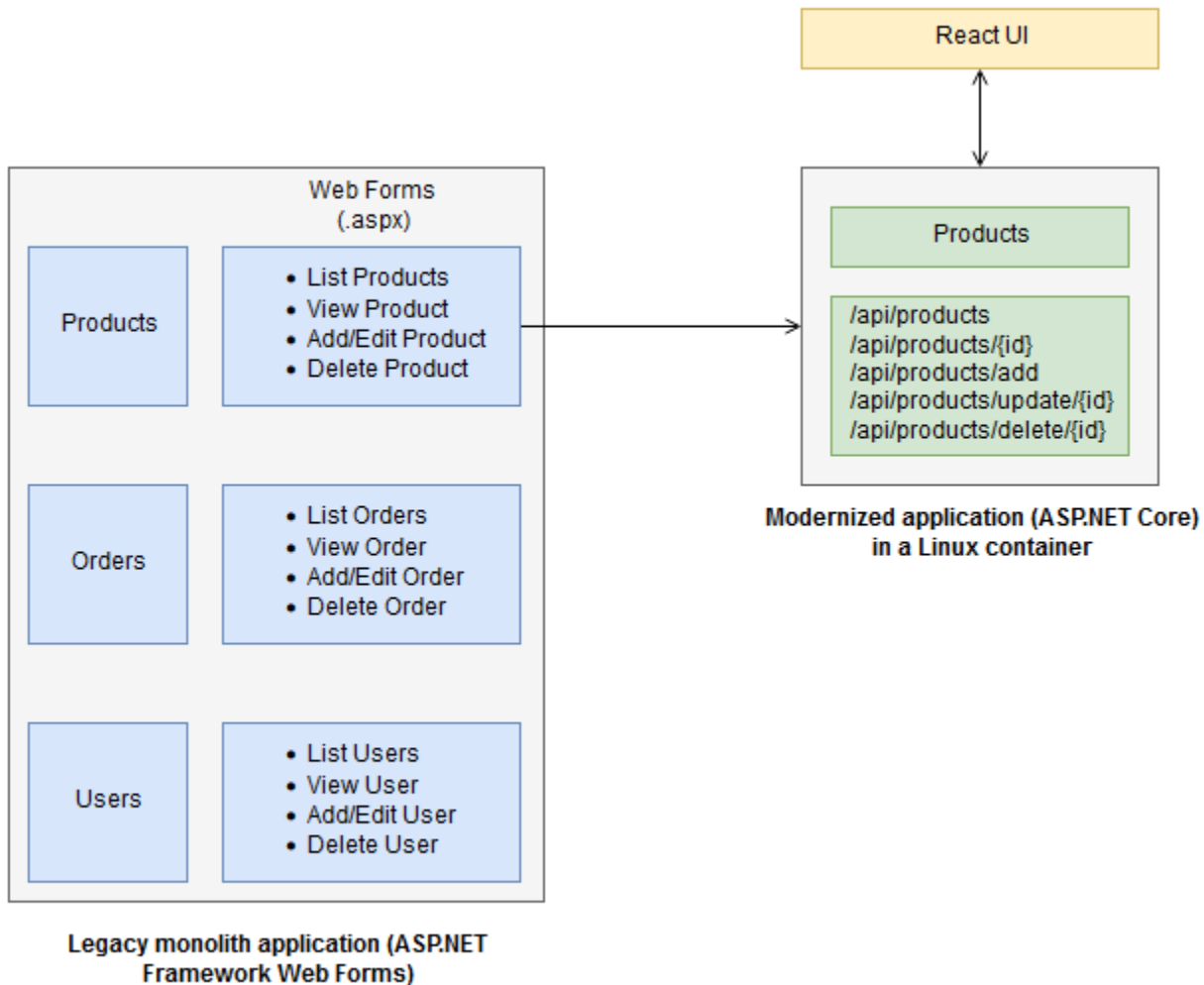

## Target architecture

The following diagram illustrates the architecture of the modernized shopping cart application on AWS. ASP.NET Core web APIs are deployed to an Amazon ECS cluster. Logging and configuration services are provided by Amazon CloudWatch Logs and AWS Systems Manager.

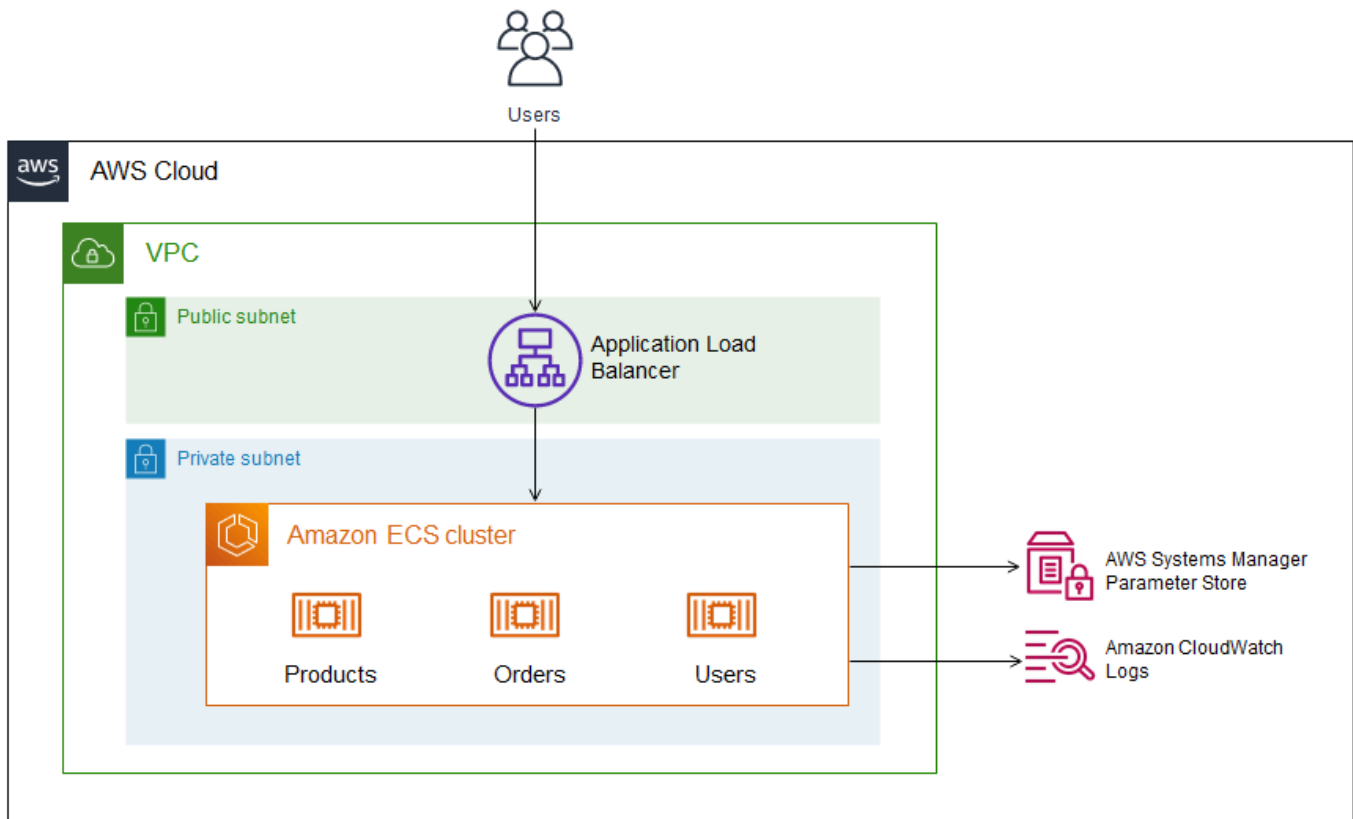

## Tools

### AWS services

- [Amazon ECS](#) – Amazon Elastic Container Service (Amazon ECS) is a highly scalable, fast container management service for running, stopping, and managing containers on a cluster. You can run your tasks and services on a serverless infrastructure that is managed by AWS Fargate. Alternatively, for more control over your infrastructure, you can run your tasks and services on a cluster of EC2 instances that you manage.
- [Amazon CloudWatch Logs](#) – Amazon CloudWatch Logs centralizes the logs from all your systems, applications, and AWS services that you use. You can view and monitor the logs, search them for specific error codes or patterns, filter them based on specific fields, or archive them securely for future analysis.
- [AWS Systems Manager](#) – AWS Systems Manager is an AWS service that you can use to view and control your infrastructure on AWS. Using the Systems Manager console, you can view operational data from multiple AWS services and automate operational tasks across your AWS

resources. Systems Manager helps you maintain security and compliance by scanning your managed instances and reporting (or taking corrective action) on any policy violations it detects.

## Tools

- [Visual Studio](#) or [Visual Studio Code](#) – Tools for building .NET applications, web APIs, and other programs.
- [AWS Toolkit for Visual Studio](#) – An extension for Visual Studio that helps develop, debug, and deploy .NET applications that use AWS services.
- [Docker Desktop](#) – A tool that simplifies building and deploying containerized applications.
- [NDepend](#) – An analyzer that monitors .NET code for dependencies, quality issues, and code changes.
- [Porting Assistant for .NET](#) – An analysis tool that scans .NET code to identify incompatibilities with .NET Core and to estimate the migration effort.

## Epics

### Port your legacy application to .NET 5 or later version

Task	Description	Skills required
Upgrade your .NET Framework legacy application to .NET 5.	You can use Porting Assistant for .NET to convert your legacy ASP.NET Web Forms application to .NET 5 or later. Follow the instructions in the <a href="#">Porting Assistant for .NET documentation</a> .	App developer
Generate NDepend reports.	When you modernize your ASP.NET Web Forms application by decomposing it into microservices, you might not need all the .cs files from the legacy application. You can use NDepend to generate	App developer

Task	Description	Skills required
	<p>a report for any code-behind (.cs) file, to get all the callers and callees. This report helps you identify and use only the required files in your microservices.</p> <p>After you install NDepend (see the <a href="#">Prerequisites</a> section), open the solution (.sln file) for your legacy application in Visual Studio and follow these steps:</p> <ol style="list-style-type: none"><li>1. Build the legacy application in Visual Studio.</li><li>2. On the Visual Studio menu bar, choose <b>NDepend, Attach new NDepend project to current VS solution.</b></li><li>3. Choose <b>Analyze .NET assemblies.</b></li><li>4. When analysis is complete, navigate to the project in Solution Explorer. Right-click any code-behind file (for example, <code>listproducts.aspx.cs</code>) that you want to generate the report for, and then choose <b>Show on Dependency Graph.</b></li><li>5. In the navigation bar, choose <b>Callers and callees,</b></li></ol>	



Task	Description	Skills required
	<p>and then choose <b>Edit code query</b>.</p> <p>6. In the <b>Queries and Rules Edit pane</b>, choose the download arrow, and then choose <b>Export to Excel</b>.</p> <p>This process generates a report for the code-behind file that lists all callers and callees. For more information about the dependency graph, see the <a href="#">NDepend documentation</a>.</p>	

Task	Description	Skills required
Create a new .NET 5 solution.	<p>To create a new .NET 5 (or later) structure for your modernized ASP.NET Core web APIs:</p> <ol style="list-style-type: none"><li>1. Open Visual Studio.</li><li>2. Create a new, blank solution.</li><li>3. Create new projects that target .NET 5 (or later), based on your legacy application. For examples of legacy and new projects for a shopping cart application, see the <a href="#">Additional information</a> section.</li><li>4. Use the NDepend report from the previous step to identify all required files. Copy these files from the application you upgraded earlier and add them to the new solution.</li><li>5. Build the solution and fix all issues.</li></ol> <p>For more information about creating projects and solutions, see the <a href="#">Visual Studio documentation</a>.</p> <p><b>Note</b> As you build the solution and verify functiona</p>	App developer

Task	Description	Skills required
	<p>lity, you might identify several additional files to be added to the solution, in addition to the files that NDepend identified.</p>	

## Update your application code

Task	Description	Skills required
<p>Implement web APIs with ASP.NET Core.</p>	<p>Let's assume that one of the microservices that you identified in your legacy monolith shopping cart application is <i>Products</i>. You created a new ASP.NET Core web API project for <i>Products</i> in the previous epic. In this step, you identify and modernize all the web forms (.aspx pages) that are related to <i>Products</i>. Let's assume that <i>Products</i> consists of four web forms, as illustrated earlier in the <a href="#">Architecture</a> section:</p> <ul style="list-style-type: none"> <li>• List Products</li> <li>• View Product</li> <li>• Add/Edit Product</li> <li>• Delete Product</li> </ul> <p>You should analyze each web form, identify all the requests that are sent to the</p>	<p>App developer</p>

Task	Description	Skills required
	<p>database to perform some logic, and get responses. You can implement each request as a web API endpoint. Given its web forms, <i>Products</i> can have the following possible endpoints:</p> <ul style="list-style-type: none"><li>• /api/products</li><li>• /api/products/{id}</li><li>• /api/products/add</li><li>• /api/products/update/{id}</li><li>• /api/products/delete/{id}</li></ul> <p>As mentioned previously, you can also reuse all the other projects that you upgraded to .NET 5, including Business Logic, Data Access, and shared/common projects.</p>	

Task	Description	Skills required
Configure Amazon CloudWatch Logs.	<p>You can use <a href="#">Amazon CloudWatch Logs</a> to monitor, store, and access your application's logs. You can log data into Amazon CloudWatch Logs by using an AWS SDK. You can also integrate .NET applications with CloudWatch Logs by using popular .NET logging frameworks such as <a href="#">NLog</a>, <a href="#">Log4Net</a>, and <a href="#">ASP.NET Core logging framework</a>.</p> <p>For more information about this step, see the blog post <a href="#">Amazon CloudWatch Logs and .NET Logging Frameworks</a>.</p>	App developer

Task	Description	Skills required
Configure AWS Systems Manager Parameter Store.	<p>You can use <a href="#">AWS Systems Manager Parameter Store</a> to store application settings such as connection strings separately from your application's code. The NuGet package <a href="#">Amazon.Extensions.Configuration.SystemsManager</a> simplifies how your application loads these settings from the AWS Systems Manager Parameter Store into the .NET Core configuration system.</p> <p>For more information about this step, see the blog post <a href="#">.NET Core configuration provider for AWS Systems Manager</a>.</p>	App developer

## Add authentication and authorization

Task	Description	Skills required
Use a shared cookie for authentication.	Modernizing a legacy monolith application is an iterative process and requires the monolith and its modernized version to co-exist. You can use a shared cookie to achieve seamless authentication between the two versions.	App developer

Task	Description	Skills required
	<p>The legacy ASP.NET application continues to validate user credentials and issues the cookie while the modernized ASP.NET Core application validates the cookie.</p> <p>For instructions and sample code, see the <a href="#">sample GitHub project</a>.</p>	

### Build and run the container locally

Task	Description	Skills required
<p>Create a Docker image by using Visual Studio.</p>	<p>In this step, you create a Docker file by using the Visual Studio for .NET Core web API.</p> <ol style="list-style-type: none"> <li>1. Open Visual Studio.</li> <li>2. In Solution Explorer, from the context (right-click) menu of your project, choose <b>Add, Docker Support</b>.</li> <li>3. Select <b>Linux</b> as the target operating system.</li> </ol> <p>Visual Studio creates a Docker file for your project. For a sample Docker file, see <a href="#">Visual Studio Container Tools for Docker</a> on the Microsoft website.</p>	<p>App developer</p>

Task	Description	Skills required
Build and run the container by using Docker Desktop.	<p>Now you can build, create and run the container in Docker Desktop.</p> <ol style="list-style-type: none"><li>1. Open a Command Prompt window. Navigate to the solution folder where the Docker file is located. Run the following command to create the Docker image: <pre>docker build -t aspnetcorewebapiimage -f Dockerfile .</pre></li><li>2. Run the following command to view all Docker images: <pre>docker images</pre></li><li>3. Run the following command to create and run a container: <pre>docker run -d -p 8080:80 --name aspnetcorewebapicontainer aspnetcorewebapiimage</pre></li><li>4. Open Docker Desktop, and then choose <b>Containers/Apps</b>. You can see a new container named <code>aspnetcorewebapicontainer</code> running.</li></ol>	App developer



## Related resources

- [Run an ASP.NET Core web API Docker container on an Amazon EC2 Linux instance](#) (AWS Prescriptive Guidance)
- [Amazon ECS Workshop](#)
- [Perform ECS blue/green deployments through CodeDeploy using AWS CloudFormation](#) (AWS CloudFormation documentation)
- [Getting started with NDepend](#) (NDepend documentation)
- [Porting Assistant for .NET](#)

## Additional information

The following tables provide examples of sample projects for a legacy shopping cart application and the equivalent projects in your modernized ASP.NET Core application.

### Legacy solution:

Project name	Project template	Target framework
Business Interface	Class Library	.NET Framework
BusinessLogic	Class Library	.NET Framework
WebApplication	ASP.NET Framework Web Application	.NET Framework
UnitTests	NUnit Test Project	.NET Framework
Shared ->Common	Class Library	.NET Framework
Shared ->Framework	Class Library	.NET Framework

### New solution:

Project name	Project template	Target framework
BusinessLogic	Class Library	.NET 5.0

---

<WebAPI>	ASP.NET Core Web API	.NET 5.0
<WebAPI>.UnitTests	NUnit 3 Test Project	.NET 5.0
Shared ->Common	Class Library	.NET 5.0
Shared ->Framework	Class Library	.NET 5.0

# Run event-driven and scheduled workloads at scale with AWS Fargate

Created by HARI OHM PRASATH RAJAGOPAL (AWS)

**Environment:** PoC or pilot

**Technologies:** Modernization; Serverless; Operations

**Workload:** Open-source

**AWS services:** Amazon EC2 Container Registry; Amazon ECS; AWS CodeCommit; AWS Fargate; AWS Lambda; Amazon SNS

## Summary

This pattern describes how to run scheduled and event-driven workloads at scale on the Amazon Web Services (AWS) Cloud by using AWS Fargate.

In the use case that this pattern sets up, code is scanned for AWS sensitive information, such as the AWS account number and credentials, whenever a pull request is submitted. The pull request initiates a Lambda function. The Lambda function invokes a Fargate task that takes care of the code scan. Lambda is initiated whenever a new pull request is raised. If the scan finds any sensitive information, Amazon Simple Notification Service (Amazon SNS) sends the scan results in an email message.

This pattern is helpful in the following business use cases:

- If your business must run many scheduled and event-driven workloads that cannot be run by AWS Lambda because of limitations around runtime (a 15-minute limit) or memory
- If you want AWS to manage the instances provisioned for these workloads

When you use this pattern, you have the option of creating a new virtual private cloud (VPC).

## Prerequisites and limitations

### Prerequisites

- An active AWS account
- AWS CodeCommit for hosting the code base and creating pull requests
- AWS Command Line Interface (AWS CLI) version 1.7 or later, installed and configured on macOS, Linux, or Windows
- Workloads running in containers
- Apache Maven executable set up in classpath

### Architecture

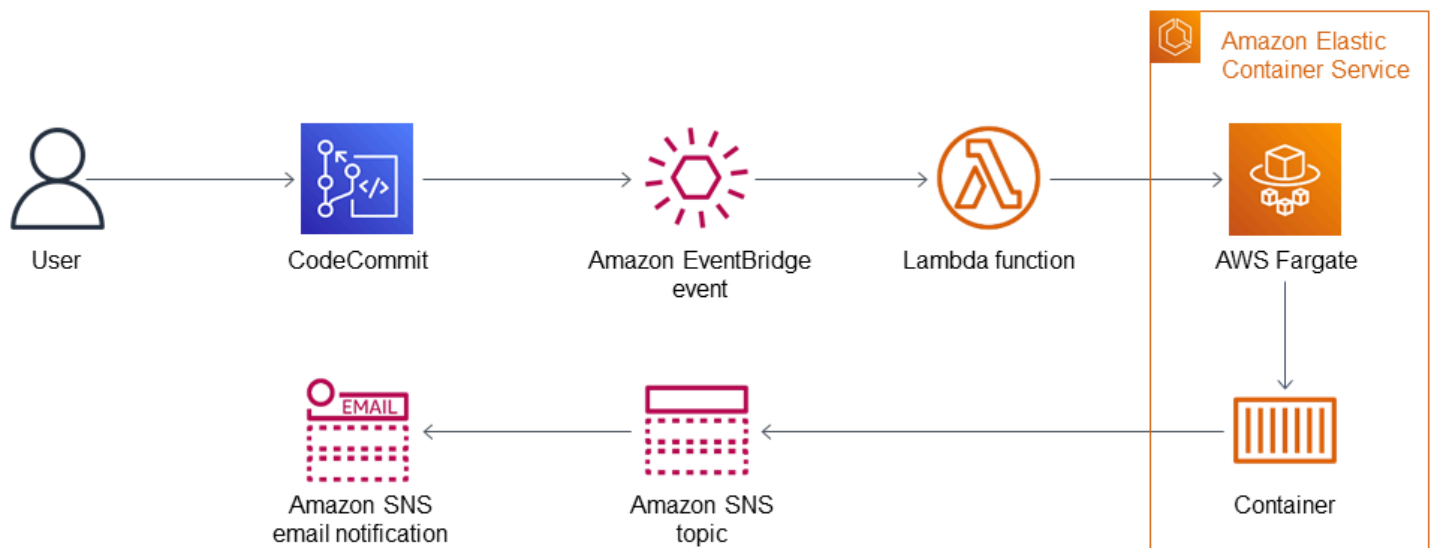

The overall flow includes the following steps.

1. Whenever a new pull request is submitted in CodeCommit, a Lambda function is initiated. The Lambda function listens through the CodeCommit Pull Request State Change event through Amazon EventBridge.
2. The Lambda function submits a new Fargate task with the following environment parameters for checking out the code and scanning it.

```

RUNNER # <<TaskARN>>
SNS_TOPIC # <<SNSTopicARN>>
  
```

```
SUBNET # <<Subnet in which Fargate task gets launched>>
```

If the scan finds sensitive information in the code, Fargate pushes a new message to the Amazon SNS topic.

3. An SNS subscriber reads the message from the topic and sends an email message.

## Technology

- AWS CodeCommit
- Amazon Elastic Container Registry (Amazon ECR)
- Amazon Elastic Container Service (Amazon ECS)
- Amazon EventBridge
- AWS Fargate
- AWS Lambda
- Amazon SNS
- Docker

## Tools

### Tools

- [AWS CLI](#) – AWS Command Line Interface (CLI) is a unified tool to manage your AWS services.
- [AWS CodeCommit](#) – AWS CodeCommit is a fully managed source control service that hosts secure Git-based repositories. Using CodeCommit, teams can collaborate on code in a secure and highly scalable environment.
- [Amazon ECR](#) – Amazon Elastic Container Registry (Amazon ECR) is a fully managed registry that developers can use to store, manage, and deploy Docker container images.
- [Amazon ECS](#) – Amazon Elastic Container Service (Amazon ECS) is a highly scalable, fast container management service. You can use Amazon ECS to run, stop, and manage containers on a cluster.
- [AWS Fargate](#) – AWS Fargate is a technology that you can use with Amazon ECS to run containers without having to manage servers or clusters of Amazon EC2 instances.
- [AWS Lambda](#) – AWS Lambda is a compute service that supports running code without provisioning or managing servers. Lambda runs your code only when needed and scales automatically, from a few requests per day to thousands per second.

- [Amazon SNS](#) – Amazon Simple Notification Service (Amazon SNS) is a managed service that provides message delivery from publishers to subscribers (also known as producers and consumers). Publishers communicate asynchronously with subscribers by sending messages to a topic, which is a logical access point and communication channel. Clients that subscribe to the SNS topic receive published messages using a supported protocol, such Lambda, email, mobile push notifications, and mobile text messages (SMS).
- [Docker](#) – Docker helps you build, test, and deliver applications in packages called containers.
- [Git client](#) – Command line or desktop tool to check out the required artifacts
- [Maven](#) – Apache Maven is a project management tool for centrally managing a project's build, reporting, and documentation.

## Epics

### Set up the local repository

Task	Description	Skills required
Download the code.	In the <b>Attachments</b> section, download the .zip file and extract the files.	Developer, AWS system administrator
Set up the repo.	Run <code>mvn clean install</code> on the root folder.	Developer, AWS system administrator

### Create an Amazon ECR image and push the image

Task	Description	Skills required
Create an Amazon ECR repository and log in.	Open the Amazon ECR console. In the navigation pane, choose <b>Repositories</b> , and then choose <b>Create repository</b> . For help with this and other stories, see the <b>Related resources</b> section.	Developer, AWS system administrator

Task	Description	Skills required
Push your container image.	Open the repository, choose <b>View push commands</b> , and log in to Docker. After you are logged in, run the commands, with the required substitutions, that are under <b>Push the container image</b> in the <b>Additional information</b> section. This uploads the Docker container image that is used to perform code scanning. After the upload is complete, copy the URL of the latest build in the Amazon ECR repository.	Developer, AWS system administrator

### Create the CodeCommit repository

Task	Description	Skills required
Create the CodeCommit repository.	To create a new AWS CodeCommit repository, run the command under <b>Create the CodeCommit repository</b> in the <b>Additional information</b> section.	Developer, AWS system administrator

### Create the VPC (optional)

Task	Description	Skills required
Create a VPC.	If you want to use a new VPC rather than an existing	Developer, AWS system administrator

Task	Description	Skills required
	one, run the commands under <b>Create a VPC</b> in the <b>Additional information</b> section. The AWS Cloud Development Kit (AWS CDK) script will output the IDs of the VPC and subnet that were created.	

### Create the Amazon ECS cluster and Fargate task

Task	Description	Skills required
Create the cluster and the task.	To create an Amazon ECS cluster and Fargate task definition, run the commands under <b>Create the cluster and task</b> in the <b>Additional information</b> section. Make sure that the correct VPC ID and Amazon ECR repo URI are passed in as a parameter while running the shell script. The script creates a Fargate task definition that points to the Docker image (responsible for scanning). The script then creates a job and an associated execution role.	Developer, AWS system administrator
Verify the Amazon ECS cluster.	Open the Amazon ECS console. In the navigation pane, choose <b>Clusters</b> , and choose the newly created Amazon ECS cluster named	Developer, AWS system administrator



Task	Description	Skills required
	<b>Fargate-Job-Cluster.</b> After this, choose <b>Task definition</b> in the navigation pane, and confirm that there is a new task definition with the prefix <code>awscdkfargateecsTaskDef</code> .	

## Create the SNS topic and subscriber

Task	Description	Skills required
Create an SNS topic.	To create an SNS topic, run the command under <b>Create the SNS topic</b> in the <b>Additional information</b> section. After creation is successful, note the SNS ARN, which is used in the next step.	Developer, AWS system administrator
Create the SNS subscriber.	To create an email subscriber for the SNS topic, run the command under <b>Create the SNS subscriber</b> in the <b>Additional information</b> section. Make sure to replace <code>TopicARN</code> and <code>Email address</code> used in the CLI command. To receive email notifications, make sure to confirm the email address that is used as a subscriber.	Developer, AWS system administrator

## Create the Lambda function and CodeCommit trigger

Task	Description	Skills required
Create the function and the trigger.	To create a Lambda function with a CodeCommit trigger, run the command under <b>Lambda function and CodeCommit trigger</b> in the <b>Additional information</b> section. Make sure to replace the parameters with the corresponding values before running the command. The script creates the Lambda function and configures it to be invoked when a new pull request is made.	Developer, AWS system administrator

## Test the application

Task	Description	Skills required
Test the application.	If you check in any AWS sensitive information to CodeCommit repo, the Lambda function should be initiated. The Lambda function initiates the Fargate task, which scans the code and sends the scan results in an email notification.	Developer, AWS system administrator

## Related resources

- [Creating an Amazon ECR repository](#)
- [Pushing Docker images to Amazon ECR](#)

## Additional information

### Push the container image

```
> cd 1-ecr-image-push
> ./run.sh <<ecr-repository>>
```

### Create the CodeCommit repository

```
aws codecommit create-repository --repository-name test-repo --repository-description
"My Test repository"
```

### Create a VPC

```
> cd 2-create-vpc
> ./run.sh
```

### Output

```
aws-batch-cdk-vpc-efs-launch-template.privatesubnet = subnet-<<id>>
aws-batch-cdk-vpc-efs-launch-template.publicsubnet = subnet-<<id>>
aws-batch-cdk-vpc-efs-launch-template.vpcid = vpc-<<id>>
```

### Create the cluster and task

```
> export CDK_DEFAULT_ACCOUNT = <<aws_account_id>>
> export CDK_DEFAULT_REGION = <<aws_region>>
> cd 3-create-ecs-task
> ./run.sh <<vpc-id>> <<ecr-repo-uri>>
```

### Output

```
aws-cdk-fargate-ecs.CLUSTERNAME = Fargate-Job-Cluster
```

```
aws-cdk-fargate-ecs.ClusterARN = <<cluster_arn>>
aws-cdk-fargate-ecs.ContainerARN = Fargate-Container
aws-cdk-fargate-ecs.TaskARN = <<task_arn>>
aws-cdk-fargate-ecs.TaskExecutionRole = <<execution_role_arn>>
aws-cdk-fargate-ecs.TaskRole = <<task_role_arn>>
```

## Create the SNS topic

```
aws sns create-topic --name code-commit-topic
```

## Create the SNS subscriber

```
aws sns subscribe \
  --topic-arn <<topic_arn>> \
  --protocol email \
  --notification-endpoint <<email_address>>
```

## Lambda function and CodeCommit trigger

```
> export CDK_DEFAULT_ACCOUNT = <<aws_account_id>>
> export CDK_DEFAULT_REGION = <<aws_region>>
> cd 5-Lambda-CodeCommit-Trigger
> ./run.sh <<taskarn>> <<snstopicarn>> subnet-<<id>> <<codecommitarn>>
```

## Output

```
aws-cdk-fargate-lambda-event.Cloudwatchrule = <<cloudwatchrule>>
aws-cdk-fargate-lambda-event.CodeCommitLambda = AWS-Code-Scanner-Function
aws-cdk-fargate-lambda-event.LambdaRole = <<lambdaiamrole>>
```

## Attachments

To access additional content that is associated with this document, unzip the following file:

[attachment.zip](#)

# Tenant onboarding in SaaS architecture for the silo model using C# and AWS CDK

Created by Tabby Ward (AWS), Susmitha Reddy Gankidi (AWS), and Vijai Anand Ramalingam (AWS)

<b>Code repository:</b> <a href="#">Tennat Onboarding Silo</a>	<b>Environment:</b> PoC or pilot	<b>Technologies:</b> Modernization; DevOps
<b>Workload:</b> Open-source	<b>AWS services:</b> AWS CloudFormation; Amazon DynamoDB; Amazon DynamoDB Streams; AWS Lambda; Amazon API Gateway	

## Summary

Software as a service (SaaS) applications can be built with a variety of different architectural models. The *silo model* refers to an architecture where tenants are provided dedicated resources.

SaaS applications rely on a frictionless model for introducing new tenants into their environment. This often requires the orchestration of a number of components to successfully provision and configure all the elements needed to create a new tenant. This process, in SaaS architecture, is referred to as tenant on-boarding. On-boarding should be fully automated for every SaaS environment by utilizing infrastructure as code in your on-boarding process.

This pattern guides you through an example of creating a tenant and provisioning a basic infrastructure for the tenant on Amazon Web Services (AWS). The pattern uses C# and the AWS Cloud Development Kit (AWS CDK).

Because this pattern creates a billing alarm, we recommend deploying the stack in the US East (N. Virginia), or us-east-1, AWS Region. For more information, see the [AWS documentation](#).

## Prerequisites and limitations

### Prerequisites

- An active [AWS account](#).
- An AWS Identity and Access Management (IAM) principal with sufficient IAM access to create AWS resources for this pattern. For more information, see [IAM roles](#).
- [Install Amazon Command Line Interface \(AWS CLI\)](#) and [configure AWS CLI](#) to perform AWS CDK deployment.
- [Visual Studio 2022](#) downloaded and installed or [Visual Studio Code](#) downloaded and installed.
- [AWS Toolkit for Visual Studio](#) set up.
- [.NET Core 3.1 or later](#) (required for C# AWS CDK applications)
- [Amazon.Lambda.Tools](#) installed.

## Limitations

- AWS CDK uses [AWS CloudFormation](#), so AWS CDK applications are subject to CloudFormation service quotas. For more information, see [AWS CloudFormation quotas](#).
- The tenant CloudFormation stack is created with a CloudFormation service role `infra-cloudformation-role` with wildcard characters on actions (`sns*` and `sqs*`) but with resources locked down to the `tenant-cluster` prefix. For a production use case, evaluate this setting and provide only required access to this service role. The `InfrastructureProvision` Lambda function also uses a wildcard character (`cloudformation*`) to provision the CloudFormation stack but with resources locked down to the `tenant-cluster` prefix.
- This example code's docker build uses `--platform=linux/amd64` to force `linux/amd64` based images. This is to ensure that the final image artifacts will be suitable for Lambda, which by default uses x86-64 architecture. If you need to change the target Lambda architecture, be sure to change both the Dockerfiles and the AWS CDK codes. For more information, see the blog post [Migrating AWS Lambda functions to Arm-based AWS Graviton2 processors](#).
- The stack deletion process will not clean up CloudWatch Logs (log groups and logs) generated by the stack. You must manually clean up the logs through the AWS Management Console Amazon CloudWatch console or the through the API.

This pattern is set up as an example. For production use, evaluate the following setups and make changes based on your business requirements:

- The [AWS Simple Storage Service \(Amazon S3\)](#) bucket in this example does not have versioning enabled for simplicity. Evaluate and update the setup as needed.

- This example sets up [Amazon API Gateway](#) REST API endpoints without authentication, authorization, or throttling for simplicity. For production use, we recommend integrating the system with the business security infrastructure. Evaluate this setting and add required security settings as needed.
- For this tenant infrastructure example, [Amazon Simple Notification Service \(Amazon SNS\)](#) and [Amazon Simple Queue Service \(Amazon SQS\)](#) have only minimum setups. The [AWS Key Management Service \(AWS KMS\)](#) for each tenant opens to [Amazon CloudWatch](#) and Amazon SNS services in the account to consume based on the [AWS KMS key policy](#). The setup is only an example placeholder. Adjust the setups as needed based on your business use case.
- The entire setup, which includes but isn't limited to API endpoints and backend tenant provisioning and deletion by using AWS CloudFormation, covers only the basic happy path case. Evaluate and update the setup with the necessary retry logic, additional error handling logic, and security logic based on your business needs.
- The example code is tested with up-to-date [cdk-nag](#) to check for policies at the time of this writing. New policies might be enforced in the future. These new policies might require you to manually modify the stack based on the recommendations before the stack can be deployed. Review the existing code to ensure that it aligns with your business requirements.
- The code relies on the AWS CDK to generate a random suffix instead of relying on static assigned physical names for most created resources. This setup is to ensure that these resources are unique and do not conflict with other stacks. For more information, see the [AWS CDK documentation](#). Adjust this based on your business requirements.
- This example code packages .NET Lambda artifacts into Docker based images and runs with the Lambda provided [Container image runtime](#). The container image runtime has advantages for standard transfer and store mechanisms (container registries) and more accurate local test environments (through the container image). You can switch the project to use [Lambda provided .NET runtimes](#) to reduce the build time of the Docker images, but you will then need to set up transfer and store mechanisms and ensure that the local setup matches the Lambda setup. Adjust the code to align with users' business requirements.

## Product versions

- AWS CDK version 2.45.0 or later
- Visual Studio 2022

# Architecture

## Technology stack

- Amazon API Gateway
- AWS CloudFormation
- Amazon CloudWatch
- Amazon DynamoDB
- AWS Identity and Access Management (IAM)
- AWS KMS
- AWS Lambda
- Amazon S3
- Amazon SNS
- Amazon SQS

## Architecture

The following diagram shows the tenant stack creation flow. For more information about the control-plane and tenant technology stacks, see the *Additional information* section.



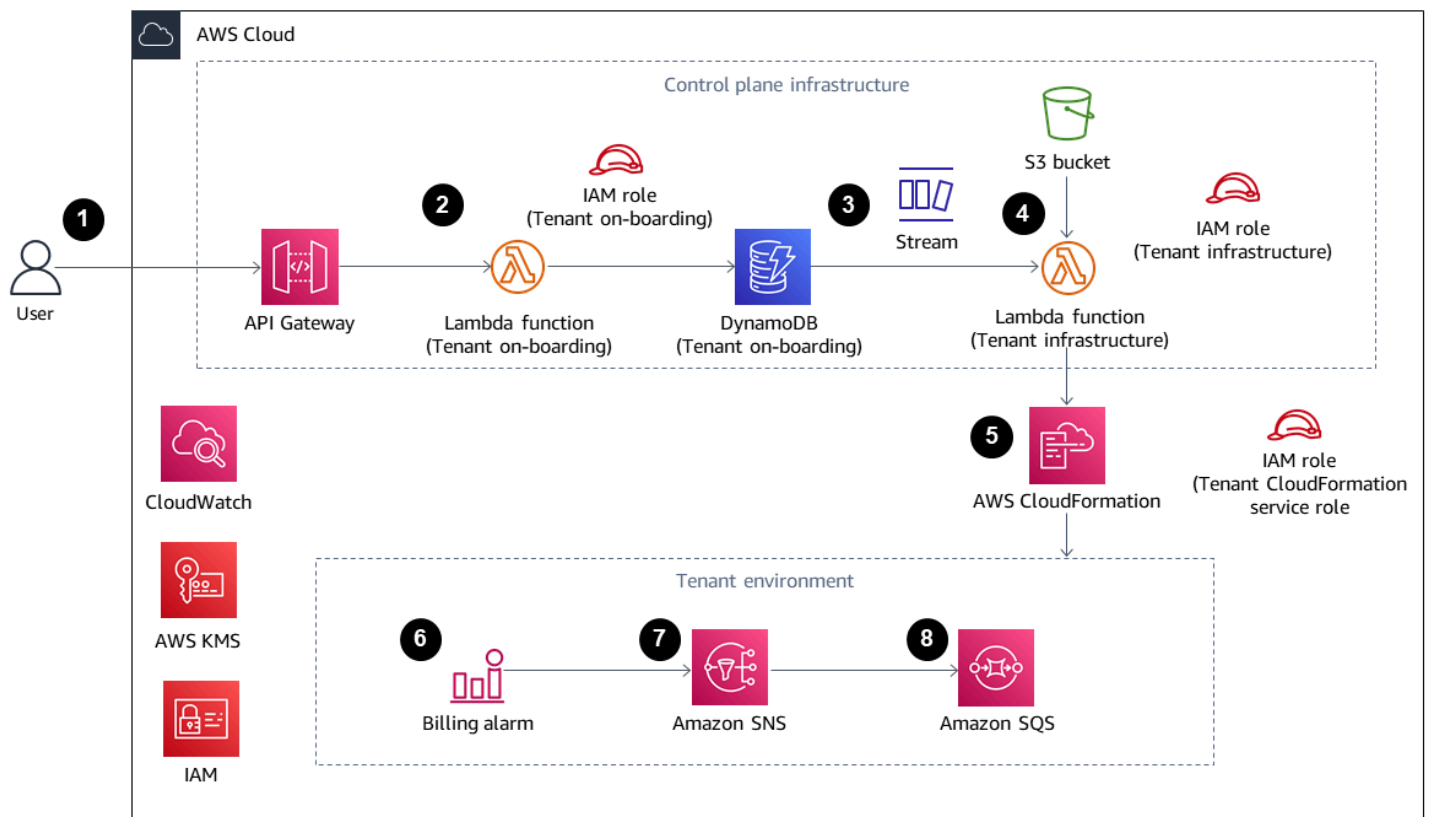

## Tenant stack creation flow

1. User sends a POST API request with new tenant payload (tenant name, tenant description) in JSON to a REST API hosted by Amazon API Gateway. The API Gateway processes the request and forwards it to the backend Lambda Tenant On-boarding function. In this example, there is no authorization or authentication. In a production setup, this API should be integrated with the SaaS infrastructure security system.
2. The Tenant On-boarding function verifies the request. Then it attempts to store the tenant record, which includes the tenant name, generated tenant universally unique identifier (UUID), and tenant description, into the Amazon DynamoDB Tenant On-boarding table.
3. After DynamoDB stores the record, a DynamoDB stream initiates the downstream Lambda Tenant Infrastructure function.
4. The Tenant Infrastructure Lambda function acts based on the received DynamoDB stream. If the stream is for the INSERT event, the function uses the stream's NewImage section (latest update record, Tenant Name field) to invoke CloudFormation to create a new tenant infrastructure using the template that is stored in the S3 bucket. The CloudFormation template requires the Tenant Name parameter.

5. AWS CloudFormation creates the tenant infrastructure based on the CloudFormation template and input parameters.
6. Each tenant infrastructure setup has a CloudWatch alarm, a billing alarm, and an alarm event.
7. The alarm event becomes a message to an SNS topic, which is encrypted by the tenant's AWS KMS key.
8. The SNS topic forwards the received alarm message to the SQS queue, which is encrypted by the tenant's AWS KMS for encryption key.

Other systems can be integrated with Amazon SQS to perform actions based on messages in queue. In this example, to keep the code generic, incoming messages remain in queue and require manual deletion.

### Tenant stack deletion flow

1. User sends a DELETE API request with new tenant payload (tenant name, tenant description) in JSON to the REST API hosted by Amazon API Gateway, which will process the request and forward to Tenant On-boarding function. In this example, there is no authorization or authentication. In a production setup, this API will be integrated with the SaaS infrastructure security system.
2. The Tenant On-boarding function will verify the request and then attempt to delete the tenant record (tenant name) from the Tenant On-boarding table.
3. After DynamoDB deletes the record successfully (the record exists in the table and is deleted), a DynamoDB stream initiates the downstream Lambda Tenant Infrastructure function.
4. The Tenant Infrastructure Lambda function acts based on the received DynamoDB stream record. If the stream is for the REMOVE event, the function uses the record's OldImage section (record information and Tenant Name field, before the latest change, which is delete) to initiate deletion of an existing stack based on that record information.
5. AWS CloudFormation deletes the target tenant stack according to the input.

## Tools

### AWS services

- [Amazon API Gateway](#) helps you create, publish, maintain, monitor, and secure REST, HTTP, and WebSocket APIs at any scale.

- [AWS Cloud Development Kit \(AWS CDK\)](#) is a software development framework that helps you define and provision AWS Cloud infrastructure in code.
- [AWS CDK Toolkit](#) is a command line cloud development kit that helps you interact with your AWS Cloud Development Kit (AWS CDK) app.
- [AWS Command Line Interface \(AWS CLI\)](#) is an open-source tool that helps you interact with AWS services through commands in your command-line shell.
- [AWS CloudFormation](#) helps you set up AWS resources, provision them quickly and consistently, and manage them throughout their lifecycle across AWS accounts and Regions.
- [Amazon DynamoDB](#) is a fully managed NoSQL database service that provides fast, predictable, and scalable performance.
- [AWS Identity and Access Management \(IAM\)](#) helps you securely manage access to your AWS resources by controlling who is authenticated and authorized to use them.
- [AWS Key Management Service \(AWS KMS\)](#) helps you create and control cryptographic keys to help protect your data.
- [AWS Lambda](#) is a compute service that helps you run code without needing to provision or manage servers. It runs your code only when needed and scales automatically, so you pay only for the compute time that you use.
- [Amazon Simple Storage Service \(Amazon S3\)](#) is a cloud-based object storage service that helps you store, protect, and retrieve any amount of data.
- [Amazon Simple Notification Service \(Amazon SNS\)](#) helps you coordinate and manage the exchange of messages between publishers and clients, including web servers and email addresses.
- [Amazon Simple Queue Service \(Amazon SQS\)](#) provides a secure, durable, and available hosted queue that helps you integrate and decouple distributed software systems and components.
- [AWS Toolkit for Visual Studio](#) is a plugin for the Visual Studio integrated development environment (IDE). The Toolkit for Visual Studio supports developing, debugging, and deploying .NET applications that use AWS services.

## Other tools

- [Visual Studio](#) is an IDE that includes compilers, code completion tools, graphical designers, and other features that support software development.

## Code

The code for this pattern is in the [Tenant onboarding in SaaS Architecture for Silo Model APG Example](#) repository.

## Epics

### Set up AWS CDK

Task	Description	Skills required
Verify Node.js installation.	<p>To verify that Node.js is installed on your local machine, run the following command.</p> <pre>node --version</pre>	AWS administrator, AWS DevOps
Install AWS CDK Toolkit.	<p>To install AWS CDK Toolkit on your local machine, run the following command.</p> <pre>npm install -g aws-cdk</pre> <p>If npm is not installed, you can install it from the <a href="#">Node.js site</a>.</p>	AWS administrator, AWS DevOps
Verify the AWS CDK Toolkit version.	<p>To verify that the AWS CDK Toolkit version is installed correctly on your machine, run the following command.</p> <pre>cdk --version</pre>	AWS administrator, AWS DevOps

## Review the code for the tenant onboarding control plane

Task	Description	Skills required
<p>Clone the repository.</p>	<p>Clone the <a href="#">repository</a>, and navigate to the <code>\tenant-onboarding-in-saas-architecture-for-silo-model-apg-example</code> folder.</p> <p>In Visual Studio 2022, open the <code>\src\TenantOnboardingInfra.sln</code> solution. Open the <code>TenantOnboardingInfraStack.cs</code> file and review the code.</p> <p>The following resources are created as part of this stack:</p> <ul style="list-style-type: none"> <li>• DynamoDB table</li> <li>• S3 bucket (Upload the CloudFormation template to the S3 bucket.)</li> <li>• Lambda execution role</li> <li>• Lambda function</li> <li>• API Gateway API</li> <li>• Event source to Lambda function</li> </ul>	<p>AWS administrator, AWS DevOps</p>
<p>Review the CloudFormation template.</p>	<p>In the <code>\tenant-onboarding-in-saas-architecture-for-silo-model-apg-example\template</code> folder, open <code>infra.yaml</code>, and</p>	<p>App developer, AWS DevOps</p>

Task	Description	Skills required
	<p>review the CloudFormation template. This template will be hydrated with the tenant name retrieved from the tenant onboarding DynamoDB table.</p> <p>The template provisions the tenant-specific infrastructure. In this example, it provisions the AWS KMS key, Amazon SNS, Amazon SQS, and the CloudWatch alarm.</p>	

Task	Description	Skills required
Review the tenant onboarding function.	<p>Open <code>Function.cs</code> , and review the code for the tenant onboarding function, which is created with the Visual Studio AWS Lambda Project (.NET Core- C#) template with the .NET 6 (Container Image) blueprint.</p> <p>Open the <code>Dockerfile</code> , and review the code. The <code>Dockerfile</code> is a text file that consists of instructions for building the Lambda container image.</p> <p>Note that the following NuGet packages are added as dependencies to the <code>TenantOnboardingFunction</code> project:</p> <ul style="list-style-type: none"><li>• <code>Amazon.Lambda.APIGatewayEvents</code></li><li>• <code>AWSSDK.DynamoDBv2</code></li><li>• <code>Newtonsoft.Json</code></li></ul>	App developer, AWS DevOps

Task	Description	Skills required
Review the Tenant InfraProvisioning function.	<p>Navigate to <code>\tenant-onboarding-in-saas-architecture-for-silo-model-app-example\src\InfraProvisioningFunction</code> .</p> <p>Open <code>Function.cs</code> , and review the code for the tenant infrastructure provisioning function, which is created with the Visual Studio AWS Lambda Project (.NET Core- C#) template with the .NET 6 (Container Image) blueprint.</p> <p>Open the <code>Dockerfile</code> , and review the code.</p> <p>Note that the following NuGet packages are added as dependencies to the <code>InfraProvisioningFunction</code> project:</p> <ul style="list-style-type: none"><li>• <code>Amazon.Lambda.DynamoDBEvents</code></li><li>• <code>AWSSDK.DynamoDBv2</code></li><li>• <code>AWSSDK.Cloudformation</code></li></ul>	App developer, AWS DevOps



## Deploy the AWS resources

Task	Description	Skills required
Build the solution.	<p>To build the solution, perform the following steps:</p> <ol style="list-style-type: none"> <li>1. In Visual Studio 2022, open the <code>\tenant-onboarding-in-saas-architecture-for-silo-model-app-example\src\TenantOnboardingInfra.sln</code> solution.</li> <li>2. Open the context (right-click) menu for the solution, and choose <b>Build solution</b>.</li> </ol> <p><b>Note:</b> Make sure that you update the <code>Amazon.CDK.Lib</code> NuGet package to the latest version in <code>\tenant-onboarding-in-saas-architecture-for-silo-model-app-example\src\TenantOnboardingInfra</code> project before you build the solution.</p>	App developer
Bootstrap the AWS CDK environment.	Open the Windows command prompt and navigate to the AWS CDK app root folder where the <code>cdk.json</code> file is available ( <code>\tenant-onboarding-in-saas-</code>	AWS administrator, AWS DevOps

Task	Description	Skills required
	<p>architecture-for-silo-model-app-example ). Run the following command for bootstrapping.</p> <pre>cdk bootstrap</pre> <p>If you have created an AWS profile for the credentials, use the command with your profile.</p> <pre>cdk bootstrap --profile &lt;profile name&gt;</pre>	
List the AWS CDK stacks.	<p>To list all the stacks to be created as part of this project, run the following command.</p> <pre>cdk ls cdk ls --profile &lt;profile name&gt;</pre> <p>If you have created an AWS profile for the credentials, use the command with your profile.</p> <pre>cdk ls --profile &lt;profile name&gt;</pre>	AWS administrator, AWS DevOps

Task	Description	Skills required
Review which AWS resources will be created.	<p>To review all the AWS resources that will be created as part of this project, run the following command.</p> <pre>cdk diff</pre> <p>If you have created an AWS profile for the credentials, use the command with your profile.</p> <pre>cdk diff --profile &lt;profile name&gt;</pre>	AWS administrator, AWS DevOps

Task	Description	Skills required
Deploy all the AWS resources by using AWS CDK.	<p>To deploy all the AWS resources run the following command.</p> <pre>cdk deploy --all --require-approval never</pre> <p>If you have created an AWS profile for the credentials, use the command with your profile.</p> <pre>cdk deploy --all --require-approval never --profile &lt;profile name&gt;</pre> <p>After the deployment is complete, copy the API URL from the outputs section in the command prompt, which is shown in the following example.</p> <pre>Outputs: TenantOnboardingIn fraStack.TenantOnb oardingAPIEndpoint 42E526D7 = https://j 2qmp8ds21i1i.execu te-api.us-west-2.a mazonaws.com/prod/</pre>	AWS administrator, AWS DevOps

## Verify the functionality

Task	Description	Skills required
Create a new tenant.	<p>To create the new tenant, send the following curl request.</p> <pre data-bbox="594 499 1027 779">curl -X POST &lt;TenantOnboardingAPIEndpoint* from CDK Output&gt;tenant -d '{"Name":"Tenant123", "Description":"Stack for Tenant123"}'</pre> <p>Change the place holder &lt;TenantOnboardingAPIEndpoint* from CDK Output&gt; to the actual value from AWS CDK, as shown in the following example.</p> <pre data-bbox="594 1129 1027 1444">curl -X POST https://j2qmp8ds21i1i.execute-api.us-west-2.amazonaws.com/prod/tenant -d '{"Name":"Tenant123", "Description":"test12"}'</pre> <p>The following example shows the output.</p> <pre data-bbox="594 1604 1027 1759">{"message": "A new tenant added - 5/4/2022 7:11:30 AM"}</pre>	App developer, AWS administrator, AWS DevOps

Task	Description	Skills required
Verify the newly created tenant details in DynamoDB.	<p>To verify the newly created tenant details in DynamoDB, perform the following steps.</p> <ol style="list-style-type: none"><li>1. Open AWS Management Console, and navigate to the Amazon DynamoDB service.</li><li>2. In the left navigation, choose <b>Explore items</b>, and choose the TenantOnboarding table.</li></ol> <p><b>Note:</b> The tenant name will be prepended with <code>tenantcluster-</code>. For more information, see the <i>Additional information</i> section.</p> <ol style="list-style-type: none"><li>3. Verify that a new item is created with the tenant details.</li></ol>	App developer, AWS administrator, AWS DevOps

Task	Description	Skills required
Verify the stack creation for the new tenant.	<p>Verify that the new stack was successfully created and provisioned with infrastructure for the newly created tenant according to the CloudFormation template.</p> <ol style="list-style-type: none"><li>1. Open the CloudFormation console.</li><li>2. In the left navigation, choose <b>Stacks</b>, and verify that a stack with the tenant name was successfully created.</li><li>3. Choose the newly created tenant stack, and then choose the <b>Resources</b> tab. Note the alarm resource and the Amazon SQS resource.</li><li>4. Open a new terminal with AWS credentials configured, and point to the correct Region. To raise a test alarm, enter the following code, replacing <code>&lt;alarm resource name&gt;</code> with the alarm resource name noted in step 3.</li></ol> <pre data-bbox="630 1646 1029 1820">aws cloudwatch set-alarm-state --alarm-name &lt;alarm resource name&gt; --state-value</pre>	App developer, AWS administrator, AWS DevOps

Task	Description	Skills required
	<pre data-bbox="630 205 1026 310">ALARM --state-reason 'Test setup'</pre> <p data-bbox="630 344 1026 478">The following example shows the code with an alarm resource name.</p> <pre data-bbox="630 512 1026 827">aws cloudwatch set- alarm-state --alarm- name tenantcluster- tenant123-alarm -- state-value ALARM -- state-reason 'Test setup'</pre> <p data-bbox="591 848 1026 1310">5. Open the console and navigate to the Amazon SQS console. Choose the Amazon SQS resource name identified in step 3. Follow the <a href="#">AWS documentation instructions</a> to receive and delete the test message from the alarm that was raised in step 4.</p>	



Task	Description	Skills required
Delete the tenant stack.	<p>To delete the tenant stack, send the following curl request.</p> <pre data-bbox="597 394 1026 632">curl -X DELETE &lt;TenantOnboardingAPIEndpoint* from CDK Output&gt;tenant/&lt;Tenant Name from previous step&gt;</pre> <p>Change the place holder &lt;TenantOnboardingAPIEndpoint* from CDK Output&gt; to the actual value from AWS CDK, and change &lt;Tenant Name from previous step&gt; to the actual value from the previous tenant creation step, as shown in the following example.</p> <pre data-bbox="597 1224 1026 1461">curl -X DELETE https://j2qmp8ds21i1i.execute-api.us-west-2.amazonaws.com/prod/tenant/Tenant123</pre> <p>The following example shows the output.</p> <pre data-bbox="597 1619 1026 1776">{"message": "Tenant destroyed - 5/4/2022 7:14:48 AM"}</pre>	App developer, AWS DevOps, AWS administrator

Task	Description	Skills required
Verify the stack deletion for the existing tenant.	<p>To verify that the existing tenant stack got deleted, perform the following steps:</p> <ol style="list-style-type: none"><li>1. Open console and navigate to the CloudFormation console.</li><li>2. In the left navigation, verify that the existing stack with the tenant name is no longer in console (if the CloudFormation console is set up to show only <b>Active</b> stacks) or is in the process of being deleted. If the stack is no longer in the CloudFormation console, use the dropdown list to change the console's setting from <b>Active</b> to <b>Deleted</b> to see the deleted stack and verify that the stack was deleted successfully.</li></ol>	App developer, AWS administrator, AWS DevOps

## Clean up

Task	Description	Skills required
Destroy the environment.	<p>Before the stack clean up, ensure the following:</p> <ul style="list-style-type: none"><li>• All records in DynamoDB are removed either through</li></ul>	AWS administrator, AWS DevOps

Task	Description	Skills required
	<p>the previous tenant deletion operation or through the DynamoDB console or API. Each tenant record deletion will initiate the cleanup of its AWS CloudFormation counterpart.</p> <ul style="list-style-type: none"><li>• All tenant-based AWS CloudFormation stacks are cleaned up (in case the DynamoDB trigger cleanup logic fails) on the AWS CloudFormation console.</li></ul> <p>After testing is done, AWS CDK can be used to destroy all the stacks and related resources by running the following command.</p> <pre>cdk destroy --all;</pre> <p>If you created an AWS profile for the credentials, use the profile.</p> <p>Confirm the stack deletion prompt to delete the stack.</p>	

Task	Description	Skills required
Clean up Amazon CloudWatch Logs.	The stack deletion process will not clean up CloudWatch Logs (log groups and logs) that were generated by the stack. Manually clean up the CloudWatch resources by using the CloudWatch console or the API.	App developer, AWS DevOps, AWS administrator

## Related resources

- [AWS CDK .NET Workshop](#)
- [Working with the AWS CDK in C#](#)
- [CDK .NET Reference](#)

## Additional information

### Control-plane technology stack

The CDK code written in .NET is used to provision the control-plane infrastructure, which consists of the following resources:

#### 1. API Gateway

Serves as the REST API entry point for the control-plane stack.

#### 2. Tenant on-boarding Lambda function

This Lambda function is initiated by API Gateway using the `m` method.

A POST method API request results in `(tenant name, tenant description)` being inserted into the DynamoDB `Tenant Onboarding` table.

In this code example, the tenant name is also used as part of the tenant stack name and the names of resources within that stack. This is to make these resources easier to identify. This

tenant name must be unique across the setup to avoid conflicts or errors. Detailed input validation setup is explained in the [IAM roles](#) documentation and the *Limitations* section.

The persistence process to the DynamoDB table will succeed only if the tenant name is not used in any other record in the table.

The tenant name in this case is the partition key for this table, because only the partition key can be used as a PutItem condition expression.

If the tenant name was never recorded before, the record will be saved into the table successfully.

However, if the tenant name is already used by an existing record in the table, the operation will fail and initiate a `DynamoDB ConditionalCheckFailedException` exception. The exception will be used to return a failure message (HTTP `BadRequest`) indicating that the tenant name already exists.

A DELETE method API request will remove the record for a specific tenant name from the `Tenant Onboarding` table.

The DynamoDB record deletion in this example will succeed even if the record does not exist.

If the target record exists and is deleted, it will create a DynamoDB stream record. Otherwise, no downstream record will be created.

### 3. Tenant on-boarding DynamoDB, with Amazon DynamoDB Streams enabled

This records the tenant metadata information, and any record save or deletion will send a stream downstream to the `Tenant Infrastructure Lambda` function.

### 4. Tenant infrastructure Lambda function

This Lambda function is initiated by the DynamoDB stream record from the previous step. If the record is for an INSERT event, it invokes AWS CloudFormation to create a new tenant infrastructure with the CloudFormation template that is stored in an S3 bucket. If the record is for REMOVE, it initiates deletion of an existing stack based on the stream record's `Tenant Name` field.

### 5. S3 bucket

This is for storing the CloudFormation template.

### 6. IAM roles for each Lambda function and a service role for CloudFormation

Each Lambda function has its unique IAM role with [least-privilege permissions](#) to achieve its task. For example, the Tenant On-boarding Lambda function has read/write access to DynamoDB, and the Tenant Infrastructure Lambda function can only read the DynamoDB stream.

A custom CloudFormation service role is created for tenant stack provisioning. This service role contains additional permissions for CloudFormation stack provisioning (for example, the AWS KMS key). This divides roles between Lambda and CloudFormation to avoid all permissions on a single role (Infrastructure Lambda role).

Permissions that allow powerful actions (such as creating and deleting CloudFormation stacks) are locked down and allowed only on resources that start with `tenantcluster-`. The exception is AWS KMS, because of its resource naming convention. The ingested tenant name from the API will be prepended with `tenantcluster-` along with other validation checks (alphanumeric with dash only, and limited to less than 30 characters to fit into most AWS resource naming). This ensures that the tenant name will not accidentally result in disruption of core infrastructure stacks or resources.

## Tenant technology stack

A CloudFormation template is stored in the S3 bucket. The template provisions the tenant-specific AWS KMS key, a CloudWatch alarm, an SNS topic, an SQS queue, and an [SQS policy](#).

The AWS KMS key is used for data encryption by Amazon SNS and Amazon SQS for their messages. The security practices for [AwsSolutions-SNS2 and AwsSolutions-SQS2](#) recommend that you set up Amazon SNS and Amazon SQS with encryption. However, CloudWatch alarms don't work with Amazon SNS when using an AWS managed key, so you must use a customer managed key in this case. For more information, see the [AWS Knowledge Center](#).

The SQS policy is used on the Amazon SQS queue to allow the created SNS topic to deliver the message to the queue. Without the SQS policy, the access will be denied. For more information, see the [Amazon SNS documentation](#).

# Decompose monoliths into microservices by using CQRS and event sourcing

Created by Rodolfo Jr. Cerrada (AWS), Dmitry Gulin (AWS), and Tabby Ward (AWS)

<b>Environment:</b> PoC or pilot	<b>Source:</b> Monolith CRUD model	<b>Target:</b> Microservices
<b>R Type:</b> Re-architect	<b>Workload:</b> Open-source	<b>Technologies:</b> Modernization; Messaging & communications; Serverless
<b>AWS services:</b> Amazon DynamoDB; AWS Lambda; Amazon SNS		

## Summary

This pattern combines two patterns, using both the command query responsibility separation (CQRS) pattern and the event sourcing pattern. The CQRS pattern separates responsibilities of the command and query models. The event sourcing pattern takes advantage of asynchronous event-driven communication to improve the overall user experience.

You can use CQRS and Amazon Web Services (AWS) services to maintain and scale each data model independently while refactoring your monolith application into microservices architecture. Then you can use the event sourcing pattern to synchronize data from the command database to the query database.

This pattern uses example code that includes a solution (\*.sln) file that you can open using the latest version of Visual Studio. The example contains Reward API code to showcase how CQRS and event sourcing work in AWS serverless and traditional or on-premises applications.

To learn more about CQRS and event sourcing, see the [Additional information](#) section.

## Prerequisites and limitations

### Prerequisites

- An active AWS account
- Amazon CloudWatch
- Amazon DynamoDB tables
- Amazon DynamoDB Streams
- AWS Identity and Access Management (IAM) access key and secret key; for more information, see the video in the *Related resources* section
- AWS Lambda
- Familiarity with Visual Studio
- Familiarity with AWS Toolkit for Visual Studio; for more information, see the *AWS Toolkit for Visual Studio demo* video in the *Related resources* section

### Product versions

- [Visual Studio 2019 Community Edition](#).
- [AWS Toolkit for Visual Studio 2019](#).
- .NET Core 3.1. This component is an option in the Visual Studio installation. To include .NET Core during installation, select **NET Core cross-platform development**.

### Limitations

- The example code for a traditional on-premises application (ASP.NET Core Web API and data access objects) does not come with a database. However, it comes with the `CustomerData` in-memory object, which acts as a mock database. The code provided is enough for you to test the pattern.

## Architecture

### Source technology stack

- ASP.NET Core Web API project
- IIS Web Server
- Data access object
- CRUD model



## Source architecture

In the source architecture, the CRUD model contains both command and query interfaces in one application. For example code, see `CustomerDAO.cs` (attached).

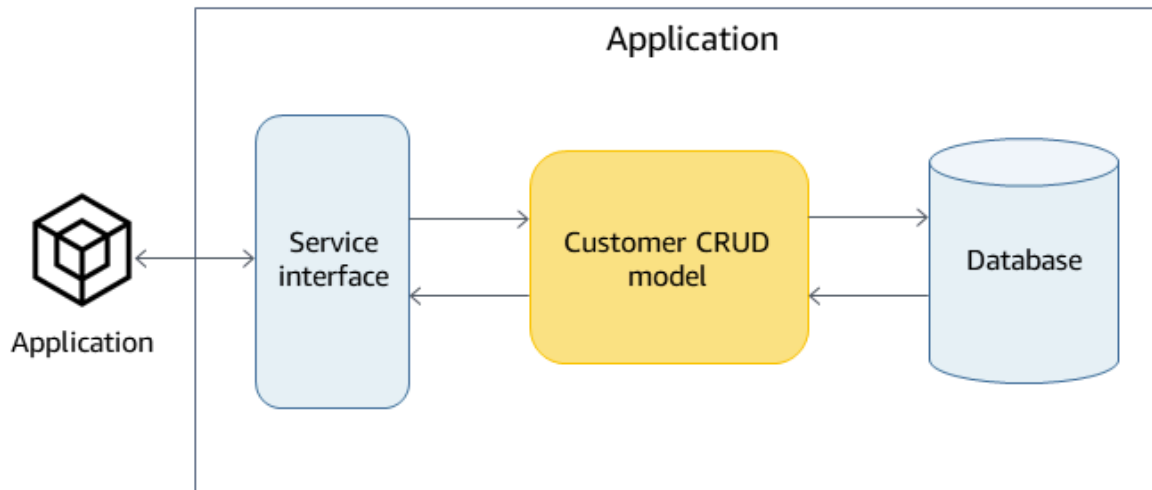

## Target technology stack

- Amazon DynamoDB
- Amazon DynamoDB Streams
- AWS Lambda
- (Optional) Amazon API Gateway
- (Optional) Amazon Simple Notification Service (Amazon SNS)

## Target architecture

In the target architecture, the command and query interfaces are separated. The architecture shown in the following diagram can be extended with API Gateway and Amazon SNS. For more information, see the [Additional information](#) section.

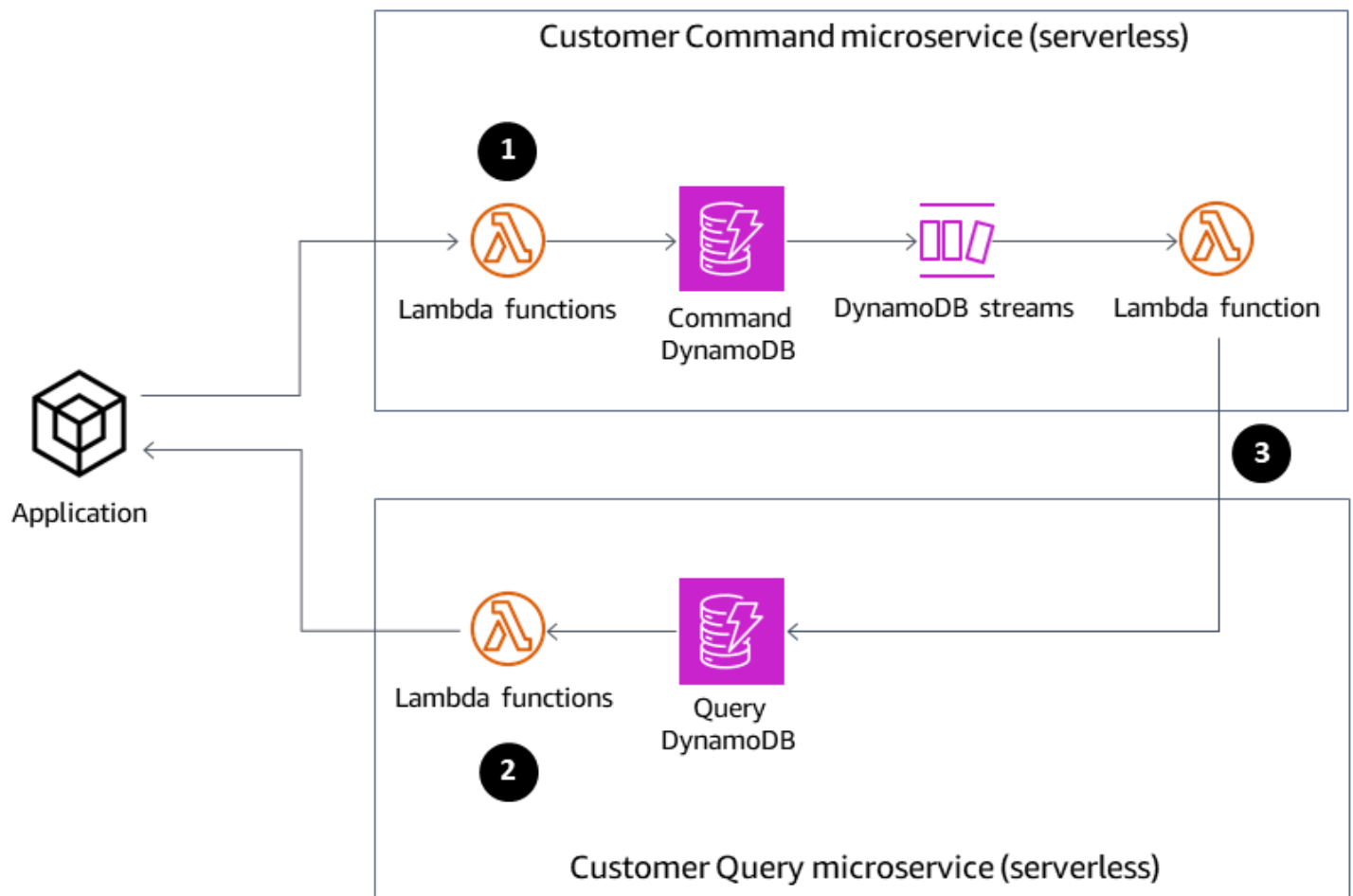

1. Command Lambda functions perform write operations, such as create, update, or delete, on the database.
2. Query Lambda functions perform read operations, such as get or select, on the database.
3. This Lambda function processes the DynamoDB streams from the Command database and updates the Query database for the changes.

## Tools

### Tools

- [Amazon DynamoDB](#) – Amazon DynamoDB is a fully managed NoSQL database service that provides fast and predictable performance with seamless scalability.
- [Amazon DynamoDB Streams](#) – DynamoDB Streams captures a time-ordered sequence of item-level modifications in any DynamoDB table. It then stores this information in a log for up to 24 hours. Encryption at rest encrypts the data in DynamoDB streams.

- [AWS Lambda](#) – AWS Lambda is a compute service that supports running code without provisioning or managing servers. Lambda runs your code only when needed and scales automatically, from a few requests per day to thousands per second. You pay only for the compute time that you consume—there is no charge when your code is not running.
- [AWS Management Console](#) – The AWS Management Console is a web application that comprises a broad collection of service consoles for managing AWS services.
- [Visual Studio 2019 Community Edition](#) – Visual Studio 2019 is an integrated development environment (IDE). The Community Edition is free for open-source contributors. In this pattern, you will use Visual Studio 2019 Community Edition to open, compile, and run example code. For viewing only, you can use any text editor or [Visual Studio Code](#).
- [AWS Toolkit for Visual Studio](#) – The AWS Toolkit for Visual Studio is a plugin for the Visual Studio IDE. The AWS Toolkit for Visual Studio makes it easier for you to develop, debug, and deploy .NET applications that use AWS services.

## Code

The example code is attached. For instructions on deploying the example code, see the *Epics* section.

## Epics

### Open and build the solution

Task	Description	Skills required
Open the solution.	<ol style="list-style-type: none"> <li>1. Download the example source code (CQRS-ES Code.zip) from the <i>Attachments</i> section, and extract the files.</li> <li>2. In the Visual Studio IDE, choose <b>File, Open, Project Solution</b>, and navigate to the folder where you extracted the source code.</li> </ol>	App developer

Task	Description	Skills required
	<p>3. Choose <b>AWS.APG.C QRSES.sln</b>, and then choose <b>Open</b>. The entire solution is loaded into Visual Studio.</p>	
Build the solution.	<p>Open the context (right-click) menu for the solution, and then choose <b>Build Solution</b>. This will build and compile all the projects in the solution. It should compile successfully.</p> <p>Visual Studio Solution Explorer should show the directory structure.</p> <ul style="list-style-type: none"> <li>• CQRS On-Premises Code Sample contains an example of using CQRS on premises.</li> <li>• CQRS AWS Serverless contains all the CQRS and event-sourcing example code using AWS serverless services.</li> </ul>	App developer

### Build the DynamoDB tables

Task	Description	Skills required
Provide credentials.	If you don't have an access key yet, see the video in the <i>Related resources</i> section.	App developer, Data engineer, DBA

Task	Description	Skills required
	<ol style="list-style-type: none"> <li>1. In Solution Explorer, expand <b>CQRS AWS Serverless</b>, and then expand the <b>Build</b> solution folder.</li> <li>2. Expand the <b>AwS.APG.CQRSES.Build</b> project and view the <code>Program.cs</code> file.</li> <li>3. Scroll to the top of <code>Program.cs</code> and look for <code>Program()</code>.</li> <li>4. Replace <code>YOUR_ACCESS_KEY</code> with your account access key, and replace <code>YOUR_SECRET_KEY</code> with your account secret key. Note that in a production environment, you would not hardcode your keys. Instead, you could use <a href="#">AWS Secrets Manager</a> to store and retrieve the credentials.</li> </ol>	
Build the project.	To build the project, open the context (right-click) menu for the <b>AwS.APG.CQRSES.Build</b> project, and then choose <b>Build</b> .	App developer, Data engineer, DBA

Task	Description	Skills required
Build and populate the tables.	To build the tables and populate them with seed data, open the context (right-click) menu for the <b>AwS.APG.CQRSES.Build</b> project, and then choose <b>Debug, Start New Instance</b> .	App developer, Data engineer, DBA
Verify the table construction and the data.	To verify, navigate to <b>AWS Explorer</b> , and expand <b>Amazon DynamoDB</b> . It should display the tables. Open each table to display the example data.	App developer, Data engineer, DBA

## Run local tests

Task	Description	Skills required
Build the CQRS project.	<ol style="list-style-type: none"> <li>1. Open the solution, and navigate to the <b>CQRS AWS Services/CQRS/Tests</b> solution folder.</li> <li>2. In the <b>AWS.APG.CQRSES.CQRSLambda.Tests</b> project, open <b>BaseFunctionTest.cs</b>, and replace <i>AccessKey</i> and <i>SecretKey</i> with the IAM keys that you created.</li> <li>3. Save the changes.</li> <li>4. To compile and build the test project, open the context (right-click) menu</li> </ol>	App developer, Test engineer

Task	Description	Skills required
	for the project, and then choose <b>Build</b> .	
Build the event-sourcing project.	<ol style="list-style-type: none"> <li>1. Navigate to the <b>CQRS AWS Services/Event Source/Tests</b> solution folder.</li> <li>2. In the <b>AWS.APG.CQRSES.EventSourceLambda.Tests</b> project, open <b>BaseFunctionTest.cs</b>, and replace <i>AccessKey</i> and <i>SecretKey</i> with the IAM keys that you created.</li> <li>3. Save the changes.</li> <li>4. To compile and build the test project, open the context (right-click) menu for the project, and then choose <b>Build</b>.</li> </ol>	App developer, Test engineer
Run the tests.	To run all tests, choose <b>View, Test Explorer</b> , and then choose <b>Run All Tests In View</b> . All tests should pass, which is indicated by a green check mark icon.	App developer, Test engineer

## Publish the CQRS Lambda functions to AWS

Task	Description	Skills required
Publish the first Lambda function.	<ol style="list-style-type: none"> <li>1. In Solution Explorer, open the context (right-click) menu for the <b>AWS.APG.C</b></li> </ol>	App developer, DevOps engineer

Task	Description	Skills required
	<p>QRSES.CommandCreat eLambda project, and then choose <b>Publish to AWS Lambda</b>.</p> <ol style="list-style-type: none"><li data-bbox="592 411 1008 680">2. Select the profile that you want to use and the AWS Region where you want to deploy the Lambda function, and the function name.</li><li data-bbox="592 709 980 835">3. For the remaining fields, keep the default values, and choose <b>Next</b>.</li><li data-bbox="592 865 980 991">4. In <b>Role Name</b> dropdown list, select <b>AWSLambda FullAccess</b>.</li><li data-bbox="592 1020 980 1432">5. To provide your account keys, choose <b>Add</b>, and enter AccessKey as the variable and your access key as the value. Then choose <b>Add</b> again, enter SecretKey as the variable and your secret key as the value.</li><li data-bbox="592 1461 1000 1772">6. For the remaining fields, keep the default values, and choose <b>Upload</b>. After the Lambda test function uploads, it appears in Visual Studio automatic ally.</li><li data-bbox="592 1801 980 1879">7. Repeat steps 1-6 for the following projects:</li></ol>	



Task	Description	Skills required
	<ul style="list-style-type: none"><li>• AWS.APG.CQRSES.CommandDeleteLambda</li><li>• AWS.APG.CQRSES.CommandUpdateLambda</li><li>• AWS.APG.CQRSES.CommandAddRewardLambda</li><li>• AWS.APG.CQRSES.CommandRedeemRewardLambda</li><li>• AWS.APG.CQRSES.QueryCustomerListLambda</li><li>• AWS.APG.CQRSES.QueryRewardLambda</li></ul>	
Verify the function upload.	(Optional) You can verify that the function was successfully loaded by navigating to AWS Explorer and expanding <b>AWS Lambda</b> . To open the test window, choose the Lambda function (double-click).	App developer, DevOps engineer

Task	Description	Skills required
Test the Lambda function.	<ol style="list-style-type: none"><li data-bbox="592 226 1027 548">1. Enter the request data, or copy an example request data from <b>Test data</b> in the <a href="#">Additional information</a> section. Make sure that you select data that is for the function you are testing.</li><li data-bbox="592 569 1027 890">2. To run the test, choose <b>Invoke</b>. The response and any errors are displayed in the <b>Response</b> text box, and logs are shown in the <b>Logs</b> text box or in CloudWatch Logs.</li><li data-bbox="592 911 1027 1087">3. To verify the data, in AWS Explorer, choose the DynamoDB table (double-click).</li></ol> <p data-bbox="592 1167 1027 1726">All CQRS Lambda projects are found under the CQRS AWS Serverless\CQRS\Command Microservice and CQRS AWS Serverless\CQRS\Command Microservice solution folders. For the solution directory and projects, see <b>Source code directory</b> in the <a href="#">Additional information</a> section.</p>	App developer, DevOps engineer

Task	Description	Skills required
Publish the remaining functions.	<p>Repeat the previous steps for the following projects:</p> <ul style="list-style-type: none"> <li>• AWS.APG.CQRSES.CommandDeleteLambda</li> <li>• AWS.APG.CQRSES.CommandUpdateLambda</li> <li>• AWS.APG.CQRSES.CommandAddRewardLambda</li> <li>• AWS.APG.CQRSES.CommandRedeemRewardLambda</li> <li>• AWS.APG.CQRSES.QueryCustomerListLambda</li> <li>• AWS.APG.CQRSES.QueryRewardLambda</li> </ul>	App developer, DevOps engineer

### Set up the Lambda function as an event listener

Task	Description	Skills required
Publish the Customer and Reward Lambda event handlers.	<p>To publish each event handler, follow the steps in the preceding epic.</p> <p>The projects are under the CQRS AWS Serverless\Event Source\Customer Event and CQRS AWS Serverless\Event Source\Reward Event solution folders. For more information, see <i>Source code</i></p>	App developer

Task	Description	Skills required
	<i>directory</i> in the <a href="#">Additional information</a> section.	

Task	Description	Skills required
Attach the event-sourcing Lambda event listener.	<ol style="list-style-type: none"><li>1. Log in to the AWS Management Console using the same account you use when you publish the Lambda projects.</li><li>2. For the <b>Region</b>, select <b>US East 1</b> or the Region where you deployed the Lambda functions in the previous epic.</li><li>3. Navigate to the <b>Lambda</b> service.</li><li>4. Select the EventSourceCustomer Lambda function.</li><li>5. Choose <b>Add Trigger</b>.</li><li>6. In the <b>Trigger configuration</b> dropdown list, select <b>DynamoDB</b>.</li><li>7. In the <b>DynamoDB table</b> dropdown list, select <b>cqrses-customer-cmd</b>.</li><li>8. In the <b>Starting position</b> dropdown list, select <i>Trim horizon</i> from . Trim horizon means that the DynamoDB trigger will start reading at the last (untrimmed) stream record, which is the oldest record in the shard.</li><li>9. Select the <b>Enable trigger</b> check box.</li></ol>	App developer

Task	Description	Skills required
	<p>10 For the remaining fields, keep the default values, and choose <b>Add</b>.</p> <p>After the listener is successfully attached to the DynamoDB table, it will be displayed on the Lambda designer page.</p>	
Publish and attach the EventSourceReward Lambda function.	To publish and attach the EventSourceReward Lambda function, repeat the steps in the previous two stories, selecting <b>cqrses-reward-cmd</b> from the <b>DynamoDB table</b> dropdown list.	App developer

### Test and validate the DynamoDB streams and Lambda trigger

Task	Description	Skills required
Test the stream and the Lambda trigger.	<ol style="list-style-type: none"> <li>1. In Visual Studio, navigate to AWS Explorer.</li> <li>2. Expand AWS Lambda, and choose the <b>CommandRe deemReward</b> function (double-click). In the function window that opens, you can test the function.</li> <li>3. In the <b>Request</b> text box, enter the request data in JavaScript Object Notation</li> </ol>	App developer

Task	Description	Skills required
	<p>(JSON) format. For an example request, see <b>Test data</b> in the <a href="#">Additional information</a> section.</p> <p>4. Choose <b>Invoke</b>.</p>	
<p>Validate, using the DynamoDB reward query table.</p>	<ol style="list-style-type: none"> <li>1. Open the <b>cqrse-reward-query</b> table.</li> <li>2. Check the points of the customer that redeemed the reward. The redeemed points should be subtracted from the customer's total aggregated points.</li> </ol>	<p>App developer</p>
<p>Validate, using CloudWatch Logs.</p>	<ol style="list-style-type: none"> <li>1. Navigate to CloudWatch and choose <b>Log groups</b>.</li> <li>2. The <b>/aws/lambda/EventSourceReward</b> log group contains the logs for the EventSourceReward trigger. All Lambda calls are logged, including the messages you placed in <code>context.Logger.LogLine</code> and <code>Console.WriteLine</code> in the Lambda code.</li> </ol>	<p>App developer</p>

Task	Description	Skills required
Validate the EventSourceCustomer trigger.	To validate the EventSourceCustomer trigger, repeat the steps in this epic, using the EventSourceCustomer trigger's respective customer table and CloudWatch logs.	App developer

## Related resources

### References

- [Visual Studio 2019 Community Edition downloads](#)
- [AWS Toolkit for Visual Studio download](#)
- [AWS Toolkit for Visual Studio User Guide](#)
- [Serverless on AWS](#)
- [DynamoDB Use Cases and Design Patterns](#)
- [Martin Fowler CQRS](#)
- [Martin Fowler Event Sourcing](#)

### Videos

- [AWS Toolkit for Visual Studio demo](#)
- [How do I create an access key ID for a new IAM user?](#)

## Additional information

### CQRS and event sourcing

#### CQRS

The CQRS pattern separates a single conceptual operations model, such as a data access object single CRUD (create, read, update, delete) model, into command and query operations models. The



command model refers to any operation, such as create, update, or delete, that changes the state. The query model refers to any operation that returns a value.

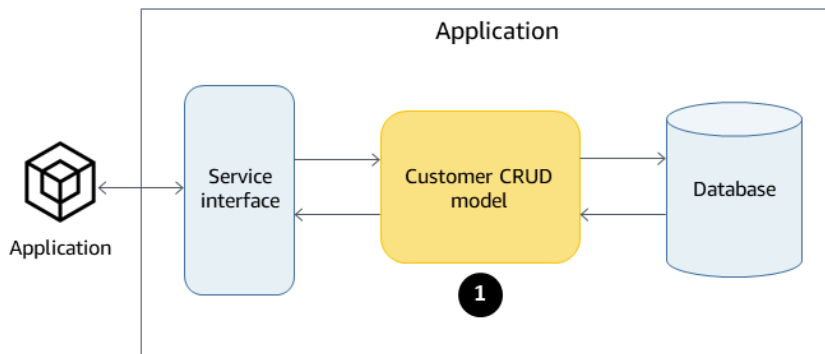

1. The Customer CRUD model includes the following interfaces:

- `Create Customer()`
- `UpdateCustomer()`
- `DeleteCustomer()`
- `AddPoints()`
- `RedeemPoints()`
- `GetVIPCustomers()`
- `GetCustomerList()`
- `GetCustomerPoints()`

As your requirements become more complex, you can move from this single-model approach. CQRS uses a command model and a query model to separate the responsibility for writing and reading data. That way, the data can be independently maintained and managed. With a clear separation of responsibilities, enhancements to each model do not impact the other. This separation improves maintenance and performance, and it reduces the complexity of the application as it grows.

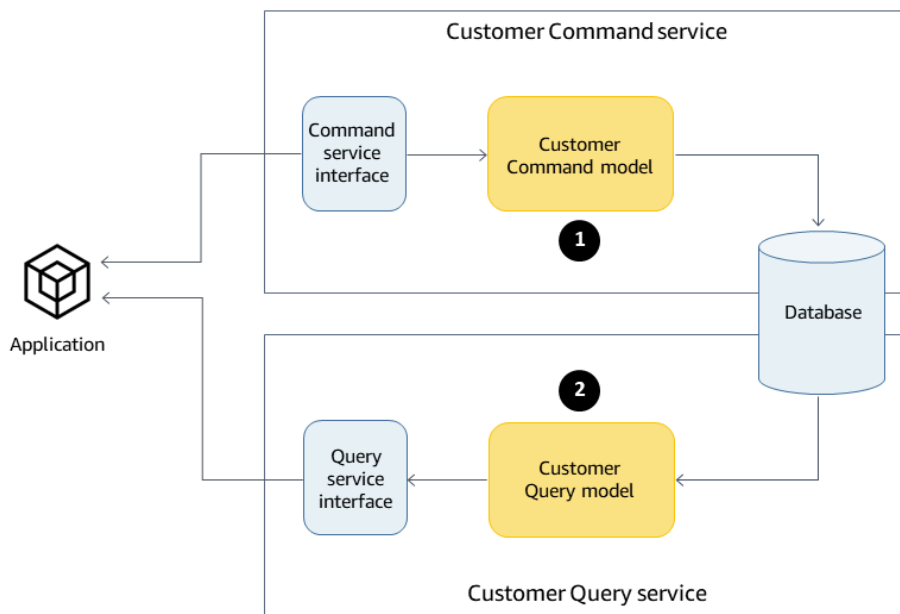

### 1. Interfaces in the Customer Command model:

- `Create Customer()`
- `UpdateCustomer()`
- `DeleteCustomer()`
- `AddPoints()`
- `RedeemPoints()`

### 2. Interfaces in the Customer Query model:

- `GetVIPCustomers()`
- `GetCustomerList()`
- `GetCustomerPoints()`
- `GetMonthlyStatement()`

For example code, see *Source code directory*.

The CQRS pattern then decouples the database. This decoupling leads to the total independence of each service, which is the main ingredient of microservice architecture.

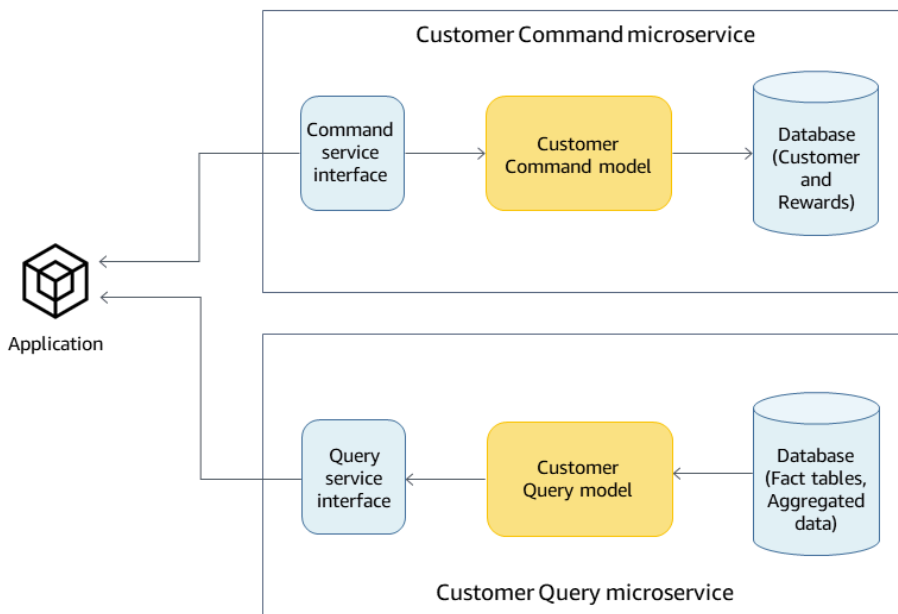

Using CQRS in the AWS Cloud, you can further optimize each service. For example, you can set different compute settings or choose between a serverless or a container-based microservice. You can replace your on-premises caching with Amazon ElastiCache. If you have an on-premises publish/subscribe messaging, you can replace it with Amazon Simple Notification Service (Amazon SNS). Additionally, you can take advantage of pay-as-you-go pricing and the wide array of AWS services that you pay only for what you use.

CQRS includes the following benefits:

- **Independent scaling** – Each model can have its scaling strategy adjusted to meet the requirements and demand of the service. Similar to high-performance applications, separating read and write enables the model to scale independently to address each demand. You can also add or reduce compute resources to address the scalability demand of one model without affecting the other.
- **Independent maintenance** – Separation of query and command models improves the maintainability of the models. You can make code changes and enhancements to one model without affecting the other.
- **Security** – It's easier to apply the permissions and policies to separate models for read and write.
- **Optimized reads** – You can define a schema that is optimized for queries. For example, you can define a schema for the aggregated data and a separate schema for the fact tables.
- **Integration** – CQRS fits well with event-based programming models.

- **Managed complexity** – The separation into query and command models is suited to complex domains.

When using CQRS, keep in mind the following caveats:

- The CQRS pattern applies only to a specific portion of an application and not the whole application. If implemented on a domain that does not fit the pattern, it can reduce productivity, increase risk, and introduce complexity.
- The pattern works best for frequently used models that have an imbalance read and write operations.
- For read-heavy applications, such as large reports that take time to process, CQRS gives you the option to select the right database and create a schema to store your aggregated data. This improves the response time of reading and viewing the report by processing the report data only one time and dumping it in the aggregated table.
- For the write-heavy applications, you can configure the database for write operations and allow the command microservice to scale independently when the demand for write increases. For examples, see the `AWS.APG.CQRSES.CommandRedeemRewardLambda` and `AWS.APG.CQRSES.CommandAddRewardLambda` microservices.

### *Event sourcing*

The next step is to use event sourcing to synchronize the query database when a command is run. For example, consider the following events:

- A customer reward point is added that requires the customer total or aggregated reward points in the query database to be updated.
- A customer's last name is updated in the command database, which requires the surrogate customer information in the query database to be updated.

In the traditional CRUD model, you ensure consistency of data by locking the data until it finishes a transaction. In event sourcing, the data are synchronized through publishing a series of events that will be consumed by a subscriber to update its respective data.

The event-sourcing pattern ensures and records a full series of actions taken on the data and publishes it through a sequence of events. These events represent a set of changes to the data that subscribers of that event must process to keep their record updated. These events are consumed

by the subscriber, synchronizing the data on the subscriber's database. In this case, that's the query database.

The following diagram shows event sourcing used with CQRS on AWS.

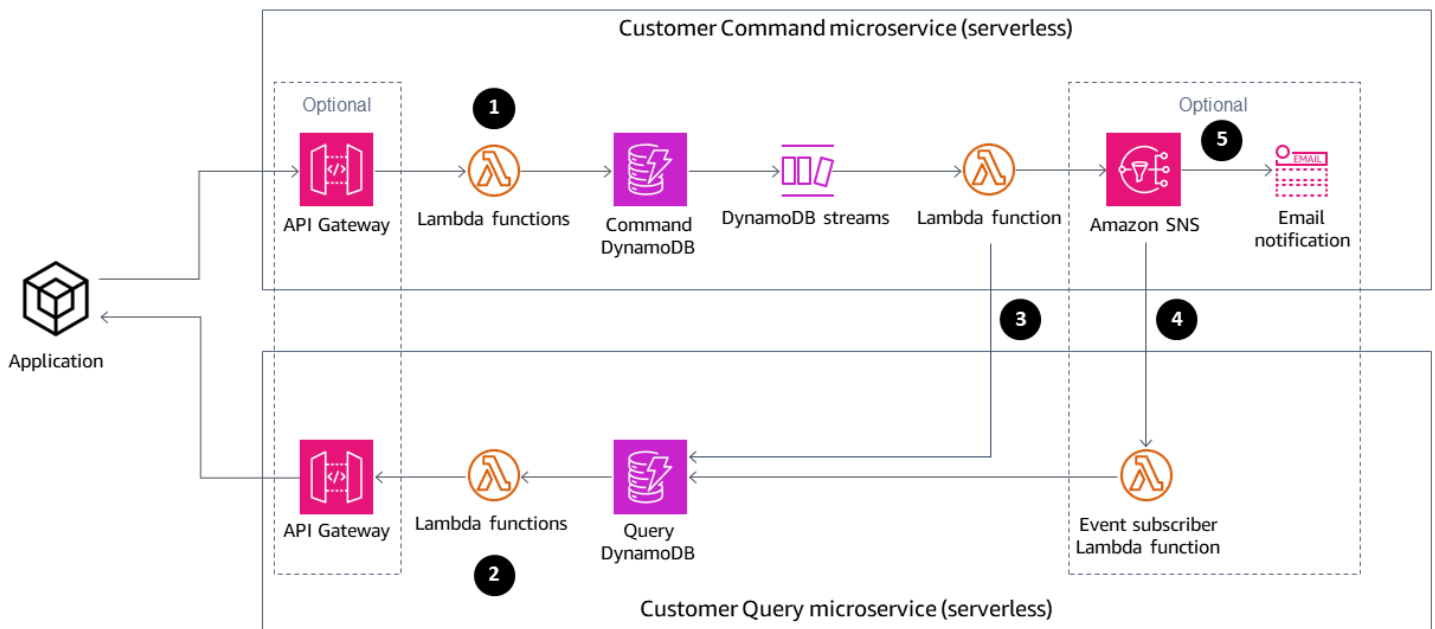

1. Command Lambda functions perform write operations, such as create, update, or delete, on the database.
2. Query Lambda functions perform read operations, such as get or select, on the database.
3. This Lambda function processes the DynamoDB streams from the Command database and updates the Query database for the changes. You can also use this function also to publish a message to Amazon SNS so that its subscribers can process the data.
4. (Optional) The Lambda event subscriber processes the message published by Amazon SNS and updates the Query database.
5. (Optional) Amazon SNS sends email notification of the write operation.

On AWS, the query database can be synchronized by DynamoDB Streams. DynamoDB captures a time-ordered sequence of item-level modifications in a DynamodbDB table in near-real time and durably stores the information within 24 hours.

Activating DynamoDB Streams enables the database to publish a sequence of events that makes the event sourcing pattern possible. The event sourcing pattern adds the event subscriber. The event subscriber application consumes the event and processes it depending on the subscriber's

responsibility. In the previous diagram, the event subscriber pushes the changes to the Query DynamoDB database to keep the data synchronized. The use of Amazon SNS, the message broker, and the event subscriber application keeps the architecture decoupled.

Event sourcing includes the following benefits:

- Consistency for transactional data
- A reliable audit trail and history of the actions, which can be used to monitor actions taken in the data
- Allows distributed applications such as microservices to synchronize their data across the environment
- Reliable publication of events whenever the state changes
- Reconstructing or replaying of past states
- Loosely coupled entities that exchange events for migration from a monolithic application to microservices
- Reduction of conflicts caused by concurrent updates; event sourcing avoids the requirement to update objects directly in the data store
- Flexibility and extensibility from decoupling the task and the event
- External system updates
- Management of multiple tasks in a single event

When using event sourcing, keep in mind the following caveats:

- Because there is some delay in updating data between the source subscriber databases, the only way to undo a change is to add a compensating event to the event store.
- Implementing event sourcing has a learning curve since its different style of programming.

## Test data

Use the following test data to test the Lambda function after successful deployment.

### CommandCreate Customer

```
{ "Id":1501, "Firstname":"John", "Lastname":"Done", "CompanyName":"AnyCompany",  
  "Address": "USA", "VIP":true }
```

## CommandUpdate Customer

```
{ "Id":1501, "Firstname":"John", "Lastname":"Doe", "CompanyName":"Example Corp.",  
  "Address": "Seattle, USA", "VIP":true }
```

## CommandDelete Customer

Enter the customer ID as request data. For example, if the customer ID is 151, enter 151 as request data.

```
151
```

## QueryCustomerList

This is blank. When it is invoked, it will return all customers.

## CommandAddReward

This will add 40 points to customer with ID 1 (Richard).

```
{  
  "Id":10101,  
  "CustomerId":1,  
  "Points":40  
}
```

## CommandRedeemReward

This will deduct 15 points to customer with ID 1 (Richard).

```
{  
  "Id":10110,  
  "CustomerId":1,  
  "Points":15  
}
```

## QueryReward

Enter the ID of the customer. For example, enter 1 for Richard, 2 for Arnav, and 3 for Shirley.

## Source code directory

Use the following table as a guide to the directory structure of the Visual Studio solution.

### *CQRS On-Premises Code Sample solution directory*

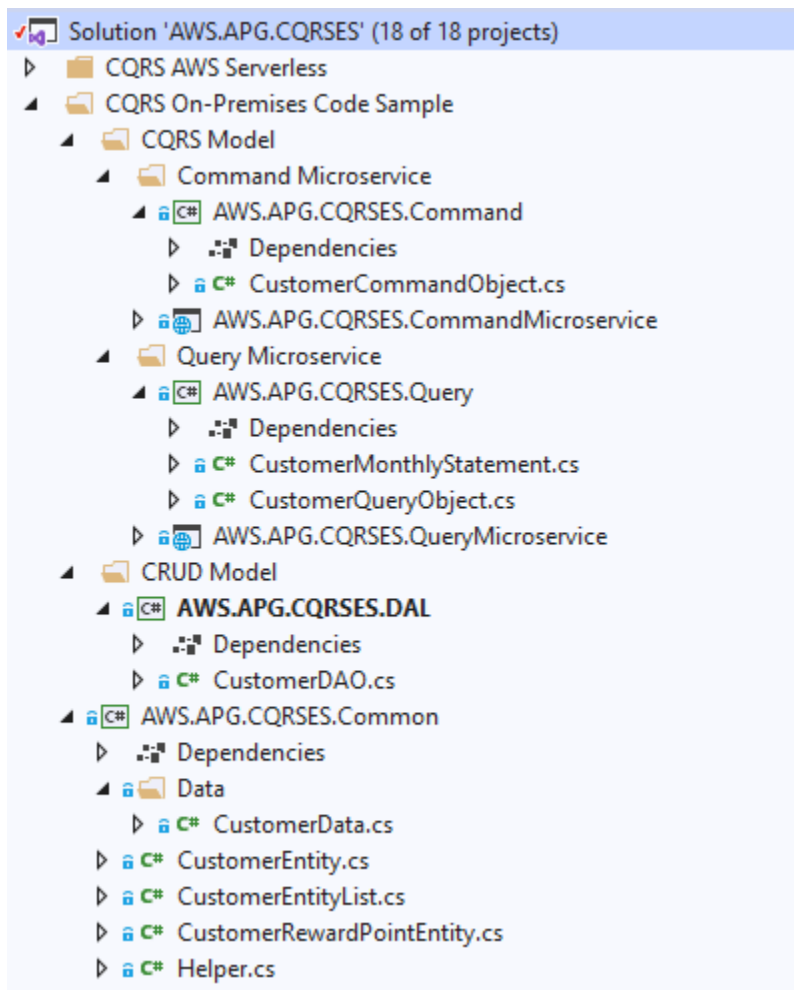

## Customer CRUD model

CQRS On-Premises Code Sample\CRUD Model\AWS.APG.CQRSES.DAL project

## CQRS version of the Customer CRUD model

- Customer command: CQRS On-Premises Code Sample\CQRS Model\Command Microservice\AWS.APG.CQRSES.Commandproject



- Customer query: CQRS On-Premises Code Sample\CQRS Model\Query Microservice \AWS.APG.CQRSES.Query project

## Command and Query microservices

The Command microservice is under the solution folder CQRS On-Premises Code Sample \CQRS Model\Command Microservice:

- AWS.APG.CQRSES.CommandMicroservice ASP.NET Core API project acts as the entry point where consumers interact with the service.
- AWS.APG.CQRSES.Command .NET Core project is an object that hosts command-related objects and interfaces.

The query microservice is under the solution folder CQRS On-Premises Code Sample\CQRS Model\Query Microservice:

- AWS.APG.CQRSES.QueryMicroservice ASP.NET Core API project acts as the entry point where consumers interact with the service.
- AWS.APG.CQRSES.Query .NET Core project is an object that hosts query-related objects and interfaces.

*CQRS AWS Serverless code solution directory*

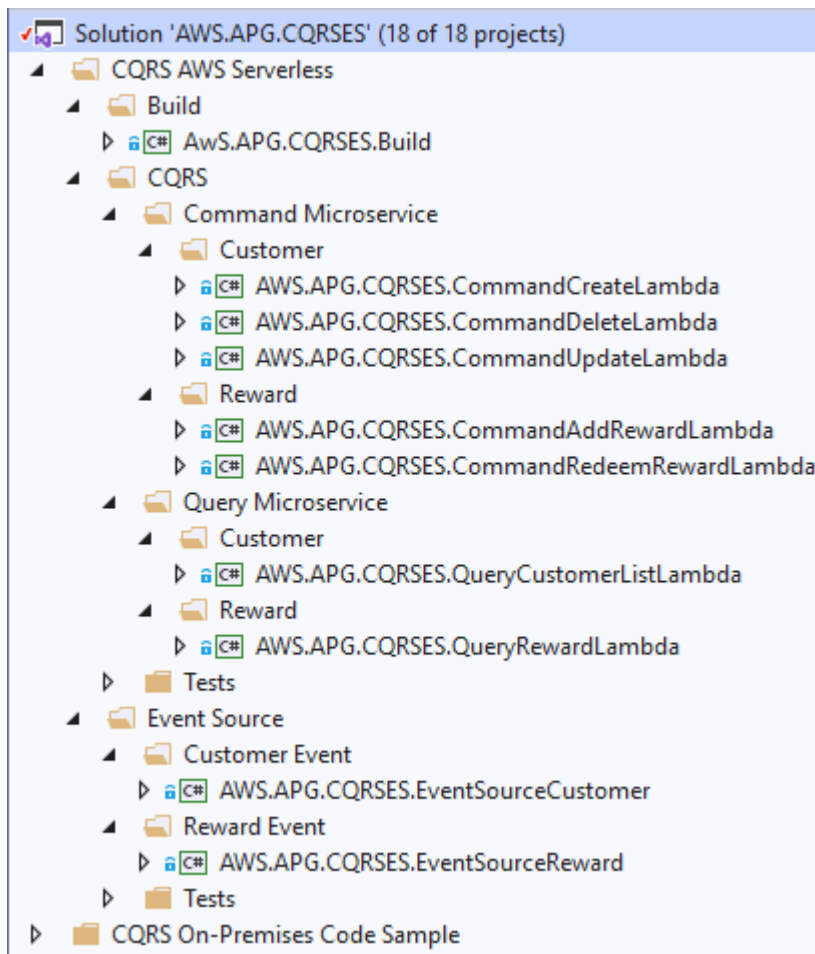

This code is the AWS version of the on-premises code using AWS serverless services.

In C# .NET Core, each Lambda function is represented by one .NET Core project. In this pattern's example code, there is a separate project for each interface in the command and query models.

### CQRS using AWS services

You can find the root solution directory for CQRS using AWS serverless services is in the `CQRS\AWS Serverless\CQRS` folder. The example includes two models: Customer and Reward.

The command Lambda functions for Customer and Reward are under `CQRS\Command Microservice\Customer` and `CQRS\Command Microservice\Reward` folders. They contain the following Lambda projects:

- Customer command: `CommandCreateLambda`, `CommandDeleteLambda`, and `CommandUpdateLambda`
- Reward command: `CommandAddRewardLambda` and `CommandRedeemRewardLambda`

The query Lambda functions for Customer and Reward are found under the CQRS\QueryMicroservice\Customer and CQRS\QueryMicroservice\Reward folders. They contain the QueryCustomerListLambda and QueryRewardLambda Lambda projects.

### **CQRS test project**

The test project is under the CQRS\Tests folder. This project contains a test script to automate testing the CQRS Lambda functions.

### **Event sourcing using AWS services**

The following Lambda event handlers are initiated by the Customer and Reward DynamoDB streams to process and synchronize the data in query tables.

- The EventSourceCustomer Lambda function is mapped to the Customer table (cqrses-customer-cmd) DynamoDB stream.
- The EventSourceReward Lambda function is mapped to the Reward table (cqrses-reward-cmd) DynamoDB stream.

## **Attachments**

To access additional content that is associated with this document, unzip the following file:

[attachment.zip](#)

## More patterns

- [Access container applications privately on Amazon EKS using AWS PrivateLink and a Network Load Balancer](#)
- [Automate adding or updating Windows registry entries using AWS Systems Manager](#)
- [Automate cross-Region failover and failback by using DR Orchestrator Framework](#)
- [Automate migration strategy identification and planning using AppScore](#)
- [Automatically build and deploy a Java application to Amazon EKS using a CI/CD pipeline](#)
- [Automatically build CI/CD pipelines and Amazon ECS clusters for microservices using AWS CDK](#)
- [Back up and archive mainframe data to Amazon S3 using BMC AMI Cloud Data](#)
- [Chain AWS services together using a serverless approach](#)
- [Containerize mainframe workloads that have been modernized by Blu Age](#)
- [Continuously deploy a modern AWS Amplify web application from an AWS CodeCommit repository](#)
- [Convert and unpack EBCDIC data to ASCII on AWS by using Python](#)
- [Convert mainframe data files with complex record layouts using Micro Focus](#)
- [Create a pipeline and AMI using CodePipeline and HashiCorp Packer](#)
- [Create a pipeline and deploy artifact updates to on-premises EC2 instances using CodePipeline](#)
- [Deploy and debug Amazon EKS clusters](#)
- [Deploy containers by using Elastic Beanstalk](#)
- [Emulate Oracle DR by using a PostgreSQL-compatible Aurora global database](#)
- [Generate data insights by using AWS Mainframe Modernization and Amazon Q in QuickSight](#)
- [Identify duplicate container images automatically when migrating to an Amazon ECR repository](#)
- [Incrementally migrate from Amazon RDS for Oracle to Amazon RDS for PostgreSQL using Oracle SQL Developer and AWS SCT](#)
- [Integrate Stonebranch Universal Controller with AWS Mainframe Modernization](#)
- [Manage AWS Service Catalog products in multiple AWS accounts and AWS Regions](#)
- [Migrate an AWS member account from AWS Organizations to AWS Control Tower](#)
- [Migrate and replicate VSAM files to Amazon RDS or Amazon MSK using Connect from Precisely](#)
- [Migrate from SAP ASE to Amazon RDS for SQL Server using AWS DMS](#)
- [Migrate Oracle external tables to Amazon Aurora PostgreSQL-Compatible](#)

- [Modernize mainframe batch printing workloads on AWS by using Micro Focus Enterprise Server and LRS VPSX/MFI](#)
- [Modernize mainframe online printing workloads on AWS by using Micro Focus Enterprise Server and LRS VPSX/MFI](#)
- [Modernize mainframe output management on AWS by using OpenText Micro Focus Enterprise Server and LRS PageCenterX](#)
- [Move mainframe files directly to Amazon S3 using Transfer Family](#)
- [Optimize AWS App2Container generated Docker images](#)
- [Replicate mainframe databases to AWS by using Precisely Connect](#)
- [Run Amazon ECS tasks on Amazon WorkSpaces with Amazon ECS Anywhere](#)
- [Send telemetry data from AWS Lambda to OpenSearch for real-time analytics and visualization](#)
- [Set up a Helm v3 chart repository in Amazon S3](#)
- [Set up AWS CloudFormation drift detection in a multi-Region, multi-account organization](#)
- [Structure a Python project in hexagonal architecture using AWS Lambda](#)
- [Upgrade SAP Pacemaker clusters from ENSA1 to ENSA2](#)
- [Use CloudEndure for disaster recovery of an on-premises database](#)
- [Validate Account Factory for Terraform \(AFT\) code locally](#)

# Multi account strategy

## Topics

- [Set up AWS CloudFormation drift detection in a multi-Region, multi-account organization](#)
- [More patterns](#)

# Set up AWS CloudFormation drift detection in a multi-Region, multi-account organization

Created by Ram Kandaswamy (AWS)

**Environment:** Production

**Technologies:** Multi account strategy; Infrastructure; Modernization

**Workload:** All other workloads

**AWS services:** Amazon SNS; AWS Config; AWS Lambda; AWS CloudFormation

## Summary

Customers on Amazon Web Services (AWS) are often looking for an efficient way to detect resource configuration mismatches, including drift in AWS CloudFormation stacks, and fix them as soon as possible. This is especially the case when AWS Control Tower is used.

This pattern provides a prescriptive solution that efficiently solves the problem by using consolidated resource configuration changes and acting on those changes to generate results. The solution is designed for scenarios where there are several AWS CloudFormation stacks created in more than one AWS Region, or in more than one account, or a combination of both. The goals of the solution are the following:

- Simplify the drift detection process
- Set up notification and alerting
- Set up consolidated reporting

## Prerequisites and limitations

### Prerequisites

- AWS Config enabled in all the Regions and accounts that must be monitored

## Limitations

- The report generated supports only the comma-separated values (CSV) and JSON output formats.

## Architecture

The following diagram shows AWS Organizations set up with multiple accounts. AWS Config rules communicate between the accounts.

The workflow includes the following steps:

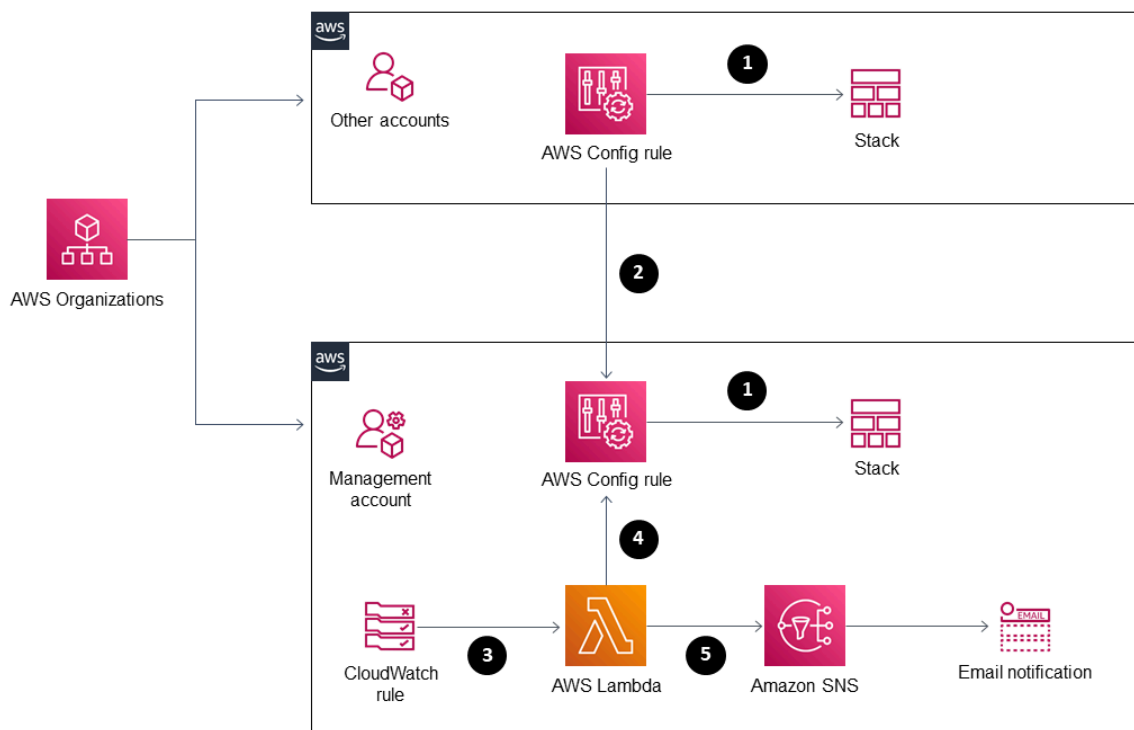

1. The AWS Config rule detects drift.
2. Drift detection results that are found in other accounts are sent to the management account.
3. The Amazon CloudWatch rule calls an AWS Lambda function.
4. The Lambda function queries the AWS Config rule for aggregated results.
5. The Lambda function notifies Amazon Simple Notification Service (Amazon SNS), which sends email notification of the drift.



## Automation and scale

The solution presented here can scale for both additional Regions and accounts.

## Tools

### AWS services

[AWS Config](#) provides a detailed view of the configuration of AWS resources in your AWS account. This includes how the resources are related to one another and how they were configured in the past so that you can see how the configurations and relationships change over time.

[Amazon CloudWatch](#) helps you monitor the metrics of your AWS resources and the applications you run on AWS in real time.

[AWS Lambda](#) is a compute service that helps you run code without needing to provision or manage servers. It runs your code only when needed and scales automatically, so you pay only for the compute time that you use.

[Amazon Simple Notification Service \(Amazon SNS\)](#) helps you coordinate and manage the exchange of messages between publishers and clients, including web servers and email addresses.

## Epics

### Automate drift detection for AWS CloudFormation

Task	Description	Skills required
Create the aggregator.	<ol style="list-style-type: none"><li>1. Sign in to the AWS Management Console and open the AWS Config console at <a href="https://console.aws.amazon.com/config">https://console.aws.amazon.com/config</a>.</li><li>2. Create an aggregator in the management account.</li><li>3. Ensure that data replication is turned on so that</li></ol>	Cloud architect

Task	Description	Skills required
	<p>AWS Config can fetch data from the source accounts.</p> <p>4. Select all applicable Regions and accounts. You can select accounts based on AWS Organizations. We recommend this approach because new accounts in the organization are automatically part of the aggregator.</p>	
Create an AWS managed rule.	<p>Add the <code>cloudformation-stack-drift-detection-check</code> AWS managed rule. The rule needs one parameter value: <code>cloudformationArn</code> .</p> <p>Enter the IAM role Amazon Resource Name (ARN) that has permissions to detect stack drift. The role must have a trust policy that enables AWS Config to assume the role.</p>	Cloud architect

Task	Description	Skills required
Create the advanced query section of the aggregator.	<p>To fetch drifted stacks from multiple sources, create the following query:</p> <pre>SELECT resourceId, configuration.driftInformation.stackDriftStatus WHERE resourceType = 'AWS::CloudFormation::Stack' AND configuration.driftInformation.stackDriftStatus IN ('DRIFTED')</pre>	Cloud architect, Developer
Automate running the query and publish.	<ol style="list-style-type: none"><li>1. Create a Lambda function by using the code that is attached. Lambda will publish the results to an SNS topic that is provided as an environment variable in the Lambda function.</li><li>2. To receive alerts, create an email subscription to the SNS topic.</li></ol>	Cloud architect, Developer
Create a CloudWatch rule.	Create a schedule-based CloudWatch rule to call the Lambda function, which is responsible for alerting.	Cloud architect

## Related resources

### Resources

- [What Is AWS Config?](#)
- [Multi-account multi-Region data aggregation](#)
- [Detecting unmanaged configuration changes to stacks and resources](#)
- [IAM: Pass an IAM role to a specific AWS service](#)
- [What is Amazon SNS?](#)

## Additional information

### Considerations

We recommend using the solution presented in this pattern instead of using custom solutions that involve API calls at specific intervals to initiate drift detection on each CloudFormation stack or stack set. Custom solutions that use API calls at specific intervals can lead to a large number of API calls and affect performance. Because of the number of API calls, throttling can occur. Another potential issue is a delay in detection if resource changes are identified based on schedule only.

Because stack sets are made of stacks, you can use this solution. Stack instance details are also available as part of the solution.

## Attachments

To access additional content that is associated with this document, unzip the following file: [attachment.zip](#)

## More patterns

- [Centralize monitoring by using Amazon CloudWatch Observability Access Manager](#)
- [Implement a Gitflow branching strategy for multi-account DevOps environments](#)
- [Implement a GitHub Flow branching strategy for multi-account DevOps environments](#)
- [Implement a Trunk branching strategy for multi-account DevOps environments](#)

# Networking

## Topics

- [Automate the setup of inter-Region peering with AWS Transit Gateway](#)
- [Centralize network connectivity using AWS Transit Gateway](#)
- [Configure HTTPS encryption for Oracle JD Edwards EnterpriseOne on Oracle WebLogic by using an Application Load Balancer](#)
- [Connect to Application Migration Service data and control planes over a private network](#)
- [Create Infoblox objects using AWS CloudFormation custom resources and Amazon SNS](#)
- [Customize Amazon CloudWatch alerts for AWS Network Firewall](#)
- [Deploy resources in an AWS Wavelength Zone by using Terraform](#)
- [Migrate DNS records in bulk to an Amazon Route 53 private hosted zone](#)
- [Modify HTTP headers when you migrate from F5 to an Application Load Balancer on AWS](#)
- [Peer VPCs in different AWS Regions by using AWS Transit Gateway](#)
- [Privately access a central AWS service endpoint from multiple VPCs](#)
- [Create a report of Network Access Analyzer findings for inbound internet access in multiple AWS accounts](#)
- [Tag Transit Gateway attachments automatically using AWS Organizations](#)
- [Verify that ELB load balancers require TLS termination](#)
- [View AWS Network Firewall logs and metrics by using Splunk](#)
- [More patterns](#)

# Automate the setup of inter-Region peering with AWS Transit Gateway

Created by Ram Kandaswamy (AWS)

**Environment:** Production

**Technologies:** Networking;  
Hybrid cloud

**AWS services:** AWS Transit Gateway; AWS Step Functions ; AWS Lambda

## Summary

AWS Transit Gateway connects virtual private clouds (VPCs) and on-premises networks through a central hub. Transit Gateway traffic always stays on the global Amazon Web Services (AWS) backbone and doesn't traverse the public internet, which reduces threat vectors, such as common exploits and distributed denial of service (DDoS) attacks.

If you need to communicate between two or more AWS Regions, you can use inter-Region Transit Gateway peering to establish peering connections between transit gateways in different Regions. However, manually configuring inter-Region peering with Transit Gateway can be a time-consuming process that has multiple steps. This pattern provides an automated process to remove these manual steps by using code to perform the peering. You can use this approach if you have to repeatedly configure several Regions and AWS accounts during a multi-Region organization setup.

This pattern uses an AWS CloudFormation stack that includes the AWS Step Functions workflow, AWS Lambda functions, AWS Identity and Access Management (IAM) roles, and log groups in Amazon CloudWatch Logs. You can then start a Step Functions execution and create the inter-Region peering connection for your transit gateways.

## Prerequisites and limitations

### Prerequisites

- An active AWS account.
- An existing Amazon Simple Storage Service (Amazon S3) bucket.
- Transit gateways, created and configured in the requestor Region and the acceptor Regions. The *requester* Region is where a peering request is originated and the *acceptor* Regions accept the

peering request. For more information about this, see [Creating and accepting a VPC peering connection](#) in the Amazon VPC documentation.

- VPCs, installed and configured in the acceptor and requester Regions. For steps to create a VPC, see [Create the VPC](#) from [Get Started with Amazon VPC](#) in the Amazon VPC documentation.
- The VPCs must use the `addToTransitGateway` tag and `true` value.
- Security groups and network access control lists (ACLs) for your VPCs, configured according to your requirements. For more information about this, see [Security groups for your VPC](#) and [Network ACLs](#) in the Amazon VPC documentation.

## AWS Regions and limitations

- Only certain AWS Regions support inter-Region peering. For a full list of Regions that support inter-Region peering, see the [AWS Transit Gateway FAQs](#).
- In the attached sample code, the requestor Region is assumed to be `us-east-2`, and the acceptor Region is assumed to be `us-west-2`. If you want to configure different Regions, you must edit these values in all Python files. To implement a more complex setup that involves more than two Regions, you can change the Step Function to pass the Regions as a parameter to the Lambda function and run the function for each combination.

## Architecture



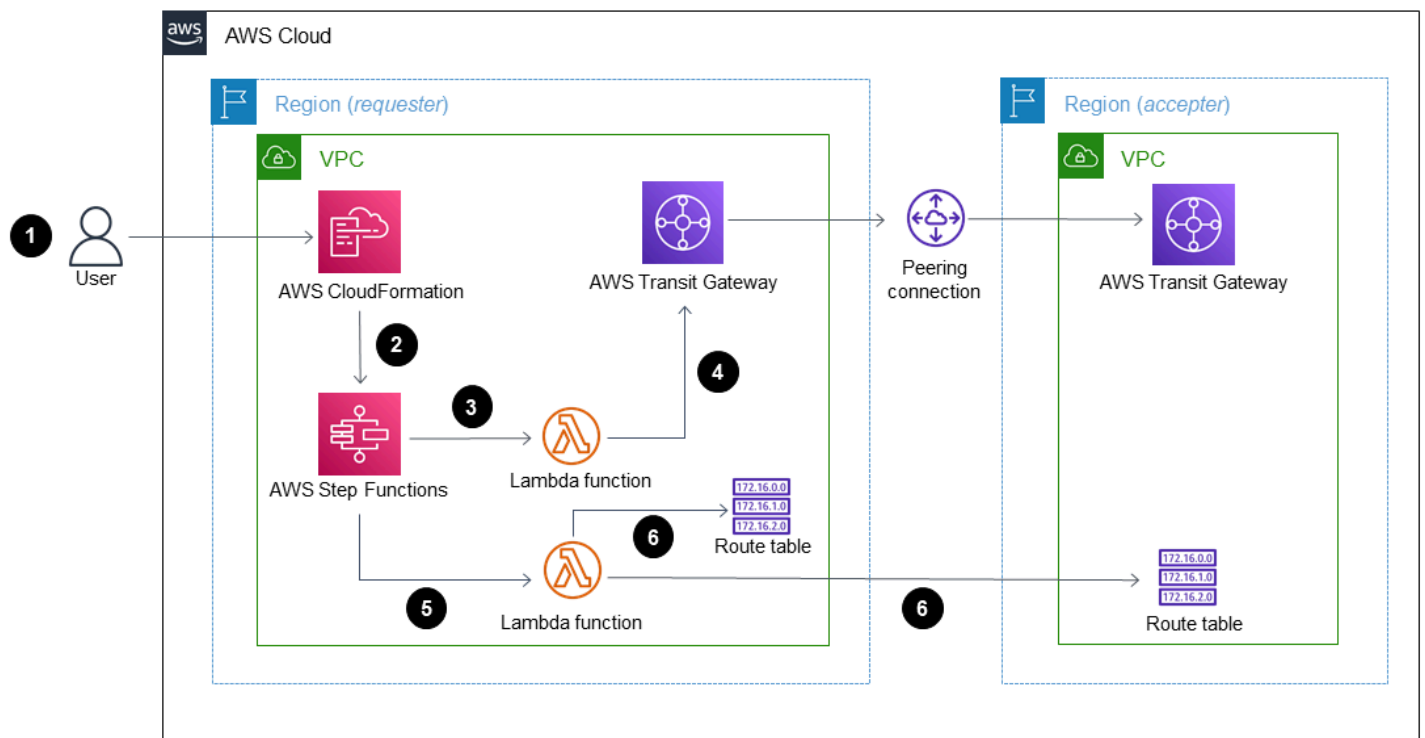

The diagram shows a workflow with the following steps:

1. The user creates an AWS CloudFormation stack.
2. AWS CloudFormation creates a Step Functions state machine that uses a Lambda function. For more information about this, see [Creating a Step Functions state machine that uses Lambda](#) in the AWS Step Functions documentation.
3. Step Functions calls a Lambda function for peering.
4. The Lambda function creates a peering connection between transit gateways.
5. Step Functions calls a Lambda function for route table modifications.
6. The Lambda function modifies the route tables by adding the Classless Inter-Domain Routing (CIDR) block of the VPCs.

## Step Functions workflow

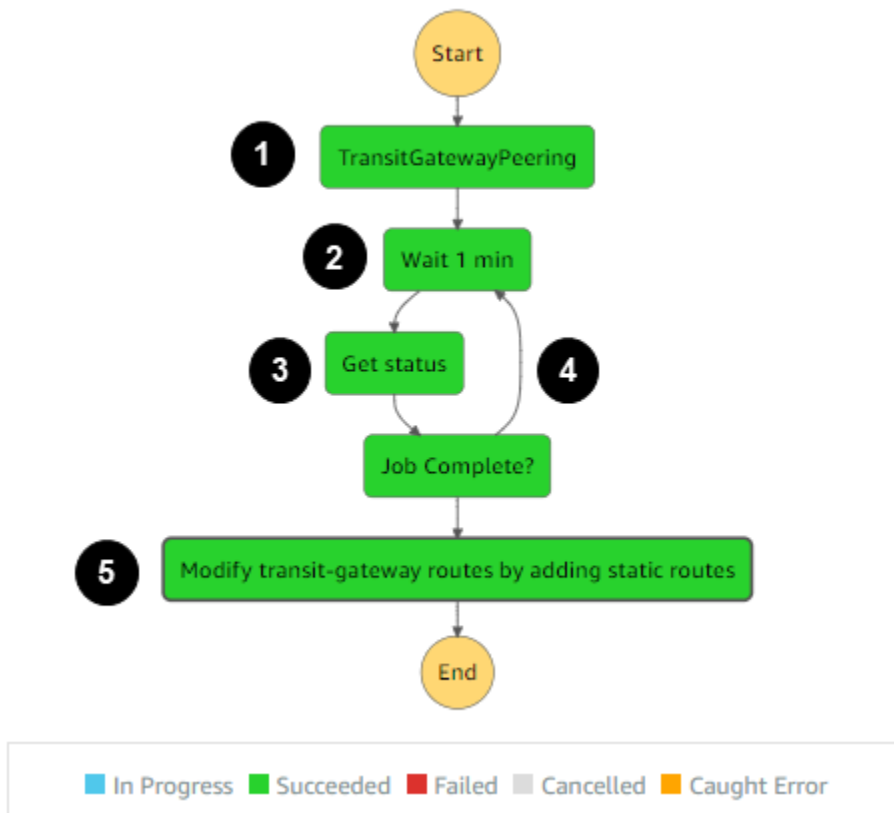

The diagram shows the following Step Functions workflow:

1. The Step Functions workflow calls the Lambda function for the transit gateway peering.
2. There is a timer call to wait for one minute.
3. The peering status is retrieved and sent to the condition block. The block is responsible for the looping.
4. If the success condition is not met, the workflow is coded to enter the timer stage.
5. If the success condition is met, a Lambda function is called to modify the route tables. After this call, the Step Functions workflow ends.

## Tools

- [AWS CloudFormation](#) – AWS CloudFormation is a service that helps you model and set up your AWS resources.
- [Amazon CloudWatch Logs](#) – CloudWatch Logs helps you centralize the logs from all of your systems, applications, and AWS services that you use.

- [AWS Identity and Access Management \(IAM\)](#) – IAM is a web service for securely controlling access to AWS services.
- [AWS Lambda](#) – Lambda runs your code on a high-availability compute infrastructure and performs all of the administration of the compute resources.
- [AWS Step Functions](#) – Step Functions makes it easy to coordinate the components of distributed applications as a series of steps in a visual workflow.

## Epics

### Automate peering

Task	Description	Skills required
Upload the attached files to your S3 bucket.	Sign in to the AWS Management Console, open the Amazon S3 console, and then upload the <code>modify-transit-gateway-routes.zip</code> , <code>peer-transit-gateway.zip</code> , and <code>get-transit-gateway-peering-status.zip</code> files (attached) to your S3 bucket.	General AWS
Create the AWS CloudFormation stack.	Run the following command to create an AWS CloudFormation stack using the <code>transit-gateway-peering.json</code> file (attached):  <pre>aws cloudformation create-stack --stack- name myteststack -- template-body file:// sampltemplate.json</pre>	DevOps engineer

Task	Description	Skills required
	<p>The AWS CloudFormation stack creates the Step Functions workflow, the Lambda functions, IAM roles, and CloudWatch log groups.</p> <p>Make sure that the AWS CloudFormation template refers to the S3 bucket that contains the files that you uploaded earlier.</p> <p><b>Note:</b> You can also create a stack by using the AWS CloudFormation console. For more information about this, see <a href="#">Creating a stack on the AWS CloudFormation console</a> in the AWS CloudFormation documentation.</p>	

Task	Description	Skills required
Start a new execution in Step Functions.	<p>Open the Step Functions console and start a new execution. Step Functions calls the Lambda function and creates the peering connection for the transit gateways. You don't need an input JSON file. Verify that an attachment is available and that the connection type is <b>Peering</b>.</p> <p>For more information about this, see <a href="#">Start a new execution</a> from <a href="#">Getting started with AWS Step Functions</a> in the AWS Steps Functions documentation.</p>	DevOps engineer, General AWS

Task	Description	Skills required
Verify the routes in the route tables.	<p>Inter-Region peering is established between the transit gateways. The route tables are updated with the peer Region VPC's IPv4 CIDR block range.</p> <p>Open the Amazon VPC console and choose the <b>Associations</b> tab in the route table that corresponds to the transit gateway attachment. Verify the VPC CIDR block range of the peered Regions.</p> <p>For detailed steps and instructions, see <a href="#">Associate a transit gateway route table</a> in the Amazon VPC documentation.</p>	Network administrator

## Related resources

- [Executions in Step Functions](#)
- [Transit gateway peering attachments](#)
- [Interconnecting VPCs across AWS Regions using AWS Transit Gateway - Demo](#) (video)

## Attachments

To access additional content that is associated with this document, unzip the following file: [attachment.zip](#)

# Centralize network connectivity using AWS Transit Gateway

Created by Mydhili Palagummi (AWS) and Nikhil Marrapu (AWS)

**Environment:** Production

**Technologies:** Networking

**AWS services:** AWS Transit Gateway; Amazon VPC

## Summary

This pattern describes the simplest configuration in which AWS Transit Gateway can be used to connect an on-premises network to virtual private clouds (VPCs) in multiple AWS accounts within an AWS Region. Using this setup, you can establish a hybrid network that connects multiple VPC networks in a Region and an on-premises network. This is accomplished by using a transit gateway and a virtual private network (VPN) connection to the on-premises network.

## Prerequisites and limitations

### Prerequisites

- An account for hosting network services, managed as a member account of an organization in AWS Organizations
- VPCs in multiple AWS accounts, without overlapping Classless Inter-Domain Routing (CIDR) blocks

### Limitations

This pattern does not support the isolation of traffic between certain VPCs or the on-premises network. All the networks attached to the transit gateway will be able to reach each other. To isolate traffic, you need to use custom route tables on the transit gateway. This pattern only connects the VPCs and on-premises network by using a single default transit gateway route table, which is the simplest configuration.

## Architecture

### Target technology stack

- AWS Transit Gateway

- AWS Site-to-Site VPN
- VPC
- AWS Resource Access Manager (AWS RAM)

## Target architecture

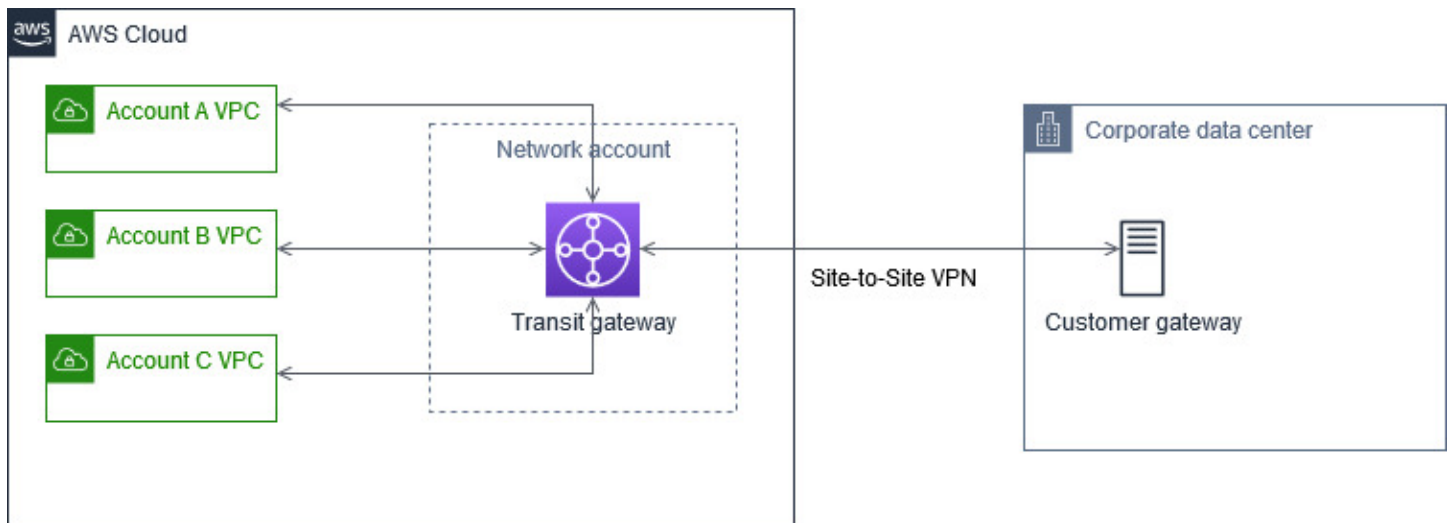

## Tools

### AWS services

- [AWS Resource Access Manager \(AWS RAM\)](#) helps you securely share your resources across your AWS accounts, organizational units, or your entire organization from AWS Organizations.
- [AWS Transit Gateway](#) is a central hub that connects virtual private clouds (VPCs) and on-premises networks.

## Epics

### Create a transit gateway in the network services account

Task	Description	Skills required
Create a transit gateway.	In the AWS account where you want to host network	Network administrator



Task	Description	Skills required
	<p>services, create a transit gateway in the target AWS Region. For instructions, see <a href="#">Create a transit gateway</a>.</p> <p>Note the following:</p> <ul style="list-style-type: none"> <li>• Select <b>Default route table association</b>.</li> <li>• Select <b>Default route table propagation</b>.</li> </ul>	

### Connect the transit gateway to your on-premises network

Task	Description	Skills required
<p>Set up a customer gateway device for the VPN connection.</p>	<p>The customer gateway device is attached on the on-premises side of the Site-to-Site VPN connection between the transit gateway and your on-premises network. For more information, see <a href="#">Your customer gateway device</a> in the AWS Site-to-Site VPN documentation. Identify or launch a supported on-premises customer device and note its public IP address. VPN configuration is completed later in this epic.</p>	<p>Network administrator</p>
<p>In the network services account, create a VPN attachment to the transit gateway.</p>	<p>To set up a connection, create a VPN attachment for the transit gateway. For instructions, see <a href="#">Create a VPN attachment</a>.</p>	<p>Network administrator</p>

Task	Description	Skills required
	ons, see <a href="#">Transit gateway VPN attachments</a> .	
Configure the VPN on the customer gateway device in your on-premises network.	Download the configuration file for the Site-to-Site VPN connection associated with the transit gateway and configure VPN settings on the customer gateway device. For instructions, see <a href="#">Download the configuration file</a> .	Network administrator

## Share the transit gateway in the network services account to other AWS accounts or your organization

Task	Description	Skills required
In the AWS Organizations management account, turn on sharing.	To share the transit gateway with your organization or with certain organizational units, turn on sharing in AWS Organizations. Otherwise , you would need to share the transit gateway for each account individually. For instructions, see <a href="#">Enable resource sharing within AWS Organizations</a> .	AWS systems administrator
Create the transit gateway resource share in the network services account.	To allow VPCs in other AWS accounts within your organization to connect to the transit gateway, in the network services account, use the AWS RAM console	AWS systems administrator

Task	Description	Skills required
	to share the transit gateway resource. For instructions, see <a href="#">Create a resource share</a> .	

## Connect VPCs to the transit gateway

Task	Description	Skills required
Create VPC attachments in individual accounts.	In the accounts to which the transit gateway has been shared, create transit gateway VPC attachments. For instructions, see <a href="#">Create a transit gateway attachment to a VPC</a> .	Network administrator
Accept the VPC attachment requests.	In the network services account, accept the transit gateway VPC attachment requests. For instructions, see <a href="#">Accept a shared attachment</a> .	Network administrator

## Configure routing

Task	Description	Skills required
Configure routes in individual account VPCs.	In each individual account VPC, add routes to the on-premises network and to other VPC networks, using the transit gateway as the target. For instructions, see <a href="#">Add and remove routes from a route table</a> .	Network administrator

Task	Description	Skills required
Configure routes in the transit gateway route table.	Routes from VPCs and the VPN connection should be propagated and should appear in the transit gateway default route table. If needed, create any static routes (one example is static routes for the static VPN connection) in the transit gateway default route table. For instructions, see <a href="#">Create a static route</a> .	Network administrator
Add security group and network access control list (ACL) rules.	For the EC2 instances and other resources in the VPC, ensure that the security group rules and the network ACL rules allow traffic between VPCs as well as the on-premises network. For instructions, see <a href="#">Control traffic to resources using security groups</a> and <a href="#">Add and delete rules from an ACL</a> .	Network administrator

## Test connectivity

Task	Description	Skills required
Test connectivity between VPCs.	Ensure that network ACL and security groups allow Internet Control Message Protocol (ICMP) traffic, and then ping from instances in a VPC to another VPC that is	Network administrator

Task	Description	Skills required
	also connected to the transit gateway.	
Test connectivity between VPCs and the on-premises network.	Ensure that network ACL rules, security group rules, and any firewalls allow ICMP traffic, and then ping between the on-premises network and the EC2 instances in the VPCs. Network communication must be initiated from the on-premises network first to bring the VPN connection to UP status.	Network administrator

## Related resources

- [Building a scalable and secure multi VPC AWS Network Infrastructure](#) (AWS whitepaper)
- [Working with shared resources](#) (AWS RAM documentation)
- [Working with transit gateways](#) (AWS Transit Gateway documentation)

# Configure HTTPS encryption for Oracle JD Edwards EnterpriseOne on Oracle WebLogic by using an Application Load Balancer

Created by Thanigaivel Thirumalai (AWS)

**Environment:** Production

**Technologies:** Networking;  
Security, identity, compliance

**Workload:** Oracle

**AWS services:** AWS Certificate Manager (ACM); Elastic Load Balancing (ELB); Amazon Route 53

## Summary

This pattern explains how to configure HTTPS encryption for SSL offloading in Oracle JD Edwards EnterpriseOne on Oracle WebLogic workloads. This approach encrypts traffic between the user's browser and a load balancer to remove the encryption burden from the EnterpriseOne servers.

Many users scale the EnterpriseOne JAVA virtual machine (JVM) tier horizontally by using an [AWS Application Load Balancer](#). The load balancer serves as the single point of contact for clients, and distributes incoming traffic across multiple JVMs. Optionally, the load balancer can distribute the traffic across multiple Availability Zones and increase the availability of EnterpriseOne.

The process described in this pattern configures encryption between the browser and the load balancer instead of encrypting the traffic between the load balancer and the EnterpriseOne JVMs. This approach is referred to as *SSL offloading*. Offloading the SSL decryption process from the EnterpriseOne web or application server to the Application Load Balancer reduces the burden on the application side. After SSL termination at the load balancer, the unencrypted traffic is routed to the application on AWS.

[Oracle JD Edwards EnterpriseOne](#) is an enterprise resource planning (ERP) solution for organizations that manufacture, construct, distribute, service, or manage products or physical assets. JD Edwards EnterpriseOne supports various hardware, operating systems, and database platforms.

## Prerequisites and limitations

### Prerequisites

- An active AWS account
- An AWS Identity and Access Management (IAM) role that has permissions to make AWS service calls and manage AWS resources
- An SSL certificate

### Product versions

- This pattern was tested with Oracle WebLogic 12c, but you can also use other versions.

## Architecture

There are multiple approaches to perform SSL offloading. This pattern uses an Application Load Balancer and Oracle HTTP Server (OHS), as illustrated in the following diagram.

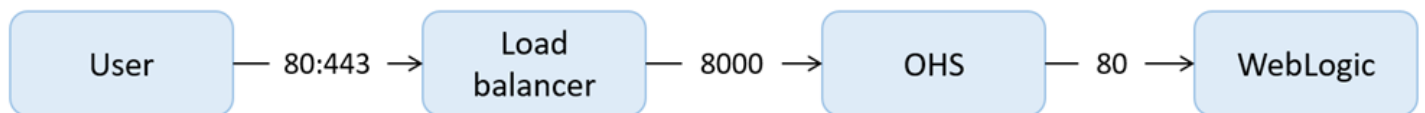

The following diagram shows the JD Edwards EnterpriseOne, Application Load Balancer, and Java Application Server (JAS) JVM layout.

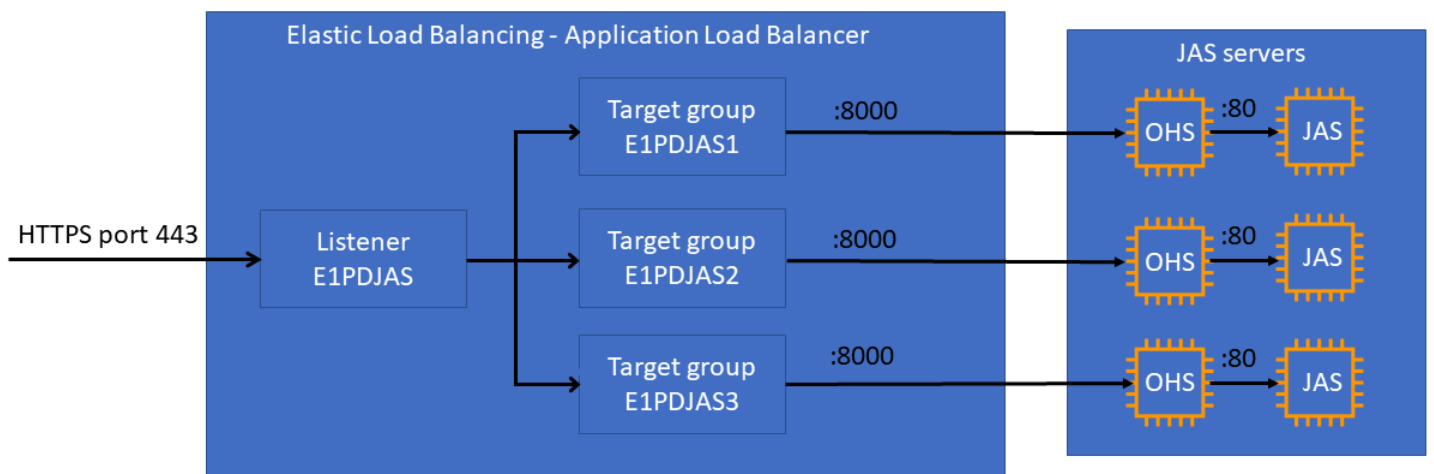

## Tools

### AWS services

- [Application Load Balancers](#) distribute incoming application traffic across multiple targets, such as Amazon Elastic Compute Cloud (Amazon EC2 instances), in multiple Availability Zones.
- [AWS Certificate Manager \(ACM\)](#) helps you create, store, and renew public and private SSL/TLS X.509 certificates and keys that protect your AWS websites and applications.
- [Amazon Route 53](#) is a highly available and scalable DNS web service.

## Best practices

- For ACM best practices, see the [ACM documentation](#).

## Epics

### Set up WebLogic and OHS

Task	Description	Skills required
Install and configure Oracle components.	<ol style="list-style-type: none"><li>1. Install Fusion Middleware Infrastructure by following the standard installation process. This program helps you install and configure a WebLogic domain. For instructions, see the <a href="#">Oracle documentation</a>.</li><li>2. Install OHS by following the standard installation process. For instructions, see the <a href="#">Oracle documentation</a>.</li><li>3. When installation is complete, start the</li></ol>	JDE CNC, WebLogic administrator



Task	Description	Skills required
	<p>configuration wizard (config.sh file) to configure OHS.</p> <ul style="list-style-type: none"><li>• You can update an existing domain or create a new domain. This pattern assumes that you're updating an existing domain.</li><li>• For <b>Available Templates</b>, choose <b>Oracle Enterprise Manager-Restricted JRF</b> and <b>Oracle HTTP Server (Restricted JRF)</b>. Selecting these Java Required Files (JRF) options eliminates the connection to an external database.</li><li>• For <b>Managed Servers, Clusters, Server Templates, Coherence Clusters, Machines, Assign Servers to Machines, Virtual targets</b>, and <b>Partitions</b>, accept the default configuration values and choose <b>Next</b> to move to the next category.</li><li>• Complete the configuration details (for example, administrator host and port, listen address and</li></ul>	

Task	Description	Skills required
	port, server name) for the OHS instance (for example, ohs1).	
Enable the WebLogic plugin at the domain level.	<p>The WebLogic plugin is required for load balancing. To enable the plugin:</p> <ol style="list-style-type: none"><li>1. Log in to the WebLogic administration console by using the link:  <code>http://&lt;WeblogicServer&gt;:&lt;Adminport&gt;/console</code></li><li>2. Choose <b>Lock &amp; Edit</b>, and then choose <b>Configuration, Web Applications</b>.</li><li>3. Choose the <b>WebLogic Plugin Enabled</b> (check box or dropdown option).</li><li>4. Choose <b>Save and Activate Changes</b>.</li></ol>	JDE CNC, WebLogic administrator

Task	Description	Skills required
Edit the configuration file.	<p>The <code>mod_wl_ohs.conf</code> file configures proxy requests from OHS to WebLogic.</p> <ol style="list-style-type: none"> <li>Edit this file. It's located at:           <pre>\$ORACLE_HOME/user_projects/domains/</pre> <p>For example:</p> <pre>/home/oracle/Oracl e/Middleware/Oracl e_Home/user_projec ts/domains/base_do main/config/fmwcon fig/components/OHS /instances/ohs1</pre> </li> <li>Add the WebLogic host (<code>WebLogicHost</code>) and port (<code>WebLogicPort</code>) values (This pattern assumes localhost and port 8000.)</li> <li>Add <code>WLProxySSL</code> and <code>WLProxySSLPassThrough</code> values as follows:</li> </ol> <pre>&lt;VirtualHost *:8000&gt; &lt;Location /jde&gt; WLSRequest On SetHandler weblogic- handler WebLogicHost localhost WebLogicPort 8000</pre>	JDE CNC, WebLogic administrator

Task	Description	Skills required
	<pre>WLProxySSL On WLProxySSLPassthrough   On &lt;/Location&gt; &lt;/VirtualHost&gt;</pre>	

Task	Description	Skills required
<p>Start OHS by using the Enterprise Manager.</p>	<ol style="list-style-type: none"> <li>1. Log in to Enterprise Manager Fusion Middleware by using the link:              <code>http://&lt;WeblogicServer&gt;:&lt;Adminport&gt;/em/</code> </li> <li>2. In <b>Target Navigation</b>, under <b>HTTP Server</b>, select the OHS instance (for example, ohs1).</li> <li>3. Choose <b>Shut Down</b> and <b>Start Up</b> to restart the OHS instance.</li> <li>4. When OHS setup is complete, you can connect to the EnterpriseOne HTML client by using your HTTP server host name with port 8000 instead of the EnterpriseOne server host name.           <ul style="list-style-type: none"> <li>• Old link: <code>http://&lt;Webserver&gt;:80/jde/owhtml</code></li> <li>• New link: <code>http://&lt;HTTP server or web server&gt;:8000/jde/owhtml</code></li> </ul> <p>If you use a port other than the default Oracle HTTP port, edit the <code>httpd.conf</code></p> </li> </ol>	<p>JDE CNC, WebLogic administrator</p>

Task	Description	Skills required
	<p>f file to add a listener for that port in two places:</p> <pre>[Listen] OHS_LISTEN N_PORT Listen 8000</pre> <p>and:</p> <pre># ServerName &lt;Weblogic Server1&gt;:8000</pre>	

## Configure the Application Load Balancer

Task	Description	Skills required
Set up a target group.	<ol style="list-style-type: none"> <li>1. Create a target group for the HTTP server port 8000.</li> <li>2. Register the targets under the target group with the same port.</li> <li>3. Check the status of the targets to confirm that they are healthy.</li> <li>4. Configure the health check settings as necessary.</li> </ol> <p>For detailed instructions, see the <a href="#">Elastic Load Balancing documentation</a>.</p>	AWS administrator
Set up the load balancer.	<ol style="list-style-type: none"> <li>1. Create an Application Load Balancer with default</li> </ol>	AWS administrator

Task	Description	Skills required
	<p>attributes and the required virtual private cloud (VPC), security groups, and subnets. For instructions, see the <a href="#">Elastic Load Balancing documentation</a>.</p> <p>2. Add a listener entry for HTTPS 443 and forward it to the target group that you created in the previous step. (For instructions, see the <a href="#">Elastic Load Balancing documentation</a>.) An HTTPS listener requires an SSL certificate. You can choose a certificate from ACM or upload one.</p> <p>3. For both listeners, enable stickiness by following the instructions in the <a href="#">Elastic Load Balancing documentation</a>.</p>	
Add a Route 53 (DNS) record.	(Optional) You can add an Amazon Route 53 DNS record for the subdomain. This record would point to your Application Load Balancer. For instructions, see the <a href="#">Route 53 documentation</a> .	AWS administrator

## Troubleshooting

Issue	Solution
HTTP server doesn't appear.	<p>If <b>HTTP Server</b> doesn't appear in the <b>Target Navigation</b> list on the Enterprise Manager console, follow these steps:</p> <ol style="list-style-type: none"><li>1. Under <b>WebLogic Domain, Administration</b>, choose <b>OHS Instances</b>.</li><li>2. Choose <b>Create</b> to create a new OHS instance.</li><li>3. Provide an instance name, and then choose <b>OK</b> to create the instance.</li></ol> <p>When the instance has been created and changes have been activated, you will be able to see the HTTP server in the <b>Target Navigation</b> panel.</p>

## Related resources

### AWS documentation

- [Application Load Balancers](#)
- [Working with public hosted zones](#)
- [Working with private hosted zones](#)

### Oracle documentation:

- [Overview of Oracle WebLogic Server Proxy Plug-In](#)
- [Installing WebLogic Server using the Infrastructure Installer](#)
- [Installing and Configuring Oracle HTTP Server](#)



# Connect to Application Migration Service data and control planes over a private network

Created by Dipin Jain (AWS) and Mike Kuznetsov (AWS)

**Environment:** PoC or pilot

**Technologies:** Networking;  
Migration

**AWS services:** AWS MGN;  
Amazon EC2; Amazon VPC;  
Amazon S3

## Summary

This pattern explains how you can connect to an AWS Application Migration Service (AWS MGN) data plane and control plane on a private, secured network by using interface VPC endpoints.

Application Migration Service is a highly automated lift-and-shift (rehost) solution that simplifies, expedites, and reduces the cost of migrating applications to AWS. It enables companies to rehost a large number of physical, virtual, or cloud servers without compatibility issues, performance disruption, or long cutover windows. Application Migration Service is available from the AWS Management Console. This enables seamless integration with other AWS services, such as AWS CloudTrail, Amazon CloudWatch, and AWS Identity and Access Management (IAM).

You can connect from a source data center to a data plane—that is, to a subnet that serves as a staging area for data replication in the destination VPC—over a private connection by using AWS VPN services, AWS Direct Connect, or VPC peering in Application Migration Service. You can also use [interface VPC endpoints](#) powered by AWS PrivateLink to connect to an Application Migration Service control plane over a private network.

## Prerequisites and limitations

### Prerequisites

- **Staging area subnet** – Before you set up Application Migration Service, create a subnet to be used as a staging area for data replicated from your source servers to AWS (that is, a data plane). You must specify this subnet in the [Replication Settings template](#) when you first access the Application Migration Service console. You can override this subnet for specific source servers in the Replication Settings template. Although you can use an existing subnet in your AWS account, we recommend that you create a new, dedicated subnet for this purpose.

- **Network requirements** – The replication servers that are launched by Application Migration Service in your staging area subnet have to be able to send data to the Application Migration Service API endpoint at `https://mgn.<region>.amazonaws.com/`, where `<region>` is the code for the AWS Region you are replicating to (for example, `https://mgn.us-east-1.amazonaws.com`). Amazon Simple Storage Service (Amazon S3) service URLs are required for downloading Application Migration Service software.
  - The AWS Replication Agent installer should have access to the S3 bucket URL of the AWS Region you are using with Application Migration Service.
  - The staging area subnet should have access to Amazon S3.
  - The source servers on which the AWS Replication Agent is installed must be able to send data to the replication servers in the staging area subnet and to the Application Migration Service API endpoint at `https://mgn.<region>.amazonaws.com/`.

The following table lists the required ports.

Source	Destination	Port	For more information, see
Source data center	Amazon S3 service URLs	443 (TCP)	<a href="#">Communication over TCP port 443</a>
Source data center	AWS Region-specific console address for Application Migration Service	443 (TCP)	<a href="#">Communication between the source servers and Application Migration Service over TCP port 443</a>
Source data center	Staging area subnet	1500 (TCP)	<a href="#">Communication between the source servers and the staging area subnet over TCP port 1500</a>
Staging area subnet	AWS Region-specific console address for Application Migration Service	443 (TCP)	<a href="#">Communication between the staging area subnet and Application Migration</a>

			<a href="#">Service over TCP port 443</a>
Staging area subnet	Amazon S3 service URLs	443 (TCP)	<a href="#">Communication over TCP port 443</a>
Staging area subnet	Amazon EC2 endpoint of the subnet's AWS Region	443 (TCP)	<a href="#">Communication over TCP port 443</a>

## Limitations

Application Migration Service isn't currently available in all AWS Regions and operating systems.

- [Supported AWS Regions](#)
- [Supported operating systems](#)

## Architecture

The following diagram illustrates the network architecture for a typical migration. For more information about this architecture, see the [Application Migration Service documentation](#) and the [Application Migration Service service architecture and network architecture video](#).

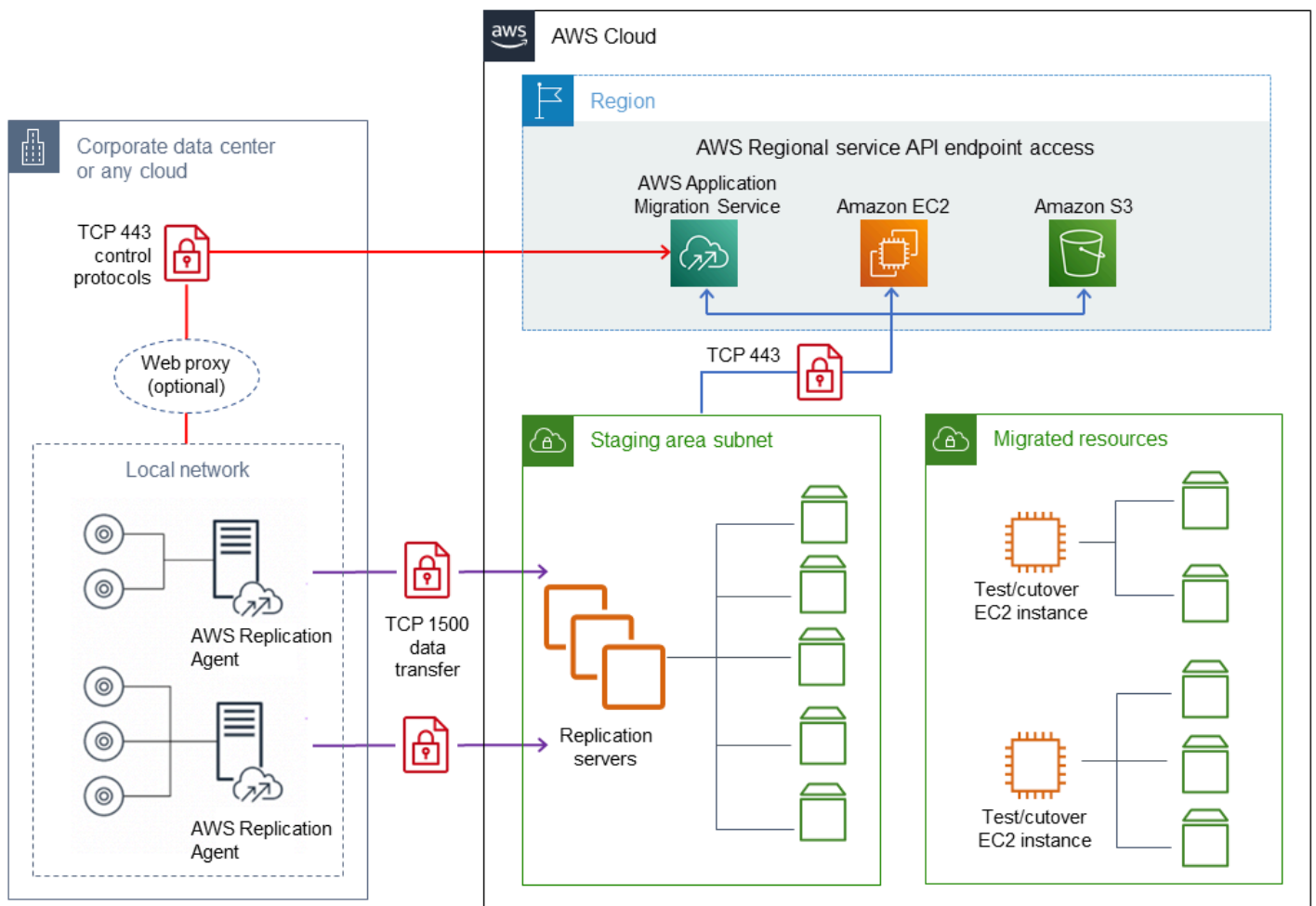

The following detailed view shows the configuration of interface VPC endpoints in the staging area VPC to connect Amazon S3 and Application Migration Service.

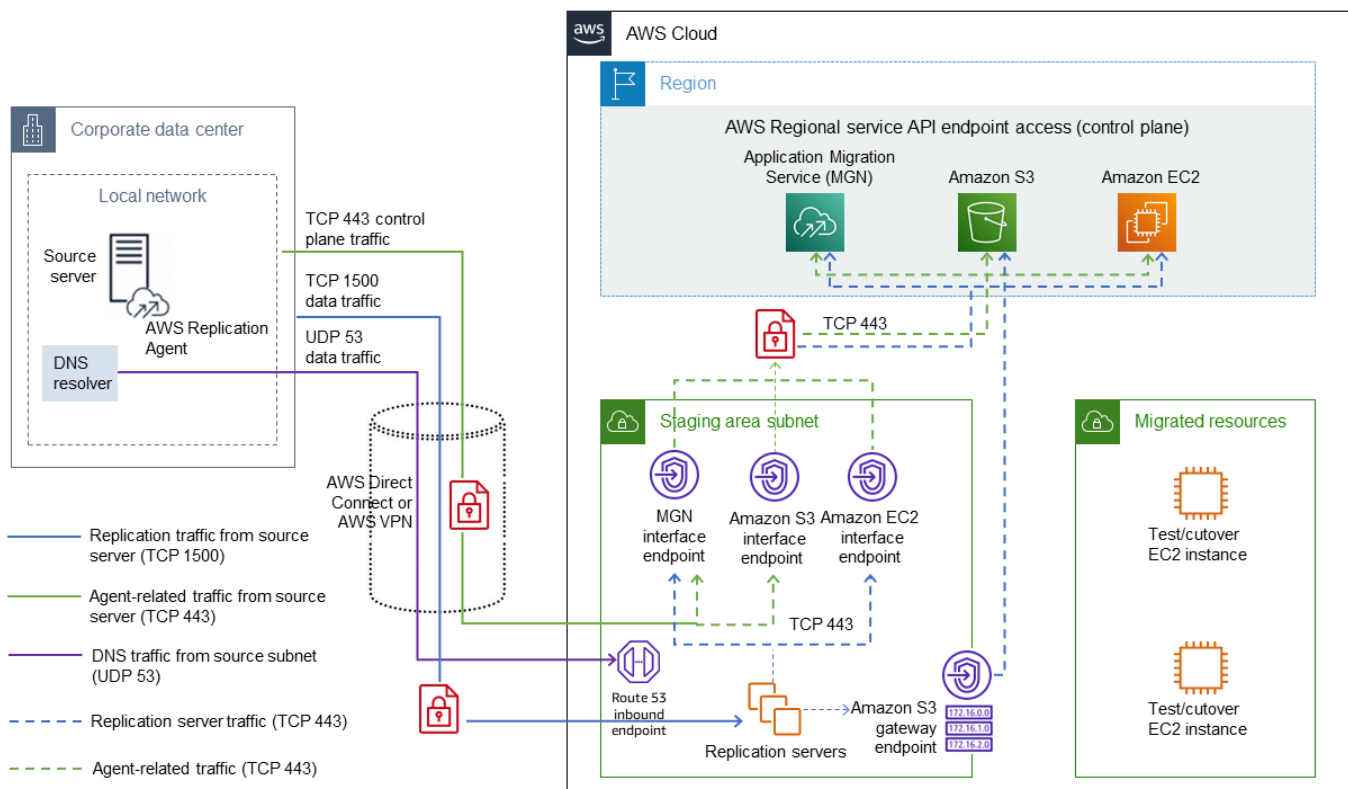

## Tools

- [AWS Application Migration Service](#) is an AWS service that simplifies, expedites, and reduces the cost of rehosting applications on AWS.
- [Interface VPC endpoints](#) enable you to connect to services that are powered by AWS PrivateLink without requiring an internet gateway, NAT device, VPN connection, or AWS Direct Connect connection. Instances in your VPC do not require public IP addresses to communicate with resources in the service. Traffic between your VPC and the other service does not leave the Amazon network.

## Epics

### Create endpoints for Application Migration Service, Amazon EC2, and Amazon S3

Task	Description	Skills required
Configure the interface endpoint for Application Migration Service.	<p>The source data center and staging area VPC connect privately to the Application Migration Service control plane through the interface endpoint that you create in the target staging area VPC. To create the endpoint:</p> <ol style="list-style-type: none"><li>1. Open the Amazon VPC console at <a href="https://console.aws.amazon.com/vpc/">https://console.aws.amazon.com/vpc/</a>.</li><li>2. In the navigation pane, choose <b>Endpoints, Create Endpoint</b>.</li><li>3. For <b>Service category</b>, choose <b>AWS services</b>.</li><li>4. For <b>Service Name</b>, enter <code>com.amazonaws.&lt;region&gt;.mgn</code>. For <b>Type</b>, choose <b>Interface</b>.</li><li>5. For <b>VPC</b>, select a target staging area VPC to create the endpoint.</li><li>6. For <b>Subnets</b>, select the subnets (Availability Zones) in which to create the endpoint network interfaces.</li></ol>	Migration lead

Task	Description	Skills required
	<ol style="list-style-type: none"><li>7. To turn on private DNS for the interface endpoint, in the <b>Additional settings</b> section, select <b>Enable DNS Name</b>.</li><li>8. Select a security group that allows ingress from the staging area VPC subnet over TCP 443.</li><li>9. Choose <b>Create endpoint</b>.</li></ol> <p>For more information, see <a href="#">Interface VPC endpoints</a> in the Amazon VPC documentation.</p>	

Task	Description	Skills required
Configure the interface endpoint for Amazon EC2.	<p>The staging area VPC connects privately to the Amazon EC2 API through the interface endpoint that you create in the target staging area VPC. To create the endpoint, follow the instructions provided in the previous story.</p> <ul style="list-style-type: none"><li>• For service name, enter <code>com.amazonaws.&lt;region&gt;.ec2</code> . For <b>Type</b>, choose <b>Interface</b>.</li><li>• The security group must allow inbound HTTPS traffic from the staging area VPC subnet over port 443.</li><li>• In the <b>Additional settings</b> section, select <b>Enable DNS name</b>.</li></ul>	Migration lead



Task	Description	Skills required
Configure the interface endpoint for Amazon S3.	<p>The source data center and staging area VPC connect privately to the Amazon S3 API through the interface endpoint that you create in the target staging area VPC. To create the endpoint, follow the instructions provided in the first story.</p> <ul style="list-style-type: none"><li>• For <b>Service Name</b>, enter <code>com.amazonaws.&lt;region&gt;.s3</code>. For <b>Type</b>, choose <b>Interface</b>.</li><li>• The VPC security group must allow inbound HTTPS traffic from the staging area VPC subnet over port 443.</li><li>• In the <b>Additional settings</b> section, clear <b>Enable DNS name</b>. Amazon S3 interface endpoints do not support private DNS names.</li></ul> <p><b>Note:</b> You use an interface endpoint because gateway endpoint connections cannot be extended out of a VPC. (For details, see the <a href="#">Amazon VPC documentation</a>.)</p>	Migration lead

Task	Description	Skills required
Configure the Amazon S3 Gateway endpoint.	<p>During the configuration phase, the replication server has to connect to an S3 bucket to download the AWS Replication Server's software updates. However, Amazon S3 interface endpoints do not support private DNS names, and there is no way to supply an Amazon S3 endpoint DNS name to a replication server.</p> <p>To mitigate this issue, you create an Amazon S3 gateway endpoint in the VPC that the staging area subnet belongs to, and update the staging subnet's route tables with the relevant routes. For more information, see <a href="#">Create a gateway endpoint</a> in the AWS PrivateLink documentation.</p>	Cloud administrator

Task	Description	Skills required
<p>Configure on-premises DNS to resolve private DNS names for endpoints.</p>	<p>The interface endpoints for Application Migration Service and Amazon EC2 have private DNS names that can be resolved in the VPC. However, you also need to configure on-premises servers to resolve private DNS names for these interface endpoints.</p> <p>There are multiple ways to configure these servers. In this pattern, we tested this functionality by forwarding on-premises DNS queries to the Amazon Route 53 Resolver inbound endpoint in the staging area VPC. For more information, see <a href="#">Resolving DNS queries between VPCs and your network</a> in the Route 53 documentation.</p>	<p>Migration engineer</p>

## Connect to the Application Migration Service control plane over a private link

Task	Description	Skills required
<p>Install AWS Replication Agent by using AWS PrivateLink.</p>	<ol style="list-style-type: none"> <li>1. Download the AWS Replication Agent to a private S3 bucket in the destination Region.</li> <li>2. Log in to the source servers to be migrated.</li> </ol>	<p>Migration engineer</p>

Task	Description	Skills required
	<p>The AWS Replication Agent installer needs network access to the Application Migration Service and Amazon S3 endpoints. Because your on-premises network isn't open to Application Migration Service and Amazon S3 public endpoints, you must install the Agent with the help of the interface endpoints you created in the previous steps by using AWS PrivateLink.</p> <p>Here's an example for Linux:</p> <ol style="list-style-type: none"><li>1. Download the Agent by using the command:</li></ol> <pre>wget -O ./aws-replication-installer-init.py \ https://aws-application-migration-service-&lt;aws_region&gt;.bucket.&lt;s3-endpoint-DNS-name&gt;/latest/linux/aws-replication-installer-init.py</pre> <p><b>Note:</b> bucket is a static keyword that you must add before the Amazon S3 interface endpoint DNS name.</p>	

Task	Description	Skills required
	<p>For more information, see the <a href="#">Amazon S3 documentation</a>.</p> <p>For example, if the DNS name of the Amazon S3 interface endpoint is <code>vpce-009c8b07adb052a11-qgf8q50y.s3.us-west-1.vpce.amazonaws.com</code> and the AWS Region is <code>us-west-1</code>, you would use the command:</p> <pre>wget -O ./aws-replication-installer-init.py \ https://aws-application-migration-service-us-west-1.bucket.vpce-009c8b07adb052a11-qgf8q50y.s3.us-west-1.vpce.amazonaws.com/latest/linux/aws-replication-installer-init.py</pre> <p>2. Install the Agent:</p> <ul style="list-style-type: none"><li>• If you selected <b>Enable DNS name</b> when you created an interface endpoint for Application Migration Service, run the command:</li></ul>	

Task	Description	Skills required
	<pre>sudo python3 aws- replication-installer- init.py \   --region &lt;aws_regi on&gt; \   --aws-access-key-i d &lt;access-key&gt; \   --aws-secret-acces s-key &lt;secret-key&gt; \   --no-prompt \   --s3-endpoint &lt;s3- endpoint-DNS-name&gt;</pre> <ul style="list-style-type: none"><li>• If you didn't select <b>Enable DNS name</b> when you created the interface endpoint for Application Migration Service, run the command:</li></ul> <pre>sudo python3 aws- replication-installer- init.py \   --region &lt;aws_regi on&gt; \   --aws-access-key-i d &lt;access-key&gt; \   --aws-secret-acces s-key &lt;secret-key&gt; \   --no-prompt \   --s3-endpoint &lt;s3- endpoint-DNS-name&gt; \   --endpoint &lt;mgn- endpoint-DNS-name&gt;</pre> <p>For more information, see <a href="#">AWS Replication Agent installation instructions</a> in the</p>	

Task	Description	Skills required
	<p>Application Migration Service documentation.</p> <p>After you have established your connection with Application Migration Service and installed the AWS Replication Agent, follow the instructions in the <a href="#">Application Migration Service documentation</a> to migrate your source servers to your target VPC and subnet.</p>	

## Related resources

### Application Migration Service documentation

- [Concepts](#)
- [Migration workflow](#)
- [Quick start guide](#)
- [FAQ](#)
- [Troubleshooting](#)

### Additional resources

- [AWS Application Migration Service - A Technical Introduction](#) (AWS Training and Certification walkthrough)
- [AWS Application Migration Service architecture and network architecture](#) (video)

## Additional information

### Troubleshooting AWS Replication Agent installations on Linux servers

If you get a **gcc** error on an Amazon Linux server, configure the package repository and use the following command:

```
## sudo yum groupinstall "Development Tools"
```



# Create Infoblox objects using AWS CloudFormation custom resources and Amazon SNS

Created by Tim Sutton (AWS)

**Environment:** PoC or pilot

**Technologies:** Networking

**Workload:** All other workloads

**AWS services:** Amazon SNS; AWS CloudFormation; AWS KMS; AWS Lambda; AWS Organizations

## Summary

Infoblox Domain Name System (DNS), Dynamic Host Configuration Protocol (DHCP), and IP address management ([Infoblox DDI](#)) enables you to centralize and efficiently control a complex hybrid environment. With Infoblox DDI, you can discover and record all network assets in one authoritative IP address management (IPAM) database, in addition to managing DNS on premises and on the Amazon Web Services (AWS) Cloud by using the same appliances.

This pattern describes how to use an AWS CloudFormation custom resource to create Infoblox objects (for example, DNS records or IPAM objects) by calling the Infoblox WAPI API. For more information about the Infoblox WAPI, see the [WAPI documentation](#) in the Infoblox documentation.

By using this pattern's approach, you can obtain a unified view of DNS records and IPAM configurations for your AWS and on-premises environments, in addition to removing manual processes that create records and provision your networks. You can use this pattern's approach for the following use cases:

- Adding an A record after creating an Amazon Elastic Compute Cloud (Amazon EC2) instance
- Adding a CNAME record after creating an Application Load Balancer
- Adding a network object after creating a virtual private cloud (VPC)
- Providing the next network range and using that range to create subnets

You can also extend this pattern and use other Infoblox device features such as adding different DNS record types or configuring Infoblox vDiscovery.

The pattern uses a hub-and-spoke design in which the hub requires connectivity to the Infoblox appliance on the AWS Cloud or on premises and uses AWS Lambda to call the Infoblox API. The spoke is in the same or a different account in the same organization in AWS Organizations, and calls the Lambda function by using an AWS CloudFormation custom resource.

## Prerequisites and limitations

### Prerequisites

- An existing Infoblox appliance or grid, installed on the AWS Cloud, on premises, or both, and configured with an admin user that can administer IPAM and DNS actions. For more information about this, see [About admin accounts](#) in the Infoblox documentation.
- An existing DNS authoritative zone that you want to add records on the Infoblox appliance. For more information about this, see [Configuring authoritative zones](#) in the Infoblox documentation.
- Two active AWS accounts in AWS Organizations. One account is the hub account and the other account is the spoke account.
- The hub and spoke accounts must be in the same AWS Region.
- The hub account's VPC must connect to the Infoblox appliance; for example, by using AWS Transit Gateway or VPC peering.
- [AWS Serverless Application Model \(AWS SAM\)](#), locally installed and configured with AWS Cloud9 or AWS CloudShell.
- The `Infoblox-Hub.zip` and `ClientTest.yaml` files (attached), downloaded to the local environment that contains AWS SAM.

### Limitations

- The AWS CloudFormation custom resource's service token must be from the same Region where the stack is created. We recommend that you use a hub account in each Region, instead of creating an Amazon Simple Notification Service (Amazon SNS) topic in one Region and calling the Lambda function in another Region.

### Product versions

- Infoblox WAPI version 2.7

## Architecture

The following diagrams shows this pattern's workflow.

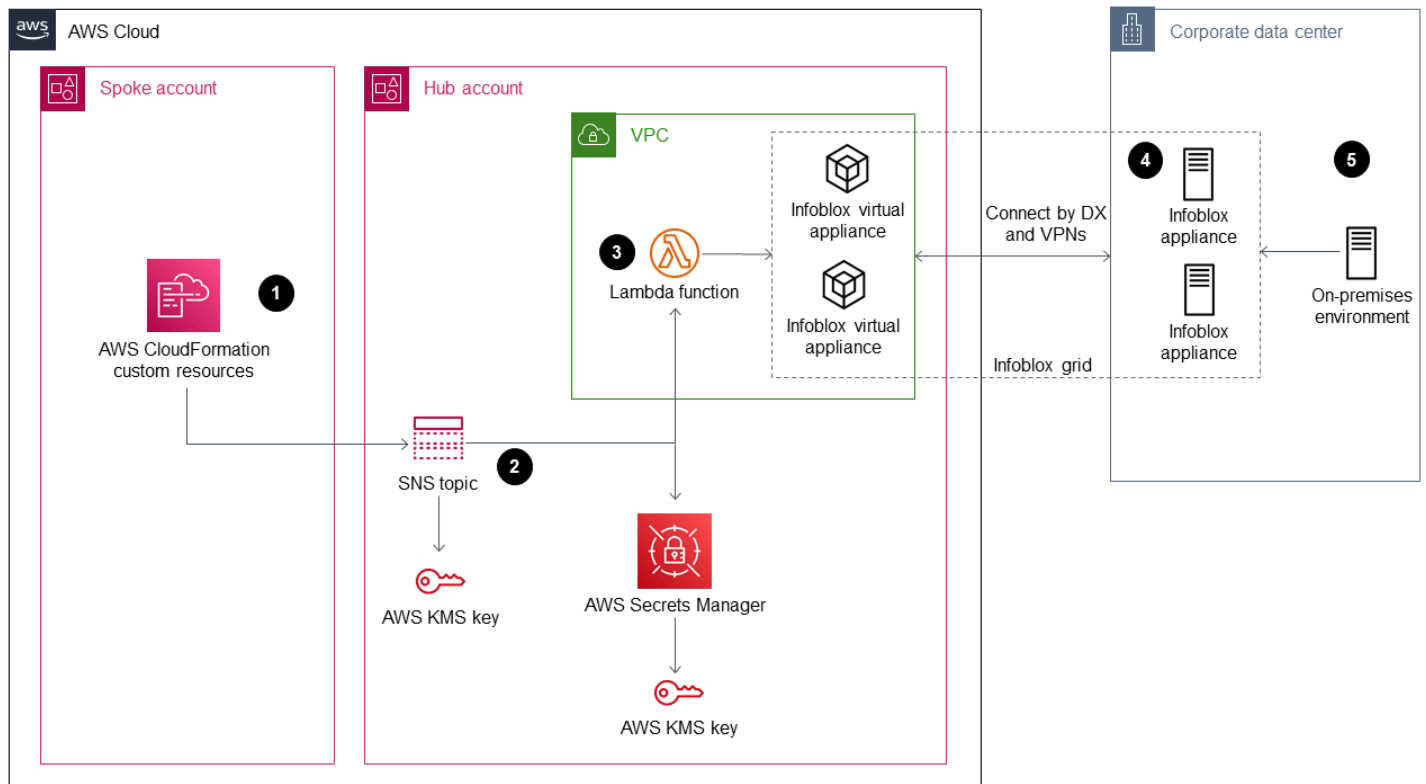

The diagram shows the following components for this pattern's solution:

1. AWS CloudFormation custom resources enable you to write custom provisioning logic in templates that AWS CloudFormation runs when you create, update, or delete stacks. When you create a stack, AWS CloudFormation sends a `create` request to an SNS topic that's monitored by an application running on an EC2 instance.
2. The Amazon SNS notification from the AWS CloudFormation custom resource is encrypted through a specific AWS Key Management Service (AWS KMS) key and access is restricted to accounts in your organization in Organizations. The SNS topic initiates the Lambda resource that calls the Infoblox WAPI API.
3. Amazon SNS invokes the following Lambda functions that take the Infoblox WAPI URL, the user name, and password AWS Secrets Manager Amazon Resource Names (ARNs) as environment variables:

- `dnsapi.lambda_handler` – Receives the `DNSName`, `DNSType`, and `DNSValue` values from the AWS CloudFormation custom resource and uses these to create DNS A records and CNAMEs.
- `ipaddr.lambda_handler` – Receives the `VPCIDR`, `Type`, `SubnetPrefix`, and `NetworkName` values from the AWS CloudFormation custom resource and uses these to add the network data into the Infoblox IPAM database or provide the custom resource with the next available network that can be used to create new subnets.
- `describeprefixes.lambda_handler` – Calls the `describe_managed_prefix_lists` AWS API by using the `"com.amazonaws."+Region+".s3"` filter to retrieve the required prefix ID.

**Important:** These Lambda functions are written in Python and are similar to each other but call different APIs.

4. You can deploy the Infoblox grid as physical, virtual, or cloud-based network appliances. It can be deployed on-premises or as a virtual appliance using a range of hypervisors, including VMware ESXi, Microsoft Hyper-V, Linux KVM, and Xen. You can also deploy the Infoblox grid on the AWS Cloud with an Amazon Machine Image (AMI).
5. The diagram shows a hybrid solution for the Infoblox grid that provides DNS and IPAM to resources on the AWS Cloud and on premises.

## Technology stack

- AWS CloudFormation
- IAM
- AWS KMS
- AWS Lambda
- AWS SAM
- AWS Secrets Manager
- Amazon SNS
- Amazon VPC

## Tools

- [AWS CloudFormation](#) helps you set up AWS resources, provision them quickly and consistently, and manage them throughout their lifecycle across AWS accounts and Regions.
- [AWS Identity and Access Management \(IAM\)](#) helps you securely manage access to your AWS resources by controlling who is authenticated and authorized to use them.
- [AWS Key Management Service \(AWS KMS\)](#) helps you create and control cryptographic keys to help protect your data.
- [AWS Lambda](#) is a compute service that helps you run code without needing to provision or manage servers. It runs your code only when needed and scales automatically, so you pay only for the compute time that you use.
- [AWS Organizations](#) is an account management service that helps you consolidate multiple AWS accounts into an organization that you create and centrally manage.
- [AWS Secrets Manager](#) helps you replace hardcoded credentials in your code, including passwords, with an API call to Secrets Manager to retrieve the secret programmatically.
- [AWS Serverless Application Model \(AWS SAM\)](#) is an open-source framework that helps you build serverless applications in the AWS Cloud.
- [Amazon Simple Notification Service \(Amazon SNS\)](#) helps you coordinate and manage the exchange of messages between publishers and clients, including web servers and email addresses.
- [Amazon Virtual Private Cloud \(Amazon VPC\)](#) helps you launch AWS resources into a virtual network that you've defined. This virtual network resembles a traditional network that you'd operate in your own data center, with the benefits of using the scalable infrastructure of AWS.

## Code

You can use the `ClientTest.yaml` sample AWS CloudFormation template (attached) to test the Infoblox hub. You can customize the AWS CloudFormation template to include the custom resources from the following table.

Create an A record using the Infoblox spoke custom resource

**Return values:**

`infobloxref` – Infoblox references

**Example resource:**

Create a CNAME record using the Infoblox spoke custom resource

```
ARECORDCustomResource:

  Type: "Custom::InfobloxAPI"

  Properties:

    ServiceToken: !Sub arn:aws:sns:
${AWS::Region}:${HubAccountID}:Ru
nInfobloxDNSFunction

    DNSName: 'arecordtest.compa
ny.com'

    DNSType: 'ARecord'

    DNSValue: '10.0.0.1'
```

**Return values:**

infobloxref – Infoblox references

**Example resource:**

```
CNAMECustomResource:

  Type: "Custom::InfobloxAPI"

  Properties:

    ServiceToken: !Sub arn:aws:sns:
${AWS::Region}:${HubAccountID}:Ru
nInfoblox

    DNSFunction

    DNSName: 'cnametest.company.com'

    DNSType: 'cname'

    DNSValue: 'aws.amazon.com'
```

## Create a network object using the Infoblox spoke custom resource

### Return values:

`infobloxref` – Infoblox references

`network` – Network range (the same as VPCCIDR)

### Example resource:

```
VPCCustomResource:
  Type: 'Custom::InfobloxAPI'
  Properties:
    ServiceToken: !Sub arn:aws:sns:
    ${AWS::Region}:${HubAccountID}:Ru
    nInfobloxNextSubnetFunction
    VPCCIDR: !Ref VpcCIDR
    Type: VPC
    NetworkName: My-VPC
```

Retrieve the next available subnet using the Infoblox spoke custom resource

**Return values:**

`infobloxref` – Infoblox references

`network` – The subnet's network range

**Example resource:**

```
Subnet1CustomResource:
  Type: 'Custom::InfobloxAPI'
  DependsOn: VPCCustomResource
  Properties:
    ServiceToken: !Sub arn:aws:sns:
${AWS::Region}:${HubAccountID}:Ru
nInfobloxNextSubnetFunction
    VPCCIDR: !Ref VpcCIDR
    Type: Subnet
    SubnetPrefix: !Ref SubnetPrefix
  NetworkName: My-Subnet
```

## Epics

### Create and configure the hub account's VPC

Task	Description	Skills required
Create a VPC with a connection to the Infoblox appliance.	Sign in to the AWS Management Console for your hub account and create a VPC by following the steps in the <a href="#">Amazon VPC on the AWS</a>	Network administrator, System administrator



Task	Description	Skills required
	<p><a href="#">Cloud Quick Start reference deployment</a> from AWS Quick Starts.</p> <p><b>Important:</b> The VPC must have HTTPS connectivity to the Infoblox appliance and we recommend that you use a private subnet for this connection.</p>	

Task	Description	Skills required
(Optional) Create the VPC endpoints for private subnets.	<p>VPC endpoints provide connectivity to public services for your private subnets. The following endpoints are required:</p> <ul style="list-style-type: none"> <li>• A gateway endpoint for Amazon Simple Storage Service (Amazon S3) to allow Lambda to communicate with AWS CloudFormation</li> <li>• An interface endpoint for Secrets Manager to enable connectivity with Secrets Manager</li> <li>• An interface endpoint for AWS KMS to allow the encryption of the SNS topic and Secrets Manager secret</li> </ul> <p>For more information about creating endpoints for private subnets, see <a href="#">VPC endpoints</a> in the Amazon VPC documentation.</p>	Network administrator, Systems administrator

## Deploy the Infoblox hub

Task	Description	Skills required
Build the AWS SAM template.	1. Run the unzip <code>Infoblox-Hub.zip</code>	Developer, System administrator

Task	Description	Skills required
	<p>command in the environment that contains AWS SAM.</p> <ol style="list-style-type: none"><li data-bbox="592 310 1027 499">2. Run the <code>cd Hub/</code> command to change your directory to the Hub directory.</li><li data-bbox="592 520 1027 1033">3. Run the <code>sam build</code> command to process the AWS SAM template file, application code, and any language-specific files and dependencies. The <code>sam build</code> command also copies build artifacts in the format and location expected for the following story.</li></ol>	

Task	Description	Skills required
Deploy the AWS SAM template.	<p>The <code>sam deploy</code> command takes the required parameters and saves them into the <code>samconfig.toml</code> file, stores the AWS CloudFormation template and Lambda functions in an S3 bucket, and then deploys the AWS CloudFormation template into your hub account.</p> <p>The following sample code shows how to deploy the AWS SAM template:</p> <pre data-bbox="594 905 1027 1871"> \$ sam deploy --guided  Configuring SAM deploy ===== ==     Looking for     config file [samconfig.toml] : Found     Reading default     arguments : Success     Setting default     arguments for 'sam     deploy'     ===== ===== =====     Stack Name     [Infoblox-Hub]:     AWS Region [eu-     west-1]:     Parameter     InfobloxUsername:     Parameter     InfobloxPassword: </pre>	Developer, System administrator

Task	Description	Skills required
	<pre> Parameter InfobloxIPAddress [xxx.xxx.xx.xxx]: Parameter AWSOrganisationID [o- xxxxxxxxx]: Parameter VPCID [vpc-xxxxxxxxx]: Parameter VPCCIDR [xxx.xxx. xxx.xxx/16]: Parameter VPCSubnetID1 [subnet-x xx]: Parameter VPCSubnetID2 [subnet-x xx]: Parameter VPCSubnetID3 [subnet-x xx]: Parameter VPCSubnetID4 []: #Shows you resources changes to be deployed and require a 'Y' to initiate deploy Confirm changes before deploy [Y/n]: y #SAM needs permission to be able to create roles to connect to the resources in your template Allow SAM CLI IAM role creation [Y/n]: n Capabilities [['CAPABI LITY_NAMED_IAM']]: Save arguments to configuration file [Y/n]: y </pre>	

Task	Description	Skills required
	<pre>SAM configura tion file [samconfi g.toml]:     SAM configura tion environment [default]:</pre> <p><b>Important:</b> You must use the <code>--guided</code> option each time because the Infoblox sign-in credentials are not stored in the <code>samconfig.toml</code> file.</p>	

## Related resources

- [Getting started with WAPIs using Postman](#) (Infoblox Blog)
- [Provisioning vNIOS for AWS Using the BYOL Model](#) (Infoblox documentation)
- [quickstart-aws-vpc](#) (GitHub repo)
- [describe\\_managed\\_prefix\\_lists](#) (AWS SDK for Python documentation)

## Attachments

To access additional content that is associated with this document, unzip the following file: [attachment.zip](#)

# Customize Amazon CloudWatch alerts for AWS Network Firewall

Created by Jason Owens (AWS)

**Environment:** PoC or pilot

**Technologies:** Networking;  
Security, identity, compliance

**Workload:** Open-source

**AWS services:** Amazon  
CloudWatch Logs; AWS  
Network Firewall; AWS CLI

## Summary

The pattern helps you customize the Amazon CloudWatch alerts that are generated by Amazon Web Services (AWS) Network Firewall. You can use predefined rules or create custom rules that determine the message, metadata, and severity of the alerts. You can then act upon these alerts or automate responses by other Amazon services, such as Amazon EventBridge.

In this pattern, you generate Suricata-compatible firewall rules. [Suricata](#) is an open-source threat detection engine. You first create simple rules and then test them to confirm that the CloudWatch alerts are generated and logged. Once you have successfully tested the rules, you modify them to define custom messages, metadata, and severities, and you then test once more to confirm the updates.

## Prerequisites and limitations

### Prerequisites

- An active AWS account.
- AWS Command Line Interface (AWS CLI) installed and configured on your Linux, macOS, or Windows workstation. For more information, see [Installing or updating the latest version of the AWS CLI](#).
- AWS Network Firewall installed and configured to use CloudWatch Logs. For more information, see [Logging network traffic from AWS Network Firewall](#).

- An Amazon Elastic Compute Cloud (Amazon EC2) instance in a private subnet of a virtual private cloud (VPC) that is protected by Network Firewall.

### Product versions

- For version 1 of AWS CLI, use 1.18.180 or later. For version 2 of AWS CLI, use 2.1.2 or later.
- The classification.config file from Suricata version 5.0.2. For a copy of this configuration file, see the [Additional information](#) section.

## Architecture

### Target technology stack

- Network Firewall
- Amazon CloudWatch Logs

### Target architecture



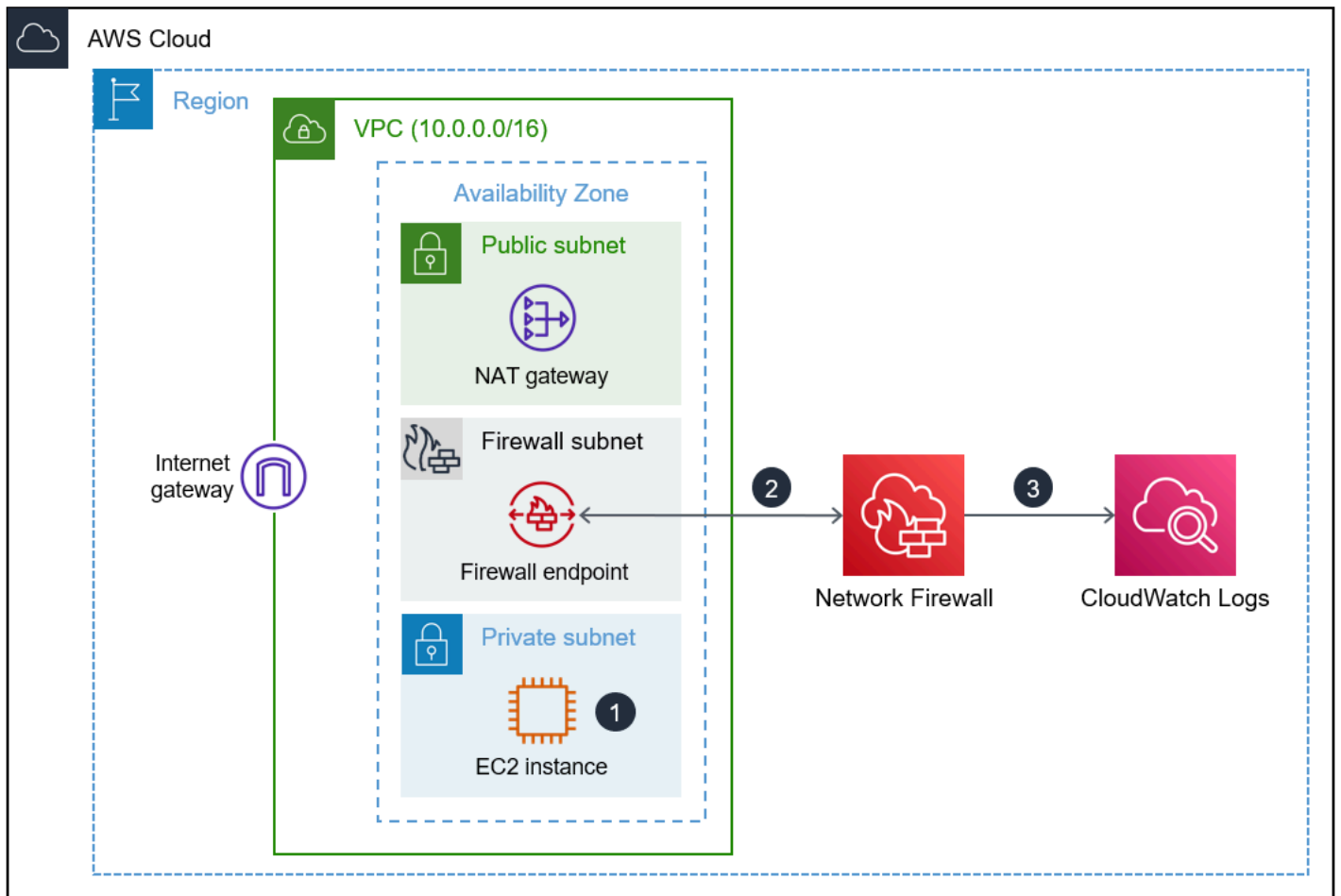

The architecture diagram shows the following workflow:

1. An EC2 instance in a private subnet makes a request by using either [curl](#) or [Wget](#).
2. Network Firewall processes the traffic and generates an alert.
3. Network Firewall sends the logged alerts to CloudWatch Logs.

## Tools

### AWS services

- [Amazon CloudWatch](#) helps you monitor the metrics of your AWS resources and the applications you run on AWS in real time.
- [Amazon CloudWatch Logs](#) helps you centralize the logs from all your systems, applications, and AWS services so you can monitor them and archive them securely.

- [AWS Command Line Interface \(AWS CLI\)](#) is an open-source tool that helps you interact with AWS services through commands in your command-line shell.
- [AWS Network Firewall](#) is a stateful, managed, network firewall and intrusion detection and prevention service for virtual private clouds (VPCs) in the AWS Cloud.

## Other tools and services

- [curl](#) – curl is an open-source command line tool and library.
- [Wget](#) – GNU Wget is a free command line tool.

## Epics

### Create the firewall rules and rule group

Task	Description	Skills required
Create rules.	<p>1. In a text editor, create a list of rules that you want to add to the firewall. Each rule must be on a separate line. The value in the <code>classtype</code> parameter is from the default Suricata classification configuration file. For the full configuration file contents, see the <a href="#">Additional information</a> section. The following are two examples of rules.</p> <pre> alert http any   any -&gt; any any   (content:"badstuff "; classtype:misc- activity; sid:3; rev:1;) </pre>	AWS systems administrator, Network administrator

Task	Description	Skills required
	<pre>alert http any any -&gt; any any (content: "morebadstuff";  classtype:bad-unknown;  sid:4; rev:1;)</pre> <p>2. Save the rules in a file named <code>custom.rules</code> .</p>	

Task	Description	Skills required
Create the rule group.	<p>In the AWS CLI, enter the following command. This creates the rule group.</p> <pre data-bbox="597 394 1026 869"># aws network-firewall create-rule-group \   --rule-group- name custom --type STATEFUL \   --capacity 10 --rules file://cu stom.rules \   --tags Key=envir onment,Value=devel opment</pre> <p>The following is an example output. Make note of the <code>RuleGroupArn</code> , which you need in a later step.</p> <pre data-bbox="597 1125 1026 1854">{   "UpdateToken":     "4f998d72-973c-490a- bed2-fc3460547e23",   "RuleGroupResponse ": {     "RuleGroupArn":       "arn:aws:network-f irewall:us-east-2: 1234567890:stateful- rulegroup/custom",     "RuleGrou pName": "custom",     "RuleGroupId":       "238a8259-9eaf-48b b-90af-5e690cf8c48b",     "Type":       "STATEFUL",</pre>	AWS systems administrator

Task	Description	Skills required
	<pre>           "Capacity": 10,           "RuleGrou pStatus": "ACTIVE",           "Tags": [             {               "Key": "environment",               "Value": "development"             }           ]         } </pre>	

## Update the firewall policy

Task	Description	Skills required
<p>Get the ARN of the firewall policy.</p>	<p>In the AWS CLI, enter the following command. This returns the Amazon Resource Name (ARN) of the firewall policy. Record the ARN for use later in this pattern.</p> <pre> # aws network-firewall describe-firewall \   --firewall-name aws-network-firewall- anfw \   --query 'Firewall .FirewallPolicyArn' </pre> <p>The following is an example ARN that is returned by this command.</p>	<p>AWS systems administrator</p>

Task	Description	Skills required
	<pre>"arn:aws:network-firewall:us-east-2:1234567890:firewall-policy/firewall-policy-anfw"</pre>	

Task	Description	Skills required
Update the firewall policy.	<p>In a text editor, copy the paste the following code. Replace <code>&lt;RuleGroupArn&gt;</code> with the value you recorded in the previous epic. Save the file as <code>firewall-policy-anfw.json</code> .</p> <pre data-bbox="594 583 1027 1381">{   "StatelessDefaultActions": [     "aws:forward_to_sfe"   ],   "StatelessFragmentDefaultActions": [     "aws:forward_to_sfe"   ],   "StatefulRuleGroupReferences": [     {       "ResourceArn": "&lt;RuleGroupArn&gt;"     }   ] }</pre> <p>Enter the following command in the AWS CLI. This command requires an <a href="#">update token</a> to add the new rules. The token is used to confirm that the policy hasn't changed since you last retrieved it.</p>	AWS systems administrator

Task	Description	Skills required
	<pre>UPDATETOKEN=(`aws network-firewall describe-firewall- policy \         -- firewall-policy-name firewall-policy-anfw \         --output text --query UpdateTok en`)  aws network-firewall update-firewall-po licy \ --update-token \$UPDATETOKEN \ --firewall-policy- name firewall-policy- anfw \ --firewall-policy file://firewall-po licy-anfw.json</pre>	



Task	Description	Skills required
Confirm the policy updates.	<p>(Optional) If you would like to confirm the rules were added and view the policy format, enter the following command in the AWS CLI.</p> <pre data-bbox="592 489 1029 848"># aws network-firewall describe-firewall- policy \   --firewall-policy- name firewall-policy- anfw \   --query FirewallP olicy</pre> <p>The following is an example output.</p> <pre data-bbox="592 1003 1029 1852">{   "StatelessDefaultA ctions": [     "aws:forw ard_to_sfe"   ],   "StatelessFragment DefaultActions": [     "aws:forw ard_to_sfe"   ],   "StatefulRuleGroup References": [     {       "Resource Arn": "arn:aws: network-firewall:u s-east-2:123456789 0:stateful-rulegroup/ custom"     }   ] }</pre>	AWS systems administrator

Task	Description	Skills required
	<pre>    ]   }</pre>	

## Test alert functionality

Task	Description	Skills required
Generate alerts for testing.	<ol style="list-style-type: none"> <li>1. Log in to a test workstation within the firewall subnet.</li> <li>2. Enter commands that should generate alerts. For example, you can use <code>wget</code> or <code>curl</code>.</li> </ol> <pre>wget -U "badstuff" http://www.amazon. com -o /dev/null</pre> <pre>curl -A "morebads tuff" http://ww w.amazon.com -o / dev/null</pre>	AWS systems administrator
Validate that the alerts are logged.	<ol style="list-style-type: none"> <li>1. Open the CloudWatch console at <a href="https://console.aws.amazon.com/cloudwatch/">https://console.aws.amazon.com/cloudwatch/</a></li> <li>2. Navigate to the correct log group and stream. For more information, see <a href="#">View log data sent to CloudWatch Logs</a> (CloudWatch Logs documentation).</li> </ol>	AWS systems administrator

Task	Description	Skills required
	<p>3. Confirm the logged events are similar to the following examples. The examples show only the relevant portion of the alert.</p> <p><b>Example 1</b></p> <pre data-bbox="630 552 1029 1108">    "alert": {       "action": "allowed",       "signature_id": 3,       "rev": 1,       "signature": "",       "category": "Misc activity",       "severity": 3     }</pre> <p><b>Example 2</b></p> <pre data-bbox="630 1220 1029 1814">    "alert": {       "action": "allowed",       "signature_id": 4,       "rev": 1,       "signature": "",       "category": "Potentially Bad Traffic",       "severity": 2     }</pre>	

## Update the firewall rules and rule group

Task	Description	Skills required
Update the firewall rules.	<ol style="list-style-type: none"><li data-bbox="592 321 1027 401">1. In a text editor, open the <code>custom.rules</code> file.</li><li data-bbox="592 426 1027 602">2. Change the first rule to be similar to the following. This rule must be entered on a single line in the file. <pre data-bbox="634 642 1027 1115">alert http any any -&gt; any any (msg:"Watch out - Bad Stuff!!"; content:"badstuff" ; classtype:misc- activity; priority: 2; sid:3; rev:2; metadata:custom- field-2 Danger!, custom-field More Info;)</pre></li></ol> <p data-bbox="630 1157 992 1236">This makes the following changes to the rule:</p> <ul style="list-style-type: none"><li data-bbox="630 1262 1027 1581">• Adds a <a href="#">msg</a> (Suricata website) string that provides text information about the signature or alert. In the generated alert, this maps to the signature.</li><li data-bbox="630 1606 1027 1873">• Adjusts the default <a href="#">priority</a> (Suricata website) of <code>misc-activity</code> from 3 to 2. For the default values of the various <code>classtype</code></li></ul>	AWS systems administrator

Task	Description	Skills required
	<p>s , see the <a href="#">Additional information</a> section.</p> <ul style="list-style-type: none"><li>• Adds custom <a href="#">metadata</a> (Suricata website) to the alert. This is additional information that that is added to the signature. It is recommended that you use key-value pairs.</li><li>• Changes the <a href="#">rev</a> (Suricata website) from 1 to 2. This represents the version of the signature.</li></ul>	

Task	Description	Skills required
Update the rule group.	<p>In the AWS CLI, run the following commands. Use the ARN of your firewall policy. These commands get an update token and update the rule group with the rule changes.</p> <pre data-bbox="597 583 1026 1060"># UPDATETOKEN=(`aws network-firewall \  describe-rule-group \ --rule-group-arn arn:aws:network-fi rewall:us-east-2:1 23457890:stateful- rulegroup/custom \ --output text --query UpdateToken`)</pre> <pre data-bbox="597 1094 1026 1570"># aws network-firewall update-rule-group \ --rule-group-arn arn:aws:network-fi rewall:us-east-2:1 234567890:stateful- rulegroup/custom \ --rules file://cu stom.rules \ --update-token \$UPDATETOKEN</pre> <p>The following is an example output.</p> <pre data-bbox="597 1730 1026 1780">{</pre>	AWS systems administrator

Task	Description	Skills required
	<pre> "UpdateToken":   "7536939f-6a1d-414 c-96d1-bb28110996ed",   "RuleGroupResponse ": {     "RuleGroupArn":   "arn:aws:network-f irewall:us-east-2: 1234567890:stateful- rulegroup/custom",     "RuleGrou pName": "custom",     "RuleGroupId":   "238a8259-9eaf-48b b-90af-5e690cf8c48b",     "Type":   "STATEFUL",     "Capacity": 10,     "RuleGrou pStatus": "ACTIVE",     "Tags": [       {         "Key":   "environment",         "Value":   "development"       }     ]   } } </pre>	

### Test the updated alert functionality

Task	Description	Skills required
Generate an alert for testing.	<ol style="list-style-type: none"> <li>1. Log in to a test workstation within the firewall subnet.</li> <li>2. Enter a command that should generate an alert.</li> </ol>	AWS systems administrator

Task	Description	Skills required
	<p>For example, you can use <code>curl</code>.</p> <pre data-bbox="630 327 1029 491">curl -A "badstuff" http://www.amazon. com -o /dev/null</pre>	



Task	Description	Skills required
Validate the alert changed.	<ol style="list-style-type: none"><li>1. Open the CloudWatch console at <a href="https://console.aws.amazon.com/cloudwatch/">https://console.aws.amazon.com/cloudwatch/</a></li><li>2. Navigate to the correct log group and stream.</li><li>3. Confirm the logged event is similar to the following example. The example shows only the relevant portion of the alert.</li></ol> <pre data-bbox="630 793 1029 1787">"alert": {   "action":   "allowed",   "signature_id":   3,   "rev": 2,   "signature":   "Watch out - Bad   Stuff!!",   "category": "Misc   activity",   "severity": 2,   "metadata": {     "custom-f     ield": [       "More       Info"     ],     "custom-f     ield-2": [       "Danger!"     ]   } }</pre>	AWS systems administrator

## Related resources

### References

- [Send alerts from AWS Network Firewall to a Slack channel](#) (AWS Prescriptive Guidance)
- [Scaling threat prevention on AWS with Suricata](#) (AWS blog post)
- [Deployment models for AWS Network Firewall](#) (AWS blog post)
- [Suricata meta keywords](#) (Suricata documentation)

### Tutorials and videos

- [AWS Network Firewall workshop](#)

## Additional information

The following is the classification configuration file from Suricata 5.0.2. These classifications are used when creating the firewall rules.

```
# config classification:shortname,short description,priority

config classification: not-suspicious,Not Suspicious Traffic,3
config classification: unknown,Unknown Traffic,3
config classification: bad-unknown,Potentially Bad Traffic, 2
config classification: attempted-recon,Attempted Information Leak,2
config classification: successful-recon-limited,Information Leak,2
config classification: successful-recon-largescale,Large Scale Information Leak,2
config classification: attempted-dos,Attempted Denial of Service,2
config classification: successful-dos,Denial of Service,2
config classification: attempted-user,Attempted User Privilege Gain,1
config classification: unsuccessful-user,Unsuccessful User Privilege Gain,1
config classification: successful-user,Successful User Privilege Gain,1
config classification: attempted-admin,Attempted Administrator Privilege Gain,1
config classification: successful-admin,Successful Administrator Privilege Gain,1

# NEW CLASSIFICATIONS
config classification: rpc-portmap-decode,Decode of an RPC Query,2
config classification: shellcode-detect,Executable code was detected,1
config classification: string-detect,A suspicious string was detected,3
config classification: suspicious-filename-detect,A suspicious filename was detected,2
```

```
config classification: suspicious-login,An attempted login using a suspicious username
was detected,2
config classification: system-call-detect,A system call was detected,2
config classification: tcp-connection,A TCP connection was detected,4
config classification: trojan-activity,A Network Trojan was detected, 1
config classification: unusual-client-port-connection,A client was using an unusual
port,2
config classification: network-scan,Detection of a Network Scan,3
config classification: denial-of-service,Detection of a Denial of Service Attack,2
config classification: non-standard-protocol,Detection of a non-standard protocol or
event,2
config classification: protocol-command-decode,Generic Protocol Command Decode,3
config classification: web-application-activity,access to a potentially vulnerable web
application,2
config classification: web-application-attack,Web Application Attack,1
config classification: misc-activity,Misc activity,3
config classification: misc-attack,Misc Attack,2
config classification: icmp-event,Generic ICMP event,3
config classification: inappropriate-content,Inappropriate Content was Detected,1
config classification: policy-violation,Potential Corporate Privacy Violation,1
config classification: default-login-attempt,Attempt to login by a default username and
password,2
```

#### # Update

```
config classification: targeted-activity,Targeted Malicious Activity was Detected,1
config classification: exploit-kit,Exploit Kit Activity Detected,1
config classification: external-ip-check,Device Retrieving External IP Address
Detected,2
config classification: domain-c2,Domain Observed Used for C2 Detected,1
config classification: pup-activity,Possibly Unwanted Program Detected,2
config classification: credential-theft,Successful Credential Theft Detected,1
config classification: social-engineering,Possible Social Engineering Attempted,2
config classification: coin-mining,Crypto Currency Mining Activity Detected,2
config classification: command-and-control,Malware Command and Control Activity
Detected,1
```

# Deploy resources in an AWS Wavelength Zone by using Terraform

Created by Zahoor Chaudhrey (AWS) and Luca Iannario (AWS)

**Code repository:** [terraform-wavelength-infrastructure](#)

**Environment:** PoC or pilot

**Technologies:** Networking; Infrastructure; Content delivery; Web & mobile apps

**AWS services:** Amazon EC2; Amazon VPC; AWS Wavelength

## Summary

[AWS Wavelength](#) helps you build infrastructure that is optimized for Multi-Access Edge Computing (MEC) applications. *Wavelength Zones* are AWS infrastructure deployments that embed AWS compute and storage services within communications service providers' (CSP) 5G networks. Application traffic from 5G devices reaches application servers running in Wavelength Zones without leaving the telecommunications network. The following facilitate network connectivity through Wavelength:

- **Virtual private clouds (VPCs)** – VPCs in an AWS account can extend to span multiple Availability Zones, including Wavelength Zones. Amazon Elastic Compute Cloud (Amazon EC2) instances and related services appear as part of your Regional VPC. VPCs are created and managed in [Amazon Virtual Private Cloud \(Amazon VPC\)](#).
- **Carrier gateway** – A carrier gateway enables connectivity from the subnet in the Wavelength Zone to the CSP network, the internet, or the AWS Region through the CSP's network. The carrier gateway serves two purposes. It allows inbound traffic from a CSP network in a specific location, and it allows outbound traffic to the telecommunications network and the internet.

This pattern and its associated Terraform code help you launch resources, such as Amazon EC2 instances, Amazon Elastic Block Store (Amazon EBS) volumes, VPCs, subnets, and a carrier gateway, in a Wavelength Zone.

## Prerequisites and limitations

### Prerequisites

- An active AWS account
- An integrated development environment (IDE)
- [Opt in](#) to the target Wavelength Zone
- AWS Command Line Interface (AWS CLI), [installed](#) and [configured](#)
- Terraform version 1.8.4 or later, [installed](#) (Terraform documentation)
- Terraform AWS Provider version 5.32.1 or later, [configured](#) (Terraform documentation)
- Git, [installed](#) (GitHub)
- [Permissions](#) to create Amazon VPC, Wavelength, and Amazon EC2 resources

### Limitations

Not all AWS Regions support Wavelength Zones. For more information, see [Available Wavelength Zones](#) in the Wavelength documentation.

## Architecture

The following diagram shows how you can create a subnet and AWS resources in a Wavelength Zone. VPCs that contain a subnet in a Wavelength Zone can connect to a carrier gateway. A carrier gateway allows you to connect to the following resources:

- 4G/LTE and 5G devices on the telecommunication carrier's network.
- Fixed wireless access for select Wavelength Zone partners. For more information, see [Multi-access AWS Wavelength](#).
- Outbound traffic to public internet resources.

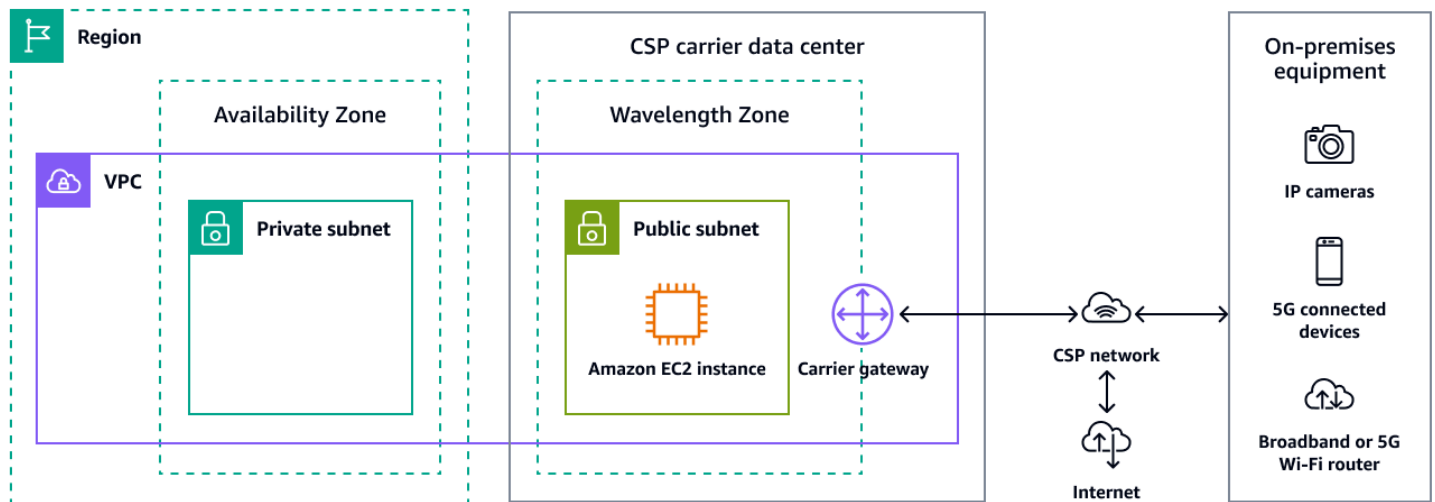

## Tools

### AWS services

- [Amazon Virtual Private Cloud \(Amazon VPC\)](#) helps you launch AWS resources into a virtual network that you've defined. This virtual network resembles a traditional network that you'd operate in your own data center, with the benefits of using the scalable infrastructure of AWS.
- [AWS Wavelength](#) extends AWS Cloud infrastructure to telecommunication providers' 5G networks. This helps you build applications that deliver ultra-low latencies to mobile devices and end users.

### Other tools

- [Terraform](#) is an infrastructure as code (IaC) tool from HashiCorp that helps you create and manage cloud and on-premises resources.

### Code repository

The code for this pattern is available in the GitHub [Creating AWS Wavelength Infrastructure using Terraform](#) repository. The Terraform code deploys the following infrastructure and resources:

- A VPC
- A Wavelength Zone
- A public subnet in the Wavelength Zone
- A carrier gateway in the Wavelength Zone

- An Amazon EC2 instance in the Wavelength Zone

## Best practices

- Before deploying, confirm that you're using the latest versions of Terraform and the AWS CLI.
- Use a continuous integration and continuous delivery (CI/CD) pipeline to deploy IaC. For more information, see [Best practices for managing Terraform State files in AWS CI/CD Pipeline](#) on AWS Blogs.

## Epics

### Provision the infrastructure

Task	Description	Skills required
Clone the repository.	<p>Enter the following command to clone the <a href="#">Creating AWS Wavelength Infrastructure using Terraform</a> repository to your environment.</p> <pre>git clone git@github.com:aws-samples/terraform-wavelength-infrastructure.git</pre>	DevOps engineer
Update the variables.	<ol style="list-style-type: none"><li>1. Navigate to the cloned repository. <pre>cd terraform-wavelength-infrastructure</pre></li><li>2. Using any text editor, create a file called <b>terraform.tfvars</b> in the root directory.</li></ol>	DevOps engineer, Terraform

Task	Description	Skills required
	<p>3. Create the following variables and enter their values:</p> <ul style="list-style-type: none"><li>• <code>region = &lt;enter Region name&gt;</code></li><li>• <code>vpc_cidr = &lt;enter CIDR block used by VPC&gt;</code></li><li>• <code>wavelength_subnet_cidr = &lt;enter CIDR block for the subnet in the Wavelength Zone&gt;</code></li><li>• <code>availabilityzone_wavelength = &lt;enter Wavelength Zone name&gt;</code></li></ul> <p>4. Save the <b>terraform.tfvars</b> file.</p>	
Initialize the configuration.	<p>Enter the following command to initialize the working directory.</p> <pre>terraform init</pre>	DevOps engineer, Terraform



Task	Description	Skills required
Preview the Terraform plan.	<p>Enter the following command to compare the target state against the current state of your AWS environment. This command generates a preview of the resources that will be configured.</p> <pre data-bbox="597 583 1026 667">terraform plan</pre>	DevOps engineer, Terraform
Verify and deploy.	<ol style="list-style-type: none"><li>1. Review the configuration changes in the Terraform plan and confirm that you want to implement these changes.</li><li>2. Enter the following command to apply the plan and create the infrastructure.<pre data-bbox="630 1163 1026 1247">terraform apply</pre></li><li>3. Enter yes to proceed. Terraform creates the architecture that is declared in the configuration files. For more information about the architecture, see the <a href="#">Target architecture</a> section of this pattern.</li></ol>	DevOps engineer, Terraform

## Validate and clean up

Task	Description	Skills required
Verify the infrastructure deployment.	<ol style="list-style-type: none"><li>1. If you don't already have an Amazon EC2 instance in a public subnet in your AWS Region, create one. For instructions, see <a href="#">Launch your Linux instance</a> or <a href="#">Launch your Windows instance</a>. You will use this instance to test the connectivity from the AWS Region to the Wavelength Zone.</li><li>2. Test the connectivity from the instance in the AWS Region to the instance in the Wavelength Zone. For instructions, see <a href="#">Test the connectivity</a> in the Wavelength documentation.</li></ol>	AWS DevOps, DevOps engineer
(Optional) Clean up the infrastructure.	<p>If you need to delete all of the resources that were provisioned by Terraform, do the following:</p> <ol style="list-style-type: none"><li>1. Enter the following command.</li></ol> <div data-bbox="630 1671 1029 1751" style="border: 1px solid #ccc; border-radius: 10px; padding: 5px; text-align: center;"><code>terraform destroy</code></div> <ol style="list-style-type: none"><li>2. Enter yes to confirm.</li></ol>	DevOps engineer, Terraform

# Troubleshooting

Issue	Solution
Connectivity to Amazon EC2 instances in the AWS Region.	See <a href="#">Troubleshoot connecting to your Linux instance</a> or <a href="#">Troubleshoot connecting to your Windows instance</a> .
Connectivity to Amazon EC2 instances in the Wavelength Zone.	See <a href="#">Troubleshoot SSH or RDP connectivity to my EC2 instances launched in a Wavelength Zone</a> .
Capacity in the Wavelength Zone.	See <a href="#">Quotas and considerations for Wavelength Zones</a> .
Mobile or carrier connectivity from the carrier network to the AWS Region.	<ol style="list-style-type: none"><li>1. Verify that the carrier gateway is operation<ol style="list-style-type: none"><li>a. Do the following:<ol style="list-style-type: none"><li>a. Open the <a href="#">Amazon VPC console</a>.</li><li>b. In the navigation pane, choose <b>Your VPCs</b>.</li><li>c. Select the VPC that contains the Wavelength Zone.</li><li>d. On the <b>Details</b> pane, for <b>Carrier gateway</b>, confirm that the value is attached.</li></ol></li></ol></li><li>2. Verify that any elastic IP addresses attached to instances in the Wavelength Zone are operational. Do the following:<ol style="list-style-type: none"><li>a. Open the <a href="#">Amazon EC2 console</a>.</li><li>b. In the navigation pane, choose <b>Instances</b>.</li><li>c. Select the instance in the Wavelength Zone.</li><li>d. Choose the <b>Network</b> tab.</li></ol></li></ol>

Issue	Solution
	<ol style="list-style-type: none"><li data-bbox="867 212 1395 338">e. Confirm that the elastic network interface has an Elastic IP address attached.</li><li data-bbox="829 363 1479 401">3. Contact the carrier network support team.</li></ol>

## Related resources

- [What is AWS Wavelength?](#)
- [How AWS Wavelength works](#)
- [Resilience in AWS Wavelength](#)

# Migrate DNS records in bulk to an Amazon Route 53 private hosted zone

Created by Ram Kandaswamy (AWS)

**Environment:** Production

**Technologies:** Networking; CloudNative; DevOps; Infrastructure

**AWS services:** AWS Cloud9; Amazon Route 53; Amazon S3

## Summary

Network engineers and cloud administrators need an efficient and simple way to add Domain Name System (DNS) records to private hosted zones in Amazon Route 53. Using a manual approach to copy entries from a Microsoft Excel worksheet to appropriate locations in the Route 53 console is tedious and error prone. This pattern describes an automated approach that reduces the time and effort required to add multiple records. It also provides a repeatable set of steps for multiple hosted zone creation.

This pattern uses the AWS Cloud9 integrated development environment (IDE) for development and testing, and Amazon Simple Storage Service (Amazon S3) to store records. To work with data efficiently, the pattern uses the JSON format because of its simplicity and its ability to support a Python dictionary (`dict` data type).

**Note:** If you can generate a zone file from your system, consider using the [Route 53 import feature](#) instead.

## Prerequisites and limitations

### Prerequisites

- An Excel worksheet that contains private hosted zone records
- Familiarity with different types of DNS records such as A record, Name Authority Pointer (NAPTR) record, and SRV record (see [Supported DNS record types](#))
- Familiarity with the Python language and its libraries

### Limitations

- The pattern doesn't provide extensive coverage for all use case scenarios. For example, the [change\\_resource\\_record\\_sets](#) call doesn't use all the available properties of the API.
- In the Excel worksheet, the value in each row is assumed to be unique. Multiple values for each fully qualified domain name (FQDN) are expected to appear in the same row. If that is not true, you should modify the code provided in this pattern to perform the necessary concatenation.
- The pattern uses the AWS SDK for Python (Boto3) to call the Route 53 service directly. You can enhance the code to use an AWS CloudFormation wrapper for the `create_stack` and `update_stack` commands, and use the JSON values to populate template resources.

## Architecture

### Technology stack

- Route 53 private hosted zones for routing traffic
- AWS Cloud9 IDE for development and testing
- Amazon S3 for storing the output JSON file

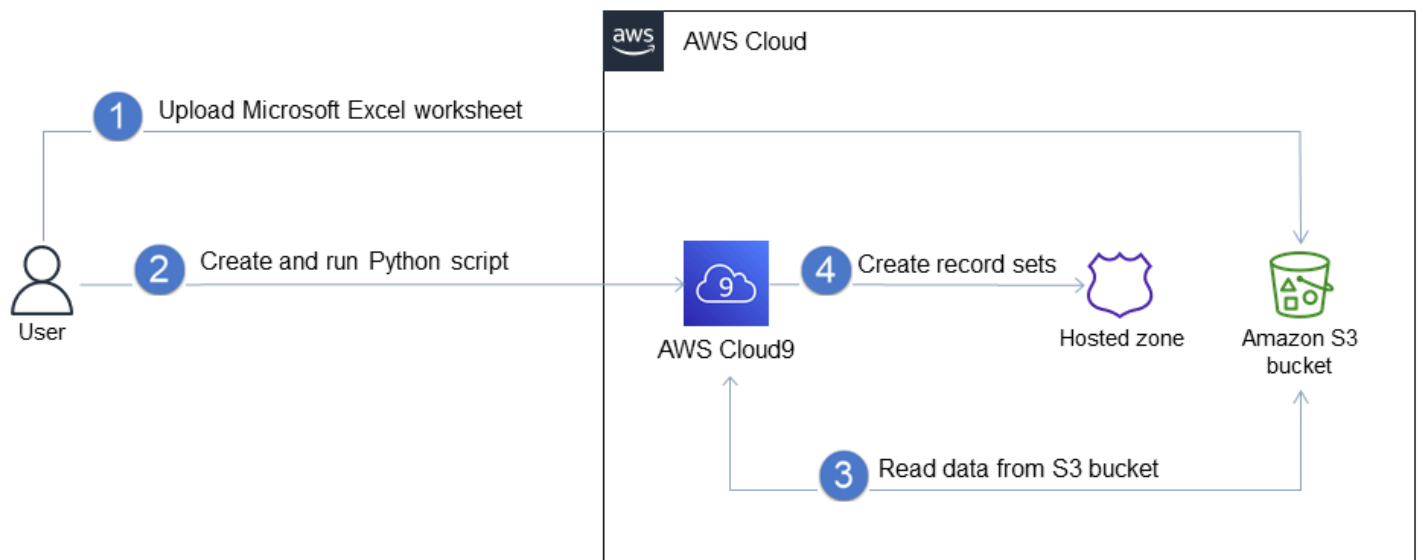

The workflow consists of these steps, as illustrated in the previous diagram and discussed in the *Epics* section:

1. Upload an Excel worksheet that has the record set information to an S3 bucket.
2. Create and run a Python script that converts the Excel data to JSON format.

3. Read the records from the S3 bucket and clean the data.
4. Create record sets in your private hosted zone.

## Tools

- [Route 53](#) – Amazon Route 53 is a highly available and scalable DNS web service that handles domain registration, DNS routing, and health checking.
- [AWS Cloud9](#) – AWS Cloud9 is an IDE that offers a rich code editing experience with support for several programming languages and runtime debuggers, and a built-in terminal. It contains a collection of tools that you use to code, build, run, test, and debug software, and helps you release software to the cloud.
- [Amazon S3](#) – Amazon Simple Storage Service (Amazon S3) is an object storage service. You can use Amazon S3 to store and retrieve any amount of data at any time, from anywhere on the web.

## Epics

### Prepare data for automation

Task	Description	Skills required
Create an Excel file for your records.	Use the records you exported from your current system to create an Excel worksheet that has the required columns for a record, such as fully qualified domain name (FQDN), record type, Time to Live (TTL), and value. For NAPTR and SRV records, the value is a combination of multiple properties, so use Excel's concat method to combine these properties.	Data engineer, Excel skills

Task	Description	Skills required
	<pre> Fqdn\ Record Value TTL e somet A 1.1.1.1 900 .exam  org </pre>	
<p>Verify the working environment.</p>	<p>In the AWS Cloud9 IDE, create a Python file to convert the Excel input worksheet to JSON format. (Instead of AWS Cloud9, you can also use an Amazon SageMaker notebook to work with Python code.)</p> <p>Verify that the Python version you're using is version 3.7 or later.</p> <pre>python3 --version</pre> <p>Install the <b>pandas</b> package.</p> <pre>pip3 install pandas --user</pre>	<p>General AWS</p>



Task	Description	Skills required
Convert the Excel worksheet data to JSON.	<p>Create a Python file that contains the following code to convert from Excel to JSON.</p> <pre data-bbox="594 443 1027 722">import pandas as pd data=pd.read_excel('./Book1.xls') data.to_json(path_or_buf='my.json', orient='records')</pre> <p>where Book1 is the name of the Excel worksheet and my.json is the name of the output JSON file.</p>	Data engineer, Python skills
Upload the JSON file to an S3 bucket.	Upload the my.json file to an S3 bucket. For more information, see <a href="#">Creating a bucket</a> in the Amazon S3 documentation.	App developer

## Insert records

Task	Description	Skills required
Create a private hosted zone.	Use the <a href="#">create_hosted_zone</a> API and the following Python sample code to create a private hosted zone. Replace the parameters hostedZoneName, vpcRegion, and vpcId with your own values.	Cloud architect, Network administrator, Python skills

Task	Description	Skills required
	<pre data-bbox="592 220 1031 1596">import boto3 import random hostedZoneName = "xxx" vpcRegion = "us-east-1" vpcId="vpc-xxxx" route53_client =     boto3.client('route53') response = route53_client.create_hosted_zone(     Name= hostedZoneName,     VPC={         'VPCRegion':             vpcRegion,         'VPCId':             vpcId     },     CallerReference=str(random.random()*100000),     HostedZoneConfig={         'Comment': "private hosted zone created by automation",         'PrivateZone': True     } ) print(response)</pre> <p data-bbox="592 1638 1031 1858">You can also use an infrastructure as code (IaC) tool such as AWS CloudFormation to replace these steps with a template that creates a</p>	

Task	Description	Skills required
	stack with the appropriate resources and properties.	
Retrieve details as a dictionary from Amazon S3.	<p>Use the following code to read from the S3 bucket and to get the JSON values as a Python dictionary.</p> <pre data-bbox="597 556 1026 1150">fileobj = s3_client .get_object(     Bucket=bu cket_name,     Key='my.json' ) filedata = fileobj[' Body'].read() contents = filedata. decode('utf-8') json_content=json. loads(contents) print(json_content )</pre> <p>where json_content contains the Python dictionary.</p>	App developer, Python skills

Task	Description	Skills required
Clean data values for spaces and Unicode characters.	<p>As a safety measure to ensure the correctness of data, use the following code to perform a strip operation on the values in <code>json_content</code> . This code removes the space characters at the front and end of each string. It also uses the <code>replace</code> method to remove hard (non-breaking) spaces (the <code>\xa0</code> characters).</p> <pre data-bbox="594 779 1029 1495">for item in json_content:     fqdn_name = uncodeda     ta.normalize("NFKD     ",item["FqdnName"]     .replace("u'",     "").replace('\xa0',     '').strip())     rec_type = item["Rec     ordType"].replace(     '\xa0', '').strip()     res_rec = {      'Value': item["Val     ue"].replace('\xa0',     '').strip()      }</pre>	App developer, Python skills

Task	Description	Skills required
Insert records.	<p>Use the following code as part of the previous for loop.</p> <pre data-bbox="594 348 1027 1738">change_response =     route53_client.change_resource_record_sets(         HostedZoneId="xxxxxxxx",         ChangeBatch={             'Comment': 'Created by automation',             'Changes': [                 {                     'Action': 'UPSERT',                     'ResourceRecordSet': {                         'Name': fqdn_name,                         'Type': rec_type,                         'TTL': item["TTL"],                         'ResourceRecords':                             res_rec                     }                 }             ]         }     )</pre>	App developer, Python skills

Task	Description	Skills required
	Where xxxxxxxx is the hosted zone ID from the first step of this epic.	

## Related resources

### References

- [Creating records by importing a zone file](#) (Amazon Route 53 documentation)
- [create\\_hosted\\_zone method](#) (Boto3 documentation)
- [change\\_resource\\_record\\_sets method](#) (Boto3 documentation)

### Tutorials and videos

- [The Python Tutorial](#) (Python documentation)
- [DNS design using Amazon Route 53](#) (YouTube video, *AWS Online Tech Talks*)

# Modify HTTP headers when you migrate from F5 to an Application Load Balancer on AWS

Created by Sachin Trivedi (AWS)

<b>Environment:</b> PoC or pilot	<b>Source:</b> On-Premise	<b>Target:</b> AWS Cloud
<b>R Type:</b> Replatform	<b>Workload:</b> All other workloads	<b>Technologies:</b> Networking; Hybrid cloud; Migration

**AWS services:** Amazon CloudFront; Elastic Load Balancing (ELB); AWS Lambda

## Summary

When you migrate an application that uses an F5 Load balancer to Amazon Web Services (AWS) and want to use an Application Load Balancer on AWS, migrating F5 rules for header modifications is a common problem. An Application Load Balancer doesn't support header modifications, but you can use Amazon CloudFront as a content delivery network (CDN) and Lambda@Edge to modify headers.

This pattern describes the required integrations and provides sample code for header modification by using AWS CloudFront and Lambda@Edge.

## Prerequisites and limitations

### Prerequisites

- An on-premises application that uses an F5 load balancer with a configuration that replaces the HTTP header value by using `if`, `else`. For more information about this configuration, see [HTTP::header](#) in the F5 product documentation.

### Limitations

- This pattern applies to F5 load balancer header customization. For other third-party load balancers, please check the load balancer documentation for support information.

- The Lambda functions that you use for Lambda@Edge must be in the US East (N. Virginia) Region.

## Architecture

The following diagram shows the architecture on AWS, including the integration flow between the CDN and other AWS components.

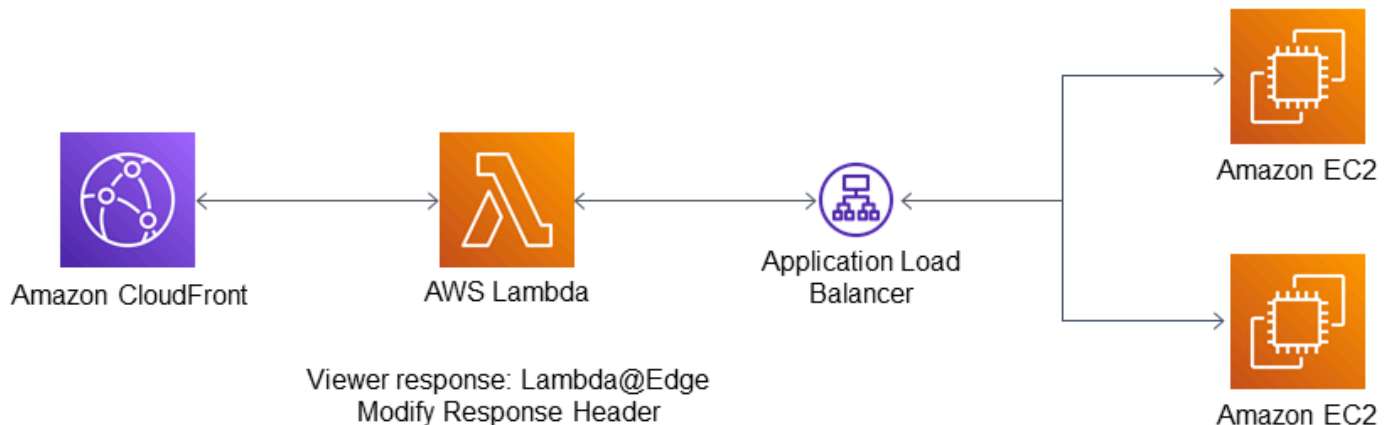

## Tools

### AWS services

- [Application Load Balancer](#) – An Application Load Balancer is an AWS fully managed load balancing service that functions at the seventh layer of the Open Systems Interconnection (OSI) model. It balances traffic across multiple targets and supports advanced routing requests based on HTTP headers and methods, query strings, and host-based or path-based routing.
- [Amazon CloudFront](#) – Amazon CloudFront is a web service that speeds up the distribution of your static and dynamic web content, such as .html, .css, .js, and image files, to your users. CloudFront delivers your content through a worldwide network of data centers called edge locations for lower latency and improved performance.
- [Lambda@Edge](#) – Lambda@Edge is an extension of AWS Lambda that lets you run functions to customize the content that CloudFront delivers. You can author functions in the US East (N. Virginia) Region, and then associate the function with a CloudFront distribution to automatically



replicate your code around the world, without provisioning or managing servers. This reduces latency and improves the user experience.

## Code

The following sample code provides a blueprint for modifying CloudFront response headers. Follow the instructions in the *Epics* section to deploy the code.

```
exports.handler = async (event, context) => {
  const response = event.Records[0].cf.response;
  const headers = response.headers;

  const headerNameSrc = 'content-security-policy';
  const headerNameValue = '*.xyz.com';

  if (headers[headerNameSrc.toLowerCase()]) {
    headers[headerNameSrc.toLowerCase()] = [{
      key: headerNameSrc,
      value: headerNameValue,
    }];
    console.log(`Response header "${headerNameSrc}" was set to ` +
      `${headers[headerNameSrc.toLowerCase()][0].value}`);
  }
  else {
    headers[headerNameSrc.toLowerCase()] = [{
      key: headerNameSrc,
      value: headerNameValue,
    }];
  }
  return response;
};
```

# Epics

## Create a CDN distribution

Task	Description	Skills required
Create a CloudFront web distribution.	<p>In this step, you create a CloudFront distribution to tell CloudFront where you want content to be delivered from, and the details about how to track and manage content delivery.</p> <p>To create a distribution by using the console, sign in to the AWS Management Console, open the <a href="#">CloudFront console</a>, and then follow the steps in the <a href="#">CloudFront documentation</a>.</p>	Cloud administrator

## Create and deploy the Lambda@Edge function

Task	Description	Skills required
Create and deploy a Lambda@Edge function.	You can create a Lambda@Edge function by using a blueprint for modifying CloudFront response headers. (Other blueprints are available for different use cases; for more information, see <a href="#">Lambda@Edge example functions</a> in the CloudFront documentation.)	AWS administrator

Task	Description	Skills required
	<p>To create a Lambda@Edge function:</p> <ol style="list-style-type: none"><li>1. Sign in to the AWS Management Console and open the AWS Lambda console at <a href="https://console.aws.amazon.com/lambda/">https://console.aws.amazon.com/lambda/</a>.</li><li>2. Make sure that you're in the US East (N. Virginia) Region. CloudFront blueprints are available only in this Region.</li><li>3. Choose <b>Create function</b>.</li><li>4. Choose <b>Use a blueprint</b>, and then enter <b>cloudfront</b> in the <b>Blueprints</b> search field.</li><li>5. Choose the <b>cloudfront-modify-response-header</b> blueprint, and then choose <b>Configure</b>.</li><li>6. On the <b>Basic information</b> page, enter the following information:<ol style="list-style-type: none"><li>a. Enter a function name.</li><li>b. For <b>Execution role</b>, choose <b>Create a new role from AWS policy templates</b>.</li><li>c. Associate the required AWS Identity and Access</li></ol></li></ol>	

Task	Description	Skills required
	<p>Management (IAM) role name.</p> <p>7. Choose <b>Create function</b>.</p> <p>8. In the <b>Designer</b> section of the page, choose your function name.</p> <p>9. In the <b>Function code</b> section, replace the template code with the sample code provided previously in this pattern, in the <i>Code</i> section.</p> <p>10 In the sample code, replace <code>xyz.com</code> with your domain name.</p> <p>11 Choose <b>Save</b>.</p>	
Deploy the Lambda@Edge function.	Follow the instructions in <a href="#">step 4</a> of the <i>Tutorial: Creating a simple Lambda@Edge function</i> in the Amazon CloudFront documentation to configure the CloudFront trigger and deploy the function.	AWS administrator

## Related resources

### CloudFront documentation

- [Request and response behavior for custom origins](#)
- [Working with distributions](#)
- [Lambda@Edge example functions](#)

- [Customizing at the edge with Lambda@Edge](#)
- [Tutorial: Creating a simple Lambda@Edge function](#)

# Peer VPCs in different AWS Regions by using AWS Transit Gateway

*Created by Durga Prasad Cheepuri (AWS) and Armin Gradiscevic (AWS)*

**Environment:** PoC or pilot

**Technologies:** Networking

**AWS services:** Amazon VPC

## Summary

A virtual private cloud (VPC) is a virtual network dedicated to your AWS account. It is logically isolated from other virtual networks in the AWS Cloud. You can launch AWS resources, such as Amazon Elastic Compute Cloud (Amazon EC2) instances, into your VPCs. When you create a peering connection between two VPCs, resources in those VPCs can communicate with each other as if they are within the same network.

There are two primary means of creating peering connections between VPCs in the AWS Cloud:

- [VPC peering](#) – This type of connection is created in Amazon Virtual Private Cloud (Amazon VPC). It directly connects VPCs without requiring any additional resources or attachments. If you need to connect more than two VPCs, then the peering connections between each of the VPCs establishes a mesh network. This peering approach is suitable for connecting a small number of VPCs.
- [Transit gateway peering attachments](#) – This is an AWS Transit Gateway connection, and it is also managed through Amazon VPC. Transit Gateway uses a hub-and-spoke model to connect multiple VPCs and on-premises networks. This approach supports transitive routing between VPCs, even if they're not directly peered. This peering approach is suitable if you need to connect a large number of VPCs or other networks because it requires less network maintenance. Unlike VPC peering, transit gateways can seamlessly integrate with a virtual private network (VPN), and for hybrid networks, they can integrate with AWS Direct Connect.

This pattern provides instructions for creating a transit gateway peering connection between two VPCs that are in the same AWS account but are in different AWS Regions. You can reuse this pattern to create a hub-and-spoke network model to connect hybrid networks within a single AWS account or across multiple accounts. This solution creates a transit gateway in each Region and

then configures the transit gateways and route tables to support inter-Region communication between the target VPCs, which are in the same account.

## Prerequisites and limitations

### Prerequisites

- An active AWS account.
- Two VPCs that are in the same AWS account and different AWS Regions. For more information, see [Create a VPC](#).
- Permissions required to work with transit gateways. For more information, see [Identity and access management for your transit gateways](#).

### Limitations

- The VPCs must not have overlapping CIDR blocks.

## Architecture

The following image shows how a transit gateway peering attachment is used to connect VPC in different AWS Regions. This connection supports communication between resources in the VPCs, such as between Amazon EC2 instances.

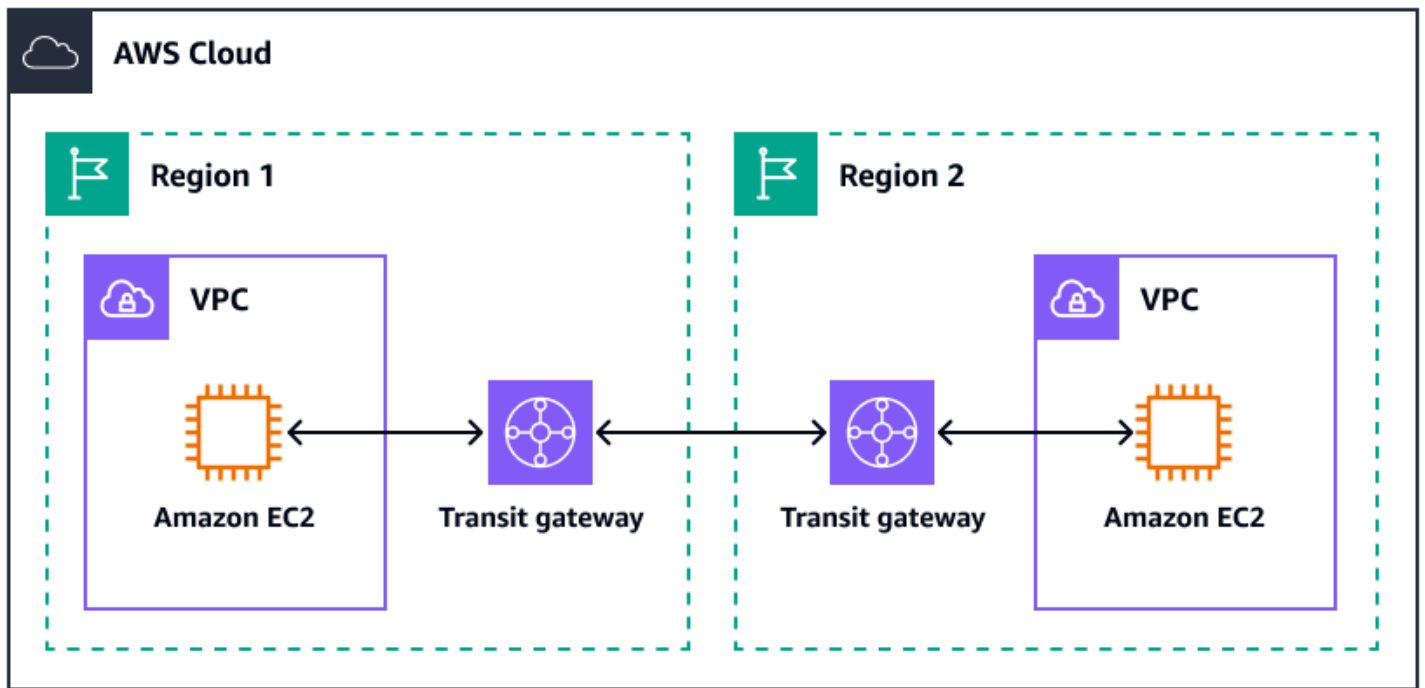

## Tools

- [AWS Transit Gateway](#) is a central hub that connects VPCs and on-premises networks.
- [Amazon Virtual Private Cloud \(Amazon VPC\)](#) helps you launch AWS resources into a virtual network that you've defined. This virtual network resembles a traditional network that you'd operate in your own data center, with the benefits of using the scalable infrastructure of AWS.

## Epics

### Create the transit gateways

Task	Description	Skills required
Create a transit gateway in each Region.	<ol style="list-style-type: none"> <li>1. In Region 1, create a transit gateway. For instructions, see <a href="#">Create a transit gateway</a>.</li> <li>2. Repeat the previous step to create a transit gateway in Region 2.</li> </ol>	General AWS



Task	Description	Skills required
	<ol style="list-style-type: none"><li>3. Make note of the new transit gateway IDs. You need these values later.</li></ol>	
Create an attachment for each VPC.	<ol style="list-style-type: none"><li>1. In Region 1, create a VPC attachment to the transit gateway. Select all of the subnets in the VPC. For instructions, see <a href="#">Attach your VPCs to your transit gateway</a>.</li><li>2. Repeat the previous step to create a VPC attachment for the transit gateway in Region 2. Select all of the subnets in the VPC.</li></ol>	General AWS

Task	Description	Skills required
Create a peering attachment.	<ol style="list-style-type: none"><li>1. Open the <a href="#">Amazon VPC console</a>.</li><li>2. In the Region selector, choose Region 1.</li><li>3. In the navigation pane, choose <b>Transit Gateway Attachments</b>.</li><li>4. Choose <b>Create transit gateway attachment</b>.</li><li>5. For <b>Transit gateway ID</b>, choose the transit gateway that you created in Region 1.</li><li>6. For <b>Attachment type</b>, choose <b>Peering Connection</b>.</li><li>7. For <b>Account</b>, choose <b>My account</b>.</li><li>8. For <b>Region</b>, choose Region 2.</li><li>9. For <b>Transit gateway (accepter)</b>, enter the ID of the transit gateway in Region 2.</li><li>10. Choose <b>Create transit gateway attachment</b>.</li></ol>	General AWS

Task	Description	Skills required
Accept the peering attachment request.	<ol style="list-style-type: none"><li>1. Open the <a href="#">Amazon VPC console</a>.</li><li>2. In the Region selector, choose Region 2.</li><li>3. In the navigation pane, choose <b>Transit Gateway Attachments</b>.</li><li>4. Select the transit gateway peering attachment that is pending acceptance.</li><li>5. Choose <b>Actions</b>, and then choose <b>Accept transit gateway attachment</b>.</li></ol>	General AWS

## Configure routing

Task	Description	Skills required
Configure the VPC route table in Region 1.	<ol style="list-style-type: none"><li>1. Open the <a href="#">Amazon VPC console</a>.</li><li>2. In the Region selector, choose Region 1.</li><li>3. In the navigation pane, choose <b>Route tables</b>.</li><li>4. Select the route table used by the VPC in this Region.</li><li>5. Choose <b>Actions</b>, and then choose <b>Edit routes</b>.</li><li>6. Choose <b>Add route</b>.</li><li>7. For <b>Destination</b>, enter the CIDR block of the VPC in Region 2.</li></ol>	General AWS

Task	Description	Skills required
	<ol style="list-style-type: none"><li>8. For <b>Target</b>, choose <b>Transit Gateway</b>, and then enter the ID of the transit gateway in Region 1.</li><li>9. Choose <b>Save changes</b>.</li></ol>	
Configure the VPC route table in Region 2.	<ol style="list-style-type: none"><li>1. Open the <a href="#">Amazon VPC console</a>.</li><li>2. In the Region selector, choose Region 2.</li><li>3. In the navigation pane, choose <b>Route tables</b>.</li><li>4. Select the route table used by the VPC in this Region.</li><li>5. Choose <b>Actions</b>, and then choose <b>Edit routes</b>.</li><li>6. Choose <b>Add route</b>.</li><li>7. For <b>Destination</b>, enter the CIDR block of the VPC in Region 1.</li><li>8. For <b>Target</b>, choose <b>Transit Gateway</b>, and then enter the ID of the transit gateway in Region 2.</li><li>9. Choose <b>Save changes</b>.</li></ol>	General AWS

Task	Description	Skills required
Attach the transit gateway in Region 1 to the VPC in Region 2.	<ol style="list-style-type: none"><li>1. Open the <a href="#">Amazon VPC console</a>.</li><li>2. In the Region selector, choose Region 1.</li><li>3. In the navigation pane, choose <b>Transit Gateway Attachments</b>.</li><li>4. Choose <b>Create transit gateway attachment</b>.</li><li>5. For <b>Transit gateway ID</b>, choose the transit gateway that you created in Region 1.</li><li>6. For <b>Attachment type</b>, choose <b>VPC</b>.</li><li>7. For <b>VPC ID</b>, enter the ID of the VPC in Region 2.</li><li>8. For <b>Subnet IDs</b>, select one subnet for each Availability Zone to be used by the transit gateway to route traffic.</li><li>9. Choose <b>Create transit gateway attachment</b>.</li></ol>	General AWS

Task	Description	Skills required
Attach the transit gateway in Region 2 to the VPC in Region 1.	<ol style="list-style-type: none"><li>1. Open the <a href="#">Amazon VPC console</a>.</li><li>2. In the Region selector, choose Region 2.</li><li>3. In the navigation pane, choose <b>Transit Gateway Attachments</b>.</li><li>4. Choose <b>Create transit gateway attachment</b>.</li><li>5. For <b>Transit gateway ID</b>, choose the transit gateway that you created in Region 2.</li><li>6. For <b>Attachment type</b>, choose <b>VPC</b>.</li><li>7. For <b>VPC ID</b>, enter the ID of the VPC in Region 1.</li><li>8. For <b>Subnet IDs</b>, select one subnet for each Availability Zone to be used by the transit gateway to route traffic.</li><li>9. Choose <b>Create transit gateway attachment</b>.</li></ol>	General AWS

Task	Description	Skills required
Configure the transit gateway route table in Region 1.	<ol style="list-style-type: none"><li>1. Open the <a href="#">Amazon VPC console</a>.</li><li>2. In the Region selector, choose Region 1.</li><li>3. In the navigation pane, choose <b>Transit gateway route tables</b>.</li><li>4. Select the route table used by the transit gateway in Region 1.</li><li>5. Choose <b>Actions</b>, and then choose <b>Create static route</b>.</li><li>6. On the <b>Create static route page</b>, enter the CIDR block for the VPC in Region 2.</li><li>7. For <b>attachment</b>, choose the attachment created for the VPC in Region 2.</li><li>8. Choose <b>Create static route</b>.</li><li>9. Repeat the previous steps to create another route. Provide the following values:<ul style="list-style-type: none"><li>• Enter the CIDR block for the VPC in Region 1.</li><li>• Choose the attachment created for the VPC in Region 1.</li></ul></li></ol>	General AWS

Task	Description	Skills required
Configure the transit gateway route table in Region 2.	<ol style="list-style-type: none"><li>1. Open the <a href="#">Amazon VPC console</a>.</li><li>2. In the Region selector, choose Region 2.</li><li>3. In the navigation pane, choose <b>Transit gateway route tables</b>.</li><li>4. Select the route table used by the transit gateway in Region 2.</li><li>5. Choose <b>Actions</b>, and then choose <b>Create static route</b>.</li><li>6. On the <b>Create static route page</b>, enter the CIDR block for the VPC in Region 1.</li><li>7. For <b>attachment</b>, choose the attachment created for the VPC in Region 1.</li><li>8. Choose <b>Create static route</b>.</li><li>9. Repeat the previous steps to create another route. Provide the following values:<ul style="list-style-type: none"><li>• Enter the CIDR block for the VPC in Region 2.</li><li>• Choose the attachment created for the VPC in Region 2.</li></ul></li></ol>	General AWS



## Test the peering connection

Task	Description	Skills required
Create EC2 instances.	<ol style="list-style-type: none"><li data-bbox="591 310 1027 772">1. In the VPC in Region 1, create an EC2 instance. For instructions, see <a href="#">Launch an instance</a>. Create the instance in any subnet that has an inbound security group rule that accepts ICMP traffic from the CIDR block of the VPC in Region 2.</li><li data-bbox="591 800 1027 1213">2. Repeat the previous step to create an EC2 instance in the VPC in Region 2. Create the instance in any subnet that has an inbound security group rule that accepts ICMP traffic from the CIDR block of the VPC in Region 1.</li></ol>	General AWS
Test the peering connection.	<ol style="list-style-type: none"><li data-bbox="591 1262 1027 1535">1. Use Session Manager, a capability of AWS Systems Manager, to connect to one of the EC2 instances. For instructions, see <a href="#">Connect using Session Manager</a>.</li><li data-bbox="591 1562 1027 1875">2. Enter the following command to initiate a ping to the other EC2 instance, where &lt;targetname&gt; is the host name or IP address of the other EC2 instance.</li></ol>	General AWS

Task	Description	Skills required
	<pre data-bbox="630 212 1027 327">\$ ping [options] &lt;targetname&gt;</pre> <p data-bbox="591 342 1016 615">3. Confirm that the ping was successful. This validates that the peering connection has been established between the two VPCs in different Regions.</p>	

## Troubleshooting

Issue	Solution
<p data-bbox="112 951 776 1035">Ping between EC2 instances does not return a reply.</p>	<ol data-bbox="829 951 1503 1724" style="list-style-type: none"> <li>1. Verify that the security groups attached to the instances allow ICMPv4 inbound pings from the appropriate CIDR blocks. For more information, see <a href="#">Control traffic to your AWS resources using security groups</a>.</li> <li>2. Verify that the VPC route table has a route to the other CIDR block. The route should point toward the transit gateway as the next-hop. For more information, see <a href="#">Work with route tables</a>.</li> <li>3. Verify that the transit gateway route table has a route to the other CIDR block. The route should point toward the peering attachment as the next-hop. For more information, see <a href="#">Transit gateway route tables</a>.</li> </ol>

## Related resources

- [What is a transit gateway?](#)
- [Getting started with transit gateways](#)
- [Transit gateway peering attachments](#)
- [Transit gateway route tables](#)
- [Work with route tables](#)

# Privately access a central AWS service endpoint from multiple VPCs

Created by Martin Guenther (AWS) and Samuel Gordon (AWS)

**Code repository:** [VPC Endpoint Sharing](#)

**Environment:** Production

**Technologies:** Networking; Infrastructure

**AWS services:** AWS RAM; Amazon Route 53; Amazon SNS; AWS Transit Gateway; Amazon VPC

## Summary

Security and compliance requirements for your environment might specify that traffic to Amazon Web Services (AWS) services or endpoints must not traverse the public internet. This pattern is a solution that is designed for a *hub-and-spoke* topology, where a central *hub* VPC is connected to multiple, distributed *spoke* VPCs. In this solution, you use AWS PrivateLink to create an interface VPC endpoint for the AWS service in the hub account. Then, you use transit gateways and a distributed Domain Name System (DNS) rule to resolve requests to the private IP address of the endpoint, across the connected VPCs.

This pattern describes how to use AWS Transit Gateway, an inbound Amazon Route 53 Resolver endpoint, and a shared Route 53 forwarding rule in order to resolve the DNS queries from the resources in connected VPCs. You create the endpoint, transit gateway, Resolver, and forwarding rule in the hub account. Then, you use AWS Resource Access Manager (AWS RAM) to share the transit gateway and the forwarding rule with the spoke VPCs. The AWS CloudFormation templates provided help you deploy and configure the resources in the hub VPC and spoke VPCs.

## Prerequisites and limitations

### Prerequisites

- A hub account and one or more spoke accounts, managed in the same organization in AWS Organizations. For more information, see [Creating and managing an organization](#).

- AWS Resource Access Manager (AWS RAM) is configured as a trusted service in AWS Organizations. For more information, see [Using AWS Organizations with other AWS services](#).
- DNS resolution must be enabled in the hub and spoke VPCs. For more information, see [DNS attributes for your VPC](#) (Amazon Virtual Private Cloud documentation).

## Limitations

- This pattern connects hub and spoke accounts in the same AWS Region. For multi-Region deployments, you must repeat this pattern for each Region.
- The AWS service must integrate with PrivateLink as an interface VPC endpoint. For a complete list, see [AWS services that integrate with AWS PrivateLink](#) (PrivateLink documentation).
- Availability Zone affinity is not guaranteed. For example, queries from Availability Zone A might respond with an IP address from Availability Zone B.
- The elastic network interface associated to the VPC endpoint has a limit of 10,000 queries per second.

## Architecture

### Target technology stack

- A hub VPC in the hub AWS account
- One or more spoke VPCs in a spoke AWS account
- One or more interface VPC endpoints in the hub account
- Inbound and outbound Route 53 Resolvers in the hub account
- A Route 53 Resolver forwarding rule deployed in the hub account and shared with the spoke account
- A transit gateway deployed in the hub account and shared with the spoke account
- AWS Transit Gateway connecting the hub and spoke VPCs

### Target architecture

The following image shows a sample architecture for this solution. In this architecture, the Route 53 Resolver forwarding rule in the hub account has the following relationship with the other architecture components:

1. The forwarding rule is shared with the spoke VPC by using AWS RAM.
2. The forwarding rule is associated with the outbound Resolver in the hub VPC.
3. The forwarding rule targets the inbound Resolver in the hub VPC.

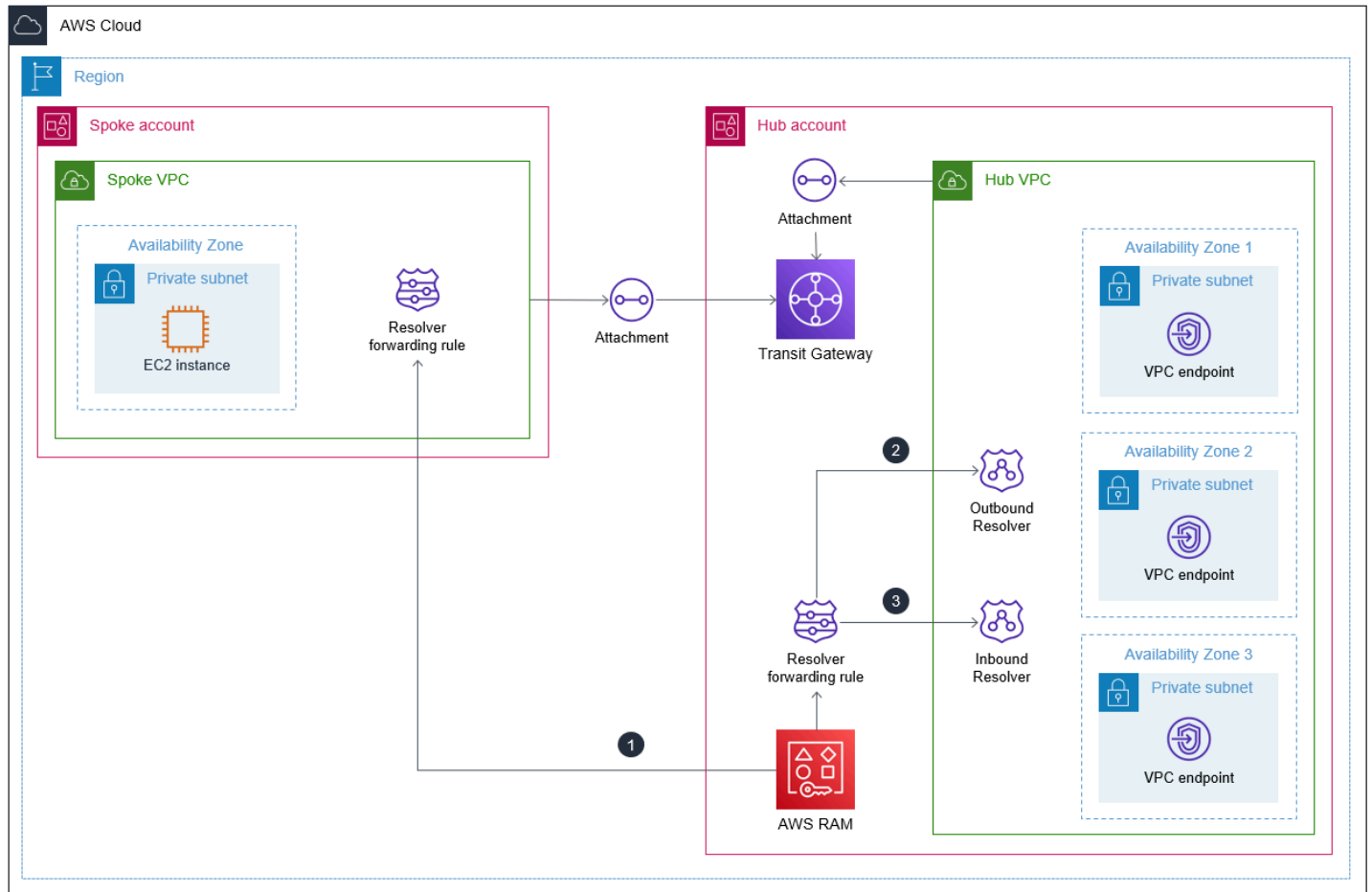

The following image shows the flow of traffic through the sample architecture:

1. A resource, such as an Amazon Elastic Compute Cloud (Amazon EC2) instance, in the spoke VPC makes a DNS request to `<service>.<region>.amazonaws.com`. The request is received by the spoke Amazon DNS Resolver.
2. The Route 53 forwarding rule, which is shared from the hub account and associated to the spoke VPC, intercepts the request.
3. In the hub VPC, the outbound Resolver uses the forwarding rule to forward the request to the inbound Resolver.

- The inbound Resolver uses the hub VPC Amazon DNS Resolver to resolve the IP address for `<service>.<region>.amazonaws.com` to the private IP address of a VPC endpoint. If no VPC endpoint is present, it resolves to the public IP address.

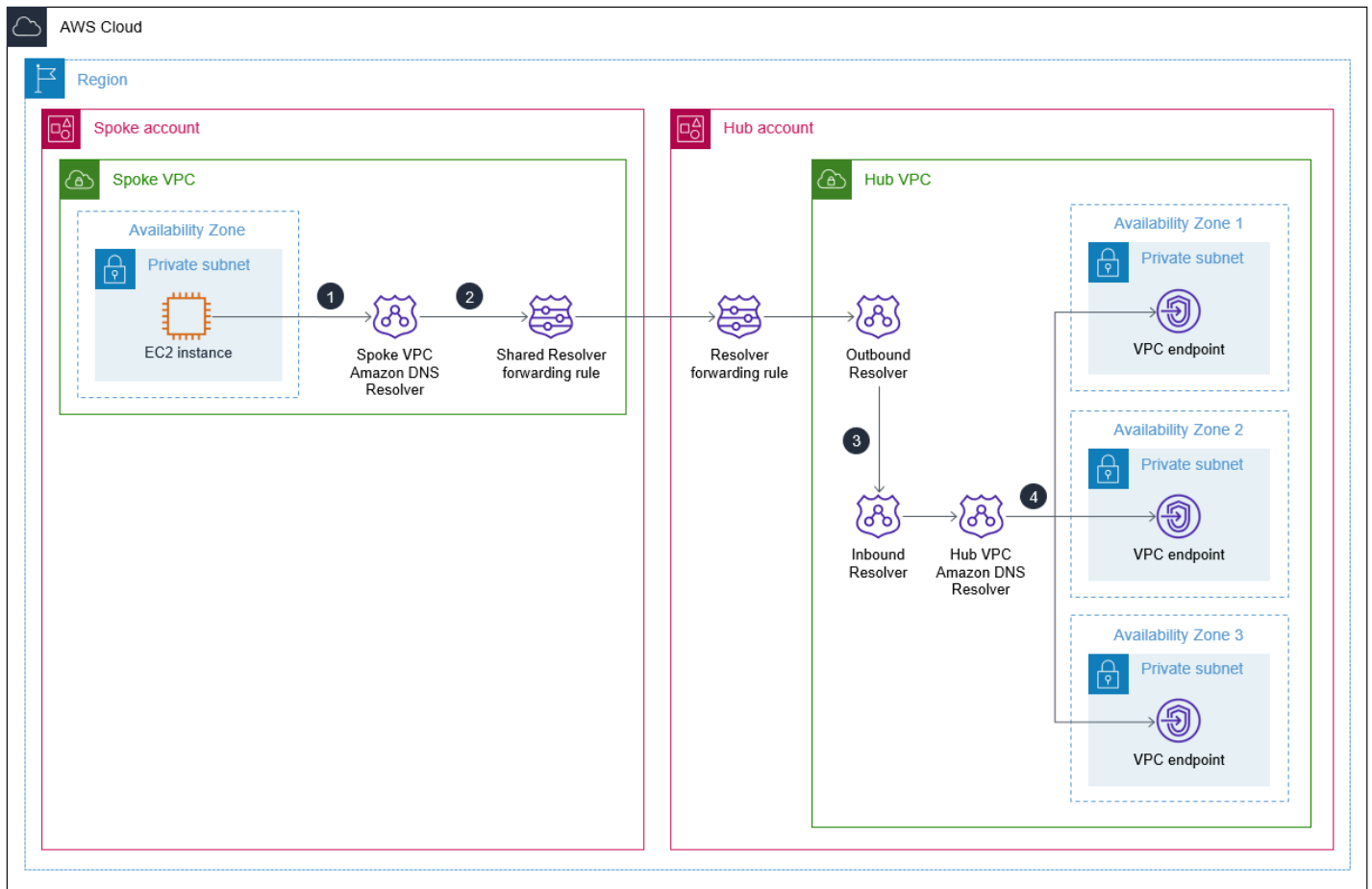

## Tools

### AWS tools and services

- [AWS CloudFormation](#) helps you set up AWS resources, provision them quickly and consistently, and manage them throughout their lifecycle across AWS accounts and Regions.
- [Amazon Elastic Compute Cloud \(Amazon EC2\)](#) provides scalable computing capacity in the AWS Cloud. You can launch as many virtual servers as you need, and quickly scale them up or down.
- [AWS Identity and Access Management \(IAM\)](#) helps you securely manage access to your AWS resources by controlling who is authenticated and authorized to use them.

- [AWS Resource Access Manager \(AWS RAM\)](#) helps you securely share your resources across AWS accounts to reduce operational overhead and provide visibility and auditability.
- [Amazon Route 53](#) is a highly available and scalable Domain Name System (DNS) web service.
- [AWS Systems Manager](#) helps you manage your applications and infrastructure running in the AWS Cloud. It simplifies application and resource management, shortens the time to detect and resolve operational problems, and helps you manage your AWS resources securely at scale.
- [AWS Transit Gateway](#) is a central hub that connects VPCs and on-premises networks.
- [Amazon Virtual Private Cloud \(Amazon VPC\)](#) helps you launch AWS resources into a virtual network that you've defined. This virtual network resembles a traditional network that you'd operate in your own data center, with the benefits of using the scalable infrastructure of AWS.

### Other tools and services

- [nslookup](#) is a command-line tool used to query DNS records. In this pattern, you use this tool to test the solution.

### Code repository

The code for this pattern is available on GitHub, in the [vpc-endpoint-sharing](#) repository. This pattern provides two AWS CloudFormation templates:

- A template for deploying the following resources in the hub account:
  - `rSecurityGroupEndpoints` – The security group that controls access to the VPC endpoint.
  - `rSecurityGroupResolvers` – The security group that controls access to the Route 53 Resolver.
  - `rKMSEndpoint`, `rSSMMessagesEndpoint`, `rSSEndpoint`, and `rEC2MessagesEndpoint` – Example interface VPC endpoints in the hub account. Customize these endpoints for your use case.
  - `rInboundResolver` – A Route 53 Resolver that resolves DNS queries against the hub Amazon DNS Resolver.
  - `rOutboundResolver` – An outbound Route 53 Resolver that forwards queries to the inbound Resolver.
  - `rAWSApiResolverRule` – The Route 53 Resolver forwarding rule that is shared with all spoke VPCs.



- `rRamShareAWSResolverRule` – The AWS RAM share that allows the spoke VPCs to use the `rAWSApiResolverRule` forwarding rule.
- `*rVPC` – The hub VPC, used to model the shared services.
- `*rSubnet1` – A private subnet used to house the hub resources.
- `*rRouteTable1` – The route table for the hub VPC.
- `*rRouteTableAssociation1` – For the `rRouteTable1` route table in the hub VPC, the association for the private subnet.
- `*rRouteSpoke` – The route from the hub VPC to the spoke VPC.
- `*rTgw` – The transit gateway that is shared with all spoke VPCs.
- `*rTgwAttach` – The attachment that allows the hub VPC to route traffic to the `rTgw` transit gateway.
- `*rTgwShare` – The AWS RAM share that allows the spoke accounts to use the `rTgw` transit gateway.
- A template for deploying the following resources in the spoke accounts:
  - `rAWSApiResolverRuleAssociation` – An association that allows the spoke VPC to use the shared forwarding rule in the hub account.
  - `*rVPC` – The spoke VPC.
  - `*rSubnet1`, `rSubnet2`, `rSubnet3` – A subnet for each Availability Zone, used to house the spoke private resources.
  - `*rTgwAttach` – The attachment that allows the spoke VPC to route traffic to the `rTgw` transit gateway.
  - `*rRouteTable1` – The route table for the spoke VPC.
  - `*rRouteEndpoints` – The route from the resources in the spoke VPC to the transit gateway.
  - `*rRouteTableAssociation1/2/3` – For the `rRouteTable1` route table in the spoke VPC, the associations for the private subnets.
  - `*rInstanceRole` – The IAM role used to test the solution.
  - `*rInstancePolicy` – The IAM policy used to test the solution.
  - `*rInstanceSg` – The security group used to test the solution.
  - `*rInstanceProfile` – The IAM instance profile used to test the solution.
  - `*rInstance` – An EC2 instance preconfigured for access through AWS Systems Manager. Use [this instance to test the solution](#).

\* These resources support the sample architecture and might not be required when implementing this pattern in an existing landing zone.

## Epics

### Prepare the CloudFormation templates

Task	Description	Skills required
Clone the code repository.	<ol style="list-style-type: none"><li>1. In a command-line interface, change your working directory to the location where you want to store the sample files.</li><li>2. Enter the following command: <pre>git clone https://github.com/aws-samples/vpc-endpoint-sharing.git</pre></li></ol>	Network administrator, Cloud architect
Modify the templates.	<ol style="list-style-type: none"><li>1. In the cloned repository, open the <b>hub.yml</b> and <b>spoke.yml</b> files.</li><li>2. Review the resources created by these templates and adjust the templates as needed for your environment. For a complete list, see the <i>Code repository</i> section in <a href="#">Tools</a>. If your accounts already have some of these resources, remove them from the CloudFormation template. For more</li></ol>	Network administrator, Cloud architect

Task	Description	Skills required
	<p>information, see <a href="#">Working with templates</a> (CloudFormation documentation).</p> <p>3. Save and close the <b>hub.yml</b> and <b>spoke.yml</b> files.</p>	

## Deploy the resources in the target accounts

Task	Description	Skills required
Deploy the hub resources.	Using the <b>hub.yml</b> template, create a CloudFormation stack. When prompted, provide values for the parameters in the template. For more information, see <a href="#">Creating a stack</a> (CloudFormation documentation).	Cloud architect, Network administrator
Deploy the spoke resources.	Using the <b>spoke.yml</b> template, create a CloudFormation stack. When prompted, provide values for the parameters in the template. For more information, see <a href="#">Creating a stack</a> (CloudFormation documentation).	Cloud architect, Network administrator

## Test the solution

Task	Description	Skills required
Test private DNS queries to the AWS service.	<ol style="list-style-type: none"><li data-bbox="591 331 1027 793">1. Connect to the rInstance EC2 instance by using Session Manager, a capability of AWS Systems Manager. For more information, see <a href="#">Connect to your Linux instance using Session Manager</a> (Amazon EC2 documentation).</li><li data-bbox="591 821 1013 1136">2. For an AWS service that has a VPC endpoint in the hub account, use <code>nslookup</code> to confirm that the private IP addresses for the inbound Route 53 Resolver are returned.  The following is an example of using <code>nslookup</code> to reach an Amazon Systems Manager endpoint.  <pre data-bbox="630 1444 1027 1566">nslookup ssm.&lt;region&gt;.amazonaws.com</pre></li><li data-bbox="591 1583 1013 1852">3. In the AWS Command Line Interface (AWS CLI), enter a command that can help you confirm that the changes did not affect the service functionality. For a</li></ol>	Network administrator

Task	Description	Skills required
	<p>list of commands, see <a href="#">AWS CLI Command Reference</a>.</p> <p>For example, the following command should return a list of Amazon Systems Manager documents.</p> <pre>aws ssm list-documents</pre>	

Task	Description	Skills required
Test public DNS queries to an AWS service.	<ol style="list-style-type: none"><li data-bbox="591 226 1027 741">1. For an AWS service that does <b>not</b> have a VPC endpoint in the hub account, use <code>nslookup</code> to confirm that the public IP addresses are returned. The following is an example of using <code>nslookup</code> to reach an Amazon Simple Notification Service (Amazon SNS) endpoint. <pre data-bbox="634 779 1027 894">nslookup sns.&lt;region&gt;.amazonaws.com</pre></li><li data-bbox="591 915 1027 1234">2. In the AWS CLI, enter a command that can help you confirm that the changes did not affect the service functionality. For a list of commands, see <a href="#">AWS CLI Command Reference</a>.  For example, if any Amazon SNS topics are present in the hub account, the following command should return a list of topics. <pre data-bbox="634 1587 1027 1667">aws sns list-topics</pre></li></ol>	Network administrator

## Related resources

- [Building a scalable and secure multi VPC AWS Network Infrastructure](#) (AWS whitepaper)
- [Working with shared resources](#) (AWS RAM documentation)
- [Working with transit gateways](#) (AWS Transit Gateway documentation)

# Create a report of Network Access Analyzer findings for inbound internet access in multiple AWS accounts

Created by Mike Virgilio (AWS)

**Code repository:** [Network Access Analyzer Multi-Account Analysis](#)

**Environment:** Production

**Technologies:** Networking; Security, identity, compliance

**AWS services:** AWS CloudFormation; Amazon S3; Amazon VPC; AWS Security Hub

## Summary

Unintentional inbound internet access to AWS resources can pose risks to an organization's data perimeter. [Network Access Analyzer](#) is an Amazon Virtual Private Cloud (Amazon VPC) feature that helps you identify unintended network access to your resources on Amazon Web Services (AWS). You can use Network Access Analyzer to specify your network access requirements and to identify potential network paths that do not meet your specified requirements. You can use Network Access Analyzer to do the following:

1. Identify AWS resources that are accessible to the internet through internet gateways.
2. Validate that your virtual private clouds (VPCs) are appropriately segmented, such as isolating production and development environments and separating transactional workloads.

Network Access Analyzer analyzes end-to-end network reachability conditions and not just a single component. To determine whether a resource is internet accessible, Network Access Analyzer evaluates the internet gateway, VPC route tables, network access control lists (ACLs), public IP addresses on elastic network interfaces, and security groups. If any of these components prevent internet access, Network Access Analyzer doesn't generate a finding. For example, if an Amazon Elastic Compute Cloud (Amazon EC2) instance has an open security group that allows traffic from 0/0 but the instance is in a private subnet that isn't routable from any internet gateway, then



Network Access Analyzer wouldn't generate a finding. This provides high-fidelity results so that you can identify resources that are truly accessible from the internet.

When you run Network Access Analyzer, you use [Network Access Scopes](#) to specify your network access requirements. This solution identifies network paths between an internet gateway and an elastic network interface. In this pattern, you deploy the solution in a centralized AWS account in your organization, managed by AWS Organizations, and it analyzes all of the accounts, in any AWS Region, in the organization.

This solution was designed with the following in mind:

- The AWS CloudFormation templates reduce the effort required to deploy the AWS resources in this pattern.
- You can adjust the parameters in the CloudFormation templates and **naa-script.sh** script at the time of deployment to customize them for your environment.
- Bash scripting automatically provisions and analyzes the Network Access Scopes for multiple accounts, in parallel.
- A Python script processes the findings, extracts the data, and then consolidates the results. You can choose to review the consolidated report of Network Access Analyzer findings in CSV format or in AWS Security Hub. An example of the CSV report is available in the [Additional information](#) section of this pattern.
- You can remediate findings, or you can exclude them from future analyses by adding them to the **naa-exclusions.csv** file.

## Prerequisites and limitations

### Prerequisites

- An AWS account for hosting security services and tools, managed as a member account of an organization in AWS Organizations. In this pattern, this account is referred to as the security account.
- In the security account, you must have a private subnet with outbound internet access. For instructions, see [Create a subnet](#) in the Amazon VPC documentation. You can establish internet access by using an [NAT gateway](#) or an [interface VPC endpoint](#).
- Access to the AWS Organizations management account or an account that has delegated administrator permissions for CloudFormation. For instructions, see [Register a delegated administrator](#) in the CloudFormation documentation.

- Enable trusted access between AWS Organizations and CloudFormation. For instructions, see [Enable trusted access with AWS Organizations](#) in the CloudFormation documentation.
- If you're uploading the findings to Security Hub, Security Hub must be enabled in the account and AWS Region where the EC2 instance is provisioned. For more information, see [Setting up AWS Security Hub](#).

## Limitations

- Cross-account network paths are not currently analyzed due to limitations of the Network Access Analyzer feature.
- The target AWS accounts must be managed as an organization in AWS Organizations. If you are not using AWS Organizations, you can update the **naa-execrole.yaml** CloudFormation template and the **naa-script.sh** script for your environment. Instead, you provide a list of AWS account IDs and Regions where you want to run the script.
- The CloudFormation template is designed to deploy the EC2 instance in a private subnet that has outbound internet access. The AWS Systems Manager Agent (SSM Agent) requires outbound access to reach the Systems Manager service endpoint, and you need outbound access to clone the code repository and install dependencies. If you want to use a public subnet, you must modify the **naa-resources.yaml** template to associate an [Elastic IP address](#) with the EC2 instance.

## Architecture

### Target technology stack

- Network Access Analyzer
- Amazon EC2 instance
- AWS Identity and Access Management (IAM) roles
- Amazon Simple Storage Service (Amazon S3) bucket
- Amazon Simple Notification Service (Amazon SNS) topic
- AWS Security Hub (Option 2 only)

### Target architecture

*Option 1: Access findings in an Amazon S3 bucket*

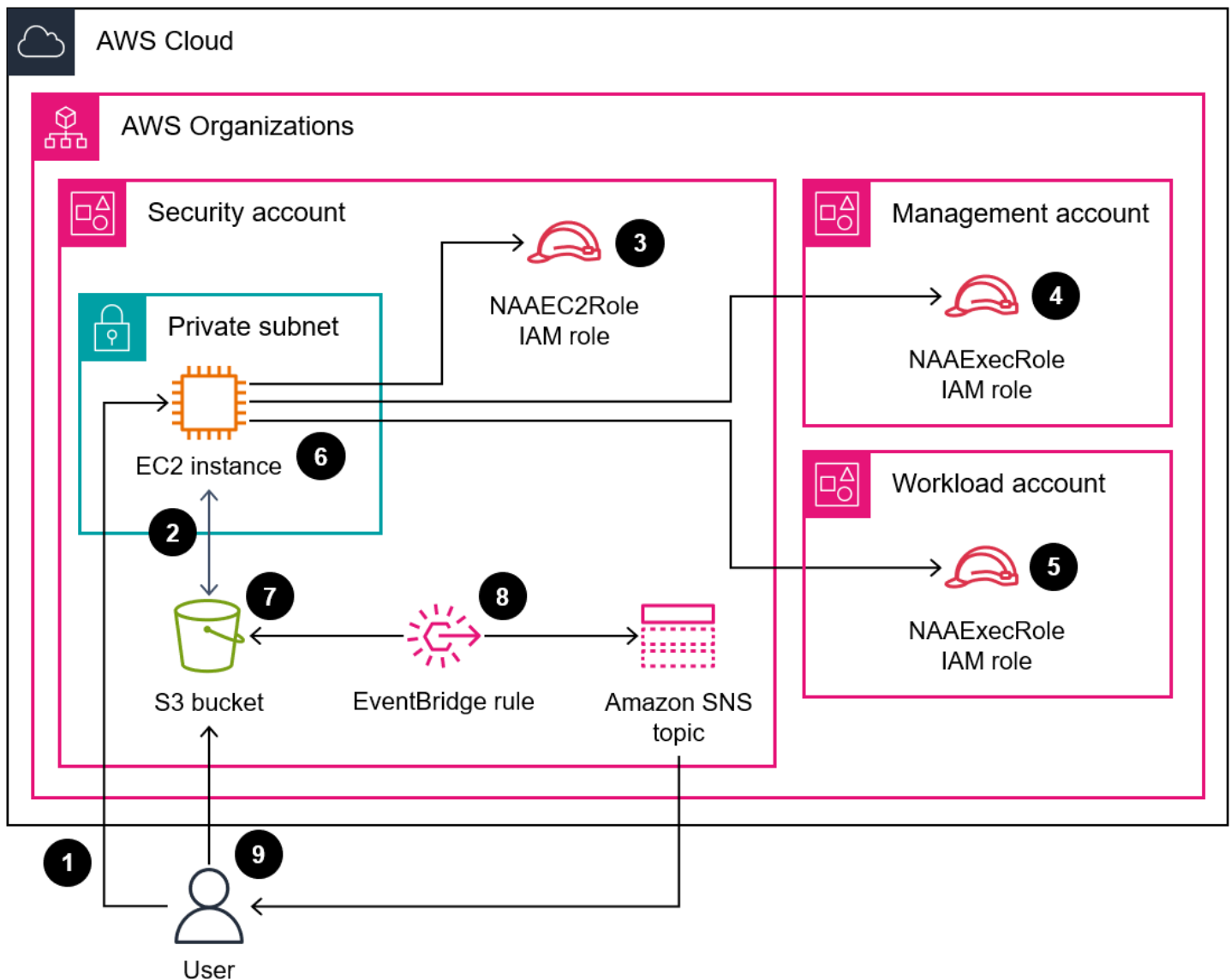

The diagram shows the following process:

1. If you're manually running the solution, the user authenticates to the EC2 instance by using Session Manager and then runs the `naa-script.sh` script. This shell script performs steps 2–7. If you're automatically running the solution, the `naa-script.sh` script starts automatically on the schedule you defined in the cron expression. This shell script performs steps 2–7. For more information, see *Automation and scale* at the end of this section.
2. The EC2 instance downloads the latest `naa-exception.csv` file from the S3 bucket. This file is used later in the process when the Python script processes the exclusions.
3. The EC2 instance assumes the `NAAEC2Role` IAM role, which grants permissions to access the S3 bucket and to assume the `NAAExecRole` IAM roles in the other accounts in the organization.

4. The EC2 instance assumes the `NAAExecRole` IAM role in the organization's management account and generates a list of the accounts in the organization.
5. The EC2 instance assumes the `NAAExecRole` IAM role in the organization's member accounts (called *workload accounts* in the architecture diagram) and performs a security assessment in each account. The findings are stored as JSON files on the EC2 instance.
6. The EC2 instance uses a Python script to process the JSON files, extract the data fields, and create a CSV report.
7. The EC2 instance uploads the CSV file to the S3 bucket.
8. An Amazon EventBridge rule detects the file upload and uses an Amazon SNS topic to send an email that notifies the user that the report is complete.
9. The user downloads the CSV file from the S3 bucket. The user imports the results into the Excel template and reviews the results.

*Option 2: Access findings in AWS Security Hub*

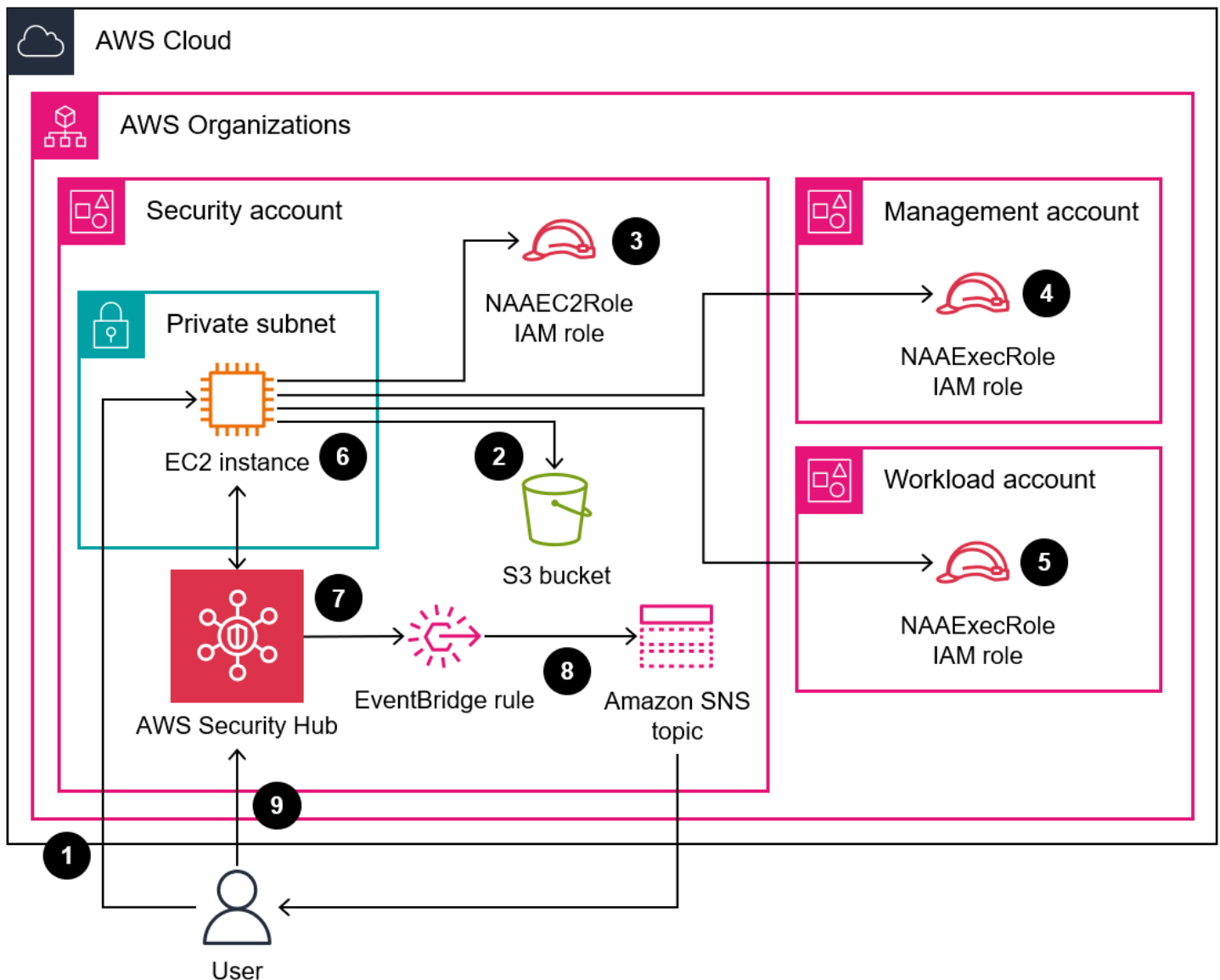

The diagram shows the following process:

1. If you're manually running the solution, the user authenticates to the EC2 instance by using Session Manager and then runs the **naa-script.sh** script. This shell script performs steps 2–7.  
If you're automatically running the solution, the **naa-script.sh** script starts automatically on the schedule you defined in the cron expression. This shell script performs steps 2–7. For more information, see *Automation and scale* at the end of this section.
2. The EC2 instance downloads the latest **naa-exception.csv** file from the S3 bucket. This file is used later in the process when the Python script processes the exclusions.
3. The EC2 instance assumes the `NAAEC2Role` IAM role, which grants permissions to access the S3 bucket and to assume the `NAAExecRole` IAM roles in the other accounts in the organization.

4. The EC2 instance assumes the `NAAExecRole` IAM role in the organization's management account and generates a list of the accounts in the organization.
5. The EC2 instance assumes the `NAAExecRole` IAM role in the organization's member accounts (called *workload accounts* in the architecture diagram) and performs a security assessment in each account. The findings are stored as JSON files on the EC2 instance.
6. The EC2 instance uses a Python script to process the JSON files and extract the data fields for import into Security Hub.
7. The EC2 instance imports the Network Access Analyzer findings to Security Hub.
8. An Amazon EventBridge rule detects the import and uses an Amazon SNS topic to send an email that notifies the user that the process is complete.
9. The user views the findings in Security Hub.

## Automation and scale

You can schedule this solution to run the `naa-script.sh` script automatically on a custom schedule. To set a custom schedule, in the `naa-resources.yaml` CloudFormation template, modify the `CronScheduleExpression` parameter. For example, the default value of `0 0 * * 0` runs the solution at midnight on every Sunday. A value of `0 0 * 1-12 0` would run the solution at midnight on the first Sunday of every month. For more information about using cron expressions, see [Cron and rate expressions](#) in the Systems Manager documentation.

If you want adjust the schedule after the `NAA-Resources` stack has been deployed, you can manually edit the cron schedule in `/etc/cron.d/naa-schedule`.

## Tools

### AWS services

- [Amazon Elastic Compute Cloud \(Amazon EC2\)](#) provides scalable computing capacity in the AWS Cloud. You can launch as many virtual servers as you need and quickly scale them up or down.
- [Amazon EventBridge](#) is a serverless event bus service that helps you connect your applications with real-time data from a variety of sources. For example, AWS Lambda functions, HTTP invocation endpoints using API destinations, or event buses in other AWS accounts.
- [AWS Identity and Access Management \(IAM\)](#) helps you securely manage access to your AWS resources by controlling who is authenticated and authorized to use them.

- [AWS Organizations](#) is an account management service that helps you consolidate multiple AWS accounts into an organization that you create and centrally manage.
- [AWS Security Hub](#) provides a comprehensive view of your security state in AWS. It also helps you check your AWS environment against security industry standards and best practices.
- [Amazon Simple Notification Service \(Amazon SNS\)](#) helps you coordinate and manage the exchange of messages between publishers and clients, including web servers and email addresses.
- [Amazon Simple Storage Service \(Amazon S3\)](#) is a cloud-based object storage service that helps you store, protect, and retrieve any amount of data.
- [AWS Systems Manager](#) helps you manage your applications and infrastructure running in the AWS Cloud. It simplifies application and resource management, shortens the time to detect and resolve operational problems, and helps you manage your AWS resources securely at scale. This pattern uses Session Manager, a capability of Systems Manager.

## Code repository

The code for this pattern is available in the GitHub [Network Access Analyzer Multi-Account Analysis](#) repository. The code repository contains the following files:

- **naa-script.sh** – This bash script is used to start a Network Access Analyzer analysis of multiple AWS accounts, in parallel. As defined in the **naa-resources.yaml** CloudFormation template, this script is automatically deployed to the `/usr/local/naa` folder on the EC2 instance.
- **naa-resources.yaml** – You use this CloudFormation template to create a stack in the security account in the organization. This template deploys all of the required resources for this account in order to support the solution. This stack must be deployed before the **naa-execrole.yaml** template.

*Note:* If this stack is deleted and redeployed, you must rebuild the `NAAExecRole` stack set in order to rebuild the cross-account dependencies between the IAM roles.

- **naa-execrole.yaml** – You use this CloudFormation template to create a stack set that deploys the `NAAExecRole` IAM role in all accounts in the organization, including the management account.
- **naa-processfindings.py** – The **naa-script.sh** script automatically calls this Python script to process the Network Access Analyzer JSON outputs, exclude any known-good resources in the **naa-exclusions.csv** file, and then either generate a CSV file of the consolidated results or import the results into Security Hub.

# Epics

## Prepare for deployment

Task	Description	Skills required
Clone the code repository.	<ol style="list-style-type: none"><li>1. In a command-line interface, change your working directory to the location where you want to store the sample files.</li><li>2. Enter the following command.  <pre>git clone https://github.com/aws-samples/network-access-analyzer-multi-account-analysis.git</pre></li></ol>	AWS DevOps
Review the templates.	<ol style="list-style-type: none"><li>1. In the cloned repository, open the <b>naa-resources.yaml</b> and <b>naa-execrole.yaml</b> files.</li><li>2. Review the resources created by these templates and adjust the templates as needed for your environment. For more information, see <a href="#">Working with templates</a> in the CloudFormation documentation.</li></ol>	AWS DevOps



Task	Description	Skills required
	3. Save and close the <b>naa-resources.yaml</b> and <b>naa-execrole.yaml</b> files.	

## Create the CloudFormation stacks

Task	Description	Skills required
Provision resources in the security account.	<p>Using the <b>naa-resources.yaml</b> template, you create a CloudFormation stack that deploys all of the required resources in the security account. For instructions, see <a href="#">Creating a stack</a> in the CloudFormation documentation. Note the following when deploying this template:</p> <ol style="list-style-type: none"> <li>1. On the <b>Specify template</b> page, choose <b>Template is ready</b>, and then upload the <b>naa-resources.yaml</b> file.</li> <li>2. On the <b>Specify stack details</b> page, in the <b>Stack name</b> box, enter <code>NAA-Resources</code> .</li> <li>3. In the <b>Parameters</b> section, enter the following: <ul style="list-style-type: none"> <li>• <b>VPCId</b> – Select a VPC in the account.</li> </ul> </li> </ol>	AWS DevOps

Task	Description	Skills required
	<ul style="list-style-type: none"><li>• SubnetId -- Select a private subnet that has internet access.  <i>Note:</i> If you select a public subnet, the EC2 instance might not be assigned a public IP address because the CloudFormation template, by default, doesn't provision and attach an Elastic IP address.</li><li>• InstanceType – Leave the default instance type.</li><li>• InstanceImageId – Leave the default.</li><li>• KeyPairName – If you're using SSH for access, specify the name of an existing key pair.</li><li>• PermittedSSHInbound – If you're using SSH for access, specify a permitted CIDR block. If you're not using SSH, keep the default value of 127.0.0.1 .</li><li>• BucketName – The default value is naa- &lt;accountID&gt;-&lt;r egion&gt; . You can</li></ul>	

Task	Description	Skills required
	<p>modify this as needed. If you specify a custom value, the account ID and Region are automatically appended to the specified value.</p> <ul style="list-style-type: none"><li data-bbox="630 506 1023 730">• <code>EmailAddress</code> – Specify an email address for an Amazon SNS notification when the analysis is complete.</li></ul> <p><i>Note:</i> The Amazon SNS subscription configuration must be confirmed prior to completion of the analysis, or a notification will not be sent.</p> <ul style="list-style-type: none"><li data-bbox="630 1121 1016 1346">• <code>NAAEC2Role</code> – Keep the default unless your naming conventions require a different name for this IAM role.</li><li data-bbox="630 1367 1027 1591">• <code>NAAExecRole</code> – Keep the default unless another name will be used when deploying the <b>naa-execrole.yaml</b></li><li data-bbox="630 1612 1000 1795">• <code>Parallelism</code> – Specify the number of parallel assessments to perform.</li></ul>	

Task	Description	Skills required
	<ul style="list-style-type: none"><li>• <b>Regions</b> – Specify the AWS Regions you want to analyze.</li><li>• <b>ScopeNameValue</b> – Specify the tag that will be assigned to the scope. This tag is used to determine the Network Access Scope.</li><li>• <b>ExclusionFile</b> – Specify the exclusion file name. Entries in this file will be excluded from findings.</li><li>• <b>FindingsToCSV</b> – Specify whether findings should be output to CSV. Accepted values are true and false.</li><li>• <b>FindingsToSecurityHub</b> – Specify whether findings should be imported into Security Hub. Accepted values are true and false.</li><li>• <b>EmailNotificationsForSecurityHub</b> – Specify whether importing findings into Security Hub should generate email notifications. Accepted values are true and false.</li></ul>	

Task	Description	Skills required
	<ul style="list-style-type: none"><li>• <code>ScheduledAnalysis</code> – If you want the solution to run automatically on a schedule, enter <code>true</code>, and then customize the schedule in the <code>CronScheduleExpression</code> parameter. If you do not want to run the solution automatically, enter <code>false</code>.</li><li>• <code>CronScheduleExpression</code> – If you're running the solution automatically, enter a cron expression to define the schedule. For more information, see <i>Automation and scale</i> in the <a href="#">Architecture</a> section of this pattern.</li></ul> <ol style="list-style-type: none"><li>1. On the <b>Review</b> page, select <b>The following resource(s) require capabilities: [AWS::IAM::Role]</b>, and then choose <b>Create Stack</b>.</li><li>2. After the stack has been successfully created, in the CloudFormation console, on the <b>Outputs</b> tab, copy the <code>NAAEC2Role</code> Amazon Resource Name (ARN). You</li></ol>	

Task	Description	Skills required
	use this ARN later when deploying the <b>naa-execrole.yaml</b> file.	

Task	Description	Skills required
Provision the IAM role in the member accounts.	<p>In the AWS Organizations management account or an account with delegated administrator permissions for CloudFormation, use the <b>naa-execrole.yaml</b> template to create a CloudFormation stack set. The stack set deploys the NAAExecRole IAM role in all member accounts in the organization. For instructions, see <a href="#">Create a stack set with service-managed permissions</a> in the CloudFormation documentation. Note the following when deploying this template:</p> <ol style="list-style-type: none"><li>1. Under <b>Prepare template</b>, choose <b>Template is ready</b>, and then upload the <b>naa-execrole.yaml</b> file.</li><li>2. On the <b>Specify StackSet details</b> page, name the stack set NAA-ExecRole .</li><li>3. In the <b>Parameters</b> section, enter the following:<ul style="list-style-type: none"><li>• <b>AuthorizedARN</b> – Enter the NAAEC2Role ARN, which you copied when you created the NAA-Resources stack.</li><li>• <b>NAARoleName</b> – Keep the default value of</li></ul></li></ol>	AWS DevOps

Task	Description	Skills required
	<p>NAAExecRole unless another name was used when deploying the <b>naa-resources.yaml</b> file.</p> <ol style="list-style-type: none"> <li>4. Under <b>Permissions</b>, choose <b>Service-managed permissions</b>.</li> <li>5. On the <b>Set deployment options</b> page, under <b>Deployment targets</b>, choose <b>Deploy to organization</b> and accept all defaults.</li> </ol> <p><i>Note:</i> If you want the stacks deployed to all member accounts simultaneously, set <b>Maximum concurrent accounts</b> and <b>Failure tolerance</b> to a high value, such as 100.</p> <ol style="list-style-type: none"> <li>6. Under <b>Deployment regions</b>, choose the Region where the EC2 instance for Network Access Analyzer is deployed. Because IAM resources are global and not Regional, this deploys the IAM role in all active Regions.</li> <li>7. On the <b>Review</b> page, select <b>I acknowledge that AWS CloudFormation might</b></li> </ol>	



Task	Description	Skills required
	<p><b>create IAM resources with custom names</b>, and then choose <b>Create StackSet</b>.</p> <p>8. Monitor the <b>Stack instances</b> tab (for individual account status) and the <b>Operations</b> tab (for overall status) to determine when the deployment is complete.</p>	

Task	Description	Skills required
Provision the IAM role in the management account.	<p>Using the <b>naa-execrole.yaml</b> template, you create a CloudFormation stack that deploys the <code>NAAExecRole</code> IAM role in the management account of the organization. The stack set you created previously doesn't deploy the IAM role in the management account. For instructions, see <a href="#">Creating a stack</a> in the CloudFormation documentation. Note the following when deploying this template:</p> <ol style="list-style-type: none"><li>1. On the <b>Specify template</b> page, choose <b>Template is ready</b>, and then upload the <b>naa-execrole.yaml</b> file.</li><li>2. On the <b>Specify stack details</b> page, in the <b>Stack name</b> box, enter <code>NAA-ExecRole</code> .</li><li>3. In the <b>Parameters</b> section, enter the following:<ul style="list-style-type: none"><li>• <b>AuthorizedARN</b> – Enter the <code>NAAEC2Role</code> ARN, which you copied when you created the <code>NAA-Resources</code> stack.</li><li>• <b>NAARoleName</b> – Keep the default value of <code>NAAExecRole</code> unless another name was used</li></ul></li></ol>	AWS DevOps

Task	Description	Skills required
	<p>when deploying the <code>naa-resources.yaml</code> file.</p> <p>4. On the <b>Review</b> page, select <b>The following resource(s) require capabilities: [AWS::IAM::Role]</b>, and then choose <b>Create Stack</b>.</p>	

## Perform the analysis

Task	Description	Skills required
Customize the shell script.	<ol style="list-style-type: none"> <li>1. Sign in to the security account in the organization.</li> <li>2. Using Session Manager, connect to the EC2 instance for Network Access Analyzer that you previously provisioned. For instructions, see <a href="#">Connect to your Linux instance using Session Manager</a>. If you're unable to connect, see the <a href="#">Troubleshooting</a> section of this pattern.</li> <li>3. Enter the following commands to open the <code>naa-script.sh</code> file for editing.</li> </ol> <pre>sudo -i cd /usr/local/naa vi naa-script.sh</pre>	AWS DevOps

Task	Description	Skills required
	<p>4. Review and modify the adjustable parameters and variables in this script as needed for your environment. For more information about customization options, see the comments at the beginning of the script.</p> <p>For example, instead of getting a list of all member accounts in the organization from the management account, you can modify the script to specify the AWS account IDs or AWS Regions that you want to scan, or you can reference an external file that contains these parameters.</p> <p>5. Save and close the <b>naa-script.sh</b> file.</p>	

Task	Description	Skills required
Analyze the target accounts.	<ol style="list-style-type: none"><li data-bbox="591 226 1027 1803">1. Enter the following commands. This runs the <b>naa-script.sh</b> script. <pre data-bbox="634 394 1027 594">sudo -i cd /usr/local/naa screen ./naa-script.sh</pre><p data-bbox="630 632 911 667">Note the following:</p><ul data-bbox="630 688 1027 1556" style="list-style-type: none"><li data-bbox="630 688 1027 961">• The screen command permits the script to continue running in the event that the connection times out or you lose console access.</li><li data-bbox="630 982 1027 1346">• After the scan starts, you can force a screen detach by pressing <b>Ctrl+A D</b>. The screen detaches, and you can close the instance connection while the analysis proceeds.</li><li data-bbox="630 1367 1027 1556">• To resume a detached session, connect to the instance, enter <code>sudo -i</code> then enter <code>screen -r</code>.</li></ul></li><li data-bbox="591 1577 1027 1803">2. Monitor the output for any errors to make sure that the script is working properly. For a sample output, see the <a href="#">Additional</a></li></ol>	AWS DevOps

Task	Description	Skills required
	<p><a href="#">information</a> section of this pattern.</p> <p>3. Wait for the analysis to complete. If you configured email notifications, you receive an email when the results have been uploaded to the S3 bucket or imported into Security Hub.</p>	
Option 1 – Retrieve the results from the S3 bucket.	<ol style="list-style-type: none"><li>1. Download the CSV file from the <code>naa- &lt;accountID&gt;-&lt;region&gt;</code> bucket. For instructions, see <a href="#">Downloading an object</a> in the Amazon S3 documentation.</li><li>2. Delete the CSV file from the S3 bucket. This is a best practice for cost optimization. For instructions, see <a href="#">Deleting objects</a> in the Amazon S3 documentation.</li></ol>	AWS DevOps

Task	Description	Skills required
Option 2 – Review the results in Security Hub.	<ol style="list-style-type: none"> <li>1. Open the Security Hub console at <a href="https://console.aws.amazon.com/securityhub/">https://console.aws.amazon.com/securityhub/</a>.</li> <li>2. Choose <b>Findings</b> from the navigation pane.</li> <li>3. Review the Network Access Analyzer findings. For instructions, see <a href="#">Viewing finding lists and details</a> in the Security Hub documentation.</li> </ol> <p><i>Note:</i> You can search findings by adding a <b>Title starts with</b> filter and entering Network Access Analyzer.</p>	AWS DevOps

## Remediate and exclude findings

Task	Description	Skills required
Remediate findings.	Remediate any findings that you want to address. For more information and best practices about how to create a perimeter around your AWS identities, resources, and networks, see <a href="#">Building a data perimeter on AWS</a> (AWS Whitepaper).	AWS DevOps

Task	Description	Skills required
Exclude resources with known-good network paths.	<p>If Network Access Analyzer generates findings for resources that should be accessible from the internet, then you can add these resources to an exclusion list. The next time Network Access Analyzer runs, it won't generate a finding for that resource.</p> <ol style="list-style-type: none"><li data-bbox="591 730 1027 1010">1. Navigate to <code>/usr/local/naa</code>, and then open the <b>naa-script.sh</b> script. Make note of the value of the <code>S3_EXCLUSION_FILE</code> variable.</li><li data-bbox="591 1031 1027 1497">2. If the value of the <code>S3_EXCLUSION_FILE</code> variable is <code>true</code>, download the <b>naa-exclusions.csv</b> file from the <code>naa-&lt;accountID&gt;-&lt;region&gt;</code> bucket. For instructions, see <a href="#">Downloading an object</a> in the Amazon S3 documentation.</li></ol> <p>If the value of the <code>S3_EXCLUSION_FILE</code> variable is <code>false</code>, navigate to <code>/usr/local/naa</code> and then open the <b>naa-exclusions.csv</b> file.</p>	AWS DevOps



Task	Description	Skills required
	<p><i>Note:</i> If the value of the <code>S3_EXCLUSION_FILE</code> variable is <code>false</code>, the script uses a local version of the exclusions file. If you later change the value to <code>true</code>, then the script overwrites the local version with the file in the S3 bucket.</p> <p>3. In the <b>naa-exclusions.csv</b> file, enter the resources that you want to exclude. Enter one resource in each line, and use the following format.</p> <pre>&lt;resource_id&gt;,&lt;sec group_id&gt;,&lt;sgrule_ cidr&gt;,&lt;sgrule_port range&gt;,&lt;sgrule_pro tocol&gt;</pre> <p>The following is an example resource.</p> <pre>eni-1111aaaaa2222b bbb,sg-3333cccc44 44ddd,0.0.0.0/0,8 0 to 80,tcp</pre> <p>4. Save and close the <b>naa-exclusions.csv</b> file.</p> <p>5. If you downloaded the <b>naa-exclusions.csv</b> file</p>	

Task	Description	Skills required
	from the S3 bucket, upload the new version. For instructions, see <a href="#">Uploading objects</a> in the Amazon S3 documentation.	

### (Optional) Update the `naa-script.sh` script

Task	Description	Skills required
Update the <code>naa-script.sh</code> script.	<p>If you want to update the <b>naa-script.sh</b> script to the latest version in the repo, do the following:</p> <ol style="list-style-type: none"><li>1. Connect to the EC2 instance by using Session Manager. For instructions, see <a href="#">Connect to your Linux instance using Session Manager</a>.</li><li>2. Enter the following command. <pre>sudo -i</pre></li><li>3. Navigate to the <b>naa-script.sh</b> script directory. <pre>cd /usr/local/naa</pre></li><li>4. Enter the following command to stash the local script so that you can</li></ol>	AWS DevOps

Task	Description	Skills required
	<p>merge custom changes into the newest version.</p> <pre data-bbox="630 327 1029 411">git stash</pre> <p>5. Enter the following command to get the latest version of the script.</p> <pre data-bbox="630 590 1029 674">git pull</pre> <p>6. Enter the following command to merge the custom script with the latest version of the script.</p> <pre data-bbox="630 898 1029 982">git stash pop</pre>	

### (Optional) Clean up

Task	Description	Skills required
Delete all deployed resources.	<p>You can leave the resources deployed in the accounts.</p> <p>If you want to deprovision all resources, do the following:</p> <ol style="list-style-type: none"> <li>1. Delete the NAA-ExecRole stack provisioned in the management account. For instructions, see <a href="#">Deleting a stack</a> in the CloudFormation documentation.</li> </ol>	AWS DevOps

Task	Description	Skills required
	<ol style="list-style-type: none"> <li>2. Delete the NAA-ExecRole stack set provisioned in the organization's management account or in the delegated administrator account. For instructions, see <a href="#">Delete a stack set</a> in the CloudFormation documentation.</li> <li>3. Delete all objects in the naa-&lt;accountID&gt;-&lt;region&gt; S3 bucket. For instructions, see <a href="#">Deleting objects</a> in the Amazon S3 documentation.</li> <li>4. Delete the NAA-Resources stack provisioned in the security account. For instructions, see <a href="#">Deleting a stack</a> in the CloudFormation documentation.</li> </ol>	

## Troubleshooting

Issue	Solution
<p>Unable to connect to the EC2 instance by using Session Manager.</p>	<p>The SSM Agent must be able to communicate with the Systems Manager endpoint. Do the following:</p> <ol style="list-style-type: none"> <li>1. Validate the subnet where the EC2 instance is deployed has internet access.</li> <li>2. Reboot the EC2 instance.</li> </ol>

Issue	Solution
When deploying the stack set, the CloudFormation console prompts you to Enable trusted access with AWS Organizations to use service-managed permissions .	This indicates that trusted access has not been enabled between AWS Organizations and CloudFormation. Trusted access is required to deploy the service-managed stack set. Choose the button to enable trusted access. For more information, see <a href="#">Enable trusted access</a> in the CloudFormation documentation.

## Related resources

- [New – Amazon VPC Network Access Analyzer](#) (AWS blog post)
- [AWS re:Inforce 2022 - Validate effective network access controls on AWS \(NIS202\)](#) (video)
- [Demo - Organization-wide Internet Ingress Data Path Analysis Using Network Access Analyzer](#) (video)

## Additional information

### Example console output

The following sample shows the output of generating the list of target accounts and analyzing the target accounts.

```
[root@ip-10-10-43-82 naa]# ./naa-script.sh
download: s3://naa-<account ID>-us-east-1/naa-exclusions.csv to ./naa-exclusions.csv

AWS Management Account: <Management account ID>

AWS Accounts being processed...
<Account ID 1> <Account ID 2> <Account ID 3>

Assessing AWS Account: <Account ID 1>, using Role: NAAExecRole
Assessing AWS Account: <Account ID 2>, using Role: NAAExecRole
Assessing AWS Account: <Account ID 3>, using Role: NAAExecRole
Processing account: <Account ID 1> / Region: us-east-1
Account: <Account ID 1> / Region: us-east-1 - Detecting Network Analyzer scope...
Processing account: <Account ID 2> / Region: us-east-1
```

```
Account: <Account ID 2> / Region: us-east-1 - Detecting Network Analyzer scope...
Processing account: <Account ID 3> / Region: us-east-1
Account: <Account ID 3> / Region: us-east-1 - Detecting Network Analyzer scope...
Account: <Account ID 1> / Region: us-east-1 - Network Access Analyzer scope detected.
Account: <Account ID 1> / Region: us-east-1 - Continuing analyses with Scope ID.
Accounts with many resources may take up to one hour
Account: <Account ID 2> / Region: us-east-1 - Network Access Analyzer scope detected.
Account: <Account ID 2> / Region: us-east-1 - Continuing analyses with Scope ID.
Accounts with many resources may take up to one hour
Account: <Account ID 3> / Region: us-east-1 - Network Access Analyzer scope detected.
Account: <Account ID 3> / Region: us-east-1 - Continuing analyses with Scope ID.
Accounts with many resources may take up to one hour
```

### CSV report examples

The following images are examples of the CSV output.

	A	B	C	D	E	F	G	H
1	account	region	vpc_id	subnet_id	instance_id	instance_arn	instance_name	resource_id
2	111111111111	us-east-1	vpc-111111111111111111	subnet-111111111111111111	i-111111111111111111	arn:aws:ec2:us-east-1:111111111111:instance/i-111111111111111111	dev_server	eni-111111111111111111
3	111111111111	us-east-1	vpc-111111111111111111	subnet-111111111111111111	i-111111111111111111	arn:aws:ec2:us-east-1:111111111111:instance/i-111111111111111111	dev_server	eni-111111111111111111
4	111111111111	us-east-1	vpc-111111111111111111	subnet-111111111111111111	i-111111111111111111	arn:aws:ec2:us-east-1:111111111111:instance/i-111111111111111111	dev_server	eni-111111111111111111
5	111111111111	us-east-1	vpc-111111111111111111	subnet-111111111111111111	i-111111111111111111	arn:aws:ec2:us-east-1:111111111111:instance/i-111111111111111111	Bastion-PublicSubnet	eni-111111111111111111
6	111111111111	us-east-1	vpc-111111111111111111	subnet-111111111111111111	i-111111111111111111	arn:aws:ec2:us-east-1:111111111111:instance/i-111111111111111111	Bastion-PublicSubnet	eni-111111111111111111
7	111111111111	us-east-1	vpc-111111111111111111	subnet-111111111111111111	i-111111111111111111	arn:aws:ec2:us-east-1:111111111111:instance/i-111111111111111111	lnx-sorter	eni-111111111111111111
8	111111111111	us-east-1	vpc-111111111111111111	subnet-111111111111111111	i-111111111111111111	arn:aws:ec2:us-east-1:111111111111:instance/i-111111111111111111	lnx-sorter	eni-111111111111111111
9	111111111111	us-east-1	vpc-111111111111111111	subnet-111111111111111111	i-111111111111111111	arn:aws:ec2:us-east-1:111111111111:instance/i-111111111111111111	lnx-sorter	eni-111111111111111111
10	111111111111	us-east-1	vpc-111111111111111111	subnet-111111111111111111	i-111111111111111111	arn:aws:ec2:us-east-1:111111111111:instance/i-111111111111111111	Container_LZ-Public	eni-111111111111111111
11	111111111111	us-east-1	vpc-111111111111111111	subnet-111111111111111111	i-111111111111111111	arn:aws:ec2:us-east-1:111111111111:instance/i-111111111111111111	Container_LZ-Public	eni-111111111111111111
12	111111111111	us-east-1	vpc-111111111111111111	subnet-111111111111111111	i-111111111111111111	arn:aws:ec2:us-east-1:111111111111:instance/i-111111111111111111	Container_LZ-Public	eni-111111111111111111
13	222222222222	us-east-1	vpc-222222222222222222	subnet-222222222222222222	N/A	N/A	N/A	eni-222222222222222222
14	222222222222	us-east-1	vpc-222222222222222222	subnet-222222222222222222	N/A	N/A	N/A	eni-222222222222222222
15	222222222222	us-east-1	vpc-222222222222222222	subnet-222222222222222222	N/A	N/A	N/A	eni-222222222222222222
16	222222222222	us-east-1	vpc-222222222222222222	subnet-222222222222222222	N/A	N/A	N/A	eni-222222222222222222
17	222222222222	us-east-1	vpc-222222222222222222	subnet-222222222222222222	i-222222222222222222	arn:aws:ec2:us-east-1:222222222222:instance/i-222222222222222222	Test-FileGateway	eni-222222222222222222
18	222222222222	us-east-1	vpc-222222222222222222	subnet-222222222222222222	i-222222222222222222	arn:aws:ec2:us-east-1:222222222222:instance/i-222222222222222222	Dev-LinuxGateway	eni-222222222222222222
19	222222222222	us-east-1	vpc-222222222222222222	subnet-222222222222222222	N/A	N/A	N/A	eni-222222222222222222
20	222222222222	us-east-1	vpc-222222222222222222	subnet-222222222222222222	i-222222222222222222	arn:aws:ec2:us-east-1:222222222222:instance/i-222222222222222222	testgw	eni-222222222222222222
21	222222222222	us-east-1	vpc-222222222222222222	subnet-222222222222222222	N/A	N/A	N/A	eni-222222222222222222
22	222222222222	us-east-1	vpc-222222222222222222	subnet-222222222222222222	i-222222222222222222	arn:aws:ec2:us-east-1:222222222222:instance/i-222222222222222222	FastProcessor	eni-222222222222222222
23	222222222222	us-east-1	vpc-222222222222222222	subnet-222222222222222222	i-222222222222222222	arn:aws:ec2:us-east-1:222222222222:instance/i-222222222222222222	FastProcessor	eni-222222222222222222
24	333333333333	us-east-1	vpc-333333333333333333	subnet-333333333333333333	i-333333333333333333	arn:aws:ec2:us-east-1:333333333333:instance/i-333333333333333333	FastProcessor	eni-333333333333333333
25	333333333333	us-east-1	vpc-333333333333333333	subnet-333333333333333333	i-333333333333333333	arn:aws:ec2:us-east-1:333333333333:instance/i-333333333333333333	FastProcessor	eni-333333333333333333
26	333333333333	us-east-1	vpc-333333333333333333	subnet-333333333333333333	i-333333333333333333	arn:aws:ec2:us-east-1:333333333333:instance/i-333333333333333333	Liam_Solution	eni-333333333333333333
27	333333333333	us-east-1	vpc-333333333333333333	subnet-333333333333333333	i-333333333333333333	arn:aws:ec2:us-east-1:333333333333:instance/i-333333333333333333	Liam_Solution	eni-333333333333333333
28	333333333333	us-east-1	vpc-333333333333333333	subnet-333333333333333333	i-333333333333333333	arn:aws:ec2:us-east-1:333333333333:instance/i-333333333333333333	Test-FileGateway	eni-333333333333333333
29	333333333333	us-east-1	vpc-333333333333333333	subnet-333333333333333333	i-333333333333333333	arn:aws:ec2:us-east-1:333333333333:instance/i-333333333333333333	Dev-LinuxGateway	eni-333333333333333333
30	333333333333	us-east-1	vpc-333333333333333333	subnet-333333333333333333	i-333333333333333333	arn:aws:ec2:us-east-1:333333333333:instance/i-333333333333333333	Dev-LinuxGateway	eni-333333333333333333
31	333333333333	us-east-1	vpc-333333333333333333	subnet-333333333333333333	i-333333333333333333	arn:aws:ec2:us-east-1:333333333333:instance/i-333333333333333333	FastProcessor	eni-333333333333333333
32	333333333333	us-east-1	vpc-333333333333333333	subnet-333333333333333333	i-333333333333333333	arn:aws:ec2:us-east-1:333333333333:instance/i-333333333333333333	FastProcessor	eni-333333333333333333



# Tag Transit Gateway attachments automatically using AWS Organizations

Created by Richard Milner-Watts (AWS), Haris Bin Ayub (AWS), and John Capps (AWS)

**Code repository:** [Transit Gateway Attachment Tagger](#)

**Environment:** Production

**Technologies:** Networking; Infrastructure; Management & governance; Operations

**AWS services:** AWS Step Functions; AWS Transit Gateway; Amazon VPC; AWS Lambda

## Summary

On Amazon Web Services (AWS), you can use [AWS Resource Access Manager](#) to share [AWS Transit Gateway](#) across AWS account boundaries. When you create Transit Gateway attachments across account boundaries, however, the attachments are created without a Name tag. That can make identifying attachments time consuming.

This solution provides an automated mechanism to gather information about each Transit Gateway attachment for accounts within an organization that is managed by [AWS Organizations](#). The process includes looking up the [Classless Inter-Domain Routing](#) (CIDR) range from the Transit Gateway route table. The solution then applies a Name tag in the form of <CIDR-range>-<AccountName> to the attachment within the account that holds the transit gateway.

This solution can be used alongside a solution such as the [Serverless Transit Network Orchestrator](#) from the AWS Solutions Library. Serverless Transit Network Orchestrator enables the automated creation of Transit Gateway attachments at scale.

## Prerequisites and limitations

### Prerequisites

- An active AWS account



- An AWS Organizations organization that contains all related accounts
- Access to the organization management account, under the organization's root, to create the required AWS Identity and Access Management (IAM) role
- A Shared Networking member account containing one or more transit gateways that are shared with the organization and have attachments

## Architecture

The following screenshot of the AWS Management Console shows examples of Transit Gateway attachments with no associated Name tag and two Transit Gateway attachments with Name tags generated by this solution. The structure of the generated Name tag is <CIDR-range>-<AccountName>.

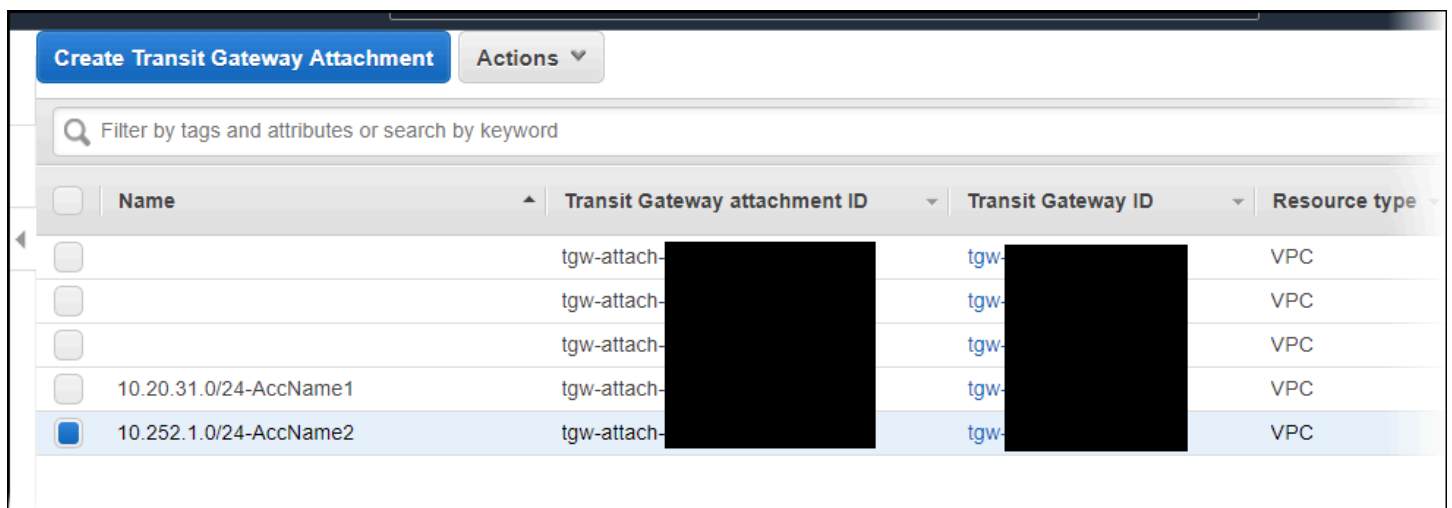

This solution uses [AWS CloudFormation](#) to deploy an [AWS Step Functions](#) workflow that manages the creation of Transit Gateway Name tags across all configured Regions. The workflow invokes [AWS Lambda](#) functions, which perform the underlying tasks.

After the solution has obtained the account names from AWS Organizations, the Step Functions state machine gets all Transit Gateway attachment IDs. These are processed in parallel by AWS Region. This processing includes looking up the CIDR range for each attachment. The CIDR range is obtained by searching the Transit Gateway route tables within the Region for a matching Transit Gateway attachment ID. If all the required information is available, the solution applies a Name tag to the attachment. The solution will not overwrite any existing Name tags.

The solution runs on a schedule controlled by an [Amazon EventBridge](#) event. The event initiates the solution each day at 6:00 AM UTC.

## Target technology stack

- Amazon EventBridge
- AWS Lambda
- AWS Organizations
- AWS Transit Gateway
- Amazon Virtual Private Cloud (Amazon VPC)
- AWS X-Ray

## Target architecture

The solution architecture and workflow are shown in the following diagram.

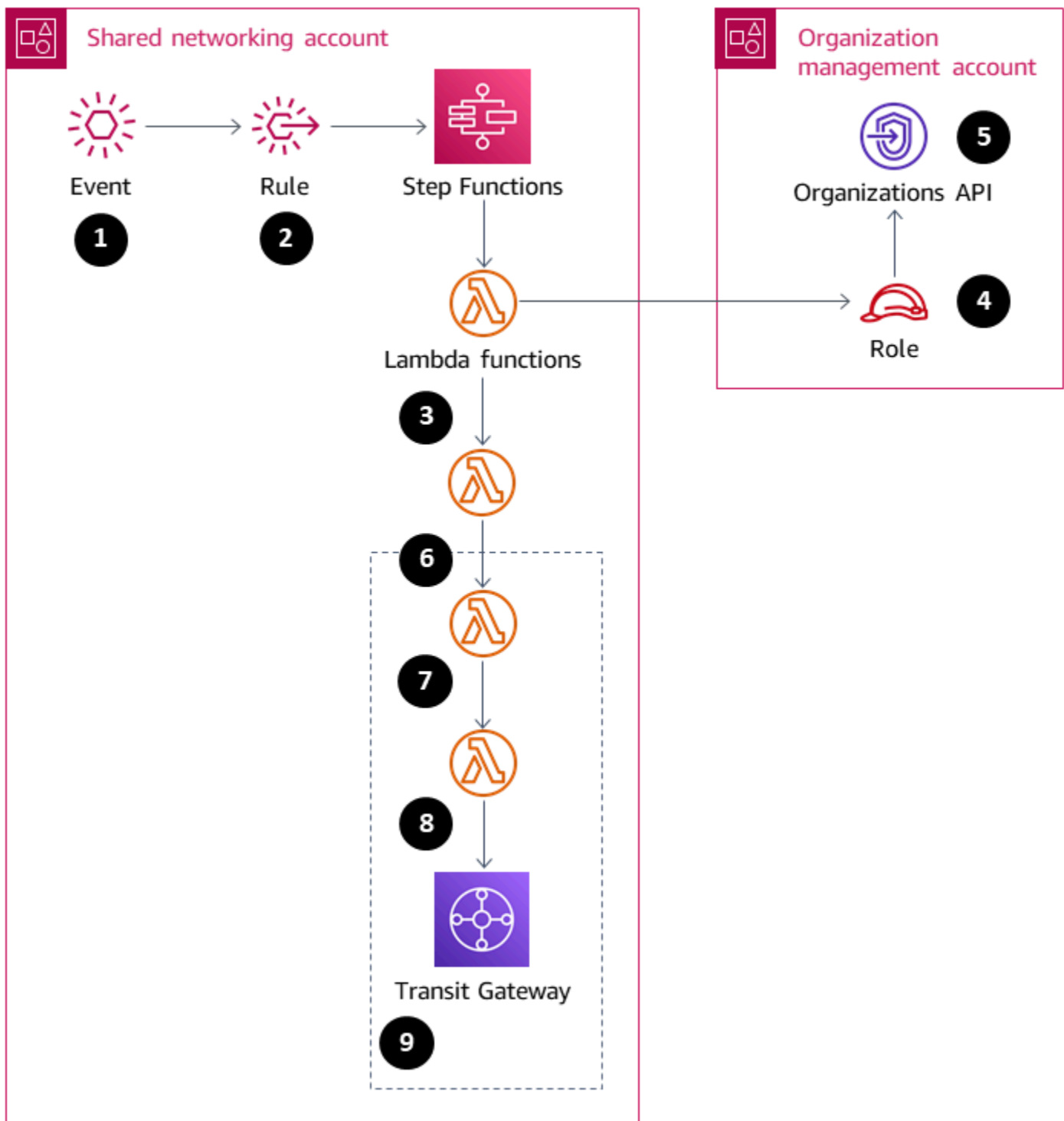

1. The scheduled event initiates the rule.
2. The EventBridge rule starts the Step Functions state machine.
3. The state machine invokes the `tgw-tagger-organizations-account-query` Lambda function.

4. The `tgw-tagger-organizations-account-query` Lambda function assumes the role in the organization management account.
5. The `tgw-tagger-organizations-account-query` Lambda function calls the Organizations API to return AWS account metadata.
6. The state machine invokes the `tgw-tagger-attachment-query` Lambda function.
7. For each Region, in parallel, the state machine invokes `tgw-tagger-rtb-query` Lambda function to read the CIDR range for each attachment.
8. For each Region, in parallel, the state machine invokes `tgw-tagger-attachment-tagger` Lambda function.
9. Name tags are created for Transit Gateway attachments in the Shared Networking account.

## Automation and scale

The solution processes each Region in parallel to reduce the total duration of the run.

## Tools

### AWS services

- [AWS CloudFormation](#) – AWS CloudFormation provides a way to model a collection of related AWS and third-party resources, provision them quickly and consistently, and manage them throughout their lifecycles, by treating infrastructure as code.
- [Amazon EventBridge](#) – Amazon EventBridge is a serverless event bus service that you can use to connect your applications with data from a variety of sources. EventBridge receives an event, an indicator of a change in environment, and applies a rule to route the event to a target. Rules match events to targets based on either the structure of the event, called an event pattern, or on a schedule.
- [AWS Lambda](#) – AWS Lambda is a compute service that supports running code without provisioning or managing servers. Lambda runs your code only when needed and scales automatically, from a few requests each day to thousands each second. You pay only for the compute time that you consume. There is no charge when your code is not running.
- [AWS Organizations](#) – AWS Organizations helps you centrally manage and govern your environment as you grow and scale your AWS resources. Using AWS Organizations, you can programmatically create new AWS accounts and allocate resources, group accounts to organize your workflows, apply policies to accounts or groups for governance, and simplify billing by using a single payment method for all of your accounts.

- [AWS Step Functions](#) – AWS Step Functions is a low-code visual workflow service used to orchestrate AWS services, automate business processes, and build serverless applications. Workflows manage failures, retries, parallelization, service integrations, and observability so developers can focus on higher-value business logic.
- [AWS Transit Gateway](#) – AWS Transit Gateway connects VPCs and on-premises networks through a central hub. This simplifies your network and puts an end to complex peering relationships. It acts as a cloud router, so that each new connection is made only one time.
- [Amazon VPC](#) – Amazon Virtual Private Cloud (Amazon VPC) is a service for launching AWS resources in a logically isolated virtual network that you define.
- [AWS X-Ray](#) – AWS X-Ray collects data about requests that your application serves, and provides tools that you can use to view, filter, and gain insights into that data to identify issues and opportunities for optimization.

## Code

The source code for this solution is available in the [Transit Gateway Attachment Tagger](#) GitHub repository. The repository includes the following files:

- `tgw-attachment-tagger-main-stack.yaml` creates all the resources to support this solution within the Shared Networking account.
- `tgw-attachment-tagger-organizations-stack.yaml` creates a role in the management account of the organization.

## Epics

### Deploy the main solution stack

Task	Description	Skills required
Gather required prerequisite information.	To configure cross-account access from the Lambda function to the AWS Organizations API, you need the account ID for the organization's management account.	DevOps engineer

Task	Description	Skills required
	<p><b>Note:</b> The order in which the two CloudFormation stacks are created matters. You must deploy resources into the Shared Networking account first. The role in the Shared Networking account must already exist before deploying resources into the organization's management account. For more information, see the <a href="#">AWS documentation</a>.</p>	

Task	Description	Skills required
Launch the CloudFormation template for the main solution stack.	<p>The template for the main solution stack will deploy the IAM roles, Step Functions workflow, Lambda functions, and the CloudWatch event.</p> <p>Open the AWS Management console for the Shared Networking account, and then open the CloudFormation console. Create the stack by using the <code>tgw-attachment-tagger-main-stack.yaml</code> template and the following values:</p> <ul style="list-style-type: none"><li>• <b>Stack name</b> – <code>tgw-attachment-tagger-main-stack</code></li><li>• <b>awsOrganizationsRootAccountId</b> – Account ID for the organization's management account</li><li>• <b>TGWRegions</b> parameter – AWS Regions for the solution, entered as a comma-delimited string</li><li>• <b>TGWList</b> parameter – Transit gateway IDs to be excluded from the solution, entered in a comma-delimited string</li></ul> <p>For more information about launching a CloudForm</p>	DevOps engineer

Task	Description	Skills required
	ation stack, see the <a href="#">AWS documentation</a> .	
Verify that the solution has launched successfully.	<p>Wait for the CloudFormation stack to reach a status of <b>CREATE_COMPLETE</b>. This should take less than one minute.</p> <p>Open the Step Functions console, and verify that a new state machine has been created with the name <b>tgw-attachment-tagger-state-machine</b>.</p>	DevOps engineer

## Deploy the AWS Organizations stack

Task	Description	Skills required
Gather required prerequisite information.	To configure cross-account access from the Lambda function to the AWS Organizations API, you need the account ID for the Shared Networking account.	DevOps engineer
Launch the CloudFormation template for the Organizations stack	<p>The template for the AWS Organizations stack will deploy the IAM role in the organization's management account.</p> <p>Access the AWS console for the organization's management account. and</p>	DevOps engineer



Task	Description	Skills required
	<p>then open the CloudFormation console. Create the stack by using the <code>tgw-attachment-tagger-organizations-stack.yaml</code> template and the following values:</p> <ul style="list-style-type: none"> <li>• <b>Stack name</b> – <code>tgw-attachment-tagger-organizations-stack</code></li> <li>• <b>NetworkingAccountId</b> parameter – Account ID for the Shared Networking account</li> </ul> <p>For the other stack creation options, use the defaults.</p>	
<p>Verify that the solution has launched successfully.</p>	<p>Wait for the CloudFormation stack to reach a status of <b>CREATE_COMPLETE</b>. This should take less than one minute.</p> <p>Open the Identity and Access Management (IAM) console, and verify that a new role has been created with the name <b>tgw-attachment-tagger-organization-query-role</b>.</p>	<p>DevOps engineer</p>

## Verify the solution

Task	Description	Skills required
Run the state machine.	<p>Open the Step Functions console for the Shared Networking account, and choose <b>State machines</b> in the navigation pane.</p> <p>Select the state machine <b>tgw-attachment-tagger-state-machine</b>, and choose <b>Start Execution</b>.</p> <p>Because the input to this state machine is not used by the solution, you can use the default value.</p> <pre data-bbox="594 1041 1027 1241">{   "Comment": "Insert your JSON here" }</pre> <p>Choose <b>Start Execution</b>.</p>	DevOps engineer
Watch the state machine until completion.	<p>On the new page that opens, you can watch the state machine run. The duration will depend on the number of Transit Gateway attachments to process.</p> <p>On this page, you can examine each step of the state machine. You can view the various tasks within the</p>	DevOps engineer

Task	Description	Skills required
	<p>state machine and follow links to the CloudWatch logs for the Lambda functions. For the tasks that run in parallel within the map, you can use the <b>Index</b> dropdown list to view the specific implementations for each Region.</p>	
<p>Verify the Transit Gateway attachment tags.</p>	<p>Open the VPC console for the Shared Networking account, and choose <b>Transit Gateway Attachments</b>. On the console, a Name tag is provided for attachments that met the criteria (the attachment is propagated to a Transit Gateway route table, and the resource owner is a member of the organization).</p>	<p>DevOps engineer</p>
<p>Verify the CloudWatch event initiation.</p>	<p>Wait for the CloudWatch event to initiate. This is scheduled for 06:00 UTC.</p> <p>Then open the Step Functions console for the Shared Networking account, and choose <b>State machines</b> in the navigation pane.</p> <p>Select the state machine <b>tgw-attachment-tagger-state-machine</b>. Verify that the solution ran at 06:00 UTC.</p>	<p>DevOps engineer</p>

## Related resources

- [AWS Organizations](#)
- [AWS Resource Access Manager](#)
- [Serverless Transit Network Orchestrator](#)
- [Creating IAM roles](#)
- [Creating a stack on the AWS CloudFormation console](#)

# Verify that ELB load balancers require TLS termination

Created by Priyanka Chaudhary (AWS)

**Environment:** Production

**Technologies:** Networking;  
Security, identity, compliance

**AWS services:** Amazon  
CloudWatch Events; Elastic  
Load Balancing (ELB); AWS  
Lambda

## Summary

On the Amazon Web Services (AWS) Cloud, Elastic Load Balancing (ELB) automatically distributes incoming application traffic across multiple targets, such as Amazon Elastic Compute Cloud (Amazon EC2) instances, containers, IP addresses, and AWS Lambda functions. The load balancers use listeners to define the ports and protocols that the load balancer uses to accept traffic from users. Application Load Balancers make routing decisions at the application layer and use the HTTP/HTTPS protocols. Classic Load Balancers make routing decisions at either the transport layer, by using TCP or Secure Sockets Layer (SSL) protocols, or at the application layer, by using HTTP/HTTPS.

This pattern provides a security control that examines multiple event types for Application Load Balancers and Classic Load Balancers. When the function is invoked, AWS Lambda inspects the event and ensures that the load balancer is compliant.

The function initiates an Amazon CloudWatch Events event on the following API calls: [CreateLoadBalancer](#), [CreateLoadBalancerListeners](#), [DeleteLoadBalancerListeners](#), [CreateLoadBalancerPolicy](#), [SetLoadBalancerPoliciesOfListener](#), [CreateListener](#), [DeleteListener](#), and [ModifyListener](#). When the event detects one of these APIs, it calls AWS Lambda, which runs a Python script. The Python script evaluates to see if the listener contains an SSL certificate, and if the policy that is applied is using Transport Layer Security (TLS). If the SSL policy is determined to be anything other than TLS, the function sends an Amazon Simple Notification Service (Amazon SNS) notification to the user with the relevant information.

## Prerequisites and limitations

### Prerequisites

- An active AWS account

## Limitations

- This security control does not check for existing load balancers, unless an update is made to the load balancer listeners.
- This security control is regional. You must deploy it in each AWS Region you want to monitor.

## Architecture

### Target architecture

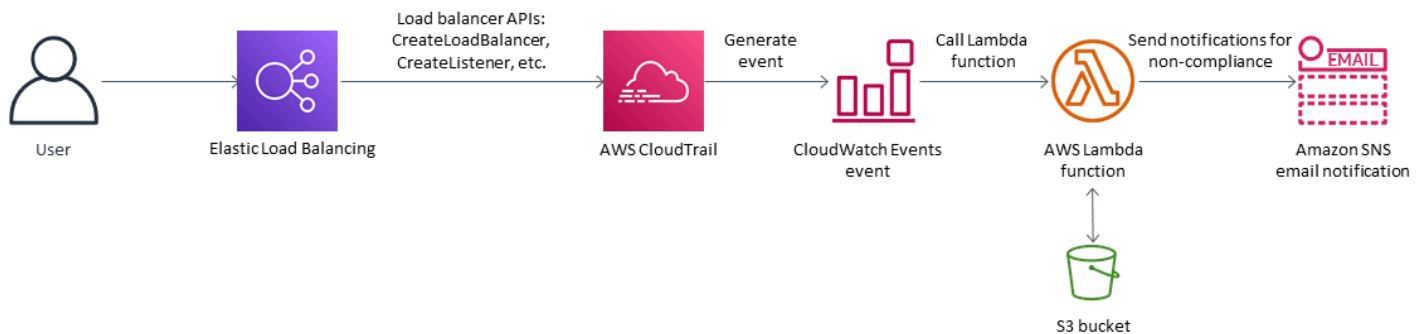

### Automation and scale

- If you are using [AWS Organizations](#), you can use [AWS Cloudformation StackSets](#) to deploy this template in multiple accounts that you want to monitor.

## Tools

### AWS services

- [AWS CloudFormation](#) – AWS CloudFormation helps you model and set up your AWS resources, provision them quickly and consistently, and manage them throughout their lifecycle. You can use a template to describe your resources and their dependencies, and launch and configure them together as a stack, instead of managing resources individually.
- [Amazon CloudWatch Events](#) – Amazon CloudWatch Events delivers a near real-time stream of system events that describe changes in AWS resources.

- [AWS Lambda](#) – AWS Lambda is a compute service that supports running code without provisioning or managing servers.
- [Amazon S3](#) – Amazon Simple Storage Service (Amazon S3) is a highly scalable object storage service that can be used for a wide range of storage solutions, including websites, mobile applications, backups, and data lakes.
- [Amazon SNS](#) – Amazon Simple Notification Service (Amazon SNS) coordinates and manages the delivery or sending of messages between publishers and clients, including web servers and email addresses. Subscribers receive all messages published to the topics to which they subscribe, and all subscribers to a topic receive the same messages.

## Code

This pattern includes the following attachments:

- `ELBRequirestlstermination.zip` – The Lambda code for the security control.
- `ELBRequirestlstermination.yml` – The CloudFormation template that sets up the event and Lambda function.

## Epics

### Set up the S3 bucket

Task	Description	Skills required
Define the S3 bucket.	On the <a href="#">Amazon S3 console</a> , choose or create an S3 bucket to host the Lambda code .zip file. This S3 bucket must be in the same AWS Region as the load balancer that you want to evaluate. An S3 bucket name is globally unique, and the namespace is shared by all AWS accounts. The S3 bucket name cannot include leading slashes.	Cloud architect

Task	Description	Skills required
Upload the Lambda code.	Upload the Lambda code (ELBRequirestlstermination.zip file) that's provided in the <i>Attachments</i> section to the S3 bucket.	Cloud architect

## Deploy the CloudFormation template

Task	Description	Skills required
Launch the AWS CloudFormation template.	Open the <a href="#">AWS CloudFormation console</a> in the same AWS Region as your S3 bucket and deploy the attached template <code>ELBRequirestlstermination.yml</code> . For more information about deploying AWS CloudFormation templates, see <a href="#">Creating a stack on the AWS CloudFormation console</a> in the CloudFormation documentation.	Cloud architect
Complete the parameters in the template.	When you launch the template, you'll be prompted for the following information: <ul style="list-style-type: none"> <li>• <b>S3 bucket:</b> Specify the bucket that you created or selected in the first epic. This is where you uploaded the attached Lambda code</li> </ul>	Cloud architect



Task	Description	Skills required
	<p>(ELBRequirestlstermination.zip file).</p> <ul style="list-style-type: none"> <li>• <b>S3 key:</b> Specify the location of the Lambda .zip file in your S3 bucket (for example, ELBRequirestlstermination.zip or controls/ELBRequirestlstermination.zip ). Do not include leading slashes.</li> <li>• <b>Notification email:</b> Provide an active email address where you want to receive Amazon SNS notifications.</li> <li>• <b>Lambda logging level:</b> Specify the logging level and frequency for the Lambda function. Use <b>Info</b> to log detailed informational messages on progress, <b>Error</b> for error events that would still allow the deployment to continue, and <b>Warning</b> for potentially harmful situations.</li> </ul>	

## Confirm the subscription

Task	Description	Skills required
Confirm the subscription.	When the CloudFormation template deploys successfully, it sends a subscription	Cloud architect

Task	Description	Skills required
	email to the email address you provided. You must confirm this email subscription to start receiving violation notifications.	

## Related resources

- [Creating a stack on the AWS CloudFormation console](#) (AWS CloudFormation documentation)
- [What is AWS Lambda?](#) (AWS Lambda documentation)
- [What is a Classic Load Balancer?](#) (ELB documentation)
- [What is an Application Load Balancer?](#) (ELB documentation)

## Attachments

To access additional content that is associated with this document, unzip the following file: [attachment.zip](#)

# View AWS Network Firewall logs and metrics by using Splunk

Created by Ivo Pinto

**Environment:** PoC or pilot

**Technologies:** Networking; CloudNative; Content delivery; Operations; Security, identity, compliance

**Workload:** All other workloads

**AWS services:** Amazon CloudWatch; Amazon CloudWatch Logs; AWS Network Firewall

## Summary

Many organizations use [Splunk Enterprise](#) as a centralized aggregation and visualization tool for logs and metrics from different sources. This pattern helps you configure Splunk to fetch [AWS Network Firewall](#) logs and metrics from [Amazon CloudWatch Logs](#) by using the Splunk Add-On for AWS.

To achieve this, you create a read-only AWS Identity and Access Management (IAM) role. Splunk Add-On for AWS uses this role to access CloudWatch. You configure the Splunk Add-On for AWS to fetch metrics and logs from CloudWatch. Finally, you create visualizations in Splunk from the retrieved log data and metrics.

## Prerequisites and limitations

### Prerequisites

- A [Splunk](#) account
- A Splunk Enterprise instance, version 8.2.2 or later
- An active AWS account
- Network Firewall, [set up](#) and [configured](#) to send logs to CloudWatch Logs

### Limitations

- Splunk Enterprise must be deployed as a cluster of Amazon Elastic Compute Cloud (Amazon EC2) instances in the AWS Cloud.
- Collecting data by using an automatically discovered IAM role for Amazon EC2 is not supported in the AWS China Regions.

## Architecture

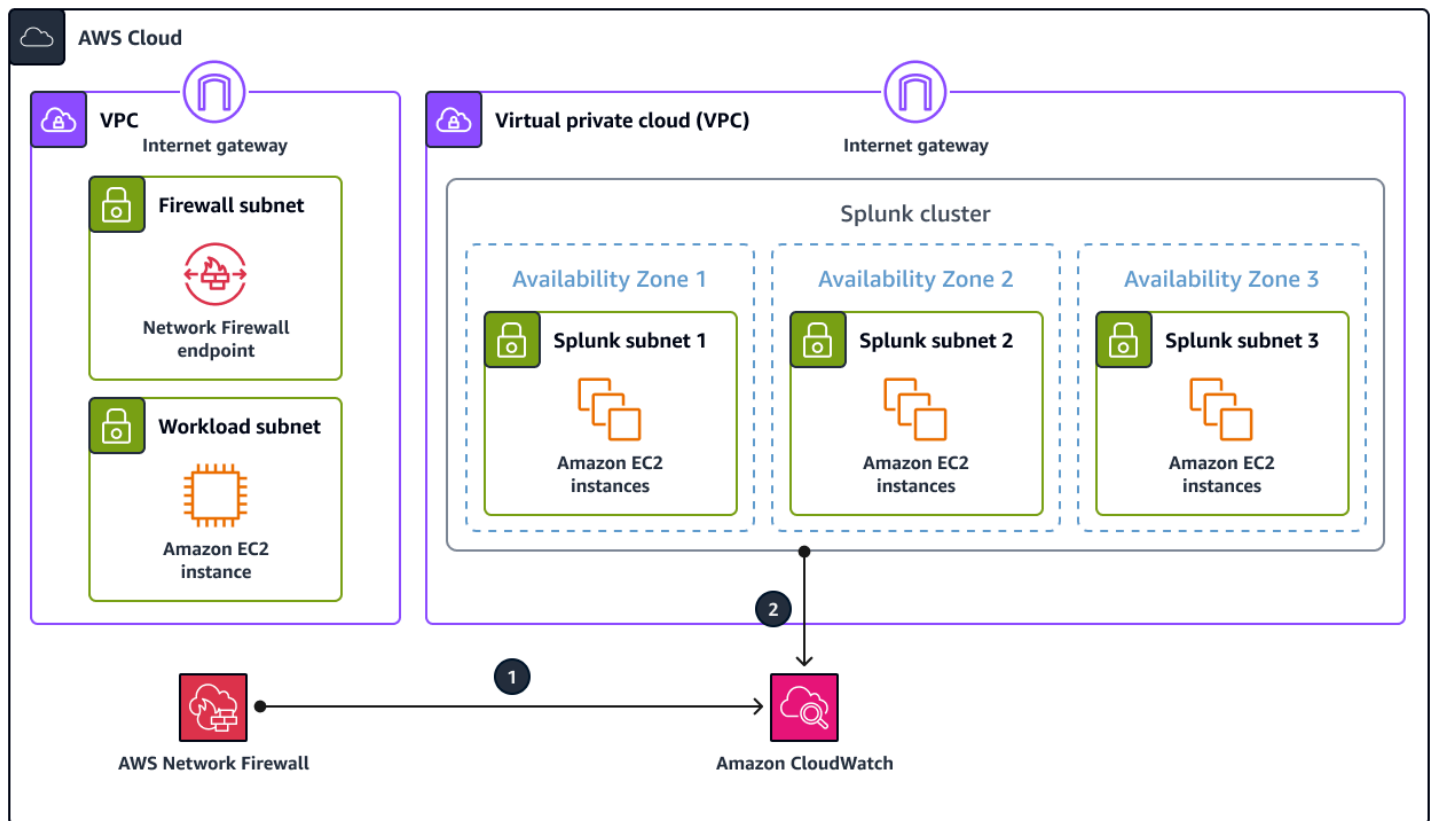

The diagram illustrates the following:

1. Network Firewall publishes logs to CloudWatch Logs.
2. Splunk Enterprise retrieves metrics and logs from CloudWatch.

To populate example metrics and logs in this architecture, a workload generates traffic that passes through the Network Firewall endpoint to go to the internet. This is achieved by the use of [route tables](#). Although this pattern uses a single Amazon EC2 instance as the workload, this pattern can apply to any architecture as long as Network Firewall is configured to send logs to CloudWatch Logs.

This architecture also uses a Splunk Enterprise instance in another virtual private cloud (VPC). However, the Splunk instance can be in another location, such as in the same VPC as the workload, as long as it can reach the CloudWatch APIs.

## Tools

### AWS services

- [Amazon CloudWatch Logs](#) helps you centralize the logs from all your systems, applications, and AWS services so you can monitor them and archive them securely.
- [Amazon Elastic Compute Cloud \(Amazon EC2\)](#) provides scalable computing capacity in the AWS Cloud. You can launch as many virtual servers as you need and quickly scale them up or down.
- [AWS Network Firewall](#) is a stateful, managed, network firewall and intrusion detection and prevention service for VPCs in the AWS Cloud.

### Other tools

- [Splunk](#) helps you monitor, visualize, and analyze log data.

## Epics

### Create an IAM role

Task	Description	Skills required
Create the IAM policy.	Follow the instructions in <a href="#">Creating policies using the JSON editor</a> to create the IAM policy that grants read-only access to the CloudWatch Logs data and CloudWatch metrics. Paste the following policy into the JSON editor. <pre>{   "Statement": [     {</pre>	AWS administrator

Task	Description	Skills required
	<pre>                 "Action": [                     "cloudwatch:List*",                     "cloudwatch:Get*",                     "network-firewall: List*",                     "logs:Describe*",                     "logs:Get*",                     "logs:List*",                     "logs:StartQuery",                     "logs:StopQuery",                     "logs:TestMetricFi lter",                     "logs:FilterLogEve nts",                     "network-firewall: Describe*"                 ],                 "Effect":                     "Allow",                 "Resource":                     "*"             }         ],         "Version":             "2012-10-17"     } </pre>	

Task	Description	Skills required
Create a new IAM role.	Follow the instructions in <a href="#">Creating a role to delegate permissions to an AWS service</a> to create the IAM role that the Splunk Add-On for AWS uses to access CloudWatch. For <b>Permissions policies</b> , choose the policy that you created previously.	AWS administrator
Assign the IAM role to the EC2 instances in the Splunk cluster.	<ol style="list-style-type: none"> <li>1. Open the Amazon EC2 console at <a href="https://console.aws.amazon.com/ec2/">https://console.aws.amazon.com/ec2/</a>.</li> <li>2. In the navigation pane, choose <b>Instances</b>.</li> <li>3. Select the EC2 instances in the Splunk cluster.</li> <li>4. Choose <b>Actions, Security</b>, and then <b>Modify IAM role</b>.</li> <li>5. Select the IAM role that you created previously, and then choose <b>Save</b>.</li> </ol>	AWS administrator

## Install the Splunk Add-On for AWS

Task	Description	Skills required
Install the add-on.	<ol style="list-style-type: none"> <li>1. In the Splunk dashboard, navigate to <b>Splunk Apps</b>.</li> <li>2. Search for <b>Splunk Add-on for Amazon Web Services</b>.</li> <li>3. Choose <b>Install</b>.</li> </ol>	Splunk administrator

Task	Description	Skills required
	4. Provide your Splunk credentials.	
Configure the AWS credentials.	<ol style="list-style-type: none"> <li>1. In the Splunk dashboard, navigate to <b>Splunk Add-on for AWS</b>.</li> <li>2. Choose <b>Configuration</b>.</li> <li>3. In the <b>Autodiscovered IAM Role</b> column, select the IAM role that you created previously.</li> </ol> <p>For more information, see <a href="#">Find an IAM role within your Splunk platform instance</a> in the Splunk documentation.</p>	Splunk administrator

## Configure Splunk access to CloudWatch

Task	Description	Skills required
Configure the retrieval of Network Firewall logs from CloudWatch Logs.	<ol style="list-style-type: none"> <li>1. In the Splunk dashboard, navigate to <b>Splunk Add-on for AWS</b>.</li> <li>2. Choose <b>Input</b>.</li> <li>3. Choose <b>Create New Input</b>.</li> <li>4. In the list, choose <b>Custom Data Type</b>, and then choose <b>CloudWatch Logs</b>.</li> <li>5. Provide the <b>Name</b>, <b>AWS Account</b>, <b>AWS Region</b>, and <b>Log Group</b> for your Network Firewall logs.</li> </ol>	Splunk administrator



Task	Description	Skills required
	<p>6. Choose <b>Save</b>.</p> <p>By default, Splunk fetches the log data every 10 minutes. This is a configurable parameter under <b>Advanced Settings</b>. For more information, see <a href="#">Configure a CloudWatch Logs input using Splunk Web</a> in the Splunk documentation.</p>	

Task	Description	Skills required
Configure the retrieval of Network Firewall metrics from CloudWatch.	<ol style="list-style-type: none"> <li>1. In the Splunk dashboard, navigate to <b>Splunk Add-on for AWS</b>.</li> <li>2. Choose <b>Input</b>.</li> <li>3. Choose <b>Create New Input</b>.</li> <li>4. In the list, choose <b>CloudWatch</b>.</li> <li>5. Provide the <b>Name</b>, <b>AWS Account</b>, and <b>AWS Region</b> for your Network Firewall metrics.</li> <li>6. Next to <b>Metric Configuration</b>, choose <b>Edit in advanced mode</b>.</li> <li>7. (Optional) Delete all preconfigured namespaces.</li> <li>8. Choose <b>Add Namespace</b>, and then name it <b>AWS/NetworkFirewall</b>.</li> <li>9. In <b>Dimension Value</b>, add the following.               <div style="border: 1px solid #ccc; border-radius: 10px; padding: 10px; margin: 10px 0;"> <pre>[{"AvailabilityZone":[".*"],"Engine":[".*"],"FirewallName":[".*"]}]]</pre> </div> </li> <li>10. For <b>Metrics</b>, choose <b>All</b>.</li> <li>11. For <b>Metric Statistics</b>, choose <b>Sum</b>.</li> <li>12. Choose <b>OK</b>.</li> <li>13. Choose <b>Save</b>.</li> </ol>	Splunk administrator

Task	Description	Skills required
	By default, Splunk fetches the metric data every 5 minutes. This is a configurable parameter under <b>Advanced Settings</b> . For more information, see <a href="#">Configure a CloudWatch input using Splunk Web</a> in the Splunk documentation.	

### Create Splunk visualizations by using queries

Task	Description	Skills required
View the top source IP addresses.	<ol style="list-style-type: none"> <li>In the Splunk dashboard , navigate to <b>Search &amp; Reporting</b>.</li> <li>In the <b>enter search here</b> box, enter the following. <div data-bbox="630 1171 1029 1335" data-label="Code-Block"> <pre>sourcetype="aws:cloudwatchlogs"   top event.src_ip</pre> </div> <p>This query displays a table of the source IP addresses with the most traffic, in descending order.</p> </li> <li>For a graphical representation, choose <b>Visualization</b>.</li> </ol>	Splunk administrator
View packet statistics.	<ol style="list-style-type: none"> <li>In the Splunk dashboard , navigate to <b>Search &amp; Reporting</b>.</li> </ol>	Splunk administrator

Task	Description	Skills required
	<p>2. In the <b>enter search here</b> box, enter the following.</p> <pre data-bbox="634 331 1029 531">sourcetype="aws:cloudwatch"   timechart sum(Sum) by metric_name</pre> <p>This query displays a table of the metrics DroppedPackets , PassedPackets , and ReceivedPackets per minute.</p> <p>3. For a graphical representation, choose <b>Visualization</b>.</p>	
View the most-used source ports.	<p>1. In the Splunk dashboard , navigate to <b>Search &amp; Reporting</b>.</p> <p>2. In the <b>enter search here</b> box, enter the following.</p> <pre data-bbox="634 1266 1029 1423">sourcetype="aws:cloudwatchlogs"   top event.dest_port</pre> <p>This query displays a table of the source ports with the most traffic, in descending order.</p> <p>3. For a graphical representation, choose <b>Visualization</b>.</p>	Splunk administrator

## Related resources

### AWS documentation

- [Creating a role to delegate permissions to an AWS service](#) (IAM documentation)
- [Creating IAM policies](#) (IAM documentation)
- [Logging and monitoring in AWS Network Firewall](#) (Network Firewall documentation)
- [Route table configurations for AWS Network Firewall](#) (Network Firewall documentation)

### AWS blog posts

- [AWS Network Firewall deployment models](#)

### AWS Marketplace

- [Splunk Enterprise Amazon Machine Image \(AMI\)](#)

## More patterns

- [Access a bastion host by using Session Manager and Amazon EC2 Instance Connect](#)
- [Access container applications privately on Amazon ECS by using AWS Fargate, AWS PrivateLink, and a Network Load Balancer](#)
- [Access container applications privately on Amazon ECS by using AWS PrivateLink and a Network Load Balancer](#)
- [Centralize DNS resolution by using AWS Managed Microsoft AD and on-premises Microsoft Active Directory](#)
- [Check for single-host network entries in security group ingress rules for IPv4 and IPv6](#)
- [Deploy a firewall using AWS Network Firewall and AWS Transit Gateway](#)
- [Deploy an Amazon API Gateway API on an internal website using private endpoints and an Application Load Balancer](#)
- [Deploy detective attribute-based access controls for public subnets by using AWS Config](#)
- [Deploy preventative attribute-based access controls for public subnets](#)
- [Enable encrypted connections for PostgreSQL DB instances in Amazon RDS](#)
- [Extend VRFs to AWS by using AWS Transit Gateway Connect](#)
- [Migrate an F5 BIG-IP workload to F5 BIG-IP VE on the AWS Cloud](#)
- [Preserve routable IP space in multi-account VPC designs for non-workload subnets](#)
- [Prevent internet access at the account level by using a service control policy](#)
- [Send alerts from AWS Network Firewall to a Slack channel](#)
- [Serve static content in an Amazon S3 bucket through a VPC by using Amazon CloudFront](#)
- [Set up disaster recovery for Oracle JD Edwards EnterpriseOne with AWS Elastic Disaster Recovery](#)
- [Set up DNS resolution for hybrid networks in a multi-account AWS environment](#)
- [Use BMC Discovery queries to extract migration data for migration planning](#)
- [Use Network Firewall to capture the DNS domain names from the Server Name Indication \(SNI\) for outbound traffic](#)

# Operating systems

## Topics

- [Migrate RHEL BYOL systems to AWS License-Included instances by using AWS MGN](#)
- [Resolve connection errors after migrating Microsoft SQL Server to the AWS Cloud](#)
- [More patterns](#)

# Migrate RHEL BYOL systems to AWS License-Included instances by using AWS MGN

Created by Mike Kuznetsov (AWS)

<b>Environment:</b> Production	<b>Source:</b> RHEL BYOL instance (on premises or any other cloud environment)	<b>Target:</b> RHEL instance with AWS License Included
<b>R Type:</b> Rehost	<b>Workload:</b> All other workloads	<b>Technologies:</b> Operating systems; Infrastructure; Migration
<b>AWS services:</b> AWS MGN		

## Summary

When you migrate your workloads to AWS by using AWS Application Migration Service (AWS MGN), you might have to lift and shift (rehost) your Red Hat Enterprise Linux (RHEL) instances and change the license from the default Bring Your Own License (BYOL) model to an AWS License Included (LI) model during migration. AWS MGN supports a scalable approach that uses Amazon Machine Image (AMI) IDs. This pattern describes how to accomplish the license change on RHEL servers during the rehost migration at scale. It also explains how to change the license for a RHEL system that's already running on Amazon Elastic Compute Cloud (Amazon EC2).

## Prerequisites and limitations

### Prerequisites

- Access to the target AWS account
- AWS MGN initialized in the target AWS account and Region for the migration (not required if you have already migrated from your on-premises system to AWS)
- A source RHEL server with a valid RHEL license



## Architecture

This pattern covers two scenarios:

- Migrating a system from on premises directly into an AWS LI instance by using AWS MGN. For this scenario, follow the instructions in the first epic (*Migrate to LI instance - option 1*) and third epic.
- Changing the licensing model from BYOL to LI for a previously migrated RHEL system that's already running on Amazon EC2. For this scenario, follow the instructions in the second epic (*Migrate to LI instance - option 2*) and third epic.

**Note:** The third epic involves reconfiguring the new RHEL instance to use the Red Hat Update Infrastructure (RHUI) servers provided by AWS. This process is the same for both scenarios.

## Tools

### AWS services

- [AWS Application Migration Service \(AWS MGN\)](#) helps you rehost (lift and shift) applications to the AWS Cloud without change and with minimal downtime.

## Epics

### Migrate to LI instance - option 1 (for an on-premises RHEL system)

Task	Description	Skills required
Find the AMI ID of the RHEL AWS LI instance in the target Region.	Visit <a href="#">AWS Marketplace</a> or use the <a href="#">Amazon EC2 console</a> to find the RHEL AMI ID that matches the version of the RHEL source system (for example, RHEL-7.7), and write down the AMI ID. On the Amazon EC2 console, you can filter the AMIs by using one of the following search terms:	Cloud administrator

Task	Description	Skills required
	<ul style="list-style-type: none"><li data-bbox="592 212 997 296">• Description = Provided by Red Hat, Inc.</li><li data-bbox="592 310 938 352">• AMI name = RHEL-7.7</li></ul>	

Task	Description	Skills required
Configure AWS MGN launch settings.	<ol style="list-style-type: none"><li data-bbox="591 226 1013 596">1. On the <a href="#">AWS MGN console</a>, add the source RHEL system: Install the AWS Replication Agent and add the source server by following the instructions in the <a href="#">AWS MGN documentation</a>.</li><li data-bbox="591 617 980 840">2. On the <b>Source servers</b> page, choose the source RHEL system, and then choose the <b>Launch settings</b> tab.</li><li data-bbox="591 861 1013 1520">3. In the <b>General launch settings</b> section, choose <b>Edit</b>. To disable automatic selection and manually specify the target instance type, change <b>Instance type right sizing</b> to <b>None</b>, and then choose <b>Save settings</b>. This lets you use the instance type that you configure in your Amazon EC2 launch template. For more information, see the <a href="#">AWS MGN documentation</a>.</li><li data-bbox="591 1541 1003 1856">4. In the <b>EC2 Launch Template</b> section, choose <b>Modify</b>. In the <b>About modifying EC2 launch templates</b> dialog box, choose <b>Modify</b> again. This opens the Amazon</li></ol>	Cloud administrator

Task	Description	Skills required
	<p>EC2 console so you can change the template for this instance.</p> <p>5. Review the key considerations in the <a href="#">AWS MGN documentation</a>.</p> <p><b>Note:</b> You can disregard the warning against choosing your own AMI.</p> <p>6. On the <a href="#">Amazon EC2 console</a>, in the new launch template, modify the following:</p> <ul style="list-style-type: none"><li>• For <b>AMI</b>, specify the AMI ID you identified previously, or search for RHEL-x and specify the version you require (for example, RHEL-7.7).</li><li>• For <b>Instance type</b>, set the desired target instance type.</li><li>• Leave the following sections unchanged: <b>Key pair (login)</b>, <b>Network settings</b> (unless you want to specify a target subnet and security groups), <b>Storage</b>, <b>Resource tags</b> (unless you want to add or modify any tags).</li></ul>	

Task	Description	Skills required
	<ul style="list-style-type: none"><li>• (Optional) In the <b>Advanced details</b> section, specify the IAM instance profile role, if needed for future management by AWS Systems Manager.</li></ul> <ol style="list-style-type: none"><li>7. Choose <b>Create template version</b>, and then choose the link in the success message to view the launch template.</li><li>8. Choose <b>Actions, Set default version</b>. For <b>Template version</b>, select the latest version (version 2 for a new system), and then choose <b>Set as default version</b>.</li></ol> <p>AWS MGN will now use this version of the launch template to launch test or cutover instances. For more information, see the <a href="#">AWS MGN documentation</a>.</p>	

Task	Description	Skills required
Validate settings.	<ol style="list-style-type: none"><li data-bbox="592 226 1027 457">1. On the <a href="#">AWS MGN console</a>, on the <b>Source servers</b> page, choose your source server, and then choose the <b>Launch settings</b> tab.</li><li data-bbox="592 478 1027 751">2. In the <b>EC2 Launch Template</b> section, verify that the <b>Instance type</b>, <b>Subnet</b>, and <b>Security groups</b> parameters are set correctly.</li></ol> <p data-bbox="630 793 1027 1161"><b>Note:</b> This section doesn't display the AMI ID you selected. To see the ID, you can open the <a href="#">Amazon EC2 console</a>, <b>Launch Templates</b> view, and search for the template ID that's shown in this section.</p>	Cloud administrator

Task	Description	Skills required
Launch the new LI instance.	<ol style="list-style-type: none"><li data-bbox="591 226 1027 1024">1. When the initial sync is complete, the <b>Migration lifecycle</b> column for the server on the AWS MGN console <b>Source servers</b> page changes to <b>Ready for testing</b>. To launch the new test instance, choose your source server, open the <b>Test and cutover</b> menu, and then choose <b>Launch test instances</b>. Choose <b>View job details</b> to monitor the status of the launch job. For more information, see the <a href="#">AWS MGN documentation</a>.</li><li data-bbox="591 1045 1027 1675">2. Wait for the launch job to complete, and then open the launched EC2 instance details page. Choose the <b>Details</b> tab and verify that the <b>Instance details</b> section contains the following:<ul style="list-style-type: none"><li data-bbox="630 1440 980 1520">• Platform details: "Red Hat Enterprise Linux"</li><li data-bbox="630 1541 1008 1675">• AMI name: The name of AMI you specified in the EC2 launch template</li></ul></li><li data-bbox="591 1696 997 1875">3. Cut over to the new LI instance by following the instructions in the <a href="#">AWS MGN documentation</a>.</li></ol>	Cloud administrator

Task	Description	Skills required
	4. Reconfigure the new instance to use the AWS-provided RHUI servers by following the steps in the last epic.	

### Migrate to LI instance - option 2 (for a RHEL BYOL EC2 instance)

Task	Description	Skills required
Migrate your RHEL BYOL EC2 instance to an AWS LI instance.	<p>You can switch RHEL systems that you previously migrated to AWS as BYOL to AWS LI instances by moving their disks (Amazon Elastic Block Store volumes) and attaching them to a new LI instance. To make this switch, follow these steps:</p> <ol style="list-style-type: none"> <li>1. Launch a new target RHEL instance from a RHEL LI AMI. Make sure that the AMI you selected: <ul style="list-style-type: none"> <li>• Uses the same RHEL version as your current RHEL instance.</li> <li>• Has the same boot-up process (BIOS or UEFI) as your current RHEL instance. For example, if the source server is BIOS-based, use the AWS Marketplace RHEL AMI</li> </ul> </li> </ol>	Cloud administrator



Task	Description	Skills required
	<p>that is also BIOS-based; for UEFI-based systems, choose the UEFI-based AMI.</p> <ol style="list-style-type: none"><li data-bbox="592 411 980 541">2. Stop both instances: the new LI instance and the original source instance.</li><li data-bbox="592 564 987 741">3. Detach all EBS volumes (including the root disk) from the new LI instance and delete them.</li><li data-bbox="592 764 1029 1371">4. Detach all EBS volumes (including the root disk) from the old source instance and attach them to the new LI instance. Keep the same mapping of volumes to devices. (For example, the EBS volume that was previously attached to the <code>/dev/sda</code> drive must be attached as <code>/dev/sda</code> to the new instance.)</li><li data-bbox="592 1394 964 1476">5. Delete the source (now diskless) instance.</li><li data-bbox="592 1499 997 1772">6. Start the new LI instance. Log in to the instance and reconfigure it to use the AWS-provided RHUI servers by following the steps in the next epic.</li></ol>	

## Reconfigure RHEL OS to use AWS-provided RHUI – both options

Task	Description	Skills required
<p>Deregister the OS from the Red Hat subscription and license.</p>	<p>After migration and successful cutover, the RHEL system has to be removed from the Red Hat subscription to stop consuming the Red Hat license and avoid double billing.</p> <p>To remove RHEL OS from Red Hat subscription, follow the process described in the <a href="#">Red Hat Subscription Management (RHSM) documentation</a>. Use the CLI command:</p> <pre>subscription-manager unregister</pre> <p>You can also disable the subscription manager plugin to stop checking the status of the subscription on every <b>yum</b> call. To do this, edit the configuration file <code>/etc/yum/pluginconf.d/subscription-manager.conf</code> and change the parameter <code>enabled=1</code> to <code>enabled=0</code>.</p>	<p>Linux or system administrator</p>
<p>Replace the old update configuration (RHUI, Red Hat Satellite network, yum</p>	<p>You must reconfigure the migrated RHEL system to use the AWS-provided</p>	<p>Linux or system administrator</p>

Task	Description	Skills required
repositories) with the AWS-provided RHUI.	<p>RHUI servers. This gives you access to the RHUI servers within AWS Regions without requiring the external update infrastructure. The change involves the following process:</p> <ol style="list-style-type: none"><li>1. Back up the existing <b>yum</b> configuration.</li><li>2. Remove the old RHUI (<b>yum</b> repositories) configuration and packages.</li><li>3. Add the new AWS-provided RHUI configuration and certificate packages. You have to retrieve these from another RHEL instance on AWS because these configuration packages are available only on AWS-provided RHUI servers.</li></ol> <p>Here are the detailed steps and commands:</p> <ol style="list-style-type: none"><li>1. Back up the existing <b>yum</b> configuration and certificates by copying all <code>/etc/yum*</code> and <code>/etc/pki/*</code> folders to a backup location. For example:</li></ol> <pre>mkdir yum-backup</pre>	

Task	Description	Skills required
	<pre>cp -ra /etc/yum* /etc/ pki ./yum-backup tar czf yum-backup p.tgz ./yum-backup</pre> <p>2. Remove the old RHUI configuration and packages:</p> <p>a. Find all installed RHUI packages:</p> <pre>sudo rpm -qa   grep rhui</pre> <p>b. Delete these packages:</p> <pre>sudo yum remove \$(rpm -qa   grep rhui)</pre> <p>c. Remove the <code>/etc/yum/vars/releasever</code> file, if it exists.</p> <p>3. Add the new AWS-provided RHUI and certificate packages. You must retrieve these from another RHEL instance on AWS. There are several ways to do this. For example, you can follow the instructions provided in the <a href="#">Red Hat Knowledgebase article</a>:</p> <p>a. Launch another RHEL (RHEL-EC2) instance from <a href="#">AWS Marketplace</a>.</p>	

Task	Description	Skills required
	<p>b. Download two packages from this instance: the latest RHUI client configuration package and the certificate authority (CA) certificates. For example, run this command from your desktop:</p> <pre>ssh RHEL-EC2 "sudo yumdownloader ca-certificates rh-amazon-rhui-client"</pre> <p>c. Copy the packages from the RHEL-EC2 instance to the new migrated system. For example:</p> <pre>scp RHEL-EC2:rh-amazon-rhui-client\* RHEL-EC2:ca-certificates\* . ssh &lt;migrated-instance&gt; "mkdir /tmp/amazon" scp rh-amazon-rhui-client* ca-certificates* &lt;migrated-instance&gt;:/tmp/amazon</pre> <p>d. Install the new RHUI and CA configuration packages on the migrated instance:</p>	

Task	Description	Skills required
	<pre>ssh &lt;migrated- instance&gt; "sudo rpm -Uhv /tmp/amazon/ *"</pre>	
Validate the configuration.	On the target migrated instance, verify that the new configuration is correct: <pre>sudo yum clean all sudo yum repolist</pre>	Linux or system administrator

## Related resources

- [AWS Application Migration Service \(AWS MGN\) User Guide](#)
- [Get an AWS RHUI client package supporting IMDSv2](#) (Red Hat Knowledgebase article)
- [Amazon EC2 launch templates](#) (Amazon EC2 documentation)

# Resolve connection errors after migrating Microsoft SQL Server to the AWS Cloud

Created by Premkumar Chelladurai (AWS)

**Environment:** Production

**Technologies:** Operating systems; Migration

**Workload:** Microsoft

**AWS services:** Amazon EC2

## Summary

After you migrate Microsoft SQL Server running on Windows Server 2008 R2, 2012, or 2012 R2 to Amazon Elastic Compute Cloud (Amazon EC2) instances on the Amazon Web Services (AWS) Cloud, the connection to SQL Server fails and the following errors appear:

- [Microsoft][ODBC SQL Server Driver][DBNETLIB] General Network error
- ERROR [08S01] [Microsoft][SQL Native Client]Communication link failure. System.Data.SqlClient.SqlException: A transport-level error has occurred when sending the request to the server. (provider: TCP Provider, error: 0 - An existing connection was forcibly closed by the remote host.)
- TCP Provider: The semaphore timeout period has expired

This pattern describes how you can resolve these errors by turning off the Windows Scalable Networking Pack (SNP) features at the operating system (OS) and network interface level for SQL Server running on Windows Server 2008 R2, 2012, or 2012 R2.

## Prerequisites and limitations

### Prerequisites

- Administrator privileges for Windows Server.
- If you used AWS Application Migration Service as your migration tool, you require one of the following Windows Server versions:

- Windows Server 2008 R2 Service Pack 1, 2012, or 2012 R2
- If you used CloudEndure Migration as your migration tool, you require one of the following Windows Server versions:
  - Windows Server 2003 R2 Service Pack 3, 2008, 2008 R2 Service Pack 1, 2012, or 2012 R2

## Tools

- [Amazon EC2](#) – Amazon Elastic Compute Cloud (Amazon EC2) provides scalable computing capacity in the AWS Cloud. You can use Amazon EC2 to launch as many or as few virtual servers as you need, and you can scale out or scale in.
- [Windows Server](#) – Windows Server is a platform for building an infrastructure of connected applications, networks, and web services.

## Epics

### Turn off SNP features at the OS and elastic network interface levels

Task	Description	Skills required
Turn off SNP features at the OS level.	<ol style="list-style-type: none"> <li>1. Sign in to Windows Server and open a command prompt as an administrator.</li> <li>2. Run the <code>netsh int tcp show global</code> command.</li> <li>3. In the output, check if either Receive-Side Scaling or Chimney Offload is in enabled mode. If either of them is enabled, run the following commands:           <ul style="list-style-type: none"> <li>• <code>netsh int tcp set global chimney=disabled</code></li> </ul> </li> </ol>	AWS administrator, AWS systems administrator, Migration engineer, Cloud administrator



Task	Description	Skills required
	<ul style="list-style-type: none"><li>• netsh int tcp set global rss=disabled</li></ul>	
Turn off SNP features at the elastic network interface level.	<ol style="list-style-type: none"><li>1. Choose <b>Start</b>, enter <code>ncpa.cpl</code>, and then press <b>Enter</b>.</li><li>2. Right-click <b>Elastic Network Adapter</b>.</li><li>3. In the popup menu, choose <b>Properties</b>.</li><li>4. In the <b>Ethernet Adapter Properties</b> window, choose <b>Configure</b>.</li><li>5. In the <b>Amazon Elastic Network Adapter Properties</b> popup window, choose the <b>Advanced</b> tab.</li><li>6. In the <b>Property</b> section, turn off all offloads and RSS.</li></ol>	AWS administrator, Cloud administrator, AWS systems administrator

## Related resources

- [How to troubleshoot advanced network performance features such as RSS and NetDMA](#)

## More patterns

- [Back up Sun SPARC servers in the Stomasys Charon-SSP emulator on the AWS Cloud](#)
- [Centralize DNS resolution by using AWS Managed Microsoft AD and on-premises Microsoft Active Directory](#)
- [Migrate an on-premises Microsoft SQL Server database to Amazon RDS for SQL Server using native backup and restore methods](#)
- [Migrate Db2 for LUW to Amazon EC2 with high availability disaster recovery](#)
- [Monitor SAP RHEL Pacemaker clusters by using AWS services](#)
- [Rehost on-premises workloads in the AWS Cloud: migration checklist](#)
- [Restart the AWS Replication Agent automatically without disabling SELinux after rebooting a RHEL source server](#)

# Operations

## Topics

- [Automatically create an RFC in AMS using Python](#)
- [Create a RACI or RASCI matrix for a cloud operating model](#)
- [Create tag-based Amazon CloudWatch dashboards automatically](#)
- [Find AWS resources based on their creation date by using AWS Config advanced queries](#)
- [View EBS snapshot details for your AWS account or organization](#)
- [More patterns](#)

# Automatically create an RFC in AMS using Python

*Created by Gnanasekaran Kailasam (AWS)*

**Environment:** Production

**Technologies:** Operations;  
CloudNative

**AWS services:** AWS Managed  
Services

## Summary

AWS Managed Services (AMS) helps you to operate your cloud-based infrastructure more efficiently and securely by providing ongoing management of your Amazon Web Services (AWS) infrastructure. To make a change to your managed environment, you need to create and submit a new request for change (RFC) that includes a change type (CT) ID for a particular operation or action.

However, manually creating an RFC can take around five minutes and teams in your organization might need to submit multiple RFCs every day. This pattern helps you to automate the RFC creation process, reduce the creation time for each RFC, and eliminate manual errors.

This pattern describes how to use Python code to automatically create the Stop EC2 instance RFC that stops Amazon Elastic Compute Cloud (Amazon EC2) instances in your AMS account. You can then apply this pattern's approach and the Python automation to other RFC types.

## Prerequisites and limitations

### Prerequisites

- An AMS Advanced account. For more information about this, see [AMS operations plans](#) in the AWS Managed Services documentation.
- At least one existing EC2 instance in your AMS account.
- An understanding of how to create and submit RFCs in AMS.
- Familiarity with Python.

### Limitations

- You can only use RFCs for changes in your AMS account. Your AWS account uses different processes for similar changes.

## Architecture

### Technology stack

- AMS
- AWS Command Line Interface (AWS CLI)
- AWS SDK for Python (Boto3)
- Python and its required packages (JSON and Boto3)

### Automation and scale

This pattern provides sample code to automate the Stop EC2 instance RFC, but you can use this pattern's sample code and approach for other RFCs.

## Tools

- [AWS Managed Services](#) – AMS helps you to operate your AWS infrastructure more efficiently and securely.
- [AWS CLI](#) – AWS Command Line Interface (AWS CLI) is a unified tool to manage your AWS services. In AMS, the change management API provides operations to create and manage RFCs.
- [AWS SDK for Python \(Boto3\)](#) – SDK for Python makes it easy to integrate your Python application, library, or script with AWS services.

## Code

The AMS Stop EC2 Instance .zip file (attached) contains the Python code for creating a Stop EC2 instance RFC. You can also configure this code to submit a single RFC for multiple EC2 instances.

## Epics

### Option 1 – Set up environment for macOS or Linux

Task	Description	Skills required
Install and validate Python.	<ol style="list-style-type: none"> <li>1. Open a terminal window and run the <code>brew install python3</code> command.</li> <li>2. Validate that Python is correctly installed by running the <code>python --version</code> command.</li> <li>3. Validate that pip is correctly installed by running the <code>pip --version</code> command.</li> </ol>	AWS systems administrator
Install AWS CLI.	Run the <code>pip install awscli --upgrade --user</code> command to install AWS CLI.	AWS systems administrator
Install Boto3.	Run the <code>pip install boto3</code> command to install Boto3.	AWS systems administrator
Install JSON.	Run the <code>pip install json</code> command to install JSON.	AWS systems administrator
Set up AMS CLI.	Sign in to the AWS Management Console, open the AMS console, and then choose <b>Documentation</b> . Download the .zip file that contains the AMS CLI, unzip	AWS systems administrator

Task	Description	Skills required
	<p>it, and then install it on your local machine.</p> <p>After you install AMS CLI, run the <code>aws amscm help</code> command. The output provides information about the AMS change management process.</p>	

## Option 2 – Set up environment for Windows

Task	Description	Skills required
Install and validate Python.	<ol style="list-style-type: none"> <li>1. Open the <a href="#">Python releases for Windows</a> page, download the latest version, and then install Python.</li> <li>2. Validate that Python is correctly installed by running the <code>python --version</code> command.</li> <li>3. Validate that pip is correctly installed by running the <code>pip --version</code> command.</li> </ol>	AWS systems administrator
Install AWS CLI.	Run the <code>pip install awscli --upgrade --user</code> command to install AWS CLI.	AWS systems administrator

Task	Description	Skills required
Install Boto3.	Run the <code>pip install boto3</code> command to install Boto3.	AWS systems administrator
Install JSON.	Run the <code>pip install json</code> command to install JSON.	AWS systems administrator
Set up AMS CLI.	<p>Sign in to the AWS Management Console, open the AMS console, and then choose <b>Documentation</b>. Download the .zip file that contains the AMS CLI, unzip it, and then install it on your local machine.</p> <p>After you install AMS CLI, run the <code>aws amscm help</code> command. The output provides information about the AMS change management process</p>	AWS systems administrator

### Extract the CT ID and execution parameters for the RFC

Task	Description	Skills required
Extract the CT ID, version, and execution parameters for the RFC.	<p>Each RFC has a different CT ID, version, and execution parameters. You can extract this information by using one of the following options:</p> <ol style="list-style-type: none"> <li>1. Follow the instructions from the <i>Finding a request</i></li> </ol>	AWS systems administrator



Task	Description	Skills required
	<p><i>for change (RFC) with the CLI section in <a href="#">RFC use examples</a> from the AWS Managed Services documentation.</i></p> <p>2. Open an existing RFC of a similar type or create new RFC as a test through the AMS console. Use the RFC's CT ID and execution parameters. For more information about this, see <a href="#">Finding an RFC with the console</a> in the AWS Managed Services documentation.</p> <p><b>Note:</b> To adapt this pattern's Python automation for other RFCs, replace the CT type and parameter values in the <code>ams_stop_ec2_instance</code> Python code file from the <code>AMS Stop EC2 Instance.zip</code> file (attached) with those that you extracted.</p>	

## Run the Python automation

Task	Description	Skills required
Run the Python automation.	1. Download the <code>AMS Stop EC2 Instance.zip</code> file	AWS systems administrator

Task	Description	Skills required
	<p>(attached) to your local machine and extract the file.</p> <ol style="list-style-type: none"><li data-bbox="591 365 976 495">2. Update <code>input_instances</code> with your EC2 instance information.</li><li data-bbox="591 520 976 646">3. Open a terminal and navigate to the path for your extracted code</li><li data-bbox="591 672 976 798">4. Run the <code>pythonamazon_stop_ec2_instance.py</code> command.</li></ol>	

## Related resources

- [What are change types?](#)
- [CLI tutorial: High availability two-tier stack \(Linux/RHEL\)](#)

## Attachments

To access additional content that is associated with this document, unzip the following file: [attachment.zip](#)

# Create a RACI or RASCI matrix for a cloud operating model

Created by Teddy Germade (AWS), Jerome Descreux (AWS), Josselin LE MINEUR (AWS), and Florian Leroux (AWS)

**Environment:** Production

**Technologies:** Operations;  
Management & governance

## Summary

The Cloud Center of Excellence (CCoE) or CEE (Cloud Enablement Engine) is an empowered and accountable team that is focused on operational readiness for the cloud. Their key focus is to transform the information IT organization from an on-premises operating model to a cloud operating model. The CCoE should be a cross-functional team that includes representation from infrastructure, applications, operations, and security.

One of the key components of a cloud operating model is a *RACI matrix* or *RASCI matrix*. This is used to define the roles and responsibilities for all parties involved in migration activities and cloud operations. The matrix name is derived from the responsibility types defined in the matrix: responsible (R), accountable (A), support (S), consulted (C), and informed (I). The support type is optional. If you include it, it's called a *RASCI matrix*, and if you exclude it, it's called a *RACI matrix*.

By starting with the attached template, your CCoE team can create a RACI or RASCI matrix for your organization. The template contains teams, roles, and tasks that are common in cloud operating models. The foundation of this matrix is the tasks related to operations integration and CCoE capabilities. However, you can customize this template to meet the needs of your organization's structure and use case.

There are no limits to the implementation of a RACI matrix. This approach works for large organizations, start-ups, and everything in between. For small organizations, the same resource can fill several roles.

# Epics

## Create the matrix

Task	Description	Skills required
Identify key stakeholders.	Identify key service and team managers that are linked to the strategic objectives of your cloud operating model.	Project manager
Customize the matrix template.	<p>Download the template in the <a href="#">Attachments</a> section, and then update the RACI or RASCI matrix as follows:</p> <ul style="list-style-type: none"><li>• On the <b>Cloud Teams</b> worksheet, update the CCoE stream names, team names, and team descriptions as needed for your organization.</li><li>• On the <b>Cloud Roles</b> worksheet, update the roles, team names, and role descriptions as needed for your organization.</li><li>• On the <b>RASCI</b> worksheet, update the following as needed for your organization:<ul style="list-style-type: none"><li>• In row 1 and column A, update the CCoE streams.</li><li>• In row 2, update the team names.</li></ul></li></ul>	Project manager

Task	Description	Skills required
	<ul style="list-style-type: none"><li>• In row 3, update the role names.</li><li>• In columns D and E, update the general fields and activities that you want to include in your RASCI chart.</li></ul>	
Plan meetings.	<ol style="list-style-type: none"><li>1. Communicate the RASCI objectives to all stakeholders.</li><li>2. Plan one or more meetings so that an empowered representative from each team can attend.</li></ol>	Project manager

Task	Description	Skills required
Complete the matrix.	<p>In the meeting with all stakeholders, do the following:</p> <ol style="list-style-type: none"><li>1. Confirm that a representative from each team is present. Team participation is mandatory so that you can accurately assign responsibility types for each task.</li><li>2. Review the what a RASCI matrix is and the objectives with the participants.</li><li>3. Review the <a href="#">shared responsibility model</a> with the participants so that they understand the scope of their organization's responsibilities for security in the cloud.</li><li>4. On the <b>RASCI</b> worksheet , for each task or activity, complete columns F through AN to assign the following responsibility types:<ul style="list-style-type: none"><li>• <b>Responsible (R)</b> – This role is responsible for performing the work to complete the task.</li><li>• <b>Accountable (A)</b> – This role is held accountable for making sure the</li></ul></li></ol>	Project manager

Task	Description	Skills required
	<p>task is completed. This role is also responsible for ensuring the prerequisites are met and delegating the task to those who are responsible.</p> <ul style="list-style-type: none"><li>• <b>Support (S)</b> – This role helps those who are responsible complete the task. This responsibility type is optional, and you can choose to exclude it in order to create a more traditional RACI matrix.</li><li>• <b>Consulted (C)</b> – This role should be consulted for opinions or expertise on the task. Depending on the task, this responsibility type might not be required.</li><li>• <b>Informed (I)</b> – This role should be kept up to date on the progress of the task and notified when the task is completed.</li><li>• <b>Blank</b> – This role is not involved in the activity or task.</li></ul>	

Task	Description	Skills required
Share the RASCI matrix.	When the RACI or RASCI matrix is complete, have it approved by leadership. Save it in a shared repository or central location where all stakeholders can access it. We recommend that you use standard document control processes to record and approve revisions to the matrix.	Project manager

## Related resources

- [AWS shared responsibility model](#)

## Attachments

To access additional content that is associated with this document, unzip the following file: [attachment.zip](#)



# Create tag-based Amazon CloudWatch dashboards automatically

Created by Janak Vadaria (AWS), RAJNEESH TYAGI (AWS), and Vinodkumar Mandalapu (AWS)

**Code repository:** [Goldensignals](#)

**Environment:** Production

**Technologies:** Operations; CloudNative; Management & governance

**AWS services:** AWS CDK; Amazon CloudWatch; AWS CodeBuild; AWS CodePipeline

## Summary

Creating different Amazon CloudWatch dashboards manually can be time-consuming, particularly when you have to create and update multiple resources to automatically scale your environment. A solution that creates and updates your CloudWatch dashboards automatically can save you time. This pattern helps you deploy a fully automated AWS Cloud Development Kit (AWS CDK) pipeline that creates and updates CloudWatch dashboards for your AWS resources based on tag change events, to display Golden Signals metrics.

In site reliability engineering (SRE), Golden Signals refers to a comprehensive set of metrics that offer a broad view of a service from a user or consumer perspective. These metrics consist of latency, traffic, errors, and saturation. For more information, see [What is Site Reliability Engineering \(SRE\)?](#) on the AWS website.

The solution provided by this pattern is event-driven. After it's deployed, it continuously monitors the tag change events and automatically updates the CloudWatch dashboards and alarms.

## Prerequisites and limitations

### Prerequisites

- An active AWS account
- AWS Command Line Interface (AWS CLI), [installed and configured](#)

- [Prerequisites](#) for the AWS CDK v2
- A [bootstrapped environment](#) on AWS
- [Python version 3](#)
- [AWS SDK for Python \(Boto3\)](#), installed
- [Node.js version 18](#) or later
- Node package manager (npm), [installed and configured](#) for the AWS CDK
- Moderate (level 200) familiarity with the AWS CDK and AWS CodePipeline

## Limitations

This solution currently creates automated dashboards for the following AWS services only:

- [Amazon Relational Database Service \(Amazon RDS\)](#)
- [AWS Auto Scaling](#)
- [Amazon Simple Notification Service \(Amazon SNS\)](#)
- [Amazon DynamoDB](#)
- [AWS Lambda](#)

## Architecture

### Target technology stack

- [CloudWatch dashboards](#)
- [CloudWatch alarms](#)

### Target architecture

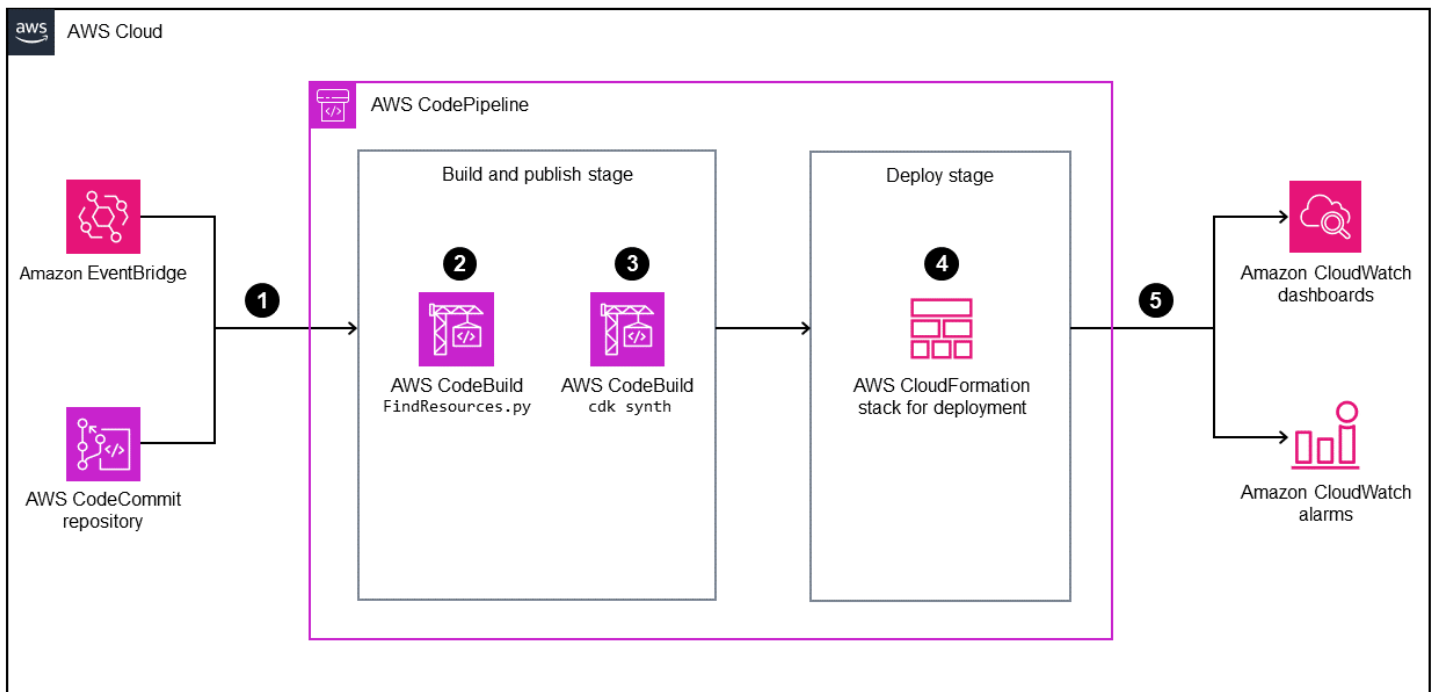

1. An AWS tag change event for the configured application tags or code changes initiates a pipeline in AWS CodePipeline to build and deploy updated CloudWatch dashboards.
2. AWS CodeBuild runs a Python script to find the resources that have configured tags and stores the resource IDs in a local file in a CodeBuild environment.
3. CodeBuild runs **cdk synth** to generate AWS CloudFormation templates that deploy CloudWatch dashboards and alarms.
4. CodePipeline deploys the AWS CloudFormation templates to the specified AWS account and Region.
5. When the AWS CloudFormation stack has been deployed successfully, you can view the CloudWatch dashboards and alarms.

## Automation and scale

This solution has been automated by using the AWS CDK. You can find the code in the GitHub [Golden Signals Dashboards on Amazon CloudWatch](#) repository. For additional scaling and to create custom dashboards, you can configure multiple tag keys and values.

## Tools

### Amazon services

- [Amazon EventBridge](#) is a serverless event bus service that helps you connect your applications with real-time data from a variety of sources, including AWS Lambda functions, HTTP invocation endpoints using API destinations, or event buses in other AWS accounts.
- [AWS CodePipeline](#) helps you quickly model and configure the different stages of a software release and automate the steps required to release software changes continuously.
- [AWS CodeBuild](#) is a fully managed build service that helps you compile source code, run unit tests, and produce artifacts that are ready to deploy.
- [AWS CodeCommit](#) is a version control service that helps you privately store and manage Git repositories without needing to manage your own source control system.
- [AWS Command Line Interface \(AWS CLI\)](#) is an open source tool that helps you interact with AWS services through commands in your command-line shell.
- [AWS Identity and Access Management \(IAM\)](#) helps you securely manage access to your AWS resources by controlling who is authenticated and authorized to use them.
- [Amazon Simple Storage Service \(Amazon S3\)](#) is a cloud-based object storage service that helps you store, protect, and retrieve any amount of data.

## Best practices

As a security best practice, you can use encryption and authentication for the source repositories that connect to your pipelines. For additional best practices, see [CodePipeline best practices and use cases](#) in the CodePipeline documentation.

## Epics

### Configure and deploy the sample application

Task	Description	Skills required
Configure and deploy the sample application.	<ol style="list-style-type: none"><li>1. Clone the GitHub <a href="#">sample code repository</a> by using the command: <pre>git clone https://github.com/aws-samples/golden-signals</pre></li></ol>	AWS DevOps

Task	Description	Skills required
	<pre>-dashboards-sample-app</pre> <ol style="list-style-type: none"><li data-bbox="592 321 1024 596">2. Navigate to the cloned repository on your computer and open the <code>src/project-settings.ts</code> file with the editor of your choice.</li><li data-bbox="592 621 1019 846">3. Change the <code>projectSettings</code> constant value according to your AWS resource tags and application mappings.</li><li data-bbox="592 871 1024 1795">4. Set the <code>AWS_ACCOUNT</code>, <code>AWS_REGION</code>, and <code>GS_DASHBOARD_INSTANCE</code> environment variables:<ul style="list-style-type: none"><li data-bbox="630 1121 987 1245">• Set <code>AWS_ACCOUNT</code> to the account ID of your AWS account.</li><li data-bbox="630 1270 1024 1451">• Set <code>AWS_REGION</code> to the Region where you want to deploy the sample application.</li><li data-bbox="630 1476 1019 1795">• Set <code>GS_DASHBOARD_INSTANCE</code> to <code>dev</code>, <code>test</code>, or <code>prod</code>, depending on your development environment. (We recommend <code>test</code> for the testing</li></ul></li></ol>	

Task	Description	Skills required
	<p>procedure described in this pattern.)</p> <ol style="list-style-type: none"><li>5. Set up the AWS CLI with your AWS credentials. For more information, see <a href="#">Set and view configuration settings using commands</a> in the AWS CLI documentation.</li><li>6. Run the following command to deploy the Golden Signals dashboard sample application:</li></ol> <pre data-bbox="630 873 1029 953">sh deploy.sh</pre>	

Task	Description	Skills required
Automatically create dashboards and alarms.	<p>After you deploy the sample application, you can create any of the resources that this solution supports with expected tag values, which will automatically create the specified dashboards and alarms.</p> <p>To test this solution, create an AWS Lambda function:</p> <ol style="list-style-type: none"><li>1. Sign in to the AWS Management Console in the AWS Region where you deployed the sample application.</li><li>2. Open the Lambda console at <a href="https://console.aws.amazon.com/lambda/">https://console.aws.amazon.com/lambda/</a>.</li><li>3. Choose <b>Create a function</b>, and then enter a function name.</li><li>4. In the <b>Advanced settings</b> pane, select <b>Enable tags</b>, and then choose <b>Add new tag</b>. Enter the following key and value:<ul style="list-style-type: none"><li>• Key: AutoDashboard</li><li>• Value: True</li></ul></li><li>5. Choose <b>Create function</b>.</li></ol> <p>The Lambda function immediately starts a code</p>	AWS DevOps

Task	Description	Skills required
	<p>pipeline, which creates the dashboards and alarms for that particular Lambda function automatically.</p> <ol style="list-style-type: none"><li data-bbox="592 415 1027 968">6. To view the automated dashboards and alarms, open the CloudWatch console at <a href="https://console.aws.amazon.com/cloudwatch/">https://console.aws.amazon.com/cloudwatch/</a>. You can view the custom dashboards and alarms for the function you specified in the <code>projectSettings</code> constant (<b>APP1-lambda</b> by default).</li><li data-bbox="592 995 1027 1262">7. Select the dashboard for the Lambda function to view additional automated dashboards that were created as part of this solution.</li><li data-bbox="592 1289 1027 1703">8. Repeat these steps for other services, such as Amazon RDS, Amazon SNS, AWS Auto Scaling, and DynamoDB, to generate the associated dashboards. For an example for Amazon RDS, see the <a href="#">Additional information</a> section.</li></ol>	



## Remove the sample application

Task	Description	Skills required
Remove the <code>golden-signals-dashboard</code> construct.	<ol style="list-style-type: none"><li>To remove all the AWS CloudFormation stacks created by the sample application, you have to reconfigure the <code>AWS_ACCOUNT</code> , <code>AWS_REGION</code> , and <code>GS_DASHBOARD_INSTANCE</code> environment variables. The <code>destroy.sh</code> command requires these configurations.<ul style="list-style-type: none"><li><code>AWS_ACCOUNT</code> is the account ID of your AWS account.</li><li><code>AWS_REGION</code> is the Region where you deployed your sample application.</li><li><code>GS_DASHBOARD_INSTANCE</code> is <code>dev</code>, <code>test</code>, or <code>prod</code>, based on your previous settings.</li></ul></li><li>Set up AWS CLI with your AWS credentials.</li><li>Run the following command to remove the sample application and all associated AWS CloudFormation stacks:</li></ol>	AWS DevOps

Task	Description	Skills required
	<pre>sh destroy.sh</pre>	

## Troubleshooting

Issue	Solution
Python command not found (referring to <code>findresources.sh</code> , line 8).	Check the version of your Python installation. If you have installed Python version 3, replace <code>python</code> with <code>python3</code> on line 8 of the <code>resources.sh</code> file, and run the <code>sh deploy.sh</code> command again to deploy the solution.

## Related resources

- [Bootstrapping](#) (AWS CDK documentation)
- [Using named profiles](#) (AWS CLI documentation)
- [AWS CDK Workshop](#)

## Additional information

The following illustration shows a sample dashboard for Amazon RDS that is created as part of this solution.

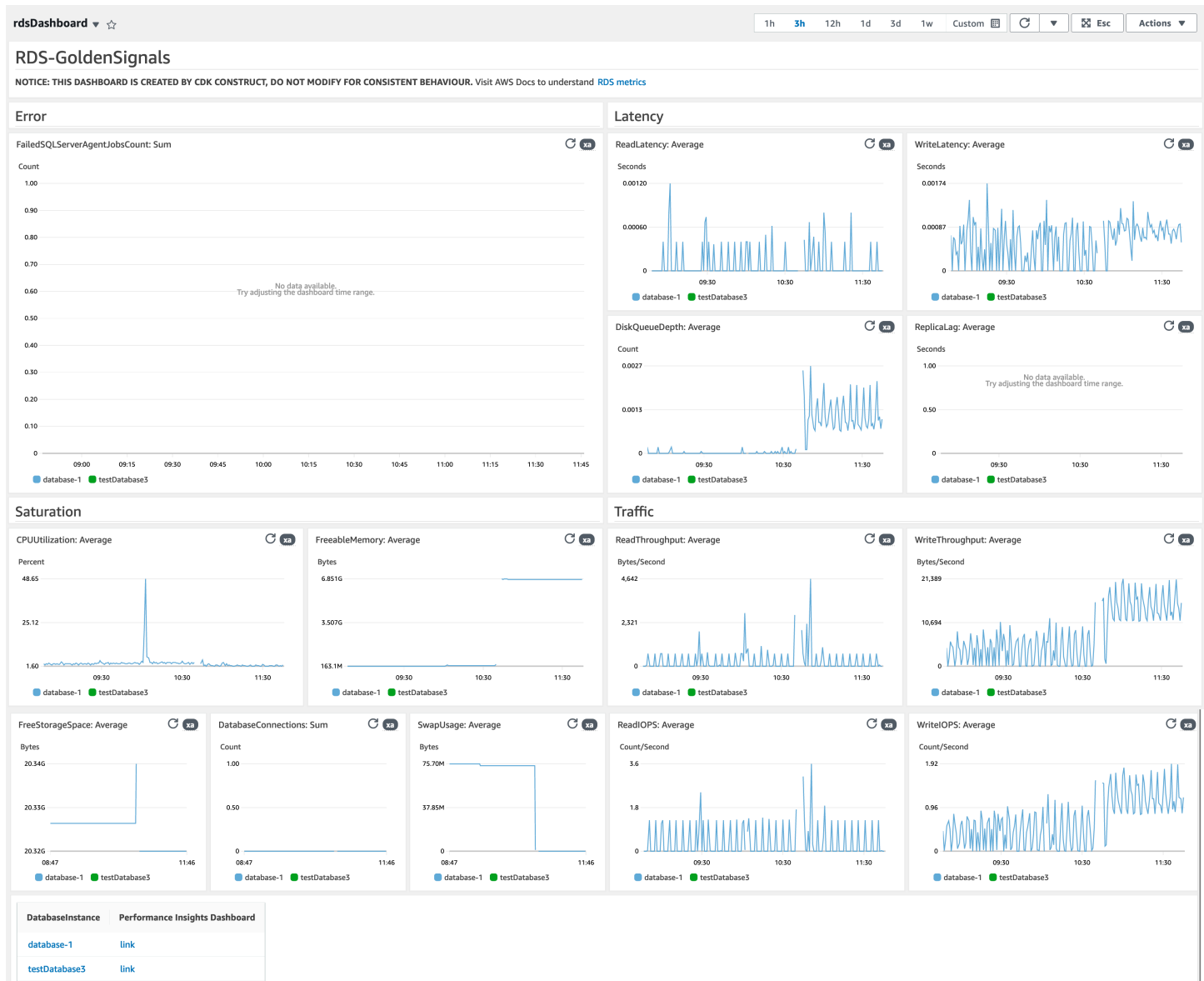

# Find AWS resources based on their creation date by using AWS Config advanced queries

Created by Inna Saman (AWS)

**Environment:** Production

**Technologies:** Operations;  
Security, identity, compliance

**AWS services:** AWS Config;  
Amazon EBS; Amazon EC2;  
Amazon S3; AWS Lambda

## Summary

This pattern shows how to find AWS resources based on their creation date by using the [AWS Config advanced query feature](#).

AWS Config advanced queries use a subset of SQL to query the configuration state of AWS resources for inventory management, operational intelligence, security, and compliance. You can use these queries to find AWS resources in a single AWS account and AWS Region or across multiple accounts and Regions. By running a query that uses the **resourceCreationTime** property, you can return a list of your AWS resources based on their specific creation date. You can run AWS Config advanced queries by using either of the following:

- The AWS Config **Query editor** in the AWS Config console
- The AWS Command Line Interface (AWS CLI)

The example query in the Additional information section of this pattern returns a list of AWS resources created within a specific 60-day time period. The query's output includes information on the following for each identified resource:

- Account ID
- Region
- Resource name
- Resource ID
- Resource type

- Tags
- Creation time

The example query also shows how the inventory list can be scoped to specific resource types with a "**WHERE ... IN**" statement. You can use a similar query to find other AWS resource types that also work with tags.

**Note:** To query resources across multiple AWS accounts and Regions or across an AWS Organizations organization, you must use an AWS Config aggregator. For more information, see [Multi-account multi-Region data aggregation](#) in the *AWS Config Developer Guide*. Global resources are recorded only in their home Region. For example, AWS Identity and Access Management (IAM) is a global resource and is recorded in **us-east-1 (N. Virginia Region)**.

## Prerequisites and limitations

### Prerequisites

- One or more active AWS accounts with AWS Config activated to record all supported resource types ([default configuration](#))
- (For multi-account, multi-Region queries) An activated AWS Config aggregator

### Limitations

- AWS Config advanced query results are paginated. When you choose **export**, up to 500 results are exported from the AWS Management Console. You can also use APIs to retrieve up to 100 paginated results at a time.
- AWS Config advanced queries use a subset of SQL that has its own syntax limitations. For more information, see [Limitations](#) in **Querying the current configuration state of AWS resources** in the *AWS Config Developer Guide*.

## Tools

### Tools

- [AWS Config](#) provides a detailed view of the resources in your AWS account and how they're configured. It helps you identify how resources are related to one another and how their configurations have changed over time.

- [AWS Command Line Interface \(AWS CLI\)](#) is an open-source tool that helps you interact with AWS services through commands in your command-line shell.

## Epics

### Run an AWS Config advanced query

Task	Description	Skills required
Verify that the resources you're querying are supported by AWS Config.	For a complete list of AWS resources that AWS Config supports, see <a href="#">Supported resource types</a> in the <i>AWS Config Developer Guide</i> .	Cloud administrator
Verify that the configuration recorder is created and running.	Follow the instructions in <a href="#">Managing the configuration recorder</a> in the <i>AWS Config Developer Guide</i> .  <b>Note:</b> AWS Config automatically creates and then starts the default configuration recorder.	Cloud administrator
Run the query.	Follow the instructions in <a href="#">Query using the SQL query editor (console)</a> or <a href="#">Query using the SQL query editor (AWS CLI)</a> in the <i>AWS Config Developer Guide</i> .  <b>Note:</b> If you receive errors when running AWS CLI commands, <a href="#">make sure that you're using the most recent version of the AWS CLI</a> .	Cloud administrator

Task	Description	Skills required
	<p><b>For single AWS account and Region queries</b></p> <p>On the <b>Query editor</b> page, in the <b>Query scope</b> section, make sure that you choose <b>This account and Region only</b>.</p> <p><b>For multi-account and multi-Region queries</b></p> <p>On the <b>Query editor</b> page, in the <b>Query scope</b> section, make sure that you create and select an AWS Config aggregator. For more information, see <a href="#">Multi-account multi-Region data aggregation</a> in the <i>AWS Config Developer Guide</i>.</p> <p>If queries across multiple accounts or Regions aren't working, follow the instructions in <a href="#">Troubleshooting for multi-account multi-Region data aggregation</a> in the <i>AWS Config Developer Guide</i>.</p> <p><b>Note:</b> To modify the scope of the query based on resource type, use the <b>WHERE resourceType IN (...)</b> construct. For an example query, see the <b>Example AWS</b></p>	

Task	Description	Skills required
	<b>Config advanced query</b> in the Additional information section.	

## Additional information

### Example AWS Config advanced query

The following example query returns a list of AWS resources created within a specific 60-day time period. For more AWS Config advanced query examples, see [Example Queries](#) in the *AWS Config Developer Guide*.

```
SELECT
  accountId,
  awsRegion,
  resourceName,
  resourceId,
  resourceType,
  resourceCreationTime,
  tags
WHERE
  resourceType IN (
    'AWS::CloudFormation::Stack',
    'AWS::EC2::VPC',
    'AWS::EC2::Volume',
    'AWS::EC2::Instance',
    'AWS::RDS::DBInstance',
    'AWS::ElasticLoadBalancingV2::LoadBalancer',
    'AWS::ServiceCatalog::CloudFormationProvisionedProduct',
    'AWS::EC2::NetworkInterface',
    'AWS::EC2::Subnet',
    'AWS::EC2::SecurityGroup',
    'AWS::AutoScaling::AutoScalingGroup',
    'AWS::Lambda::Function',
    'AWS::DynamoDB::Table',
    'AWS::S3::Bucket'
  )
AND resourceCreationTime BETWEEN '2022-05-23T00:00:00.000Z' AND
'2022-07-23T17:59:51.000Z'
```



```
ORDER BY
  accountId ASC,
  resourceType ASC
```

## Data privacy and protection

AWS Config is activated in each AWS Region separately. To comply with regulatory requirements, special considerations need to apply—such as creating separate Regional aggregators. For more information, see [Data protection in AWS Config](#) in the *AWS Config Developer Guide*.

## IAM permissions

The [AWS\\_ConfigRole](#) AWS managed policy is required as a minimum set of permissions to run AWS Config advanced queries. For more information, see [IAM role policy for getting configuration details](#) in the **Permissions for the IAM role assigned to AWS Config** section of the *AWS Config Developer Guide*.

# View EBS snapshot details for your AWS account or organization

Created by Arun Chandapillai (AWS) and Parag Nagwekar (AWS)

**Environment:** Production

**Technologies:** Operations;  
Storage & backup

**AWS services:** Amazon EBS

## Summary

This pattern describes how you can automatically generate an on-demand report of all Amazon Elastic Block Store (Amazon EBS) snapshots in your Amazon Web Services (AWS) account or organizational unit (OU) in AWS Organizations.

Amazon EBS is an easy-to-use, scalable, high-performance block-storage service designed for Amazon Elastic Compute Cloud (Amazon EC2). An EBS volume provides durable and persistent storage that you can attach to your EC2 instances. You can use EBS volumes as primary storage for your data and take a point-in-time backup of your EBS volumes by creating a snapshot. You can use the AWS Management Console or the AWS Command Line Interface (AWS CLI) to view the details of specific EBS snapshots. This pattern provides a programmatic way to retrieve information about all EBS snapshots in your AWS account or OU.

You can use the script provided by this pattern to generate a comma-separated values (CSV) file that has the following information about each snapshot: account ID, snapshot ID, volume ID and size, the date the snapshot was taken, instance ID, and description. If your EBS snapshots are tagged, the report also includes the owner and team attributes.

## Prerequisites and limitations

### Prerequisites

- An active AWS account
- AWS CLI version 2 [installed](#) and [configured](#)
- AWS Identity and Access Management (IAM) role with the appropriate permissions (access permissions for a specific account or for all accounts in an OU if you're planning to run the script from AWS Organizations)

## Architecture

The following diagram shows the script workflow that generates an on-demand report of EBS snapshots that are spread across multiple AWS accounts in an OU.

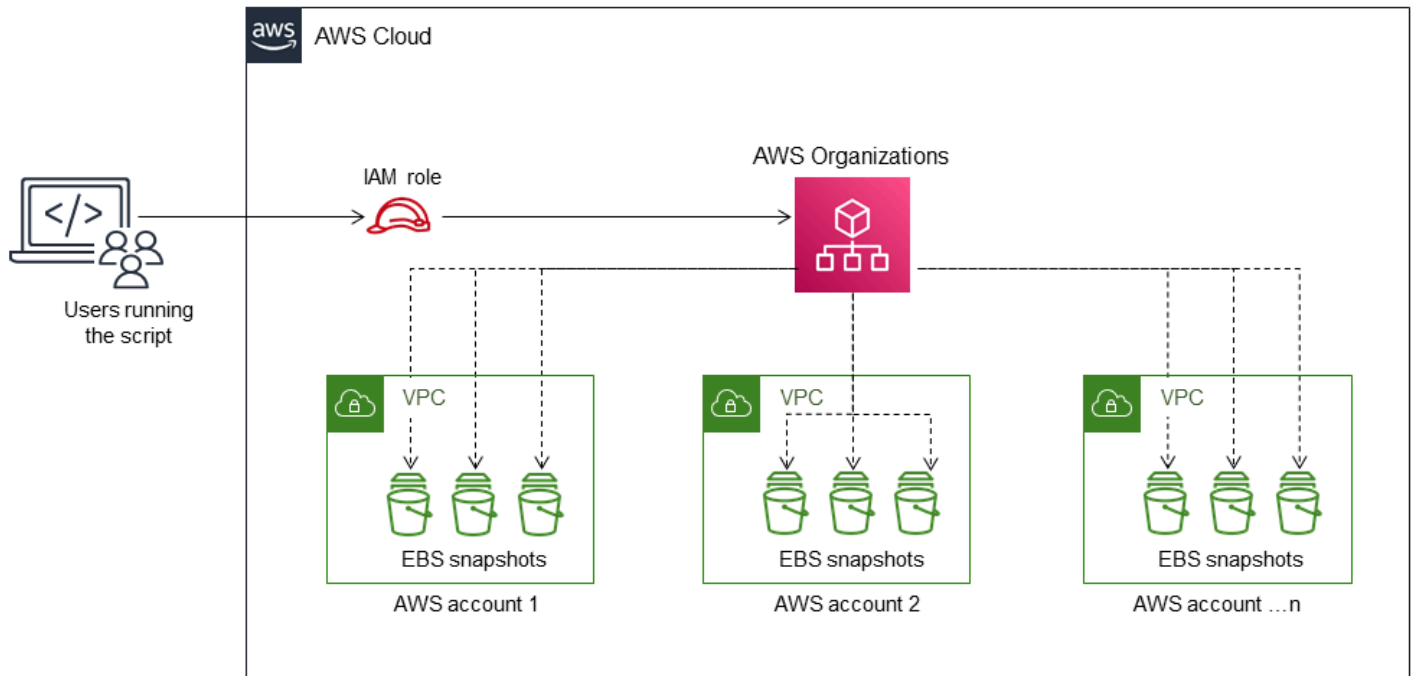

## Tools

### AWS services

- [AWS Command Line Interface \(AWS CLI\)](#) is an open-source tool that helps you interact with AWS services through commands in your command-line shell.
- [Amazon Elastic Block Store \(Amazon EBS\)](#) provides block-level storage volumes for use with EC2 instances.
- [AWS Identity and Access Management \(IAM\)](#) helps you securely manage access to your AWS resources by controlling who is authenticated and authorized to use them.
- [AWS Organizations](#) is an account management service that helps you consolidate multiple AWS accounts into an organization that you create and centrally manage.

## Code

The code for the sample application used in this pattern is available on GitHub, in the [aws-eks-snapshots-awsorganizations](#) repository. Follow the instructions in the next section to use the sample files.

## Epics

### Download the script

Task	Description	Skills required
Download the Python script.	Download the script <a href="#">GetSnapshotDetailsAllAccountsOU.py</a> from the <a href="#">GitHub repository</a> .	General AWS

### Get EBS snapshot details for an AWS account

Task	Description	Skills required
Run the Python script.	<p>Run the command:</p> <pre>python3 getsnapsh otinfo.py --file &lt;output-file&gt;.csv -- region &lt;region-name&gt;</pre> <p>where <code>&lt;output-file&gt;</code> refers to the CSV output file where you want information about the EBS snapshots placed, and <code>&lt;region-name&gt;</code> is the AWS Region where the snapshots are stored. For example:</p> <pre>python3 getsnapsh otinfo.py --file</pre>	General AWS

Task	Description	Skills required
	<pre>snapshots.csv --region us-east-1</pre>	

## Get EBS snapshot details for an organization

Task	Description	Skills required
Run the Python script.	<p>Run the command:</p> <pre>python3 getsnapsh otinfo.py --file &lt;output-file&gt;.csv --role &lt;IAM-role&gt; -- region &lt;region-name&gt;</pre> <p>where <code>&lt;output-file&gt;</code> refers to the CSV output file where you want information about the EBS snapshots placed, <code>&lt;IAM-role&gt;</code> is a role that provides permissions to access AWS Organizations, and <code>&lt;region-name&gt;</code> is the AWS Region where the snapshots are stored. For example:</p> <pre>python3 getsnapsh otinfo.py --file snapshots.csv --role &lt;IAM role&gt; --region us- west-2</pre>	General AWS

## Related resources

- [Amazon EBS documentation](#)
- [Amazon EBS actions](#)
- [Amazon EBS API reference](#)
- [Improving Amazon EBS performance](#)
- [Amazon EBS resources](#)
- [EBS snapshot pricing](#)

## Additional information

### EBS snapshot types

Amazon EBS provides three types of snapshots, based on ownership and access:

- **Owned by you** – By default, only you can create volumes from snapshots that you own.
- **Public snapshots** – You can share snapshots publicly with all other AWS accounts. To create a public snapshot, you modify the permissions for a snapshot to share it with the AWS accounts that you specify. Users that you will authorize can then use the snapshots you share by creating their own EBS volumes, while your original snapshot remains unaffected. You can also make your unencrypted snapshots available publicly to all AWS users. However, you can't make your encrypted snapshots available publicly for security reasons. Public snapshots pose a significant security risk because of the possibility of exposing personal and sensitive data. We strongly recommend against sharing your EBS snapshots with all AWS accounts. For more information about sharing snapshots, see the [AWS documentation](#).
- **Private snapshots** – You can share snapshots privately with individual AWS accounts that you specify. To share the snapshot privately with specific AWS accounts, follow the [instructions](#) in the AWS documentation, and choose **Private** for the permissions setting. Users that you have authorized can use the snapshots that you share to create their own EBS volumes, while your original snapshot remains unaffected.

### Overviews and procedures

The following table provides links to more information about EBS snapshots, including how you can lower EBS volume costs by finding and deleting unused snapshots, and archive rarely accessed snapshots that do not require frequent or fast retrieval.

**For information about****Snapshots, their features, and limitations****How to create a snapshot****See**[Create Amazon EBS snapshots](#)Console: [Create a snapshot](#)AWS CLI: [create-snapshot command](#)

For example:

```
aws ec2 create-snapshot --volume-id
vol-1234567890abcdef0 --description
" volume snapshot"
```

**Deleting snapshots (general information)****How to delete a snapshot**[Delete an Amazon EBS snapshot](#)Console: [Delete a snapshot](#)AWS CLI: [delete-snapshot command](#)

For example:

```
aws ec2 delete-snapshot --snapshot-id
snap-1234567890abcdef0
```

**Archiving snapshots (general information)****How to archive a snapshot**[Archive Amazon EBS snapshots](#)[Amazon EBS Snapshots Archive](#) (blog post)Console: [Archive a snapshot](#)AWS CLI: [modify-snapshot-tier command](#)**How to retrieve an archived snapshot**Console: [Restore an archived snapshot](#)AWS CLI: [restore-snapshot-tier command](#)**Snapshot pricing**[Amazon EBS pricing](#)**FAQ**

**What is the minimum archive period?**

The minimum archive period is 90 days.

**How long would it take to restore an archived snapshot?**

It can take up to 72 hours to restore an archived snapshot from the archive tier to the standard tier, depending on the size of the snapshot.

**Are archived snapshots full snapshots?**

Archived snapshots are always full snapshots.

**Which snapshots can a user archive?**

You can archive only snapshots that you own in your account.

**Can you archive a snapshot of the root device volume of a registered Amazon Machine Image (AMI)?**

No, you can't archive a snapshot of the root device volume of a registered AMI.

**What are security considerations for sharing a snapshot?**

When you share a snapshot, you are giving others access to all the data on the snapshot. Share snapshots only with people that you trust with your data.

**How do you share a snapshot with another AWS Region?**

Snapshots are constrained to the Region in which they were created. To share a snapshot with another Region, copy the snapshot to that Region and then share the copy.

**Can you share snapshots that are encrypted?**

You can't share snapshots that are encrypted with the default AWS managed key. You can share snapshots that are encrypted with a customer managed key only. When you share an encrypted snapshot, you must also share the customer managed key that was used to encrypt the snapshot.

**What about unencrypted snapshots?**

You can share unencrypted snapshots publicly.



## More patterns

- [Allow EC2 instances write access to S3 buckets in AMS accounts](#)
- [Automate AWS resource assessment](#)
- [Automatically re-enable AWS CloudTrail by using a custom remediation rule in AWS Config](#)
- [Build an MLOps workflow by using Amazon SageMaker and Azure DevOps](#)
- [Configure logging and monitoring for security events in your AWS IoT environment](#)
- [Connect to an Amazon EC2 instance by using Session Manager](#)
- [Create alarms for custom metrics using Amazon CloudWatch anomaly detection](#)
- [Enable Amazon GuardDuty conditionally by using AWS CloudFormation templates](#)
- [Improve operational performance by enabling Amazon DevOps Guru across multiple AWS Regions, accounts, and OUs with the AWS CDK](#)
- [Ingest and migrate EC2 Windows instances into an AWS Managed Services account](#)
- [Install the SSM Agent and CloudWatch agent on Amazon EKS worker nodes using preBootstrapCommands](#)
- [Integrate Stonebranch Universal Controller with AWS Mainframe Modernization](#)
- [Launch a CodeBuild project across AWS accounts using Step Functions and a Lambda proxy function](#)
- [Monitor and remediate scheduled deletion of AWS KMS keys](#)
- [Monitor use of a shared Amazon Machine Image across multiple AWS accounts](#)
- [Run AWS Systems Manager Automation tasks synchronously from AWS Step Functions](#)
- [Run event-driven and scheduled workloads at scale with AWS Fargate](#)
- [Set up disaster recovery for SAP on IBM Db2 on AWS](#)
- [Tag Transit Gateway attachments automatically using AWS Organizations](#)
- [View AWS Network Firewall logs and metrics by using Splunk](#)

# Security, identity, compliance

## Topics

- [Access AWS services from an ASP.NET Core app using Amazon Cognito identity pools](#)
- [Authenticate Microsoft SQL Server on Amazon EC2 using AWS Directory Service](#)
- [Automate incident response and forensics](#)
- [Automate remediation for AWS Security Hub standard findings](#)
- [Automate security scans for cross-account workloads using Amazon Inspector and AWS Security Hub](#)
- [Automatically re-enable AWS CloudTrail by using a custom remediation rule in AWS Config](#)
- [Automatically remediate unencrypted Amazon RDS DB instances and clusters](#)
- [Automatically rotate IAM user access keys at scale with AWS Organizations and AWS Secrets Manager](#)
- [Automatically validate and deploy IAM policies and roles in an AWS account by using CodePipeline, IAM Access Analyzer, and AWS CloudFormation macros](#)
- [Bidirectionally integrate AWS Security Hub with Jira software](#)
- [Build a pipeline for hardened container images using EC2 Image Builder and Terraform](#)
- [Centralize IAM access key management in AWS Organizations by using Terraform](#)
- [Centralized logging and multiple-account security guardrails](#)
- [Check an Amazon CloudFront distribution for access logging, HTTPS, and TLS version](#)
- [Check for single-host network entries in security group ingress rules for IPv4 and IPv6](#)
- [Choose an Amazon Cognito authentication flow for enterprise applications](#)
- [Create AWS Config custom rules by using AWS CloudFormation Guard policies](#)
- [Create a consolidated report of Prowler security findings from multiple AWS accounts](#)
- [Delete unused Amazon Elastic Block Store \(Amazon EBS\) volumes by using AWS Config and AWS Systems Manager](#)
- [Deploy and manage AWS Control Tower controls by using AWS CDK and AWS CloudFormation](#)
- [Deploy and manage AWS Control Tower controls by using Terraform](#)
- [Deploy a pipeline that simultaneously detects security issues in multiple code deliverables](#)
- [Deploy detective attribute-based access controls for public subnets by using AWS Config](#)
- [Deploy preventative attribute-based access controls for public subnets](#)

- [Deploy the Security Automations for AWS WAF solution by using Terraform](#)
- [Detect Amazon RDS and Aurora database instances that have expiring CA certificates](#)
- [Dynamically generate an IAM policy with IAM Access Analyzer by using Step Functions](#)
- [Enable Amazon GuardDuty conditionally by using AWS CloudFormation templates](#)
- [Enable transparent data encryption in Amazon RDS for SQL Server](#)
- [Ensure AWS load balancers use secure listener protocols \(HTTPS, SSL/TLS\)](#)
- [Ensure encryption for Amazon EMR data at rest is enabled at launch](#)
- [Ensure that an IAM profile is associated with an EC2 instance](#)
- [Ensure an Amazon Redshift cluster is encrypted upon creation](#)
- [Export a report of AWS IAM Identity Center identities and their assignments by using PowerShell](#)
- [Monitor and remediate scheduled deletion of AWS KMS keys](#)
- [Identify public S3 buckets in AWS Organizations using Security Hub](#)
- [Ingest and analyze AWS security logs in Microsoft Sentinel](#)
- [Manage AWS IAM Identity Center permission sets as code by using AWS CodePipeline](#)
- [Manage credentials using AWS Secrets Manager](#)
- [Monitor ElastiCache clusters for security groups](#)
- [Monitor Amazon EMR clusters for in-transit encryption at launch](#)
- [Monitor Amazon ElastiCache clusters for at-rest encryption](#)
- [Monitor EC2 instance key pairs using AWS Config](#)
- [Monitor IAM root user activity](#)
- [Send a notification when an IAM user is created](#)
- [Prevent internet access at the account level by using a service control policy](#)
- [Scan Git repositories for sensitive information and security issues by using git-secrets](#)
- [Send alerts from AWS Network Firewall to a Slack channel](#)
- [Simplify private certificate management by using AWS Private CA and AWS RAM](#)
- [Turn off security standard controls across all Security Hub member accounts in a multi-account environment](#)
- [Update AWS CLI credentials from AWS IAM Identity Center by using PowerShell](#)
- [Use AWS Config to monitor Amazon Redshift security configurations](#)
- [Use Network Firewall to capture the DNS domain names from the Server Name Indication \(SNI\) for outbound traffic](#)

- [Use Terraform to automatically enable Amazon GuardDuty for an organization](#)
- [Verify that new Amazon Redshift clusters have required SSL endpoints](#)
- [Verify that new Amazon Redshift clusters launch in a VPC](#)
- [More patterns](#)

# Access AWS services from an ASP.NET Core app using Amazon Cognito identity pools

Created by Bibhuti Sahu (AWS) and Marcelo Barbosa (AWS)

**Environment:** PoC or pilot

**Technologies:** Security, identity, compliance; Web & mobile apps

**AWS services:** Amazon Cognito

## Summary

This pattern discusses how you can configure Amazon Cognito user pools and identity pools, and then enable an ASP.NET Core app to access AWS resources after successful authentication.

Amazon Cognito provides authentication, authorization, and user management for your web and mobile apps. The two main components of Amazon Cognito are user pools and identity pools.

A user pool is a user directory in Amazon Cognito. With a user pool, your users can sign in to your web or mobile app through Amazon Cognito. Your users can also sign in through social identity providers such as Google, Facebook, Amazon, or Apple, and through SAML identity providers.

Amazon Cognito identity pools (federated identities) enable you to create unique identities for your users and federate them with identity providers. With an identity pool, you can obtain temporary, limited-privilege AWS credentials to access other AWS services. Before you can begin using your new Amazon Cognito identity pool, you must assign one or more AWS Identity and Access Management (IAM) roles to determine the level of access you want your application users to have to your AWS resources. Identity pools define two types of identities: authenticated and unauthenticated. Each identity type can be assigned its own role in IAM. Authenticated identities belong to users who are authenticated by a public login provider (Amazon Cognito user pools, Facebook, Google, SAML, or any OpenID Connect providers) or a developer provider (your own backend authentication process), whereas unauthenticated identities typically belong to guest users. When Amazon Cognito receives a user request, the service determines whether the request is authenticated or unauthenticated, determines which role is associated with that authentication type, and then uses the policy attached to that role to respond to the request.

# Prerequisites and limitations

## Prerequisites

- An AWS account with Amazon Cognito and IAM permissions
- Access to the AWS resources you want to use
- ASP.NET Core 2.0.0 or later

## Architecture

### Technology stack

- Amazon Cognito
- ASP.NET Core

### Target architecture

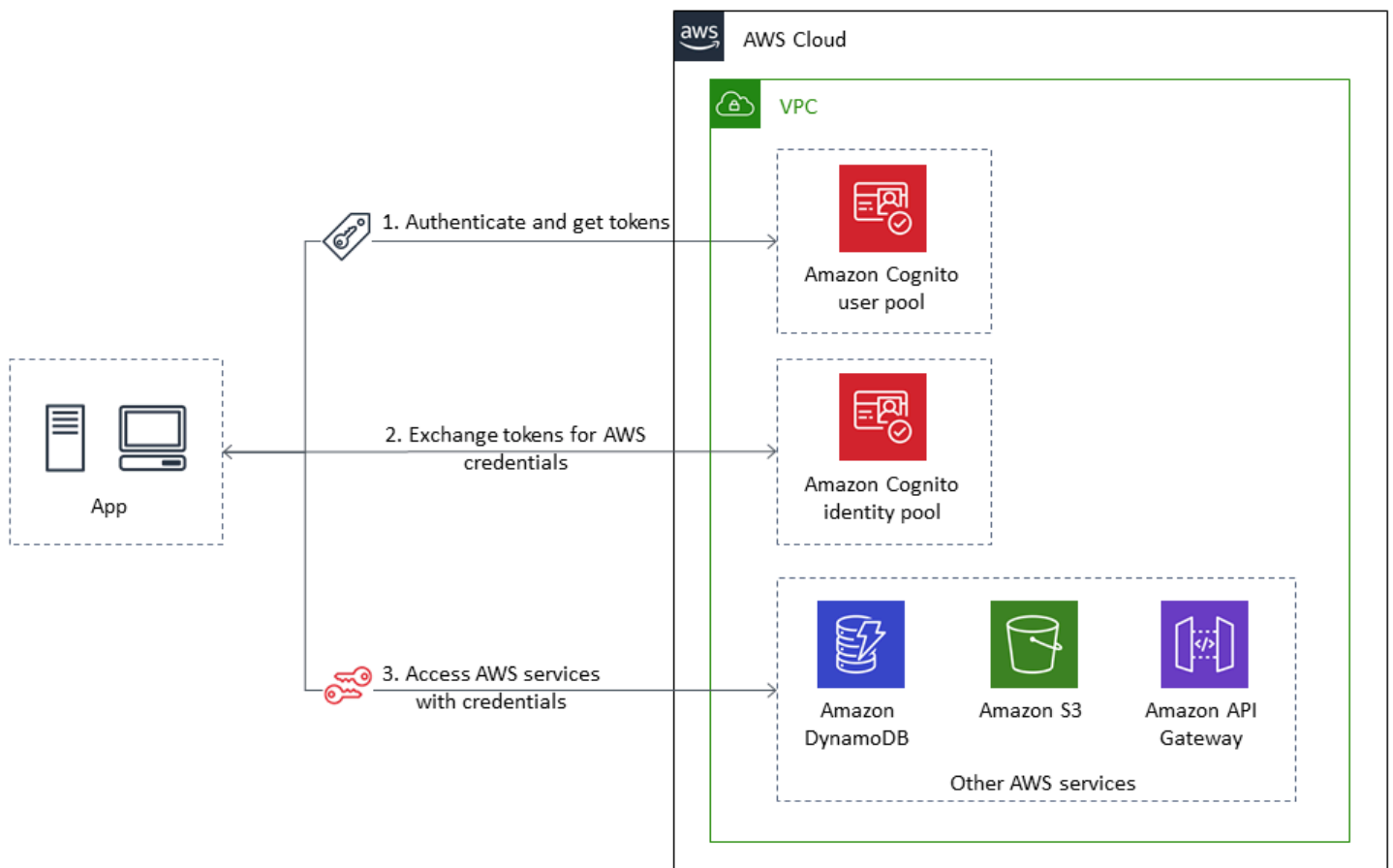

# Tools

## Tools, SDKs, and AWS services

- Visual Studio or Visual Studio Code
- [Amazon.AspNetCore.Identity.Cognito \(1.0.4\)](#) – NuGet package
- [AWSSDK.S3 \(3.3.110.32\)](#) – NuGet package
- [Amazon Cognito](#)

## Code

The attached .zip file includes sample files that illustrate the following:

- How to retrieve an access token for the logged in user
- How to exchange an access token for AWS credentials
- How to access the Amazon Simple Storage Service (Amazon S3) service with AWS credentials

## *IAM* role for authenticated identities

```
{
  "Version": "2012-10-17",
  "Statement": [
    {
      "Effect": "Allow",
      "Action": [
        "mobileanalytics:PutEvents",
        "cognito-sync:*",
        "cognito-identity:*",
        "s3:ListAllMyBuckets*"
      ],
      "Resource": [
        "*"
      ]
    }
  ]
}
```

# Epics

## Create an Amazon Cognito user pool

Task	Description	Skills required
Create a user pool.	<ol style="list-style-type: none"><li>1. Sign in to the AWS Management Console and open the <a href="#">Amazon Cognito console</a>.</li><li>2. Choose <b>Manage User Pools</b>.</li><li>3. In the top-right corner of the page, choose <b>Create a user pool</b>.</li><li>4. Provide a name for your user pool, choose <b>Review defaults</b>, and then choose <b>Create pool</b>.</li><li>5. Note the pool ID.</li></ol>	Developer
Add an app client.	<p>You can create an app to use the built-in webpages for signing up and signing in your users.</p> <ol style="list-style-type: none"><li>1. On the navigation bar on the left side of the user pool page, choose <b>App clients</b> under <b>General settings</b>, and then choose <b>Add an app client</b>.</li><li>2. Give your app a name, and then choose <b>Create app client</b>.</li></ol>	Developer



Task	Description	Skills required
	3. Note the app client ID and the client secret (choose <b>Show Details</b> to see the client secret).	

## Create an Amazon Cognito identity pool

Task	Description	Skills required
Create an identity pool.	<ol style="list-style-type: none"> <li>1. On the Amazon Cognito console, choose <b>Manage Identity Pools</b>, and then choose <b>Create new identity pool</b>.</li> <li>2. Type a name for the identity pool.</li> <li>3. If you want to enable unauthenticated identities, select that option from the <b>Unauthenticated identities</b> section.</li> <li>4. In the <b>Authentication providers</b> section, configure the Amazon Cognito identity pool by setting the user pool ID and the app client ID, and then choose <b>Create Pool</b>.</li> </ol>	Developer
Assign IAM roles for the identity pool.	You can edit the IAM roles for authenticated and unauthenticated users, or keep the defaults, and then choose <b>Allow</b> . For this pattern, we	Developer

Task	Description	Skills required
	will edit the authenticated IAM role and provide access for <code>s3:ListAllMyBuckets</code> . For sample code, see the IAM role provided earlier in the <a href="#">Tools</a> section.	
Copy the identity pool ID.	When you choose <b>Allow</b> in the previous step, the <b>Getting started with Amazon Cognito</b> page is displayed. On this page, you can either copy the identity pool ID from the <b>Get AWS Credentials</b> section or choose <b>Edit identity pool</b> in the upper right and copy the identity pool ID from the screen that's displayed.	Developer

## Configure your sample app

Task	Description	Skills required
Clone the sample ASP.NET Core web app.	<ol style="list-style-type: none"> <li>1. Clone the sample .NET core web app from <a href="https://github.com/aws/aws-aspnet-cognito-identity-provider.git">https://github.com/aws/aws-aspnet-cognito-identity-provider.git</a>.</li> <li>2. Navigate to the <code>samples</code> folder and open the solution. In this project, you'll configure the <code>appsettings.json</code> file and add a new page that</li> </ol>	Developer

Task	Description	Skills required
	will render all S3 buckets after successful sign in.	
Add dependencies.	Add a NuGet dependency for <code>Amazon.AspNetCore.Identity.Cognito</code> to your ASP.NET Core application.	Developer
Add the configuration keys and values to <code>appsettings.json</code> .	Include the code from the attached <code>appsettings.json</code> file in your <code>appsettings.json</code> file, and then replace the placeholders with the values from the previous steps.	Developer
Create a new user and sign in.	Create a new user in the Amazon Cognito user pool, and verify that the user exists under <b>Users and Groups</b> in the user pool.	Developer
Create a new Razor Page called <code>MyS3Buckets</code> .	Add a new ASP.NET Core Razor Page to your sample app, and replace the content for <code>MyS3Bucket.cshtml</code> and <code>MyS3Bucket.cshtml.cs</code> from the attached sample. Add the new <b>MyS3Bucket</b> page under navigation in the <code>_Layout.cshtml</code> page.	Developer

## Troubleshooting

Issue	Solution
<p>After you open the sample application from the GitHub repository, you get an error when you try to add the NuGet package to the Samples project.</p>	<p>In the <code>src</code> folder, make sure to remove from the reference to the <code>Amazon.AspNetCore.Identity.Cognito</code> project from the <code>Samples.sln</code> file. You can then add the NuGet package to the Samples project without any issues.</p>

## Related resources

- [Amazon Cognito](#)
- [Amazon Cognito user pools](#)
- [Amazon Cognito identity pools](#)
- [Access policy samples](#)
- [GitHub - AWS ASP.NET Cognito Identity Provider](#)

## Attachments

To access additional content that is associated with this document, unzip the following file: [attachment.zip](#)

# Authenticate Microsoft SQL Server on Amazon EC2 using AWS Directory Service

Created by Jagadish Kantubugata (AWS) and Oludahun Bade Ajidahun (AWS)

<b>Environment:</b> PoC or pilot	<b>Source:</b> Active Directory	<b>Target:</b> AWS Directory Service
<b>R Type:</b> N/A	<b>Workload:</b> Microsoft	<b>Technologies:</b> Security, identity, compliance; Databases

**AWS services:** AWS Directory Service

## Summary

This pattern describes how to create an AWS Directory Service directory and use it to authenticate Microsoft SQL Server on an Amazon Elastic Compute Cloud (Amazon EC2) instance.

AWS Directory Service provides multiple ways to use Amazon Cloud Directory and Microsoft Active Directory (AD) with other AWS services. Directories store information about users, groups, and devices, and administrators use them to manage access to information and resources. AWS Directory Service provides multiple directory choices for users who want to use their existing Microsoft AD or Lightweight Directory Access Protocol (LDAP)-aware applications in the cloud. It also offers those same choices to developers who need a directory to manage users, groups, devices, and access.

## Prerequisites and limitations

### Prerequisites

- An active AWS account
- A virtual private cloud (VPC) with a minimum of two private subnets and two public subnets
- An AWS Identity and Access Management (IAM) role to join the server into the domain

# Architecture

## Source technology stack

- The source can be an on-premises Active Directory

## Target technology stack

- AWS Directory Service for Microsoft Active Directory (AWS Managed Microsoft AD)

## Target architecture

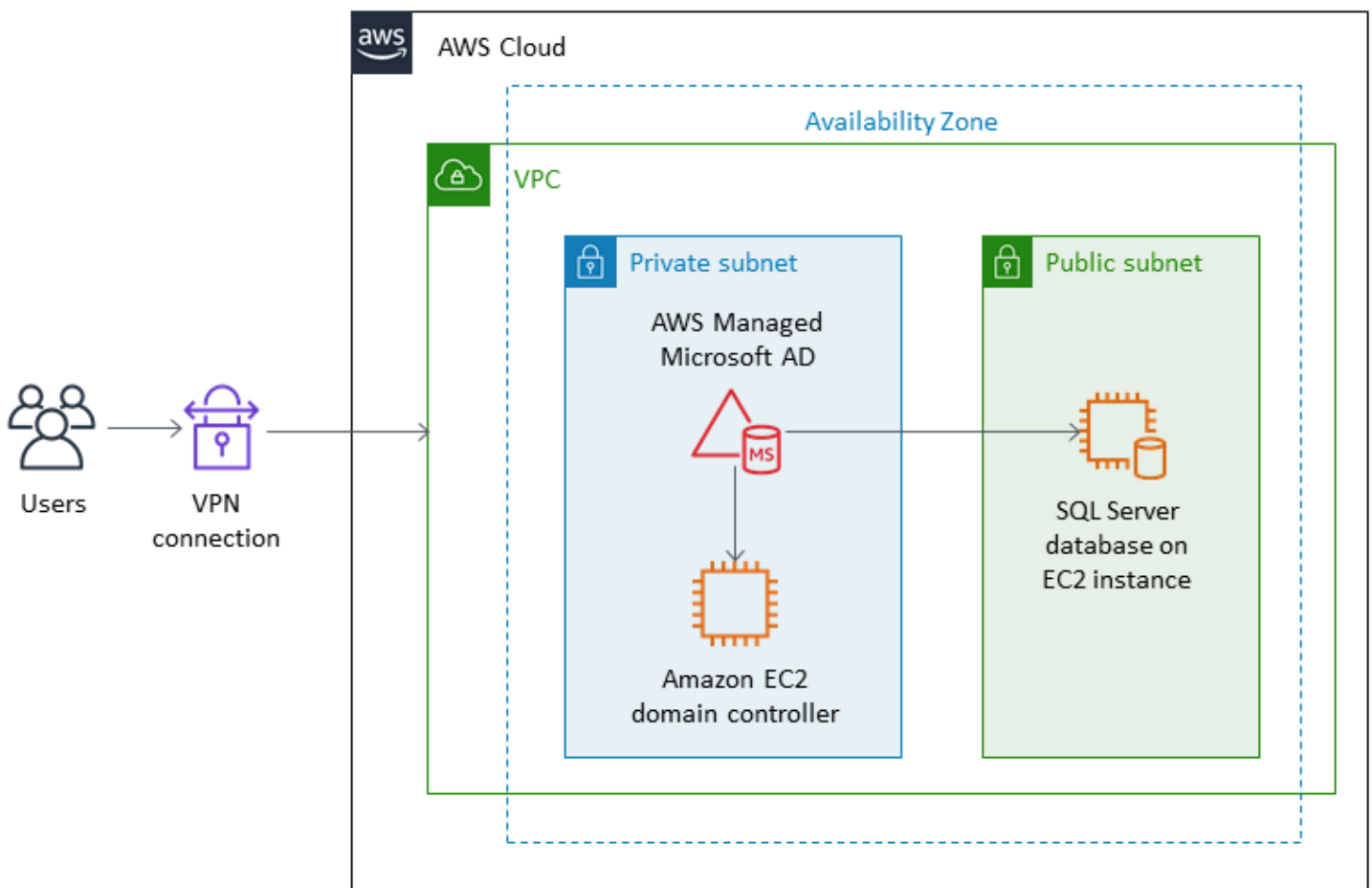

## Tools

- SQL Server Management Studio (SSMS) is a tool for managing Microsoft SQL Server, including accessing, configuring, and administering SQL Server components.

# Epics

## Set up a directory

Task	Description	Skills required
Select AWS Managed Microsoft AD as the directory type.	On the <a href="#">AWS Directory Service console</a> , choose <b>Directories, Set up directory, AWS Managed Microsoft AD, Next</b> .	DevOps
Select edition.	From the available editions for AWS Managed Microsoft AD, choose <b>Standard Edition</b> .	DevOps
Specify the directory DNS name.	Use a fully qualified domain name. This name will resolve inside your VPC only. It does not need to be publicly resolvable.	DevOps
Set the administrator password.	Set the password for the default administrative user, which is named <b>Admin</b> .	DevOps
Choose the VPC and subnets.	Choose the VPC that will contain your directory and the subnets for the domain controllers. If you do not have a VPC with at least two subnets, you must create one.	DevOps
Review and launch the directory.	Review the edition and price information for the directory , and then choose <b>Create directory</b> .	DevOps

## Launch an EC2 instance for SQL Server in the domain

Task	Description	Skills required
Select an AMI for SQL Server.	<p>The steps in this epic seamlessly join a Windows EC2 instance to your AWS Managed Microsoft AD directory.</p> <p>On the <a href="#">Amazon EC2 console</a>, choose <b>Launch instance</b>, and then select the appropriate Amazon Machine Image (AMI) for SQL Server.</p>	DevOps, DBA
Configure instance details.	Configure the Windows instance to meet your requirements for SQL Server.	DevOps, DBA
Select the key pair name.	Select a key pair, and then launch the instance.	DevOps, DBA
Add a network.	You can choose the VPC that your directory was created in.	DevOps, DBA
Select an IAM role.	In <b>Advanced settings</b> , select an IAM profile that has the AWS managed policies AmazonSSMManagedInstanceCore and AmazonSSMDirectoryServiceAccess attached to it.	DevOps, DBA
Add a subnet.	Choose one of the public subnets in your VPC. The subnet that you choose must	DevOps, DBA



Task	Description	Skills required
	have all external traffic routed to an internet gateway. If this is not the case, you won't be able to connect to the instance remotely.	
Choose your domain.	Choose the domain that you created from the <b>Domain join</b> directory list.	DevOps, DBA
Launch the instance.	Choose <b>Launch instance</b> .	DBA

### Authenticate SQL Server using Directory Service

Task	Description	Skills required
Log in as a Windows administrator.	Log in to the Windows EC2 instance by using Windows administrator credentials.	DBA
Log in to SQL Server.	Launch SQL Server Management Studio (SSMS) and log in to SQL Server by using the Windows authentication method.	DBA
Create a login for the directory user.	In SSMS, choose <b>Security</b> , and then choose <b>New Login</b> .	DBA
Search for a login name.	Choose the search button next to the login text box.	DBA
Select a location.	In the <b>Select User or Group</b> dialog box, choose <b>Locations</b> .	DBA

Task	Description	Skills required
Enter network credentials.	Enter the fully qualified network credentials you used when you created the directory service; for example: <code>test.com\admin</code> .	DBA
Select the directory.	Choose the AWS directory name, and then choose <b>OK</b> .	DBA
Select an object name.	Select the user for which you want to create the login. Select the location, choose the entire directory, search for the user, and add the login.	DBA
Log in to the SQL Server instance.	Log in to the Windows EC2 instance for SQL Server by using your domain credentials.	DBA
Log in to SQL Server as a domain user.	Launch SSMS and connect to the database engine by using the Windows authentication method.	DBA

## Related resources

- [AWS Directory Service documentation](#) (AWS website)
- [Create your AWS Managed Microsoft AD directory](#) (AWS Directory Service documentation)
- [Seamlessly join a Windows EC2 instance](#) (AWS Directory Service documentation)
- [Microsoft SQL Server on AWS](#) (AWS website)
- [SSMS documentation](#) (Microsoft website)
- [Create a login in SQL Server](#) (SQL Server documentation)



# Automate incident response and forensics

Created by Lucas Kauffman (AWS) and Tomek Jakubowski (AWS)

**Code repository:** [aws-automated-incident-response-and-forensics](#)

**Environment:** Production

**Technologies:** Security, identity, compliance

**AWS services:** Amazon EC2; AWS Lambda; Amazon S3; AWS Security Hub; AWS Identity and Access Management

## Summary

This pattern deploys a set of processes that use AWS Lambda functions to provide the following:

- A way to initiate the incident-response process with minimum knowledge
- Automated, repeatable processes that are aligned with the AWS Security Incident Response Guide
- Separation of accounts to operate the automation steps, store artifacts, and create forensic environments

The Automated Incident Response and Forensics framework follows a standard digital forensic process consisting of the following phases:

1. Containment
2. Acquisition
3. Examination
4. Analysis

You can perform investigations on static data (for example, acquired memory or disk images) and on dynamic data that is live but on separated systems.

For more details, see the [Additional information](#) section.

## Prerequisites and limitations

### Prerequisites

- Two AWS accounts:
  - Security account, which can be an existing account, but is preferably new
  - Forensics account, preferably new
- AWS Organizations set up
- In the Organizations member accounts:
  - The Amazon Elastic Compute Cloud (Amazon EC2) role must have Get and List access to Amazon Simple Storage Service (Amazon S3) and be accessible by AWS Systems Manager. We recommend using the AmazonSSMManagedInstanceCore AWS managed role. Note that this role will automatically be attached to the EC2 instance when incident response is initiated. After the response has finished, AWS Identity and Access Management (IAM) will remove all rights to the instance.
  - Virtual private cloud (VPC) endpoints in the AWS member account and in the Incident Response and Analysis VPCs. Those endpoints are: S3 Gateway, EC2 Messages, SSM, and SSM Messages.
- AWS Command Line Interface (AWS CLI) installed on the EC2 instances. If the EC2 instances don't have AWS CLI installed, internet access will be required for the disk snapshot and memory acquisition to work. In this case, the scripts will reach out to the internet to download the AWS CLI installation files and will install them on the instances.

### Limitations

- This framework does not intend to generate artifacts that can be considered as electronic evidence, submissible in court.
- Currently, this pattern supports only Linux based instances running on x86 architecture.

## Architecture

### Target technology stack

- AWS CloudFormation

- AWS CloudTrail
- AWS Config
- IAM
- Lambda
- Amazon S3
- AWS Key Management System (AWS KMS)
- AWS Security Hub
- Amazon Simple Notification Service (Amazon SNS)
- AWS Step Functions

### Target architecture

In addition to the member account, the target environment consists of two main accounts: a Security account and a Forensics account. Two accounts are used for the following reasons:

- To separate them from any other customer accounts to reduce blast radius in case of a failed forensic analysis
- To help ensure the isolation and protection of the integrity of the artifacts being analyzed
- To keep the investigation confidential
- To avoid situations where the threat actors might have used all the resources immediately available to your compromised AWS account by hitting service quotas and so preventing you from instantiating an Amazon EC2 instance to perform investigations.

Also, having separate Security and Forensics accounts allows for creating separate roles—a Responder for acquiring evidence and an Investigator for analyzing it. Each role would have access to its separate account.

The following diagram shows only the interaction between the accounts. Details of each account are shown in subsequent diagrams, and a complete diagram is attached.

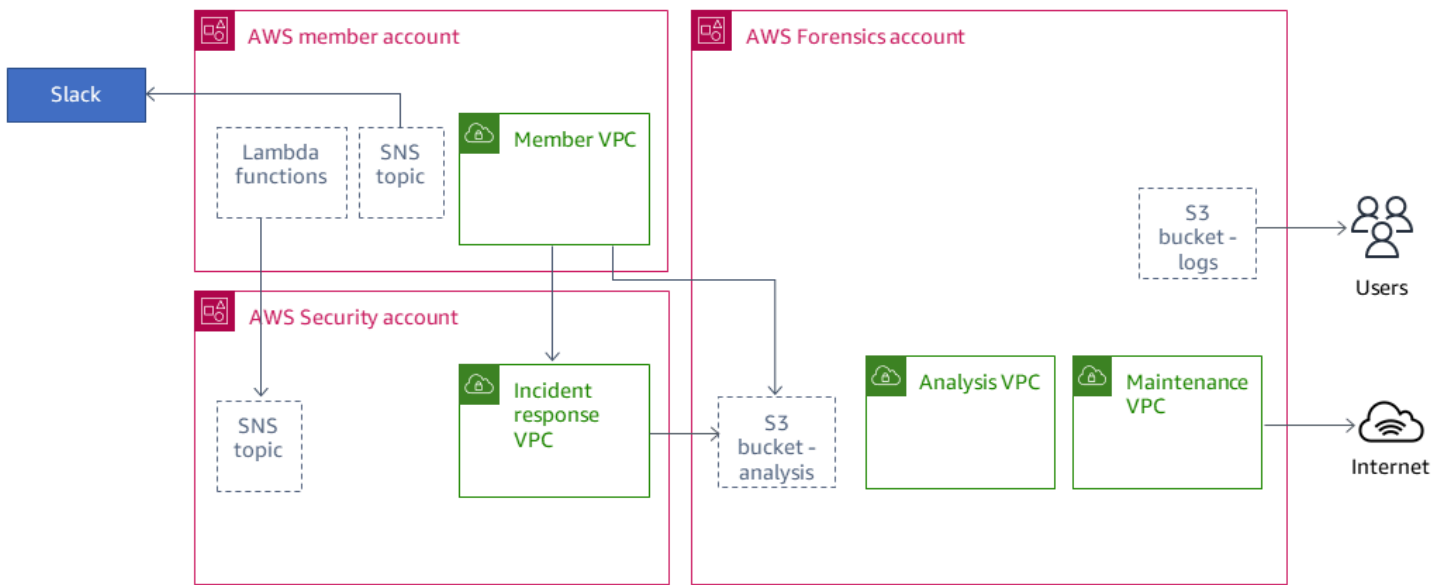

The following diagram shows the member account.

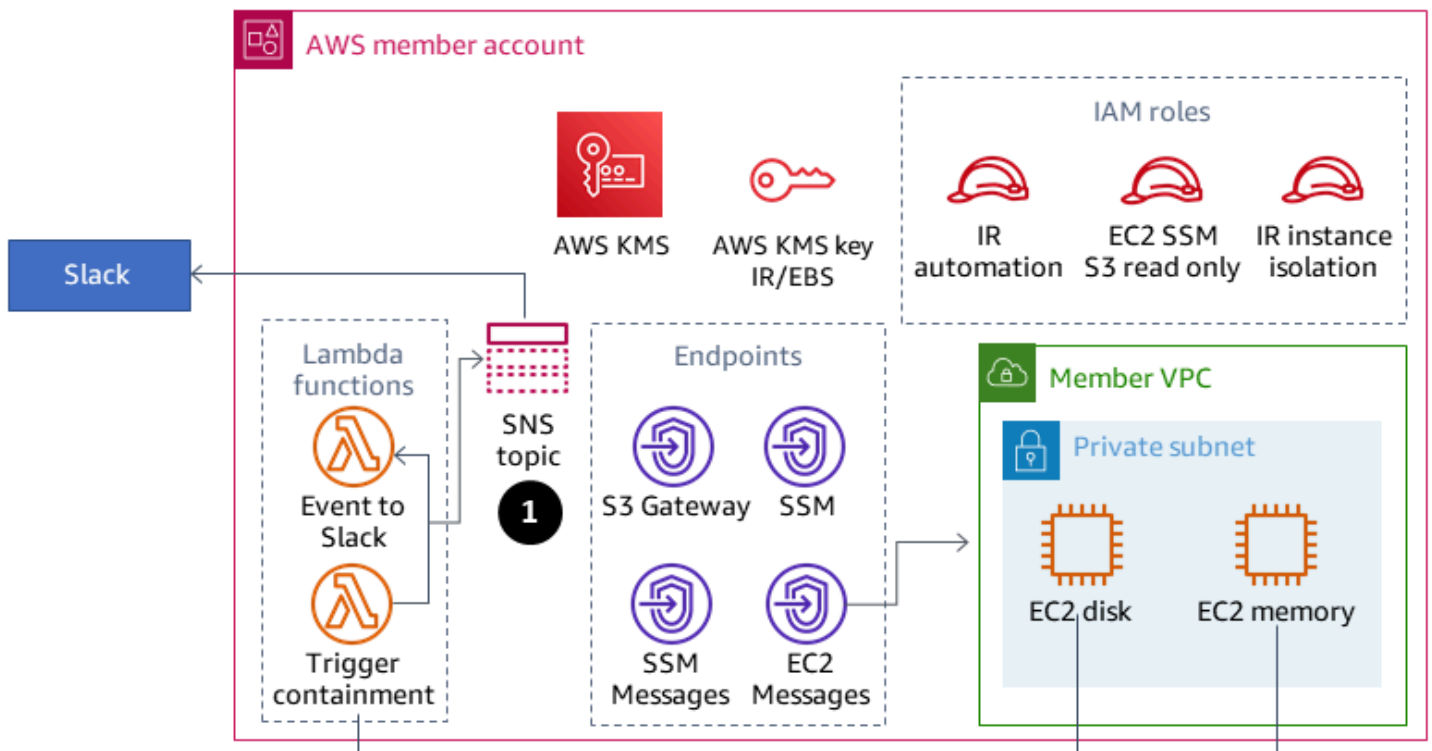

1. An event is sent to the Slack Amazon SNS topic.

The following diagram shows the Security account.

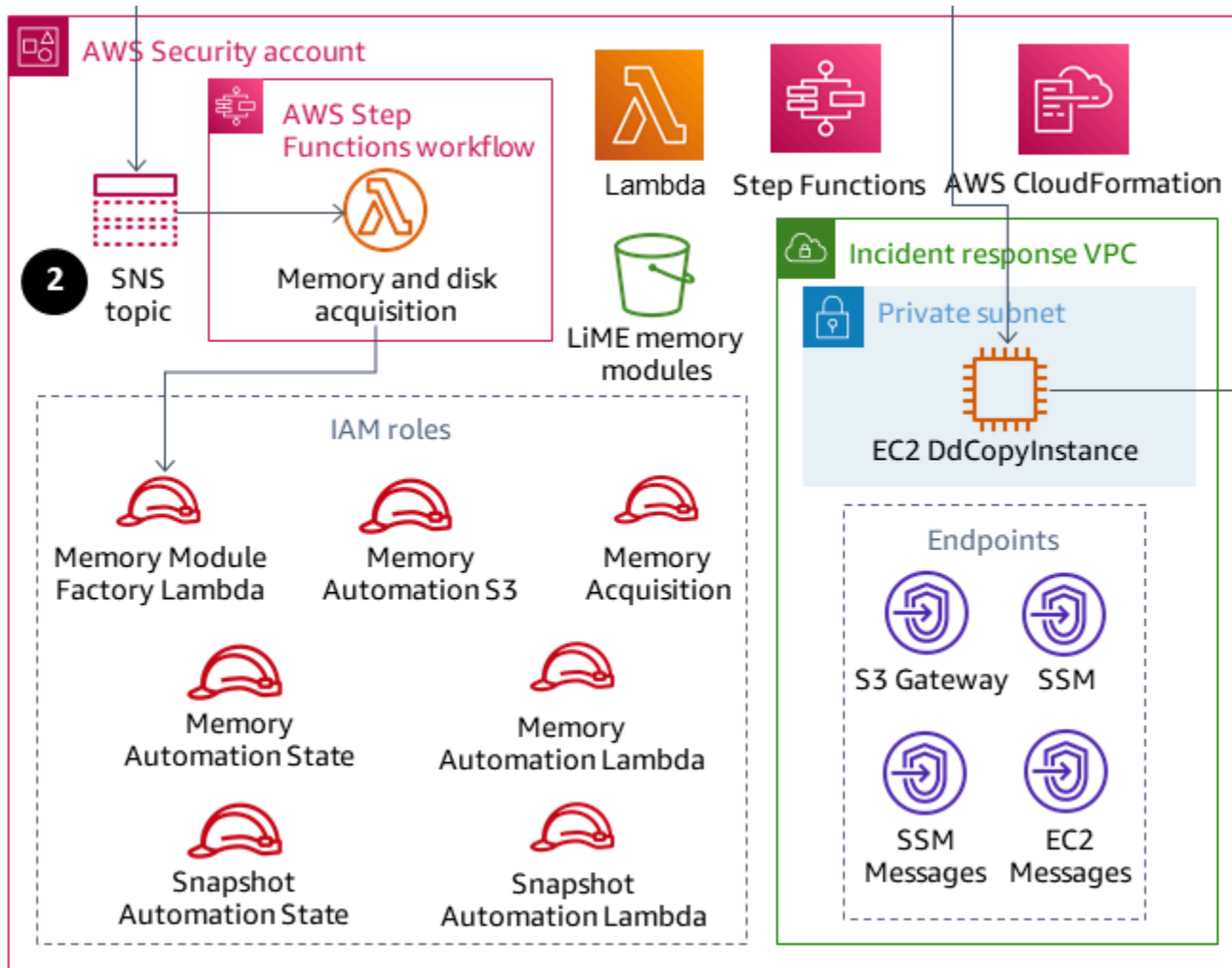

2. The SNS topic in the Security account initiates Forensics events.

The following diagram shows the Forensics account.



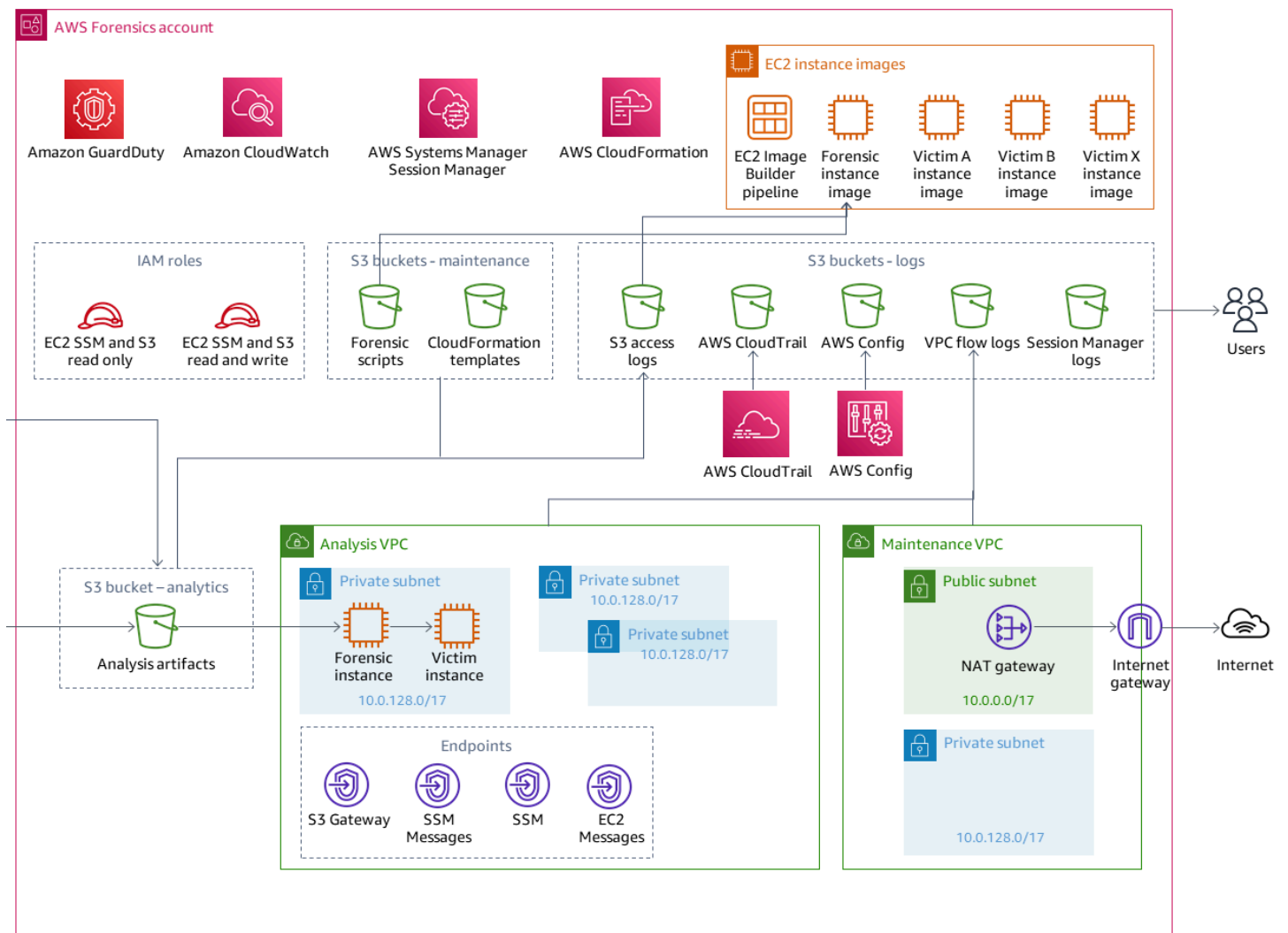

The Security account is where the two main AWS Step Functions workflows are created for memory and disk image acquisition. After the workflows are running, they access the member account that has the EC2 instances involved in an incident, and they initiate a set of Lambda functions that will gather a memory dump or a disk dump. Those artifacts are then stored in the Forensics account.

The Forensics account will hold the artifacts gathered by the Step Functions workflow in the Analysis artifacts S3 bucket. The Forensics account will also have an EC2 Image Builder pipeline that builds an Amazon Machine Image (AMI) of a Forensics instance. Currently, the image is based on SANS SIFT Workstation.

The build process uses the Maintenance VPC, which has connectivity to the internet. The image can be later used for spinning up the EC2 instance for analysis of the gathered artifacts in the Analysis VPC.

The Analysis VPC does not have internet connectivity. By default, the pattern creates three private analysis subnets. You can create up to 200 subnets, which is the quota for the number of subnets in a VPC, but the VPC endpoints need to have those subnets added for AWS Systems Manager Sessions Manager to automate running commands in them.

From a best-practices perspective, we recommend using AWS CloudTrail and AWS Config to do the following:

- Track changes made in your Forensics account
- Monitor access and integrity of the artifacts that are stored and analyzed

## Workflow

The following diagram shows the key steps of a workflow that includes the process and decision tree from when an instance is compromised until it is analyzed and contained.

1. Has the `SecurityIncidentStatustag` been set with the value `Analyze`? If yes, do the following:
  - a. Attach the correct IAM profiles for AWS Systems Manager and Amazon S3.
  - b. Send an Amazon SNS message to the Amazon SNS queue in Slack.
  - c. Send an Amazon SNS message to the `SecurityIncident` queue.
  - d. Invoke the Memory and Disk Acquisition state machine.
2. Have memory and disk been acquired? If no, there is an error.
3. Tag the EC2 instance with the `Contain` tag.
4. Attach the IAM role and security group to fully isolate the instance.

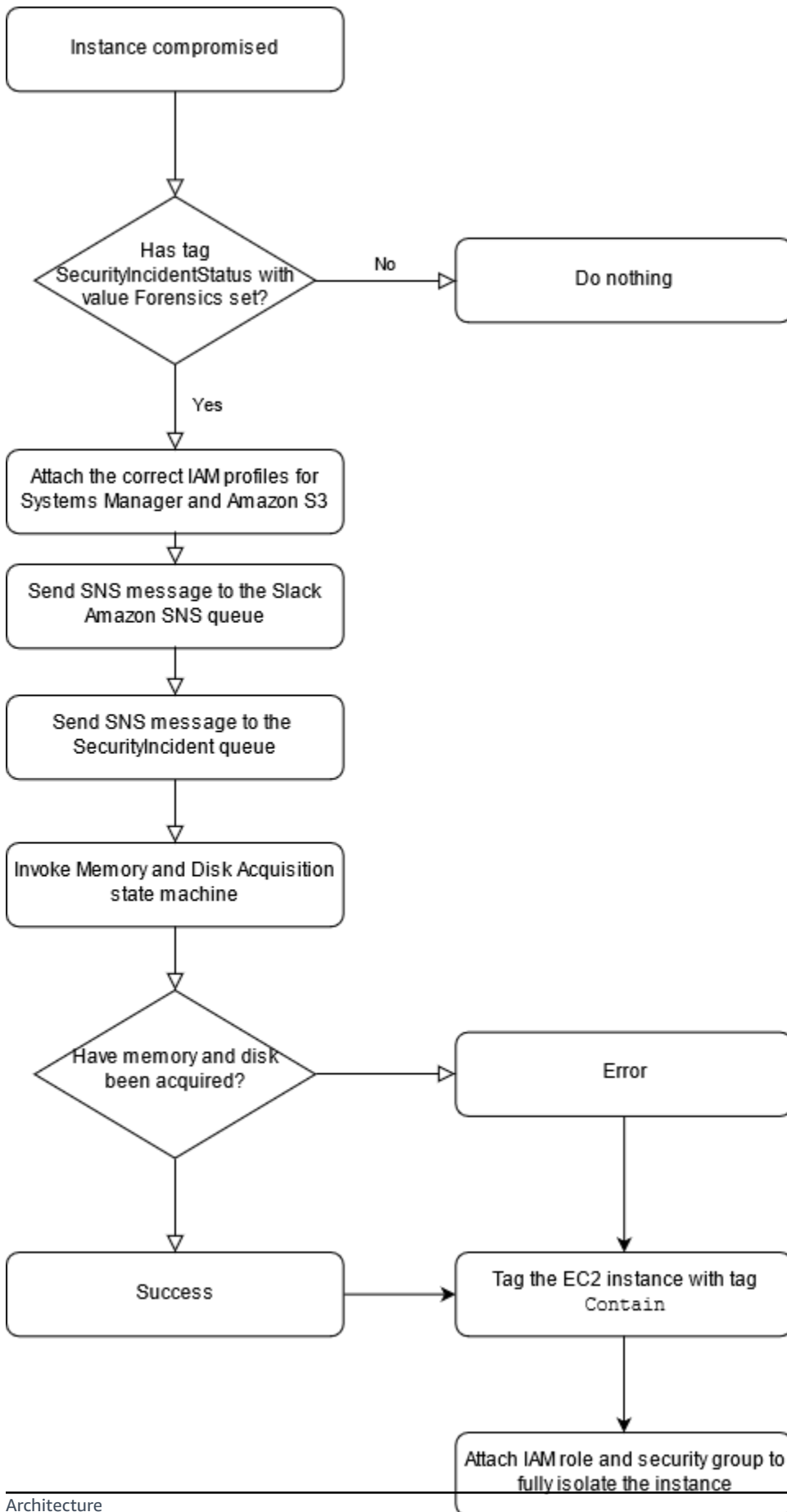

## Automation and scale

The intent of this pattern is to provide a scalable solution to perform incident response and forensics across several accounts within a single AWS Organizations organization.

## Tools

### AWS Services

- [AWS CloudFormation](#) helps you set up AWS resources, provision them quickly and consistently, and manage them throughout their lifecycle across AWS accounts and Regions.
- [AWS Command Line Interface \(AWS CLI\)](#) is an open-source tool for interacting with AWS services through commands in your command-line shell.
- [AWS Identity and Access Management \(IAM\)](#) helps you securely manage access to your AWS resources by controlling who is authenticated and authorized to use them.
- [AWS Key Management Service \(AWS KMS\)](#) helps you create and control cryptographic keys to protect your data.
- [AWS Lambda](#) is a compute service that helps you run code without needing to provision or manage servers. It runs your code only when needed and scales automatically, so you pay only for the compute time that you use.
- [Amazon Simple Storage Service \(Amazon S3\)](#) is a cloud-based object storage service that helps you store, protect, and retrieve any amount of data.
- [AWS Security Hub](#) provides a comprehensive view of your security state in AWS. It also helps you check your AWS environment against security industry standards and best practices.
- [Amazon Simple Notification Service \(Amazon SNS\)](#) helps you coordinate and manage the exchange of messages between publishers and clients, including web servers and email addresses.
- [AWS Step Functions](#) is a serverless orchestration service that helps you combine AWS Lambda functions and other AWS services to build business-critical applications.
- [AWS Systems Manager](#) helps you manage your applications and infrastructure running in the AWS Cloud. It simplifies application and resource management, shortens the time to detect and resolve operational problems, and helps you manage your AWS resources securely at scale.

### Code

For the code and specific implementation and usage guidance, see the GitHub [Automated Incident Response and Forensics Framework](#) repository.

## Epics

### Deploy the CloudFormation templates

Task	Description	Skills required
Deploy CloudFormation templates.	<p>The CloudFormation templates are marked 1 through 7 with the first word of the script name indicating in which account the template needs to be deployed. Note that the order of launching the CloudFormation templates is important.</p> <ul style="list-style-type: none"><li>• 1-forensic-AnalysisVPCnS3Buckets.yam 1 : Deployed in the forensics account. It creates the S3 buckets and the Analysis VPC, and it activates CloudTrail.</li><li>• 2-forensic-MaintenanceVPCnEC2ImageBuilderPipeline.yaml : Deploys the maintenance VPC and image builder pipeline based on SANS SIFT.</li><li>• 3-security_IR-Disk_Mem_automation.yaml : Deploys the functions in the security account that</li></ul>	AWS administrator

Task	Description	Skills required
	<p>enable disk and memory acquisition.</p> <ul style="list-style-type: none"><li data-bbox="592 317 1027 1066">• <code>4-security_LiME_Volatility_Factory.yaml</code> : Initiates a build function to start creating the memory modules based on the given AMI IDs. Note that AMI IDs are different across AWS Regions. Whenever you need new memory modules, you can rerun this script with the new AMI IDs. Consider integrating this with your golden image AMI builder pipelines (if used in your environment).</li><li data-bbox="592 1094 1027 1843">• <code>5-member-IR-automation.yaml</code> : Creates the member incident-response automation function, which initiates the incident-response process. It allows sharing Amazon Elastic Block Store (Amazon EBS) volumes across accounts, automated posting to Slack channels during the incident-response process, initiating the forensics process, and isolating the instances after the process finishes.</li></ul>	

Task	Description	Skills required
	<ul style="list-style-type: none"><li>• <code>6-forensic-artifact-s3-policies.yaml</code> : After all the scripts have been deployed this script fixes the permissions required for all the cross-account interactions.</li><li>• <code>7-security-IR-vpc.yaml</code> : Configures a VPC used for incident response volume processing.</li></ul> <p>To initiate the incident response framework for a specific EC2 instance, create a tag with the key <code>SecurityIncidentStatus</code> and the value <code>Analyze</code>. This will initiate the member Lambda function that will automatically start isolation and memory as well as disk acquisition.</p>	

Task	Description	Skills required
Operate the framework.	<p>The Lambda function will also retag the asset at the end (or on failure) with Contain.</p> <p>This initiates the containment, which fully isolates the instance with a no INBOUND/OUTBOUND security group and with an IAM role that disallows all access.</p> <p>Follow the steps in the <a href="#">GitHub repository</a>.</p>	AWS administrator

## Deploy custom Security Hub actions

Task	Description	Skills required
Deploy the custom Security Hub actions by using a CloudFormation template.	<p>To create a custom action so that you can use the dropdown list from Security Hub, deploy the Modules/SecurityHub Custom Actions/SecurityHubCustomActions.yaml CloudFormation template. Then modify the IRAutomation role in each of the member accounts to allow the Lambda function that runs the action to assume the IRAutomation role. For more information, see the <a href="#">GitHub repository</a>.</p>	AWS administrator



## Related resources

- [AWS Security Incident Response Guide](#)

## Additional information

By using this environment, a Security Operations Center (SOC) team can improve their security incident response process through the following:

- Having the ability to perform forensics in a segregated environment to avoid accidental compromise of production resources
- Having a standardized, repeatable, automated process to do containment and analysis.
- Giving any account owner or administrator the ability to initiate the incident-response process with the minimal knowledge of how to use tags
- Having a standardized, clean environment for performing incident analysis and forensics without the noise of a larger environment
- Having the ability to create multiple analysis environments in parallel
- Focusing SOC resources on incident response instead of on maintenance and documentation of a cloud forensics environment
- Moving away from a manual process toward an automated one to achieve scalability
- Using CloudFormation templates for consistency and to avoid repeatable tasks

Additionally, you avoid using persistent infrastructure, and you pay for resources when you need them.

## Attachments

To access additional content that is associated with this document, unzip the following file: [attachment.zip](#)

# Automate remediation for AWS Security Hub standard findings

Created by Chandini Penmetsa (AWS) and Aromal Raj Jayarajan (AWS)

<b>Environment:</b> Production	<b>Technologies:</b> Security, identity, compliance	<b>Workload:</b> All other workloads
<b>AWS services:</b> AWS CloudFormation; Amazon CloudWatch; AWS Lambda; AWS Security Hub; Amazon SNS		

## Summary

With AWS Security Hub, you can enable checks for standard best practices such as the following:

- AWS Foundational Security Best Practices
- CIS AWS Foundations Benchmark
- Payment Card Industry Data Security Standard (PCI DSS)

Each of these standards has predefined controls. Security Hub checks for the control in a given AWS account and reports the findings.

AWS Security Hub sends all findings to Amazon EventBridge by default. This pattern provides a security control that deploys an EventBridge rule to identify AWS Foundational Security Best Practices standard findings. The rule identifies the following findings for automatic scaling, virtual private clouds (VPCs), Amazon Elastic Block Store (Amazon EBS), and Amazon Relational Database Service (Amazon RDS) from the AWS Foundational Security Best Practices standard:

- [AutoScaling.1] Auto Scaling groups associated with a load balancer should use load balancer health checks
- [EC2.2] The VPC default security group should not allow inbound and outbound traffic
- [EC2.6] VPC flow logging should be enabled in all VPCs
- [EC2.7] EBS default encryption should be enabled

- [RDS.1] RDS snapshots should be private
- [RDS.6] Enhanced monitoring should be configured for RDS DB instances and clusters
- [RDS.7] RDS clusters should have deletion protection enabled

The EventBridge rule forwards these findings to an AWS Lambda function, which remediates the finding. The Lambda function then sends a notification with remediation information to an Amazon Simple Notification Service (Amazon SNS) topic.

## Prerequisites and limitations

### Prerequisites

- An active AWS account
- An email address where you want to receive the remediation notification
- Security Hub and AWS Config enabled in the AWS Region where you intend to deploy the control
- An Amazon Simple Storage Service (Amazon S3) bucket in same Region as the control to upload the AWS Lambda code

### Limitations

- This security control automatically remediates new findings reported after the security control deployment. To remediate existing findings, select the findings manually on the Security Hub console. Then, under **Actions**, select the **AFSBPREmedy** custom action that was created as part of the deployment by AWS CloudFormation.
- This security control is regional and must be deployed in the AWS Regions that you intend to monitor.
- For the EC2.6 remedy, to enable VPC Flow Logs, an Amazon CloudWatch Logs log group will be created with /VpcFlowLogs/vpc\_id format. If a log group exists with same name, the existing log group will be used.
- For the EC2.7 remedy, to enable Amazon EBS default encryption, the default AWS Key Management Service (AWS KMS) key is used. This change prevents the use of certain instances that do not support encryption.

# Architecture

## Target technology stack

- Lambda function
- Amazon SNS topic
- EventBridge rule
- AWS Identity and Access Management (IAM) roles for Lambda function, VPC Flow Logs, and Amazon Relational Database Service (Amazon RDS) Enhanced Monitoring

## Target architecture



## Automation and scale

If you are using AWS Organizations, you can use [AWS CloudFormation StackSets](#) to deploy this template in multiple accounts that you want this to monitor.

# Tools

## Tools

- [AWS CloudFormation](#) – AWS CloudFormation is a service that helps you model and set up AWS resources by using infrastructure as code.
- [EventBridge](#) – Amazon EventBridge delivers a stream of real-time data from your own applications, software as a service (SaaS) applications, and AWS services, routing that data to targets such as Lambda functions.
- [Lambda](#) – AWS Lambda supports running code without provisioning or managing servers.
- [Amazon S3](#) – Amazon Simple Storage Service (Amazon S3) is a highly scalable object storage service that you can use for a wide range of storage solutions, including websites, mobile applications, backups, and data lakes.

- [Amazon SNS](#) – Amazon Simple Notification Service (Amazon SNS) coordinates and manages the delivery or sending of messages between publishers and clients, including web servers and email addresses. Subscribers receive all messages published to the topics to which they subscribe, and all subscribers to a topic receive the same messages.

## Best practices

- [Nine AWS Security Hub best practices](#)
- [AWS Foundational Security Best Practices standard](#)

## Epics

### Deploy the security control

Task	Description	Skills required
Define the S3 bucket.	On the Amazon S3 console, choose or create an S3 bucket with a unique name that does not contain leading slashes. An S3 bucket name is globally unique, and the namespace is shared by all AWS accounts. Your S3 bucket must be in the same Region as the Security Hub findings that are being evaluated.	Cloud Architect
Upload the Lambda code to the S3 bucket.	Upload the Lambda code .zip file that's provided in the "Attachments" section to the defined S3 bucket.	Cloud Architect
Deploy the AWS CloudFormation template.	Deploy the AWS CloudFormation template that's provided as an attachment to this pattern. In the next	Cloud Architect

Task	Description	Skills required
	epic, provide the values for the parameters.	

### Complete the parameters in the AWS CloudFormation template

Task	Description	Skills required
Provide the S3 bucket name.	Enter the name of the S3 bucket that you created in the first epic.	Cloud Architect
Provide the Amazon S3 prefix.	Provide the location of the Lambda code .zip file in your S3 bucket, without leading slashes (for example, <directory>/<file-name>.zip).	Cloud Architect
Provide the SNS topic ARN.	Provide the SNS topic Amazon Resource Name (ARN) if you want to use an existing SNS topic for remediation notifications. To use a new SNS topic, keep the value as "None" (the default value).	Cloud Architect
Provide an email address.	Provide an email address where you want to receive the remediation notifications (needed only when you want AWS CloudFormation to create the SNS topic).	Cloud Architect
Define the logging level.	Define the logging level and frequency for your Lambda	Cloud Architect

Task	Description	Skills required
	function. "Info" designates detailed informational messages on the application's progress. "Error" designates error events that could still allow the application to continue running. "Warning" designates potentially harmful situations.	
Provide the VPC Flow Logs IAM role ARN.	Provide the IAM role ARN to be used for VPC Flow Logs. (If "None" is entered as input, AWS CloudFormation creates an IAM role and uses it.)	Cloud Architect
Provide the RDS Enhanced Monitoring IAM role ARN.	Provide the IAM role ARN to be used for RDS Enhanced Monitoring. (If "None" is entered, AWS CloudFormation creates an IAM role and uses it.)	Cloud Architect

## Confirm the subscription

Task	Description	Skills required
Confirm the Amazon SNS subscription.	When the template successfully deploys, if a new SNS topic was created, a subscription message is sent to the email address that you provided. To receive remediation notifications, you must confirm this subscription email message.	Cloud Architect

## Related resources

- [Creating a stack on the AWS CloudFormation console](#)
- [AWS Lambda](#)
- [AWS Security Hub](#)

## Attachments

To access additional content that is associated with this document, unzip the following file:  
[attachment.zip](#)



# Automate security scans for cross-account workloads using Amazon Inspector and AWS Security Hub

Created by Ramya Pulipaka (AWS) and Mikeshe Khanal (AWS)

**Environment:** Production

**Technologies:** Security, identity, compliance; Management & governance

**AWS services:** Amazon Inspector; Amazon SNS; AWS Lambda; AWS Security Hub; Amazon CloudWatch

## Summary

This pattern describes how to automatically scan for vulnerabilities in cross-account workloads on the Amazon Web Services (AWS) Cloud.

The pattern helps create a schedule for host-based scans of Amazon Elastic Compute Cloud (Amazon EC2) instances that are grouped by tags or for network-based Amazon Inspector scans. An AWS CloudFormation stack deploys all the required AWS resources and services to your AWS accounts.

The Amazon Inspector findings are exported to AWS Security Hub and provide insights into vulnerabilities across your accounts, AWS Regions, virtual private clouds (VPCs), and EC2 instances. You can receive these findings by email or you can create an Amazon Simple Notification Service (Amazon SNS) topic that uses an HTTP endpoint to send the findings to ticketing tools, security information and event management (SIEM) software, or other third-party security solutions.

## Prerequisites and limitations

### Prerequisites

- An existing email address to receive email notifications from Amazon SNS.
- An existing HTTP endpoint used by ticketing tools, SIEM software, or other third-party security solutions.
- Active AWS accounts that host cross-account workloads, including a central audit account.

- Security Hub, enabled and configured. You can use this pattern without Security Hub, but we recommend using Security Hub because of the insights it generates. For more information, see [Setting up Security Hub](#) in the AWS Security Hub documentation.
- An Amazon Inspector agent must be installed on each EC2 instance that you want to scan. You can install the Amazon Inspector agent on multiple EC2 instances by using [AWS Systems Manager Run Command](#).

## Skills

- Experience using self-managed and service-managed permissions for stack sets in AWS CloudFormation. If you want to use self-managed permissions to deploy stack instances to specific accounts in specific Regions, you must create the required AWS Identity and Access Management (IAM) roles. If you want to use service-managed permissions to deploy stack instances to accounts managed by AWS Organizations in specific Regions, you don't need to create the required IAM roles. For more information, see [Create a stack set](#) in the AWS CloudFormation documentation.

## Limitations

- If no tags are applied to EC2 instances in an account, then Amazon Inspector scans all the EC2 instances in that account.
- The AWS CloudFormation stack sets and the onboard-audit-account.yaml file (attached) must be deployed in the same Region.
- By default, [Amazon Inspector Classic](#) doesn't support aggregated findings. Security Hub is the recommended solution to viewing assessments for multiple accounts or AWS Regions.
- This pattern's approach can scale under the publish quota of 30,000 transactions per second (TPS) for an SNS topic in the US East (N. Virginia) Region (us-east-1), although limits vary by Region. To scale more effectively and avoid data loss, we recommend using Amazon Simple Queue Service (Amazon SQS) in front of the SNS topic.

## Architecture

The following diagram illustrates the workflow for automatically scanning EC2 instances.

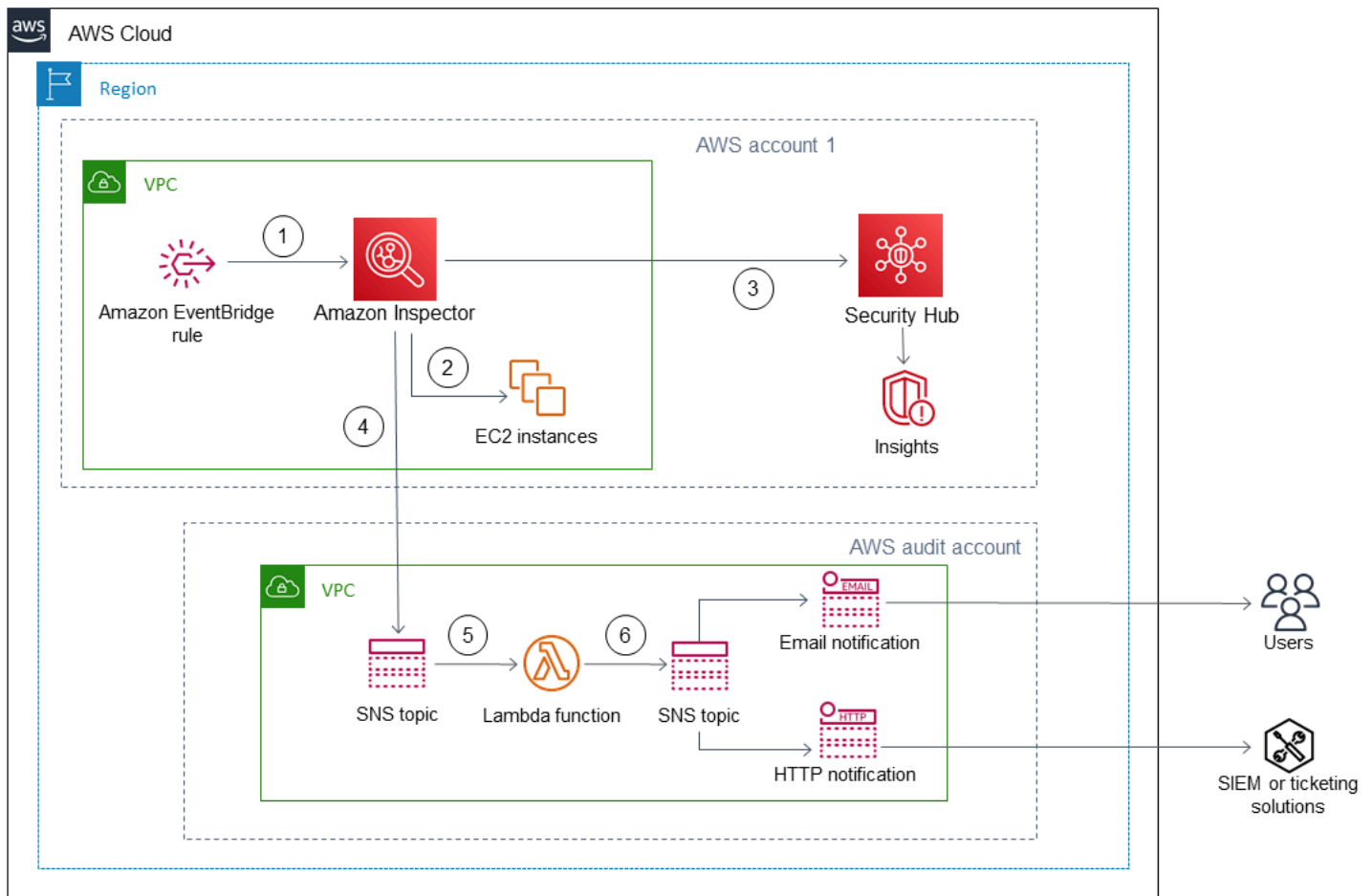

The workflow consists of the following steps:

1. An Amazon EventBridge rule uses a cron expression to self-initiate on a specific schedule and initiates Amazon Inspector.
2. Amazon Inspector scans the tagged EC2 instances in the account.
3. Amazon Inspector sends the findings to Security Hub, which generates insights for workflow, prioritization, and remediation.
4. Amazon Inspector also sends the assessment's status to an SNS topic in the audit account. An AWS Lambda function is invoked if a findings reported event is published to the SNS topic.
5. The Lambda function fetches, formats, and sends the findings to another SNS topic in the audit account.
6. Findings are sent to the email addresses that are subscribed to the SNS topic. The full details and recommendations are sent in JSON format to the subscribed HTTP endpoint.

## Technology stack

- AWS Control Tower
- EventBridge
- IAM
- Amazon Inspector
- Lambda
- Security Hub
- Amazon SNS

## Tools

- [AWS CloudFormation](#) – AWS CloudFormation helps you model and set up your AWS resources so that you can spend less time managing those resources and more time focusing on your applications.
- [AWS CloudFormation StackSets](#) – AWS CloudFormation StackSets extends the functionality of stacks by enabling you to create, update, or delete stacks across multiple accounts and Regions with a single operation.
- [AWS Control Tower](#) – AWS Control Tower creates an abstraction or orchestration layer that combines and integrates the capabilities of several other AWS services, including AWS Organizations.
- [Amazon EventBridge](#) – EventBridge is a serverless event bus service that makes it easy to connect your applications with data from a variety of sources.
- [AWS Lambda](#) – Lambda is a compute service that helps you run code without provisioning or managing servers.
- [AWS Security Hub](#) – Security Hub provides you with a comprehensive view of your security state in AWS and helps you check your environment against security industry standards and best practices.
- [Amazon SNS](#) – Amazon Simple Notification Service (Amazon SNS) is a managed service that provides message delivery from publishers to subscribers.

## Epics

### Deploy the AWS CloudFormation template

Task	Description	Skills required
Deploy the AWS CloudFormation template in the audit account.	<p>Download and save the <code>onboard-audit-account.yaml</code> file (attached) to a local path on your computer.</p> <p>Sign in to the AWS Management Console for your audit account, open the AWS CloudFormation console, and then choose <b>Create stack</b>.</p> <p>Choose <b>Prepare template</b> in the <b>Prerequisites</b> section, and then choose <b>Template is ready</b>. Choose <b>Template source</b> in the <b>Specify template</b> section, and then choose <b>Template is ready</b>. Upload the <code>onboard-audit-account.yaml</code> file and then configure the remaining options according to your requirements.</p> <p><b>Important:</b> Make sure that you configure the following input parameters:</p>	Developer, Security engineer

Task	Description	Skills required
	<ul style="list-style-type: none"> <li>• <code>DestinationEmailAddress</code> – Enter an email address to receive findings.</li> <li>• <code>HTTPEndpoint</code> – Provide an HTTP endpoint for your ticketing or SIEM tools.</li> </ul> <p>You can also deploy the AWS CloudFormation template by using AWS Command Line Interface (AWS CLI). For more information about this, see <a href="#">Creating a stack</a> in the AWS CloudFormation documentation.</p>	
Confirm the Amazon SNS subscription.	Open your email inbox and choose <b>Confirm subscription</b> in the email that you receive from Amazon SNS. This opens a web browser window and displays the subscription confirmation.	Developer, Security engineer

## Create AWS CloudFormation stack sets to automate the Amazon Inspector scan schedule

Task	Description	Skills required
Create stack sets in the audit account.	Download the <code>vulnerability-management-program.yaml</code> file (attached) to a local path on your computer.	Developer, Security engineer

Task	Description	Skills required
	<p>On the AWS CloudFormation console, choose <b>View stacksets</b> and then choose <b>Create StackSet</b>. Choose <b>Template is ready</b>, choose <b>Upload a template file</b>, and then upload the <code>vulnerability-management-program.yaml</code> file.</p> <p>If you want to use self-managed permissions, follow the instructions from <a href="#">Create a stack set with self-managed permissions</a> in the AWS CloudFormation documentation. This creates stack sets in individual accounts.</p> <p>If you want to use service-managed permissions, follow the instructions from <a href="#">Create a stack set with service-managed permissions</a> in the AWS CloudFormation documentation. This creates stack sets in your entire organization or specified organizational units (OUs).</p> <p><b>Important:</b> Make sure that the following input parameters are configured for your stack sets:</p>	

Task	Description	Skills required
	<ul style="list-style-type: none"> <li>• <code>AssessmentSchedule</code> <ul style="list-style-type: none"> <li>– The schedule for EventBridge using cron expressions.</li> </ul> </li> <li>• <code>Duration</code> – The duration of the Amazon Inspector assessment run in seconds.</li> <li>• <code>CentralSNSTopicArn</code> <ul style="list-style-type: none"> <li>– The Amazon Resource Name (ARN) for the central SNS topic.</li> </ul> </li> <li>• <code>Tagkey</code> – The tag key that is associated with the resource group.</li> <li>• <code>Tagvalue</code> – The tag value that is associated with the resource group.</li> </ul> <p>If you want to scan EC2 instances in the audit account, you must run the <code>vulnerability-management-program.yaml</code> file as an AWS CloudFormation stack in the audit account.</p>	
Validate the solution.	Check that you receive findings by email or HTTP endpoint on the schedule that you specified for Amazon Inspector.	Developer, Security engineer



## Related resources

- [Scale your security vulnerability testing with Amazon Inspector](#)
- [Automatically remediate Amazon Inspector security findings](#)
- [How to simplify security assessment setup by using Amazon EC2, AWS Systems Manager, and Amazon Inspector](#)

## Attachments

To access additional content that is associated with this document, unzip the following file:  
[attachment.zip](#)

# Automatically re-enable AWS CloudTrail by using a custom remediation rule in AWS Config

Created by Manigandan Shri (AWS)

**Environment:** Production

**Technologies:** Infrastructure; Operations; Security, identity, compliance

**AWS services:** Amazon S3; AWS Config; AWS KMS; AWS Identity and Access Management; AWS Systems Manager; AWS CloudTrail

## Summary

Visibility over activity in your Amazon Web Services (AWS) account is an important security and operational best practice. AWS CloudTrail helps you with the governance, compliance, and operational and risk auditing of your account.

To ensure that CloudTrail remains enabled in your account, AWS Config provides the `cloudtrail-enabled` managed rule. If CloudTrail is turned off, the `cloudtrail-enabled` rule automatically re-enables it by using [automatic remediation](#).

However, you must make sure that you follow [security best practices](#) for CloudTrail if you use automatic remediation. These best practices include enabling CloudTrail in all AWS Regions, logging read and write workloads, enabling insights, and encrypting log files with [server-side encryption using AWS Key Management Service \(AWS KMS\) managed keys \(SSE-KMS\)](#).

This pattern helps you follow these security best practices by providing a custom remediation action to automatically re-enable CloudTrail in your account.

**Important:** We recommend using [service control policies \(SCPs\)](#) to prevent any tampering with CloudTrail. For more information about this, see the *Prevent tampering with AWS CloudTrail* section of [How to use AWS Organizations to simplify security at enormous scale](#) on the AWS Security Blog.

## Prerequisites and limitations

### Prerequisites

- An active AWS account
- Permissions to create an AWS Systems Manager Automation runbook
- An existing trail for your account

## Limitations

This pattern doesn't support the following actions:

- Setting an Amazon Simple Storage Service (Amazon S3) prefix key for the storage location
- Publishing to an Amazon Simple Notification Service (Amazon SNS) topic
- Configuring Amazon CloudWatch Logs to monitor your CloudTrail logs

## Architecture

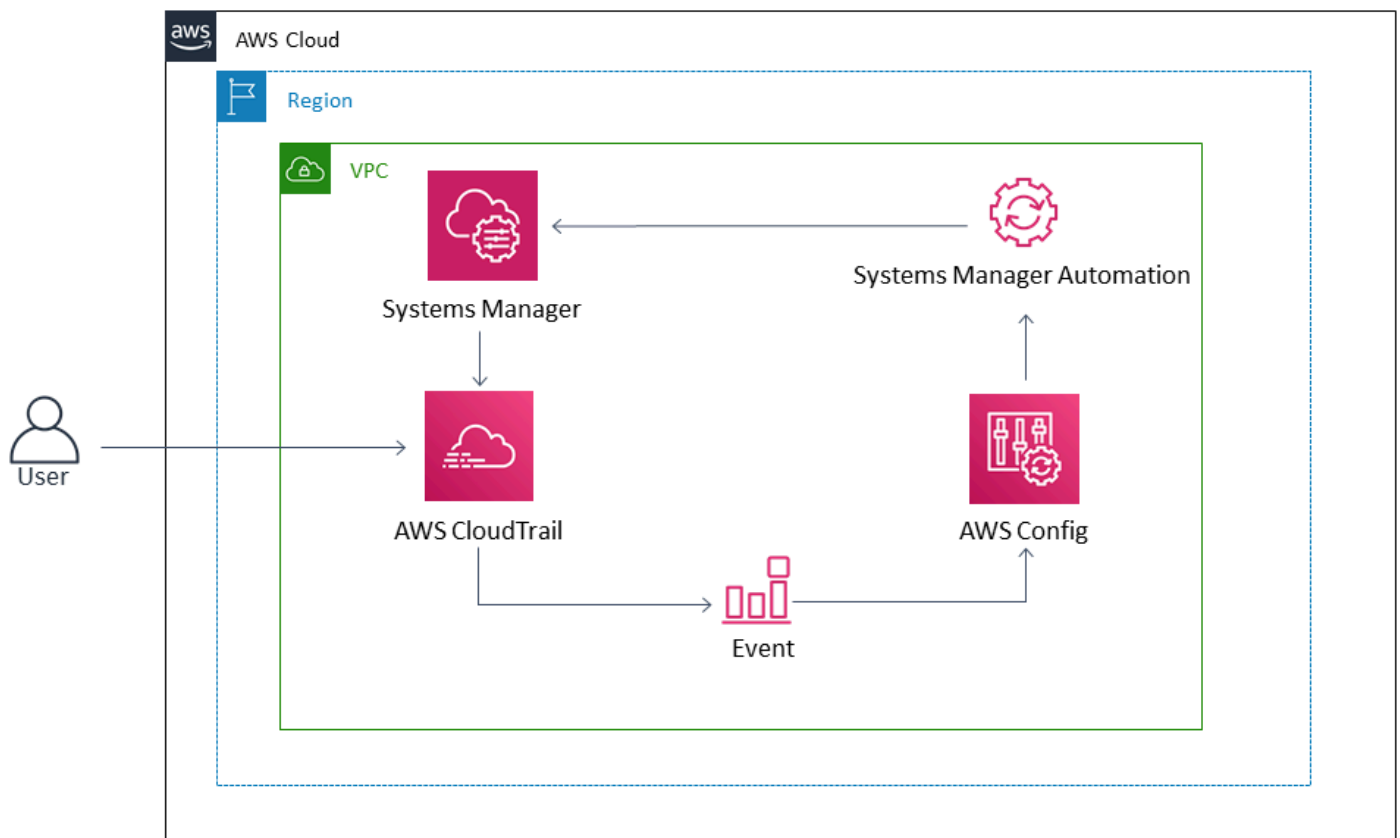

## Technology stack

- AWS Config

- CloudTrail
- Systems Manager
- Systems Manager Automation

## Tools

- [AWS Config](#) provides a detailed view of the configuration of AWS resources in your account.
- [AWS CloudTrail](#) helps you enable governance, compliance, and operational and risk auditing of your account.
- [AWS Key Management Service \(AWS KMS\)](#) is an encryption and key management service.
- [AWS Systems Manager](#) helps you view and control your infrastructure on AWS.
- [AWS Systems Manager Automation](#) simplifies common maintenance and deployment tasks of Amazon Elastic Compute Cloud (Amazon EC2) instances and other AWS resources.
- [Amazon Simple Storage Service \(Amazon S3\)](#) is a cloud-based object storage service that helps you store, protect, and retrieve any amount of data.

## Code

The **cloudtrail-remediation-action.yml** file (attached) helps you create a Systems Manager Automation runbook to set up and re-enable CloudTrail using security best practices.

## Epics

### Configure CloudTrail

Task	Description	Skills required
Create an S3 bucket.	Sign in to the AWS Management Console, open the Amazon S3 console, and then create an S3 bucket to store the CloudTrail logs. For more information, see <a href="#">Create an S3 bucket</a> in the Amazon S3 documentation.	Systems administrator

Task	Description	Skills required
<p>Add a bucket policy to allow CloudTrail to deliver log files to the S3 bucket.</p>	<p>CloudTrail must have the required permissions to deliver log files to your S3 bucket. On the Amazon S3 console, choose the S3 bucket that you created earlier and then choose <b>Permissions</b>. Create an S3 bucket policy by using the <a href="#">Amazon S3 bucket policy for CloudTrail</a> from the CloudTrail documentation.</p> <p>For steps on how to add a policy to an S3 bucket, see <a href="#">Adding a bucket policy using the Amazon S3 console</a> in the Amazon S3 documentation.</p> <p><b>Important:</b> If you specified a prefix when you created your trail in CloudTrail, make sure that you include it in the S3 bucket policy. The prefix is an optional addition to the S3 object key that creates a folder-like organization in your S3 bucket. For more information about this, see <a href="#">Creating a trail</a> in the CloudTrail documentation.</p>	<p>Systems administrator</p>

Task	Description	Skills required
Create a KMS key.	Create an AWS KMS key for CloudTrail to encrypt objects before adding them to the S3 bucket. For help with this story, see <a href="#">Encrypting CloudTrail log files with AWS KMS managed keys (SSE-KMS)</a> in the CloudTrail documentation.	Systems administrator
Add a key policy to the KMS key.	Attach a KMS key policy to allow CloudTrail to use the KMS key. For help with this story, see <a href="#">Encrypting CloudTrail log files with AWS KMS-managed keys (SSE-KMS)</a> in the CloudTrail documentation.  <b>Important:</b> CloudTrail doesn't require Decrypt permissions.	Systems administrator
Create AssumeRole for Systems Manager runbook	Create an AssumeRole for Systems Manager Automation to run the runbook. For instructions and more information about this, see <a href="#">Setting up automation</a> in the Systems Manager documentation.	Systems administrator

## Create and test the Systems Manager Automation runbook

Task	Description	Skills required
Create the Systems Manager Automation runbook.	Use the <code>cloudtrail-remediation-action.yml</code> file (attached) to create the Systems Manager Automation runbook. For more information about this, see <a href="#">Creating Systems Manager documents</a> in the Systems Manager documentation.	Systems administrator
Test the runbook.	On the Systems Manager console, test the Systems Manager Automation runbook that you created earlier. For more information about this, see <a href="#">Running a simple automation</a> in the Systems Manager documentation.	Systems administrator

## Set up the automatic remediation rule in AWS Config

Task	Description	Skills required
Add the CloudTrail-enabled rule.	On the AWS Config console, choose <b>Rules</b> and then choose <b>Add rule</b> . On the <b>Add rule</b> page, choose <b>Add custom</b> rule. On the <b>Configure rule</b> page, enter a name and description, and add the <code>cloudtrail-</code>	Systems administrator

Task	Description	Skills required
	enabled rule. For more information, see <a href="#">Managing your AWS Config rules</a> in the AWS Config documentation.	



Task	Description	Skills required
Add the automatic remediation action.	<p>From the <b>Actions</b> dropdown list, choose <b>Manage remediation</b>. Choose <b>Auto remediation</b> and then choose the Systems Manager runbook that you created earlier.</p> <p>The following are the required input parameters for CloudTrail:</p> <ul style="list-style-type: none"><li>• CloudTrailName</li><li>• CloudTrailS3BucketName</li><li>• CloudTrailKmsKeyId</li><li>• AssumeRole (optional)</li></ul> <p>The following input parameters are set to <b>true</b> by default:</p> <ul style="list-style-type: none"><li>• IsMultiRegionTrail</li><li>• IsOrganizationTrail</li><li>• IncludeGlobalServiceEvents</li><li>• EnableLogFileValidation</li></ul> <p>Retain the default values for the <b>Rate Limits</b> parameter and</p>	Systems administrator

Task	Description	Skills required
	<p><b>Resource ID parameter.</b> Choose <b>Save</b>.</p> <p>For more information, see <a href="#">Remediating noncompliant AWS resources with AWS Config rules</a> in the AWS Config documentation.</p>	
<p>Test the automatic remediation rule.</p>	<p>To test the automatic remediation rule, open the CloudTrail console, choose <b>Trails</b>, and then choose the trail. Choose <b>Stop logging</b> to turn off logging for the trail. When you are prompted to confirm, choose <b>Stop logging</b>. CloudTrail stops logging activity for that trail.</p> <p>Follow the instructions from <a href="#">Evaluating your resources</a> in the AWS Config documentation to make sure that CloudTrail was automatically re-enabled.</p>	<p>Systems administrator</p>

## Related resources

### Configure CloudTrail

- [Create an S3 bucket](#)
- [Amazon S3 bucket policy for CloudTrail](#)
- [Adding a bucket policy using the Amazon S3 console](#)
- [Creating a trail](#)

- [Setting up automation](#)
- [Encrypting CloudTrail log files with AWS KMS managed keys \(SSE-KMS\)](#)

### **Create and test the Systems Manager Automation runbook**

- [Creating Systems Manager documents](#)
- [Running a simple automation](#)

### **Set up the automatic remediation rule in AWS Config**

- [Managing your AWS Config rules](#)
- [Remediating noncompliant AWS resources with AWS Config rules](#)

### **Additional resources**

- [AWS CloudTrail - Security best practices](#)
- [Getting started with AWS Systems Manager](#)
- [Getting started with AWS Config](#)
- [Getting started with AWS CloudTrail](#)

## **Attachments**

To access additional content that is associated with this document, unzip the following file:  
[attachment.zip](#)

# Automatically remediate unencrypted Amazon RDS DB instances and clusters

Created by Ajay Rawat (AWS) and Josh Joy (AWS)

**Environment:** PoC or pilot

**Technologies:** Security, identity, compliance; Databases

**AWS services:** AWS Config; AWS KMS; AWS Identity and Access Management; AWS Systems Manager; Amazon RDS

## Summary

This pattern describes how to automatically remediate unencrypted Amazon Relational Database Service (Amazon RDS) DB instances and clusters on Amazon Web Services (AWS) by using AWS Config, AWS Systems Manager runbooks, and AWS Key Management Service (AWS KMS) keys.

Encrypted RDS DB instances provide an additional layer of data protection by securing your data from unauthorized access to the underlying storage. You can use Amazon RDS encryption to increase data protection of your applications deployed in the AWS Cloud, and to fulfill compliance requirements for encryption at rest. You can enable encryption for an RDS DB instance when you create it, but not after it's created. However, you can add encryption to an unencrypted RDS DB instance by creating a snapshot of your DB instance, and then creating an encrypted copy of that snapshot. You can then restore a DB instance from the encrypted snapshot to get an encrypted copy of your original DB instance.

This pattern uses AWS Config rules to evaluate RDS DB instances and clusters. It applies remediation by using AWS Systems Manager runbooks, which define the actions to be performed on noncompliant Amazon RDS resources, and AWS KMS keys to encrypt the DB snapshots. It then enforces service control policies (SCPs) to prevent the creation of new DB instances and clusters without encryption.

The code for this pattern is provided in [GitHub](#).

## Prerequisites and limitations

### Prerequisites

- An active AWS account
- Files from the [GitHub source code repository](#) for this pattern downloaded to your computer
- An unencrypted RDS DB instance or cluster
- An existing AWS KMS key for encrypting RDS DB instances and clusters
- Access to update the KMS key resource policy
- AWS Config enabled in your AWS account (see [Getting Started with AWS Config](#) in the AWS documentation)

## Limitations

- You can enable encryption for an RDS DB instance only when you create it, not after it has been created.
- You can't have an encrypted read replica of an unencrypted DB instance or an unencrypted read replica of an encrypted DB instance.
- You can't restore an unencrypted backup or snapshot to an encrypted DB instance.
- Amazon RDS encryption is available for most DB instance classes. For a list of exceptions, see [Encrypting Amazon RDS resources](#) in the Amazon RDS documentation.
- To copy an encrypted snapshot from one AWS Region to another, you must specify the KMS key in the destination AWS Region. This is because KMS keys are specific to the AWS Region that they are created in.
- The source snapshot remains encrypted throughout the copy process. Amazon RDS uses envelope encryption to protect data during the copy process. For more information, see [Envelope encryption](#) in the AWS KMS documentation.
- You can't unencrypt an encrypted DB instance. However, you can export data from an encrypted DB instance and import the data into an unencrypted DB instance.
- You should delete a KMS key only when you are sure that you don't need to use it any longer. If you aren't sure, consider [disabling the KMS key](#) instead of deleting it. You can reenableView a disabled KMS key if you need to use it again later, but you cannot recover a deleted KMS key.
- If you don't choose to retain automated backups, your automated backups that are in the same AWS Region as the DB instance are deleted. They can't be recovered after you delete the DB instance.
- Your automated backups are retained for the retention period that is set on the DB instance at the time you delete it. This set retention period occurs whether or not you choose to create a final DB snapshot.

- If automatic remediation is enabled, this solution encrypts all databases that have the same KMS key.

## Architecture

The following diagram illustrates the architecture for the AWS CloudFormation implementation. Note that you can also implement this pattern by using the AWS Cloud Development Kit (AWS CDK).

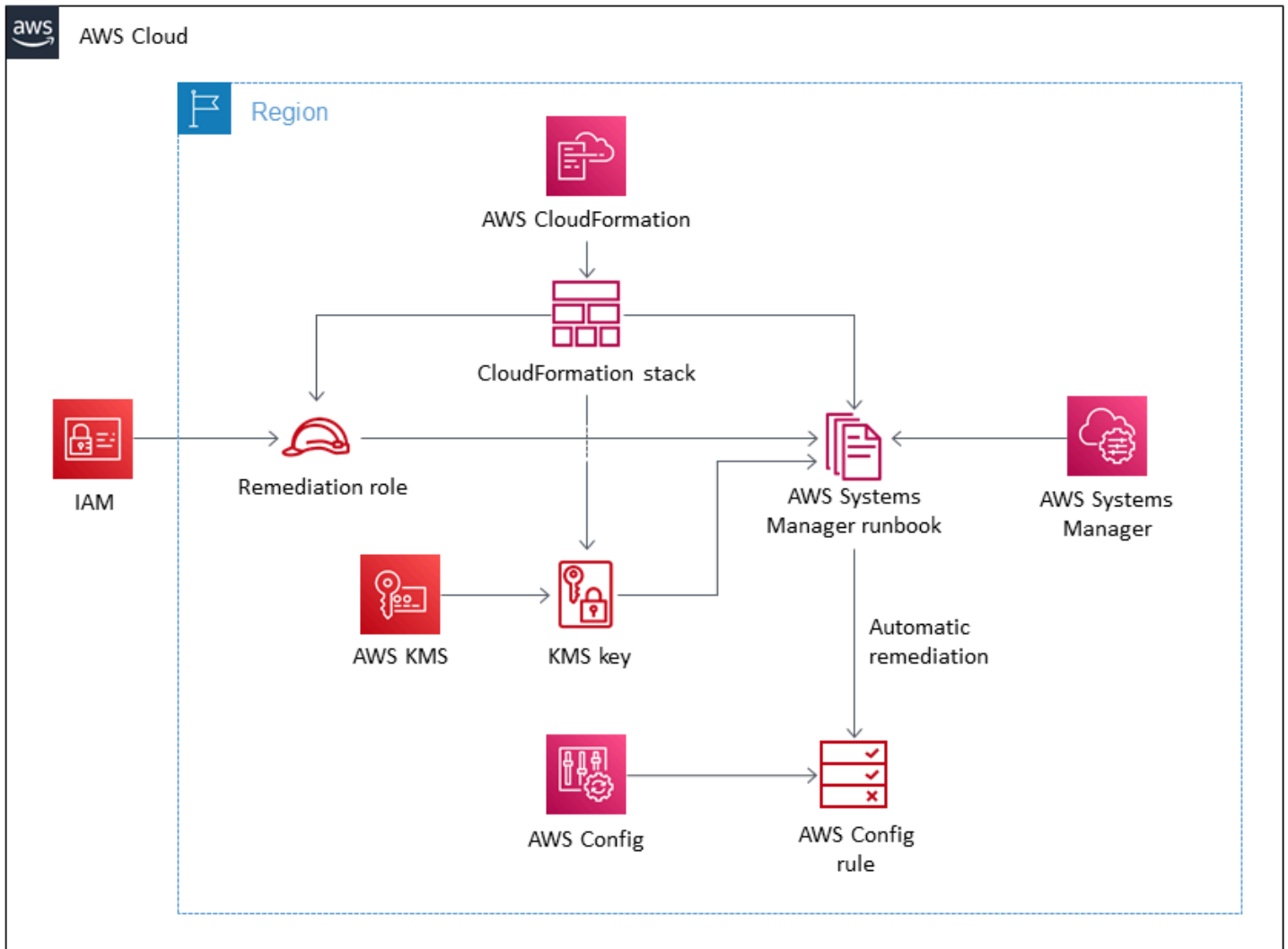

## Tools

### Tools

- [AWS CloudFormation](#) helps you automatically set up your AWS resources. It enables you to use a template file to create and delete a collection of resources together as a single unit (a stack).
- [AWS Cloud Development Kit \(AWS CDK\)](#) is a software development framework for defining your cloud infrastructure in code and provisioning it by using familiar programming languages.

## AWS services and features

- [AWS Config](#) keeps track of the configuration of your AWS resources and their relationships to your other resources. It can also evaluate those AWS resources for compliance. This service uses rules that can be configured to evaluate AWS resources against desired configurations. You can use a set of AWS Config managed rules for common compliance scenarios, or you can create your own rules for custom scenarios. When an AWS resource is found to be noncompliant, you can specify a remediation action through an AWS Systems Manager runbook and optionally send an alert through an Amazon Simple Notification Service (Amazon SNS) topic. In other words, you can associate remediation actions with AWS Config rules and choose to run them automatically to address noncompliant resources without manual intervention. If a resource is still noncompliant after automatic remediation, you can set the rule to try automatic remediation again.
- [Amazon Relational Database Service \(Amazon RDS\)](#) makes it easier to set up, operate, and scale a relational database in the cloud. The basic building block of Amazon RDS is the DB instance, which is an isolated database environment in the AWS Cloud. Amazon RDS provides a [selection of instance types](#) that are optimized to fit different relational database use cases. Instance types comprise various combinations of CPU, memory, storage, and networking capacity and give you the flexibility to choose the appropriate mix of resources for your database. Each instance type includes several instance sizes, allowing you to scale your database to the requirements of your target workload.
- [AWS Key Management Service \(AWS KMS\)](#) is a managed service that makes it easy for you to create and control AWS KMS keys, which encrypt your data. A KMS key is a logical representation of a root key. The KMS key includes metadata, such as the key ID, creation date, description, and key state.
- [AWS Identity and Access Management \(IAM\)](#) helps you securely manage access to your AWS resources by controlling who is authenticated and authorized to use them.
- [Service control policies \(SCPs\)](#) offer central control over the maximum available permissions for all accounts in your organization. SCPs help you ensure that your accounts stay within your organization's access control guidelines. SCPs don't affect users or roles in the management

account. They affect only the member accounts in your organization. We strongly recommend that you don't attach SCPs to the root of your organization without thoroughly testing the impact that the policy has on accounts. Instead, create an organizational unit (OU) that you can move your accounts into one at a time, or at least in small numbers, to ensure that you don't inadvertently lock users out of key services.

## Code

The source code and templates for this pattern are available in a [GitHub repository](#). The pattern provides two implementation options: You can deploy an AWS CloudFormation template to create the remediation role that encrypts RDS DB instances and clusters, or use the AWS CDK. The repository has separate folders for these two options.

The *Epics* section provides step-by-step instructions for deploying the CloudFormation template. If you want to use the AWS CDK, follow the instructions in the README.md file in the GitHub repository.

## Best practices

- Enable data encryption both at rest and in transit.
- Enable AWS Config in all accounts and AWS Regions.
- Record configuration changes to all resource types.
- Rotate your IAM credentials regularly.
- Leverage tagging for AWS Config, which makes it easier to manage, search for, and filter resources.

## Epics

### Create the IAM remediation role and AWS Systems Manager runbook

Task	Description	Skills required
Download the CloudFormation template.	Download the unencrypted-to-encrypted-rds.template.json file from the <a href="#">GitHub repository</a> .	DevOps engineer



Task	Description	Skills required
Create the CloudFormation stack.	<ol style="list-style-type: none"><li>1. Sign in to the AWS Management Console and open the CloudFormation console at <a href="https://console.aws.amazon.com/cloudformation/">https://console.aws.amazon.com/cloudformation/</a>.</li><li>2. Launch the unencrypted-to-encrypted-rds.template.json template to create a new stack.</li></ol> <p>For more information about deploying templates, see the <a href="#">AWS CloudFormation documentation</a>.</p>	DevOps engineer
Review CloudFormation parameters and values.	<ol style="list-style-type: none"><li>1. Review stack details and update values based on your environment requirements.</li><li>2. Choose <b>Create stack</b> to deploy the template.</li></ol>	DevOps engineer
Review the resources.	When the stack has been created, its status changes to <b>CREATE_COMPLETE</b> . Review the created resources (IAM role, AWS Systems Manager runbook) in the CloudFormation console.	DevOps engineer

## Update the AWS KMS key policy

Task	Description	Skills required
Update your KMS key policy.	<ol style="list-style-type: none"><li>1. Make sure that the key alias <code>alias/RDS EncryptionAtRestKMSAlias</code> exists.</li><li>2. The key policy statement should include the IAM remediation role. (Check the resources created by the CloudFormation template you deployed in the previous epic.)</li><li>3. In the following key policy, update the portions that are in bold to match your account and the IAM role that was created.</li></ol> <pre data-bbox="592 1178 1029 1866">{   "Sid": "Allow access through RDS for all principals in the account that are authorized to use RDS",   "Effect": "Allow",   "Principal": {     "AWS": "arn:aws: iam:: &lt;your-AWS- account-ID&gt;:role/ &lt;your-IAM-remediation- role&gt;"   },   "Action": [     "kms:Encrypt",</pre>	DevOps engineer

Task	Description	Skills required
	<pre>         "kms:Decrypt",         "kms:ReEn crypt*",         "kms:Gene rateDataKey*",         "kms:Crea teGrant",         "kms:List Grants",         "kms:Desc ribeKey"       ],       "Resource": "*",       "Condition": {         "StringEquals":       {         "kms:ViaS ervice": "ids.us-e ast-1.amazonaws.com",         "kms:Call erAccount": "&lt;your-AW S-account-ID&gt;"       }     }   } </pre>	

## Find and remediate noncompliant resources

Task	Description	Skills required
View noncompliant resources.	<ol style="list-style-type: none"> <li>To view a list of noncompliant resources, open the AWS Config console at <a href="https://console.aws.amazon.com/config/">https://console.aws.amazon.com/config/</a>.</li> <li>In the navigation pane, choose <b>Rules</b>, and then</li> </ol>	DevOps engineer

Task	Description	Skills required
	<p>choose the <code>rds-storage-encrypted</code> rule.</p> <p>The noncompliant resources listed in the AWS Config console will be instances, not clusters. The remediation automation encrypts instances and clusters, and creates either a newly encrypted instance or a newly created cluster. However, be sure not to simultaneously remediate multiple instances that belong to the same cluster.</p> <p>Before you remediate any RDS DB instances or volumes, make sure that the RDS DB instance is not in use. Confirm that there are no write operations occurring while the snapshot is being created, to ensure that the snapshot contains the original data. Consider enforcing a maintenance window during which the remediation will run.</p>	

Task	Description	Skills required
Remediate noncompliant resources.	<ol style="list-style-type: none"><li data-bbox="591 226 1027 451">1. When you are ready and the maintenance window is in effect, choose the resource to remediate, and then choose <b>Remediate</b>.  The <b>Action status</b> column should now display <b>Action execution queued</b>.</li><li data-bbox="591 646 1027 1255">2. View the progress and status of the remediation in Systems Manager. Open the AWS Systems Manager console at <a href="https://console.aws.amazon.com/systems-manager/">https://console.aws.amazon.com/systems-manager/</a>. In the navigation pane, choose <b>Automation</b>, and then select the execution ID of the corresponding automation to view further details.</li></ol>	DevOps engineer

Task	Description	Skills required
Verify that the RDS DB instance is available.	After the automation completes, the newly encrypted RDS DB instance will become available. The encrypted RDS DB instance will have the prefix encrypted followed by the original name. For example, if the unencrypted RDS DB instance name was database-1 , the newly encrypted RDS DB instance would be encrypted-database-1 .	DevOps engineer
Terminate the unencrypted instance.	After remediation is complete and the newly encrypted resource has been validated , you can terminate the unencrypted instance. Make sure to confirm that the newly encrypted resource matches the unencrypted resource before you terminate any resources.	DevOps engineer

## Enforce SCPs

Task	Description	Skills required
Enforce SCPs.	Enforce SCPs to prevent DB instances and clusters from being created without encryption in the future. Use	Security engineer

Task	Description	Skills required
	the <code>rds_encrypted.json</code> file that's provided in the <a href="#">GitHub repository</a> for this purpose, and follow the instructions in the <a href="#">AWS documentation</a> .	

## Related resources

### References

- [Setting up AWS Config](#)
- [AWS Config custom rules](#)
- [AWS KMS concepts](#)
- [AWS Systems Manager documents](#)
- [Service control policies](#)

### Tools

- [AWS CloudFormation](#)
- [AWS Cloud Development Kit \(AWS CDK\)](#)

### Guides and patterns

- [Automatically re-enable AWS CloudTrail by using a custom remediation rule in AWS Config](#)

## Additional information

### FAQ

**Q.** How does AWS Config work?

**A.** When you turn on AWS Config, it first discovers the supported AWS resources that exist in your account and generates a [configuration item](#) for each resource. AWS Config also generates

configuration items when the configuration of a resource changes, and it maintains historical records of the configuration items of your resources from the time you start the configuration recorder. By default, AWS Config creates configuration items for every supported resource in the AWS Region. If you don't want AWS Config to create configuration items for all supported resources, you can specify the resource types that you want it to track.

**Q.** How are AWS Config and AWS Config rules related to AWS Security Hub?

**A.** AWS Security Hub is a security and compliance service that provides security and compliance posture management as a service. It uses AWS Config and AWS Config rules as its primary mechanism to evaluate the configuration of AWS resources. AWS Config rules can also be used to evaluate resource configuration directly. Config rules are also used by other AWS services, such as AWS Control Tower and AWS Firewall Manager.



# Automatically rotate IAM user access keys at scale with AWS Organizations and AWS Secrets Manager

Created by Tracy Hickey (AWS), Gaurav Verma (AWS), Laura Seletos (AWS), Michael Davie (AWS), and Arvind Patel (AWS)

**Environment:** PoC or pilot

**Technologies:** Security, identity, compliance

**AWS services:** AWS CloudFormation; Amazon CloudWatch Events; AWS Identity and Access Management; AWS Lambda; AWS Organizations; Amazon S3; Amazon SES; AWS Secrets Manager

## Summary

**Important:** As a [best practice](#), AWS recommends that you use AWS Identity and Access Management (IAM) roles instead of IAM users with long-term credentials such as access keys. The approach documented in this pattern is intended only for legacy implementations that require long-lived AWS API credentials. For these implementations, we still recommend that you consider options for using short-term credentials, such as using [Amazon Elastic Compute Cloud \(Amazon EC2\) instance profiles](#) or [IAM Roles Anywhere](#). The approach in this article is only for cases where you are unable to change to using short-term credentials immediately, and you require long-term credentials to be rotated on a schedule. With this approach, you are responsible for periodically updating your legacy application code or configuration to use the rotated API credentials.

[Access keys](#) are long-term credentials for an IAM user. Regularly rotating your IAM credentials helps prevent a compromised set of IAM access keys from accessing components in your AWS account. Rotating IAM credentials is also an important part of [security best practices in IAM](#).

This pattern helps you automatically rotate IAM access keys by using AWS CloudFormation templates, which are provided in the GitHub [IAM key rotation](#) repository.

The pattern supports deployment in a single account or multiple accounts. If you're using AWS Organizations, this solution identifies all AWS account IDs within your organization and dynamically scales as accounts are removed or new accounts are created. The centralized AWS Lambda function uses an assumed IAM role to locally run the rotation functions across multiple accounts that you select.

- New IAM access keys are generated when existing access keys are 90 days old.
- The new access keys are stored as a secret in AWS Secrets Manager. A resource-based policy allows only the specified [IAM principal](#) to access and retrieve the secret. If you choose to store keys in the management account, the keys for all accounts are stored in the management account.
- The email address assigned to the owner of the AWS account where the new access keys were created receives a notification.
- The previous access keys are deactivated at 100 days old, and then deleted at 110 days old.
- A centralized email notification is sent to the AWS account owner.

Lambda functions and Amazon CloudWatch automatically perform these actions. You can then retrieve the new access key pair and replace them in your code or applications. The rotation, deletion, and deactivation periods can be customized.

## Prerequisites and limitations

- At least one active AWS account.
- AWS Organizations, configured and set up (see [tutorial](#)).
- Permissions to query AWS Organizations from your management account. For more information, see [AWS Organizations and service-linked roles](#) in the AWS Organizations documentation.
- An IAM principal that has permissions to launch the AWS CloudFormation template and associated resources. For more information, see [Grant self-managed permissions](#) in the AWS CloudFormation documentation.
- An existing Amazon Simple Storage Service (Amazon S3) bucket to deploy the resources.
- Amazon Simple Email Service (Amazon SES) moved out of the sandbox. For more information, see [Moving out of the Amazon SES sandbox](#) in the Amazon SES documentation.
- If you choose to run Lambda in a virtual private cloud (VPC), the following resources, which should be created before you run the main CloudFormation template:
  - A VPC.

- A subnet.
- Endpoints for Amazon SES, AWS Systems Manager, AWS Security Token Service (AWS STS), Amazon S3, and AWS Secrets Manager. (You can run the endpoint template that's provided in the GitHub [IAM key rotation](#) repository to create these endpoints.)
- The Simple Mail Transfer Protocol (SMTP) user and password stored in AWS Systems Manager parameters (SSM parameters). Parameters must match the main CloudFormation template parameters.

## Architecture

### Technology stack

- Amazon CloudWatch
- Amazon EventBridge
- IAM
- AWS Lambda
- AWS Organizations
- Amazon S3

### Architecture

The following diagrams show the components and workflows for this pattern. The solution supports two scenarios for storing the credentials: in a member account and in the management account.

*Option 1: Store the credentials in a member account*

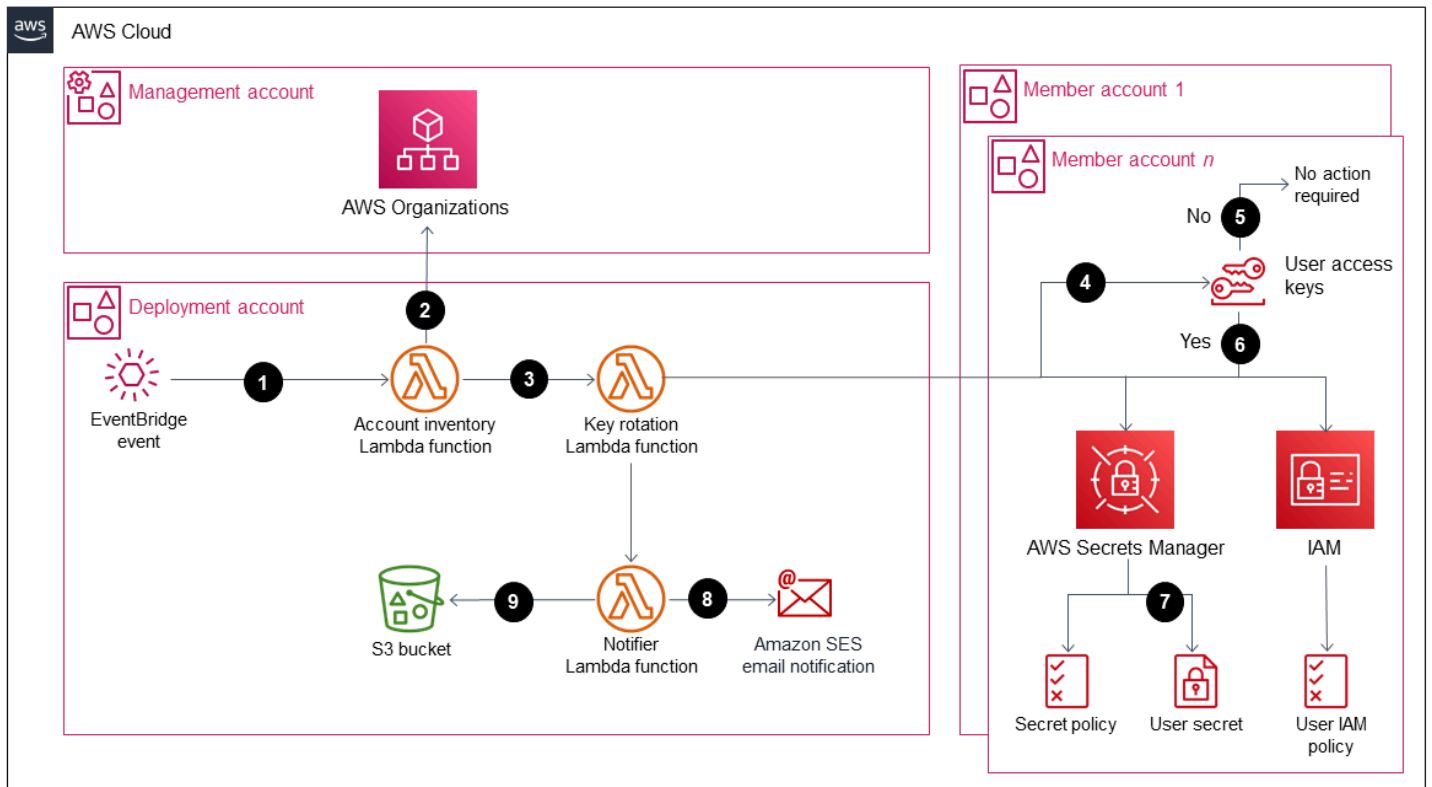

*Option 2: Store the credentials in the management account*

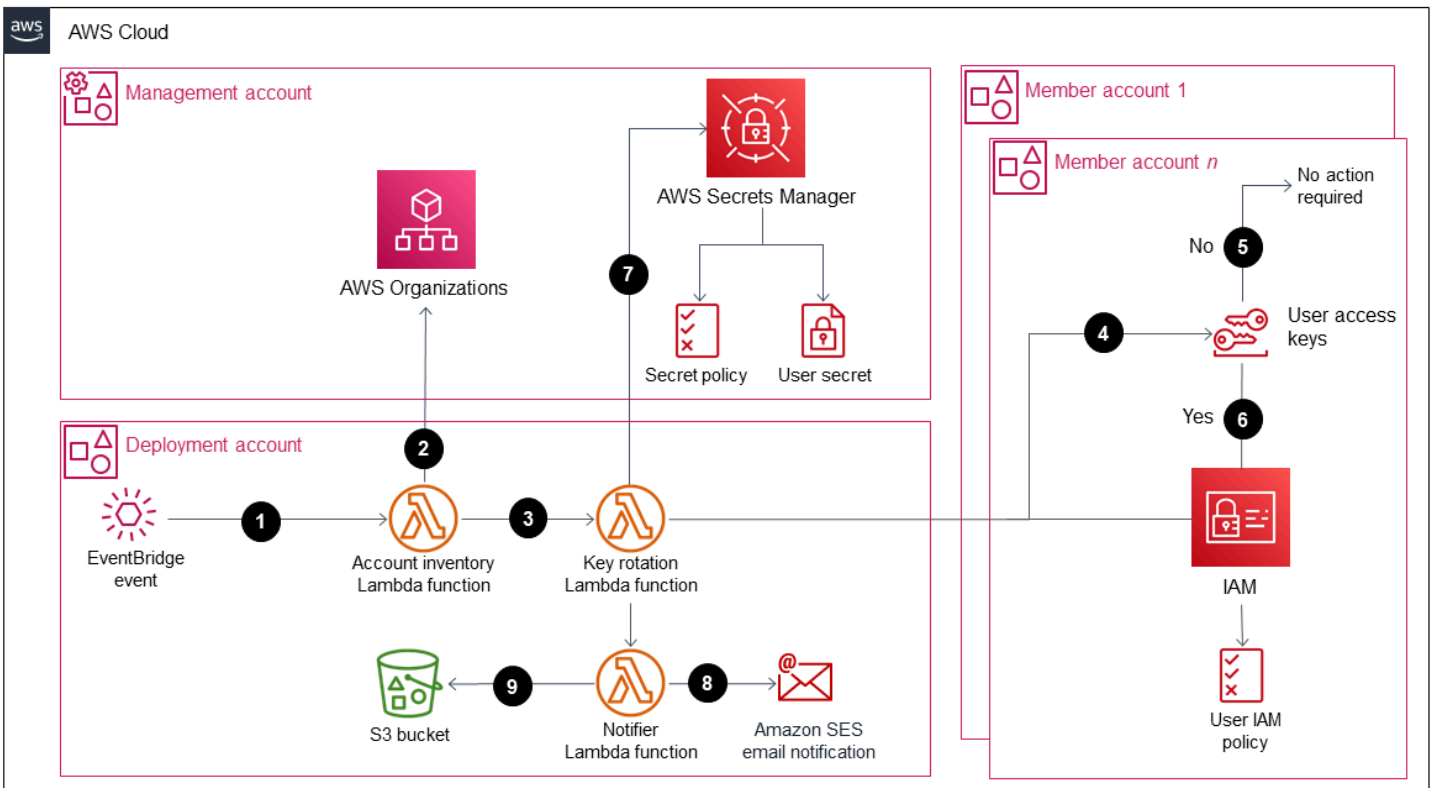

The diagrams show the following workflow:

1. An EventBridge event initiates an `account_inventory` Lambda function every 24 hours.
2. This Lambda function queries AWS Organizations for a list of all AWS account IDs, account names, and account emails.
3. The `account_inventory` Lambda function initiates an `access_key_auto_rotation` Lambda function for each AWS account ID and passes the metadata to it for additional processing.
4. The `access_key_auto_rotation` Lambda function uses an assumed IAM role to access the AWS account ID. The Lambda script runs an audit against all users and their IAM access keys in the account.
5. If the IAM access key's age hasn't exceeded the best practice threshold, the Lambda function takes no further action.
6. If the IAM access key's age has exceeded the best practice threshold, the `access_key_auto_rotation` Lambda function determines which rotation action to perform.
7. When action is required, the `access_key_auto_rotation` Lambda function creates and updates a secret in AWS Secrets Manager if a new key is generated. A resource-based policy is also created that allows only the specified IAM principal to access and retrieve the secret. In the case of option 1, the credentials are stored in Secrets Manager in the respective account. In the case of option 2 (if the `StoreSecretsInCentralAccount` flag is set to **True**), the credentials are stored in Secrets Manager in the management account.
8. A `notifier` Lambda function is initiated to notify the account's owner of the rotation activity. This function receives the AWS account ID, account name, account email, and the rotation actions that were performed.
9. The `notifier` Lambda function queries the deployment S3 bucket for an email template and dynamically updates it with the relevant activity metadata. The email is then sent to the account owner's email address.

#### Notes:

- This solution supports resiliency in multiple Availability Zones. However, it doesn't support resiliency in multiple AWS Regions. For support in multiple Regions, you can deploy the solution in the second Region and keep the key rotation EventBridge rule disabled. You can then enable the rule when you want to run the solution in the second Region.

- You can run this solution in audit mode. In audit mode, IAM access keys aren't modified, but an email is sent to notify users. To run the solution in audit mode, set the `DryRunFlag` flag to **True** when you run the key rotation template or in the environment variable for the `access_key_auto_rotation` Lambda function.

## Automation and scale

The CloudFormation templates that automate this solution are provided in the GitHub [IAM key rotation](#) repository and listed in the *Code* section. In AWS Organizations, you can use [CloudFormation StackSets](#) to deploy the `ASA-iam-key-auto-rotation-iam-assumed-roles.yaml` CloudFormation template in multiple accounts instead of deploying the solution individually to each member account.

## Tools

### AWS services

- [Amazon CloudWatch](#) helps you monitor the metrics of your AWS resources and the applications you run on AWS in real time.
- [AWS Identity and Access Management \(IAM\)](#) helps you securely manage access to your AWS resources by controlling who is authenticated and authorized to use them.
- [AWS Lambda](#) is a compute service that helps you run code without needing to provision or manage servers. It runs your code only when needed and scales automatically, so you pay only for the compute time that you use.
- [AWS Organizations](#) is an account management service that helps you consolidate multiple AWS accounts into an organization that you create and centrally manage.
- [AWS Secrets Manager](#) helps you replace hardcoded credentials in your code, including passwords, with an API call to Secrets Manager to retrieve the secret programmatically.
- [Amazon Simple Storage Service \(Amazon S3\)](#) is a cloud-based object storage service that helps you store, protect, and retrieve any amount of data.
- [Amazon Simple Email Service \(Amazon SES\)](#) helps you send and receive emails by using your own email addresses and domains.
- [Amazon Simple Notification Service \(Amazon SNS\)](#) helps you coordinate and manage the exchange of messages between publishers and clients, including web servers and email addresses.

- [Amazon Virtual Private Cloud \(Amazon VPC\)](#) helps you launch AWS resources into a virtual network that you've defined. This virtual network resembles a traditional network that you'd operate in your own data center, with the benefits of using the scalable infrastructure of AWS.
- [Amazon VPC endpoints](#) provide an interface to connect to services powered by AWS PrivateLink, including many AWS services. For each subnet that you specify from your VPC, an endpoint network interface is created in the subnet and assigned a private IP address from the subnet address range.

## Code

The required AWS CloudFormation templates, Python scripts, and runbook documentation are available in the GitHub [IAM key rotation](#) repository. The templates are deployed as follows.

Template	Deploy in	Notes
ASA-iam-key-auto-rotation-and-notifier-solution.yaml	Deployment account	This is the main template for the solution.
ASA-iam-key-auto-rotation-iam-assumed-roles.yaml	Single or multiple member accounts where you want to rotate the credentials	You can use CloudFormation stack sets to deploy this template in multiple accounts.
ASA-iam-key-auto-rotation-list-accounts-role.yaml	Central/management account	Use this template to keep an inventory of accounts in AWS Organizations.
ASA-iam-key-auto-rotation-vpc-endpoints.yaml	Deployment account	Use this template to automate the creation of endpoints only if you want to run the Lambda functions in a VPC (set the RunLambdaInVPC parameter to <b>True</b> in the main template).

# Epics

## Set up the solution

Task	Description	Skills required
Choose your deployment S3 bucket.	Sign in to the AWS Management Console for your account, open the <a href="#">Amazon S3 console</a> , and then choose the S3 bucket for your deployment. If you want to implement the solution for multiple accounts in AWS Organizations, sign in to the management account for your organization.	Cloud architect
Clone the repository.	Clone the GitHub <a href="#">IAM key rotation</a> repository to your local desktop.	Cloud architect
Upload the files to the S3 bucket.	Upload the cloned files to your S3 bucket. Use the following default folder structure to copy and paste all cloned files and directories: <code>asa/asa-iam-rotation</code>  <b>Note:</b> You can customize this folder structure in the CloudFormation templates.	Cloud architect
Modify the email template.	Modify the <code>iam-auto-key-rotation-enforcement.html</code> email template (located in the	Cloud architect



Task	Description	Skills required
	template folder) according to your requirements. Replace [Department Name Here] at the end of the template with your department's name.	

## Deploy the solution

Task	Description	Skills required
Launch the CloudFormation template for key rotation.	<ol style="list-style-type: none"> <li>1. Launch the <code>ASA-iam-key-auto-rotation-and-notifier-solution.yaml</code> template in the deployment account. For more information, see <a href="#">Selecting a stack template</a> in the CloudFormation documentation.</li> <li>2. Specify values for parameters, including: <ul style="list-style-type: none"> <li>• <b>CloudFormation S3 Bucket Name</b> (<code>S3BucketName</code>) – The name of the deployment S3 bucket that contains your Lambda code.</li> <li>• <b>CloudFormation S3 Bucket Prefix</b> (<code>S3BucketPrefix</code>) – The S3 bucket's prefix.</li> </ul> </li> </ol>	Cloud architect

Task	Description	Skills required
	<ul style="list-style-type: none"> <li>• <b>Assumed IAM Role Name</b> (IAMRoleName ) – The role name that the key-rotation Lambda function will assume to rotate the keys.</li> <li>• <b>IAM Execution Role Name</b> (ExecutionRoleName ) – The name of the IAM execution role that’s used by the key-rotation Lambda function.</li> <li>• <b>Inventory Execution Role Name</b> (InventoryExecutionRoleName ) – The name of the IAM execution role that’s used by the account_inventory Lambda function.</li> <li>• <b>Dry Run Flag (Audit Mode)</b> (DryRunFlag ) – Set to <b>True</b> to turn on audit mode (default). Set to <b>False</b> to turn on enforcement mode.</li> <li>• <b>Account to List Organization Accounts</b> (OrgListAccount ) – The account ID of the central/management account that will be used</li> </ul>	

Task	Description	Skills required
	<p>to list the accounts in the organization.</p> <ul style="list-style-type: none"> <li>• <b>List Accounts Role Name</b> (<code>OrgListRole</code>) <ul style="list-style-type: none"> <li>– The role name that will be used to list the accounts in the organization.</li> </ul> </li> <li>• <b>Secrets Store flag for central account</b> (<code>StoreSecretsInCentralAccount</code>) <ul style="list-style-type: none"> <li>– Set to <b>True</b> to store secrets in the central account. Set to <b>False</b> to store secrets in the respective account.</li> </ul> </li> <li>• <b>Regions to replicate the credentials</b> (<code>CredentialReplicationRegions</code>) <ul style="list-style-type: none"> <li>– The AWS Regions where you want to replicate the credentials (Secrets Manager), separated by commas; for example, <code>us-east-2,us-west-1,us-west-2</code>. Skip the Region where you are creating the stack.</li> </ul> </li> <li>• <b>Run Lambda in VPC</b> (<code>RunLambdaInVpc</code>) <ul style="list-style-type: none"> <li>– Set to <b>True</b> to run</li> </ul> </li> </ul>	

Task	Description	Skills required
	<p>Lambda functions in a specified VPC. You must have VPC endpoints created and attach a NAT gateway to the subnet that contains the Lambda function. For more information, see the <a href="#">re:Post article</a> that covers this option.</p> <ul style="list-style-type: none"><li>• <b>VPC Id for Lambda functions</b> (<code>VpcId</code>), <b>VPC CIDR for Security Group Rule</b> (<code>VpcCidr</code>), and <b>Subnet Id for Lambda functions</b> (<code>SubnetId</code>) – Provide information about the VPC, CIDR, and subnet if you set <code>RunLambdaInVpc</code> to <b>True</b>.</li><li>• <b>Admin Email Address</b> (<code>AdminEmailAddress</code>) – A valid email address to send notifications to.</li><li>• <b>AWS Organization ID</b> (<code>AWSOrgID</code>) – The unique ID of your organization. This ID begins with o- and is followed by 10-32 lowercase letters or digits.</li></ul>	

Task	Description	Skills required
	<ul style="list-style-type: none"><li>• <b>Email Template File name [Audit Mode]</b> (EmailTemplateAudit ) and <b>[Enforce Mode]</b> (EmailTemplateEnforce ) – The filename of the email HTML template to be sent out by the <code>notifier</code> module for audit mode and enforce mode.</li><li>• <b>SMTP User SSM Parameter Name</b> (SMTPUserParamName ) and <b>SMTP Password SSM Parameter Name</b> (SMTPPasswordParamName ) – User and password information for Simple Mail Transfer Protocol (SMTP).</li></ul>	

Task	Description	Skills required
Launch the CloudFormation template for assumed roles.	<ol style="list-style-type: none"><li data-bbox="591 226 1015 1360">1. In the <a href="#">AWS CloudFormation console</a>, launch the <code>ASA-iam-key-auto-rotation-iam-assumed-roles.yaml</code> template for each account where you want to rotate keys. If you have more than one account, you can deploy the main CloudFormation template in your management account as a stack and deploy the <code>ASA-iam-key-auto-rotation-iam-assumed-roles.yaml</code> template with CloudFormation stack sets to all required accounts. For more information, see <a href="#">Working with AWS CloudFormation StackSets</a> in the CloudFormation documentation.</li><li data-bbox="591 1381 1015 1856">2. Specify values for the following parameters:<ul style="list-style-type: none"><li data-bbox="630 1493 1015 1856">• <b>Assumed IAM Role Name</b> (<code>IAMRoleName</code>) – IAM role name that will be assumed by the Lambda <code>access_key_auto_rotation</code> function. You can keep the default value.</li></ul></li></ol>	Cloud architect

Task	Description	Skills required
	<ul style="list-style-type: none"><li>• <b>IAM Execution Role Name</b> (Execution RoleName ) – The IAM role that will assume the sub-account role to run the Lambda function.</li><li>• <b>Primary AWS Account ID</b> (PrimaryAccountID ) – The AWS account ID where the main template will be deployed.</li><li>• <b>IAM Exemption Group</b> (IAMExemptionGroup ) – The IAM group name being used to facilitate IAM accounts that you want to exclude from automatic key rotation.</li></ul>	

Task	Description	Skills required
<p>Launch the CloudFormation template for account inventory.</p>	<ol style="list-style-type: none"> <li>1. Launch the <code>ASA-iam-key-auto-rotation-list-accounts-role.yaml</code> template in the management/central account</li> <li>2. Specify values for the following parameters: <ul style="list-style-type: none"> <li>• <b>Assumed IAM Role Name</b> (<code>IAMRoleName</code>) <ul style="list-style-type: none"> <li>– IAM role name that the Lambda <code>access_key_auto_rotation</code> function will assume.</li> </ul> </li> <li>• <b>IAM Execution Role Name for Account Lambda</b> (<code>AccountExecutionRoleName</code>) <ul style="list-style-type: none"> <li>– The name of the IAM role that the Lambda <code>notifier</code> function will assume.</li> </ul> </li> <li>• <b>IAM Execution Role Name for rotation Lambda</b> (<code>RotationExecutionRoleName</code>) <ul style="list-style-type: none"> <li>– The name of the IAM role that the Lambda <code>access_key_auto_rotation</code> function will assume.</li> </ul> </li> <li>• <b>Primary AWS Account ID</b> (<code>PrimaryAc</code></li> </ul> </li> </ol>	<p>Cloud architect</p>



Task	Description	Skills required
	<p>countID ) – The AWS account ID where the main template will be deployed.</p>	
<p>Launch the CloudFormation template for VPC endpoints.</p>	<p>This task is optional.</p> <ol style="list-style-type: none"> <li>1. Launch the <code>ASA-iam-key-auto-rotation-vpc-endpoints.yaml</code> template in the deployment account.</li> <li>2. Specify values for the following parameters: <ul style="list-style-type: none"> <li>• <b>VPC ID</b> (pVpcId), <b>Subnet Id</b> (pSubnetId ), and <b>CIDR range for VPC</b> (pVPCCidr) – Provide information about the VPC, CIDR, and subnet.</li> <li>• Set the parameter for each VPC endpoint to <b>True</b>. If you already have endpoints, you can choose <b>False</b>.</li> </ul> </li> </ol>	<p>Cloud architect</p>

## Related resources

- [Security best practices in IAM](#) (IAM documentation)
- [AWS Organizations and service-linked roles](#) (AWS Organizations documentation)
- [Selecting a stack template](#) (CloudFormation documentation)
- [Working with AWS CloudFormation StackSets](#) (CloudFormation documentation)



# Automatically validate and deploy IAM policies and roles in an AWS account by using CodePipeline, IAM Access Analyzer, and AWS CloudFormation macros

Created by Helton Ribeiro (AWS) and Guilherme Simoes (AWS)

**Code repository:** [IAM roles pipeline](#)

**Environment:** PoC or pilot

**Technologies:** Security, identity, compliance; DevOps

**AWS services:** AWS CloudFormation; AWS CodeBuild; AWS CodeCommit; AWS CodePipeline; AWS Lambda; AWS SAM

## Summary

This pattern describes the steps and provides code to create a deployment pipeline that allows your development teams to create AWS Identity and Access Management (IAM) policies and roles in your Amazon Web Services (AWS) accounts. This approach helps your organization reduce overhead for your operational teams and speed up the deployment process. It also helps your developers to create IAM roles and policies that are compatible with your existing governance and security controls.

This pattern's approach uses [AWS Identity and Access Management Access Analyzer](#) to validate the IAM policies that you want to attach to IAM roles and uses AWS CloudFormation to deploy the IAM roles. However, instead of directly editing the AWS CloudFormation template file, your development team creates JSON-formatted IAM policies and roles. An AWS CloudFormation macro transforms these JSON-formatted policy files into AWS CloudFormation IAM resource types before beginning the deployment.

The deployment pipeline (RolesPipeline) has source, validation, and deployment stages. During the source stage, your development team pushes the JSON files that contain the definition of the IAM roles and policies to an AWS CodeCommit repository. AWS CodeBuild then runs a script to validate those files and copies them to an Amazon Simple Storage Service (Amazon S3) bucket.

Because your development teams don't have direct access to the AWS CloudFormation template file stored in a separate S3 bucket, they must follow the JSON file creation and validation process.

Finally, during the deployment phase, AWS CodeDeploy uses an AWS CloudFormation stack to update or delete the IAM policies and roles in an account.

**Important:** This pattern's workflow is a proof of concept (POC) and we recommend that you only use it in a test environment. If you want to use this pattern's approach in a production environment, see [Security best practices in IAM](#) in the IAM documentation and make the required changes to your IAM roles and AWS services.

## Prerequisites and limitations

### Prerequisites

- An active AWS account.
- A new or existing S3 bucket for the RolesPipeline pipeline. Make sure that the access credentials you're using have permissions to upload objects to this bucket.
- AWS Command Line Interface (AWS CLI), installed and configured. For more information about this, see [Installing, updating, and uninstalling the AWS CLI](#) in the AWS CLI documentation.
- AWS Serverless Application Model (AWS SAM) CLI, installed and configured. For more information about this, see [Installing the AWS SAM CLI](#) in the AWS SAM documentation.
- Python 3, installed on your local machine. For more information about this, see the [Python documentation](#).
- A Git client, installed and configured.
- The GitHub IAM roles pipeline repository, cloned to your local machine.
- Existing JSON-formatted IAM policies and roles. For more information about this, see the [ReadMe](#) file in the Github IAM roles pipeline repository.
- Your developer team must not have permissions to edit this solution's AWS CodePipeline, CodeBuild, and CodeDeploy resources.

### Limitations

- This pattern's workflow is a proof of concept (POC) and we recommend that you only use it in a test environment. If you want to use this pattern's approach in a production environment, see [Security best practices in IAM](#) in the IAM documentation and make the required changes to your IAM roles and AWS services.

## Architecture

The following diagram shows you how to automatically validate and deploy IAM roles and policies to an account by using CodePipeline, IAM Access Analyzer, and AWS CloudFormation macros.

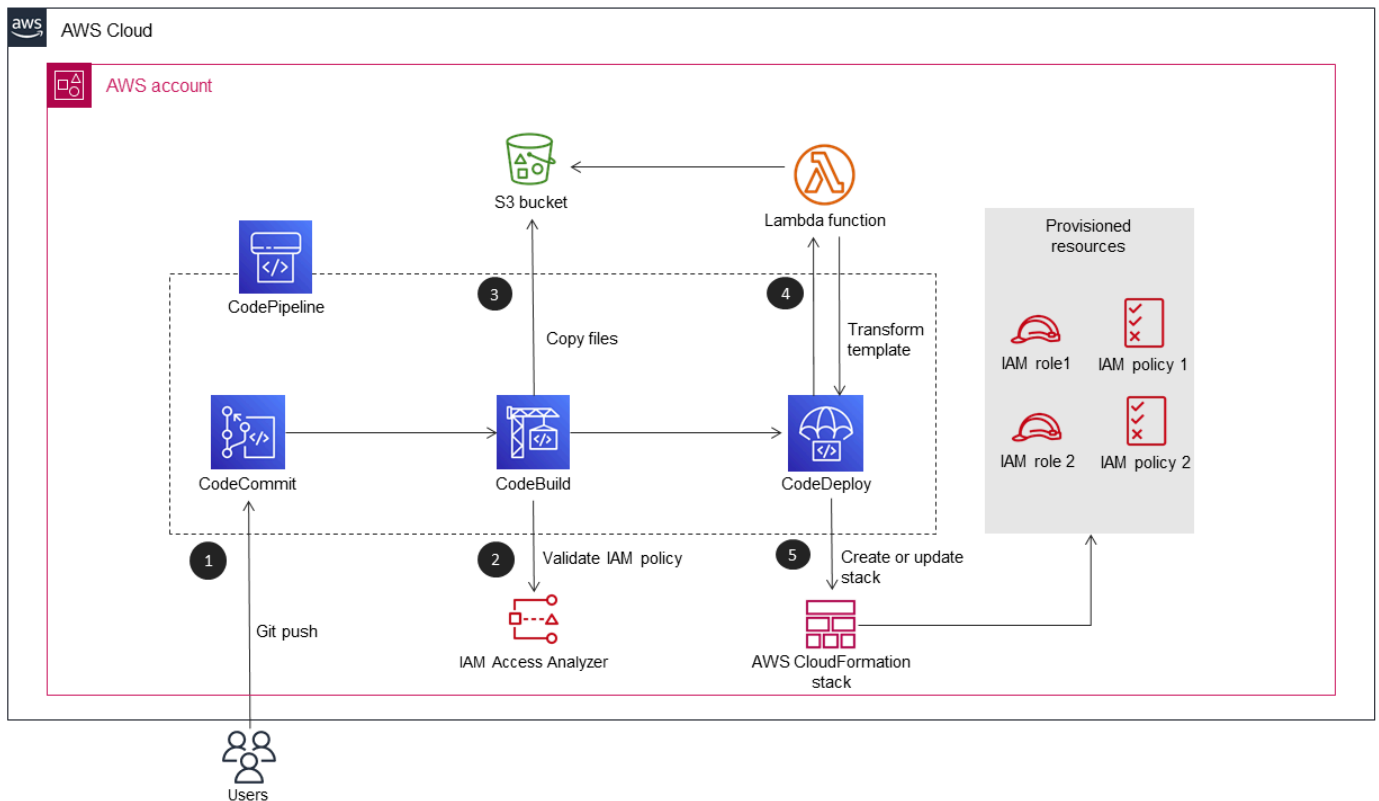

The diagram shows the following workflow:

1. A developer writes JSON files that contain the definitions for the IAM policies and roles. The developer pushes the code to a CodeCommit repository and CodePipeline then initiates the RolesPipeline pipeline.
2. CodeBuild validates the JSON files by using IAM Access Analyzer. If there are any security or error-related findings, the deployment process is stopped.
3. If there are no security or error-related findings, the JSON files are sent to the RolesBucket S3 bucket.
4. An AWS CloudFormation macro implemented as an AWS Lambda function then reads the JSON files from the RolesBucket bucket and transforms them into AWS CloudFormation IAM resources types.
5. A predefined AWS CloudFormation stack installs, updates, or deletes the IAM policies and roles in the account.

## Automation and scale

AWS CloudFormation templates that automatically deploy this pattern are provided in the GitHub [IAM roles pipeline](#) repository.

## Tools

- [AWS Command Line Interface \(AWS CLI\)](#) is an open-source tool that helps you interact with AWS services through commands in your command-line shell.
- [AWS Identity and Access Management \(IAM\)](#) helps you securely manage access to your AWS resources by controlling who is authenticated and authorized to use them.
- [IAM Access Analyzer](#) helps you identify the resources in your organization and accounts, such as S3 buckets or IAM roles, that are shared with an external entity. This helps you to identify unintended access to your resources and data.
- [AWS Serverless Application Model \(AWS SAM\)](#) is an open-source framework that helps you build serverless applications in the AWS Cloud.

## Code

The source code and templates for this pattern are available in the GitHub [IAM roles pipeline](#) repository.

## Epics

### Clone the repository

Task	Description	Skills required
Clone the sample repository.	Clone the GitHub <a href="#">IAM roles pipeline</a> repository to your local machine.	App developer, General AWS

## Deploy the RolesPipeline pipeline

Task	Description	Skills required
Deploy the pipeline.	<ol style="list-style-type: none"><li data-bbox="591 327 997 457">1. Navigate to the directory that contains the cloned repository.</li><li data-bbox="591 485 1013 804">2. Run the <code>make deploy bucket=&lt;bucket_name&gt;</code> command. <b>Important</b> : you must replace <code>&lt;bucket_name&gt;</code> with the bucket name for your existing S3 bucket.</li><li data-bbox="591 831 1005 1056">3. Run the <code>aws codepipeline get-pipeline -name RolesPipeline</code> command to check if your deployment is successful.</li></ol>	App developer, General AWS
Clone the pipeline's repository.	<ol style="list-style-type: none"><li data-bbox="591 1102 992 1327">1. The RolesPipeline AWS CloudFormation stack creates the <code>roles-pipeline-repo</code> CodeCommit repository.</li><li data-bbox="591 1354 1019 1808">2. Sign in to the AWS Management Console, open the AWS CodeCommit console, and then copy the CodeCommit repository's URL to clone it to your local machine. For more information about this, see <a href="#">Connect to an AWS CodeCommit repository</a></li></ol>	App developer, General AWS

Task	Description	Skills required
	in the AWS CodeCommit documentation.	

## Test the RolesPipeline pipeline

Task	Description	Skills required
<p>Test the RolesPipeline pipeline with valid IAM policies and roles.</p>	<ol style="list-style-type: none"> <li>1. Create JSON files for your IAM policies and roles. You can use the samples in the <code>role-example</code> directory from the GitHub IAM roles pipeline repository.</li> <li>2. Define your IAM policies and roles with the required configurations. <b>Important</b> : Make sure that you follow the format described in the ReadMe file from the GitHub IAM roles pipeline repository.</li> <li>3. Push the modifications into the <code>roles-pipeline-repo</code> CodeCommit repository.</li> <li>4. Verify the implementation of the RolesPipeline pipeline.</li> <li>5. Make sure that the IAM policies and roles are correctly deployed in the account.</li> </ol>	<p>App developer, General AWS</p>



Task	Description	Skills required
	<p>6. Validate if there is a permissions boundary associated to the IAM policies or roles. For more information about this, see <a href="#">Permissions boundaries for IAM entities</a> in the IAM documentation.</p>	
<p>Test the RolesPipeline pipeline with invalid IAM policies and roles.</p>	<ol style="list-style-type: none"> <li>1. Modify the <code>roles-pipeline-repo</code> CodeCommit repository and include invalid IAM roles or policies. For example, you can use an action that doesn't exist or an invalid IAM policy version.</li> <li>2. Verify the pipeline implementation. IAM Access Analyzer stops the pipeline during the validation stage if it detects invalid IAM policies or roles.</li> </ol>	<p>App developer, General AWS</p>

## Clean up your resources

Task	Description	Skills required
<p>Prepare for cleanup.</p>	<p>Empty the S3 buckets and then run the <code>destroy</code> command.</p>	<p>App developer, General AWS</p>

Task	Description	Skills required
Delete the RolesStack stack.	<ol style="list-style-type: none"> <li>1. The RolesPipeline pipeline creates a RolesStack AWS CloudFormation stack that deploys the IAM policies and roles. You must delete this stack before deleting the RolesPipeline pipeline.</li> <li>2. Sign in to the AWS Management Console, open the AWS CloudFormation console, and then choose the RolesStack stack and choose <b>Delete</b>.</li> </ol>	App developer, General AWS
Delete the RolesPipeline stack.	To delete the RolesPipeline AWS CloudFormation stack, follow the instructions from the <a href="#">ReadMe</a> file in the Github IAM roles pipeline repository.	App developer, General AWS

## Related resources

- [IAM Access Analyzer - Policy validation](#) (AWS News Blog)
- [Using AWS CloudFormation macros to perform custom processing on templates](#) (AWS CloudFormation documentation)
- [Building Lambda functions with Python](#) (AWS Lambda documentation)

# Bidirectionally integrate AWS Security Hub with Jira software

Created by Joaquin Manuel Rinaudo (AWS)

<b>Code repository:</b> <a href="#">Security Hub to JIRA Integration</a>	<b>Environment:</b> PoC or pilot	<b>Technologies:</b> Security, identity, compliance
<b>Workload:</b> All other workloads	<b>AWS services:</b> AWS Lambda; AWS Security Hub; Amazon CloudWatch	

## Summary

This solution supports a bidirectional integration between AWS Security Hub and Jira. Using this solution, you can automatically and manually create and update JIRA tickets from Security Hub findings. Security teams can use this integration to notify developer teams of severe security findings that require action.

The solution allows you to:

- Select which Security Hub controls automatically create or update tickets in Jira.
- In the Security Hub console, use Security Hub custom actions to manually escalate tickets in Jira.
- Automatically assign tickets in Jira based on the AWS account tags defined in AWS Organizations. If this tag is not defined, a default assignee is used.
- Automatically suppress Security Hub findings that are marked as false positive or accepted risk in Jira.
- Automatically close a Jira ticket when its related finding is archived in Security Hub.
- Reopen Jira tickets when Security Hub findings reoccur.

## Jira workflow

The solution uses a custom Jira workflow that allows developers to manage and document risks. As the issue moves through the workflow, bidirectional integration ensures that the status of the Jira ticket and Security Hub finding is synchronized across the workflows in both services. This

workflow is a derivative of *SecDevOps Risk Workflow* by Dinis Cruz, licensed under [CC BY 4.0](#). We recommend adding a Jira workflow condition so that only members of your security team can change the ticket status.

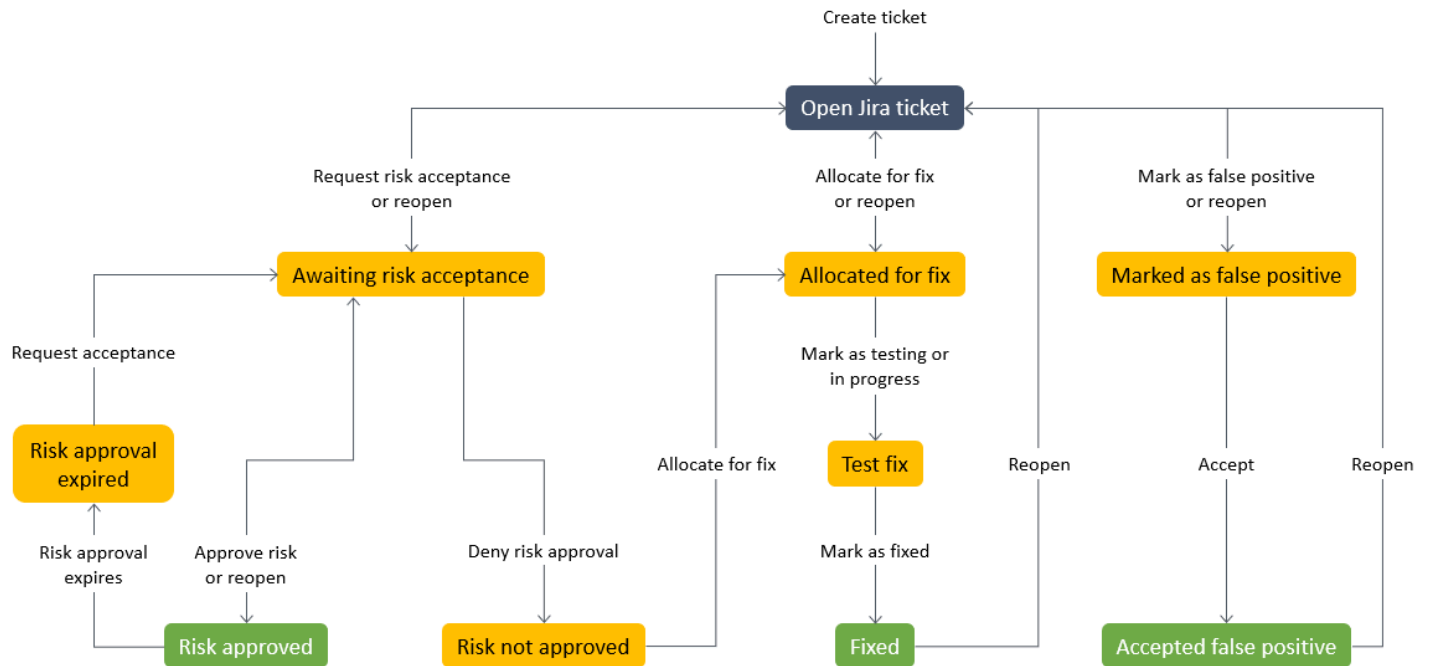

For an example of a Jira ticket automatically generated by this solution, see the [Additional information](#) section of this pattern.

## Prerequisites and limitations

### Prerequisites

- If you want to deploy this solution across a multi-account AWS environment:
  - Your multi-account environment is active and managed by AWS Organizations.
  - Security Hub is enabled on your AWS accounts.
  - In AWS Organizations, you have designated a Security Hub administrator account.
  - You have a cross-account IAM role that has `AWSOrganizationsReadOnlyAccess` permissions to the AWS Organizations management account.
  - (Optional) You have tagged your AWS accounts with `SecurityContactID`. This tag is used to assign Jira tickets to the defined security contacts.
- If you want to deploy this solution within a single AWS account:
  - You have an active AWS account.

- Security Hub is enabled on your AWS account.
- A Jira Server instance

**Important:** This solution supports use of Jira Cloud. However, Jira Cloud does not support importing XML workflows, so you need to manually re-create the workflow in Jira.

- Administrator permissions in Jira
- One of the following Jira tokens:
  - For Jira Enterprise, a personal access token (PAT). For more information, see [Using Personal Access Tokens](#) (Atlassian support).
  - For Jira Cloud, a Jira API token. For more information, see [Manage API tokens](#) (Atlassian support).

## Architecture

This section illustrates the architecture of the solution in various scenarios, such as when the developer and security engineer decide to accept the risk or decide to fix the issue.

### *Scenario 1: Developer addresses the issue*

1. Security Hub generates a finding against a specified security control, such as those in the [AWS Foundational Security Best Practices standard](#).
2. An Amazon CloudWatch event associated with the finding and the CreateJIRA action initiates an AWS Lambda function.
3. The Lambda function uses its configuration file and the finding's GeneratorId field to evaluate whether it should escalate the finding.
4. The Lambda function determines the finding should be escalated, it obtains the SecurityContactID account tag from AWS Organizations in the AWS management account. This ID is associated with the developer and is used as the assignee ID for the Jira ticket.
5. The Lambda function uses the credentials stored in AWS Secrets Manager to create a ticket in Jira. Jira notifies the developer.
6. The developer addresses the underlying security finding and, in Jira, changes the status of the ticket to TEST FIX.
7. Security Hub updates the finding as ARCHIVED, and a new event is generated. This event causes the Lambda function to automatically close the Jira ticket.

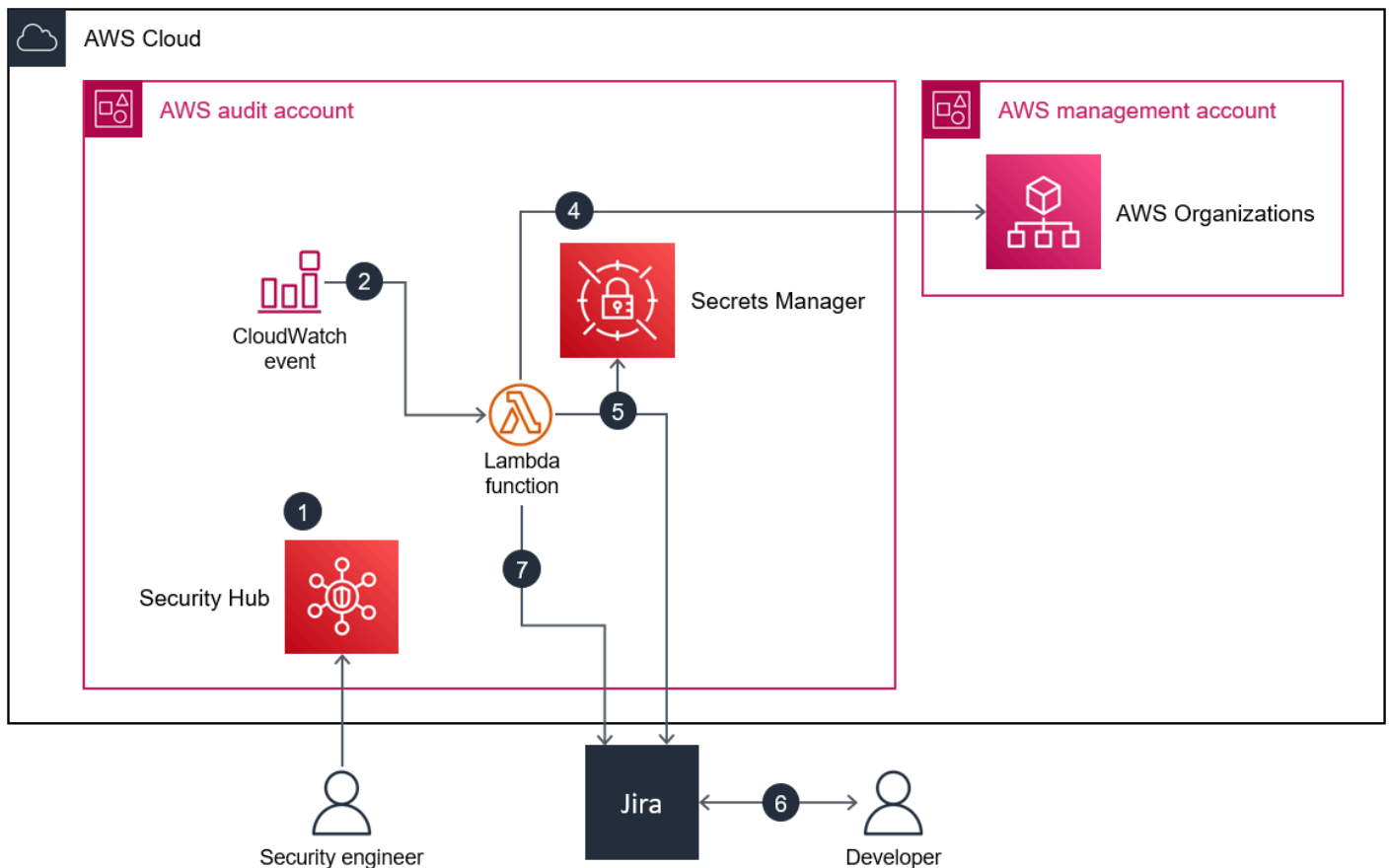

### Scenario 2: Developer decides to accept the risk

1. Security Hub generates a finding against a specified security control, such as those in the [AWS Foundational Security Best Practices standard](#).
2. A CloudWatch event associated with the finding and the CreateJIRA action initiates a Lambda function.
3. The Lambda function uses its configuration file and the finding's `GeneratorId` field to evaluate whether it should escalate the finding.
4. The Lambda function determines the finding should be escalated, it obtains the `SecurityContactID` account tag from AWS Organizations in the AWS management account. This ID is associated with the developer and is used as the assignee ID for the Jira ticket.
5. The Lambda function uses the credentials stored in Secrets Manager to create a ticket in Jira. Jira notifies the developer.
6. The developer decides to accept the risk and, in Jira, changes the status of the ticket to **AWAITING RISK ACCEPTANCE**.

7. The security engineer reviews the request and finds the business justification appropriate. The security engineer changes the status of the Jira ticket to ACCEPTED RISK. This closes the Jira ticket.
8. A CloudWatch daily event initiates the refresh Lambda function, which identifies closed JIRA tickets and updates their related Security Hub findings as SUPPRESSED.

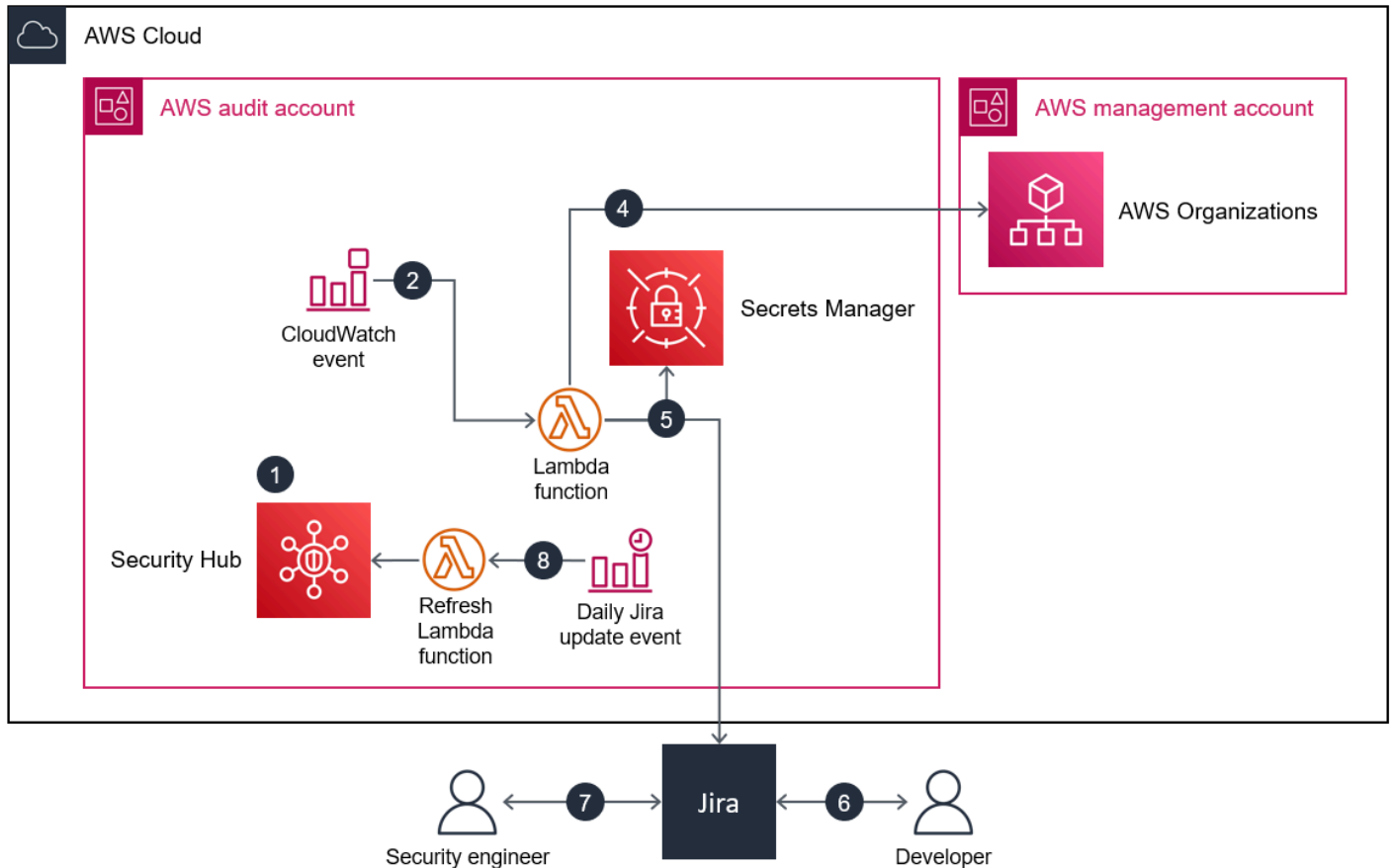

## Tools

- [AWS CloudFormation](#) helps you set up AWS resources, provision them quickly and consistently, and manage them throughout their lifecycle across AWS accounts and Regions.
- [Amazon CloudWatch Events](#) helps you monitor system events for your AWS resources by using rules to match events and route them to functions or streams.
- [AWS Lambda](#) is a compute service that helps you run code without needing to provision or manage servers. It runs your code only when needed and scales automatically, so you pay only for the compute time that you use.

- [AWS Organizations](#) is an account management service that helps you consolidate multiple AWS accounts into an organization that you create and centrally manage.
- [AWS Secrets Manager](#) helps you replace hardcoded credentials in your code, including passwords, with an API call to Secrets Manager to retrieve the secret programmatically.
- [AWS Security Hub](#) provides a comprehensive view of your security state in AWS. It also helps you check your AWS environment against security industry standards and best practices.

## Code repository

The code for this pattern is available on GitHub, in the [aws-securityhub-jira-software-integration](#) repository. It includes the sample code and Jira workflow for this solution.

## Epics

### Configure Jira

Task	Description	Skills required
Import the workflow.	As an administrator in Jira, import the <code>issue-workflow.xml</code> file to your Jira Server instance. This file can be found in the <a href="#">aws-securityhub-jira-software-integration</a> repository in GitHub. For instructions, see <a href="#">Using XML to create a workflow</a> (Jira documentation).	Jira administrator
Activate and assign the workflow.	Workflows are inactive until you assign them to a workflow scheme. You then assign the workflow scheme to a project.  1. For your project, make sure you have identified	Jira administrator



Task	Description	Skills required
	<p>an issue type scheme for the project. You can create a new issue type or select from an existing one, such as Bug.</p> <ol style="list-style-type: none"> <li>2. Assign the imported workflow to a workflow scheme according to the instructions in <a href="#">Activate a workflow</a> (Jira documentation).</li> <li>3. Assign the workflow scheme to a project according to the instructions in <a href="#">Associate a workflow scheme with a project</a> (Jira documentation).</li> </ol>	

## Set up the solution parameters

Task	Description	Skills required
Configure the solution parameters.	<ol style="list-style-type: none"> <li>1. In the <b>conf</b> folder, open <code>params_prod.shfile</code>.</li> <li>2. Provide values for the following parameters: <ul style="list-style-type: none"> <li>• <code>ORG_ACCOUNT_ID</code> <ul style="list-style-type: none"> <li>– The account ID for your AWS Organizations management account. The solution reads account tags and assigns tickets to the specific</li> </ul> </li> </ul> </li> </ol>	AWS systems administrator

Task	Description	Skills required
	<p>security contacts defined in those AWS account tags.</p> <ul style="list-style-type: none"><li>• <b>ORG_ROLE</b> – The name of the IAM role used to access the AWS Organization management account. This role must have <code>OrganizationsReadOnlyAccess</code> permissions.</li><li>• <b>EXTERNAL_ID</b> – An optional parameter if you are using an external ID to assume the IAM role defined in <b>ORG_ROLE</b>. For more information, see <a href="#">How to use an external ID</a> (IAM documentation).</li><li>• <b>JIRA_DEFAULT_ASSIGNEE</b> – This is the Jira ID for default assignee for all Security Issues. This default assigned is used in case account is not tagged properly or role cannot be assumed.</li><li>• <b>JIRA_INSTANCE</b> – The HTTPS address for your Jira server in the following format:</li></ul>	

Task	Description	Skills required
	<p>team-&lt;team-id&gt;.atl lassian.net/</p> <ul style="list-style-type: none"><li>• JIRA_PROJECT_KEY – The name of the Jira project key used to create tickets, such as SEC or TEST. This project must already exist in Jira.</li><li>• ISSUE_TYPE – The name of the issue type scheme assigned to the project in Jira, such as Bug or Security Issue.</li><li>• REGIONS – List of AWS Region codes where you want to deploy this solution, such as eu-west-1 .</li></ul> <p>3. Save and close the solution parameter file.</p>	

Task	Description	Skills required
Identify the findings you want to automate.	<ol style="list-style-type: none"><li>1. Open the Security Hub console at <a href="https://console.aws.amazon.com/securityhub/">https://console.aws.amazon.com/securityhub/</a></li><li>2. In the Security Hub navigation pane, choose <b>Findings</b>.</li><li>3. Choose the finding title.</li><li>4. Choose the finding ID. This displays the complete JSON for the finding.</li><li>5. In the JSON, copy the string in the <code>GeneratorId</code> field. This value is in <a href="#">AWS Security Finding Format (ASFF)</a>. For example, <code>aws-foundational-security-best-practices/v/1.0.0/S3.1</code> corresponds to findings from the security control <i>S3.1 S3 Block Public Access setting should be enabled</i>.</li><li>6. Repeat these steps until you have copied all of the <code>GeneratorId</code> values for any findings you want to automate.</li></ol>	

Task	Description	Skills required
Add the findings to the configuration file.	<ol style="list-style-type: none"><li>1. In <b>src/code</b>, open the <code>config.jsonconfig</code> file.</li><li>2. Paste the <code>GeneratorID</code> values you retrieved in the previous story into the <code>default</code> parameter, and use commas to separate each ID.</li><li>3. Save and close the configuration file.</li></ol> <p>The following code example shows automating the <code>aws-foundational-security-best-practices/v/1.0.0/SNS.1</code> and <code>aws-foundational-security-best-practices/v/1.0.0/S3.1</code> findings.</p> <pre data-bbox="594 1293 1029 1822">{   "Controls" : {     "eu-west-1": [       "arn:aws:securityhub::rule set/cis-aws-founda tions-benchmark/v/ 1.2.0/rule/1.22"     ],     "default": [ aws-foundational- security-best-pra ctices/v/1.0.0/SNS.1,</pre>	AWS systems administrator

Task	Description	Skills required
	<pre>aws-foundational- security-best-p ractices/v/1.0.0/S3.1     ]     } }</pre> <p><b>Note:</b> You can choose to automate different findings for each AWS Region. A good practice to help prevent duplicated findings is to select a single Region to automate creation of IAM-related controls.</p>	

## Deploy the integration

Task	Description	Skills required
Deploy the integration.	<p>In a command line terminal, enter the following command:</p> <pre>./deploy.sh prod</pre>	AWS systems administrator
Upload Jira credentials to AWS Secrets Manager.	<ol style="list-style-type: none"> <li>1. Open the Secrets Manager console at <a href="https://console.aws.amazon.com/secretsmanager/">https://console.aws.amazon.com/secretsmanager/</a>.</li> <li>2. Under Secrets, choose <b>Store a new secret</b>.</li> <li>3. For <b>Secret type</b>, choose <b>Other type of secret</b>.</li> </ol>	AWS systems administrator

Task	Description	Skills required
	<p>4. If you are using Jira Enterprise, for <b>Key/value pairs</b>, do the following:</p> <ul style="list-style-type: none"><li>• In the first row, enter <code>auth</code> in the key box, and then enter <code>token_auth</code> in the value box.</li><li>• Add a second row, enter <code>token</code> in the key box, and then enter your personal access token in the value box.</li></ul> <p>If you are using Jira Cloud, for <b>Key/value pairs</b>, do the following:</p> <ul style="list-style-type: none"><li>• In the first row, enter <code>auth</code> in the key box, and then enter <code>basic_auth</code> in the value box.</li><li>• Add a second row, enter <code>token</code> in the key box, and then enter your API token in the value box.</li><li>• Add a third row, enter <code>email</code> in the key box, and then enter your email address in the value box.</li></ul> <p>5. Choose <b>Next</b>.</p> <p>6. For <b>Secret name</b>, enter <code>Jira-Token</code> , and then at the bottom of the page, choose <b>Next</b>.</p>	

Task	Description	Skills required
	<ol style="list-style-type: none"><li data-bbox="591 212 1003 436">7. On the Secret rotation page, keep <b>Disable automatic rotation</b>, and then at the bottom of the page, choose <b>Next</b>.</li><li data-bbox="591 457 1003 590">8. On the Review page, review the secret details, and then choose <b>Store</b>.</li></ol>	



Task	Description	Skills required
Create the Security Hub custom action.	<ol style="list-style-type: none"><li>For each AWS Region, in the AWS Command Line Interface (AWS CLI), use the <a href="#">create-action-target</a> command to create a Security Hub custom action named CreateJiraIssue . <pre>aws securityhub   create-action-target   --name "CreateJiraIssue" \   --description   "Create ticket in   JIRA" \   --id "CreateJiraIssue"   --region \$&lt;aws-region&gt;</pre></li><li>Open the Security Hub console at <a href="https://console.aws.amazon.com/securityhub/">https://console.aws.amazon.com/securityhub/</a>.</li><li>In the Security Hub navigation pane, choose <b>Findings</b>.</li><li>In the list of findings, select the findings you want to escalate.</li><li>In the <b>Actions</b> menu, choose CreateJiraIssue .</li></ol>	AWS systems administrator

## Related resources

- [AWS Service Management Connector for Jira Service Management](#)
- [AWS Foundational Security Best Practices standard](#)

## Additional information

### Example of a Jira ticket

When a specified Security Hub finding occurs, this solution automatically creates a Jira ticket. The ticket includes the following information:

- **Title** – The title identifies the security issue in the following format:

```
AWS Security Issue :: <AWS account ID> :: <Security Hub finding title>
```

- **Description** – The description section of the ticket describes the security control associated with the finding, includes a link to the finding in the Security Hub console, and provides a short description of how to handle the security issue in the Jira workflow.

The following is an example of an automatically generated Jira ticket.

<b>Title</b>	AWS Security Issue :: 012345678912 :: Lambda.1 Lambda function policies should prohibit public access.
<b>Description</b>	<p><b>What is the problem?</b> We detected a security finding within the AWS account 012345678912 you are responsible for.</p> <p>This control checks whether the AWS Lambda function policy attached to the Lambda resource prohibits public access. If the Lambda function policy allows public access, the control fails.</p> <p>&lt;Link to Security Hub finding&gt;</p>

## What do I need to do with the ticket?

- Access the account and verify the configuration. Acknowledge working on ticket by moving it to "Allocated for Fix". Once fixed, moved to test fix so Security validates the issue is addressed.
- If you think risk should be accepted, move it to "Awaiting Risk acceptance". This will require review by a Security engineer.
- If you think is a false positive, transition it to "Mark as False Positive". This will get reviewed by a Security engineer and reopened/closed accordingly.

# Build a pipeline for hardened container images using EC2 Image Builder and Terraform

Created by Mike Saintcross (AWS) and Andrew Ranes (AWS)

<b>Code repository:</b> <a href="#">Terraform EC2 Image Builder Container Hardening Pipeline</a>	<b>Environment:</b> Production	<b>Source:</b> Packer, Chef, or Pure Ansible
<b>Target:</b> EC2 Image Builder	<b>R Type:</b> Re-architect	<b>Workload:</b> Open-source
<b>Technologies:</b> Security, identity, compliance; DevOps	<b>AWS services:</b> Amazon EC2 Container Registry; EC2 Image Builder	

## Summary

This pattern builds an [EC2 Image Builder pipeline](#) that produces a hardened [Amazon Linux 2](#) base container image. Terraform is used as an infrastructure as code (IaC) tool to configure and provision the infrastructure that is used to create hardened container images. The recipe helps you deploy a Docker-based Amazon Linux 2 container image that has been hardened according to Red Hat Enterprise Linux (RHEL) 7 STIG Version 3 Release 7 – Medium. (See [STIG-Build-Linux-Medium version 2022.2.1](#) in the *Linux STIG components* section of the EC2 Image Builder documentation.) This is referred to as a *golden* container image.

The build includes two [Amazon EventBridge rules](#). One rule starts the container image pipeline when the [Amazon Inspector finding](#) is **High** or **Critical** so that non-secure images are replaced. This rule requires both Amazon Inspector and Amazon Elastic Container Registry (Amazon ECR) [enhanced scanning](#) to be enabled. The other rule sends notifications to an Amazon Simple Queue Service (Amazon SQS) [queue](#) after a successful image push to the Amazon ECR repository, to help you use the latest container images.

**Note:** Amazon Linux 2 is nearing end of support. For more information, see the [Amazon Linux 2 FAQs](#).

# Prerequisites and limitations

## Prerequisites

- An [AWS account](#) that you can deploy the infrastructure in.
- [AWS Command Line Interface \(AWS CLI\) installed](#) for setting your AWS credentials for local deployment.
- Terraform [downloaded](#) and set up by following the [instructions](#) in the Terraform documentation.
- [Git](#) (if you're provisioning from a local machine).
- A [role](#) within the AWS account that you can use to create AWS resources.
- All variables defined in the [.tfvars](#) file. Or, you can define all variables when you apply the Terraform configuration.

## Limitations

- This solution creates an Amazon Virtual Private Cloud (Amazon VPC) infrastructure that includes a [NAT gateway](#) and an [internet gateway](#) for internet connectivity from its private subnet. You cannot use [VPC endpoints](#), because the [bootstrap process by AWS Task Orchestrator and Executor \(AWSTOE\)](#) installs AWS CLI version 2 from the internet.

## Product versions

- Amazon Linux 2
- AWS CLI version 1.1 or later

# Architecture

## Target technology stack

This pattern creates 43 resources, including:

- Two Amazon Simple Storage Service (Amazon S3) [buckets](#): one for the pipeline component files and one for server access and Amazon VPC flow logs
- An [Amazon ECR repository](#)
- A virtual private cloud (VPC) that contains a public subnet, a private subnet, route tables, a NAT gateway, and an internet gateway

- An EC2 Image Builder pipeline, recipe, and components
- A container image
- An AWS Key Management Service (AWS KMS) [key](#) for image encryption
- An SQS queue
- Three roles: one to run the EC2 Image Builder pipeline, one instance profile for EC2 Image Builder, and one for EventBridge rules
- Two EventBridge rules

## Terraform module structure

For the source code, see the GitHub repository [Terraform EC2 Image Builder Container Hardening Pipeline](#).

```
### components.tf
### config.tf
### dist-config.tf
### files
#   ###assumption-policy.json
### hardening-pipeline.tfvars
### image.tf
### infr-config.tf
### infra-network-config.tf
### kms-key.tf
### main.tf
### outputs.tf
### pipeline.tf
### recipes.tf
### roles.tf
### sec-groups.tf
### trigger-build.tf
### variables.tf
```

## Module details

- `components.tf` contains an Amazon S3 upload resource to upload the contents of the `/files` directory. You can also modularly add custom component YAML files here as well.
- `/files` contains the `.yaml` files that define the components used in `components.tf`.
- `image.tf` contains the definitions for the base image operating system. This is where you can modify the definitions for a different base image pipeline.

- `infr-config.tf` and `dist-config.tf` contain the resources for the minimum AWS infrastructure needed to spin up and distribute the image.
- `infra-network-config.tf` contains the minimum VPC infrastructure to deploy the container image into.
- `hardening-pipeline.tfvars` contains the Terraform variables to be used at apply time.
- `pipeline.tf` creates and manages an EC2 Image Builder pipeline in Terraform.
- `recipes.tf` is where you can specify different mixtures of components to create container recipes.
- `roles.tf` contains the AWS Identity and Access Management (IAM) policy definitions for the Amazon Elastic Compute Cloud (Amazon EC2) instance profile and pipeline deployment role.
- `trigger-build.tf` contains the EventBridge rules and SQS queue resources.

## Target architecture

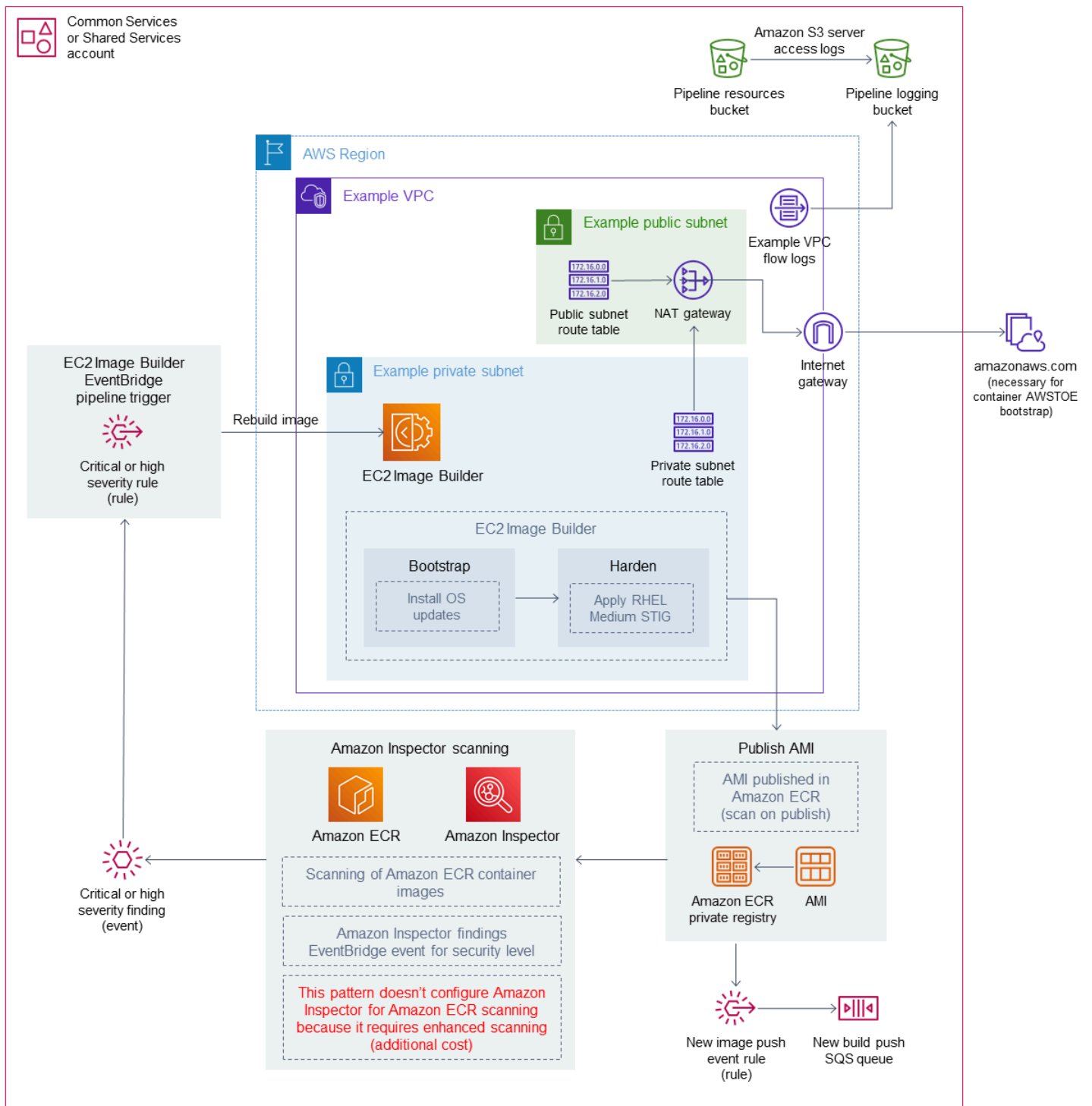

The diagram illustrates the following workflow:

1. EC2 Image Builder builds a container image by using the defined recipe, which installs operating system updates and applies the RHEL Medium STIG to the Amazon Linux 2 base image.



2. The hardened image is published to a private Amazon ECR registry, and an EventBridge rule sends a message to an SQS queue when the image has been published successfully.
3. If Amazon Inspector is configured for enhanced scanning, it scans the Amazon ECR registry.
4. If Amazon Inspector generates a **Critical** or **High** severity finding for the image, an EventBridge rule triggers the EC2 Image Builder pipeline to run again and publish a newly hardened image.

## Automation and scale

- This pattern describes how to provision the infrastructure and build the pipeline on your computer. However, it is intended to be used at scale. Instead of deploying the Terraform modules locally, you can use them in a multi-account environment, such as an [AWS Control Tower](#) with [Account Factory for Terraform](#) environment. In that case, you should use a [backend state S3 bucket](#) to manage Terraform state files instead of managing the configuration state locally.
- For scaled use, deploy the solution to one central account, such as a Shared Services or Common Services account, from a Control Tower or landing zone account model, and grant consumer accounts permission to access the Amazon ECR repository and AWS KMS key. For more information about the setup, see the re:Post article [How can I allow a secondary account to push or pull images in my Amazon ECR image repository?](#) For example, in an [account vending machine](#) or Account Factory for Terraform, add permissions to each account baseline or account customization baseline to provide access to that Amazon ECR repository and encryption key.
- After the container image pipeline is deployed, you can modify it by using EC2 Image Builder features such as [components](#), which help you package more components into the Docker build.
- The AWS KMS key that is used to encrypt the container image should be shared across the accounts that the image is intended to be used in.
- You can add support for other images by duplicating the entire Terraform module and modifying the following `recipes.tf` attributes:
  - Modify `parent_image = "amazonlinux:latest"` to another image type.
  - Modify `repository_name` to point to an existing Amazon ECR repository. This creates another pipeline that deploys a different parent image type to your existing Amazon ECR repository.

## Tools

### Tools

- Terraform (IaC provisioning)
- Git (if provisioning locally)
- AWS CLI version 1 or version 2 (if provisioning locally)

## Code

The code for this pattern is in the GitHub repository [Terraform EC2 Image Builder Container Hardening Pipeline](#). To use the sample code, follow the instructions in the next section.

## Epics

### Provision the infrastructure

Task	Description	Skills required
Set up local credentials.	<p>Set up your AWS temporary credentials.</p> <ol style="list-style-type: none"> <li>See if the AWS CLI is installed:</li> </ol> <pre>\$ aws --version aws-cli/1.16.249 Python/3.6.8...</pre> <ul style="list-style-type: none"> <li>• AWS CLI version should be 1.1 or later.</li> <li>• If the command isn't found, <a href="#">install the AWS CLI</a>.</li> </ul> <ol style="list-style-type: none"> <li>Run <code>aws configure</code> and provide the following values:</li> </ol> <pre>\$ aws configure AWS Access Key ID [*****xXXX</pre>	AWS DevOps

Task	Description	Skills required
	<pre>] : &lt;Your AWS access key ID&gt; AWS Secret Access Key [*****xxx x] : &lt;Your AWS secret access key&gt; Default region name: [us-east-1] : &lt;Your desired Region for deployment&gt; Default output format [None] : &lt;Your desired output format&gt;</pre>	

Task	Description	Skills required
Clone the repository.	<p>1. Clone the repository that's provided with this pattern. You can use HTTPS or Secure Shell (SSH).</p> <p>HTTPS:</p> <pre>git clone https://github.com/aws-samples/terraform-ec2-image-builder-container-hardening-pipeline</pre> <p>SSH:</p> <pre>git clone git@github.com:aws-samples/terraform-ec2-image-builder-container-hardening-pipeline.git</pre> <p>2. Navigate to your local directory that contains this solution:</p> <pre>cd terraform-ec2-image-builder-container-hardening-pipeline</pre>	AWS DevOps

Task	Description	Skills required
Update variables.	<p>Update the variables in the <code>hardening-pipeline.tfvars</code> file to match your environment and your desired configuration. You must provide your own <code>account_id</code>. However, you should also modify the rest of the variables to fit your desired deployment. All variables are required.</p> <pre>account_id      =   "&lt;DEPLOYMENT-ACCOUNT-   ID&gt;" aws_region     = "us- east-1" vpc_name       =   "example-hardening-   pipeline-vpc" kms_key_alias  =   "image-builder-con   tainer-key" ec2_iam_role_name =   "example-hardening-   instance-role" hardening_pipeline_role_name = "example- hardening-pipeline- role" aws_s3_ami_resources_bucket = "example- hardening-ami-reso rces-bucket-0123" image_name     = "example- hardening-al2-cont ainer-image"</pre>	AWS DevOps

Task	Description	Skills required
	<pre data-bbox="609 210 1015 462">ecr_name = "example- hardening-container- repo" recipe_version =   "1.0.0" ebs_root_vol_size = 10</pre> <p data-bbox="592 504 990 577">Here's a description of each variable:</p> <ul data-bbox="592 630 1023 1869" style="list-style-type: none"><li data-bbox="592 630 1023 808">• <code>account_id</code> – The AWS account number that you want to deploy the solution into.</li><li data-bbox="592 829 1023 966">• <code>aws_region</code> – The AWS Region that you want to deploy the solution into.</li><li data-bbox="592 987 1023 1060">• <code>vpc_name</code> – The name for your VPC infrastructure.</li><li data-bbox="592 1081 1023 1312">• <code>kms_key_alias</code> – The AWS KMS key name to be used by the EC2 Image Builder infrastructure configuration.</li><li data-bbox="592 1333 1023 1512">• <code>ec2_iam_role_name</code> – The name for the role that will be used as the EC2 instance profile.</li><li data-bbox="592 1533 1023 1764">• <code>hardening_pipeline_role_name</code> – The name for the role that will be used to deploy the hardening pipeline.</li><li data-bbox="592 1785 1023 1869">• <code>aws_s3_ami_resources_bucket</code> – The name</li></ul>	

Task	Description	Skills required
	<p>for an S3 bucket that will host all files necessary to build the pipeline and container images.</p> <ul style="list-style-type: none"><li>• <code>image_name</code> – The container image name. This value must be between 3 and 50 characters and should contain alphanumeric characters and hyphens only.</li><li>• <code>ecr_name</code> – The name of the Amazon ECR registry to store the container images in.</li><li>• <code>recipe_version</code> – The version of the image recipe. The default value is 1.0.0.</li><li>• <code>ebs_root_vol_size</code> – The size (in gigabytes) of the Amazon Elastic Block Store (Amazon EBS) root volume. The default value is 10 gigabytes.</li></ul>	

Task	Description	Skills required
Initialize Terraform.	<p>After you update your variable values, you can initialize the Terraform configuration directory. Initializing a configuration directory downloads and installs the AWS provider, which is defined in the configuration.</p> <pre data-bbox="594 680 1027 758">terraform init</pre> <p>You should see a message that says Terraform has been successfully initialized and identifies the version of the provider that was installed.</p>	AWS DevOps
Deploy the infrastructure and create a container image.	<p>Use the following command to initialize, validate, and apply the Terraform modules to the environment by using the variables defined in your <code>.tfvars</code> file:</p> <pre data-bbox="594 1381 1027 1619">terraform init &amp;&amp; terraform validate &amp;&amp; terraform apply -var-file *.tfvars -auto-approve</pre>	AWS DevOps



Task	Description	Skills required
Customize the container.	<p>You can create a new version of a container recipe after EC2 Image Builder deploys the pipeline and initial recipe.</p> <p>You can add any of the 31+ components available within EC2 Image Builder to customize the container build. For more information, see the <i>Components</i> section of <a href="#">Create a new version of a container recipe</a> in the EC2 Image Builder documentation.</p>	AWS administrator

## Validate resources

Task	Description	Skills required
Validate AWS infrastructure provisioning.	<p>After you have successfully completed your first Terraform apply command, if you're provisioning locally, you should see this snippet in your local machine's terminal:</p> <pre>Apply complete! Resources: 43 added, 0 changed, 0 destroyed.</pre>	AWS DevOps
Validate individual AWS infrastructure resources.	To validate the individual resources that were deployed, if you're provisioning locally,	AWS DevOps

Task	Description	Skills required
	<p>you can run the following command:</p> <pre>terraform state list</pre> <p>This command returns a list of 43 resources.</p>	

## Remove resources

Task	Description	Skills required
Remove the infrastructure and container image.	<p>When you've finished working with your Terraform configuration, you can run the following command to remove resources:</p> <pre>terraform init &amp;&amp; terraform validate &amp;&amp; terraform destroy -var-file *.tfvars -auto-approve</pre>	AWS DevOps

## Troubleshooting

Issue	Solution
Error validating provider credentials	When you run the Terraform apply or destroy command from your local machine, you might encounter an error similar to the following:

Issue	Solution
	<pre data-bbox="846 226 1429 621">Error: configuring Terraform AWS Provider: error validating provider credentials: error calling sts:GetCa llerIdentity: operation error STS: GetCallerIdentity, https response error StatusCode: 403, RequestID: 123456a9-fbc1-40ed-b8d8-513d0133ba7 f, api error InvalidClientTokenId: The security token included in the request is invalid.</pre> <p data-bbox="829 682 1494 814">This error is caused by the expiration of the security token for the credentials used in your local machine's configuration.</p> <p data-bbox="829 856 1369 989">To resolve the error, see <a href="#">Set and view configuration settings</a> in the AWS CLI documentation.</p>

## Related resources

- [Terraform EC2 Image Builder Container Hardening Pipeline](#) (GitHub repository)
- [EC2 Image Builder documentation](#)
- [AWS Control Tower Account Factory for Terraform](#) (AWS blog post)
- [Backend state S3 bucket](#) (Terraform documentation)
- [Installing or updating the latest version of the AWS CLI](#) (AWS CLI documentation)
- [Download Terraform](#)

# Centralize IAM access key management in AWS Organizations by using Terraform

*Created by Aarti Rajput (AWS), Chintamani Aphale (AWS), T.V.R.L.Phani Kumar Dadi (AWS), Pradip kumar Pandey (AWS), Mayuri Shinde (AWS), and Pratap Kumar Nanda (AWS)*

**Environment:** Production

**Technologies:** Security, identity, compliance; Infrastructure

**AWS services:** Amazon EventBridge; AWS Lambda; AWS Organizations; AWS Secrets Manager; Amazon SES

## Summary

Enforcing security rules for keys and passwords is an essential task for every organization. One important rule is to rotate AWS Identity and Access Management (IAM) keys at regular intervals to enforce security. AWS access keys are generally created and configured locally whenever teams want to access AWS from the AWS Command Line Interface (AWS CLI) or from applications outside AWS. To maintain strong security across the organization, old security keys must be changed or deleted after the requirement has been met or at regular intervals. The process of managing key rotations across multiple accounts in an organization is time-consuming and tedious. This pattern helps you automate the rotation process by using Account Factory for Terraform (AFT) and AWS services.

The pattern provides these benefits:

- Manages your access key IDs and secret access keys across all the accounts in your organization from a central location.
- Automatically rotates the `AWS_ACCESS_KEY_ID` and `AWS_SECRET_ACCESS_KEY` environment variables.
- Enforces renewal if user credentials are compromised.

The pattern uses Terraform to deploy AWS Lambda functions, Amazon EventBridge rules, and IAM roles. An EventBridge rule runs at regular intervals and calls a Lambda function that lists all user access keys based on when they were created. Additional Lambda functions create a new access key ID and secret access key, if the previous key is older than the rotation period you define (for

example, 45 days), and notify a security administrator by using Amazon Simple Notification Service (Amazon SNS) and Amazon Simple Email Service (Amazon SES). Secrets are created in AWS Secrets Manager for that user, the old secret access key is stored in Secrets Manager, and permissions for accessing the old key are configured. To ensure that the old access key is no longer used, it is disabled after an inactive period (for example, 60 days, which would be 15 days after the keys were rotated in our example). After an inactive buffer period (for example, 90 days, or 45 days after the keys were rotated in our example), the old access keys are deleted from AWS Secrets Manager. For a detailed architecture and workflow, see the [Architecture](#) section.

## Prerequisites and limitations

- A landing zone for your organization that's built by using [AWS Control Tower](#) (version 3.1 or later)
- [Account Factory for Terraform \(AFT\)](#) configured with three accounts:
  - [Organization management account](#) manages the entire organization from a central location.
  - [AFT management account](#) hosts the Terraform pipeline and deploys the infrastructure into the deployment account.
  - [Deployment account](#) deploys this complete solution and manages IAM keys from a central location.
- Terraform version 0.15.0 or later for provisioning the infrastructure in the deployment account.
- An email address that's configured in [Amazon Simple Email Service \(Amazon SES\)](#).
- (Recommended) To enhance security, deploy this solution inside a [private subnet](#) (deployment account) within a [virtual private cloud \(VPC\)](#). You can provide the details of the VPC and subnet when you customize the variables (see *Customize parameters for the code pipeline* in the [Epics](#) section).

## Architecture

### AFT repositories

This pattern uses Account Factory for Terraform (AFT) to create all required AWS resources and the code pipeline to deploy the resources in a deployment account. The code pipeline runs in two repositories:

- **Global customization** contains Terraform code that will run across all accounts registered with AFT.

- **Account customizations** contains Terraform code that will run in the deployment account.

## Resource details

AWS CodePipeline jobs create the following resources in the deployment account:

- AWS EventBridge rule and configured rule
- `account-inventory` Lambda function
- `IAM-access-key-rotation` Lambda function
- `Notification` Lambda function
- Amazon Simple Storage Service (Amazon S3) bucket that contains an email template
- Required IAM policy

## Architecture

The diagram illustrates the following:

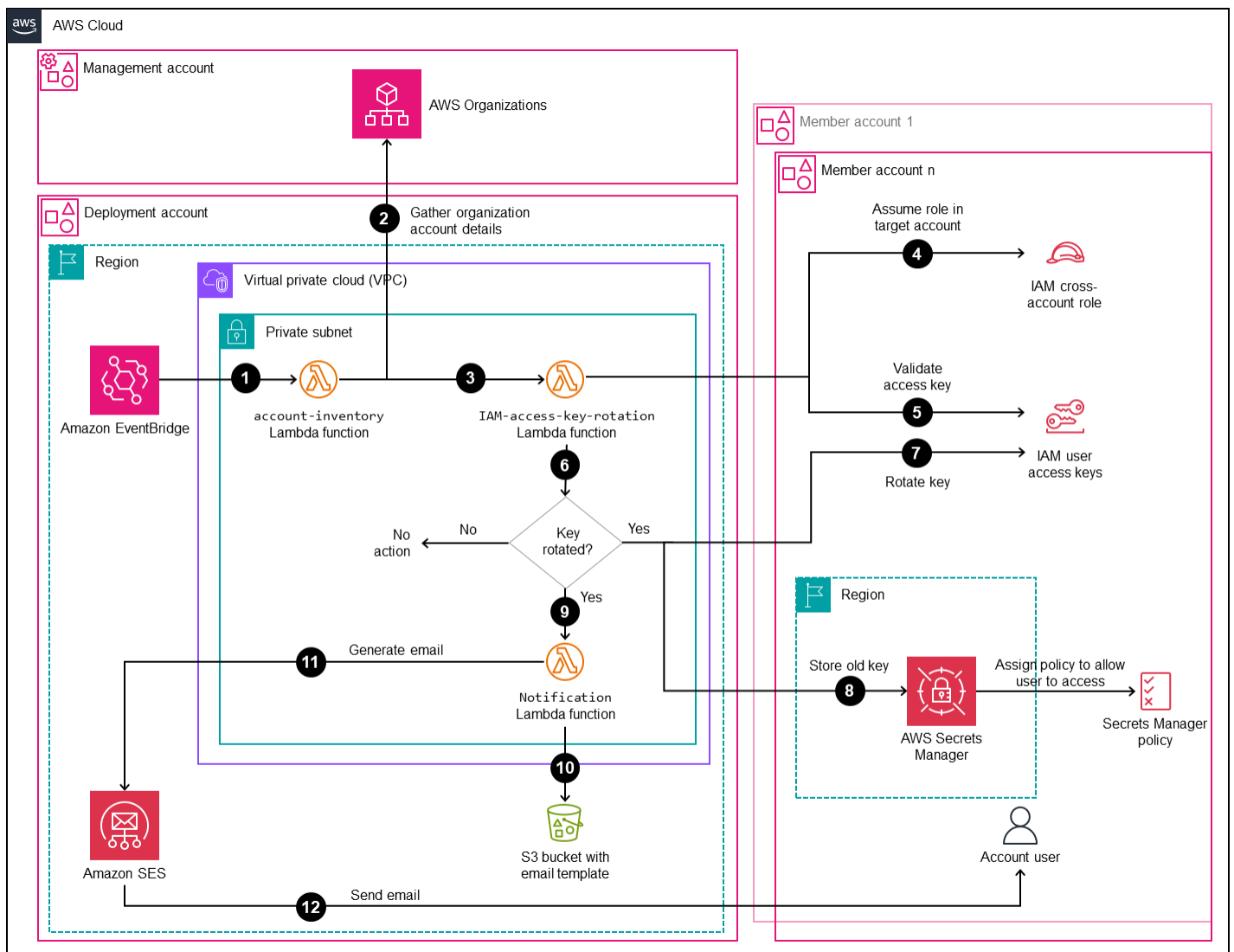

1. An EventBridge rule calls the `account-inventory` Lambda function every 24 hours.
2. The `account-inventory` Lambda function queries AWS Organizations for a list of all AWS account IDs, account names, and account emails.
3. The `account-inventory` Lambda function initiates an `IAM-access-key-rotation` Lambda function for each AWS account and passes the metadata to it for additional processing.
4. The `IAM-access-key-rotation` Lambda function uses an assumed IAM role to access the AWS account. The Lambda script runs an audit against all users and their IAM access keys in the account.
5. The IAM key rotation threshold (rotation period) is configured as an environment variable when the `IAM-access-key-rotation` Lambda function is deployed. If the rotation period

is modified, the `IAM-access-key-auto-rotation` Lambda function is redeployed with an updated environment variable. You can configure parameters to set the rotation period, the inactive period for old keys, and the inactive buffer after which old keys will be deleted (see *Customize parameters for the code pipeline* in the [Epics](#) section).

6. The `IAM-access-key-auto-rotation` Lambda function validates the age of the access key based on its configuration. If the IAM access key's age hasn't exceeded the rotation period you defined, the Lambda function takes no further action.
7. If the IAM access key's age has exceeded the rotation period you defined, the `IAM-access-key-auto-rotation` Lambda function creates a new key and rotates the existing key.
8. The Lambda function saves the old key in Secrets Manager and limits permissions to the user whose access keys deviated from security standards. The Lambda function also creates a resource-based policy that allows only the specified IAM principal to access and retrieve the secret.
9. The `IAM-access-key-rotation` Lambda function calls the `Notification` Lambda function.
10. The `Notification` Lambda function queries the S3 bucket for an email template and dynamically generates email messages with the relevant activity metadata.
11. The `Notification` Lambda function calls Amazon SES for further action.
12. Amazon SES sends email to the account owner's email address with the relevant information.

## Tools

### AWS services

- [AWS Identity and Access Management \(IAM\)](#) helps you securely manage access to your AWS resources by controlling who is authenticated and authorized to use them. This pattern requires IAM roles and permissions.
- [AWS Lambda](#) is a compute service that helps you run code without needing to provision or manage servers. It runs your code only when needed and scales automatically, so you pay only for the compute time that you use.
- [AWS Secrets Manager](#) helps you replace hardcoded credentials in your code, including passwords, with an API call to Secrets Manager to retrieve the secret programmatically.
- [Amazon Simple Email Service \(Amazon SES\)](#) helps you send and receive emails by using your own email addresses and domains.



## Other tools

- [Terraform](#) is an infrastructure as code (IaC) tool from HashiCorp that helps you create and manage cloud and on-premises resources.

## Code repository

The instructions and code for this pattern are available in the GitHub [IAM access key rotation](#) repository. You can deploy the code in the AWS Control Tower central deployment account to manage key rotation from a central location.

## Best practices

- For IAM, see [security best practices](#) in the IAM documentation.
- For key rotation, see [guidelines for updating access keys](#) in the IAM documentation.

## Epics

### Set up source files

Task	Description	Skills required
Clone the repository.	<ol style="list-style-type: none"> <li>1. Clone the <a href="#">IAM access key rotation</a> GitHub repository:           <pre>\$ git clone https://github.com/aws-samples/centralized-iam-key-management-aws-organizations-terraform.git</pre> </li> <li>2. Confirm that your local copy of the repository contains three folders:           <pre>\$ cd Iam-Access-keys-Rotation \$ ls</pre> </li> </ol>	DevOps engineer

Task	Description	Skills required
	<pre>org-account-cus tomization global-account-c ustomization account-custom ization</pre>	

## Configure accounts

Task	Description	Skills required
Configure the bootstrapping account.	<p>As part of the <a href="#">AFT bootstrapping</a> process, you should have a folder called <code>aft-bootstrap</code> on your local machine.</p> <ol style="list-style-type: none"> <li>Copy all Terraform files manually from your local GitHub <a href="#">org-account-customization</a> folder to your <code>aft-bootstrap</code> folder.</li> <li>Run Terraform commands to configure the global cross-account role in the AWS Control Tower management account:</li> </ol> <pre>\$ cd aft-bootstrap \$ terraform init \$ terraform apply -auto-approve</pre>	DevOps engineer
Configure global customizations.	As part of the <a href="#">AFT folder</a> setup, you should have a	DevOps engineer

Task	Description	Skills required
	<p>folder called <code>aft-global-customizations</code> on your local machine.</p> <ol style="list-style-type: none"><li>1. Manually copy all Terraform files from your local GitHub <a href="#">global-account-customization</a> folder to your <code>aft-global-customizations/terraform</code> folder.</li><li>2. Push the code to AWS CodeCommit:</li></ol> <pre data-bbox="634 852 1029 1052">\$ git add * \$ git commit -m   "message" \$ git push</pre>	

Task	Description	Skills required
Configure account customizations.	<p>As part of the <a href="#">AFT folder setup</a>, you have be a folder called <code>aft-account-customizations</code> on your local machine.</p> <ol style="list-style-type: none"> <li>1. Create a folder with your vended account number.</li> <li>2. Manually copy manual all Terraform files from your local GitHub <a href="#">account-c ustomization</a> folder to your <code>aft-account-customizations/&lt;vended account&gt;/terraform</code> folder.</li> <li>3. Push the code to AWS CodeCommit:</li> </ol> <pre data-bbox="630 1115 1029 1314"> \$ git add * \$ git commit -m "message" \$ git push           </pre>	DevOps engineer

## Customize parameters for the code pipeline

Task	Description	Skills required
Customize non-Terraform code pipeline parameters for all accounts.	Create a file called <code>input.auto.tfvars</code> in the <code>aft-global-customizations/terraform/</code> folder and provide the required input data. See <a href="#">the</a>	DevOps engineer

Task	Description	Skills required
	<a href="#">file in the GitHub repository</a> for default values.	

Task	Description	Skills required
Customize code pipeline parameters for the deployment account.	<p>Create a file called <code>input.auto.tfvars</code> in the <code>aft-account-customizations/&lt;AccountName&gt;/terraform/</code> folder and push the code to AWS CodeCommit. Pushing code to AWS CodeCommit automatically initiates the code pipeline.</p> <p>Specify values for parameters based on your organization's requirements, including the following (see <a href="#">the file in the Github repository</a> for default values):</p> <ul style="list-style-type: none"><li>• <code>s3_bucket_name</code> – A unique bucket name for the email template.</li><li>• <code>s3_bucket_prefix</code> – A folder name inside the S3 bucket.</li><li>• <code>admin_email_address</code> – The email address for the administrator who should receive the notification.</li><li>• <code>org_list_account</code> – The account number of the management account.</li><li>• <code>rotation_period</code> – The number of days after which</li></ul>	DevOps engineer

Task	Description	Skills required
	<p>a key should be rotated from active to inactive.</p> <ul style="list-style-type: none"><li>• <code>inactive_period</code> – The number of days after which rotated keys should be deactivated. This value must be greater than the value of <code>rotation_period</code> .</li><li>• <code>inactive_buffer</code> – The grace period between the rotation and the deactivation of a key.</li><li>• <code>recovery_grace_period</code> – The grace period between the deactivation and the deletion of a key.</li><li>• <code>dry_run_flag</code> – Set to <b>true</b> if you want to send a notification to the administrator for testing purposes, without rotating keys.</li><li>• <code>store_secrets_in_central_account</code> – Set to <b>true</b> if you want to store the secret in the deployment account. If the variable is set to <b>false</b> (default), the secret will be stored in the member account.</li><li>• <code>credential_replication_region</code> – The</li></ul>	

Task	Description	Skills required
	<p>AWS Region where you want to deploy the Lambda function and the S3 buckets for the email template.</p> <ul style="list-style-type: none"> <li>• <code>run_lambda_in_vpc</code> – Set to <b>true</b> to run the Lambda function inside the VPC.</li> <li>• <code>vpc_id</code> – The VPC ID of the deployment account, if you want to run the Lambda function inside the VPC.</li> <li>• <code>vpc_cidr</code> – The CIDR range for the deployment account.</li> <li>• <code>subnet_id</code> – The subnet IDs for the deployment account.</li> <li>• <code>create_smtp_endpoint</code> – Set to <b>true</b> if you want to enable the email endpoint.</li> </ul>	

## Validate key rotation

Task	Description	Skills required
Validate the solution.	<ol style="list-style-type: none"> <li>1. From the AWS Management Console, sign in to the deployment account.</li> <li>2. Open the <a href="#">IAM console</a> and check whether user credentials (access key IDs</li> </ol>	DevOps engineer



Task	Description	Skills required
	<p>and secret keys) are being rotated as specified.</p> <p>3. After an IAM key has been rotated, confirm the following:</p> <ul style="list-style-type: none"> <li>• The old value is stored in AWS Secrets Manager.</li> <li>• The secret name is in the format <code>Account_&lt;account ID&gt;_User_&lt;username&gt;_AccessKey</code> .</li> <li>• The user you specified in the <code>admin_email_address</code> parameter receives an email notification about the key rotation.</li> </ul>	

## Extend the solution

Task	Description	Skills required
<p>Customize the email notification date.</p>	<p>If you want to send email notifications on a specific day before you disable the access key, you can update the <code>IAM-access-key-auto-rotation</code> Lambda function with those changes:</p> <ol style="list-style-type: none"> <li>1. Define a variable called <code>notify-period</code> .</li> </ol>	<p>DevOps engineer</p>

Task	Description	Skills required
	<p>2. Add an if condition in <code>main.py</code> before you deactivate the key:</p> <pre data-bbox="634 380 1029 894"> If (keyage&gt;rotation- period-notify-perio d){   send_to_notifier(c ontext, aws_accou nt_id, account_name,   resource_owner, resource_actions[res ource_owner],   dryrun, config.em ailTemplateAudit) } </pre>	

## Troubleshooting

Issue	Solution
<p>The <code>account-inventory</code> Lambda job fails with <code>AccessDenied</code> while listing accounts.</p>	<p>If you encounter this issue, you must validate permissions:</p> <ol style="list-style-type: none"> <li>1. Log in to the newly vended account, open the <a href="#">Amazon CloudWatch console</a>, and then view the CloudWatch log group / <code>aws/lambda/account-inventory-lambda</code> .</li> <li>2. In the latest CloudWatch logs, identify the account number that is causing the access denied issue.</li> <li>3. Log in to the AWS Control Tower management account and confirm that the role <code>allow-list-account</code> was created.</li> </ol>

Issue	Solution
	<ol style="list-style-type: none"><li data-bbox="831 214 1507 340">4. If the role doesn't exist, rerun the Terraform code by using the <code>terraform apply</code> command.</li><li data-bbox="831 365 1468 445">5. Choose the <b>Trusted Account</b> tab and validate that the same account is trusted.</li></ol>

## Related resources

- [Terraform Recommended Practices](#) (Terraform documentation)
- [Security best practices in IAM](#) (IAM documentation)
- [Best practices for key rotation](#) (IAM documentation)

# Centralized logging and multiple-account security guardrails

Created by Ankush Verma (AWS) and Tracy (Pierce) Hickey (AWS)

**Environment:** Production

**Technologies:** Security, identity, compliance; Management & governance

**AWS services:** AWS CloudFormation; AWS Config; Amazon CloudWatch; AWS CodePipeline; Amazon GuardDuty; AWS Lambda; Amazon Macie; AWS Security Hub; Amazon S3

## Summary

The approach covered in this pattern is suitable for customers who have multiple Amazon Web Services (AWS) accounts with AWS Organizations and are now encountering challenges when using AWS Control Tower, a landing zone, or account vending machine services to set up baseline guardrails in their accounts.

This pattern demonstrates the use of a streamlined multiple-account architecture to set up centralized logging and standardized security controls in a well-structured manner. With the help of AWS CloudFormation templates, AWS CodePipeline, and automation scripts, this setup is deployed in all accounts that belong to an organization.

The multiple-account architecture includes the following accounts:

- **Centralized logging account** – The account where all the virtual private cloud (VPC) flows logs, AWS CloudTrail logs, the AWS Config log, and all the logs of Amazon CloudWatch Logs (using subscriptions) from all the other accounts are stored.
- **Parent security account**– The account to serve as the parent account for the following security services that manage across multiple accounts.
  - Amazon GuardDuty
  - AWS Security Hub
  - Amazon Macie
  - Amazon Detective

- **Child accounts** – The other accounts in the organization. These accounts store all the useful logs in the centralized logging account. The child accounts join the parent security account as members for the security services.

After you launch the CloudFormation template (attached), it provisions three Amazon Simple Storage Service (Amazon S3) buckets in the centralized logging account. One bucket is used to store all AWS related logs (such as logs from VPC Flow Logs, CloudTrail, and AWS Config) from all the accounts. The second bucket is for storing the CloudFormation templates from all the accounts. The third bucket is for storing Amazon S3 access logs.

A separate CloudFormation template creates the pipeline that uses AWS CodeCommit. After the updated code is pushed to the CodeCommit repository, it takes care of launching resources and setting up security services in all the accounts. For more information about the file structure of the files that will be uploaded to the CodeCommit repository, see the README.md file (attached).

## Prerequisites and limitations

### Prerequisites

- An AWS Organizations organization ID, with all accounts joined to the same organization.
- An active email address to receive Amazon Simple Notification Service (Amazon SNS) notifications.
- Confirmed quotas for Amazon Simple Storage Service (Amazon S3) buckets in each of your accounts. By default, each account has 100 S3 buckets. If you require additional buckets, request a quota increase before you deploy this solution.

### Limitations

All the accounts should be the part of the same organization. If you are not using AWS Organizations, you must modify certain policies, such as the S3 bucket policy, to allow access from the AWS Identity and Access Management (IAM) roles for each account.

**Note:** While the solution is being deployed, you must confirm the Amazon SNS subscription. The confirmation message is sent to the email address that you provide during the deployment process. This will initiate a few email alert messages to this email address, because these alarms are initiated whenever IAM role policies are created or modified in the account. During the deployment process, you can ignore these alert messages.

# Architecture

## Target technology stack

- Amazon CloudWatch alarms and logs
- AWS CodeCommit repository
- AWS CodePipeline
- AWS Config
- Amazon Detective
- Amazon GuardDuty
- IAM roles and permissions
- Amazon Macie
- S3 buckets
- AWS Security Hub
- Amazon SNS

## Target architecture

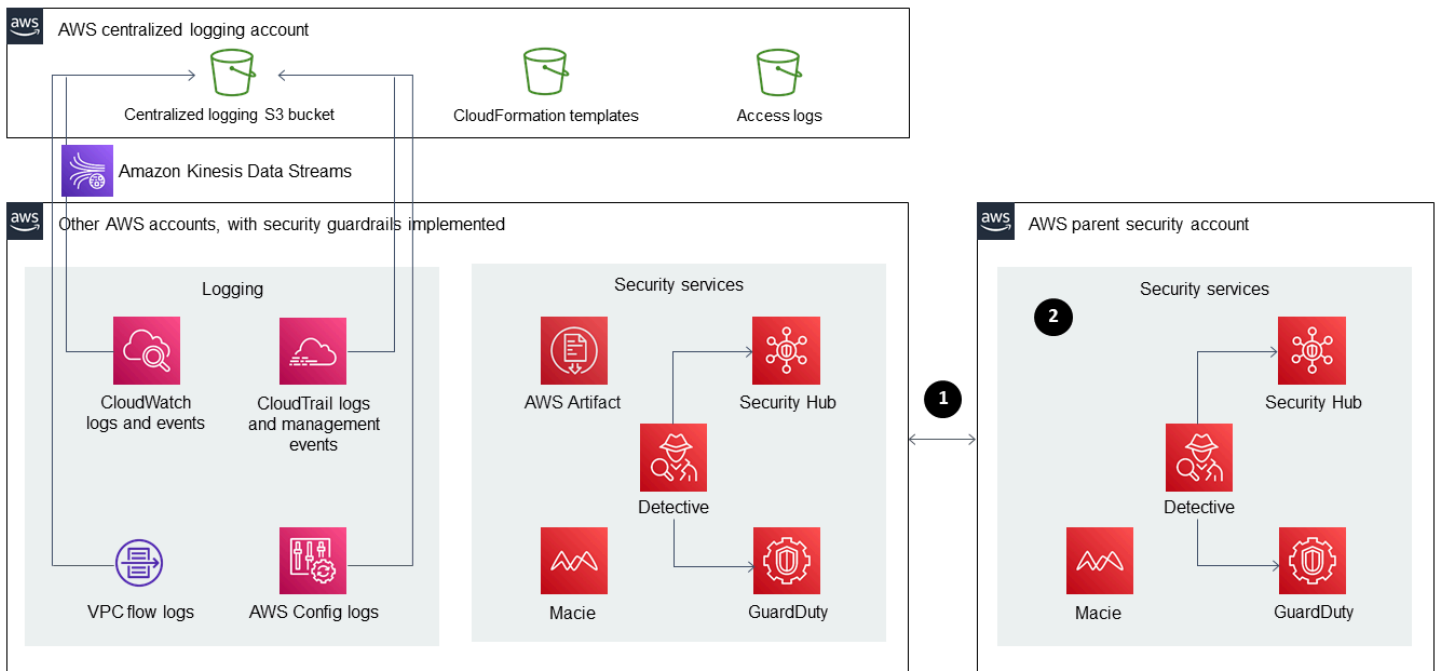

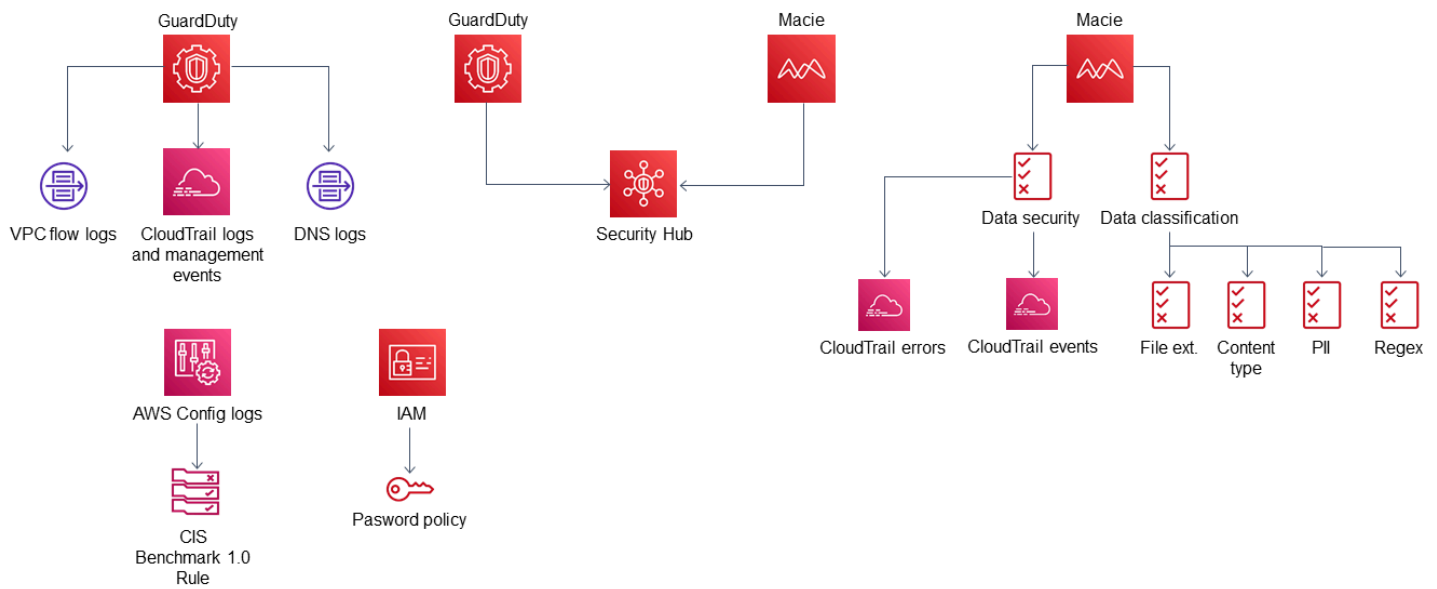

1. Other accounts registered as child accounts of the parent security account for the security services
2. Security findings from all the child accounts, including the parent account

## Resources

The following resources are provisioned automatically when the updated code is pushed to the CodeCommit repository in each account and AWS Region.

### *CloudFormation stack 1 – Logging parent stack*

- Nested stack 1 – Standard IAM roles and policies
- Nested stack 2 – AWS Config setup in the account
- Nested stack 3 – CloudWatch alarms
  - SecurityGroupChangesAlarm
  - UnauthorizedAttemptAlarm
  - RootActivityAlarm
  - NetworkAclChangesAlarm
  - IAMUserManagementAlarm

- IAMPolicyChangesAlarm
- CloudTrailChangeAlarm
- IAMCreateAccessKeyAlarm
- Metric filters for creating metrics from CloudTrail logs and using them for alarms
- SNS topic

### *CloudFormation stack 2 – Parent guardrail stack*

- Nested stack 1 – AWS Lambda function for setting up the account password policy
- Nested stack 2 – Basic AWS Config rules
  - CIS-SecurityGroupsMustRestrictSshTraffic
  - OpenSecurityGroupRuleCheck along with the Lambda function for security group rule evaluation
    - check-ec2-for-required-tag
    - check-for-unrestricted-ports

### *CloudFormation stack 3 – CloudWatch logs export*

- Exporting CloudWatch logs from log groups to Amazon S3 using an Amazon Kinesis subscription

## **Tools**

- [AWS CloudFormation](#) – AWS CloudFormation uses templates to model and provision, in an automated and secure manner, all the resources needed for your applications across all AWS Regions and accounts.
- [Amazon CloudWatch](#) – Amazon CloudWatch monitors your AWS resources and the applications you run on AWS in real time. You can use CloudWatch to collect and track metrics, which are variables you can measure for your resources and applications.
- [AWS CodeCommit](#) – AWS CodeCommit is a version-control service hosted by AWS. You can use CodeCommit to privately store and manage assets (such as documents, source code, and binary files) in the cloud.



- [AWS CodePipeline](#) – AWS CodePipeline is a continuous delivery service that you can use to model, visualize, and automate the steps required to release your software.
- [AWS Config](#) – AWS Config provides a detailed view of the configuration of AWS resources in your AWS account. This includes how the resources are related to one another and how they were configured in the past so that you can see how the configurations and relationships change over time.
- [Amazon Detective](#) – Amazon Detective is used to analyze, investigate, and quickly identify the root cause of security findings or suspicious activities. Detective automatically collects log data from your AWS resources. It then uses machine learning, statistical analysis, and graph theory to help you visualize and conduct faster and more efficient security investigations.
- [Amazon GuardDuty](#) – Amazon GuardDuty is a continuous security monitoring service that analyzes and processes the flow logs, CloudTrail management event logs, CloudTrail data event logs, and Domain Name System (DNS) logs. It uses threat intelligence feeds, such as lists of malicious IP addresses and domains, and machine learning to identify unexpected and potentially unauthorized and malicious activity within your AWS environment.
- [AWS Identity and Access Management](#) – AWS Identity and Access Management (IAM) is a web service that helps you securely control access to AWS resources. You use IAM to control who is authenticated (signed in) and authorized (has permissions) to use resources.
- [Amazon Macie](#) – Amazon Macie automates the discovery of sensitive data, such as personally identifiable information (PII) and financial data, to provide you with a better understanding of the data that your organization stores in Amazon S3.
- [Amazon S3](#) – Amazon Simple Storage Service (Amazon S3) is a highly scalable object storage service that can be used for a wide range of storage solutions, including websites, mobile applications, backups, and data lakes.
- [AWS Security Hub](#) – AWS Security Hub provides you with a comprehensive view of your security state in AWS and helps you check your environment against security standards and best practices.
- [Amazon SNS](#) – Amazon Simple Notification Service (Amazon SNS) is a managed service that provides message delivery from publishers to subscribers (also known as *producers* and *consumers*).

## Epics

### Step 1: Set up the IAM roles in all the accounts

Task	Description	Skills required
Launch the Childaccount_IAM_role_All_Accounts.yaml CloudFormation template to create the IAM role in the us-east-1 Region.	To create the required IAM roles and permissions, you must manually launch this template in each account, one by one (centralized logging account, parent security account, and all other AWS accounts in the organization) in the us-east-1 Region. The Childaccount_IAM_role_All_Accounts.yaml template is in the /templates/initial_deployment_templates directory of the package. The IAM role is used when making API calls for provisioning and setting up the rest of the architecture. Make sure that the name of the IAM role that is passed as a parameter is consistent across all the accounts.	Cloud architect
In the template parameters, provide the name of the IAM role.	Provide the IAM role that CodeBuild, in the parent security account, can assume in all other child accounts. The default role name is security_execute_child_stack_role .	Cloud architect

Task	Description	Skills required
In the parameters, provide the account ID for the parent security account.	The parent security account is the account where CodeBuild runs.	Cloud architect

## Step 2: Set up S3 buckets in the centralized logging account

Task	Description	Skills required
In the centralized logging account, in us-east-1, launch the S3Buckets-Centralized-LoggingAccount.yaml CloudFormation template.	To create the S3 buckets in the centralized logging account, launch the S3Buckets-Centralized-LoggingAccount.yaml . The template is in the /templates/initial_deployment_templates directory of the package. The S3 buckets will store all the logs, templates , and Amazon S3 access logs. Make a note of the all the S3 bucket names, which you will use to modify the parameter files in the following steps.	Cloud architect
In the template parameters, provide the name of the S3 bucket for AWS logs storage.	Enter a name for the S3 Bucket Name for Centralized Logging in Logging Account parameter. This bucket acts as centralized location to store AWS logs, such as flow logs and CloudTrail logs, from all the accounts. Make a note of	Cloud architect

Task	Description	Skills required
	both the bucket name and the Amazon Resource Name (ARN).	
Provide the name of the S3 bucket for storing access logs.	Enter an S3 bucket name for the S3 Bucket Name for Access Logs in Logging Account parameter. This S3 bucket stores access logs for Amazon S3.	Cloud architect
Provide the name of the S3 bucket for storing templates.	Enter an S3 bucket name in the S3 Bucket Name for CloudFormation Template storage in Logging Account parameter.	Cloud architect
Provide the organization ID.	To provide access to S3 buckets within the organization, enter the ID for the organization in the Organization Id for Non-AMS accounts parameter.	Cloud architect

### Step 3: Deploy the CI/CD infrastructure in the parent security account

Task	Description	Skills required
Launch the security-guard-rai ls-codepipeline-Centralized-SecurityAccount.yml CloudFormation template.	To deploy the CI/CD pipeline, manually launch the security-guard-rai ls-codepipeline-Ce ntralized-Security	Cloud architect

Task	Description	Skills required
	Account.yml template in the parent security account in us-east-1. The template is in the /templates/initial_deployement_templates directory of the package. This pipeline will deploy all the infrastructure in all the child accounts.	
Provide a name for the S3 bucket that will store templates in the centralized logging account.	Enter the name of the S3 bucket that you provided for the S3 Bucket Name for the CloudFormation Template storage in Logging Account parameter in Step 2.	Cloud architect
Provide the name of the IAM role to be used in the child accounts.	Enter the name that you provided for the Name of the IAM role parameter in Step 1.	Cloud architect
Provide an active email address for receiving CodePipeline failure notifications.	Enter the email address that you want to use for receiving CodePipeline failure notifications and other CloudWatch alarm-related notifications.	Cloud architect

#### Step 4: Update files to include account information

Task	Description	Skills required
Modify Accountlist.json.	In the Accountlist.json file, which is at the top	Cloud architect

Task	Description	Skills required
	<p>level in the package, add the parent security account number and the child account numbers. Note that the <code>ChildAccountList</code> field also includes the parent security account number. See the example in the <code>deployment-instructions.md</code> file in the package.</p>	
Modify <code>accounts.csv</code>	<p>In the <code>accounts.csv</code> file, which is at the top level in the package, add all the child accounts along with the email registered with the accounts. See the example in the <code>deployment-instructions.md</code> file.</p>	Cloud architect

Task	Description	Skills required
Modify <code>parameters.config</code> .	<p>In the <code>parameters.config</code> file, which is in the <code>/templates</code> folder, update the following six parameters:</p> <ul style="list-style-type: none"><li>• <code>pNotifyEmail</code> : The email address that you provided when you set up the pipeline (see Step 3)</li><li>• <code>pstackNameLogging</code> : The name of the CloudFormation stack for centralized logging</li><li>• <code>pS3LogsBucket</code> : The name of the S3 bucket where logs from all accounts will be stored (see Step 2)</li><li>• <code>pBucketName</code> : The ARN for the S3 bucket used to store the logs</li><li>• <code>pTemplateBucketName</code> : The name of the S3 buckets where templates will be stored (see Step 2)</li><li>• <code>pAllowedAccounts</code> : Account IDs for the parent and child accounts</li></ul> <p>For the other parameters, you can keep the default values. For an example, see the deployment -</p>	Cloud architect

Task	Description	Skills required
	<code>instructions.md</code> file in the package.	

### Step 5: Access the CodeCommit repository and push the updated files

Task	Description	Skills required
Access the CodeCommit repo that you created in Step 3.	From the <b>Outputs</b> section of the CI/CD infrastructure CloudFormation stack (launched in <i>Step 3</i> ), note the name of the CodeCommit repository URL. Create access to the repository so that the files can be pushed to it for the infrastructure to be deployed in all the target accounts. For more information, see <a href="#">Setting up for AWS CodeCommit</a> .	Cloud architect
Push the files to the CodeCommit repository.	Install Git on your machine. Then run the Git commands to clone the empty repository, copy the files from your laptop to the repository folder, and push the artifacts to the repository. Check for the sample Git commands in the <code>deployment-instructions.md</code> file in the package. For basic Git commands, see the <i>Related resources</i> section.	Cloud architect



## Step 6: Confirm CodePipeline and CodeBuild status

Task	Description	Skills required
Confirm the status of CodePipeline and CodeBuild.	After you push the artifacts to the CodeCommit repo, confirm that the CodePipeline pipeline that you created in <i>Step 3</i> has been initiated. Then check the CodeBuild logs to confirm the status or errors.	Cloud architect

## Related resources

- [Deploying AWS CloudFormation templates](#)
- [Setting up for AWS CodeCommit](#)
- [Uploading files to S3 bucket](#)
- [Basic Git commands](#)

## Attachments

To access additional content that is associated with this document, unzip the following file: [attachment.zip](#)

# Check an Amazon CloudFront distribution for access logging, HTTPS, and TLS version

Created by SaiJeevan Devireddy (AWS) and Bijesh Bal (AWS)

**Environment:** Production

**Technologies:** Content delivery; Security, identity, compliance

**Workload:** All other workloads

**AWS services:** Amazon SNS; AWS CloudFormation; Amazon CloudWatch; AWS Lambda

## Summary

This pattern checks an Amazon CloudFront distribution to make sure that it uses HTTPS, uses Transport Layer Security (TLS) version 1.2 or later, and has access logging enabled. CloudFront is a service provided by Amazon Web Services (AWS) that speeds up the distribution of your static and dynamic web content, such as .html, .css, .js, and image files, to your users. CloudFront delivers your content through a worldwide network of data centers called *edge locations*. When a user requests content that you're serving with CloudFront, the request is routed to the edge location that provides the lowest latency (time delay), so that content is delivered with the best possible performance.

This pattern provides an AWS Lambda function that is initiated when Amazon CloudWatch Events detects the CloudFront API call [CreateDistribution](#), [CreateDistributionWithTags](#), or [UpdateDistribution](#). The custom logic in the Lambda function evaluates all CloudFront distributions that were created or updated in the AWS account. It sends a violation notification by using Amazon Simple Notification Service (Amazon SNS) if it detects the following violations:

- Global checks:
  - Custom certificate doesn't use TLS version 1.2
  - Logging is disabled for distribution
- Origin checks:

- Origin isn't configured with TLS version 1.2
- Communication with origin is allowed on a protocol other than HTTPS
- Behavior checks:
  - Default behavior communication is allowed on a protocol other than HTTPS
  - Custom behavior communication is allowed on a protocol other than HTTPS

## Prerequisites and limitations

### Prerequisites

- An active AWS account
- An email address where you want to receive the violation notifications

### Limitations

- This security control doesn't check for existing CloudFront distributions unless an update has been made to the distribution.
- CloudFront is considered a global service and isn't tied to a specific AWS Region. However, Amazon CloudWatch Logs and AWS Cloudtrail API logging for global services occur in the US East (N. Virginia) Region (us-east-1). Therefore, this security control for CloudFront must be deployed and maintained in us-east-1. This single deployment monitors all distributions for CloudFront. Do not deploy the security control in any other AWS Regions. (Deployment in other Regions will result in a failure to initiate CloudWatch Events and the Lambda function, and no SNS notifications.)
- This solution has gone through extensive testing with CloudFront web content distributions. It does not cover real-time messaging protocol (RTMP) streaming distributions.

## Architecture

### Target technology stack

- Lambda function
- SNS topic
- Amazon EventBridge rule

## Target architecture



## Automation and scale

- If you are using AWS Organizations, you can use [AWS CloudFormation StackSets](#) to deploy the attached template across multiple accounts that you want to monitor.

## Tools

### AWS services

- [AWS CloudFormation](#) – CloudFormation is a service that helps you model and set up AWS resources by using infrastructure as code.
- [Amazon EventBridge](#) – EventBridge delivers a stream of real-time data from your own applications, software as a service (SaaS) applications, and AWS services, routing that data to targets such as Lambda functions.
- [AWS Lambda](#) – Lambda supports running code without provisioning or managing servers.
- [Amazon S3](#) – Amazon Simple Storage Service (Amazon S3) is a highly scalable object storage service that can be used for a wide range of storage solutions, including websites, mobile applications, backups, and data lakes.
- [Amazon SNS](#) – Amazon SNS coordinates and manages the delivery or sending of messages between publishers and clients, including web servers and email addresses. Subscribers receive all messages published to the topics to which they subscribe, and all subscribers to a topic receive the same messages.

## Code

The attached code includes:

- A .zip file that contains the Lambda code (index.py)

- A CloudFormation template (.yml file) that you run to deploy the Lambda code

## Epics

### Upload the security control

Task	Description	Skills required
Create the S3 bucket for the Lambda code.	On the Amazon S3 console, create a S3 bucket with a unique name that does not contain leading slashes. An S3 bucket name is globally unique, and the namespace is shared by all AWS accounts. Your S3 bucket must be in the Region where you are planning to deploy the Lambda code.	Cloud architect
Upload the Lambda code to the S3 bucket.	Upload the Lambda code (cloudfront_ssl_log_lambda.zip file) that's provided in the <i>Attachments</i> section to the S3 bucket you created in the previous step.	Cloud architect

### Deploy the CloudFormation template

Task	Description	Skills required
Deploy the CloudFormation template.	On the AWS CloudFormation console, in the same AWS Region as the S3 bucket, deploy the CloudFormation template (cloudfront-ssl-lo	Cloud architect

Task	Description	Skills required
	gging.yml) that's provided in the <i>Attachments</i> section.	
Specify the S3 bucket name.	For the <b>S3 Bucket</b> parameter , specify the name of the S3 bucket that you created in the first epic.	Cloud architect
Specify the Amazon S3 key name for the Lambda file.	For the <b>S3 Key</b> parameter , specify the Amazon S3 location of the Lambda code .zip file in your S3 bucket. Do not include leading slashes (for example, you can enter lambda.zip or controls/lambda.zip).	Cloud architect
Provide a notification email address.	For the <b>Notification email</b> parameter, provide an email address where you would like to receive the violation notifications.	Cloud architect

Task	Description	Skills required
Define the logging level.	<p>For the <b>Lambda Logging level</b> parameter, define the logging level for your Lambda function. Choose one of the following values:</p> <ul style="list-style-type: none"><li>• <b>INFO</b> to get detailed informational messages on the application's progress.</li><li>• <b>ERROR</b> to get information about error events that could still allow the application to continue running.</li><li>• <b>WARNING</b> to get information about potentially harmful situations.</li></ul>	Cloud architect

## Confirm the subscription

Task	Description	Skills required
Confirm the subscription.	<p>When the CloudFormation template has been deployed successfully, a new SNS topic is created and a subscription message is sent to the email address you provided. You must confirm this email subscription to receive violation notifications.</p>	Cloud architect

## Related resources

- [AWS CloudFormation information](#)
- [Creating a stack on the AWS CloudFormation console](#) (CloudFormation documentation)
- [CloudFront logging](#) (CloudFront documentation)
- [Amazon S3 information](#)
- [AWS Lambda information](#)

## Attachments

To access additional content that is associated with this document, unzip the following file:  
[attachment.zip](#)



# Check for single-host network entries in security group ingress rules for IPv4 and IPv6

Created by SaiJeevan Devireddy (AWS), Ganesh Kumar (AWS), and John Reynolds (AWS)

**Environment:** Production

**Technologies:** Networking;  
Security, identity, compliance

**AWS services:** Amazon  
SNS; AWS CloudFormation;  
Amazon CloudWatch; AWS  
Lambda; Amazon VPC

## Summary

This pattern provides a security control that notifies you when Amazon Web Services (AWS) resources do not meet your specifications. It provides an AWS Lambda function that looks for single-host network entries in both Internet Protocol version 4 (IPv4) and IPv6 security group source address fields. The Lambda function is initiated when Amazon CloudWatch Events detects the Amazon Elastic Compute Cloud (Amazon EC2) [AuthorizeSecurityGroupIngress](#) API call. The custom logic in the Lambda function evaluates the subnet mask of the CIDR block of the security group ingress rule. If the subnet mask is determined to be anything other than /32 (IPv4) or /128 (IPv6), the Lambda function sends a violation notification by using Amazon Simple Notification Service (Amazon SNS).

## Prerequisites and limitations

### Prerequisites

- An active AWS account
- An email address where you want to receive the violation notifications

### Limitations

- This security monitoring solution is regional and must be deployed in each AWS Region that you want to monitor.

# Architecture

## Target technology stack

- Lambda function
- SNS topic
- Amazon EventBridge rule

## Target architecture



## Automation and scale

- If you are using AWS Organizations, you can use [AWS Cloudformation StackSets](#) to deploy this template across multiple accounts that you want to monitor.

# Tools

## AWS services

- [AWS CloudFormation](#) is a service that helps you model and set up AWS resources by using infrastructure as code.
- [Amazon EventBridge](#) delivers a stream of real-time data from your own applications, software as a service (SaaS) applications, and AWS services, and routes that data to targets such as Lambda functions.
- [AWS Lambda](#) supports running code without provisioning or managing servers.
- [Amazon Simple Storage Service \(Amazon S3\)](#) is a highly scalable object storage service that can be used for a wide range of storage solutions, including websites, mobile applications, backups, and data lakes.

- [Amazon SNS](#) coordinates and manages the delivery or sending of messages between publishers and clients, including web servers and email addresses. Subscribers receive all messages published to the topics to which they subscribe, and all subscribers to a topic receive the same messages.

## Code

The attached code includes:

- A .zip file that contains the Lambda security control code (`index.py`)
- A CloudFormation template (`security-control.yml` file) that you run to deploy the Lambda code

## Epics

### Upload the security control

Task	Description	Skills required
Create the S3 bucket for the Lambda code.	On the <a href="#">Amazon S3 console</a> , create a S3 bucket with a unique name that does not contain leading slashes. An S3 bucket name is globally unique, and the namespace is shared by all AWS accounts. Your S3 bucket must be in the AWS Region where you want to deploy the security group ingress check.	Cloud architect
Upload the Lambda code to the S3 bucket.	Upload the Lambda code ( <code>security-control-lambda.zip</code> file) that's provided in the <i>Attachments</i> section to the S3 bucket	Cloud architect

Task	Description	Skills required
	that you created in the previous step.	

## Deploy the CloudFormation template

Task	Description	Skills required
Change the Python version.	<p>Download the CloudFormation template (<code>security-control.yml</code>) that's provided in the <i>Attachments</i> section. Open the file and modify the Python version to reflect the latest version supported by Lambda (currently Python 3.9).</p> <p>For example, you can search for <code>python</code> in the code and change the value for <code>Runtime</code> from <code>python3.6</code> to <code>python3.9</code>.</p> <p>For the latest information about Python runtime version support, see the <a href="#">AWS Lambda documentation</a>.</p>	Cloud architect
Deploy the AWS CloudFormation template.	On the AWS CloudFormation console, in the same AWS Region as the S3 bucket, deploy the CloudFormation template ( <code>security-control.yml</code> ).	Cloud architect

Task	Description	Skills required
Specify the S3 bucket name.	For the <b>S3 Bucket</b> parameter , specify the name of the S3 bucket that you created in the first epic.	Cloud architect
Specify the Amazon S3 key name for the Lambda file.	For the <b>S3 Key</b> parameter , specify the Amazon S3 location of the Lambda code .zip file in your S3 bucket. Do not include leading slashes (for example, you can enter <code>lambda.zip</code> or <code>controls/lambda.zip</code> ).	Cloud architect
Provide a notification email address.	For the <b>Notification email</b> parameter, provide an email address where you would like to receive the violation notifications.	Cloud architect

Task	Description	Skills required
Define the logging level.	<p>For the <b>Lambda Logging level</b> parameter, define the logging level for your Lambda function. Choose one of the following values:</p> <ul style="list-style-type: none"><li>• <b>INFO</b> to get detailed informational messages on the application's progress.</li><li>• <b>ERROR</b> to get information about error events that could still allow the application to continue running.</li><li>• <b>WARNING</b> to get information about potentially harmful situations.</li></ul>	Cloud architect

## Confirm the subscription

Task	Description	Skills required
Confirm the subscription.	<p>When the CloudFormation template has been deployed successfully, a new SNS topic is created and a subscription message is sent to the email address you provided. You must confirm this email subscription to receive violation notifications.</p>	Cloud architect

## Related resources

- [AWS CloudFormation information](#)
- [Creating a stack on the AWS CloudFormation Console](#) (AWS CloudFormation documentation)
- [Security groups for your VPC](#) (Amazon VPC documentation)
- [Amazon S3 information](#)
- [AWS Lambda information](#)

## Attachments

To access additional content that is associated with this document, unzip the following file:  
[attachment.zip](#)

# Choose an Amazon Cognito authentication flow for enterprise applications

Created by Michael Daehnert (AWS) and Fabian Jahnke (AWS)

**Environment:** Production

**Technologies:** Security, identity, compliance

**AWS services:** Amazon Cognito

## Summary

[Amazon Cognito](#) provides authentication, authorization, and user management for web and mobile applications. It offers beneficial features for authentication of federated identities. To get it up and running, technical architects need to decide how they want to use those features.

Amazon Cognito supports multiple flows for authentication requests. These flows define how your users can verify their identity. The decision about which authentication flow to use depends on specific requirements of your application and can become complex. This pattern helps you decide which authentication flow is the best fit for your enterprise application. It assumes that you already have a basic knowledge of Amazon Cognito, OpenID Connect (OIDC), and federation, and it guides you through details about different federated authentication flows.

This solution is intended for technical decision makers. It helps you understand the different authentication flows and map them to your application requirements. Technical leads should gather the required insights to start the Amazon Cognito integrations. Because enterprise organizations mainly focus on SAML federation, this pattern includes descriptions for [Amazon Cognito user pools](#) with SAML federation.

## Prerequisites and limitations

### Prerequisites

- An active AWS account
- AWS Identity and Access Management (IAM) roles and permissions with full access to Amazon Cognito
- (Optional) Access to your identity provider (IdP), such as Microsoft Entra ID, Active Directory Federation Service (AD FS), or Okta



- A high level of expertise for your application
- Basic knowledge of Amazon Cognito, OpenID Connect (OIDC), and federation

## Limitations

- This pattern focuses on Amazon Cognito user pools and identity providers. For information about Amazon Cognito identity pools, see the [Additional information](#) section.

## Architecture

Use the following table to help you choose an authentication flow. More information about each flow is provided in this section.

Do you need machine-to-machine authentication?	Is your app a web-based application where the frontend is rendered on the server?	Is your app a single-page application (SPA) or mobile-based frontend application?	Does your application require refresh tokens for a "keep me signed in" feature?	Does the frontend offer a browser-based redirect mechanism?	Recommended Amazon Cognito flow
Yes	No	No	No	No	Client Credentials flow
No	Yes	No	Yes	Yes	Authorization Code flow
No	No	Yes	Yes	Yes	Authorization Code flow with Proof Key for Code Exchange (PKCE)

---

No	No	No	No	No	Resource Owner Password flow*
----	----	----	----	----	--

\* Resource Owner Password flow should be used only if absolutely necessary. For more information, see the *Resource Owner Password flow* section in this pattern.

### **Client Credentials flow**

The Client Credentials flow is the shortest of the Amazon Cognito flows. It should be used if systems or services communicate with each other without any user interaction. The requesting system uses the client ID and the client secret to retrieve an access token. Because both systems work without user interaction, no additional consent step is required.

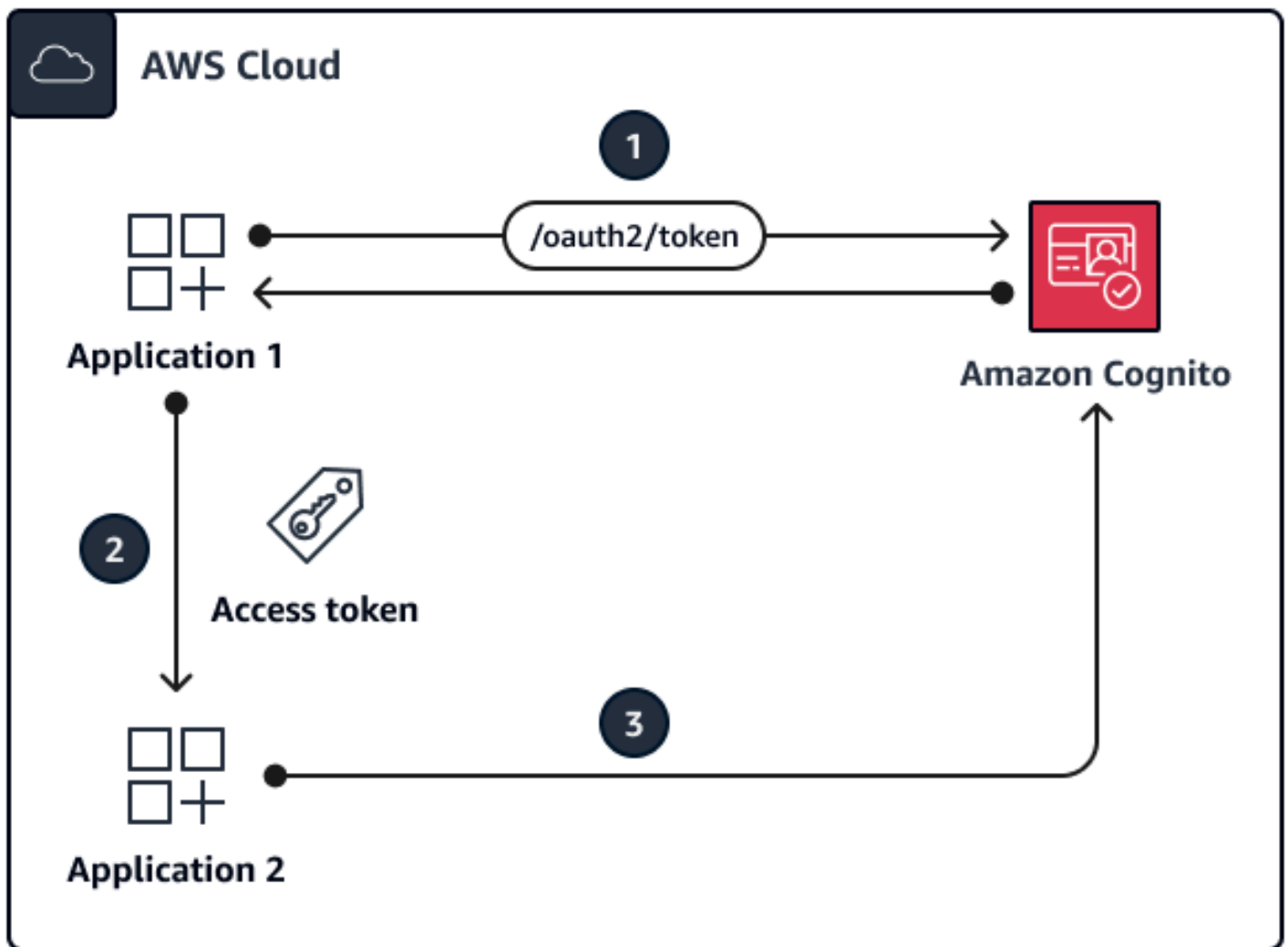

The diagram illustrates the following:

1. Application 1 sends an authentication request with the client ID and client secret to the Amazon Cognito endpoint, and it retrieves an access token.
2. Application 1 uses this access token for every subsequent call to Application 2.
3. Application 2 validates the access token with Amazon Cognito.

This flow should be used:

- For communications between applications with no user interaction

This flow should not be used:

- For any communication in which user interactions are possible

## Authorization Code flow

The Authorization Code flow is for classic web-based authentication. In this flow, the backend handles all of the token exchange and storage. The browser-based client does not see the actual tokens. This solution is used for applications written in frameworks such as .NET Core, Jakarta Faces, or Jakarta Server Pages (JSP).

The Authorization Code flow is a redirection-based flow. The client must be able to interact with the web browser or a similar client. The client is redirected to an authentication server and authenticates against this server. If the client authenticates successfully, it is redirected back to the server.

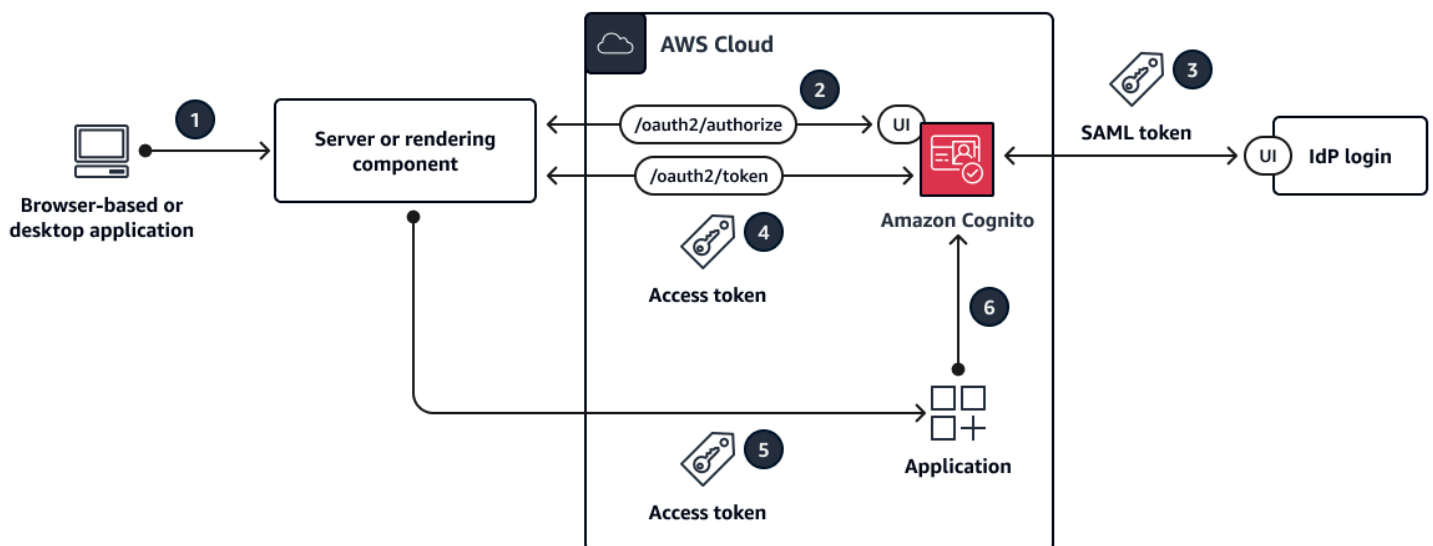

The diagram illustrates the following:

1. The client sends a request to the web server.
2. The web server redirects the client to Amazon Cognito by using an HTTP 302 status code. The client automatically follows this redirect to the configured IdP login.
3. The IdP checks for an existing browser session on the IdP side. If none exists, the user receives a prompt to authenticate by providing their username and password. The IdP responds with a SAML token to Amazon Cognito.
4. Amazon Cognito returns success with a JSON web token (JWT), specifically a code token. The web server calls `/oauth2/token` to exchange the code token for an access token. The web server sends the client ID and client secret to Amazon Cognito for validation.

5. The access token is used for every subsequent call to other applications.
6. Other applications validate the access token with Amazon Cognito.

This flow should be used:

- If the user is able to interact with the web browser or client. The application code is run and rendered on the server to make sure that no secrets are exposed to the browser.

This flow should not be used:

- For single-page applications (SPAs) or mobile apps because they're rendered on the client and shouldn't use client secrets.

### Authorization Code flow with PKCE

Authorization Code flow with Proof Key for Code Exchange (PKCE) should be used for single-page applications and mobile applications. It is the successor of the Implicit flow and is more secure because it uses PKCE. PKCE is an extension to the OAuth 2.0 authorization code grant for public clients. PKCE guards against the redemption of intercepted authorization codes.

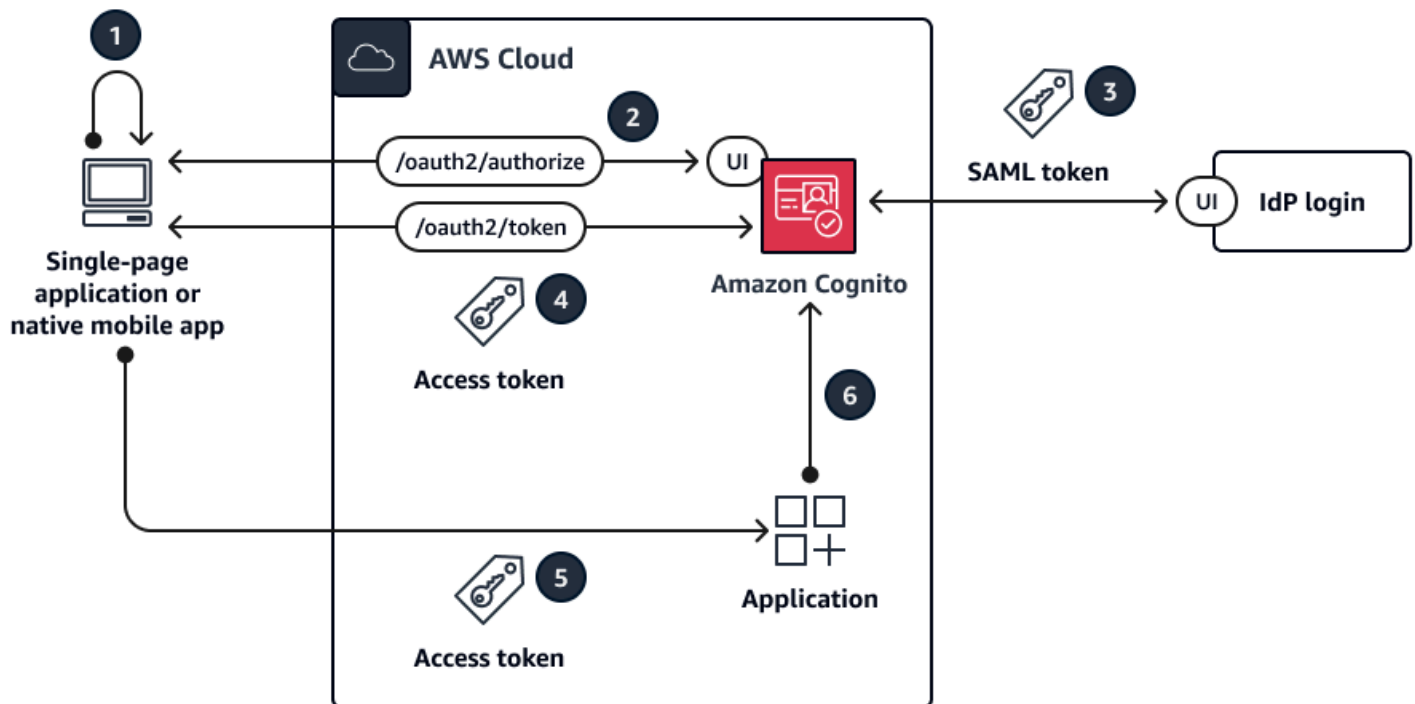

The diagram illustrates the following:

1. The application creates a code verifier and code challenge. These are well defined, unique values that are sent to Amazon Cognito for future reference.
2. The application calls the `/oauth2/authorization` endpoint of Amazon Cognito. It automatically redirects the user to the configured IdP login.
3. The IdP checks for an existing session. If none exists, the user receives a prompt to authenticate by providing their username and password. The IdP responds with a SAML token to Amazon Cognito.
4. After Amazon Cognito returns success with a code token, the web server calls `/oauth2/token` to exchange the code token for an access token.
5. The access token is used for every subsequent call to other applications.
6. The other applications validate the access token with Amazon Cognito.

This flow should be used:

- For SPAs or mobile applications

This flow should not be used:

- If the application backend handles authentication

### **Resource Owner Password flow**

The Resource Owner Password flow is intended for applications with no redirect capabilities. It is built by creating a login form in your own application. The login is checked on Amazon Cognito through a CLI or SDK call instead of relying on redirect flows. Federation is not possible in this authentication flow because federation requires browser-based redirects.

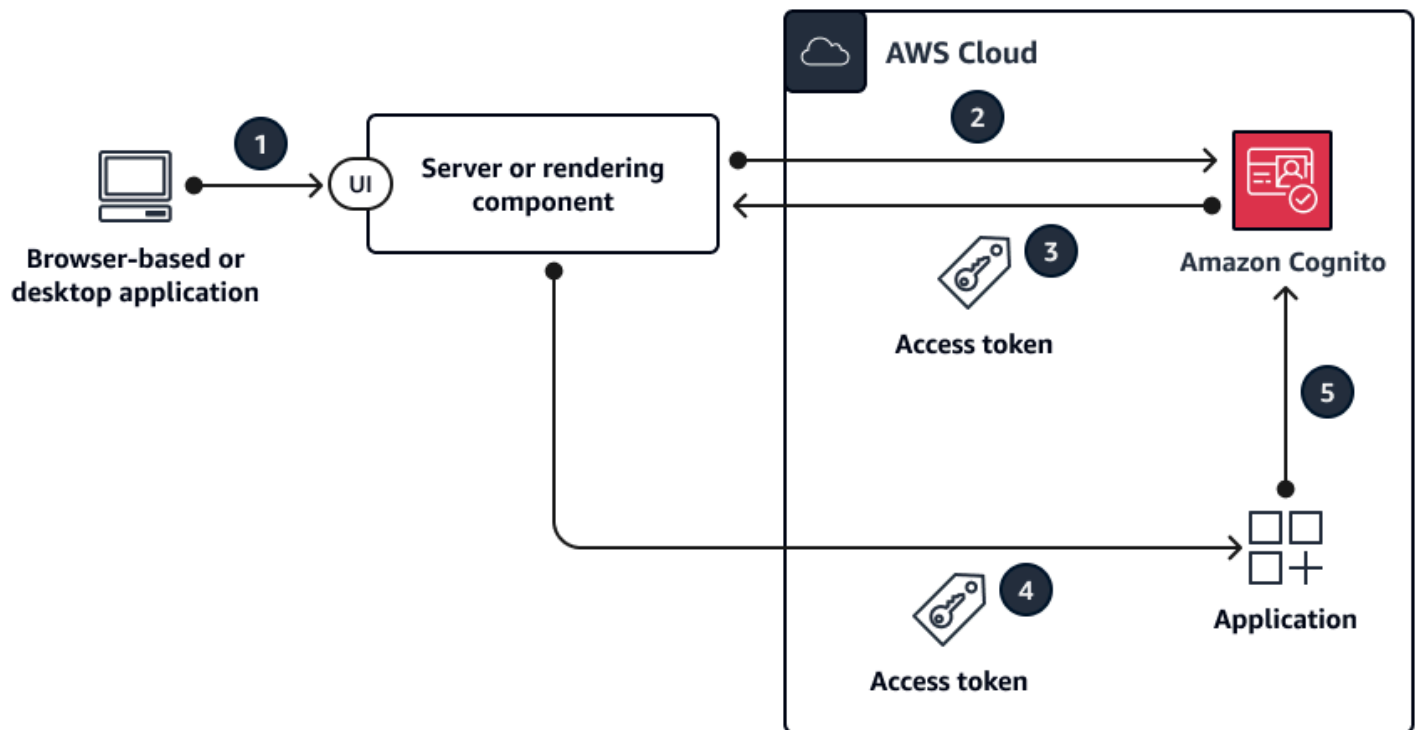

The diagram illustrates the following:

1. The user enters their credentials on a login form provided by the application.
2. The AWS Command Line Interface (AWS CLI) makes an [admin-initiated-auth](#) call to Amazon Cognito.

**Note:** Alternatively, you can use AWS SDKs instead of the AWS CLI.

3. Amazon Cognito returns an access token.
4. The access token is used for every subsequent call to other applications.
5. The other applications validate the access token with Amazon Cognito.

This flow should be used:

- When migrating existing clients that use direct authentication logic (such as basic access authentication or digest access authentication) to OAuth by converting the stored credentials to an access token

This flow should not be used:

- If you want to use federated identities

- If your application supports redirects

## Tools

### AWS services

- [Amazon Cognito](#) provides authentication, authorization, and user management for web and mobile apps.

### Other tools

- [JSON web token \(JWT\) debugger](#) is a web-based JWT validation tool.

## Epics

### Assess your application

Task	Description	Skills required
Define authentication requirements.	Assess your application according to your specific authentication requirements.	App developer, App architect
Align requirements with authentication flows.	In the <a href="#">Architecture</a> section, use the decision table and explanations of each flow to choose your Amazon Cognito authentication flow.	App developer, General AWS, App architect

### Set up the Amazon Cognito user pool

Task	Description	Skills required
Create a user pool.	1. Sign in to the AWS Management Console, and	General AWS



Task	Description	Skills required
	<p>then open the <a href="#">Amazon Cognito console</a>.</p> <ol style="list-style-type: none"> <li>2. Create a new Cognito user pool. For instructions, see <a href="#">Amazon Cognito user pools</a>.</li> <li>3. Update the user pool settings and attributes as needed. For example, set a <a href="#">password policy</a> for the user pool. Do not create app clients yet.</li> </ol>	
(Optional) Configure an identity provider.	<ol style="list-style-type: none"> <li>1. Create a SAML identity provider in the Amazon Cognito user pool. For instructions, see <a href="#">Adding and managing SAML identity providers in a user pool</a>.</li> <li>2. Configure your third-party SAML identity provider to work with federation for Amazon Cognito user pools. For more information, see <a href="#">Configuring your third-party SAML identity provider</a>. If you're using AD FS, see <a href="#">Building AD FS Federation for your Web App using Amazon Cognito User Pools</a> (AWS blog post).</li> </ol>	General AWS, Federation administrator

Task	Description	Skills required
Create an app client.	<ol style="list-style-type: none"><li>1. Create an app client for the user pool. For instructions, see <a href="#">Creating an app client</a>. Note the following:<ul style="list-style-type: none"><li>• Change settings as needed, such as token expirations.</li><li>• If your authentication flow doesn't require a client secret, then clear the <b>Generate client secret</b> checkbox.</li></ul></li><li>2. Choose <b>App client settings</b> to change its integration to a user pool login (username and password) or federated login through a SAML-based IdP.</li><li>3. Enable your IdP by defining URLs and defining OAuth flows or scopes as needed.</li></ol>	General AWS

## Integrate the application with Amazon Cognito

Task	Description	Skills required
Exchange Amazon Cognito integration details.	Depending on your authentication flow, share Amazon Cognito information with the application, such as the user pool ID and app client ID.	App developer, General AWS

Task	Description	Skills required
Implement Amazon Cognito authentication.	This depends on your chosen authentication flow, your programming language, and the frameworks you're using. For some links to get started, see the <a href="#">Related resources</a> section.	App developer

## Related resources

### AWS documentation

- [User pool authentication flow](#)
- [Verifying a JSON web token](#)
- [Access AWS services from an ASP.NET Core app using Amazon Cognito identity pools](#)
- Frameworks and SDKs:
  - [Amazon Amplify authentication](#)
  - [Amazon Cognito Identity Provider examples](#) (AWS SDK for Java 2.x documentation)
  - [Authenticating users with Amazon Cognito](#) (AWS SDK for .NET documentation)

### AWS blog posts

- [Authorization@Edge using cookies: Protect your Amazon CloudFront content from being downloaded by unauthenticated users](#)
- [Building AD FS Federation for your Web App using Amazon Cognito User Pools](#)

### Implementation partners

- [AWS Partners for authentication solutions](#)

## Additional information

### FAQ

### *Why is the Implicit flow deprecated?*

Since the release of the [OAuth 2.1 framework](#), the Implicit flow is marked as deprecated for security reasons. As an alternative, please use the Authorization Code flow with PKCE described in the [Architecture](#) section.

### *What if Amazon Cognito doesn't offer some functionality I require?*

AWS Partners offer different integrations for authentication and authorization solutions. For more information, see [AWS Partners for authentication solutions](#).

### *What about Amazon Cognito identity pool flows?*

Amazon Cognito user pools and federated identities are for authentication. Amazon Cognito identity pools are used for authorization of AWS resources access by requesting temporary AWS credentials. The ID token and access token exchange for identity pools isn't discussed in this pattern. For more information, see [What's the difference between Amazon Cognito user pools and identity pools](#) and [Common Amazon Cognito scenarios](#).

## **Next steps**

This pattern provides an overview of Amazon Cognito authentication flows. As a next step, the detailed implementation for the application's programming language needs to be chosen. Multiple languages offer SDKs and frameworks, which you can use with Amazon Cognito. For helpful references, see the [Related resources](#) section.

# Create AWS Config custom rules by using AWS CloudFormation Guard policies

Created by Andrew Lok (AWS), Kailash Havildar (AWS), Nicole Brown (AWS), and Tanya Howell (AWS)

**Code repository:** [aws-config-custom-rule-cloudformation-guard](#)

**Environment:** PoC or pilot

**Technologies:** Security, identity, compliance; Management & governance

**AWS services:** AWS CloudFormation; AWS Config

## Summary

[AWS Config](#) rules help you evaluate your AWS resources and their target configuration state. There are two types of AWS Config rules: managed and custom. You can create custom rules with AWS Lambda functions or with [AWS CloudFormation Guard](#) (GitHub), a policy-as-code language.

Rules created with Guard provide more granular control than managed rules, and they are typically easier to configure than fully custom Lambda rules. This approach provides engineers and architects the ability to build rules without needing to know Python, NodeJS, or Java, which are required to deploy custom rules through Lambda.

This pattern provides workable templates, code samples, and deployment approaches to help you adopt custom rules with Guard. By using this pattern, an administrator can use AWS Config to build custom compliance rules that have [configuration item](#) attributes. For example, developers can use Guard policies against AWS Config configuration items to continuously monitor the state of deployed AWS and non-AWS resources, detect rule violations, and automatically initiate remediation.

## Objectives

After reading this pattern, you should be able to:

- Understand how Guard policy code interacts with the AWS Config service.

- Deploy *Scenario 1*, which is an AWS Config custom rule that uses Guard syntax to validate compliance for encrypted volumes. This rule verifies that the drive is in use and verifies that the drive type is [gp3](#).
- Deploy *Scenario 2*, which is an AWS Config custom rule that uses Guard syntax to validate Amazon GuardDuty compliance. This rule verifies that GuardDuty recorders have [Amazon Simple Storage Service \(Amazon S3\) Protection](#) and [Amazon Elastic Kubernetes Service \(Amazon EKS\) Protection](#) enabled.

## Prerequisites and limitations

### Prerequisites

- An active AWS account
- AWS Config, [set up](#) in your AWS account

### Limitations

- Guard custom rules are only able to query key-value pairs in a target configuration item JSON record

## Architecture

You apply the Guard syntax to an AWS Config rule as a custom policy. AWS Config captures the hierarchical JSON of each of the resources specified. The JSON of the AWS Config configuration item contains key-value pairs. These attributes are used in the Guard syntax as variables that are assigned to their corresponding value.

The following is an explanation of the Guard syntax. The variables from the configuration item JSON are used and prepended with a % character.

```
# declare variable
let <variable name> = <'value'>

# create rule and assign condition and policy
rule <rule name> when
  <CI json key> == <"CI json value"> {
    <top level CI json key>.<next level CI json key> == %<variable name>
```

```
}
```

## Scenario 1: Amazon EBS volumes

Scenario 1 deploys an AWS Config custom rule that uses Guard syntax to validate compliance for encrypted volumes. This rule verifies that the drive is in use and verifies that the drive type is gp3.

The following is an example of an AWS Config configuration item for scenario 1. There are three key-value pairs in this configuration item that used as variables in the Guard policy: `volumeStatus`, `volumeEncryptionStatus`, and `volumeType`. Also, the `resourceType` key is used as a filter in the Guard policy.

```
{
  "version": "1.3",
  "accountId": "111111111111",
  "configurationItemCaptureTime": "2023-01-15T19:04:45.402Z",
  "configurationItemStatus": "ResourceDiscovered",
  "configurationStateId": "4444444444444444",
  "configurationItemMD5Hash": "",
  "arn": "arn:aws:ec2:us-west-2:111111111111:volume/vol-222222222222",
  "resourceType": "AWS::EC2::Volume",
  "resourceId": "vol-222222222222",
  "awsRegion": "us-west-2",
  "availabilityZone": "us-west-2b",
  "resourceCreationTime": "2023-01-15T19:03:22.247Z",
  "tags": {},
  "relatedEvents": [],
  "relationships": [
    {
      "resourceType": "AWS::EC2::Instance",
      "resourceId": "i-3333333333333333",
      "relationshipName": "Is attached to Instance"
    }
  ],
  "configuration": {
    "attachments": [
      {
        "attachTime": "2023-01-15T19:03:22.000Z",
        "device": "/dev/xvda",
        "instanceId": "i-3333333333333333",
        "state": "attached",
        "volumeId": "vol-222222222222",
        "deleteOnTermination": true,

```

```
        "associatedResource": null,
        "instanceOwningService": null
    }
],
"availabilityZone": "us-west-2b",
"createTime": "2023-01-15T19:03:22.247Z",
"encrypted": false,
"kmsKeyId": null,
"outpostArn": null,
"size": 8,
"snapshotId": "snap-5555555555555555",
"state": "in-use",
"volumeId": "vol-222222222222",
"iops": 100,
"tags": [],
"volumeType": "gp2",
"fastRestored": null,
"multiAttachEnabled": false,
"throughput": null,
"sseType": null
},
"supplementaryConfiguration": {}
}
```

The following is an example of using Guard syntax to define the variables and rules in scenario 1. In the following example:

- The first three lines define the variables by using the `let` command. They are assigned a name and value that is derived from the attributes of the configuration item.
- The `compliancecheck` rule block adds a `when` conditional dependency that looks for a `resourceType` key-value pair that matches `AWS::EC2::Volume`. If a match is found, the rule proceeds through the rest of the JSON attributes and looks for matches on the following three conditions: `state`, `encrypted`, and `volumeType`.

```
let volumestatus = 'available'
let volumetype = 'gp3'
let volumeencryptionstatus = true

rule compliancecheck when
    resourceType == "AWS::EC2::Volume" {
        configuration.state == %volumestatus
```



```
    configuration.encrypted == %volumeencryptionstatus
    configuration.volumeType == %volumetype
}
```

For the complete Guard custom policy that implements this custom rule, see [awsconfig-guard-cft.yaml](#) or [awsconfig-guard-tf-ec2vol.json](#) in the GitHub code repository. For HashiCorp Terraform code that deploys this custom policy in Guard, see [awsconfig-guard-tf-example.json](#) in the code repository.

## Scenario 2: GuardDuty compliance

Scenario 2 deploys an AWS Config custom rule that uses Guard syntax to validate Amazon GuardDuty compliance. This rule verifies that GuardDuty recorders have Amazon S3 Protection and Amazon EKS Protection enabled. It also verifies that GuardDuty findings are published every 15 minutes. This scenario could be deployed across all AWS accounts and AWS Regions in an organization (in AWS Organizations).

The following is an example of an AWS Config configuration item for scenario 2. There are three key-value pairs in this configuration item that used as variables in the Guard policy: FindingPublishingFrequency, S3Logs, and Kubernetes. Also, the resourceType key is used as a filter in the policy.

```
{
  "version": "1.3",
  "accountId": "111111111111",
  "configurationItemCaptureTime": "2023-11-27T13:34:28.888Z",
  "configurationItemStatus": "OK",
  "configurationStateId": "777777777777",
  "configurationItemMD5Hash": "",
  "arn": "arn:aws:guardduty:us-west-2:111111111111:detector/66666666666666666666666666666666",
  "resourceType": "AWS::GuardDuty::Detector",
  "resourceId": "66666666666666666666666666666666",
  "resourceName": "66666666666666666666666666666666",
  "awsRegion": "us-west-2",
  "availabilityZone": "Regional",
  "resourceCreationTime": "2020-02-17T02:48:04.511Z",
  "tags": {},
  "relatedEvents": [],
  "relationships": [],
  "configuration": {
```

```
"Enable": true,
"FindingPublishingFrequency": "FIFTEEN_MINUTES",
"DataSources": {
  "S3Logs": {
    "Enable": true
  },
  "Kubernetes": {
    "AuditLogs": {
      "Enable": true
    }
  }
},

  "Id": "66666666666666666666666666666666",
  "Tags": []
},
"supplementaryConfiguration": {
  "CreatedAt": "2020-02-17T02:48:04.511Z"
}
}
```

The following is an example of using Guard syntax to define the variables and rules in scenario 2. In the following example:

- The first three lines define the variables by using the `let` command. They are assigned a name and value that is derived from the attributes of the configuration item.
- The `compliancecheck` rule block adds a `when` conditional dependency that looks for a `resourceType` key-value pair that matches `AWS::GuardDuty::Detector`. If a match is found, the rule proceeds through the rest of the JSON attributes and looks for matches on the following three conditions: `S3Logs.Enable`, `Kubernetes.AuditLogs.Enable`, and `FindingPublishingFrequency`.

```
let s3protection = true
let kubernetesprotection = true
let publishfrequency = 'FIFTEEN_MINUTES'

rule compliancecheck when
  resourceType == "AWS::GuardDuty::Detector" {
    configuration.DataSources.S3Logs.Enable == %s3protection
    configuration.DataSources.Kubernetes.AuditLogs.Enable ==
%kubernetesprotection
```

```
configuration.FindingPublishingFrequency == %publishfrequency
}
```

For the complete Guard custom policy that implements this custom rule, see [awsconfig-guard-cft-gd.yaml](#) in the GitHub code repository. For HashiCorp Terraform code that deploys this custom policy in Guard, see [awsconfig-guard-tf-gd.json](#) in the code repository.

## Tools

### AWS services

- [AWS CloudFormation](#) helps you set up AWS resources, provision them quickly and consistently, and manage them throughout their lifecycle across AWS accounts and Regions.
- [AWS Config](#) provides a detailed view of the resources in your AWS account and how they're configured. It helps you identify how resources are related to one another and how their configurations have changed over time.

### Other tools

- [HashiCorp Terraform](#) is an open source infrastructure as code (IaC) tool that helps you use code to provision and manage cloud infrastructure and resources.

### Code repository

The code for this pattern is available in the GitHub [AWS Config with AWS CloudFormation Guard](#) repository. This code repository contains samples for both of the scenarios described in this pattern.

## Epics

### Creating AWS Config custom rules

Task	Description	Skills required
(Optional) Select key-value pairs for the rule.	Complete these steps if you are defining a custom Guard policy. If you are using one of the sample policies for	AWS administrator, Security engineer

Task	Description	Skills required
	<p>scenario 1 or 2, skip these steps.</p> <ol style="list-style-type: none"> <li>1. Sign in to the AWS Management Console and open the <a href="#">AWS Config console</a>.</li> <li>2. In the left navigation, choose <b>Resources</b>.</li> <li>3. In the resource inventory , choose the type of resource that you want to create an AWS Config custom rule for.</li> <li>4. Choose <b>View details</b>.</li> <li>5. Choose <b>View Configuration Item (JSON)</b>. This section expands to show the configuration item in JSON format.</li> <li>6. Identify the key-value pairs that you would like to build an AWS Config custom rule for.</li> </ol>	
Create the custom rule.	Using the key-value pairs that you identified previously or using one of the provided sample Guard policies, follow the instructions in <a href="#">Creating AWS Config Custom Policy Rules</a> to create a custom rule.	AWS administrator, Security engineer

Task	Description	Skills required
Validate the custom rule.	<p>Do one of the following to validate the custom Guard rule:</p> <ul style="list-style-type: none"> <li>Enter the following command in the AWS Command Line Interface (AWS CLI).</li> </ul> <pre data-bbox="625 617 1029 814">cfn-guard validate -r guard-s3.guard -d s3bucket-prod-pass.json</pre> <ul style="list-style-type: none"> <li>Follow the instructions in <i>Detective mode</i> in <a href="#">Evaluating Your Resources with AWS Config Rules</a> to deploy the rule in AWS Config. Confirm that the Guard syntax matches correctly to corresponding resources in the target account or file.</li> </ul>	AWS administrator, Security engineer

## Troubleshooting

Issue	Solution
Test the Guard policy outside of AWS Config	<p>Unit testing can be done on your local device or in an integrated development environment (IDE), such as an AWS Cloud9 IDE. To perform unit testing, do the following:</p> <ol style="list-style-type: none"> <li>1. Install the <a href="#">AWS CloudFormation Guard CLI</a> and its dependencies.</li> </ol>

Issue	Solution
	<ol style="list-style-type: none"><li>2. Save a JSON-formatted CI sample to your workstation as a .json file.</li><li>3. Save the GuardDuty policy to your workstation as a .guard file.</li><li>4. In the Guard CLI, enter the following command to validate the sample JSON file by using the Guard policy.</li></ol> <pre data-bbox="868 588 1507 745">cfn-guard validate \ -r guard-s3.guard \ -d s3bucket-prod-pass.json</pre>
Debug an AWS Config custom rule	In your Guard policy, change the <code>EnableDebugLogDelivery</code> value to <code>true</code> . The default value is <code>false</code> . The log messages are stored in Amazon CloudWatch.

## Related resources

### AWS documentation

- [Creating AWS Config Custom Policy Rules](#) (AWS Config documentation)
- [Writing AWS CloudFormation Guard rules](#) (Guard documentation)

### AWS blog posts and workshops

- [Introducing AWS CloudFormation Guard 2.0](#) (AWS blog post)

### Other resources

- [AWS CloudFormation Guard](#) (GitHub)
- [AWS CloudFormation Guard CLI documentation](#) (GitHub)

# Create a consolidated report of Prowler security findings from multiple AWS accounts

Created by Mike Virgilio (AWS), Andrea Di Fabio (AWS), and Jay Durga (AWS)

<b>Code repository:</b> <a href="#">multi-account-security-assessment-via-prowler</a>	<b>Environment:</b> Production	<b>Technologies:</b> Security, identity, compliance
<b>Workload:</b> Open-source	<b>AWS services:</b> AWS CloudFormation; Amazon EC2; AWS Identity and Access Management	

## Summary

[Prowler](#) (GitHub) is an open-source command line tool that can help you assess, audit, and monitor your Amazon Web Services (AWS) accounts for adherence to security best practices. In this pattern, you deploy Prowler in a centralized AWS account in your organization, managed by AWS Organizations, and then use Prowler to perform a security assessment of all of the accounts in the organization.

While there are many methods to deploy and utilize Prowler for an assessment, this solution has been designed for rapid deployment, full analysis of all accounts in the organization or defined target accounts, and accessible reporting of the security findings. In this solution, when Prowler completes the security assessment of all accounts in the organization, it consolidates the results. It also filters out any expected error messages, such as errors related to restrictions that prevent Prowler from scanning Amazon Simple Storage Service (Amazon S3) buckets in accounts provisioned through AWS Control Tower. The filtered, consolidated results are reported in a Microsoft Excel template that is included with this pattern. You can use this report to identify potential improvements for the security controls in your organization.

This solution was designed with the following in mind:

- The AWS CloudFormation templates reduce the effort required to deploy the AWS resources in this pattern.

- You can adjust the parameters in the CloudFormation templates and **prowler\_scan.sh** script at the time of deployment to customize the templates for your environment.
- Prowler assessment and reporting speeds are optimized through parallel processing of AWS accounts, aggregated results, consolidated reporting with recommended remediations, and automatically generated visualizations.
- The user doesn't need to monitor the scan progress. When the assessment is complete, the user is notified through an Amazon Simple Notification Service (Amazon SNS) topic so that they can retrieve the report.
- The report template helps you read and assess only the relevant results for your entire organization.

## Prerequisites and limitations

### Prerequisites

- An AWS account for hosting security services and tools, managed as a member account of an organization in AWS Organizations. In this pattern, this account is referred to as the *security account*.
- In the security account, you must have a private subnet with outbound internet access. For instructions, see [VPC with servers in private subnets and NAT](#) in the Amazon Virtual Private Cloud (Amazon VPC) documentation. You can establish internet access by using an [NAT gateway](#) that is provisioned in a public subnet.
- Access to the AWS Organizations management account or an account that has delegated administrator permissions for CloudFormation. For instructions, see [Register a delegated administrator](#) in the CloudFormation documentation.
- Enable trusted access between AWS Organizations and CloudFormation. For instructions, see [Enable trusted access with AWS Organizations](#) in the CloudFormation documentation.

### Limitations

- The target AWS accounts must be managed as an organization in AWS Organizations. If you are not using AWS Organizations, you can update the **IAM-ProwlerExecRole.yaml** CloudFormation template and the **prowler\_scan.sh** script for your environment. Instead, you provide a list of AWS account IDs and Regions where you want to run the script.



- The CloudFormation template is designed to deploy the Amazon Elastic Compute Cloud (Amazon EC2) instance in a private subnet that has outbound internet access. The AWS Systems Manager Agent (SSM Agent) requires outbound access to reach the AWS Systems Manager service endpoint, and you need outbound access to clone the code repository and install dependencies. If you want to use a public subnet, you must modify the `proowler-resources.yaml` template to associate an [Elastic IP address](#) with the EC2 instance.

## Product versions

- Prowler version 4.0 or later

## Architecture

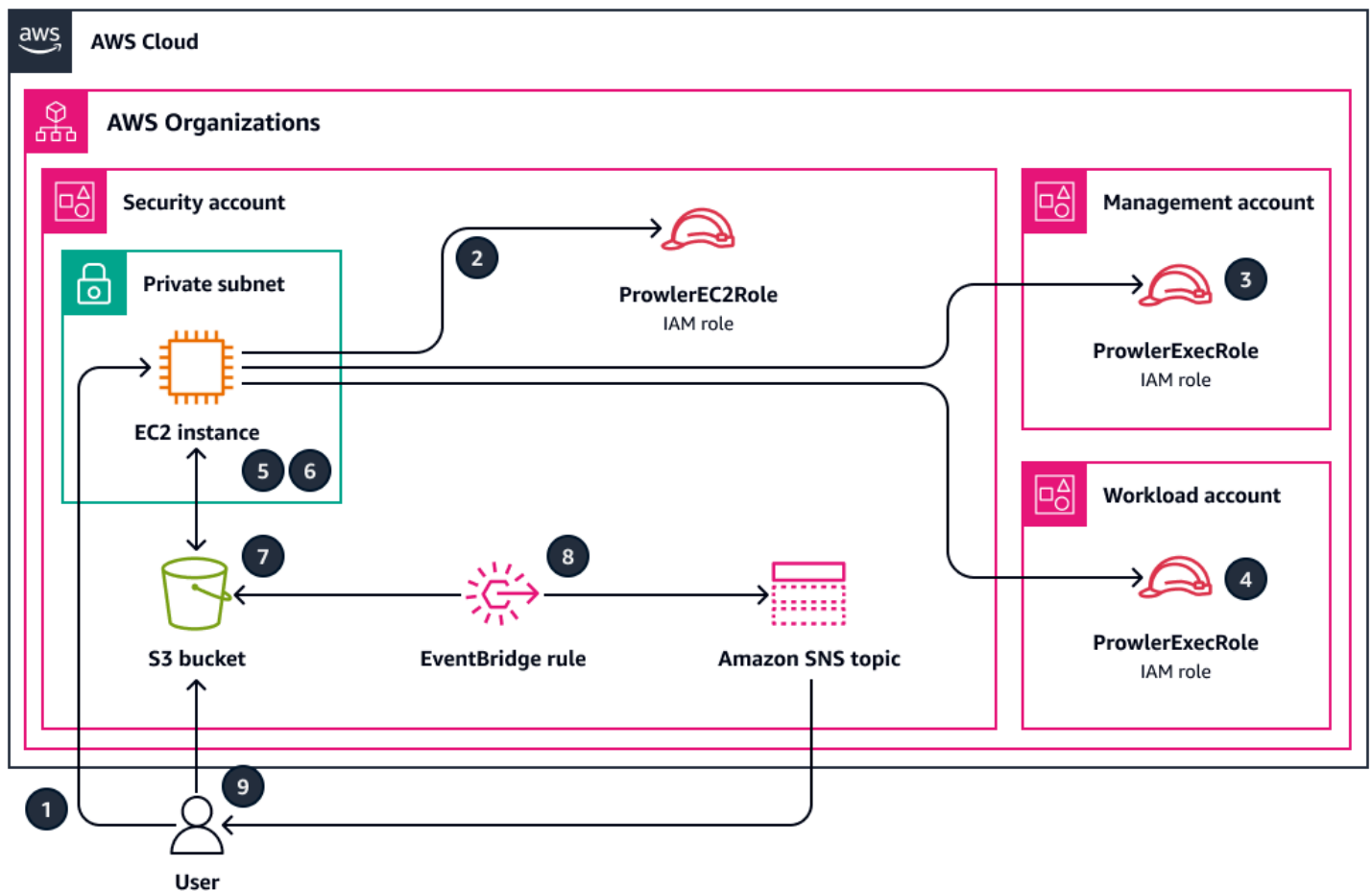

The diagram shows the following process:

1. Using Session Manager, a capability of AWS Systems Manager, the user authenticates to the EC2 instance and runs the `proowler_scan.sh` script. This shell script performs steps 2–8.
2. The EC2 instance assumes the `ProwlerEC2Role` IAM role, which grants permissions to access the S3 bucket and to assume the `ProwlerExecRole` IAM roles in the other accounts in the organization.
3. The EC2 instance assumes the `ProwlerExecRole` IAM role in the organization's management account and generates a list of the accounts in the organization.
4. The EC2 instance assumes the `ProwlerExecRole` IAM role in the organization's member accounts (called *workload accounts* in the architecture diagram) and performs a security assessment in each account. The findings are stored as CSV and HTML files on the EC2 instance.

**Note:** HTML files are an output of the Prowler assessment. Due to the nature of HTML, they aren't concatenated, processed, or used directly in this pattern. However, these might be useful for individual account report review.

5. The EC2 instance processes all of the CSV files to remove known, expected errors and consolidates the remaining findings into a single CSV file.
6. The EC2 instance packages the individual account results and aggregated results into a zip file.
7. The EC2 instance uploads the zip file to the S3 bucket.
8. An EventBridge rule detects the file upload and uses an Amazon SNS topic to send an email to the user notifying them that the assessment is complete.
9. The user downloads the zip file from the S3 bucket. The user imports the results into the Excel template and reviews the results.

## Tools

### AWS services

- [Amazon Elastic Compute Cloud \(Amazon EC2\)](#) provides scalable computing capacity in the AWS Cloud. You can launch as many virtual servers as you need and quickly scale them up or down.
- [Amazon EventBridge](#) is a serverless event bus service that helps you connect your applications with real-time data from a variety of sources. For example, AWS Lambda functions, HTTP invocation endpoints using API destinations, or event buses in other AWS accounts.
- [AWS Identity and Access Management \(IAM\)](#) helps you securely manage access to your AWS resources by controlling who is authenticated and authorized to use them.

- [AWS Organizations](#) is an account management service that helps you consolidate multiple AWS accounts into an organization that you create and centrally manage.
- [Amazon Simple Notification Service \(Amazon SNS\)](#) helps you coordinate and manage the exchange of messages between publishers and clients, including web servers and email addresses.
- [Amazon Simple Storage Service \(Amazon S3\)](#) is a cloud-based object storage service that helps you store, protect, and retrieve any amount of data.
- [AWS Systems Manager](#) helps you manage your applications and infrastructure running in the AWS Cloud. It simplifies application and resource management, shortens the time to detect and resolve operational problems, and helps you manage your AWS resources securely at scale. This pattern uses Session Manager, a capability of Systems Manager.

## Other tools

- [Prowler](#) is an open-source command-line tool that helps you assess, audit, and monitor your accounts for adherence to AWS security best practices and other security frameworks and standards.

## Code repository

The code for this pattern is available in the GitHub [Multi-Account Security Assessment via Prowler](#) repository. The code repository contains the following files:

- **prowler\_scan.sh** – This bash script is used to start a Prowler security assessment of multiple AWS accounts, in parallel. As defined in the **Prowler-resources.yaml** CloudFormation template, this script is automatically deployed to the `usr/local/prowler` folder on the EC2 instance.
- **Prowler-Resources.yaml** – You use this CloudFormation template to create a stack in the security account in the organization. This template deploys all of the required resources for this account in order to support the solution. This stack must be deployed before the **IAM-ProwlerExecRole.yaml** template. We do not recommend that you deploy these resources in an account that hosts critical production workloads.

**Note:** If this stack is deleted and redeployed, you must rebuild the `ProwlerExecRole` stack set in order to rebuild the cross-account dependencies between the IAM roles.

- **IAM-ProwlerExecRole.yaml** – You use this CloudFormation template to create a stack set that deploys the `ProwlerExecRole` IAM role in all accounts in the organization, including the management account.
- **prowler-report-template.xlsm** – You use this Excel template to process the Prowler findings. The pivot tables in the report provide search capabilities, charts, and consolidated findings.

## Epics

### Prepare for deployment

Task	Description	Skills required
Clone the code repository.	<ol style="list-style-type: none"> <li>1. In a command-line interface, change your working directory to the location where you want to store the sample files.</li> <li>2. Enter the following command:   <pre>git clone https://github.com/aws-samples/multi-account-security-assessment-via-prowler.git</pre> </li> </ol>	AWS DevOps
Review the templates.	<ol style="list-style-type: none"> <li>1. In the cloned repository, open the <b>Prowler-Resources.yaml</b> and <b>IAM-ProwlerExecRole.yaml</b> files.</li> <li>2. Review the resources created by these templates and adjust the templates as needed for your environment. For more</li> </ol>	AWS DevOps

Task	Description	Skills required
	<p>information, see <a href="#">Working with templates</a> in the CloudFormation documentation.</p> <p>3. Save and close the <b>Prowler-Resources.yaml</b> and <b>IAM-ProwlerExecRole.yaml</b> files.</p>	

## Create the CloudFormation stacks

Task	Description	Skills required
<p>Provision resources in the security account.</p>	<p>Using the <b>prowler-resources.yaml</b> template, you create a CloudFormation stack that deploys all of the required resources in the security account. For instructions, see <a href="#">Creating a stack</a> in the CloudFormation documentation. Note the following when deploying this template:</p> <ol style="list-style-type: none"> <li>1. On the <b>Specify template</b> page, choose <b>Template is ready</b>, and then upload the <b>prowler-resources.yaml</b> file.</li> <li>2. On the <b>Specify stack details</b> page, in the <b>Stack name</b> box, enter <code>Prowler-Resources</code> .</li> </ol>	<p>AWS DevOps</p>

Task	Description	Skills required
	<p>3. In the <b>Parameters</b> section, enter the following:</p> <ul style="list-style-type: none"><li>• <b>VPCId</b> – Select a VPC in the account.</li><li>• <b>SubnetId</b> – Select a private subnet that has internet access.</li></ul> <p><i>Note:</i> If you select a public subnet, the EC2 instance won't be assigned a public IP address because the CloudFormation template, by default, doesn't provision and attach an Elastic IP address.</p> <ul style="list-style-type: none"><li>• <b>InstanceType</b> – Select an instance size based on the number of parallel assessments:<ul style="list-style-type: none"><li>• For 10, choose <code>r6i.large</code> .</li><li>• For 12, choose <code>r6i.xlarge</code> .</li><li>• For 14–18, choose <code>r6i.2xlarge</code> .</li></ul></li><li>• <b>InstanceImageId</b> – Leave the default for Amazon Linux.</li><li>• <b>KeyPairName</b> – If you're using SSH for</li></ul>	

Task	Description	Skills required
	<p>access, specify the name of an existing key pair.</p> <ul style="list-style-type: none"><li>• <code>PermittedSSHInbound</code> – If you're using SSH for access, specify a permitted CIDR block. If you're not using SSH, keep the default value of <code>127.0.0.1</code>.</li><li>• <code>BucketName</code> – The default value is <code>prowler-output-&lt;accountID&gt;-&lt;region&gt;</code>. You can modify this as needed. If you specify a custom value, the account ID and Region are automatically appended to the specified value.</li><li>• <code>EmailAddress</code> – Specify an email address for an Amazon SNS notification when Prowler completes the assessment and uploads the .zip file to the S3 bucket.</li></ul> <p><i>Note:</i> The SNS subscription configuration must be confirmed prior to Prowler completing the</p>	

Task	Description	Skills required
	<p>assessment or a notification will not be sent.</p> <ul style="list-style-type: none"> <li>• <code>IAMProwlerEC2Role</code> <ul style="list-style-type: none"> <li>– Keep the default unless your naming conventions require a different name for this IAM role.</li> </ul> </li> <li>• <code>IAMProwlerExecRole</code> <ul style="list-style-type: none"> <li>– Keep the default unless another name will be used when deploying the <b>IAM-ProwlerExecRole.yaml</b> file.</li> </ul> </li> <li>• <code>Parallelism</code> – Specify the number of parallel assessments to perform. Make sure that the value in the <code>InstanceType</code> parameter supports this number of parallel assessments.</li> <li>• <code>FindingOutput</code> – If you want to exclude pass results, select <code>FailOnly</code>. This significantly reduces the output size and focuses on the checks that might need to be resolved. If you want to include pass results, select <code>FailAndPass</code>.</li> </ul> <p>4. On the <b>Review</b> page, select <b>The following resource</b>(</p>	



Task	Description	Skills required
	<p>s) <b>require capabilities: [AWS::IAM::Role]</b>, and then choose <b>Create Stack</b>.</p> <p>5. After the stack has been successfully created, in the CloudFormation console, on the <b>Outputs</b> tab, copy the <code>ProwlerEC2Role</code> Amazon Resource Name (ARN). You use this ARN later when deploying the <b>IAM-ProwlerExecRole.yaml</b> file.</p>	

Task	Description	Skills required
Provision the IAM role in the member accounts.	<p>In the AWS Organizations management account or an account with delegated administrator permissions for CloudFormation, use the <b>IAM-ProwlerExecRole.yaml</b> template to create a CloudFormation stack set. The stack set deploys the <code>ProwlerExecRole</code> IAM role in all member accounts in the organization. For instructions, see <a href="#">Create a stack set with service-managed permissions</a> in the CloudFormation documentation. Note the following when deploying this template:</p> <ol style="list-style-type: none"><li>1. Under <b>Prepare template</b>, choose <b>Template is ready</b>, and then upload the <b>IAM-ProwlerExecRole.yaml</b> file.</li><li>2. On the <b>Specify StackSet details</b> page, name the stack set <code>IAM-ProwlerExecRole</code>.</li><li>3. In the <b>Parameters</b> section, enter the following:<ul style="list-style-type: none"><li>• <b>AuthorizedARN</b> – Enter the <code>ProwlerEC2Role</code> ARN, which you copied when you</li></ul></li></ol>	AWS DevOps

Task	Description	Skills required
	<p>created the Prowler-R resources stack.</p> <ul style="list-style-type: none"><li>• <code>ProwlerExecRoleName</code> – Keep the default value of <code>ProwlerExecRole</code> unless another name was used when deploying the <b>Prowler-R resources.yaml</b> file.</li></ul> <ol style="list-style-type: none"><li>4. Under <b>Permissions</b>, choose <b>Service-managed permissions</b>.</li><li>5. On the <b>Set deployment options</b> page, under <b>Deployment targets</b>, choose <b>Deploy to organization</b> and accept all defaults.</li></ol> <p><i>Note:</i> If you want the stacks deployed to all member accounts simultaneously, set <b>Maximum concurrent accounts</b> and <b>Failure tolerance</b> to a high value, such as 100.</p> <ol style="list-style-type: none"><li>6. Under <b>Deployment regions</b>, choose the AWS Region where the EC2 instance for Prowler is deployed. Because IAM resources are global and not Regional, this deploys</li></ol>	

Task	Description	Skills required
	<p>the IAM role in all active Regions.</p> <p>7. On the <b>Review</b> page, select <b>I acknowledge that AWS CloudFormation might create IAM resources with custom names</b>, and then choose <b>Create StackSet</b>.</p> <p>8. Monitor the <b>Stack instances</b> tab (for individual account status) and the <b>Operations</b> tab (for overall status) to determine when the deployment is complete.</p>	

Task	Description	Skills required
Provision the IAM role in the management account.	<p>Using the <b>IAM-ProwlerExecRole.yaml</b> template, you create a CloudFormation stack that deploys the <code>ProwlerExecRole</code> IAM role in the management account of the organization. The stack set you created previously doesn't deploy the IAM role in the management account. For instructions, see <a href="#">Creating a stack</a> in the CloudFormation documentation. Note the following when deploying this template:</p> <ol style="list-style-type: none"><li>1. On the <b>Specify template</b> page, choose <b>Template is ready</b>, and then upload the <b>IAM-ProwlerExecRole.yaml</b> file.</li><li>2. On the <b>Specify stack details</b> page, in the <b>Stack name</b> box, enter <code>IAM-ProwlerExecRole</code>.</li><li>3. In the <b>Parameters</b> section, enter the following:<ul style="list-style-type: none"><li>• <b>AuthorizedARN</b> – Enter the <code>ProwlerEC2Role</code> ARN, which you copied when you created the <code>Prowler-Resources</code> stack.</li></ul></li></ol>	AWS DevOps

Task	Description	Skills required
	<ul style="list-style-type: none"> <li>• <code>ProwlerExecRoleName</code> – Keep the default value of <code>ProwlerExecRole</code> unless another name was used when deploying the <b>Prowler-Resources.yaml</b> file.</li> </ul> <p>4. On the <b>Review</b> page, select <b>The following resource(s) require capabilities: [AWS::IAM::Role]</b>, and then choose <b>Create Stack</b>.</p>	

## Perform the Prowler security assessment

Task	Description	Skills required
Run the scan.	<ol style="list-style-type: none"> <li>1. Sign in to the security account in the organization.</li> <li>2. Using Session Manager, connect to the EC2 instance for Prowler that you previously provisioned. For instructions, see <a href="#">Connect to your Linux instance using Session Manager</a>. If you're unable to connect, see the <a href="#">Troubleshooting</a> section of this pattern.</li> </ol>	AWS administrator

Task	Description	Skills required
	<ol style="list-style-type: none"><li>3. Navigate to <code>usr/local/prowler</code>, and then open the <b><code>prowler_scan.sh</code></b> file.</li><li>4. Review and modify the adjustable parameters and variables in this script as needed for your environment. For more information about customization options, see the comments at the beginning of the script.  For example, instead of getting a list of all member accounts in the organization from the management account, you can modify the script to specify the AWS account IDs or AWS Regions that you want to scan, or you can reference an external file that contains these parameters.</li><li>5. Save and close the <b><code>prowler_scan.sh</code></b> file.</li><li>6. Enter the following commands. This runs the <b><code>prowler_scan.sh</code></b> script.</li></ol> <pre data-bbox="630 1680 1029 1852">sudo -i screen cd /usr/local/ prowler</pre>	

Task	Description	Skills required
	<pre>./prowler_scan.sh</pre> <p>Note the following:</p> <ul style="list-style-type: none"><li>• The screen command permits the script to continue running in the event that the connection times out or you lose console access.</li><li>• After the scan starts, you can force a screen detach by pressing <b>Ctrl+A D</b>. The screen detaches, and you can close the instance connection and allow the assessment to proceed.</li><li>• To resume a detached session, connect to the instance, enter <code>sudo -i</code> then enter <code>screen -r</code>.</li><li>• To monitor progress of the individual account assessments, you can navigate to the <code>usr/local/prowler</code> directory and enter the command <code>tail -f output/stdout-&lt;account-id&gt; .</code></li></ul> <p>7. Wait for Prowler to complete scans in all accounts. The script assesses multiple accounts</p>	



Task	Description	Skills required
	<p>at the same time. When the assessment is complete in all accounts, you receive a notification if you specified an email address when you deployed the <b>Prowler-Resources.yaml</b> file.</p>	
Retrieve the Prowler findings.	<ol style="list-style-type: none"><li>1. Download the <code>prowler-output-&lt;assessDate&gt;.zip</code> file from the <code>prowler-output-&lt;accountID&gt;-&lt;region&gt;</code> bucket. For instructions, see <a href="#">Downloading an object</a> in the Amazon S3 documentation.</li><li>2. Delete all objects in the bucket, including the file you downloaded. This is a best practice for cost optimization and to make sure that you can delete the Prowler-Resources CloudFormation stack at any time. For instructions, see <a href="#">Deleting objects</a> in the Amazon S3 documentation.</li></ol>	General AWS

Task	Description	Skills required
Stop the EC2 instance.	To prevent billing while the instance is idle, stop the EC2 instance that runs Prowler. For instructions, see <a href="#">Stop and start your instances</a> in the Amazon EC2 documentation.	AWS DevOps

## Create a report of the findings

Task	Description	Skills required
Import the findings.	<ol style="list-style-type: none"> <li>1. In Excel, open the <b>prowler-report-template.xlsx</b> file, and then choose the <b>Prowler CSV</b> worksheet.</li> <li>2. Delete all of the sample data, including the header row. If you are asked whether to delete the query associated with the data being removed, choose <b>No</b>. Deleting the query can affect the functionality of the pivot tables in the Excel template.</li> <li>3. Extract the contents of the zip file you download from the S3 bucket.</li> <li>4. In Excel, open the <b>prowler-fullorgresults-accsdeniedfiltered.txt</b>. We recommended that you</li> </ol>	General AWS

Task	Description	Skills required
	<p>use this file because the most common, non-actionable errors have already been removed, such as Access Denied errors related to attempted scans of AWS Control Tower resources. If you want the unfiltered findings, open the <b>prowler-fullorgresulsts.txt</b> file instead.</p> <ol style="list-style-type: none"><li>5. Select column A.</li><li>6. If you're using Windows, enter <b>Ctrl+C</b>, or if you're using MacOS, enter <b>Cmd +C</b>. This copies all of the data to the clipboard.</li><li>7. In the Excel report template, on the <b>Prowler CSV</b> worksheet, select cell A1.</li><li>8. If you're using Windows, enter <b>Ctrl+V</b>, or if you're using MacOS, enter <b>Cmd +V</b>. This pastes the findings into the report.</li><li>9. Confirm all of the cells containing pasted data are selected. If not, select column A.</li><li>10 On the <b>Data</b> tab, choose <b>Text to Columns</b>.</li></ol>	

Task	Description	Skills required
	<p>11 In the wizard, do the following:</p> <ul style="list-style-type: none"><li>• For step 1, choose <b>Delimited</b>.</li><li>• For step 2, for <b>Delimiters</b>, choose <b>Semicolon</b>. In the <b>Data preview</b> pane, confirm that the data is being separated into columns.</li><li>• For step 3, choose <b>Finish</b>.</li></ul> <p>12 Confirm that the text data is delimited across multiple columns.</p> <p>13 Save the Excel report with a new name.</p> <p>14 Search and delete any Access Denied errors in the findings. For instructions about how to remove these programmatically, see <i>Programmatically removing errors</i> in the <a href="#">Additional information</a> section.</p>	

Task	Description	Skills required
Finalize the report.	<ol style="list-style-type: none"><li>1. Choose the <b>Findings</b> worksheet, and then select cell A17. This cell is the header of the pivot table.</li><li>2. In the ribbon, under <b>PivotTable Tools</b>, choose <b>Analyze</b>, and then under <b>Refresh</b>, choose <b>Refresh All</b>. This updates the pivot tables with the new data set.</li><li>3. By default, Excel does not properly display AWS account numbers. To fix the number formatting, do the following:<ul style="list-style-type: none"><li>• On the <b>Findings</b> worksheet, open the context (right-click) menu for column A, and then choose <b>Format Cells</b>.</li><li>• Choose <b>Number</b>, and in <b>Decimal places</b>, enter 0.</li><li>• Choose <b>OK</b>.</li></ul><p><i>Note:</i> If an AWS account number starts with one or more zeros, Excel automatically removes the zeros. If you see an account number that is less than 12 digits in the report, the missing digits are zeros</p></li></ol>	General AWS

Task	Description	Skills required
	<p>at the beginning of the number.</p> <p>4. (Optional) You can collapse fields to make the findings easier to read. Do the following:</p> <ul style="list-style-type: none"> <li>• On the <b>Findings</b> worksheet, if you move the cursor to the line between rows 18 and 19 (the space between the critical header and the first finding), the cursor icon changes to a small arrow pointing down.</li> <li>• Click to select all finding fields.</li> <li>• Open the context (right-click) menu, find <b>Expand/Collapse</b>, and then choose <b>Collapse</b>.</li> </ul> <p>5. For details about the assessment, review the <b>Findings, Severity, and Pass Fail</b> worksheets.</p>	

### (Optional) Update Prowler or the resources in the code repository

Task	Description	Skills required
Update Prowler.	If you want to update Prowler to the latest version, do the following:	General AWS

Task	Description	Skills required
	<ol style="list-style-type: none"><li data-bbox="592 212 1024 485">1. Connect to the EC2 instance for Prowler by using Session Manager. For instructions, see <a href="#">Connect to your Linux instance using Session Manager</a>.</li><li data-bbox="592 506 911 583">2. Enter the following command.</li></ol> <pre data-bbox="634 632 1029 785">sudo -i pip3 install --upgrade prowler</pre>	

Task	Description	Skills required
Update the <code>prowler_scan.sh</code> script.	<p>If you want to update the <b>prowler_scan.sh</b> script to the latest version in the repo, do the following:</p> <ol style="list-style-type: none"><li>1. Connect to the EC2 instance for Prowler by using Session Manager. For instructions, see <a href="#">Connect to your Linux instance using Session Manager</a>.</li><li>2. Enter the following command. <pre>sudo -i</pre></li><li>3. Navigate to the Prowler script directory. <pre>cd /usr/local/prowler</pre></li><li>4. Enter the following command to stash the local script so that you can merge custom changes into the newest version. <pre>git stash</pre></li><li>5. Enter the following command to get the latest version of the script. <pre>git pull</pre></li></ol>	General AWS



Task	Description	Skills required
	<p>6. Enter the following command to merge the custom script with the latest version of the script.</p> <pre data-bbox="630 426 1027 506">git stash pop</pre> <p><b>Note:</b> You might receive warnings related to any locally generated files that are not in the GitHub repo, such as finding reports. You can ignore these as long as the <b>prowler_scan.sh</b> shows that the locally stashed changes are merged back in.</p>	

### (Optional) Clean up

Task	Description	Skills required
Delete all deployed resources.	<p>You can leave the resources deployed in the accounts. If you shut down the EC2 instance when it is not in use and keep the S3 bucket empty, this reduces the costs of maintaining the resources for future scans.</p> <p>If you want to deprovision all resources, do the following:</p>	AWS DevOps

Task	Description	Skills required
	<ol style="list-style-type: none"><li data-bbox="592 212 1008 531">1. Delete the IAM-ProwlerExecRole stack provisioned in the management account. For instructions, see <a href="#">Deleting a stack</a> in the CloudFormation documentation.</li><li data-bbox="592 558 1019 1016">2. Delete the IAM-ProwlerExecRole stack set provisioned in the organization's management account or in the delegated administrator account. For instructions, see <a href="#">Delete a stack set</a> in the CloudFormation documentation.</li><li data-bbox="592 1043 1008 1310">3. Delete all objects in the prowler-output S3 bucket. For instructions, see <a href="#">Deleting objects</a> in the Amazon S3 documentation.</li><li data-bbox="592 1337 1008 1656">4. Delete the Prowler-Resources stack provisioned in the security account. For instructions, see <a href="#">Deleting a stack</a> in the CloudFormation documentation.</li></ol>	

## Troubleshooting

Issue	Solution
Unable to connect to the EC2 instance by using Session Manager.	The SSM Agent must be able to communicate with the Systems Manager endpoint. Do the following: <ol style="list-style-type: none"><li data-bbox="829 506 1498 590">1. Validate the subnet where the EC2 instance is deployed has internet access.</li><li data-bbox="829 611 1227 653">2. Reboot the EC2 instance.</li></ol>
When deploying the stack set, the CloudFormation console prompts you to Enable trusted access with AWS Organizations to use service-managed permissions .	This indicates that trusted access has not been enabled between AWS Organizations and CloudFormation. Trusted access is required to deploy the service-managed stack set. Choose the button to enable trusted access. For more information, see <a href="#">Enable trusted access</a> in the CloudFormation documentation.

## Related resources

### AWS documentation

- [Implementing security controls on AWS](#) (AWS Prescriptive Guidance)

### Other resources

- [Prowler](#) (GitHub)

## Additional information

### Programmatically removing errors

If the results contain Access Denied errors, you should remove them from the findings. These errors are typically due to external influencing permissions that prevent Prowler from assessing a particular resource. For example, some checks fail when reviewing S3 buckets provisioned through

AWS Control Tower. You can programmatically extract these results and save the filtered results as a new file.

The following commands remove rows that contain a single text string (a pattern) and then output the results to a new file.

- For Linux or MacOS (Grep)

```
grep -v -i "Access Denied getting bucket" myoutput.csv > myoutput_modified.csv
```

- For Windows (PowerShell)

```
Select-String -Path myoutput.csv -Pattern 'Access Denied getting bucket' -NotMatch > myoutput_modified.csv
```

The following commands removes rows that match more than one text string and then output the results to a new file.

- For Linux or MacOS (Uses an escaped pipe between strings)

```
grep -v -i 'Access Denied getting bucket\|Access Denied Trying to Get' myoutput.csv > myoutput_modified.csv
```

- For Windows (Uses a comma between strings)

```
Select-String -Path myoutput.csv -Pattern 'Access Denied getting bucket', 'Access Denied Trying to Get' -NotMatch > myoutput_modified.csv
```

## Report examples

The following image is an example of the **Findings** worksheet in the report of consolidated Prowler findings.

ACCOUNT_NAME	ACCOUNT_ID	STATUS	SEVERITY	REGION	SERVICE_NAME	SUBSERVICE_NAME	CATEGORIES
116263	116263	FAIL	critical	ap-northeast-1	acm	api	forensics-ready
160299	160299	INFO	high	ap-northeast-2	apigateway	ebs	internet-exposed
203916	203916	PASS	low	ap-northeast-3	appstream	endpoint	secrets
230091	230091		medium	ap-south-1	cloudformation	flow_log	trustboundaries
274463	274463			ap-southeast-1	cloudfront	instance	(blank)
288225	288225			ap-southeast-2	cloudtrail	logs	
412964	412964			ca-central-1	cloudwatch	networkacl	
432567	432567			eu-central-1	codebuild	rest_api	

Findings	Count
critical	532
Find secrets in Lambda functions variables.	315
Find secrets in Lambda functions code.	96
Find secrets in CloudFormation outputs	34
Check if EFS have policies which allow access to everyone	25
Ensure hardware MFA is enabled for the root account	24
Ensure that no custom IAM policies exist which allow permissive role assumption (e.g. sts:AssumeRole on *)	19
Check if secrets exists in ECS task definitions environment variables	10
Ensure that all the expired SSL/TLS certificates stored in AWS IAM are removed.	3
Check if SQS queues have policy set as Public	2
Ensure there are no Public Accessible RDS instances.	2
Ensure there are no S3 buckets open to Everyone or Any AWS user.	1
Ensure no root account access key exists	1
high	7155
Ensure IAM Service Roles prevents against a cross-service confused deputy attack	4598
Ensure there are no Security Groups without ingress filtering being used.	691
Check if SNS topics have policy set as Public	672
Ensure there are no SNS Topics unencrypted	437
Ensure that your Amazon WorkSpaces storage volumes are encrypted in order to meet security and compliance requirements	297
Ensure no Customer Managed IAM policies allow actions that may lead into Privilege Escalation	203
Ensure no security groups allow Ingress from 0.0.0.0/0 or :::0 to any port.	102
Ensure no security groups allow ingress from 0.0.0.0/0 or :::0 to Kafka port 9092.	83
Check if ACM Certificates are about to expire in specific days or less	54

The following image is an example of the **Pass Fail** worksheet in the report of consolidated Prowler findings. (By default, pass results are excluded from the output.)

ACCOUNT_NAME	ACCOUNT_ID	STATUS	SEVERITY	REGION	SERVICE_NAME	SUBSERVICE_NAME	CATEGORIES
116263	1162633	FAIL	critical	ap-northeast-1	accessanalyzer	ami	forensics-ready
160299	1602998	INFO	high	ap-northeast-2	acm	api	internet-exposed
203916	2039167	PASS	low	ap-northeast-3	apigateway	ebs	secrets
230091	2300910		medium	ap-south-1	appstream	endpoint	trustboundaries
274463	2744637			ap-southeast-1	autoscaling	flow_log	(blank)
288225	2882252			ap-southeast-2	cloudformation	instance	
412964	4129648			ca-central-1	cloudfront	logs	
432567	4325678			eu-central-1	cloudtrail	networkacl	

Row Labels	Count of STATUS
<b>FAIL</b>	<b>71822</b>
critical	532
high	7155
low	3357
medium	60778
<b>PASS</b>	<b>140965</b>
critical	43187
high	41821
low	1963
medium	53994
<b>Grand Total</b>	<b>212787</b>

  

Category	Count	Percentage
FAIL critical	532	0.25%
FAIL high	7155	3.3%
FAIL low	3357	2.9%
FAIL medium	60778	28.6%
PASS critical	43187	20.3%
PASS high	41821	19.7%

The following image is an example of the **Severity** worksheet in the report of consolidated Prowler findings.

ACCOUNT_NAME	ACCOUNT_ID	STATUS	SEVERITY	REGION	SERVICE_NAME	SUBSERVICE_NAME	CATEGORIES
1162633	1162633	FAIL	critical	ap-northeast-1	accessanalyzer	api	forensics-ready
1602998	1602998	INFO	high	ap-northeast-2	acm	ebs	internet-exposed
2039167	2039167	PASS	low	ap-northeast-3	apigateway	endpoint	secrets
2300910	2300910		medium	ap-south-1	appstream	flow_log	trustboundaries
2744632	2744632			ap-southeast-1	cloudformation	instance	(blank)
2882252	2882252			ap-southeast-2	cloudfront	logs	
4129648	4129648			ca-central-1	cloudtrail	networkacl	
4325678	4325678			eu-central-1	cloudwatch	rest_api	

Row Labels	Count of STATUS
critical	532
FAIL	532
high	7155
FAIL	7155
low	3357
FAIL	3357
medium	60778
FAIL	60778
<b>Grand Total</b>	<b>71822</b>

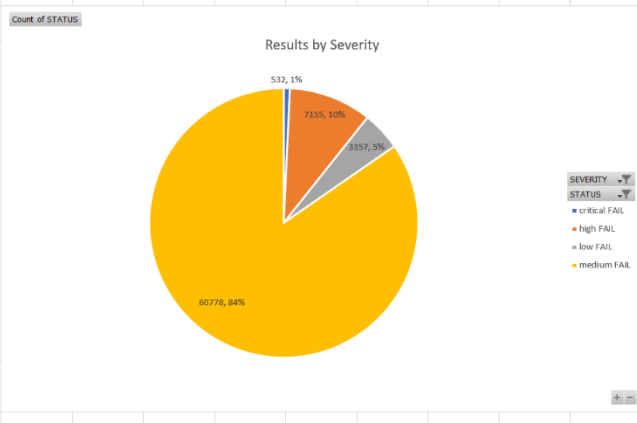

# Delete unused Amazon Elastic Block Store (Amazon EBS) volumes by using AWS Config and AWS Systems Manager

Created by Sankar Sangubotla (AWS)

**Environment:** PoC or pilot

**Technologies:** Security, identity, compliance; Management & governance; Cost management

**AWS services:** AWS Config; AWS Systems Manager

## Summary

The lifecycle of an Amazon Elastic Block Store (Amazon EBS) volume is typically independent from the lifecycle of the Amazon Elastic Compute Cloud (Amazon EC2) instance to which it is attached. Unless you select **Delete on Termination** option at the time of launch, terminating the EC2 instance detaches the EBS volume but doesn't delete it. Especially in development and testing environments where it's common to launch and terminate EC2 instances, this can result in a large number of unutilized EBS volumes. EBS volumes accrue charges in your Amazon Web Services (AWS) account, regardless of whether they're being used. Deleting these volumes can help you optimize costs for your AWS accounts. In addition, deleting unused EBS volumes is a security best practice to prevent access to any unused, potentially sensitive, data in those volumes.

AWS Config can help you manually or automatically remediate noncompliant resources. This pattern describes how to configure an AWS Config rule and automatic remediation action that deletes unused Amazon EBS volumes in the account. The remediation action is a predefined runbook for Automation, a capability of AWS Systems Manager. You can configure the runbook to create a snapshot of the volume before deleting it.

## Prerequisites and limitations

### Prerequisites

- An active AWS account.
- AWS Identity and Access Management (IAM) permissions to run the `AWSConfigRemediation-DeleteUnusedEBSVolume` runbook for Automation, a capability of AWS Systems

Manager. For more information, see *Required IAM permissions* in [AWSConfigRemediation-DeleteUnusedEBSVolume](#).

- One or more unused Amazon EBS volumes.

## Limitations

- The unused Amazon EBS volumes must be in the available state.

## Architecture

### Technology stack

- AWS Config
- Amazon EBS
- Systems Manager
- Systems Manager Automation

### Target architecture



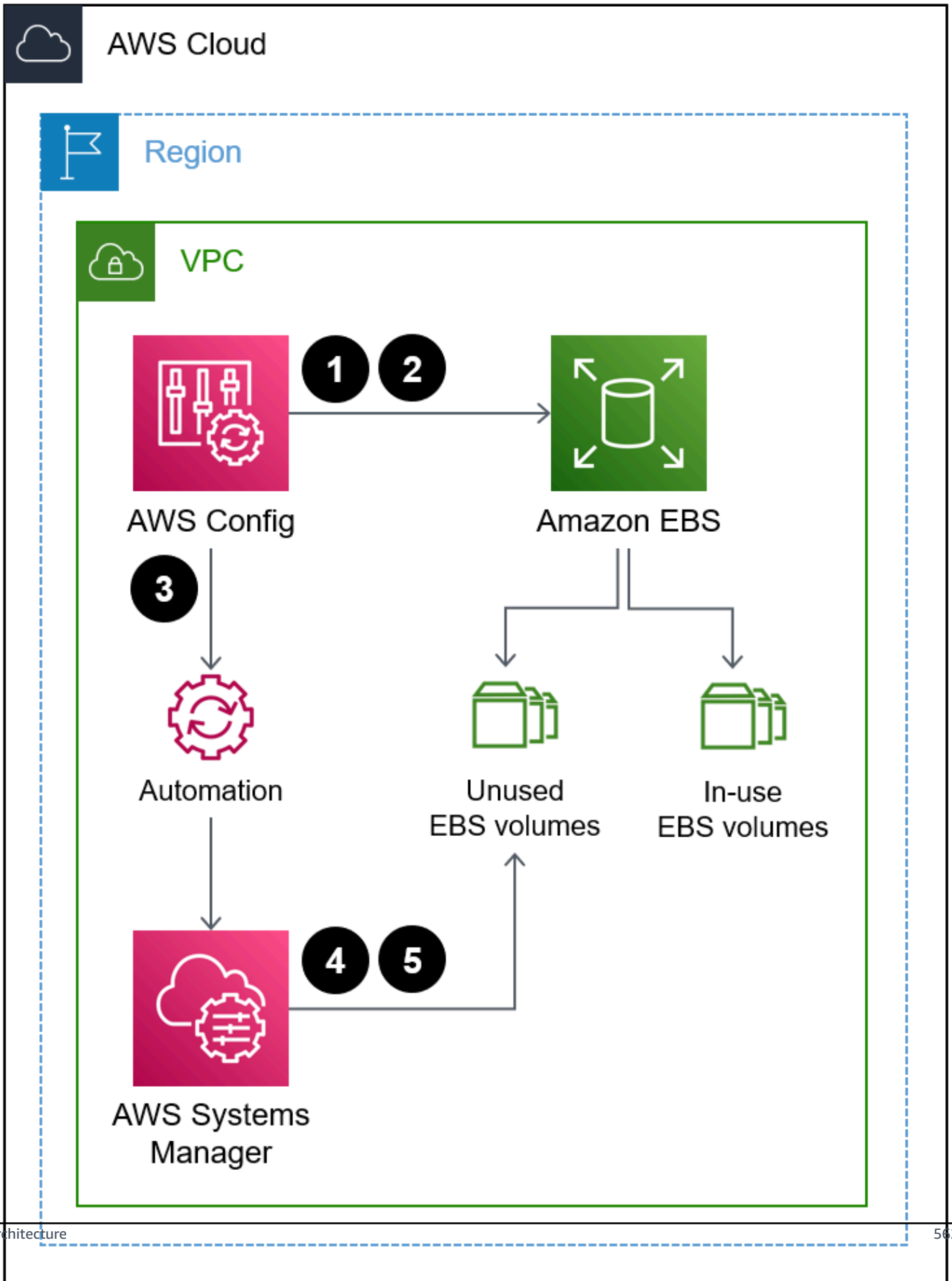

1. The AWS Config rule evaluates the EBS volumes.
2. The rule returns a list of compliant and noncompliant resources. EBS volumes that are in the `available` state, which are unused volumes, are determined to be noncompliant.
3. AWS Config automatically starts the Automation runbook.
4. If configured, Systems Manager creates snapshots of the unused volumes before deleting them.
5. Systems Manager deletes the unused EBS volumes.

## Automation and scale

You can apply this solution across all accounts in your organization. For more information, see [Managing rules across all accounts in your organization](#) in the AWS Config documentation.

## Tools

- [AWS Config](#) provides a detailed view of the resources in your AWS account and how they're configured. It helps you identify how resources are related to one another and how their configurations have changed over time.
- [AWS Systems Manager](#) helps you manage your applications and infrastructure running in the AWS Cloud. It simplifies application and resource management, shortens the time to detect and resolve operational problems, and helps you manage your AWS resources securely at scale.
- [AWS Systems Manager Automation](#) simplifies common maintenance, deployment, and remediation tasks for many AWS services.

## Epics

### Configure the AWS Config rule

Task	Description	Skills required
Create a role for the Automation runbook.	Create a role called <code>AssumeRole</code> . Systems Manager Automation uses this role to run the runbook. For instructions, see <a href="#">Configuring a service role (assume role) access for automations</a> in the	AWS systems administrator

Task	Description	Skills required
	Systems Manager documentation.	
Turn on the AWS Config recorder.	Follow the instructions in <a href="#">Setting Up AWS Config with the Console</a> in the AWS Config documentation to make sure that AWS Config is running and it is configured to record Amazon EBS volumes.	AWS systems administrator
Run the rule.	<ol style="list-style-type: none"><li>1. Follow the instructions in <a href="#">Evaluating your resources</a> in the AWS Config documentation to run the <code>ec2-volume-inuse-check</code> rule. Wait for the evaluation to complete.</li><li>2. On the <b>Rules</b> page, select the <code>ec2-volume-inuse-check</code> rule, and then for <b>Resources in scope</b>, choose <b>Noncompliant</b>.</li><li>3. Confirm that there are one or more unused Amazon EBS volumes in the evaluation results.</li></ol>	AWS systems administrator

## Configure automatic remediation of unused Amazon EBS volumes

Task	Description	Skills required
Add the automatic remediation action.	<ol style="list-style-type: none"><li>1. On the Rules page, select the <code>ec2-volume-inuse-check</code> rule.</li><li>2. Follow the instructions in <a href="#">Setting up automatic remediation</a> in the AWS Config documentation. Note the following:</li><li>3. In the <b>Remediation action details</b> section, choose <code>AWSConfigRemediation-DeleteUnusedEBSVolume</code>.<ul style="list-style-type: none"><li>• Select <b>Resource ID parameter</b>, and then in the list, choose <b>Volumeld</b>. At runtime, this parameter is substituted with the ID of the noncompliant EBS volume.</li><li>• In the <b>Parameters</b> section, provide values for the following parameters:<ul style="list-style-type: none"><li>• <code>CreateSnapshot</code> – (Optional) If set to <code>true</code>, the automation creates a snapshot of the EBS volume before it's deleted.</li></ul></li></ul></li></ol>	AWS systems administrator

Task	Description	Skills required
	<ul style="list-style-type: none"> <li>• Automatio nAssumeRole – Enter the Amazon Resource Name (ARN) of the AssumeRole service role that you created previously.</li> </ul>	
Test the automatic remediation for the AWS Config rule.	<ol style="list-style-type: none"> <li>1. In the AWS Config Console, on the <b>Rules</b> page, select the <code>ec2-volume-inuse-check</code> rule.</li> <li>2. In the <b>Actions</b> menu, choose <b>Re-evaluate</b>.</li> <li>3. Allow the rule to evaluate the non-compliant resources, and then confirm that the unused Amazon EBS volumes are deleted.</li> </ol>	AWS systems administrator

## Troubleshooting

Issue	Solution
AWS Config doesn't accurately reflect the resource state.	Sometimes, AWS Config doesn't update the state of the resources. Turn the recorder off and then turn it back on again on the AWS Config <b>Settings</b> page. The recorder captures the state of the resources. For newly created or deleted resources, it might take some time for the recorder to reflect the current state. For more information about EBS volume

Issue	Solution
	states, see <a href="#">Volume state</a> in the Amazon EC2 documentation.

## Related resources

- [AWSConfigRemediation-DeleteUnusedEBSVolume runbook](#)
- [ec2-volume-inuse-check rule](#)
- [Remediating noncompliant AWS resources with AWS Config rules](#)

# Deploy and manage AWS Control Tower controls by using AWS CDK and AWS CloudFormation

Created by Iker Reina Fuente (AWS) and Ivan Girardi (AWS)

**Code repository:** [aws-control-tower-controls-cdk](#)

**Environment:** Production

**Technologies:** Security, identity, compliance; CloudNative; Infrastructure; Management & governance

**AWS services:** AWS CloudFormation; AWS Control Tower; AWS Organizations; AWS CDK

## Summary

This pattern describes how to use AWS CloudFormation and AWS Cloud Development Kit (AWS CDK) to implement and administer preventive, detective, and proactive AWS Control Tower controls as infrastructure as code (IaC). A [control](#) (also known as a *guardrail*) is a high-level rule that provides ongoing governance for your overall AWS Control Tower environment. For example, you can use controls to require logging for your AWS accounts and then configure automatic notifications if specific security-related events occur.

AWS Control Tower helps you implement preventive, detective, and proactive controls that govern your AWS resources and monitor compliance across multiple AWS accounts. Each control enforces a single rule. In this pattern, you use a provided IaC template to specify which controls you want to deploy in your environment.

AWS Control Tower controls apply to an entire [organizational unit \(OU\)](#), and the control affects every AWS account within the OU. Therefore, when users perform any action in any account in your landing zone, the action is subject to the controls that govern the OU.

Implementing AWS Control Tower controls helps establish a strong security foundation for your AWS landing zone. By using this pattern to deploy the controls as IaC through CloudFormation and AWS CDK, you can standardize the controls in your landing zone and more efficiently deploy and

manage them. This solution uses [cdk\\_nag](#) to scan the AWS CDK application during deployment. This tool checks the application for adherence to AWS best practices.

To deploy AWS Control Tower controls as IaC, you can also use HashiCorp Terraform instead of AWS CDK. For more information, see [Deploy and manage AWS Control Tower controls by using Terraform](#).

## Target audience

This pattern is recommended for users who have experience with AWS Control Tower, CloudFormation, AWS CDK, and AWS Organizations.

## Prerequisites and limitations

### Prerequisites

- Active AWS accounts managed as an organization in AWS Organizations and an AWS Control Tower landing zone. For instructions, see [Create an account structure](#) (AWS Well-Architected Labs).
- AWS Command Line Interface (AWS CLI), [installed](#) and [configured](#).
- Node package manager (npm), [installed and configured](#) for the AWS CDK.
- [Prerequisites](#) for AWS CDK.
- Permissions to assume an existing AWS Identity and Access Management (IAM) role in a deployment account.
- Permissions to assume an IAM role in the organization's management account that that can be used to bootstrap AWS CDK. The role must have permissions to modify and deploy CloudFormation resources. For more information, see [Bootstrapping](#) in the AWS CDK documentation.
- Permissions to create IAM roles and policies in the organization's management account. For more information, see [Permissions required to access IAM resources](#) in the IAM documentation.
- Apply the service control policy (SCP)-based control with the identifier **CT.CLOUDFORMATION.PR.1**. This SCP must be activated to deploy proactive controls. For instructions, see [Disallow management of resource types, modules, and hooks within the AWS CloudFormation registry](#).

### Limitations



- This pattern provides instructions for deploying this solution across AWS accounts, from a deployment account to the organization's management account. For testing purposes, you can deploy this solution directly in the management account, but instructions for this configuration are not explicitly provided.

## Product versions

- Python version 3.9 or later
- npm version 8.9.0 or later

## Architecture

### Target architecture

This section provides a high-level overview of this solution and the architecture established by the sample code. The following diagram shows controls deployed across the various accounts in the OU.

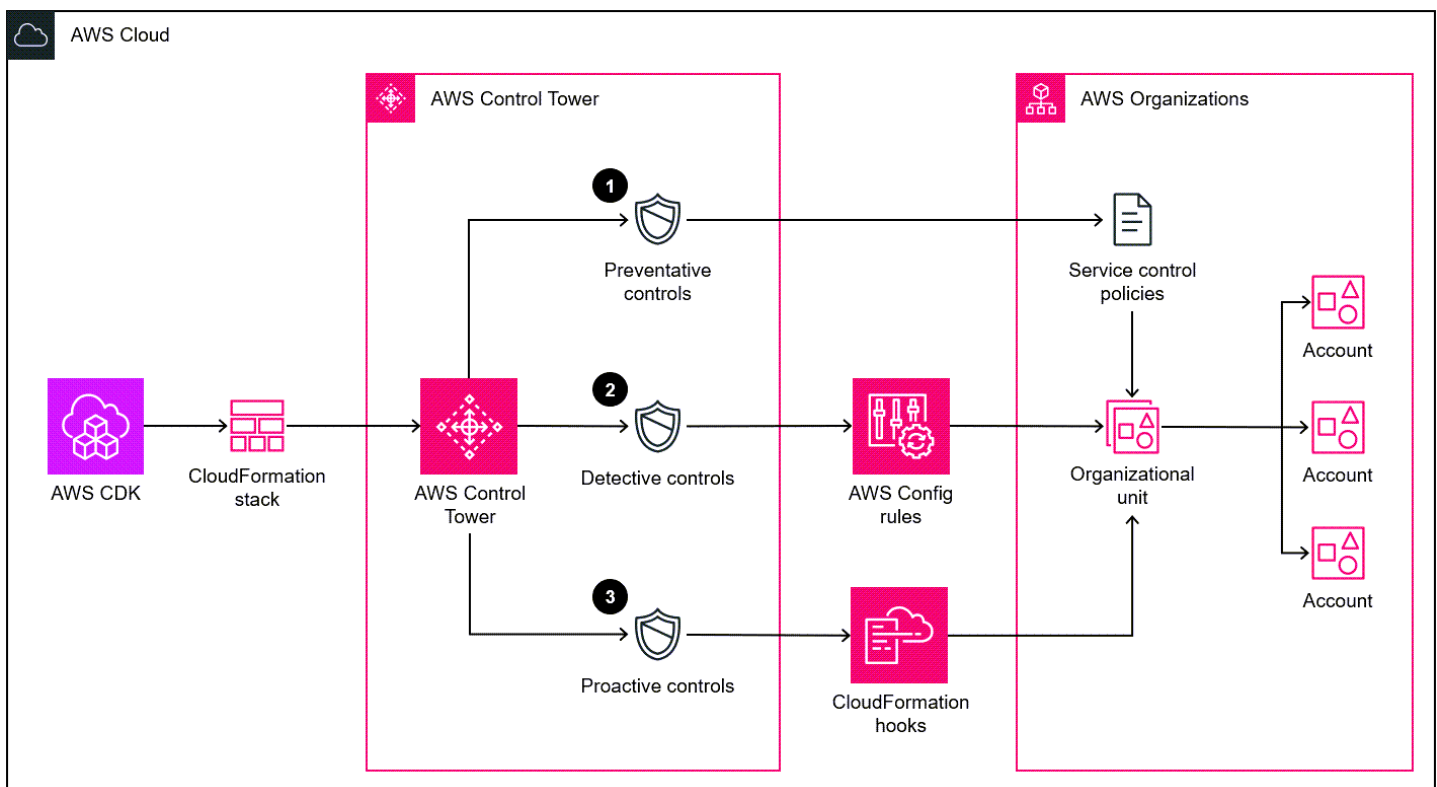

AWS Control Tower controls are categorized according to their *behavior* and their *guidance*.

There are three primary types of control behaviors:

1. *Preventive controls* are designed to prevent actions from occurring. These are implemented with [service control policies \(SCPs\)](#) in AWS Organizations. The status of a preventive control is either **enforced** or **not enabled**. Preventive controls are supported in all AWS Regions.
2. *Detective controls* are designed to detect specific events when they occur and log the action in CloudTrail. These are implemented with [AWS Config rules](#). The status of a detective control is either **clear**, **in violation**, or **not enabled**. Detective controls apply only in those AWS Regions supported by AWS Control Tower.
3. *Proactive controls* scan resources that would be provisioned by AWS CloudFormation and check whether they are compliant with your company policies and objectives. Resources that are not compliant will not be provisioned. These are implemented with [AWS CloudFormation hooks](#). The status of a proactive control is **PASS**, **FAIL**, or **SKIP**.

Control *guidance* refers to the recommended practice for how to apply each control to your OUs. AWS Control Tower provides three categories of guidance: *mandatory*, *strongly recommended*, and *elective*. The guidance of a control is independent of its behavior. For more information, see [Control behavior and guidance](#).

## Tools

### AWS services

- [AWS Cloud Development Kit \(AWS CDK\)](#) is a software development framework that helps you define and provision AWS Cloud infrastructure in code. The [AWS CDK Toolkit](#) is the primary tool for interacting with your AWS CDK app.
- [AWS CloudFormation](#) helps you set up AWS resources, provision them quickly and consistently, and manage them throughout their lifecycle across AWS accounts and Regions.
- [AWS Config](#) provides a detailed view of the resources in your AWS account and how they're configured. It helps you identify how resources are related to one another and how their configurations have changed over time.
- [AWS Control Tower](#) helps you set up and govern an AWS multi-account environment, following prescriptive best practices.
- [AWS Organizations](#) is an account management service that helps you consolidate multiple AWS accounts into an organization that you create and centrally manage.

## Other tools

- [cdk\\_nag](#) is an open-source tool that uses a combination of rule packs to check AWS Cloud Development Kit (AWS CDK) applications for adherence to best practices.
- [npm](#) is a software registry that runs in a Node.js environment and is used to share or borrow packages and manage deployment of private packages.
- [Python](#) is a general-purpose computer programming language.

## Code repository

The code for this pattern is available in the GitHub [Deploy AWS Control Tower controls using AWS CDK](#) repository. You use the `cdk.json` file to interact with the AWS CDK app, and you use the `package.json` file to install the npm packages.

## Best practices

- Follow the [principle of least-privilege](#) (IAM documentation). The sample IAM policy and trust policy provided in this pattern include the minimum permissions required, and the AWS CDK stacks created in the management account are restricted by these permissions.
- Follow the [Best practices for AWS Control Tower administrators](#) (AWS Control Tower documentation).
- Follow the [Best practices for developing and deploying cloud infrastructure with the AWS CDK](#) (AWS CDK documentation).
- When bootstrapping the AWS CDK, customize the bootstrap template to define policies and the trusted accounts that should have the ability to read and write to any resource in the management account. For more information, see [Customizing bootstrapping](#).
- Use code analysis tools, such as [cfn\\_nag](#), to scan the generated CloudFormation templates. The cfn-nag tool looks for patterns in CloudFormation templates that might indicate the infrastructure is not secure. You can also use cdk-nag to check your CloudFormation templates by using the [cloudformation-include](#) module.

# Epics

## Prepare to enable the controls

Task	Description	Skills required
Create the IAM role in the management account.	<ol style="list-style-type: none"><li data-bbox="592 415 1027 972">1. Create an IAM policy in the management account with the permissions defined in <i>IAM policy</i> in the <a href="#">Additional information</a> section. For instructions, see <a href="#">Creating IAM policies</a> in the IAM documentation. Make note of the Amazon Resource Name (ARN) of the policy. The following is an example ARN.<div data-bbox="630 1010 1027 1209" style="border: 1px solid #ccc; border-radius: 10px; padding: 10px; margin: 10px 0;"><pre>arn:aws:iam::&lt;MANAGEMENT-ACCOUNT-ID&gt;:policy/&lt;POLICY-NAME&gt;</pre></div></li><li data-bbox="592 1224 1027 1873">2. Create an IAM role in the management account, attach the IAM permission policy that you created in the previous step, and attach the custom trust policy in <i>Trust policy</i> in the <a href="#">Additional information</a> section. For instructions, see <a href="#">Creating a role using custom trust policies</a> in the IAM documentation. The following is an example ARN for the new role.</li></ol>	DevOps engineer, General AWS

Task	Description	Skills required
	<pre>arn:aws:iam::   &lt;MANAGEMENT-ACCOUN T-ID&gt;:role/&lt;ROLE-N AME&gt;</pre>	

Task	Description	Skills required
Bootstrap AWS CDK.	<ol style="list-style-type: none"><li>1. In the management account, assume a role that has permissions to bootstrap AWS CDK.</li><li>2. Enter the following command, replacing the following:<ul style="list-style-type: none"><li>• &lt;MANAGEMENT-ACCOUNT-ID&gt; is the ID of the organization's management account.</li><li>• &lt;AWS-CONTROL-TOWER-REGION&gt; is the AWS Region where Control Tower is deployed. For a complete list of Region codes, see <a href="#">Regional endpoints</a> in <i>AWS General Reference</i>.</li><li>• &lt;DEPLOYMENT-ACCOUNT-ID&gt; is the ID of the deployment account.</li><li>• &lt;DEPLOYMENT-ROLE-NAME&gt; is the name of the IAM role you are using the deployment account.</li><li>• &lt;POLICY-NAME&gt; is the name of the policy you created in the management account.</li></ul></li></ol> <pre data-bbox="634 1745 1029 1877">\$ npx cdk bootstrap aws://&lt;MANAGEMENT- ACCOUNT-ID&gt;/&lt;AWS-C</pre>	DevOps engineer, General AWS, Python

Task	Description	Skills required
<p>Clone the repository.</p>	<pre data-bbox="634 205 1027 743"> CONTROL-TOWER-REGION&gt; \ --trust arn:aws:iam::&lt;DEPLOYMENT-ACCOUNT-ID&gt;:role/&lt;DEPLOYMENT-ROLE-NAME&gt; \ --cloudformation-execution-policies arn:aws:iam::&lt;MANAGEMENT-ACCOUNT-ID&gt;:policy/&lt;POLICY-NAME&gt; </pre> <p data-bbox="589 779 1008 1052">In a bash shell, enter the following command. This clones the <a href="#">Deploy AWS Control Tower controls using AWS CDK</a> repository from GitHub.</p> <pre data-bbox="589 1094 1027 1295"> git clone https://github.com/aws-samples/aws-control-tower-controls-cdk.git </pre>	<p>DevOps engineer, General AWS</p>

Task	Description	Skills required
Edit the AWS CDK configuration file.	<ol style="list-style-type: none"><li>1. In the cloned repository, open the <b>constants.py</b> file.</li><li>2. In the <code>ACCOUNT_ID</code> parameter, enter the ID of your management account.</li><li>3. In the <code>&lt;AWS-CONTROL-TOWER-REGION&gt;</code> parameter, enter AWS Region where AWS Control Tower is deployed.</li><li>4. In the <code>ROLE_ARN</code> parameter, enter the ARN of the role you created in the management account.</li><li>5. In the <code>GUARDRAILS_CONFIGURATION</code> section, in the <code>Enable-Control</code> parameter, enter the control API identifiers. Enter the identifier in double quotation marks, and separate multiple identifiers with commas. Each control has a unique API identifier for each Region in which AWS Control Tower is available. To find the control identifier, do the following:<ol style="list-style-type: none"><li>a. In <a href="#">Tables of control metadata</a>, locate the control you want to enable.</li></ol></li></ol>	



Task	Description	Skills required
	<p>b. In the <b>Control API identifiers, by Region</b> column, locate the API identifier for the Region in which you are making the API call, such as <code>arn:aws:controltower:us-east-1::control/AWS-GR_ENCRYPTED_VOLUMES</code> .</p> <p>c. Extract the control identifier from the Regional identifier, such as <code>AWS-GR_ENCRYPTED_VOLUMES</code> .</p> <p>6. In the <b>GUARDRAILS_CONFIGURATION</b> section, in the <code>OrganizationalUnitIds</code> parameter, enter the ID of the organizational unit where you want to enable the control, such as <code>ou-1111-11111111</code> . Enter the ID in double quotation marks, and separate multiple IDs with commas. For more information about how to retrieve OU IDs, see <a href="#">Viewing the details of an OU</a>.</p>	

Task	Description	Skills required
	<p>7. Save and close the <b>constants.py</b> file. For an example of an updated <b>constants.py</b> file, see the <a href="#">Additional information</a> section of this pattern.</p>	

## Enable controls in the management account

Task	Description	Skills required
Assume the IAM role in the deployment account.	In the deployment account, assume the IAM role that has permissions to deploy the AWS CDK stacks in the management account. For more information about assuming an IAM role in the AWS CLI, see <a href="#">Use an IAM role in the AWS CLI</a> .	DevOps engineer, General AWS
Activate the environment.	<p>If you are using Linux or MacOS:</p> <ol style="list-style-type: none"> <li>1. Enter the following command to create a virtual environment.</li> </ol> <pre style="border: 1px solid #ccc; border-radius: 10px; padding: 10px; margin: 10px 0;">\$ python3 -m venv .venv</pre> <ol style="list-style-type: none"> <li>2. After the virtual environment is created, enter the following command to activate it.</li> </ol>	DevOps engineer, General AWS

Task	Description	Skills required
	<pre data-bbox="634 212 1027 327">\$ source .venv/bin/activate</pre> <p data-bbox="591 396 963 432">If you are using Windows:</p> <ol data-bbox="591 478 963 604" style="list-style-type: none"><li>1. Enter the following command to activate a virtual environment.</li></ol> <pre data-bbox="634 646 1027 762">% .venv\Scripts\activate.bat</pre>	
Install the dependencies.	<p data-bbox="591 831 1003 1100">After the virtual environment is activated, enter the following command to run the <b>install_deps.sh</b> script. This script installs the required dependencies.</p> <pre data-bbox="591 1142 1027 1257">\$ ./scripts/install_deps.sh</pre>	DevOps engineer, General AWS, Python
Deploy the stack.	<p data-bbox="591 1302 1013 1472">Enter the following commands to synthesize and deploy the CloudFormation stack.</p> <pre data-bbox="591 1514 1027 1629">\$ npx cdk synth \$ npx cdk deploy</pre>	DevOps engineer, General AWS, Python

## Related resources

### AWS documentation

- [About controls](#) (AWS Control Tower documentation)
- [Controls library](#) (AWS Control Tower documentation)
- [AWS CDK Toolkit commands](#) (AWS CDK documentation)
- [Deploy and manage AWS Control Tower controls by using Terraform](#) (AWS Prescriptive Guidance)

## Other resources

- [Python](#)

## Additional information

### Example constants.py file

The following is an example of an updated `constants.py` file.

```
ACCOUNT_ID = 111122223333
AWS_CONTROL_TOWER_REGION = us-east-2
ROLE_ARN = "arn:aws:iam::111122223333:role/CT-Controls-Role"
GUARDRAILS_CONFIGURATION = [
    {
        "Enable-Control": {
            "AWS-GR_ENCRYPTED_VOLUMES",
            ...
        },
        "OrganizationalUnitIds": ["ou-1111-11111111", "ou-2222-22222222"...],
    },
    {
        "Enable-Control": {
            "AWS-GR_SUBNET_AUTO_ASSIGN_PUBLIC_IP_DISABLED",
            ...
        },
        "OrganizationalUnitIds": ["ou-2222-22222222"...],
    },
]
```

### IAM policy

The following sample policy allows the minimum actions required to enable or disable AWS Control Tower controls when deploying AWS CDK stacks from a deployment account to the management account.

```

{
  "Version": "2012-10-17",
  "Statement": [
    {
      "Effect": "Allow",
      "Action": [
        "controltower:EnableControl",
        "controltower:DisableControl",
        "controltower:GetControlOperation",
        "controltower:ListEnabledControls",
        "organizations:AttachPolicy",
        "organizations:CreatePolicy",
        "organizations>DeletePolicy",
        "organizations:DescribeOrganization",
        "organizations:DescribeOrganizationalUnit",
        "organizations:DetachPolicy",
        "organizations:ListAccounts",
        "organizations:ListAWSServiceAccessForOrganization",
        "organizations:ListChildren",
        "organizations:ListOrganizationalUnitsForParent",
        "organizations:ListParents",
        "organizations:ListPoliciesForTarget",
        "organizations:ListRoots",
        "organizations:UpdatePolicy",
        "ssm:GetParameters"
      ],
      "Resource": "*"
    }
  ]
}

```

## Trust policy

The following custom trust policy allows a specific IAM role in the deployment account to assume the IAM role in the management account. Replace the following:

- <DEPLOYMENT-ACCOUNT-ID> is the ID of the deployment account
- <DEPLOYMENT-ROLE-NAME> is the name of the role in the deployment account that is allowed to assume the role in the management account

```

{

```

```
    "Version": "2012-10-17",
    "Statement": [
      {
        "Effect": "Allow",
        "Principal": {
          "AWS": "arn:aws:iam::<DEPLOYMENT-ACCOUNT-ID>:role/<DEPLOYMENT-ROLE-
NAME>"
        },
        "Action": "sts:AssumeRole",
        "Condition": {}
      }
    ]
  }
```

# Deploy and manage AWS Control Tower controls by using Terraform

Created by Iker Reina Fuente (AWS) and Ivan Girardi (AWS)

<b>Code repository:</b> <a href="#">Deploy and manage AWS Control Tower controls by using Terraform</a>	<b>Environment:</b> Production	<b>Technologies:</b> Security, identity, compliance; CloudNative; Infrastructure; Management & governance
<b>Workload:</b> Open-source	<b>AWS services:</b> AWS Control Tower; AWS Organizations	

## Summary

This pattern describes how to use AWS Control Tower controls, HashiCorp Terraform, and infrastructure as code (IaC) to implement and administer preventive, detective, and proactive security controls. A [control](#) (also known as a *guardrail*) is a high-level rule that provides ongoing governance for your overall AWS Control Tower environment. For example, you can use controls to require logging for your AWS accounts and then configure automatic notifications if specific security-related events occur.

AWS Control Tower helps you implement preventive, detective, and proactive controls that govern your AWS resources and monitor compliance across multiple AWS accounts. Each control enforces a single rule. In this pattern, you use a provided IaC template to specify which controls you want to deploy in your environment.

AWS Control Tower controls apply to an entire [organizational unit \(OU\)](#), and the control affects every AWS account within the OU. Therefore, when users perform any action in any account in your landing zone, the action is subject to the controls that govern the OU.

Implementing AWS Control Tower controls helps establish a strong security foundation for your AWS landing zone. By using this pattern to deploy the controls as IaC through Terraform, you can standardize the controls in your landing zone and more efficiently deploy and manage them.

To deploy AWS Control Tower controls as IaC, you can also use AWS Cloud Development Kit (AWS CDK) instead of Terraform. For more information, see [Deploy and manage AWS Control Tower controls by using AWS CDK and AWS CloudFormation](#).

## Target audience

This pattern is recommended for users who have experience with AWS Control Tower, Terraform, and AWS Organizations.

## Prerequisites and limitations

### Prerequisites

- Active AWS accounts managed as an organization in AWS Organizations and an AWS Control Tower landing zone. For instructions, see [Create an account structure](#) (AWS Well-Architected Labs).
- AWS Command Line Interface (AWS CLI), [installed](#) and [configured](#).
- An AWS Identity and Access Management (IAM) role in the management account that has permissions to deploy this pattern. For more information about the required permissions and a sample policy, see *Least privilege permissions for the IAM role* in the [Additional information](#) section of this pattern.
- Permissions to assume the IAM role in the management account.
- Apply the service control policy (SCP)-based control with the identifier **CT.CLOUDFORMATION.PR.1**. This SCP must be activated to deploy proactive controls. For instructions, see [Disallow management of resource types, modules, and hooks within the AWS CloudFormation registry](#).
- Terraform CLI, [installed](#) (Terraform documentation).
- Terraform AWS Provider, [configured](#) (Terraform documentation).
- Terraform backend, [configured](#) (Terraform documentation).

### Product versions

- AWS Control Tower version 3.0 or later
- Terraform version 1.5 or later
- Terraform AWS Provider version 4.67 or later



# Architecture

## Target architecture

This section provides a high-level overview of this solution and the architecture established by the sample code. The following diagram shows controls deployed across the various accounts in the OU.

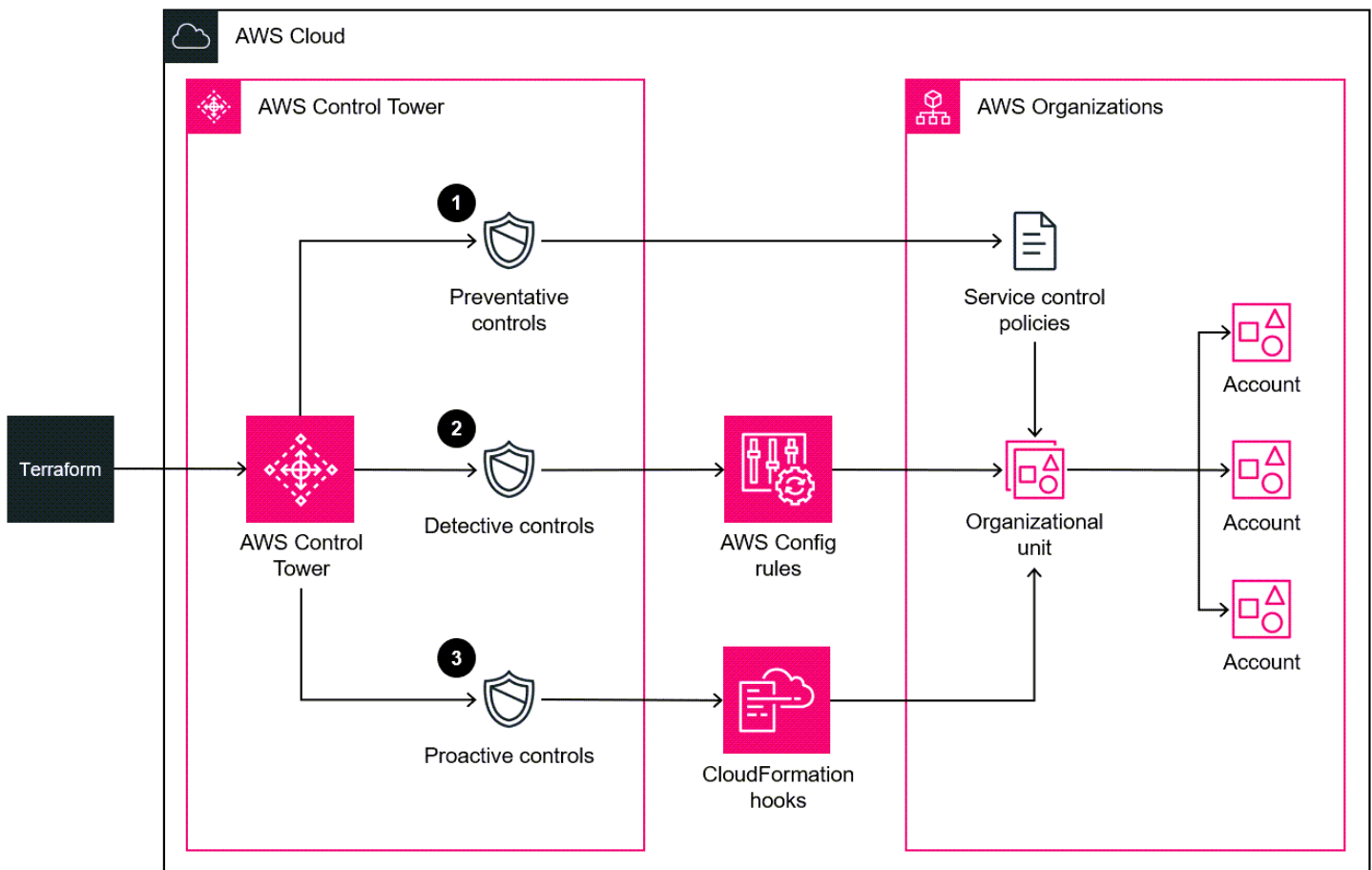

AWS Control Tower controls are categorized according to their *behavior* and their *guidance*.

There are three primary types of control behaviors:

1. *Preventive controls* are designed to prevent actions from occurring. These are implemented with [service control policies \(SCPs\)](#) in AWS Organizations. The status of a preventive control is either **enforced** or **not enabled**. Preventive controls are supported in all AWS Regions.
2. *Detective controls* are designed to detect specific events when they occur and log the action in CloudTrail. These are implemented with [AWS Config rules](#). The status of a detective control is

either **clear, in violation**, or **not enabled**. Detective controls apply only in those AWS Regions supported by AWS Control Tower.

3. *Proactive controls* scan resources that would be provisioned by AWS CloudFormation and check whether they are compliant with your company policies and objectives. Resources that are not compliant will not be provisioned. These are implemented with [AWS CloudFormation hooks](#). The status of a proactive control is **PASS**, **FAIL**, or **SKIP**.

Control *guidance* is the recommended practice for how to apply each control to your OUs. AWS Control Tower provides three categories of guidance: *mandatory*, *strongly recommended*, and *elective*. The guidance of a control is independent of its behavior. For more information, see [Control behavior and guidance](#).

## Tools

### AWS services

- [AWS CloudFormation](#) helps you set up AWS resources, provision them quickly and consistently, and manage them throughout their lifecycle across AWS accounts and Regions.
- [AWS Config](#) provides a detailed view of the resources in your AWS account and how they're configured. It helps you identify how resources are related to one another and how their configurations have changed over time.
- [AWS Control Tower](#) helps you set up and govern an AWS multi-account environment, following prescriptive best practices.
- [AWS Organizations](#) is an account management service that helps you consolidate multiple AWS accounts into an organization that you create and centrally manage.

### Other tools

- [HashiCorp Terraform](#) is an open-source infrastructure as code (IaC) tool that helps you use code to provision and manage cloud infrastructure and resources.

### Code repository

The code for this pattern is available in the GitHub [Deploy and manage AWS Control Tower controls by using Terraform](#) repository.

## Best practices

- The IAM role used to deploy this solution should adhere to the [principle of least-privilege](#) (IAM documentation).
- Follow the [Best practices for AWS Control Tower administrators](#) (AWS Control Tower documentation).

## Epics

### Enable controls in the management account

Task	Description	Skills required
Clone the repository.	<p>In a bash shell, enter the following command. This clones the <a href="#">Deploy and manage AWS Control Tower controls by using Terraform</a> repository from GitHub.</p> <pre>git clone https://github.com/aws-samples/aws-control-tower-controls-terraform.git</pre>	DevOps engineer
Edit the Terraform backend configuration file.	<ol style="list-style-type: none"><li>1. In the cloned repository, open the <b>backend.tf</b> file.</li><li>2. Edit the file to set the Terraform backend configuration. The configuration you define in this file depends on your environment. For more information, see <a href="#">Backend configuration</a> (Terraform documentation).</li></ol>	DevOps engineer, Terraform

Task	Description	Skills required
	3. Save and close the <b>backend.tf</b> file.	
Edit the Terraform provider configuration file.	<ol style="list-style-type: none"><li>1. In the cloned repository, open the <b>provider.tf</b> file.</li><li>2. Edit the file to set the Terraform provider configuration. For more information, see <a href="#">Provider configuration</a> (Terraform documentation). Set the AWS Region as the Region where the AWS Control Tower API is available.</li><li>3. Save and close the <b>provider.tf</b> file.</li></ol>	DevOps engineer, Terraform

Task	Description	Skills required
Edit the configuration file.	<ol style="list-style-type: none"> <li>1. In the cloned repository, open the <b>variables.tfvars</b> file.</li> <li>2. In the <code>controls</code> section, in the <code>control_names</code> parameter, enter the control API identifier. Each control has a unique API identifier for each Region in which AWS Control Tower is available. To find the control identifier, do the following:               <ol style="list-style-type: none"> <li>a. In <a href="#">Tables of control metadata</a>, locate the control you want to enable.</li> <li>b. In the <b>Control API identifiers, by Region</b> column, locate the API identifier for the Region in which you are making the API call, such as <code>arn:aws:controltower:us-east-1::control/AWS-GR_AUDIT_BUCKET_ENCRYPTION_ENABLED</code>.</li> <li>c. Extract the control identifier from the Regional identifier, such as <code>AWS-GR_AUDIT_BUCKE</code></li> </ol> </li> </ol>	DevOps engineer, General AWS, Terraform

Task	Description	Skills required
	<p>T_ENCRYPT ION_ENABLED .</p> <p>3. In the controls section, in the organizational_unit_ids parameter, enter the ID of the organizational unit where you want to enable the control, such as ou-1111-11111111 . Enter the ID in double quotation marks, and separate multiple IDs with commas. For more information about how to retrieve OU IDs, see <a href="#">Viewing the details of an OU</a>.</p> <p>4. Save and close the <b>variables.tfvars</b> file. For an example of an updated <b>variables.tfvars</b> file, see the <a href="#">Additional information</a> section of this pattern.</p>	

Task	Description	Skills required
Assume the IAM role in the management account.	In the management account, assume the IAM role that has permissions to deploy the Terraform configuration file. For more information about the permissions required and a sample policy, see <i>Least privilege permissions for the IAM role</i> in the <a href="#">Additional information</a> section. For more information about assuming an IAM role in the AWS CLI, see <a href="#">Use an IAM role in the AWS CLI</a> .	DevOps engineer, General AWS

Task	Description	Skills required
Deploy the configuration file.	<ol style="list-style-type: none"><li data-bbox="591 226 1027 512">1. Enter the following command to initialize Terraform. <pre data-bbox="634 394 1027 512">\$ terraform init - upgrade</pre></li><li data-bbox="591 527 1027 898">2. Enter the following command to preview the changes compared the current state. <pre data-bbox="634 743 1027 898">\$ terraform plan - var-file="variables.tfvars"</pre></li><li data-bbox="591 913 1027 1199">3. Review the configuration changes in the Terraform plan and confirm that you want to implement these changes in the organization.</li><li data-bbox="591 1213 1027 1541">4. Enter the following command to deploy the resources. <pre data-bbox="634 1381 1027 1541">\$ terraform apply - var-file="variables.tfvars"</pre></li></ol>	DevOps engineer, General AWS, Terraform



## (Optional) Disable controls in the AWS Control Tower management account

Task	Description	Skills required
Run the destroy command.	<p>Enter the following command to remove the resources deployed by this pattern.</p> <pre>\$ terraform destroy -var-file="variables.tfvars"</pre>	DevOps engineer, General AWS, Terraform

## Troubleshooting

Issue	Solution
<p>Error: creating ControlTowerControl ValidationException: Guardrail &lt;control ID&gt; is already enabled on organizational unit &lt;OU ID&gt; error</p>	<p>The control you are trying to enable is already enabled in the target OU. This error can occur if a user manually enabled the control through the AWS Management Console, through AWS Control Tower or through AWS Organizations. To deploy the Terraform configuration file, you can use either of the following options.</p> <p><b>Option 1: Update the Terraform current state file</b></p> <p>You can import the resource to the Terraform current state file. When you rerun the apply command, Terraform will skip this resource. Do the following to import the resource to the current Terraform state:</p> <ol style="list-style-type: none"> <li>1. In the AWS Control Tower management account, enter the following command to retrieve a list of the Amazon Resource Names (ARNs) for the OUs, where &lt;root-</li> </ol>

Issue	Solution
	<p>ID&gt; is the organization root. For more information about retrieving this ID, see <a href="#">Viewing the details of the root</a>.</p> <pre>aws organizations list-organizational-units-for-parent --parent-id &lt;root-ID&gt;</pre> <ol style="list-style-type: none"><li>2. For each OU returned in the previous step, enter the following command, where &lt;OU-ARN&gt; is the ARN of the OU.</li></ol> <pre>aws controltower list-enabled-controls --target-identifier &lt;OU-ARN&gt;</pre> <ol style="list-style-type: none"><li>3. Copy the ARNs and perform the Terraform import in the required module so that it is included in the Terraform state. For instructions, see <a href="#">Import</a> (Terraform documentation).</li><li>4. Repeat the steps in <i>Deploy the configuration</i> in the <a href="#">Epics</a> section.</li></ol> <p><b>Option 2: Disable the control</b></p> <p>If you are working in a non-production environment, you can disable the control in the console. Reenable it by repeating the steps in <i>Deploy the configuration</i> in the <a href="#">Epics</a> section. This approach is not recommended for production environments because there is a period of time when the control will be disabled. If you want to use this option in a production environment, you can implement temporary controls, such as temporarily applying a SCP in AWS Organizations.</p>

## Related resources

### AWS documentation

- [About controls](#) (AWS Control Tower documentation)
- [Controls library](#) (AWS Control Tower documentation)
- [Deploy and manage AWS Control Tower controls by using AWS CDK and AWS CloudFormation](#) (AWS Prescriptive Guidance)

### Other resources

- [Terraform](#)
- [Terraform CLI documentation](#)

## Additional information

### Example variables.tfvars file

The following is an example of an updated `variables.tfvars` file.

```
controls = [  
  {  
    control_names = [  
      "AWS-GR_ENCRYPTED_VOLUMES",  
      ...  
    ],  
    organizational_unit_ids = ["ou-1111-11111111", "ou-2222-22222222"...],  
  },  
  {  
    control_names = [  
      "AWS-GR_SUBNET_AUTO_ASSIGN_PUBLIC_IP_DISABLED",  
      ...  
    ],  
    organizational_unit_ids = ["ou-1111-11111111"...],  
  },  
]
```

### Least privilege permissions for the IAM role

This APG pattern requires that you assume an IAM role in the management account. Best practice is to assume a role with temporary permissions and limit the permissions according to the principle of least privilege. The following sample policy allows the minimum actions required to enable or disable AWS Control Tower controls.

```
{
  "Version": "2012-10-17",
  "Statement": [
    {
      "Effect": "Allow",
      "Action": [
        "controltower:EnableControl",
        "controltower:DisableControl",
        "controltower:GetControlOperation",
        "controltower:ListEnabledControls",
        "organizations:AttachPolicy",
        "organizations:CreatePolicy",
        "organizations>DeletePolicy",
        "organizations:DescribeOrganization",
        "organizations:DetachPolicy",
        "organizations:ListAccounts",
        "organizations:ListAWSServiceAccessForOrganization",
        "organizations:ListChildren",
        "organizations:ListOrganizationalUnitsForParent",
        "organizations:ListParents",
        "organizations:ListPoliciesForTarget",
        "organizations:ListRoots",
        "organizations:UpdatePolicy"
      ],
      "Resource": "*"
    }
  ]
}
```

# Deploy a pipeline that simultaneously detects security issues in multiple code deliverables

Created by Benjamin Morris (AWS), Dina Odum (AWS), Isaiah Schisler (AWS), Sapeksh Madan (AWS), and Tim Hahn (AWS)

**Code repository:** [Simple Code Scanning Pipeline](#)

**Environment:** PoC or pilot

**Technologies:** Security, identity, compliance; DevOps

**AWS services:** AWS CloudFormation; AWS CodeBuild; AWS CodeCommit; AWS CodePipeline

## Summary

The [Simple Code Scanning Pipeline \(SCSP\)](#) provides two-click creation of a code analysis pipeline that runs industry-standard open-source security tools in parallel. This enables developers to check the quality and security of their code without having to install tools or even understand how to run them. This helps you reduce vulnerabilities and misconfigurations in code deliverables. It also reduces the amount of time your organization spends installing, researching, and configuring security tools.

Before SCSP, scanning code using this particular suite of tools required developers to locate, manually install, and configure the software analysis tools. Even locally installed, all-in-one tools, such as Automated Security Helper (ASH), require configuring a Docker container in order to run. However, with SCSP, a suite of industry-standard code analysis tools runs automatically in the AWS Cloud. With this solution, you use Git to push your code deliverables, and then you receive a visual output with at-a-glance insights into which security checks failed.

## Prerequisites and limitations

- An active AWS account
- One or more code deliverables that you want to scan for security issues
- AWS Command Line Interface (AWS CLI), [installed](#) and [configured](#)

- Python version 3.0 or later and pip version 9.0.3 or later, [installed](#)
- Git, [installed](#)
- Install [git-remote-codecommit](#) on your local workstation

## Architecture

### Target technology stack

- AWS CodeCommit repository
- AWS CodeBuild project
- AWS CodePipeline pipeline
- Amazon Simple Storage Service (Amazon S3) bucket
- AWS CloudFormation template

### Target architecture

The SCSP for static code analysis is a DevOps project designed to give security feedback on deliverable code.

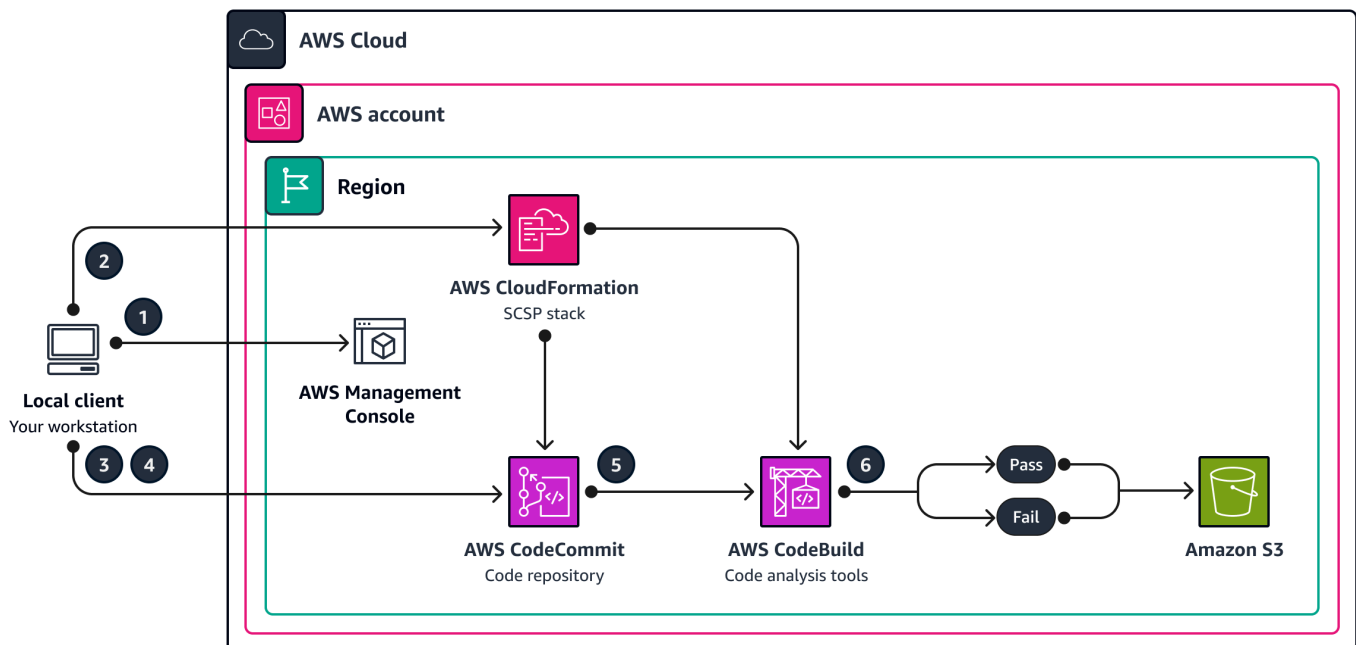

1. In the AWS Management Console, log into the target AWS account. Confirm that you are in the AWS Region where you want to deploy the pipeline.

2. Use the CloudFormation template in the code repository to deploy the SCSP stack. This creates a new CodeCommit repository and CodeBuild project.

**Note:** As an alternative deployment option, you can use an existing CodeCommit by providing the Amazon Resource Name (ARN) of the repository as a parameter during stack deployment.

3. Clone the repository to your local workstation, and then add any files to their respective folders in the cloned repository.
4. Use Git to add, commit, and push the files to the CodeCommit repository.
5. Pushing to the CodeCommit repository initiates a CodeBuild job. The CodeBuild project uses the security tools to scan the code deliverables.
6. Review the output of the pipeline. Security tools that found error-level issues will result in failed actions in the pipeline. Fix these errors or suppress them as false positives. Review details of the tool output in the **Action details** in CodePipeline or in the pipeline's S3 bucket.

## Tools

### AWS services

- [AWS CloudFormation](#) helps you set up AWS resources, provision them quickly and consistently, and manage them throughout their lifecycle across AWS accounts and Regions.
- [AWS CodeBuild](#) is a fully managed build service that helps you compile source code, run unit tests, and produce artifacts that are ready to deploy.
- [AWS CodeCommit](#) is a version control service that helps you privately store and manage Git repositories, without needing to manage your own source control system.

### Other tools

For a complete list of tools that SCSP uses to scan code deliverables, see the [SCSP readme](#) in GitHub.

### Code repository

The code for this pattern is available in the [Simple Code Scanning Pipeline \(SCSP\)](#) repository in GitHub.

# Epics

## Deploy the SCSP

Task	Description	Skills required
Create the CloudFormation stack.	<ol style="list-style-type: none"><li>1. Sign in to the <a href="#">AWS Management Console</a>.</li><li>2. In the console, confirm that you're in the target Region where you want to deploy the solution. For more information, see <a href="#">Choosing a Region</a>.</li><li>3. Choose the following link. This opens the Quick create stack wizard in CloudFormation.  <a href="https://console.aws.amazon.com/cloudformation/home?#/stacks/create/review?templateURL=https://proservetools.s3.amazonaws.com/cft/scsp-pipeline-stack.template.json&amp;stackName=SimpleCodeScanPipeline">https://console.aws.amazon.com/cloudformation/home?#/stacks/create/review?templateURL=https://proservetools.s3.amazonaws.com/cft/scsp-pipeline-stack.template.json&amp;stackName=SimpleCodeScanPipeline</a></li><li>4. On the <b>Quick create stack</b> wizard, review the parameter settings for your stack and make any modifications as needed for your use case.</li></ol>	AWS DevOps, AWS administrator



Task	Description	Skills required
	<p>5. Select <b>I acknowledge that AWS CloudFormation might create IAM resources</b>, and then choose <b>Create stack</b>.</p> <p>This creates a CodeCommit repository, a CodePipeline pipeline, several CodeBuild job definitions, and an S3 bucket. Build runs and scanning results are copied into this bucket. After the CloudFormation stack has been completely deployed, SCSP is ready to use.</p>	

## Use the pipeline

Task	Description	Skills required
<p>Examine the results of the scan.</p>	<ol style="list-style-type: none"> <li>1. In the <a href="#">Amazon S3 console</a>, in <b>Buckets</b>, choose the <b>simplecodescanpipeline-deleteresourcespipeline</b> bucket.</li> <li>2. Choose the <b>scan_results</b> directory, and then choose the folder with the most recent scan date stamp.</li> <li>3. Review the log files in this folder to review any issues detected by the security tools used in the pipeline.</li> </ol>	<p>App developer, AWS DevOps</p>

Task	Description	Skills required
	<p>Security tools that found error-level issues will result in failed actions in the pipeline. These need to be fixed or suppressed if they are false positives.</p> <p><b>Note:</b> You can also view details of the tool output (for both passing and failing scans) in the CodePipeline console, in the <b>Action details</b> section.</p>	

## Troubleshooting

Issue	Solution
HashiCorp Terraform or AWS CloudFormation files aren't being scanned.	Make sure that Terraform (.tf) and CloudFormation (.yaml, .yml, or .json) files are placed in the appropriate folders in the cloned CodeCommit repository.
The <code>git clone</code> command is failing.	Make sure that you have installed <code>git-remote-codecommit</code> and that your CLI has access to AWS credentials that have permissions to read the CodeCommit repository.
A concurrency error, such as <code>Project-level concurrent build limit cannot exceed the account-level concurrent build limit of 1</code> .	Rerun the pipeline by choosing the <b>Release Change</b> button in the <a href="#">CodePipeline console</a> . This is a known issue that seems to be most common during the first few times that the pipeline runs.

## Related resources

[Provide feedback](#) on the SCSP project.

## Additional information

### FAQ

*Is the SCSP project the same as Automated Security Helper (ASH)?*

No. Use ASH when you want a CLI tool that runs code-scanning tools by using containers.

[Automated Security Helper \(ASH\)](#) is a tool that is designed to reduce the probability of a security violation in new code, infrastructure, or IAM resource configuration. ASH is a command-line utility that can be run locally. Local use requires a container environment be installed and operational on the system.

Use SCSP when you want an easier setup pipeline than ASH. SCSP requires no local installations. SCSP is designed to run checks individually in a pipeline and display results by tool. SCSP also avoids a lot of the overhead with setting up Docker, and it is operating system (OS) agnostic.

*Is SCSP just for security teams?*

No, anyone can deploy the pipeline to determine which parts of their code are failing security checks. For example, non-security users can use SCSP to check their code before reviewing with their security teams.

*Can I use SCSP if I'm working with another type of repository, such as GitLab, GitHub, or Bitbucket?*

You can configure a local git repository to point to two different remote repositories. For example, you could clone an existing GitLab repository, create a SCSP instance (specifying CloudFormation, Terraform, and AWS Config Rules Development Kit (AWS RDK) folders, if needed), and then use `git remote add upstream <SCSPGitLink>` to point the local repository at the SCSP CodeCommit repository as well. This allows for code changes to be sent to SCSP first, validated, then, after any additional updates are made to address findings, pushed to the GitLab, GitHub, or Bitbucket repository. For more information about multiple remotes, see [Push commits to an additional Git repository](#) (AWS blog post).

**Note:** Be careful of drift, such as avoid making changes through web interfaces.

## Contributing and adding your own actions

SCSP setup is maintained as a GitHub project, which contains the source code for the SCSP AWS Cloud Development Kit (AWS CDK) application. To add additional checks to the pipeline, the AWS CDK application needs to be updated and then synthesized or deployed into the target AWS account where the pipeline will run. To do this, start by cloning the SCSP [GitHub project](#), and then find the stack definition file in the `lib` folder.

If there's an additional check you would like to add, the `StandardizedCodeBuildProject` class in the AWS CDK code makes it very straightforward to add actions. Provide the name, description, and `install` or `build` commands. AWS CDK creates the CodeBuild project by using sensible default values. In addition to creating the build project, you need to add it to the CodePipeline actions in the build stage. When designing a new check, the action should FAIL if the scanning tool detects problems or fails to run. The action should PASS if the scanning tool doesn't detect any problems. For an example of configuring a tool, review the code for the `Bandit` action.

For more information about expected input and outputs, see the [repository documentation](#).

If you add custom actions, you need to deploy SCSP by using `cdk deploy` or `cdk synth + CloudFormation deploy`. This is because the **Quick create stack** CloudFormation template is maintained by the repo owners.

# Deploy detective attribute-based access controls for public subnets by using AWS Config

Created by Alberto Menendez (AWS)

**Environment:** PoC or pilot

**Technologies:** Security, identity, compliance; Networking

**AWS services:** AWS Config; Amazon SNS

## Summary

Distributed edge network architectures rely on network edge security that runs alongside the workloads in their virtual private clouds (VPCs). This provides unprecedented scalability in comparison to the more common, centralized approach. Although deploying public subnets in workload accounts can provide benefits, it also introduces new security risks because it increases the attack surface. We recommend that you deploy only Elastic Load Balancing (ELB) resources, such as Application Load Balancers, or NAT gateways in the public subnets of these VPCs. Using load balancers and NAT gateways in dedicated public subnets helps you implement fine-grained control for inbound and outbound traffic.

We recommend that you implement both preventative and detective controls to limit the types of resources that can be deployed in public subnets. For more information about using attribute-based access control (ABAC) to deploy preventative controls for public subnets, see [Deploy preventative attribute-based access controls for public subnets](#). Although effective for most situations, these preventative controls might not address all possible use cases. Therefore, this pattern builds on the ABAC approach and helps you configure alerts about noncompliant resources that are deployed in public subnets. The solution checks whether elastic network interfaces belong to a resource that is not allowed in public subnets.

To achieve this, this pattern uses [AWS Config custom rules](#) and [ABAC](#). The custom rule processes the configuration of an elastic network interface whenever it is created or modified. At a high level, this rule performs two actions to determine whether the network interface is compliant:

1. To determine whether the network interface is in scope of the rule, the rule checks whether the subnet has specific [AWS tags](#) that indicate it is a public subnet. For example, this tag might be `IsPublicFacing=True`.

2. If the network interface is deployed in a public subnet, the rule checks which AWS service created this resource. If the resource is not an ELB resource or NAT gateway, it marks the resource as noncompliant.

## Prerequisites and limitations

### Prerequisites

- An active AWS account
- AWS Config, [set up](#) in the workload account
- Permissions to deploy the required resources in the workload account
- A VPC with public subnets
- Tags properly applied to identify the target public subnets
- (Optional) An organization in AWS Organizations
- (Optional) A central security account that is the delegated administrator for AWS Config and AWS Security Hub

## Architecture

### Target architecture

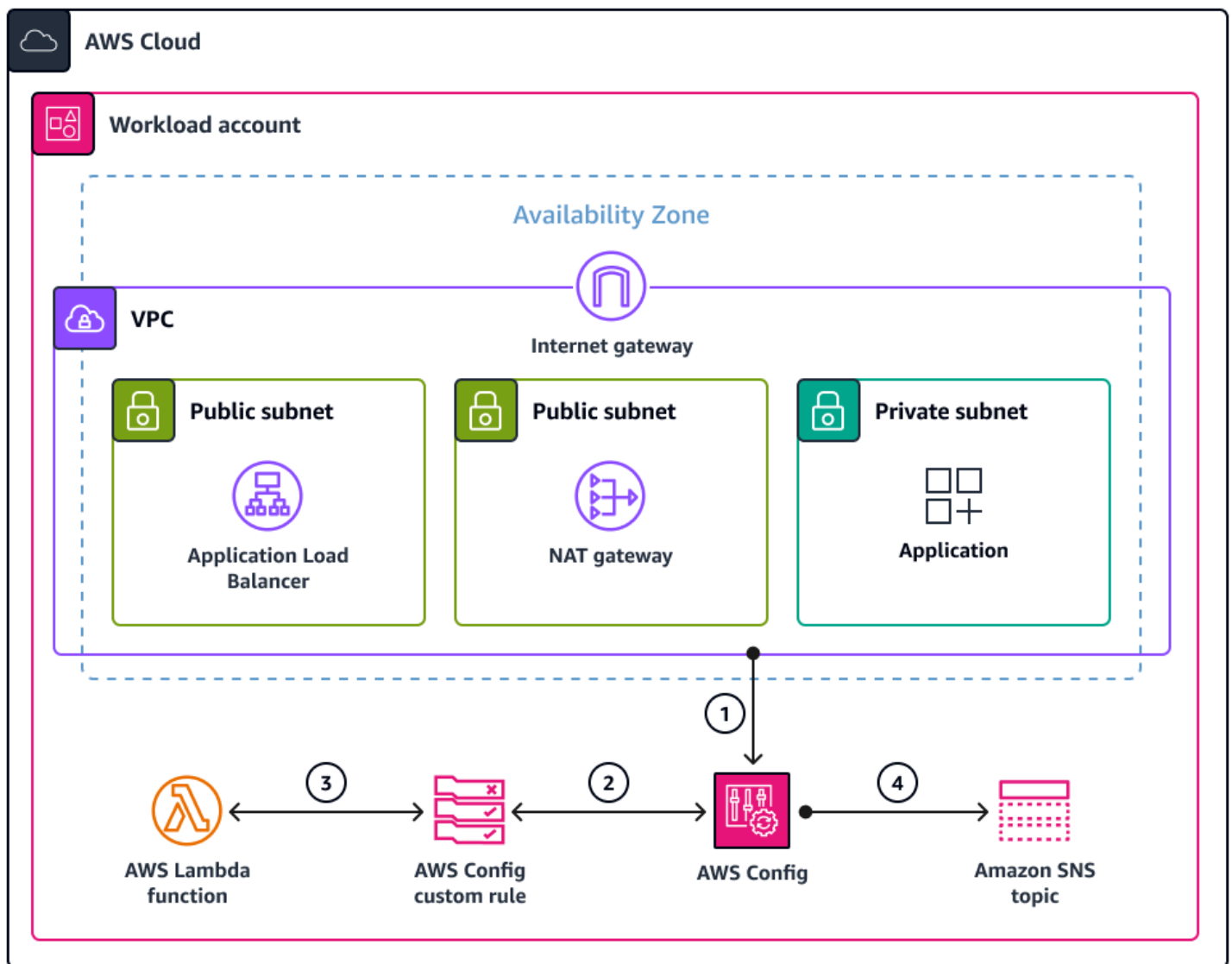

The diagram illustrates the following:

1. When an elastic network interface resource (`AWS::EC2::NetworkInterface`) is deployed or modified, AWS Config captures the event and the configuration.
2. AWS Config matches this event against the custom rule used to evaluate the configuration.
3. The AWS Lambda function associated with this custom rule is invoked. The function evaluates the resource and applies the specified logic to determine if the resource configuration is `COMPLIANT`, `NON_COMPLIANT` or `NOT_APPLICABLE`.
4. If a resource is determined to be `NON_COMPLIANT`, AWS Config sends an alert through Amazon Simple Notification Service (Amazon SNS).

**Note:** If this account is a member account in AWS Organizations, you can send compliance data to a central security account through AWS Config or AWS Security Hub.

### Lambda function evaluation logic

The following diagram shows the logic applied by the Lambda function to evaluate the compliance of the elastic network interface.



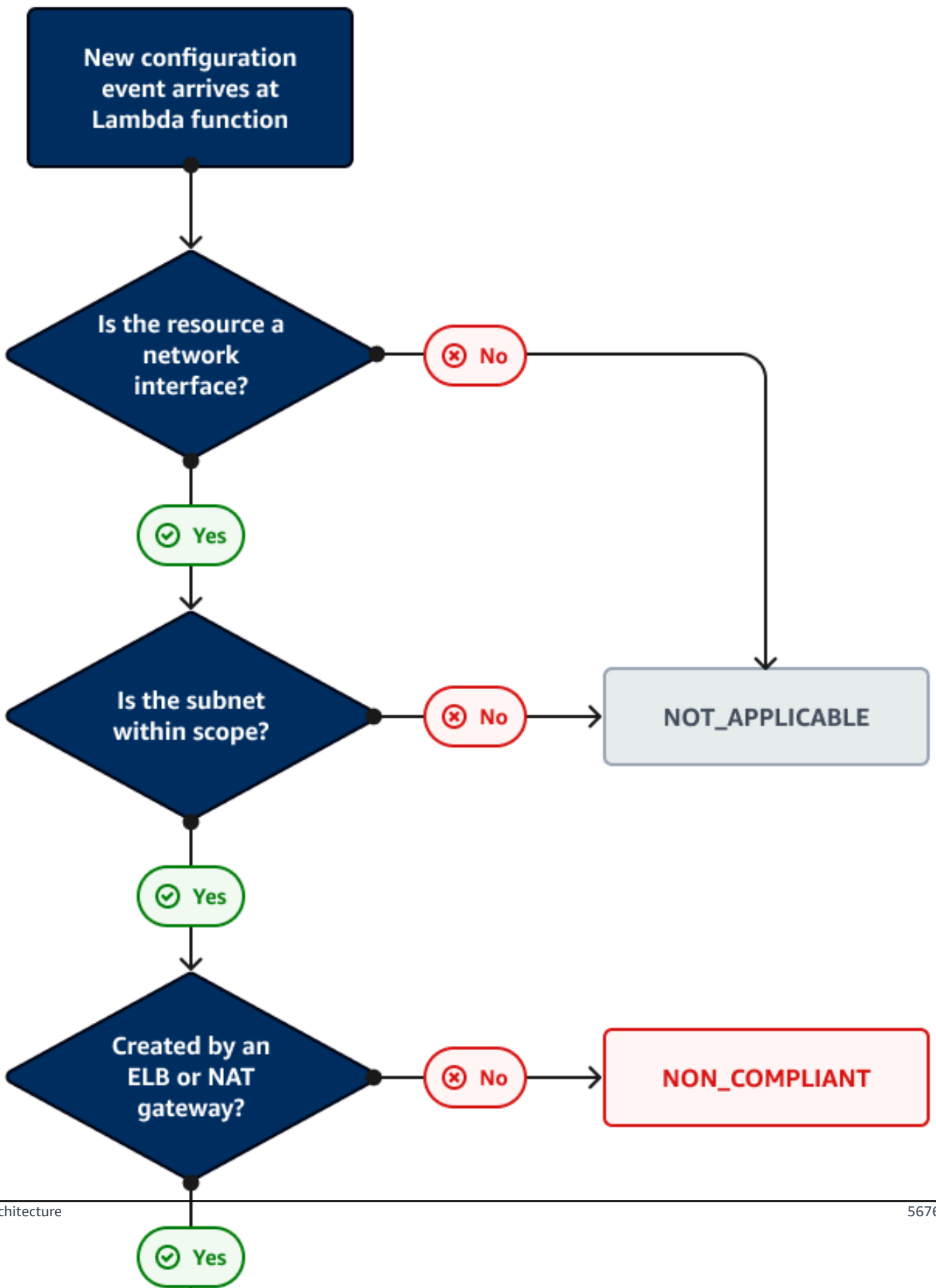

## Automation and scale

This pattern is a detective solution. You can also complement it with a remediation rule to automatically resolve any noncompliant resources. For more information, see [Remediating Noncompliant Resources with AWS Config Rules](#).

You can scale this solution by:

- Enforcing application of the corresponding AWS tags that you establish to identify public-facing subnets. For more information, see [Tag policies](#) in the AWS Organizations documentation.
- Configuring a central security account that applies the AWS Config custom rule to every workload account in the organization. For more information, see [Automate configuration compliance at scale in AWS](#) (AWS blog post).
- Integrating AWS Config with AWS Security Hub in order to capture, centralize, and notify at scale. For more information, see [Configuring AWS Config](#) in the AWS Security Hub documentation.

## Tools

- [AWS Config](#) provides a detailed view of the resources in your AWS account and how they're configured. It helps you identify how resources are related to one another and how their configurations have changed over time.
- [Elastic Load Balancing \(ELB\)](#) distributes incoming application or network traffic across multiple targets. For example, you can distribute traffic across Amazon Elastic Compute Cloud (Amazon EC2) instances, containers, and IP addresses in one or more Availability Zones.
- [AWS Lambda](#) is a compute service that helps you run code without needing to provision or manage servers. It runs your code only when needed and scales automatically, so you pay only for the compute time that you use.
- [Amazon Simple Notification Service \(Amazon SNS\)](#) helps you coordinate and manage the exchange of messages between publishers and clients, including web servers and email addresses.
- [Amazon Virtual Private Cloud \(Amazon VPC\)](#) helps you launch AWS resources into a virtual network that you've defined. This virtual network resembles a traditional network that you'd operate in your own data center, with the benefits of using the scalable infrastructure of AWS.

## Best practices

For more examples and best practices for developing custom AWS Config rules, see the official [AWS Config Rules Repository](#) on GitHub.

## Epics

### Deploy the solution

Task	Description	Skills required
Create the Lambda function.	<ol style="list-style-type: none"><li>1. Sign in to the AWS Management Console, and then open the AWS Lambda console.</li><li>2. On the <b>Functions</b> page, choose <b>Create function</b>.</li><li>3. Select <b>Author from scratch</b>.</li><li>4. In the <b>Basic information</b> pane, for <b>Function name</b>, enter a name.</li><li>5. For <b>Runtime</b>, choose <b>Python 3.12</b>.</li><li>6. Leave <b>architecture</b> set to <b>x86_64</b>.</li><li>7. Choose <b>Create function</b>.</li><li>8. Choose the <b>Code</b> tab.</li><li>9. In the file explorer, choose <b>lambda_function.py</b>.</li><li>10 Paste the sample code provided in the <a href="#">Additional information</a> section of this pattern into the <b>lambda_function.py</b> tab. Customize the sample code</li></ol>	General AWS

Task	Description	Skills required
	<p>to identify any custom evaluation logic in the <code>evaluate_change_notification_compliance</code> function.</p> <p>11Choose <b>Deploy</b>.</p>	

Task	Description	Skills required
Add permissions to the Lambda function's execution role.	<ol style="list-style-type: none"><li>1. In the navigation pane, choose <b>Functions</b>.</li><li>2. Choose the function you just created.</li><li>3. Choose <b>Configuration</b>, and then choose <b>Permissions</b>.</li><li>4. Choose the role name to open the role in the AWS Identity and Access Management (IAM) console.</li><li>5. Under <b>Permissions policies</b>, choose <b>Add permissions</b>, and then choose <b>Create inline policy</b>.</li><li>6. Choose <b>JSON</b>.</li><li>7. Paste the following policy into the policy editor. This allows the Lambda function to:<ul style="list-style-type: none"><li>• Get the details of the subnet tags.</li><li>• Send the compliance outcome back to AWS Config.</li></ul></li></ol> <pre data-bbox="631 1566 1029 1818">{      "Version":     "2012-10-17",     "Statement": [         {</pre>	General AWS

Task	Description	Skills required
	<pre data-bbox="630 205 1026 861">                 "Action":                 [                 "config:PutEvaluat                 ions",                 "ec2:DescribeSubne                 ts"                 ],                 "Resource                 ": "*",                 "Effect":                 "Allow"                 }                 ]             }             </pre> <p data-bbox="591 877 1010 1071">                     8. Choose <b>Next</b>.                      9. Enter a name for the policy, and then choose <b>Create policy</b>.                 </p>	
<p data-bbox="110 1108 555 1243">Retrieve the Lambda function Amazon Resource Name (ARN).</p>	<ol data-bbox="591 1108 1026 1507" style="list-style-type: none"> <li>1. Open the Lambda console.</li> <li>2. In the navigation pane, choose <b>Functions</b>.</li> <li>3. Choose the function you just created.</li> <li>4. In the <b>Function overview</b> section, under <b>Function ARN</b>, copy the value.</li> </ol>	<p data-bbox="1068 1108 1260 1142">General AWS</p>

Task	Description	Skills required
Create the AWS Config custom rule.	<ol style="list-style-type: none"><li>1. Open the AWS Config console at <a href="https://console.aws.amazon.com/config/">https://console.aws.amazon.com/config/</a>.</li><li>2. On the <b>Rules</b> page, choose <b>Add rule</b>.</li><li>3. On the <b>Specify rule type</b> page, choose <b>Create custom Lambda rule</b>, and then choose <b>Next</b>.</li><li>4. On the <b>Configure rule</b> page, do the following:<ol style="list-style-type: none"><li>a. Enter a name and description.</li><li>b. For <b>AWS Lambda function ARN</b>, paste the ARN that you previously copied.</li><li>c. For <b>Trigger type</b>, choose <b>When configuration changes</b>.</li><li>d. For <b>Scope of changes</b>, select <b>Resources</b>.</li><li>e. For <b>Resource type</b>, choose <b>AWS EC2 NetworkInterface</b>.</li><li>f. Choose <b>Next</b>.</li></ol></li><li>5. On the <b>Review and create</b> page, verify your rule, and then choose <b>Save</b>.</li></ol>	General AWS

Task	Description	Skills required
Configure notifications.	<ol style="list-style-type: none"> <li>1. Follow the instructions in <a href="#">Creating an Amazon SNS topic</a> in order to create an Amazon SNS topic.</li> <li>2. Follow the instructions in <a href="#">Subscribing to an Amazon SNS topic</a> to configure an endpoint that receives notifications for the Amazon SNS topic.</li> <li>3. Follow the instructions in <a href="#">How can I be notified when an AWS resource is non-compliant using AWS Config</a> to configure a custom Amazon EventBridge rule for your noncompliant resources.</li> </ol>	General AWS

## Test the solution

Task	Description	Skills required
Create a compliant resource.	<ol style="list-style-type: none"> <li>1. Use the following instructions to create one of the supported resources in a public subnet: <ul style="list-style-type: none"> <li>• <a href="#">Create a NAT gateway</a></li> <li>• <a href="#">Getting started with Network Load Balancers</a></li> <li>• <a href="#">Create an Application Load Balancer</a></li> </ul> </li> </ol>	General AWS



Task	Description	Skills required
	<p>2. After the resource is created, the AWS Config custom rule evaluates the elastic network interfaces associated with resource. It marks these network interfaces as <b>COMPLIANT</b> . You can view the resources in AWS Config by following these steps:</p> <ol style="list-style-type: none"><li>a. Open the AWS Config console at <a href="https://console.aws.amazon.com/config/">https://console.aws.amazon.com/config/</a>.</li><li>b. On the <b>Rules</b> page, choose your rule.</li><li>c. On the <b>Rule detail</b> page, go to the bottom of the page.</li><li>d. Under <b>Resources in scope</b>, select <b>Compliant</b> . Confirm that you see the IDs of the network interfaces that were created.</li><li>e. For more detail about the network interface configuration, choose the resource ID.</li></ol>	

Task	Description	Skills required
Create a noncompliant resource.	<ol style="list-style-type: none"><li>1. Use the following instructions to create a noncompliant resource in a public subnet:<ul style="list-style-type: none"><li>• <a href="#">Launch an Amazon EC2 instance</a></li><li>• <a href="#">Creating an Amazon Relational Database Service (Amazon RDS) database instance</a></li><li>• <a href="#">Create a VPC endpoint</a></li></ul></li><li>2. After the resource is created, the AWS Config custom rule evaluates the elastic network interfaces associated with resource. It marks these network interfaces as NON_COMPLIANT . You can view the resources in AWS Config by following these steps:<ol style="list-style-type: none"><li>a. Open the AWS Config console at <a href="https://console.aws.amazon.com/config/">https://console.aws.amazon.com/config/</a>.</li><li>b. On the <b>Rules</b> page, choose your rule.</li><li>c. On the <b>Rule detail</b> page, go to the bottom of the page.</li><li>d. Under <b>Resources in scope</b>, select <b>NonCompliant</b>. Confirm</li></ol></li></ol>	General AWS

Task	Description	Skills required
	<p>that you see the IDs of the network interfaces that were created.</p> <p>e. For more detail about the network interface configuration, choose the resource ID.</p> <p>3. Confirm that you receive the notification at the endpoint that you configured in Amazon SNS.</p>	
<p>Create a resource that is not applicable.</p>	<ol style="list-style-type: none"> <li>1. In a private subnet, create any resource that requires an elastic network interface.</li> <li>2. After the resource is created, the AWS Config custom rule evaluates the elastic network interfaces associated with resource. It marks these network interfaces as NOT_APPLICABLE . These resources are not shown in the AWS Config console.</li> </ol>	<p>General AWS</p>

## Related resources

### AWS documentation

- [Setting up AWS Config](#)
- [AWS Config custom rules](#)
- [ABAC for AWS](#)

- [Deploy preventative attribute-based access controls for public subnets](#)

## Other AWS resources

- [Automate configuration compliance at scale in AWS](#)
- [Distributed Inspection Architectures with Gateway Load Balancer](#)

## Additional information

The following is a sample Lambda function that is provided for demonstration purposes.

```
import boto3
import json
import os

# Init clients
config_client = boto3.client('config')
ec2_client = boto3.client('ec2')

def lambda_handler(event, context):

    # Init values
    compliance_value = 'NOT_APPLICABLE'
    invoking_event = json.loads(event['invokingEvent'])
    configuration_item = invoking_event['configurationItem']

    status = configuration_item['configurationItemStatus']
    eventLeftScope = event['eventLeftScope']

    # First check if the event configuration applies. Ex. resource event is not delete
    if (status == 'OK' or status == 'ResourceDiscovered') and not eventLeftScope:
        compliance_value = evaluate_change_notification_compliance(configuration_item)

    config_client.put_evaluations(
        Evaluations=[
            {
                'ComplianceResourceType': invoking_event['configurationItem']
['resourceType'],
                'ComplianceResourceId': invoking_event['configurationItem']
['resourceId'],
```

```
        'ComplianceType': compliance_value,
        'OrderingTimestamp': invoking_event['configurationItem']
['configurationItemCaptureTime']
    },
],
ResultToken=event['resultToken'])

# Function with the logs to evaluate the resource
def evaluate_change_notification_compliance(configuration_item):
    is_in_scope = is_in_scope_subnet(configuration_item['configuration']['subnetId'])

    if (configuration_item['resourceType'] != 'AWS::EC2::NetworkInterface') or not
is_in_scope:
        return 'NOT_APPLICABLE'

    else:
        alb_condition = configuration_item['configuration']['requesterId'] in ['amazon-
elb']
        nlb_condition = configuration_item['configuration']['interfaceType'] in
['network_load_balancer']
        nat_gateway_condition = configuration_item['configuration']['interfaceType'] in
['nat_gateway']

        if alb_condition or nlb_condition or nat_gateway_condition:
            return 'COMPLIANT'
        return 'NON_COMPLIANT'

# Function to check if elastic network interface is in public subnet
def is_in_scope_subnet(eni_subnet):

    subnet_description = ec2_client.describe_subnets(
        SubnetIds=[eni_subnet]
    )

    for subnet in subnet_description['Subnets']:
        for tag in subnet['Tags']:
            if tag['Key'] == os.environ.get('TAG_KEY') and tag['Value'] ==
os.environ.get('TAG_VALUE'):
                return True

    return False
```

# Deploy preventative attribute-based access controls for public subnets

Created by Joel Alfredo Nunez Gonzalez (AWS) and Samuel Ortega Sancho (AWS)

**Environment:** PoC or pilot

**Technologies:** Security, identity, compliance; Networking; Content delivery

**AWS services:** AWS Organizations; AWS Identity and Access Management

## Summary

In centralized network architectures, inspection and edge virtual private clouds (VPCs) concentrate all inbound and outbound traffic, such as traffic to and from the internet. However, this can create bottlenecks or result in reaching the limits of AWS service quotas. Deploying network edge security alongside the workloads in their VPCs provides unprecedented scalability in comparison to the more common, centralized approach. This is called a *distributed edge* architecture.

Although deploying public subnets in workload accounts can provide benefits, it also introduces new security risks because it increases the attack surface. We recommend that you deploy only Elastic Load Balancing (ELB) resources, such as Application Load Balancers, or NAT gateways in the public subnets of these VPCs. Using load balancers and NAT gateways in dedicated public subnets helps you implement fine-grained control for inbound and outbound traffic.

*Attribute-based access control* (ABAC) is the practice of creating fine-grained permissions based on user attributes, such as department, job role, and team name. For more information, see [ABAC for AWS](#). ABAC can provide guardrails for public subnets in workload accounts. This helps application teams be agile, without compromising the security of the infrastructure.

This pattern describes how to help secure public subnets by implementing ABAC through a [service control policy \(SCP\)](#) in AWS Organizations and [policies](#) in AWS Identity and Access Management (IAM). You apply the SCP to either a member account of an organization or to an organizational unit (OU). These ABAC policies permit users to deploy NAT gateways in the target subnets and prevent them from deploying other Amazon Elastic Compute Cloud (Amazon EC2) resources, such as EC2 instances and elastic network interfaces.

## Prerequisites and limitations

### Prerequisites

- An organization in AWS Organizations
- Administrative access to the AWS Organizations root account
- In the organization, an active member account or OU for testing the SCP

### Limitations

- The SCP in this solution doesn't prevent AWS services that use a service-linked role from deploying resources in the target subnets. Examples of these services are Elastic Load Balancing (ELB), Amazon Elastic Container Service (Amazon ECS), and Amazon Relational Database Service (Amazon RDS). For more information, see [SCP effects on permissions](#) in the AWS Organizations documentation. Implement security controls to detect these exceptions.

## Architecture

### Target technology stack

- SCP applied to an AWS account or OU in AWS Organizations
- The following IAM roles:
  - `AutomationAdminRole` – Used to modify subnet tags and create VPC resources after implementing the SCP
  - `TestAdminRole` – Used to test whether the SCP is preventing other IAM principals, including those with administrative access, from performing the actions reserved for the `AutomationAdminRole`

### Target architecture

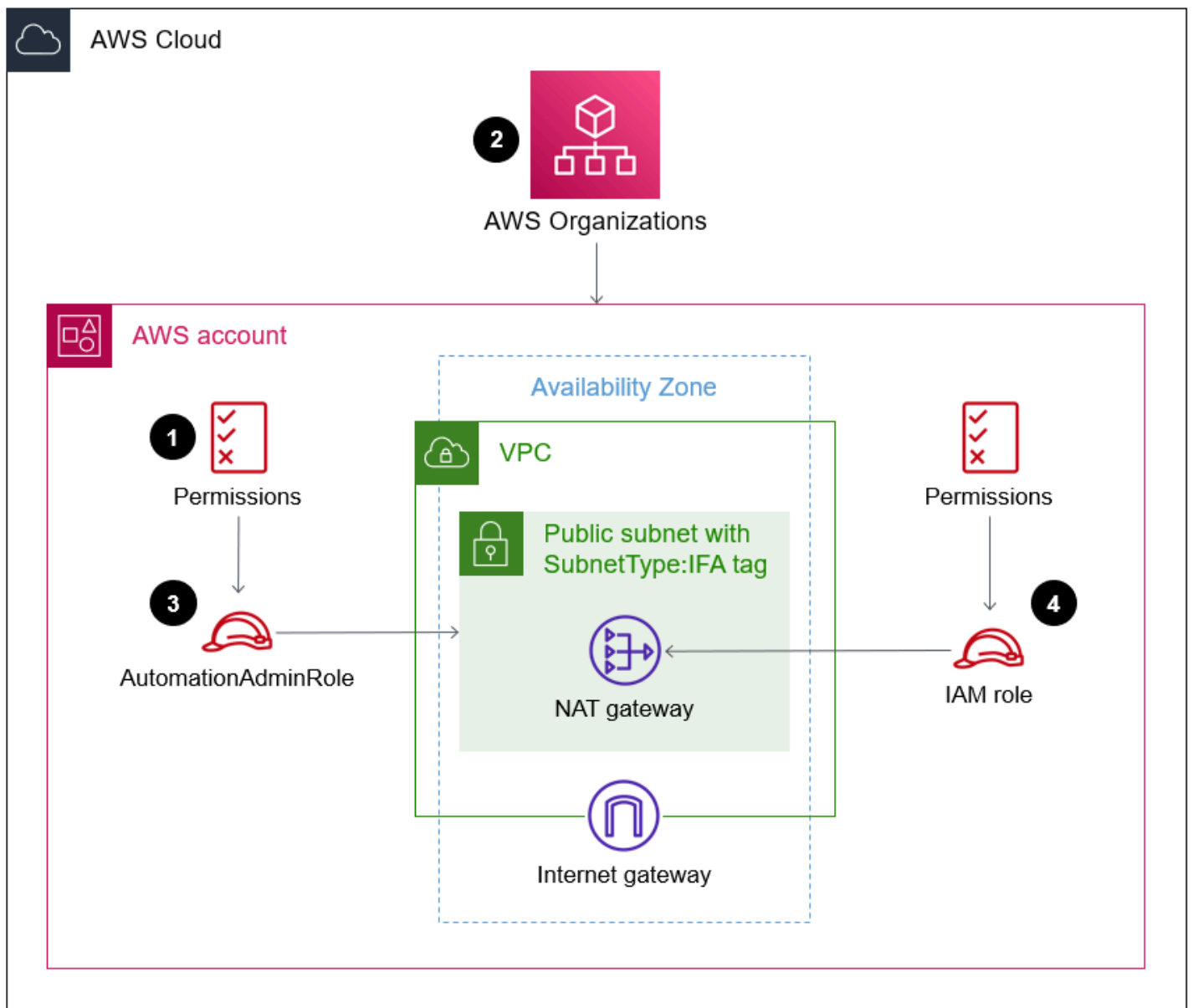

1. You create the `AutomationAdminRole` IAM role in the target account. This role has permissions to manage networking resources. Note the following permissions that are exclusive to this role:
  - This role can create VPCs and public subnets.
  - This role can modify the tag assignments for the target subnets.
  - This role can manage its own permissions.
2. In AWS Organizations, you apply the SCP to the target AWS account or OU. For a sample policy, see [Additional information](#) in this pattern.
3. A user or a tool in the CI/CD pipeline can assume the `AutomationAdminRole` role to apply the `SubnetType` tag to the target subnets.



4. By assuming other IAM roles, authorized IAM principals in your organization can manage NAT gateways in the target subnets and other permitted networking resources in the AWS account, such as route tables. Use IAM policies to grant these permissions. For more information, see [Identity and access management for Amazon VPC](#).

## Automation and scale

To help protect public subnets, the corresponding [AWS tags](#) must be applied. After applying the SCP, NAT gateways are the only kind of Amazon EC2 resource that authorized users can create in subnets that have the `SubnetType: IFA` tag. (IFA means *internet-facing assets*.) The SCP prevents the creation of other Amazon EC2 resources, such as instances and elastic network interfaces. We recommend that you use a CI/CD pipeline that assumes the `AutomationAdminRole` role to create VPC resources so that these tags are properly applied to public subnets.

## Tools

### AWS services

- [AWS Identity and Access Management \(IAM\)](#) helps you securely manage access to your AWS resources by controlling who is authenticated and authorized to use them.
- [AWS Organizations](#) is an account management service that helps you consolidate multiple AWS accounts into an organization that you create and centrally manage. In AWS Organizations, you can implement [service control policies \(SCPs\)](#), which are a type of policy that you can use to manage permissions in your organization.
- [Amazon Virtual Private Cloud \(Amazon VPC\)](#) helps you launch AWS resources into a virtual network that you've defined. This virtual network resembles a traditional network that you'd operate in your own data center, with the benefits of using the scalable infrastructure of AWS.

## Epics

### Apply the SCP

Task	Description	Skills required
Create a test admin role.	Create an IAM role named <code>TestAdminRole</code> in the target AWS account. Attach	AWS administrator

Task	Description	Skills required
	the <b>AdministratorAccess</b> AWS managed IAM policy to the new role. For instructions, see <a href="#">Creating a role to delegate permissions to an IAM user</a> in the IAM documentation.	

Task	Description	Skills required
Create the automation admin role.	<ol style="list-style-type: none"><li>1. Create an IAM role named <code>AutomationAdminRole</code> in the target AWS account.</li><li>2. Attach the <b>AdministratorAccess</b> AWS managed IAM policy to the new role.</li></ol> <p>The following is an example of a trust policy that you could use to test the role from the <code>000000000000</code> account.</p> <pre data-bbox="594 898 1027 1812">{   "Version":     "2012-10-17",   "Statement": [     {       "Effect":         "Allow",       "Principal": {         "AWS": [           "arn:aws:iam::000000000000:root"         ]       },       "Action":         "sts:AssumeRole",       "Condition": {}     }   ] }</pre>	AWS administrator

Task	Description	Skills required
Create and attach the SCP.	<ol style="list-style-type: none"> <li>Using the sample code provided in the <a href="#">Additional information</a> section, create a security control policy. For instructions, see <a href="#">Creating an SCP</a> in the AWS Organizations documentation.</li> <li>Attach the SCP to the target AWS account or OU. For instructions, see <a href="#">Attaching and detaching service control policies</a> in the AWS Organizations documentation.</li> </ol>	AWS administrator

## Test the SCP

Task	Description	Skills required
Create a VPC or subnet.	<ol style="list-style-type: none"> <li>Assume the TestAdminRole role in the target AWS account.</li> <li>Try to create a VPC or a new public subnet in an existing VPC. For instructions, see <a href="#">Create a VPC, subnets, and other VPC resources</a> in the Amazon VPC documentation. You shouldn't be able to create these resources.</li> </ol>	AWS administrator

Task	Description	Skills required
	<ol style="list-style-type: none"><li>3. Assume the <code>AutomationAdminRole</code> role, and retry the previous step. Now, you should be able to create the networking resources.</li></ol>	
Manage tags.	<ol style="list-style-type: none"><li>1. Assume the <code>TestAdminRole</code> role in the target AWS account.</li><li>2. Add a <code>SubnetType: IFA</code> tag to an available public subnet. You should be able to add this tag. For instructions about how to add tags through the AWS Command Line Interface (AWS CLI), see <a href="#">create-tags</a> in the <i>AWS CLI Command Reference</i>.</li><li>3. Without changing your credentials, attempt to modify the <code>SubnetType: IFA</code> tag assigned to this subnet. You shouldn't be able to modify this tag.</li><li>4. Assume the <code>AutomationAdminRole</code> role, and retry the previous steps. This role should be able to add and modify this tag.</li></ol>	AWS administrator

Task	Description	Skills required
Deploy resources in the target subnets.	<ol style="list-style-type: none"><li data-bbox="592 226 1027 310">1. Assume the TestAdmin Role role.</li><li data-bbox="592 331 1027 898">2. For a public subnet that has the SubnetType: IFA tag, try to create an EC2 instance. For instructions, see <a href="#">Launch an instance</a> in the Amazon EC2 documentation. In this subnet, you shouldn't be able to create, modify, or delete any Amazon EC2 resources except NAT gateways.</li><li data-bbox="592 919 1027 1329">3. In the same subnet, create a NAT gateway. For instructions, see <a href="#">Create a NAT gateway</a> in the Amazon VPC documentation. You should be able to create, modify, or delete NAT gateways in this subnet.</li></ol>	AWS administrator

Task	Description	Skills required
Manage the AutomationAdminRole role.	<ol style="list-style-type: none"> <li>1. Assume the TestAdminRole role.</li> <li>2. Try to modify the AutomationAdminRole role. For instructions, see <a href="#">Modifying a role</a> in the IAM documentation. You shouldn't be able to modify this role.</li> <li>3. Assume the AutomationAdminRole role, and retry the previous step. Now, you should be able to modify the role.</li> </ol>	AWS administrator

## Clean up

Task	Description	Skills required
Clean up deployed resources.	<ol style="list-style-type: none"> <li>1. Detach the SCP from the AWS account or OU. For instructions, see <a href="#">Detaching an SCP</a> in the AWS Organizations documentation.</li> <li>2. Delete the SCP. For instructions, see <a href="#">Deleting an SCP</a> (AWS Organizations documentation).</li> <li>3. Delete the AutomationAdminRole role and the TestAdminRole role. For instructions, see</li> </ol>	AWS administrator

Task	Description	Skills required
	<p><a href="#">Deleting roles</a> in the IAM documentation.</p> <p>4. Delete all networking resources, such as VPCs and subnets, that you created for this solution.</p>	

## Related resources

### AWS documentation

- [Attaching and detaching SCPs](#)
- [Creating, updating, and deleting SCPs](#)
- [Deploy detective attribute-based access controls for public subnets by using AWS Config](#)
- [Detective controls](#)
- [Service authorization reference](#)
- [Tagging AWS resources](#)
- [What is ABAC for AWS?](#)

### Additional AWS references

- [Securing resource tags used for authorization using a Service Control Policy in AWS Organizations](#) (AWS blog post)

## Additional information

The following service control policy is an example that you can use to test this approach in your organization.

```
{
  "Version": "2012-10-17",
  "Statement": [
    {
      "Sid": "DenyVPCActions",
```



```
"Effect": "Deny",
"Action": [
  "ec2:CreateVPC",
  "ec2:CreateRoute",
  "ec2:CreateSubnet",
  "ec2:CreateInternetGateway",
  "ec2>DeleteVPC",
  "ec2>DeleteRoute",
  "ec2>DeleteSubnet",
  "ec2>DeleteInternetGateway"
],
"Resource": [
  "arn:aws:ec2:*:*:*"
],
"Condition": {
  "StringNotLike": {
    "aws:PrincipalARN": ["arn:aws:iam:*:*:role/AutomationAdminRole"]
  }
}
},
{
  "Sid": "AllowNATGWOnIFASubnet",
  "Effect": "Deny",
  "NotAction": [
    "ec2:CreateNatGateway",
    "ec2>DeleteNatGateway"
  ],
  "Resource": [
    "arn:aws:ec2:*:*:subnet/*"
  ],
  "Condition": {
    "ForAnyValue:StringEqualsIfExists": {
      "aws:ResourceTag/SubnetType": "IFA"
    },
    "StringNotLike": {
      "aws:PrincipalARN": ["arn:aws:iam:*:*:role/AutomationAdminRole"]
    }
  }
},
{
  "Sid": "DenyChangesToAdminRole",
  "Effect": "Deny",
  "NotAction": [
    "iam:GetContextKeysForPrincipalPolicy",
```

```
    "iam:GetRole",
    "iam:GetRolePolicy",
    "iam:ListAttachedRolePolicies",
    "iam:ListInstanceProfilesForRole",
    "iam:ListRolePolicies",
    "iam:ListRoleTags"
  ],
  "Resource": [
    "arn:aws:iam::*:role/AutomationAdminRole"
  ],
  "Condition": {
    "StringNotLike": {
      "aws:PrincipalARN": ["arn:aws:iam::*:role/AutomationAdminRole"]
    }
  }
},
{
  "Sid": "allowbydefault",
  "Effect": "Allow",
  "Action": "*",
  "Resource": "*"
}
]
```

# Deploy the Security Automations for AWS WAF solution by using Terraform

Created by Dr. Rahul Sharad Gaikwad (AWS) and Tamilselvan P (AWS)

<b>Code repository:</b> <a href="#">aws-waf-automation-terraform-samples</a>	<b>Environment:</b> PoC or pilot	<b>Technologies:</b> Security, identity, compliance; Infrastructure; Content delivery; DevOps
<b>Workload:</b> All other workloads	<b>AWS services:</b> AWS WAF	

## Summary

AWS WAF is a web application firewall that helps protect applications from common exploits by using customizable rules, which you define and deploy in *web access control lists* (ACLs). Configuring AWS WAF rules can be challenging, especially for organizations that do not have dedicated security teams. To simplify this process, Amazon Web Services (AWS) offers the [Security Automations for AWS WAF](#) solution, which automatically deploys a single web ACL with a set of AWS WAF rules that filters web-based attacks. During Terraform deployment, you can specify which protective features to include. After you deploy this solution, AWS WAF inspects web requests to existing Amazon CloudFront distributions or Application Load Balancers, and blocks any requests that don't match the rules.

The Security Automations for AWS WAF solution can be deployed by using AWS CloudFormation according to the instructions in the [Security Automations for AWS WAF Implementation Guide](#). This pattern provides an alternative deployment option for organizations that use HashiCorp Terraform as their preferred infrastructure as code (IaC) tool to provision and manage their cloud infrastructure. When you deploy this solution, Terraform automatically applies the changes in the cloud and deploys and configures the AWS WAF settings and protective features.

## Prerequisites and limitations

### Prerequisites

- An active AWS account.
- AWS Command Line Interface (AWS CLI) installed and configured with necessary permissions. For more information, see [Getting started](#) (AWS CLI documentation).
- Terraform installed and configured. For more information, see [Install Terraform](#) (Terraform documentation).

## Product versions

- AWS CLI version 2.4.25 or later
- Terraform version 1.1.9 or later

# Architecture

## Target architecture

This pattern deploys the Security Automations for AWS WAF solution. For more information about the target architecture, see [Architecture overview](#) in the *Security Automations for AWS WAF Implementation Guide*. For more information about the AWS Lambda automations in this deployment, the Application log parser, the AWS WAF log parser, the IP lists parser, and the Access handler, see [Component details](#) in the *Security Automations for AWS WAF Implementation Guide*.

## Terraform deployment

When you run `terraform apply`, Terraform does the following:

1. Terraform creates IAM roles and Lambda functions based on the inputs from the **testing.tfvars** file.
2. Terraform creates AWS WAF ACL rules and IP sets based on the inputs from the **testing.tfvars** file.
3. Terraform creates the Amazon Simple Storage Service (Amazon S3) buckets, Amazon EventBridge rules, AWS Glue database tables, and Amazon Athena work groups based on the inputs from the **testing.tfvars** file.
4. Terraform deploys the AWS CloudFormation stack to provision the custom resources.
5. Terraform creates the Amazon API Gateway resources based on the given inputs from **testing.tfvars** file.

## Automation and scale

You can use this pattern to create AWS WAF rules for multiple AWS accounts and AWS Regions to deploy the Security Automations for AWS WAF solution throughout your AWS Cloud environment.

## Tools

### AWS services

- [AWS Command Line Interface \(AWS CLI\)](#) is an open-source tool that helps you interact with AWS services through commands in your command-line shell.
- [AWS WAF](#) is a web application firewall that helps you monitor HTTP and HTTPS requests that are forwarded to your protected web application resources.

### Other services

- [Git](#) is an open-source, distributed version control system.
- [HashiCorp Terraform](#) is a command-line interface application that helps you use code to provision and manage cloud infrastructure and resources.

### Code repository

The code for this pattern is available in the GitHub [AWS WAF Automation Using Terraform](#) repository.

## Best practices

- Put static files in separate S3 buckets.
- Avoid hardcoding variables.
- Limit the use of custom scripts.
- Adopt a naming convention.

# Epics

## Set up your local workstation

Task	Description	Skills required
Install Git.	Follow the instructions in <a href="#">Getting started</a> (Git website) to install Git on your local workstation.	DevOps engineer
Clone the repository.	On your local workstation, enter the following command to clone the code repository. To copy the full command, including the repo URL, see the <a href="#">Additional information</a> section of this pattern. <pre>git clone &lt;repo-URL&gt; .git</pre>	DevOps engineer
Update the variables.	<ol style="list-style-type: none"><li>Navigate into the cloned directory by entering the following command. <pre>cd terraform-aws-waf-automation</pre></li><li>In any text editor, open the <b>testing.tfvars</b> file.</li><li>Update the values of the variables in the <b>testing.tfvars</b> file.</li><li>Save and close the file.</li></ol>	DevOps engineer

## Provision the target architecture using Terraform

Task	Description	Skills required
Initialize the Terraform configuration.	<p>Enter the following command to initialize your working directory that contains the Terraform configuration files.</p> <pre>terraform init</pre>	DevOps engineer
Preview the Terraform plan.	<p>Enter the following command. Terraform evaluates the configuration files to determine the target state for the declared resources. It then compares the target state against the current state and creates a plan.</p> <pre>terraform plan -var-file="testing.tfvars"</pre>	DevOps engineer
Verify the plan.	<p>Review the plan and confirm that it configures the required architecture in your target AWS account.</p>	DevOps engineer
Deploy the solution.	<p>1. Enter the following command to apply the plan.</p> <pre>terraform apply -var-file="testing.tfvars"</pre>	DevOps engineer

Task	Description	Skills required
	<p>2. Enter yes to confirm.</p> <p>Terraform creates, updates, or destroys infrastructure to achieve the target state declared in the configuration files. For more information about the sequence, see <i>Terraform deployment</i> in the <a href="#">Architecture</a> section of this pattern.</p>	

## Validate and clean up

Task	Description	Skills required
Verify the changes.	<ol style="list-style-type: none"> <li>1. In the Terraform console, verify that the outputs match the expected results.</li> <li>2. Sign in to the AWS Management Console.</li> <li>3. Verify the outputs in the Terraform console have been successfully deployed in your AWS account.</li> </ol>	DevOps engineer
(Optional) Clean up the infrastructure.	<p>If you want to remove all resources and configuration changes made by this solution, do the following:</p> <ol style="list-style-type: none"> <li>1. In the Terraform console, enter the following command.</li> </ol>	DevOps engineer



Task	Description	Skills required
	<pre>terraform destroy - var-file="testing .tfvars"</pre> <p>2. Enter yes to confirm.</p>	

## Troubleshooting

Issue	Solution
WAFV2 IPSet: WAFOptimisticLockException error	If you receive this error when you run the terraform destroy command, you must manually delete the IP sets. For instructions, see <a href="#">Deleting an IP set</a> (AWS WAF documentation).

## Related resources

### AWS references

- [Security Automations for AWS WAF Implementation Guide](#)
- [Security Automations for AWS WAF](#) (AWS Solutions Library)
- [Security Automations for AWS WAF FAQ](#)

### Terraform references

- [Terraform Backend Configuration](#)
- [Terraform AWS Provider - Documentation and Usage](#)
- [Terraform AWS Provider](#) (GitHub repository)

## Additional information

The following command clones the GitHub repository for this pattern.

```
git clone https://github.com/aws-samples/aws-waf-automation-terraform-samples.git
```

# Detect Amazon RDS and Aurora database instances that have expiring CA certificates

Created by Stephen DiCato (AWS) and Eugene Shifer (AWS)

**Code repository:** [Detect Amazon RDS instances with expiring CA certificates](#)

**Environment:** Production

**Technologies:** Security, identity, compliance; CloudNative; Infrastructure

**AWS services:** Amazon Aurora; AWS Config; Amazon RDS; AWS Security Hub

## Summary

As a security best practice, it is recommended that you encrypt data in transit between application servers and relational databases. You can use SSL or TLS to encrypt a connection to a database (DB) instance or cluster. These protocols help provide confidentiality, integrity, and authenticity between an application and database. The database uses a server certificate, which is issued by a [certificate authority \(CA\)](#) and is used to perform server identity verification. SSL or TLS verifies the authenticity of the certificate by validating its digital signature and ensuring it is not expired.

In the AWS Management Console, [Amazon Relational Database Service \(Amazon RDS\)](#) and [Amazon Aurora](#) provide notifications about DB instances that require certificate updates. However, to check for these notifications, you must log into each AWS account and navigate to the service console in each AWS Region. This task becomes more complex if you need to assess certificate validity across many AWS accounts that are managed as an organization in [AWS Organizations](#).

By provisioning the infrastructure as code (IaC) provided in this pattern, you can detect expiring CA certificates for all Amazon RDS and Aurora DB instances in your AWS account or AWS organization. The [AWS CloudFormation](#) template provisions an AWS Config rule, an AWS Lambda function, and the necessary permissions. You can deploy it into a single account as a [stack](#), or you can deploy it across the entire AWS organization as a [stack set](#).

## Prerequisites and limitations

### Prerequisites

- An active AWS account
- If you're deploying into a single AWS account:
  - Ensure that you have [permissions](#) to create CloudFormation stacks.
  - [Enable](#) AWS Config in the target account.
  - (Optional) [Enable](#) AWS Security Hub in the target account.
- If you're deploying into an AWS organization:
  - Ensure that you have [permissions](#) to create CloudFormation stack sets.
  - [Enable](#) Security Hub with AWS Organizations integration.
  - [Enable](#) AWS Config in the accounts where you are deploying this solution.
  - Designate an AWS account to be the delegated administrator for AWS Config and Security Hub.

## Limitations

- If you're deploying to an individual account that doesn't have Security Hub enabled, you can use AWS Config to evaluate the findings.
- If you're deploying to an organization that doesn't have a delegated administrator for AWS Config and Security Hub, you must log into the individual member accounts to view the findings.
- If you use AWS Control Tower to manage and govern the accounts in your organization, deploy the IaC in this pattern by using [Customizations for AWS Control Tower \(CfCT\)](#). Using the CloudFormation console will create configuration drift from AWS Control Tower guardrails and require that you re-enroll the organizational units (OUs) or managed accounts.
- Some AWS services aren't available in all AWS Regions. For Region availability, see the [Service endpoints and quotas](#) page, and choose the link for the service.

## Architecture

### Deploying into an individual AWS account

The following architecture diagram shows the deployment of the AWS resources within a single AWS account. It's implemented by using a CloudFormation template directly through the CloudFormation console. If Security Hub is enabled, you can view the results in either AWS Config or Security Hub. If Security Hub is not enabled, you can view the results only in the AWS Config console.

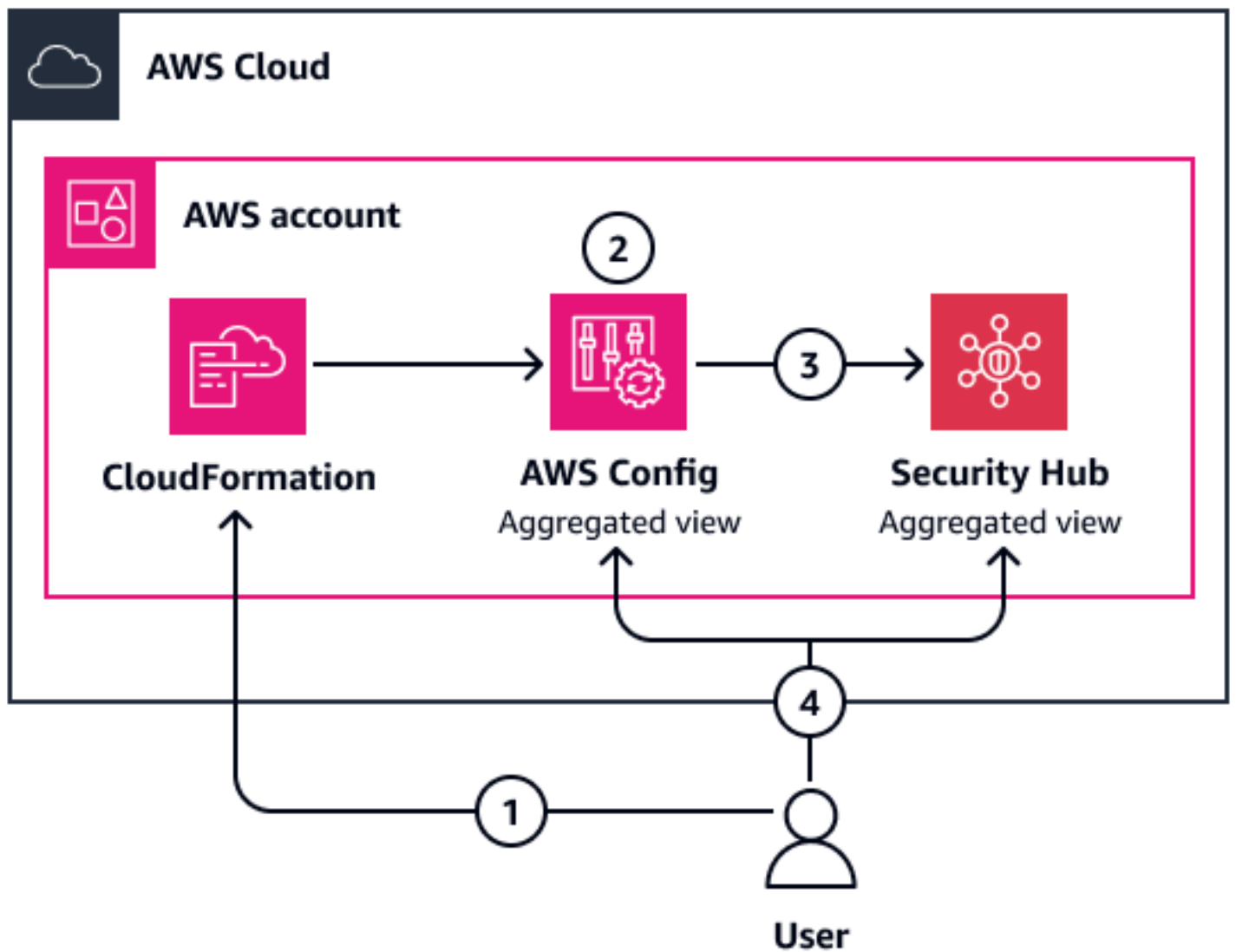

The diagram shows the following steps:

1. You create a CloudFormation stack. This deploys a Lambda function and an AWS Config rule. Both the rule and function are set up with the AWS Identity and Access Management (IAM) permissions required to publish resource evaluations in AWS Config and logs.
2. The AWS Config rule operates in [detective evaluation mode](#) and runs every 24 hours.
3. Security Hub receives all AWS Config findings.
4. You can view the findings in Security Hub or in AWS Config, depending on the account's configuration.

## Deploying into an AWS organization

The following diagram shows the assessment of certificate expiration across multiple accounts that are managed through AWS Organizations and AWS Control Tower. You deploy the CloudFormation template through CfCT. The assessment outcomes are centralized in Security Hub in the delegated administrator account. The AWS CodePipeline workflow depicted in the diagram shows the background steps that occur during CfCT deployment.

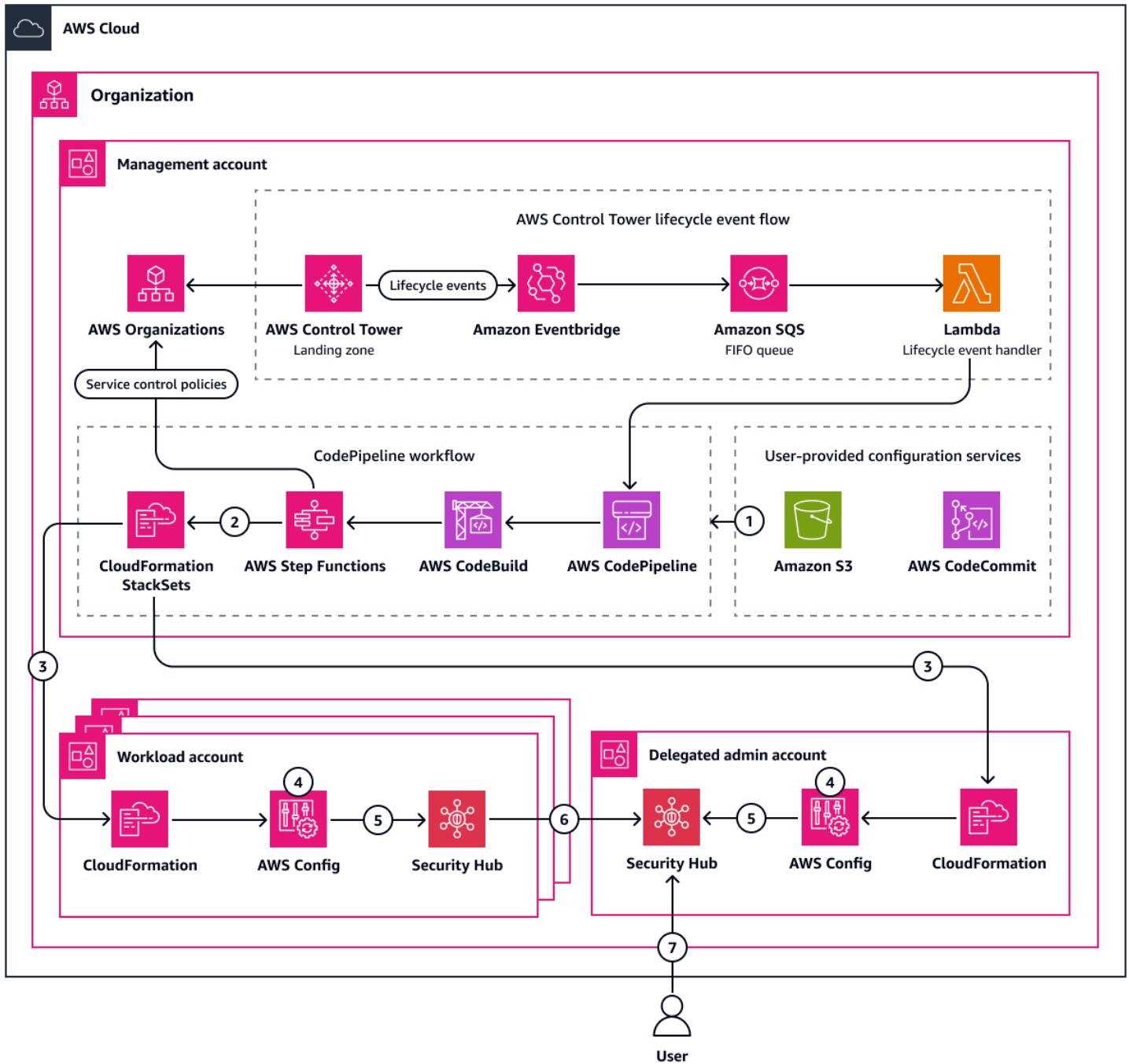

The diagram shows the following steps:

1. Depending on the configuration for CfCT, in the management account, you push the IaC to an AWS CodeCommit repository or you upload a compressed (ZIP) file of the IaC to an Amazon Simple Storage Service (Amazon S3) bucket.
2. The CfCT pipeline unzips the file, runs [cfn-nag](#) (GitHub) checks, and deploys it as a CloudFormation stack set.
3. Depending on the configuration specified in the CfCT manifest file, CloudFormation StackSets deploys stacks into individual accounts or specified OUs. This deploys a Lambda function and an AWS Config rule in the target accounts. Both the rule and function are set up with the IAM permissions required to publish resource evaluations in AWS Config and logs.
4. The AWS Config rule operates in [detective evaluation mode](#) and runs every 24 hours.
5. AWS Config forwards all findings to Security Hub.
6. Security Hub findings are aggregated in the delegated administrator account.
7. You can view the findings in Security Hub in the delegated administrator account.

## Tools

### AWS services

- [AWS CloudFormation](#) helps you set up AWS resources, provision them quickly and consistently, and manage them throughout their lifecycle across AWS accounts and Regions.
- [AWS Config](#) provides a detailed view of the resources in your AWS account and how they're configured. It helps you identify how resources are related to one another and how their configurations have changed over time. An AWS Config [rule](#) defines your ideal configuration settings for a resource, and AWS Config can evaluate whether your AWS resources comply with the conditions in your rules.
- [AWS Control Tower](#) helps you set up and govern an AWS multi-account environment, following prescriptive best practices. [Customizations for AWS Control Tower \(CfCT\)](#) helps you customize your AWS Control Tower landing zone and stay aligned with AWS best practices. Customizations are implemented with CloudFormation templates and service control policies (SCPs).
- [AWS Lambda](#) is a compute service that helps you run code without needing to provision or manage servers. It runs your code only when needed and scales automatically, so you pay only for the compute time that you use.
- [AWS Organizations](#) is an account management service that helps you consolidate multiple AWS accounts into an organization that you create and centrally manage.

- [AWS Security Hub](#) provides a comprehensive view of your security state in AWS. It also helps you check your AWS environment against security industry standards and best practices.

## Other tools

- [Python](#) is a general-purpose computer programming language.

## Code repository

The code for this pattern is available in the GitHub [Detect Amazon RDS instances with expiring CA certificates](#) repository.

## Best practices

We recommend that you adhere to the best practices in the following resources:

- [Best Practices for Organizational Units with AWS Organizations](#) (AWS Cloud Operations & Migrations Blog)
- [Guidance for Establishing an Initial Foundation using AWS Control Tower on AWS](#) (AWS Solutions Library)
- [Guidance for creating and modifying AWS Control Tower resources](#) (AWS Control Tower documentation)
- [CfCT deployment considerations](#) (AWS Control Tower documentation)

## Epics

### Review the solution and code

Task	Description	Skills required
Determine your deployment strategy.	Review the solution and code to determine how you will deploy it into your AWS environment. Determine if you will be deploying into a single account or an AWS organization.	App owner, General AWS



Task	Description	Skills required
Clone the repository.	<p>Enter the following command to clone the <a href="#">Detect Amazon RDS instances with expiring CA certificates</a> repository.</p> <pre>git clone https://github.com/aws-samples/config-rds-ca-expiry.git</pre>	App developer, App owner
Validate the Python version.	<ol style="list-style-type: none"><li>1. Navigate into the top-level directory in the cloned repository.<pre>cd config-rds-ca-expiry</pre></li><li>2. Open <b>config-rds-ca-expiry.yaml</b>.</li><li>3. In the <code>CertExpirationCheckLambdaFunction</code> resource, confirm that the Python version is compatible with your target AWS Regions. By default, this function uses Python 3.12. For more information, see <a href="#">AWS Lambda adds support for Python 3.12</a>. If necessary, update the Python version.</li><li>4. Save and close <b>config-rds-ca-expiry.yaml</b>.</li></ol>	App developer, App owner

## Deploy the solution

Task	Description	Skills required
Deploy the CloudFormation template.	<p>Deploy the CloudFormation template to your AWS environment. Do one of the following:</p> <ul style="list-style-type: none"><li>• If you're deploying to a single AWS account, follow the instructions in <a href="#">Creating a stack</a>.</li><li>• If you're deploying to an organization that isn't managed by AWS Control Tower, follow the instructions in <a href="#">Create a stack set</a>.</li><li>• If you're deploying to an organization that is managed by AWS Control Tower, see the instructions in the <a href="#">Build your own customizations</a>.</li></ul>	App developer, AWS administrator, General AWS
Verify the deployment.	In the <a href="#">CloudFormation console</a> , verify that the stack or stack set has deployed successfully.	AWS administrator, App owner

## Review the findings

Task	Description	Skills required
View the AWS Config rule findings.	<p>In Security Hub, do the following to view a list of individual findings:</p> <ol style="list-style-type: none"><li>1. Open the <a href="#">Security Hub console</a>.</li><li>2. In the navigation pane, choose <b>Findings</b>.</li><li>3. In the <b>Add filters</b> box, add the following filters:<ul style="list-style-type: none"><li>• <b>Compliance Status</b> is FAILED</li><li>• <b>Title</b> is rds-has-expiring-ca</li></ul></li><li>4. Choose <b>Apply</b>.</li></ol> <p>In Security Hub, do the following to view a list of total findings grouped by AWS account:</p> <ol style="list-style-type: none"><li>1. Open the <a href="#">Security Hub console</a>.</li><li>2. In the navigation pane, choose <b>Insights</b>.</li><li>3. Choose <b>Create insight</b>.</li><li>4. To select the grouping attribute for the insight:<ol style="list-style-type: none"><li>a. Choose the search box to display the filter options.</li></ol></li></ol>	AWS administrator, AWS systems administrator, Cloud administrator

Task	Description	Skills required
	<p>b. Choose <b>Group by</b>.</p> <p>c. Select <b>AwsAccountId</b>.</p> <p>d. Choose <b>Apply</b>.</p> <p>5. In the <b>Add filters</b> box, add the following filters:</p> <ul style="list-style-type: none"> <li>• <b>Title</b> is rds-has-expiring-ca</li> <li>• <b>Compliance Status</b> is FAILED</li> </ul> <p>6. Choose <b>Create insight</b>.</p> <p>7. Enter an <b>Insight name</b>, and then choose <b>Create insight</b>.</p> <p>In AWS Config, to view a list of findings, follow the instructions in <a href="#">Viewing Compliance Information and Evaluation Results</a> in the AWS Config documentation.</p>	

## Troubleshooting

Issue	Solution
CloudFormation stack set creation or deletion fails	When AWS Control Tower is deployed, it enforces necessary guardrails and assumes control over AWS Config aggregators and rules. This includes preventing any direct alterations through CloudFormation. To properly deploy or remove this CloudForm

Issue	Solution
CfCT fails to delete the CloudFormation template	ation template, including all associated resources, you must use CfCT.  If the CloudFormation template persists even after making necessary changes in the manifest file and removing the template files, confirm that the manifest file contains the <code>enable_stack_set_deletion</code> parameter and that the value is set to <code>false</code> . For more information, see <a href="#">Delete a stack set</a> in the CfCT documentation.

## Related resources

- [Using SSL/TLS to encrypt a connection to a DB instance or cluster](#) (Amazon RDS documentation)
- [AWS Config Custom Rules](#) (AWS Config documentation)

# Dynamically generate an IAM policy with IAM Access Analyzer by using Step Functions

Created by Thomas Scott (AWS), Adil El Kanabi (AWS), Koen van Blijderveen (AWS), and Rafal Pawlaszek (AWS)

**Code repository:** [Automated IAM Access Analyzer Role Policy Generator](#)

**Environment:** PoC or pilot

**Technologies:** Security, identity, compliance; Serverless

**AWS services:** AWS IAM Access Analyzer; AWS Lambda; AWS Step Functions ; AWS Identity and Access Management

## Summary

*Least-privilege* is the security best practice of granting the minimum permissions required to perform a task. Implementing least-privilege access in an already active Amazon Web Services (AWS) account can be challenging because you don't want to unintentionally block users from performing their job duties by changing their permissions. Before you can implement AWS Identity and Access Management (IAM) policy changes, you need to understand the actions and resources the account users are performing.

This pattern is designed to help you apply the principle of least-privilege access, without blocking or slowing down team productivity. It describes how to use IAM Access Analyzer and AWS Step Functions to dynamically generate an up-to-date IAM policy for your role, based on the actions that are currently being performed in the account. The new policy is designed to permit the current activity but remove any unnecessary, elevated privileges. You can customize the generated policy by defining allow and deny rules, and the solution integrates your custom rules.

This pattern includes options for implementing the solution with AWS Cloud Development Kit (AWS CDK) or HashiCorp CDK for Terraform (CDKTF). You can then associate the new policy to the role by using a continuous integration and continuous delivery (CI/CD) pipeline. If you have a multi-

account architecture, you can deploy this solution in any account where you want to generate updated IAM policies for the roles, increasing the security of your entire AWS Cloud environment.

## Prerequisites and limitations

### Prerequisites

- An active AWS account with a AWS CloudTrail trail enabled.
- IAM permissions for the following:
  - Create and deploy Step Functions workflows. For more information, see [Actions, resources, and condition keys for AWS Step Functions](#) (Step Functions documentation).
  - Create AWS Lambda functions. For more information, see [Execution role and user permissions](#) (Lambda documentation).
  - Create IAM roles. For more information, see [Creating a role to delegate permissions to an IAM user](#) (IAM documentation).
- npm installed. For more information, see [Downloading and installing Node.js and npm](#) (npm documentation).
- If you are deploying this solution with AWS CDK (Option 1):
  - AWS CDK Toolkit, installed and configured. For more information, see [Install the AWS CDK](#) (AWS CDK documentation).
- If you are deploying this solution with CDKTF (Option 2):
  - CDKTF, installed and configured. For more information, see [Install CDK for Terraform](#) (CDKTF documentation).
  - Terraform, installed and configured. For more information, see [Get Started](#) (Terraform documentation).
- AWS Command Line Interface (AWS CLI) locally installed and configured for your AWS account. For more information, see [Installing or updating the latest version of the AWS CLI](#) (AWS CLI documentation).

### Limitations

- This pattern does not apply the new IAM policy to the role. At the end of this solution, the new IAM policy is stored in an AWS CodeCommit repository. You can use a CI/CD pipeline to apply policies to the roles in your account.

# Architecture

## Target architecture

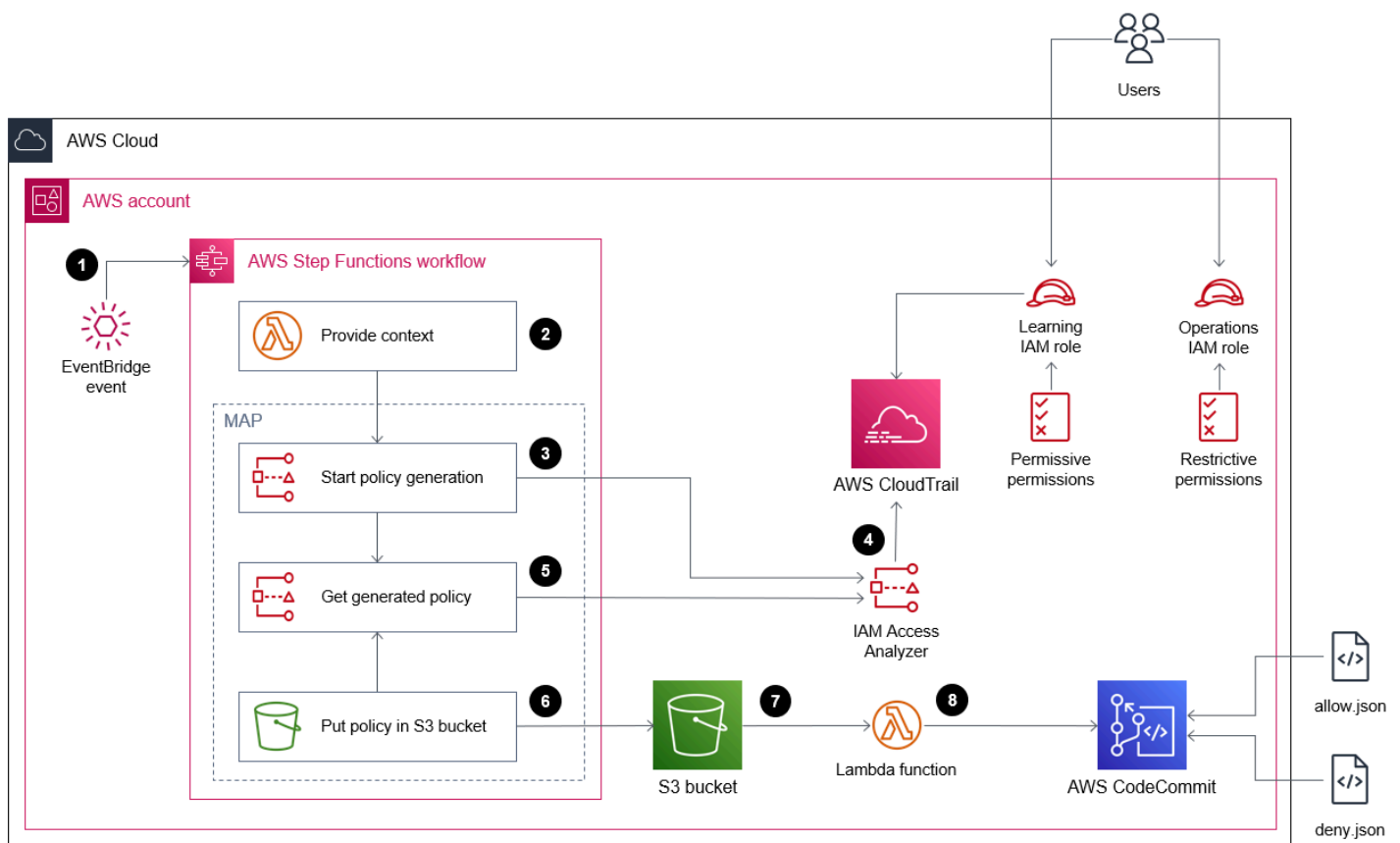

1. A regularly scheduled Amazon EventBridge event rule starts a Step Functions workflow. You define this regeneration schedule as part of setting up this solution.
2. In the Step Functions workflow, a Lambda function generates the date ranges to use when analyzing account activity in the CloudTrail logs.
3. The next workflow step calls the IAM Access Analyzer API to start generating the policy.
4. Using the Amazon Resource Name (ARN) of the role you specify during set up, IAM Access Analyzer analyzes the CloudTrail logs for activity within the specified date range. Based on the activity, IAM Access Analyzer generates an IAM policy that permits only the actions and services used by the role during the specified date range. When this step is complete, this step generates a job ID.
5. The next workflow step checks for the job ID every 30 seconds. When the job ID is detected, this step uses the job ID to call the IAM Access Analyzer API and retrieve the new IAM policy. IAM Access Analyzer returns the policy as a JSON file.



6. The next workflow step puts the **<IAM role name>/policy.json** file in an Amazon Simple Storage Service (Amazon S3) bucket. You define this S3 bucket as part of setting up this solution.
7. An Amazon S3 event notification starts a Lambda function.
8. The Lambda function retrieves the policy from the S3 bucket, integrates the custom rules you define in the **allow.json** and **deny.json** files, and then pushes the updated policy to CodeCommit. You define the CodeCommit repository, branch, and folder path as part of setting up this solution.

## Tools

### AWS services

- [AWS Cloud Development Kit \(AWS CDK\)](#) is a software development framework that helps you define and provision AWS Cloud infrastructure in code.
- [AWS CDK Toolkit](#) is a command line cloud development kit that helps you interact with your AWS Cloud Development Kit (AWS CDK) app.
- [AWS CloudTrail](#) helps you audit the governance, compliance, and operational risk of your AWS account.
- [AWS CodeCommit](#) is a version control service that helps you privately store and manage Git repositories, without needing to manage your own source control system.
- [AWS Command Line Interface \(AWS CLI\)](#) is an open-source tool that helps you interact with AWS services through commands in your command-line shell.
- [AWS Identity and Access Management \(IAM\)](#) helps you securely manage access to your AWS resources by controlling who is authenticated and authorized to use them. This pattern uses [IAM Access Analyzer](#), a feature of IAM, to analyze your CloudTrail logs to identify actions and services that have been used by an IAM entity (user or role) and then generate an IAM policy that is based on that activity.
- [AWS Lambda](#) is a compute service that helps you run code without needing to provision or manage servers. It runs your code only when needed and scales automatically, so you pay only for the compute time that you use.
- [Amazon Simple Storage Service \(Amazon S3\)](#) is a cloud-based object storage service that helps you store, protect, and retrieve any amount of data.

- [AWS Step Functions](#) is a serverless orchestration service that helps you combine AWS Lambda functions and other AWS services to build business-critical applications. In this pattern, you use [AWS SDK service integrations](#) in Step Functions to call service API actions from your workflow.

## Other tools

- [CDK for Terraform \(CDKTF\)](#) helps you define infrastructure as code (IaC) by using common programming languages, such as Python and Typescript.
- [Lerna](#) is a build system for managing and publishing multiple JavaScript or TypeScript packages from the same repository.
- [Node.js](#) is an event-driven JavaScript runtime environment designed for building scalable network applications.
- [npm](#) is a software registry that runs in a Node.js environment and is used to share or borrow packages and manage deployment of private packages.

## Code repository

The code for this pattern is available in the GitHub [Automated IAM Access Analyzer Role Policy Generator](#) repository.

## Epics

### Prepare for deployment

Task	Description	Skills required
Clone the repo.	<p>The following command clones the <a href="#">Automated IAM Access Analyzer Role Policy Generator</a> (GitHub) repository.</p> <pre>git clone https://github.com/aws-samples/automated-iam-access-analyzer.git</pre>	App developer

Task	Description	Skills required
Install Lerna.	The following command installs Lerna. <pre data-bbox="597 348 1027 428">npm i -g lerna</pre>	App developer
Set up the dependencies.	The following command installs the dependencies for the repository. <pre data-bbox="597 632 1027 831">cd automated-iam-access-analyzer/ npm install &amp;&amp; npm run bootstrap</pre>	App developer
Build the code.	The following command tests, builds, and prepares the zip packages of the Lambda functions. <pre data-bbox="597 1087 1027 1245">npm run test:code npm run build:code npm run pack:code</pre>	App developer
Build the constructs.	The following command builds the infrastructure synthesizing applications, for both AWS CDK and CDKTF. <pre data-bbox="597 1499 1027 1579">npm run build:infra</pre>	

Task	Description	Skills required
Configure any custom permissions.	In the <b>repo</b> folder of the cloned repository, edit the <b>allow.json</b> and <b>deny.json</b> files to define any custom permissions for the role. If the <b>allow.json</b> and <b>deny.json</b> files contain the same permission, the deny permission is applied.	AWS administrator, App developer

### Option 1 – Deploy the solution using AWS CDK

Task	Description	Skills required
Deploy the AWS CDK stack.	<p>The following command deploys the infrastructure through AWS CloudFormation. Define the following parameters:</p> <ul style="list-style-type: none"> <li>&lt;NAME_OF_ROLE&gt; – The ARN of the IAM role for which you are creating a new policy.</li> <li>&lt;TRAIL_ARN&gt; – The ARN of the CloudTrail trail in which the role activity is stored.</li> <li>&lt;CRON_EXPRESSION_T0_RUN_SOLUTION&gt; – The Cron expression that defines the regeneration schedule for the policy. The</li> </ul>	App developer

Task	Description	Skills required
	<p>Step Functions workflow runs on this schedule.</p> <ul style="list-style-type: none"> <li>• &lt;TRAIL_LOOKBACK&gt; <ul style="list-style-type: none"> <li>– The period, in days, to look back in the trail when evaluating the role permissions.</li> </ul> </li> </ul> <pre data-bbox="594 617 1029 1134"> cd infra/cdk cdk deploy --parameters   roleArn=&lt;NAME_OF_ROLE&gt; \ --parameters trailArn= &lt;TRAIL_ARN&gt; \ --parameters schedule= &lt;CRON_EXPRESSION_T O_RUN_SOLUTION&gt; \ [ --parameters   trailLookBack=&lt;TRAIL_LOOKBACK&gt; ] </pre> <p><b>Note:</b> The square brackets denote optional parameters.</p>	
(Optional) Wait for the new policy.	<p>If the trail does not contain a reasonable amount of historical activity for the role, wait until you are confident that there is enough logged activity for IAM Access Analyzer to generate an accurate policy. If the role has been active in the account for a sufficient period of time, this waiting period might not be necessary.</p>	AWS administrator

Task	Description	Skills required
Manually review the generated policy.	In your CodeCommit repository, review the generated <b>&lt;ROLE_ARN&gt;.json</b> file to confirm that the allow and deny permissions are appropriate for the role.	AWS administrator

## Option 2 – Deploy the solution using CDKTF

Task	Description	Skills required
Synthesize the Terraform template.	<p>The following command synthesizes the Terraform template.</p> <pre>lerna exec cdktf synth --scope @aiaa/tfm</pre>	App developer
Deploy the Terraform template.	<p>The following command navigates to the directory that contains the CDKTF-defined infrastructure.</p> <pre>cd infra/cdktf</pre> <p>The following command deploys the infrastructure in the target AWS account. Define the following parameters:</p> <ul style="list-style-type: none"> <li>• <b>&lt;account_ID&gt;</b> – The ID of the target account.</li> </ul>	App developer

Task	Description	Skills required
	<ul style="list-style-type: none"><li>• <code>&lt;region&gt;</code> - The target AWS Region.</li><li>• <code>&lt;selected_role_ARN&gt;</code> – The ARN of the IAM role for which you are creating a new policy.</li><li>• <code>&lt;trail_ARN&gt;</code> – The ARN of the CloudTrail trail in which the role activity is stored.</li><li>• <code>&lt;schedule_expression&gt;</code> – The Cron expression that defines the regeneration schedule for the policy. The Step Functions workflow runs on this schedule.</li><li>• <code>&lt;trail_look_back&gt;</code> – The period, in days, to look back in the trail when evaluating the role permissions.</li></ul> <pre data-bbox="597 1367 1026 1774">TF_VAR_accountId=&lt;account_ID&gt; \   TF_VAR_region=&lt;region&gt; \   TF_VAR_roleArns=&lt;selected_role_ARN&gt; \   TF_VAR_trailArn=&lt;trail_ARN&gt; \   TF_VAR_schedule=&lt;schedule_expression&gt; \ </pre>	

Task	Description	Skills required
	<pre>[ TF_VAR_trailLookBack=&lt;trail_look_back&gt; ] \ cdktf deploy</pre> <p><b>Note:</b> The square brackets denote optional parameters.</p>	
(Optional) Wait for the new policy.	If the trail does not contain a reasonable amount of historical activity for the role, wait until you are confident that there is enough logged activity for IAM Access Analyzer to generate an accurate policy. If the role has been active in the account for a sufficient period of time, this waiting period might not be necessary.	AWS administrator
Manually review the generated policy.	In your CodeCommit repository, review the generated <b>&lt;ROLE_ARN&gt;.json</b> file to confirm that the allow and deny permissions are appropriate for the role.	AWS administrator

## Related resources

### AWS resources

- [IAM Access Analyzer endpoints and quotas](#)
- [Configuring the AWS CLI](#)
- [Getting started with the AWS CDK](#)
- [Least-privilege permissions](#)



## Other resources

- [CDK for Terraform](#) (Terraform website)

# Enable Amazon GuardDuty conditionally by using AWS CloudFormation templates

Created by Ram Kandaswamy (AWS)

**Environment:** Production

**Technologies:** Security, identity, compliance; DevOps; Operations

**AWS services:** AWS CloudFormation; Amazon GuardDuty; AWS Lambda; AWS Identity and Access Management

## Summary

You can enable Amazon GuardDuty on an Amazon Web Services (AWS) account by using an AWS CloudFormation template. By default, if GuardDuty is already enabled when you try to use CloudFormation to turn it on, the stack deployment fails. However, you can use conditions in your CloudFormation template to check whether GuardDuty is already enabled. CloudFormation supports the use of conditions that compare static values; it does not support using the output of another resource property within the same template. For more information, see [Conditions](#) in the CloudFormation user guide.

In this pattern, you use a CloudFormation custom resource backed by an AWS Lambda function to conditionally enable GuardDuty if it is not already enabled. If GuardDuty is enabled, the stack captures the status and records it in the output section of the stack. If GuardDuty is not enabled, the stack enables it.

## Prerequisites and limitations

### Prerequisites

- An active AWS account
- An AWS Identity and Access Management (IAM) role that has permissions to create, update, and delete CloudFormation stacks

### Limitations

- If GuardDuty has been manually disabled for an AWS account or Region, this pattern does not enable GuardDuty for that target account or Region.

## Architecture

### Target technology stack

The pattern uses CloudFormation for Infrastructure as Code (IaC). You use a CloudFormation custom resource backed by a Lambda function to achieve the dynamic service-enablement capability.

### Target architecture

The following high-level architecture diagram shows the process of enabling GuardDuty by deploying a CloudFormation template:

1. You deploy a CloudFormation template to create a CloudFormation stack.
2. The stack creates an IAM role and a Lambda function.
3. The Lambda function assumes the IAM role.
4. If GuardDuty is not already enabled on the target AWS account, the Lambda function enables it.

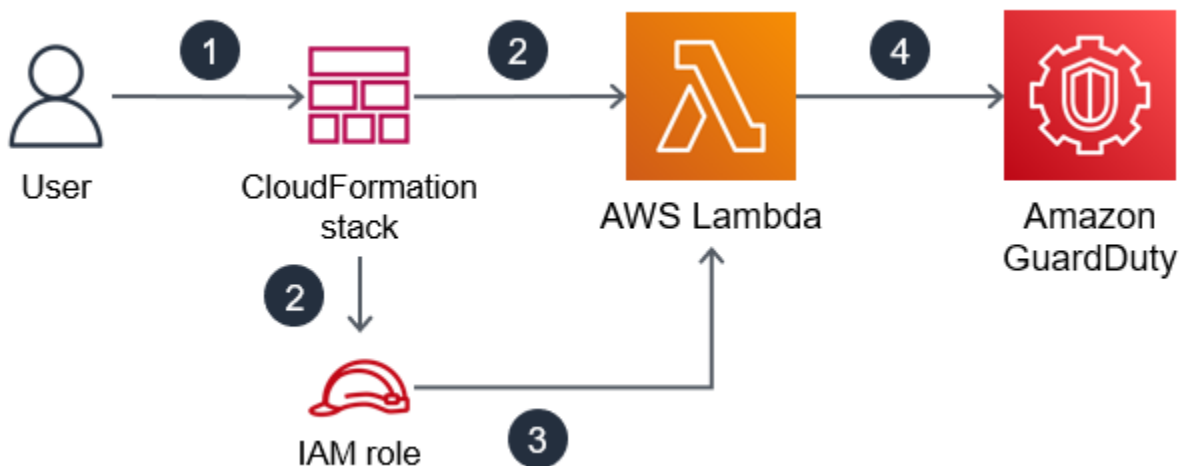

### Automation and scale

You can use the AWS CloudFormation StackSet feature to extend this solution to multiple AWS accounts and AWS Regions. For more information, see [Working with AWS CloudFormation StackSets](#) in the CloudFormation user guide.

## Tools

- [AWS Command Line Interface \(AWS CLI\)](#) is an open-source tool that helps you interact with AWS services through commands in your command-line shell.
- [AWS CloudFormation](#) helps you set up AWS resources, provision them quickly and consistently, and manage them throughout their lifecycle across AWS accounts and Regions.
- [Amazon GuardDuty](#) is a continuous security monitoring service that analyzes and processes logs to identify unexpected and potentially unauthorized activity in your AWS environment.
- [AWS Identity and Access Management \(IAM\)](#) helps you securely manage access to your AWS resources by controlling who is authenticated and authorized to use them.
- [AWS Lambda](#) is a compute service that helps you run code without needing to provision or manage servers. It runs your code only when needed and scales automatically, so you pay only for the compute time that you use.

## Epics

### Create the CloudFormation template and deploy the stack

Task	Description	Skills required
Create the CloudFormation template.	<ol style="list-style-type: none"> <li>1. Copy the code in <i>CloudFormation template</i> in the <a href="#">Additional information</a> section.</li> <li>2. Paste the code in a text editor.</li> <li>3. Save the file as <code>sample.yaml</code> on your workstation.</li> </ol>	AWS DevOps
Create the CloudFormation stack.	<ol style="list-style-type: none"> <li>1. In AWS CLI, enter the following command. This creates a new CloudForm</li> </ol>	AWS DevOps

Task	Description	Skills required
	<p>ation stack using the <code>sample.yaml</code> file. For more information, see <a href="#">Creating a stack</a> in the CloudFormation user guide.</p> <pre>aws cloudformation   create-stack \     --stack-name     guardduty-cf-stack \     --template-body     file://sample.yaml</pre> <p>2. Confirm the following value appears in the AWS CLI, indicating that the stack has been successfully created. The amount of time required to create the stack can vary.</p> <pre>"StackStatus":   "CREATE_COMPLETE",</pre>	
<p>Validate that GuardDuty is enabled for the AWS account.</p>	<ol style="list-style-type: none"> <li>1. Sign in to the AWS Management Console and open the GuardDuty console at <a href="https://console.aws.amazon.com/guardduty/">https://console.aws.amazon.com/guardduty/</a>.</li> <li>2. Verify that the GuardDuty service is enabled.</li> </ol>	<p>Cloud administrator, AWS administrator</p>

Task	Description	Skills required
Configure additional accounts or AWS Regions.	As needed for your use case, use the AWS CloudFormation StackSet feature to extend this solution to multiple AWS accounts and AWS Regions. For more information, see <a href="#">Working with AWS CloudFormation StackSets</a> in the CloudFormation user guide.	Cloud administrator, AWS administrator

## Related resources

### References

- [AWS CloudFormation documentation](#)
- [AWS Lambda resource type reference](#)
- [CloudFormation resource type: AWS::IAM::Role](#)
- [CloudFormation resource type: AWS::GuardDuty::Detector](#)
- [Four ways to retrieve any AWS service property using AWS CloudFormation](#) (blog)

### Tutorials and videos

- [Simplify Your Infrastructure Management Using AWS CloudFormation](#) (Tutorial)
- [Use Amazon GuardDuty and AWS Security Hub to secure multiple accounts](#) (AWS re:Invent 2020)
- [Best practices for authoring AWS CloudFormation](#) (AWS re:Invent 2019)
- [Threat Detection on AWS: An Introduction to Amazon GuardDuty](#) (AWS re:Inforce 2019)

## Additional information

### CloudFormation template

```
AWSTemplateFormatVersion: 2010-09-09
```

```
Resources:
  rLambdaLogGroup:
    Type: 'AWS::Logs::LogGroup'
    DeletionPolicy: Delete
    Properties:
      RetentionInDays: 7
      LogGroupName: /aws/lambda/resource-checker
  rLambdaCheckerLambdaRole:
    Type: 'AWS::IAM::Role'
    Properties:
      RoleName: !Sub 'resource-checker-lambda-role-${AWS::Region}'
      AssumeRolePolicyDocument:
        Version: 2012-10-17
        Statement:
          - Effect: Allow
            Principal:
              Service: lambda.amazonaws.com
            Action: 'sts:AssumeRole'
      Path: /
    Policies:
      - PolicyName: !Sub 'resource-checker-lambda-policy-${AWS::Region}'
        PolicyDocument:
          Version: 2012-10-17
          Statement:
            - Sid: CreateLogGroup
              Effect: Allow
              Action:
                - 'logs:CreateLogGroup'
                - 'logs:CreateLogStream'
                - 'logs:PutLogEvents'
                - 'iam:CreateServiceLinkedRole'
                - 'cloudformation:CreateStack'
                - 'cloudformation>DeleteStack'
                - 'cloudformation:Desc*'
                - 'guardduty:CreateDetector'
                - 'guardduty:ListDetectors'
                - 'guardduty>DeleteDetector'
              Resource: '*'
  resourceCheckerLambda:
    Type: 'AWS::Lambda::Function'
    Properties:
      Description: Checks for resource type enabled and possibly name to exist
      FunctionName: resource-checker
      Handler: index.lambda_handler
```

```
Role: !GetAtt
  - rLambdaCheckerLambdaRole
  - Arn
Runtime: python3.8
MemorySize: 128
Timeout: 180
Code:
  ZipFile: |
    import boto3
    import os
    import json
    from botocore.exceptions import ClientError
    import cfnresponse

    guardduty=boto3.client('guardduty')
    cfn=boto3.client('cloudformation')

    def lambda_handler(event, context):
        print('Event: ', event)
        if 'RequestType' in event:
            if event['RequestType'] in ["Create","Update"]:
                enabled=False
                try:
                    response=guardduty.list_detectors()
                    if "DetectorIds" in response and len(response["DetectorIds"])>0:
                        enabled="AlreadyEnabled"
                    elif "DetectorIds" in response and
len(response["DetectorIds"])==0:
                        cfn_response=cfn.create_stack(
                            StackName='guardduty-cfn-stack',
                            TemplateBody='{ "AWSTemplateFormatVersion": "2010-09-09",
"Description": "A sample template",    "Resources": { "IRWorkshopGuardDutyDetector": {
"Type": "AWS::GuardDuty::Detector",    "Properties": {    "Enable": true  }  } } }'
                            )
                        enabled="True"
                except Exception as e:
                    print("Exception: ",e)
                    responseData = {}
                    responseData['status'] = enabled
                    cfnresponse.send(event, context, cfnresponse.SUCCESS, responseData,
"CustomResourcePhysicalID" )
            elif event['RequestType'] == "Delete":
```



```
                cfn_response=cfn.delete_stack(
                    StackName='guardduty-cfn-stack')
                cfnresponse.send(event, context, cfnresponse.SUCCESS, {})
CheckResourceExist:
  Type: 'Custom::LambdaCustomResource'
  Properties:
    ServiceToken: !GetAtt
      - resourceCheckerLambda
      - Arn
Outputs:
  status:
    Value: !GetAtt
      - CheckResourceExist
      - status
```

### Alternative code option for the Lambda resource

The provided CloudFormation template uses inline code to reference the Lambda resource, for easier reference and guidance. Alternatively, you can place the Lambda code in an Amazon Simple Storage Service (Amazon S3) bucket and reference it in the CloudFormation template. Inline code doesn't support package dependencies or libraries. You can support these by placing the Lambda code in an S3 bucket and referencing it in the CloudFormation template.

Replace the following lines of code:

```
Code:
    ZipFile: |
```

with the following lines of code:

```
Code:
    S3Bucket: <bucket name>
    S3Key: <python file name>
    S3ObjectVersion: <version>
```

The `S3ObjectVersion` property can be omitted if you are not using versioning in your S3 bucket. For more information, see [Using versioning in S3 buckets](#) in the Amazon S3 user guide.

# Enable transparent data encryption in Amazon RDS for SQL Server

Created by Ranga Cherukuri (AWS)

**Environment:** PoC or pilot

**Technologies:** Security, identity, compliance; Databases

**Workload:** Microsoft

**AWS services:** Amazon RDS

## Summary

This pattern describes how to implement transparent data encryption (TDE) in Amazon Relational Database Service (Amazon RDS) for SQL Server to encrypt data at rest.

## Prerequisites and limitations

### Prerequisites

- An active AWS account
- An Amazon RDS for SQL Server DB instance

### Product versions

Amazon RDS currently supports TDE for the following SQL Server versions and editions:

- SQL Server 2012 Enterprise Edition
- SQL Server 2014 Enterprise Edition
- SQL Server 2016 Enterprise Edition
- SQL Server 2017 Enterprise Edition
- SQL Server 2019 Standard and Enterprise Editions

For the latest information about supported versions and editions, see [Support for Transparent Data Encryption in SQL Server](#) in the Amazon RDS documentation.

# Architecture

## Technology stack

- Amazon RDS for SQL Server

## Architecture

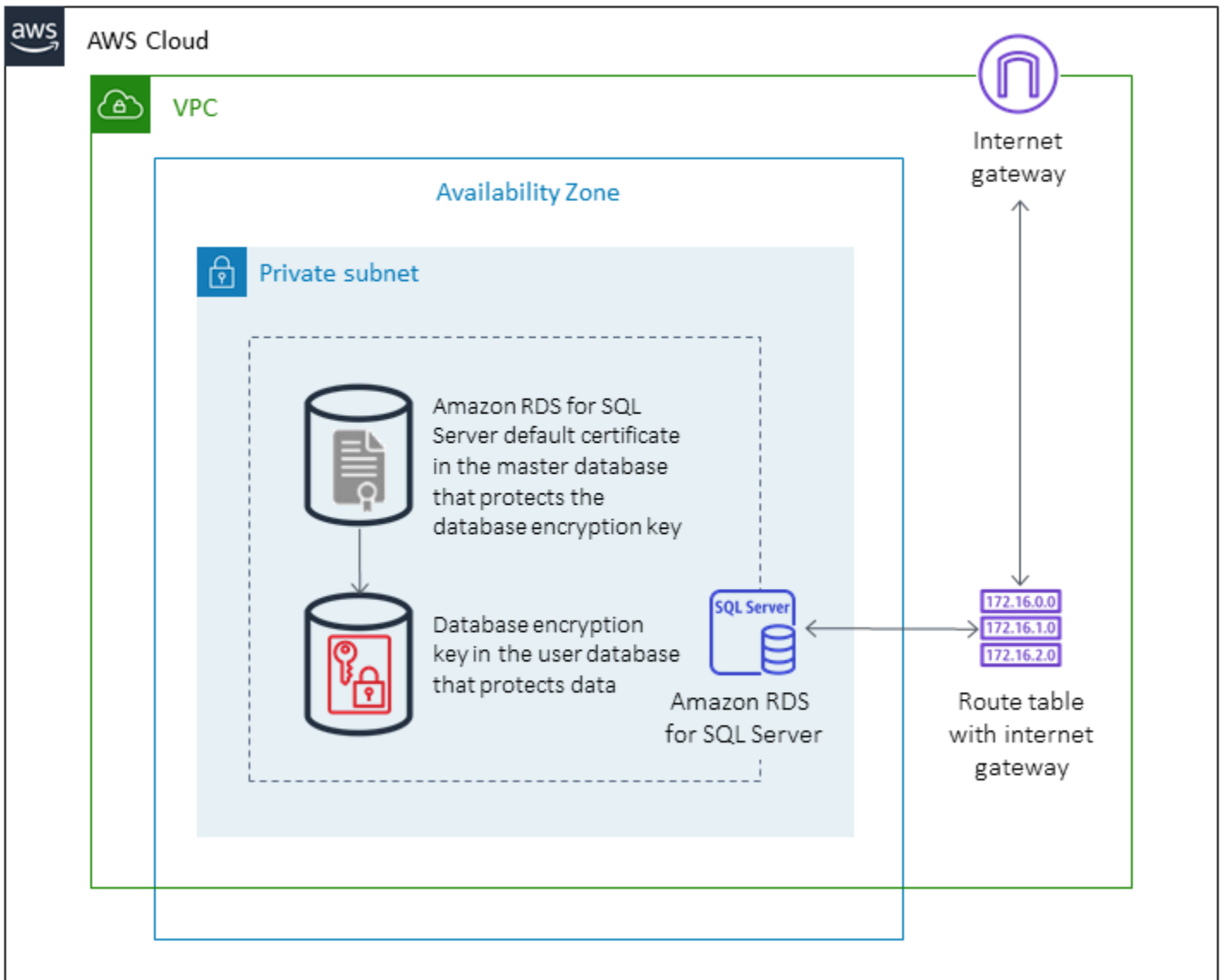

## Tools

## Tools

- Microsoft SQL Server Management Studio (SSMS) is an integrated environment for managing a SQL Server infrastructure. It provides a user interface and a group of tools with rich script editors that interact with SQL Server.

## Epics

### Create an option group in the Amazon RDS console

Task	Description	Skills required
Open the Amazon RDS console.	Sign in to the AWS Management Console and open the <a href="#">Amazon RDS console</a> .	Developer, DBA
Create an option group.	In the navigation pane, choose <b>Option groups</b> , <b>Create group</b> . Choose <b>sqlserver-ee</b> as the DB engine, and then select the engine version.	Developer, DBA
Add the TRANSPARENT_DATA_ENCRYPTION option.	Edit the option group you created and add the option called TRANSPARENT_DATA_ENCRYPTION .	Developer, DBA

### Associate the option group with the DB instance

Task	Description	Skills required
Choose the DB instance.	In the Amazon RDS console, in the navigation pane, choose <b>Databases</b> , and then choose the DB instance you	Developer, DBA

Task	Description	Skills required
	want to associate with the option group.	
Associate the DB instance with the option group.	Choose <b>Modify</b> , and then use the <b>Option group</b> setting to associate the SQL Server DB instance with the option group you created earlier.	Developer, DBA
Apply the changes.	Apply the changes immediately or during the next maintenance window, as desired.	Developer, DBA
Get the certificate name.	Get the default certificate name by using the following query. <div style="border: 1px solid #ccc; border-radius: 10px; padding: 10px; margin-top: 10px;"> <pre>USE [master] GO SELECT name FROM   sys.certificates WHERE   name LIKE 'RDSTDECertificate%' GO</pre> </div>	Developer, DBA

## Create the database encryption key

Task	Description	Skills required
Connect to the Amazon RDS for SQL Server DB instance using SSMS.	For instructions, see <a href="#">Using SSMS</a> in the Microsoft documentation.	Developer, DBA

Task	Description	Skills required
<p>Create the database encryption key by using the default certificate.</p>	<p>Create a database encryption key by using the default certificate name you got earlier. Use the following T-SQL query to create a database encryption key. You can specify the AES_256 algorithm instead of AES_128.</p> <pre data-bbox="597 680 1026 1079">USE [Databasename] GO CREATE DATABASE   ENCRYPTION KEY   WITH ALGORITHM = AES_128   ENCRYPTION BY SERVER   CERTIFICATE [certific   atename] GO</pre>	<p>Developer, DBA</p>
<p>Enable the encryption on the database.</p>	<p>Use the following T-SQL query to enable database encryption.</p> <pre data-bbox="597 1283 1026 1486">ALTER DATABASE [Database   Name] SET ENCRYPTION ON GO</pre>	<p>Developer, DBA</p>

Task	Description	Skills required
Check the status of encryption.	Use the following T-SQL query to check the status of encryption. <pre>SELECT DB_NAME(database_id) AS DatabaseName, encryption_state, percent_complete FROM sys.dm_database_encryption_keys</pre>	Developer, DBA

## Related resources

- [Support for Transparent Data Encryption in SQL Server](#) (Amazon RDS documentation)
- [Working with Option Groups](#) (Amazon RDS documentation)
- [Modifying an Amazon RDS DB Instance](#) (Amazon RDS documentation)
- [Transparent Data Encryption for SQL Server](#) (Microsoft documentation)
- [Using SSMS](#) (Microsoft documentation)

# Ensure AWS load balancers use secure listener protocols (HTTPS, SSL/TLS)

Created by Chandini Penmetsa (AWS) and Purushotham G K (AWS)

**Environment:** Production

**Technologies:** Security, identity, compliance

**Workload:** All other workloads

**AWS services:** Amazon SNS; AWS CloudFormation; Amazon CloudWatch; AWS Lambda; Elastic Load Balancing (ELB)

## Summary

On the Amazon Web Services (AWS) Cloud, Elastic Load Balancing automatically distributes incoming application traffic across multiple targets, such as Amazon Elastic Compute Cloud (Amazon EC2) instances, containers, IP addresses, and AWS Lambda functions. The load balancers use listeners to define the ports and protocols that the load balancer uses to accept traffic from users. Application Load Balancers make routing decisions at the application layer and use the HTTP/HTTPS protocols. Network Load Balancers make routing decisions at the transport layer and use the Transmission Control Protocol (TCP), Transport Layer Security (TLS), User Datagram Protocol (UDP), or TCP\_UDP protocols. Classic Load Balancers make routing decisions at either the transport layer, using TCP or Secure Sockets Layer (SSL) protocols, or at the application layer, using HTTP/HTTPS.

Your organization might have a security or compliance requirement that load balancers accept traffic from users only on secure protocols, such as HTTPS or SSL/TLS.

This pattern provides a security control that uses an Amazon EventBridge rule to monitor the `CreateListener` and `ModifyListener` API calls for Application Load Balancers and Network Load Balancers, and the `CreateLoadBalancerListeners` and `CreateLoadBalancer` API calls for Classic Load Balancers. If HTTP, TCP/UDP, or TCP\_UDP is used for the load balancer's listener protocol, the control invokes a Lambda function. The Lambda function publishes a



message to an Amazon Simple Notification Service (Amazon SNS) topic to send a notification that contains the load balancer details.

## Prerequisites and limitations

### Prerequisites

- An active AWS account
- An email address where you want to receive the violation notification
- An Amazon Simple Storage Service (Amazon S3) bucket to store the Lambda code .zip file

### Limitations

- This security control does not check for existing load balancers unless an update is made to the load balancer listeners.
- This security control is regional and must be deployed in the AWS Regions that you intend to monitor.

## Architecture

### Target technology stack

- Lambda function
- Amazon SNS topic
- EventBridge rule

### Target architecture

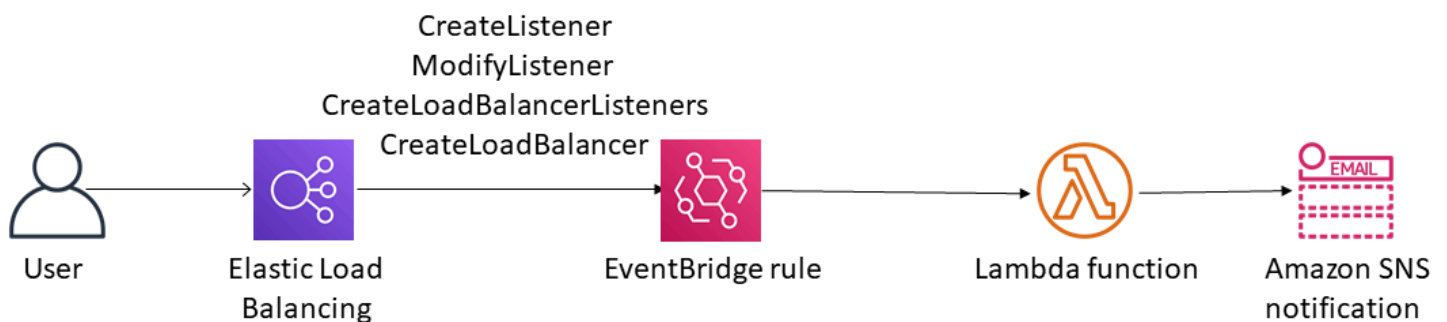

## Automation and scale

- If you are using AWS Organizations, you can use [AWS Cloudformation StackSets](#) to deploy this template in multiple accounts that you want this to monitor.

## Tools

- [AWS CloudFormation](#) – AWS CloudFormation is a service that helps you model and set up AWS resources by using infrastructure as code.
- [Amazon EventBridge](#) – Amazon EventBridge delivers a stream of real-time data from your own applications, software as a service (SaaS) applications, and AWS services, routing that data to targets such as Lambda functions.
- [AWS Lambda](#) – Lambda supports running code without provisioning or managing servers.
- [Amazon S3](#) – Amazon Simple Storage Service (Amazon S3) is a highly scalable object storage service that can be used for a wide range of storage solutions, including websites, mobile applications, backups, and data lakes.
- [Amazon SNS](#) – Amazon Simple Notification Service (Amazon SNS) coordinates and manages the delivery or sending of messages between publishers and clients, including web servers and email addresses. Subscribers receive all messages published to the topics to which they subscribe, and all subscribers to a topic receive the same messages.

## Best practices

Ensure that the SNS topic used isn't publicly accessible. For more information, see the [AWS documentation](#).

## Epics

### Upload the Lambda code

Task	Description	Skills required
Define the S3 bucket.	On the Amazon S3 console, choose or create an S3 bucket with a unique name that does not contain leading slashes.	Cloud Architect

Task	Description	Skills required
	An S3 bucket name is globally unique, and the namespace is shared by all AWS accounts. Your S3 bucket needs to be in the same Region as the load balancer that is being evaluated.	
Upload the Lambda code to the S3 bucket.	Upload the Lambda code .zip file that's provided in the "Attachments" section to the defined S3 bucket.	Cloud Architect
Deploy the AWS CloudFormation template.	On the AWS CloudFormation console, in the same AWS Region as the S3 bucket, deploy the template that is provided in the "Attachments" section. In the next epic, provide the values for the parameters.	Cloud Architect

### CloudFormation parameters

Task	Description	Skills required
Name the S3 bucket.	Enter the name of the S3 bucket that you created in the first epic.	Cloud Architect
Provide the Amazon S3 prefix.	Provide the location of the Lambda code .zip file in your S3 bucket, without leading slashes (for example,	Cloud Architect

Task	Description	Skills required
	<directory>/<file-name>.zip ).	
Provide the SNS topic ARN.	Provide the SNS topic Amazon Resource Name (ARN) if you want to use an existing SNS topic for violation notifications. To create a new SNS topic, keep the value as None (the default value).	Cloud Architect
Provide an email address.	Provide an active email address to receive Amazon SNS notifications.	Cloud Architect
Define the logging level.	Define the logging level and frequency for your Lambda function. Info designates detailed informational messages on the application's progress. Error designates error events that could still allow the application to continue running. Warning designates potentially harmful situations.	Cloud Architect

## Deploy the CloudFormation template

Task	Description	Skills required
Download the template.	Download the CloudFormation template that's	Cloud architect

Task	Description	Skills required
	provided in the <i>Attachments</i> section.	
Create the stack.	In the same Region as the S3 bucket, navigate to the CloudFormation service console, and deploy the downloaded template. Refer to the previous epic for parameter details.	Cloud architect
Verify the resources.	After the stack is created completely, navigate to the <b>Resources</b> tab, and verify the resources. The template will create the following resources : <ul style="list-style-type: none"> <li>• EventBridge rule</li> <li>• Lambda function</li> <li>• Lambda execution role</li> <li>• Lambda invoke permission</li> </ul>	Cloud architect

## Confirm the subscription

Task	Description	Skills required
Confirm the subscription.	When the template successfully deploys, if a new SNS topic was created, a subscription email message is sent to the email address provided in the parameters. You must confirm	Cloud architect

Task	Description	Skills required
	this email subscription to receive violation notifications.	

## Troubleshooting

Issue	Solution
Stack creation failed. Error occurred while GetObject. S3 Error Code: PermanentRedirect. S3 Error Message: The bucket is in this region: xx-xxxx-1. Please use this region to retry the request.	Make sure that the S3 bucket Region and the Region where the stack is being deployed are the same.
Stack creation failed. The runtime parameter of python3.6 is no longer supported for creating or updating AWS Lambda functions.	Update the downloaded template at line 186 from Python version 3.6 to 3.9.

## Related resources

- [Creating a stack on the AWS CloudFormation console](#)
- [AWS Lambda](#)
- [What is a Classic Load Balancer?](#)
- [What is an Application Load Balancer?](#)
- [What is a Network Load Balancer?](#)
- [Best practices for working with AWS Lambda functions](#)
- [AWS CloudFormation best practices](#)

## Attachments

To access additional content that is associated with this document, unzip the following file: [attachment.zip](#)

# Ensure encryption for Amazon EMR data at rest is enabled at launch

Created by Priyanka Chaudhary (AWS)

**Environment:** Production

**Technologies:** Security, identity, compliance; Analytics

**Workload:** Open-source

**AWS services:** Amazon EMR; Amazon SNS; AWS KMS; AWS CloudFormation; AWS Lambda; Amazon S3

## Summary

This pattern provides a security control for monitoring the encryption of Amazon EMR clusters on Amazon Web Services (AWS).

Data encryption helps prevent unauthorized users from reading data on a cluster and associated data storage systems. This includes data that may be intercepted as it travels the network, known as data in transit, and data that is saved to persistent media, known as data at-rest. Data at rest in Amazon Simple Storage Service (Amazon S3) can be encrypted in two ways.

- Server-side encryption with Amazon S3–managed keys (SSE-S3)
- Server-side encryption with AWS Key Management Service (AWS KMS) keys (SSE-KMS), set up with policies that are suitable for Amazon EMR.

This security control monitors for API calls and initiates an Amazon CloudWatch Events event on [RunJobFlow](#). The trigger invokes AWS Lambda, which runs a Python script. The function retrieves the EMR cluster ID from the event JSON input and determines whether there is a security violation by performing the following checks.

1. Check if an EMR cluster is associated with an Amazon EMR specific security configuration.

2. If an Amazon EMR specific security configuration is associated with the EMR cluster, check if Encryption-at-Rest is turned on.
3. If Encryption-at-Rest is not turned on, send an Amazon Simple Notification Service (Amazon SNS) notification that includes the EMR cluster name, violation details, AWS Region, AWS account, and the Lambda Amazon Resource Name (ARN) that this notification is sourced from.

## Prerequisites and limitations

### Prerequisites

- An active AWS account
- An S3 bucket for the Lambda code .zip file
- An email address where you want to receive the violation notification
- Amazon EMR logging turned off so that all the API logs can be retrieved

### Limitations

- This detective control is regional and must be deployed in the AWS Regions you intend to monitor.

### Product versions

- Amazon EMR release 4.8.0 and above

## Architecture

### *Target technology stack*

- Amazon EMR
- Amazon CloudWatch Events event
- Lambda function
- Amazon SNS

### *Target architecture*





## Automation and scale

If you are using AWS Organizations, you can use [AWS Cloudformation StackSets](#) to deploy this template in multiple accounts that you want to monitor.

## Tools

### Tools

- [AWS CloudFormation](#) is a service that helps you model and set up AWS resources using infrastructure as code.
- [Amazon CloudWatch Events](#) delivers a near real-time stream of system events that describe changes in AWS resources.
- [Amazon EMR](#) is a managed cluster platform that simplifies running big data frameworks.
- [AWS Lambda](#) supports running code without provisioning or managing servers.
- [Amazon S3](#) is a highly scalable object storage service that can be used for a wide range of storage solutions, including websites, mobile applications, backups, and data lakes.
- [Amazon SNS](#) coordinates and manages the delivery or sending of messages between publishers and clients, including web servers and email addresses. Subscribers receive all messages published to the topics to which they subscribe, and all subscribers to a topic receive the same messages.

### Code

- The EMREncryptionAtRest.zip and EMREncryptionAtRest.yml files for this project available as an attachment.

## Epics

### Define the S3 bucket

Task	Description	Skills required
Define the S3 bucket.	On the Amazon S3 console, choose or create an S3 bucket with a unique name that does not contain leading slashes. An S3 bucket name is globally unique, and the namespace is shared by all AWS accounts. Your S3 bucket needs to be in the same Region as the Amazon EMR cluster that is being evaluated.	Cloud Architect

### Upload the Lambda code to the S3 bucket

Task	Description	Skills required
Upload the Lambda code to the S3 bucket.	Upload the Lambda code .zip file that's provided in the "Attachments" section to the defined S3 bucket.	Cloud Architect

### Deploy the AWS CloudFormation template

Task	Description	Skills required
Deploy the AWS CloudFormation template.	On the AWS CloudFormation console, in the same Region as your S3 bucket, deploy the AWS CloudFormation	Cloud Architect

Task	Description	Skills required
	<p>template that's provided as an attachment to this pattern. In the next epic, provide the values for the parameters. For more information about deploying AWS CloudFormation templates, see the "Related resources" section.</p>	

### Complete the parameters in the AWS CloudFormation template

Task	Description	Skills required
Name the S3 bucket.	Enter the name of the S3 bucket that you created in the first epic.	Cloud Architect
Provide the Amazon S3 key.	Provide the location of the Lambda code .zip file in your S3 bucket, without leading slashes (for example, <directory>/<file-name>.zip).	Cloud Architect
Provide an email address.	Provide an active email address to receive Amazon SNS notifications.	Cloud Architect
Define the logging level.	Define the logging level and frequency for your Lambda function. "Info" designates detailed informational messages on the application's progress. "Error" designates error events that could still allow the application to	Cloud Architect

Task	Description	Skills required
	continue running. "Warning" designates potentially harmful situations.	

## Confirm the subscription

Task	Description	Skills required
Confirm the subscription.	When the template successfully deploys, it sends a subscription email message to the email address provided. You must confirm this email subscription to receive violation notifications.	Cloud Architect

## Related resources

- [Creating a stack on the AWS CloudFormation console](#)
- [AWS Lambda](#)
- [Amazon EMR encryption options](#)

## Attachments

To access additional content that is associated with this document, unzip the following file: [attachment.zip](#)

# Ensure that an IAM profile is associated with an EC2 instance

Created by Mansi Suratwala (AWS)

**Environment:** Production

**Technologies:** Infrastructure;  
Security, identity, compliance

**AWS services:** Amazon EC2;  
AWS Identity and Access  
Management; Amazon  
CloudWatch; AWS Lambda;  
Amazon SNS

## Summary

This pattern provides an AWS CloudFormation security control template that sets up automatic notification when an AWS Identity and Access Management (IAM) profile violation occurs for an Amazon Elastic Compute Cloud (Amazon EC2) instance.

An instance profile is a container for an IAM role that you can use to pass role information to an EC2 instance when the instance starts.

Amazon CloudWatch Events initiates this check when AWS CloudTrail logs Amazon EC2 API calls based on the `RunInstances`, `AssociateIamInstanceProfile`, and `ReplaceIamInstanceProfileAssociation` actions. The trigger calls an AWS Lambda function, which uses an Amazon CloudWatch Events event to check for an IAM profile.

If an IAM profile does not exist, the Lambda function initiates an Amazon Simple Notification Service (Amazon SNS) email notification that includes the Amazon Web Services (AWS) account ID and the AWS Region.

If an IAM profile does exist, the Lambda function checks for any wildcard entries in the policy documents. If the wildcards entries exist, initiates an Amazon SNS violation notification, which helps you to implement enhanced security. The notification contains the name of the IAM profile, the event, the EC2 instance ID, the name of the managed policy, the violation, the account ID, and the Region.

## Prerequisites and limitations

### Prerequisites

- An active account
- An Amazon Simple Storage Service (Amazon S3) bucket for the Lambda code .zip file

## Limitations

- The AWS CloudFormation template must be deployed for the RunInstances, AssociateIamInstanceProfile, and ReplaceIamInstanceProfileAssociation actions only.
- The security control does not monitor the detachment of IAM profiles.
- The security control does not check for modification of IAM policies that are attached to the EC2 instance IAM profile.
- The security control does not account for [unsupported resource-level permissions](#) that require the use of "Resource":\*.

## Architecture

### Target technology stack

- Amazon EC2
- AWS CloudTrail
- Amazon CloudWatch
- AWS Lambda
- Amazon S3
- Amazon SNS

### Target architecture



## Automation and scale

You can use the AWS CloudFormation template multiple times for different AWS Regions and accounts. You need to launch the template only one time for each account or Region.

## Tools

### Tools

- [Amazon EC2](#) – Amazon EC2 provides scalable computing capacity (virtual servers) in the AWS Cloud.
- [AWS CloudTrail](#) – AWS CloudTrail helps you enable governance, compliance, and operational and risk auditing of your AWS account. Actions taken by a user, a role, or an AWS service are recorded as events in CloudTrail.
- [Amazon CloudWatch Events](#) – Amazon CloudWatch Events delivers a near real-time stream of system events that describe changes in AWS resources.
- [AWS Lambda](#) – AWS Lambda is a compute service that you can use to run code without provisioning or managing servers. Lambda runs your code only when needed and scales automatically, from a few requests per day to thousands per second.
- [Amazon S3](#) – Amazon S3 provides highly scalable object storage that you can use for a wide range of storage solutions, including websites, mobile applications, backups, and data lakes.
- [Amazon SNS](#) – Amazon SNS enables applications and devices to send and receive notifications from the cloud.

### Code

- A .zip file of the project is available as an attachment.

## Epics

### Define the S3 bucket

Task	Description	Skills required
Define the S3 bucket.	To host the Lambda code .zip file, choose or create an S3 bucket with a unique name that does not contain leading slashes. An S3 bucket name is globally unique, and the namespace is shared by all AWS accounts. Your S3 bucket needs to be in the same Region as the EC2 instance that is being evaluated.	Cloud Architect

### Upload the Lambda code to the S3 bucket

Task	Description	Skills required
Upload the Lambda code to the S3 bucket.	Upload the Lambda code that's provided in the <i>Attachments</i> section to the S3 bucket. The S3 bucket must be in the same Region as the EC2 instance being evaluated.	Cloud Architect

### Deploy the AWS CloudFormation template

Task	Description	Skills required
Deploy the AWS CloudFormation template.	Deploy the AWS CloudFormation template that's	Cloud Architect



Task	Description	Skills required
	provided as an attachment to this pattern. In the next epic, provide the values for the parameters.	

### Complete the parameters in the AWS CloudFormation template

Task	Description	Skills required
Name the S3 bucket.	Enter the name of the S3 bucket that you created in the first epic.	Cloud Architect
Provide the S3 key.	Provide the location of the Lambda code .zip file in your S3 bucket, without leading slashes (for example, <directory>/<file-name>.zip ).	Cloud Architect
Provide an email address.	Provide an active email address to receive Amazon SNS notifications.	Cloud Architect
Define the logging level.	Define the logging level and frequency for your Lambda function. Info designates detailed informational messages on the application's progress. Error designates error events that could still allow the application to continue running. Warning designates potentially harmful situations.	Cloud Architect

## Confirm the subscription

Task	Description	Skills required
Confirm the subscription.	When the template successfully deploys, it sends a subscription email message to the email address provided. You must confirm this email subscription to receive violation notifications.	Cloud Architect

## Related resources

- [Creating an S3 bucket](#)
- [Uploading files to an S3 bucket](#)
- [Using instance profiles](#)
- [Creating a CloudWatch Events rule that triggers on an AWS API call using AWS CloudTrail](#)

## Attachments

To access additional content that is associated with this document, unzip the following file: [attachment.zip](#)

# Ensure an Amazon Redshift cluster is encrypted upon creation

Created by Mansi Suratwala (AWS)

<b>Environment:</b> Production	<b>Technologies:</b> Analytics; Data lakes; Security, identity, compliance	<b>Workload:</b> All other workloads
<b>AWS services:</b> Amazon Redshift; Amazon SNS; AWS CloudTrail; Amazon CloudWatch; AWS Lambda; Amazon S3		

## Summary

This pattern provides an AWS CloudFormation template that provides you with automatic notification when a new Amazon Redshift cluster is created without encryption.

The AWS CloudFormation template creates an Amazon CloudWatch Events event and an AWS Lambda function. The event watches for any Amazon Redshift cluster being created or being restored from a snapshot through AWS CloudTrail. If the cluster is created without AWS Key Management Service (AWS KMS) or cloud hardware security model (HSM) encryption in the AWS account, CloudWatch initiates a Lambda function that sends you an Amazon Simple Notification Service (Amazon SNS) notification informing you of the violation.

## Prerequisites and limitations

### Prerequisites

- An active AWS account.
- A virtual private cloud (VPC) with a cluster subnet group, and an associated security group.

### Limitations

- The AWS CloudFormation template can be deployed for the `CreateCluster` and `RestoreFromClusterSnapshot` actions only.

# Architecture

## Target technology stack

- Amazon Redshift
- AWS CloudTrail
- Amazon CloudWatch
- AWS Lambda
- Amazon Simple Storage Service (Amazon S3)
- Amazon SNS

## Target architecture



## Automation and scale

You can use the AWS CloudFormation template multiple times for different AWS Regions and accounts. You need to run it only one time in each Region or account.

## Tools

### Tools

- [Amazon Redshift](#) – Amazon Redshift is a fully managed, petabyte-scale data warehouse service in the cloud. Amazon Redshift is integrated with your data lake, which enables you to use your data to acquire new insights for your business and customers.
- [AWS CloudTrail](#) – AWS CloudTrail is an AWS service that helps you implement governance, compliance, and operational and risk auditing of your AWS account. Actions taken by a user, role, or an AWS service are recorded as events in CloudTrail.

- [Amazon CloudWatch Events](#) – Amazon CloudWatch Events delivers a near real-time stream of system events that describe changes in AWS resources.
- [AWS Lambda](#) – AWS Lambda supports running code without provisioning or managing servers. AWS Lambda runs your code only when needed and scales automatically, from a few requests per day to thousands per second.
- [Amazon S3](#) – Amazon S3 is a highly scalable object storage service that you can use for a wide range of storage solutions, including websites, mobile applications, backups, and data lakes.
- [Amazon SNS](#) – Amazon SNS is a web service that coordinates and manages the delivery or sending of messages to between publishers and clients, including web servers and email addresses.

## Code

- A .zip file of the project is available as an attachment.

## Epics

### Define the S3 bucket

Task	Description	Skills required
Define the S3 bucket.	On the Amazon S3 console, choose or create an S3 bucket. This S3 bucket will host the Lambda code .zip file. Your S3 bucket needs to be in the same Region as the Amazon Redshift cluster being evaluated. The S3 bucket's name cannot contain leading slashes.	Cloud Architect

## Upload the Lambda code to the S3 bucket

Task	Description	Skills required
Upload the Lambda code to the S3 bucket.	Upload the Lambda code provided in the <i>Attachments</i> section to the S3 bucket. The S3 bucket must be in the same Region as the Amazon Redshift cluster being evaluated.	Cloud Architect

## Deploy the AWS CloudFormation template

Task	Description	Skills required
Deploy the AWS CloudFormation template.	Deploy the AWS CloudFormation template that's provided as an attachment to this pattern. In the next epic, provide the values for the parameters.	Cloud Architect

## Complete the parameters in the AWS CloudFormation template

Task	Description	Skills required
Name the S3 bucket.	Enter the name of the S3 bucket that you created in the first epic.	Cloud Architect
Provide the S3 key.	Provide the location of the Lambda code .zip file in your S3 bucket, without leading slashes (for example,	Cloud Architect

Task	Description	Skills required
	<code>&lt;directory&gt;/&lt;file-name&gt;.zip</code> ).	
Provide an email address.	Provide an active email address to receive Amazon SNS notifications.	Cloud Architect
Define the logging level.	Define the logging level and frequency for your Lambda function. <code>Info</code> designates detailed informational messages on the application's progress. <code>Error</code> designates error events that could still allow the application to continue running. <code>Warning</code> designates potentially harmful situations.	Cloud Architect

## Confirm the subscription

Task	Description	Skills required
Confirm the subscription.	When the template successfully deploys, it sends a subscription email to the email address provided. You must confirm this email subscription to receive violation notifications.	Cloud Architect

## Related resources

- [Creating an S3 bucket](#)

- [Uploading files to an S3 bucket](#)
- [Creating a CloudWatch Events rule that triggers on an AWS API call using AWS CloudTrail](#)
- [Creating an Amazon Redshift cluster](#)

## Attachments

To access additional content that is associated with this document, unzip the following file:  
[attachment.zip](#)



# Export a report of AWS IAM Identity Center identities and their assignments by using PowerShell

*Created by Jorge Pava (AWS), Chad Miles (AWS), Frank Allotta (AWS), and Manideep Reddy Gillela (AWS)*

**Environment:** Production

**Technologies:** Security, identity, compliance; Management & governance

**Workload:** Microsoft

**AWS services:** IAM Identity Center; AWS Tools for PowerShell

## Summary

When you use AWS IAM Identity Center (successor to AWS Single Sign-On) to centrally manage single sign-on (SSO) access to all of your Amazon Web Services (AWS) accounts and cloud applications, reporting and auditing those assignments through the AWS Management Console can be tedious and time consuming. This is especially true if you're reporting on permissions for a user or group across dozens or hundreds of AWS accounts.

For many, the ideal tool to view this information would be in a spreadsheet application, such as Microsoft Excel. This can help you filter, search, and visualize the data for your entire organization, managed by AWS Organizations.

This pattern describes how to use AWS Tools for PowerShell to generate a report of SSO identity configurations in IAM Identity Center. The report is formatted as a CSV file, and it includes the identity name (principal), identity type (user or group), accounts the identity can access, and permission sets. After generating this report, you can open it in your preferred application to search, filter, and audit the data as needed. The following image shows sample data in a spreadsheet application.

AccountName	PermissionSet	Principal	Type
Audit	SecurityAudit	AWSAuditAccountAdmins	GROUP
Log Archive	AWSPowerUserAccess	AWSSecurityAuditPowerUsers	GROUP
Dev-Test	AWSAdministratorAccess	dev-Users	GROUP
Prod	AWSReadOnlyAccess	Prod@example.com	USER

**Important:** Because this report contains sensitive information, we highly recommend you store it securely and share it only on a need-to-know basis.

## Prerequisites and limitations

### Prerequisites

- IAM Identity Center and AWS Organizations, configured and enabled.
- PowerShell, installed and configured. For more information, see [Installing PowerShell](#) (Microsoft documentation).
- AWS Tools for PowerShell, installed and configured. For performance reasons, we highly recommend that you install the modularized version of AWS Tools for PowerShell, called `AWS.Tools`. Each AWS service is supported by its own individual, small module. In the PowerShell shell, enter the following commands to install the modules needed for this pattern: `AWS.Tools.Installer`, `Organizations`, `SSOAdmin`, and `IdentityStore`.

```
Install-Module AWS.Tools.Installer
Install-AWSToolsModule -Name Organizations, SSOAdmin, IdentityStore
```

For more information, see [Install AWS.Tools on Windows](#) or [Install AWS.Tools on Linux or macOS](#) (AWS Tools for PowerShell documentation). If you receive an error when installing the modules, see the [Troubleshooting](#) section of this pattern.

- AWS Command Line Interface (AWS CLI) or the AWS SDK must be previously configured with working credentials by doing one of the following:
  - Use the AWS CLI `aws configure` For more information, see [Quick configuration](#) (AWS CLI documentation).
  - Configure AWS CLI or AWS Cloud Development Kit (AWS CDK) to get temporary access through an AWS Identity and Access Management (IAM) role. For more information, see [Getting IAM role credentials for CLI access](#) (IAM Identity Center documentation).

- A named profile for the AWS CLI that has saved credentials for an IAM principal that:
  - Has access to the AWS Organizations management account or the delegated administrator account for IAM Identity Center
  - Has the `AWSSS0ReadOnly` and `AWSSS0DirectoryReadOnly` AWS managed policies applied to it

For more information, see [Using named profiles](#) (AWS CLI documentation) and [AWS managed policies](#) (IAM documentation).

## Limitations

- The target AWS accounts must be managed as an organization in AWS Organizations.

## Product versions

- For all operating systems, it is recommended that you use [PowerShell version 7.0](#) or later.

## Architecture

### Target architecture

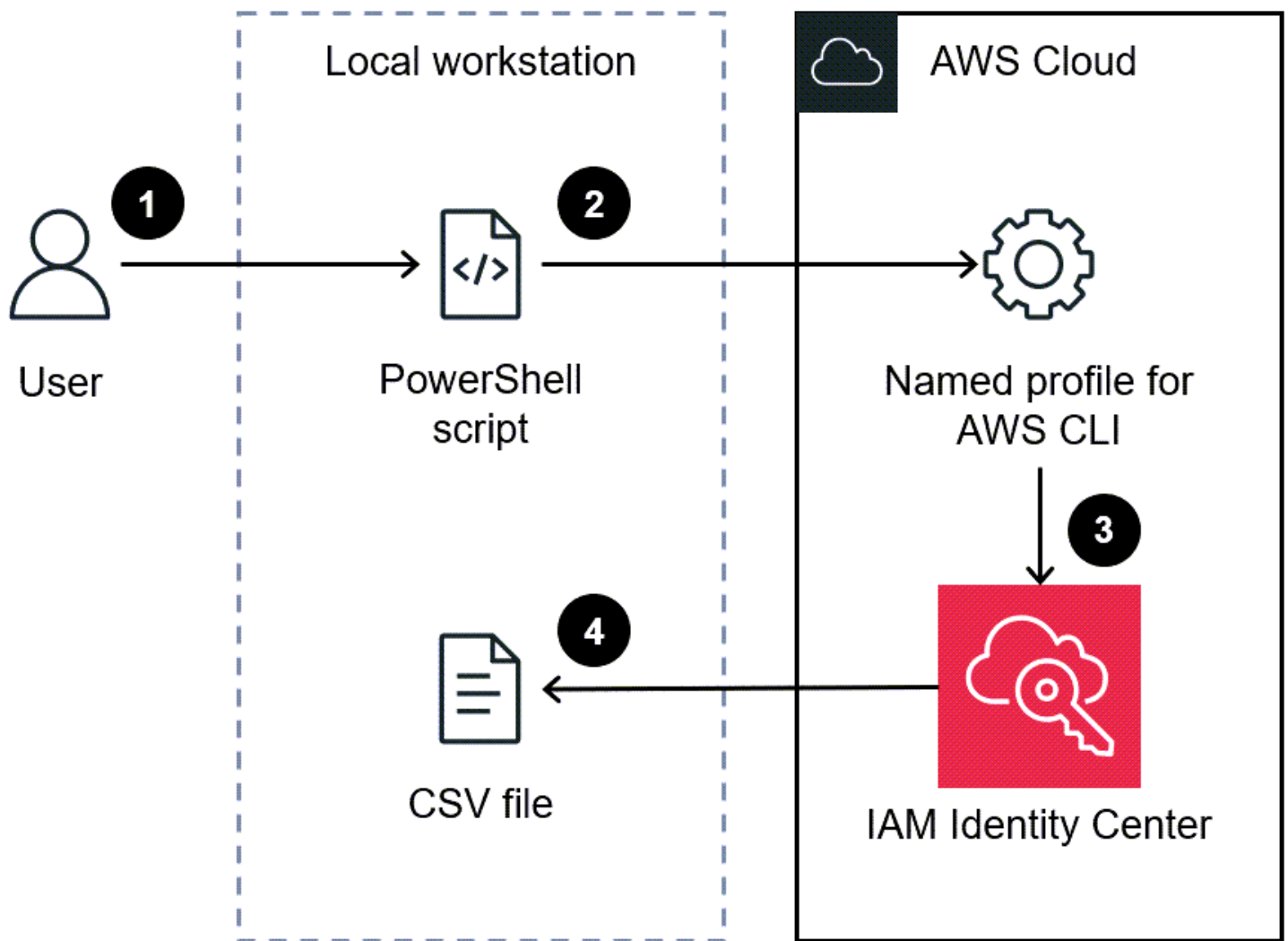

1. The user runs the script in a PowerShell command line.
2. The script assumes the named profile for AWS CLI. This grants access to IAM Identity Center.
3. The script retrieves the SSO identity configurations from IAM Identity Center.
4. The script generates a CSV file in the same directory on the local workstation where the script is saved.

## Tools

### AWS services

- [AWS Command Line Interface \(AWS CLI\)](#) is an open-source tool that helps you interact with AWS services through commands in your command-line shell.

- [AWS IAM Identity Center](#) helps you centrally manage single sign-on (SSO) access to all of your AWS accounts and cloud applications.
- [AWS Tools for PowerShell](#) are a set of PowerShell modules that help you script operations on your AWS resources from the PowerShell command line.

## Other tools

- [PowerShell](#) is a Microsoft automation and configuration management program that runs on Windows, Linux, and macOS.

## Epics

### Generate the report

Task	Description	Skills required
Prepare the script.	<ol style="list-style-type: none"><li>1. Copy the PowerShell script in the <a href="#">Additional information</a> section of this pattern.</li><li>2. In the Param section, for your AWS environment, define the values for the following variables:<ul style="list-style-type: none"><li>• <code>OutputFile</code> – The file name of the report.</li><li>• <code>ProfileName</code> – The AWS CLI named profile that you want to use to generate the report.</li><li>• <code>Region</code> – The AWS Region in which IAM Identity Center is deployed. For a complete list of Regions and their</li></ul></li></ol>	Cloud administrator

Task	Description	Skills required
	<p>codes, see <a href="#">Regional endpoints</a>.</p> <p>3. Save the script with the file name <code>SSO-Report.ps1</code>.</p>	
Run the script.	<p>It is recommended that you run your custom script in the PowerShell shell with the following command.</p> <pre data-bbox="597 659 1027 739">.\SSO-Report.ps1</pre> <p>Alternatively, you can run the script from another shell by entering the following command.</p> <pre data-bbox="597 995 1027 1075">pwsh .\SSO-Report.ps1</pre> <p>The script generates a CSV file in the same directory as the script file.</p>	Cloud administrator
Analyze report data.	<p>The output CSV file has the headers <b>AccountName</b>, <b>PermissionSet</b>, <b>Principal</b>, and <b>Type</b>. Open this file in your preferred spreadsheet application. You can create a data table to filter and sort the output.</p>	Cloud administrator

## Troubleshooting

Issue	Solution
<p>The term 'Get-&lt;parameter&gt;' is not recognized as the name of a cmdlet, function, script file, or operable program. error</p>	<p>AWS Tools for PowerShell or its modules are not installed. In the PowerShell shell, enter the following commands to install AWS Tools for PowerShell and the modules needed for this pattern: <code>AWS.Tools.Installer</code>, <code>Organizations</code>, <code>SSOAdmin</code>, and <code>IdentityStore</code>.</p> <pre>Install-Module AWS.Tools.Installer Install-AWSToolsModule -Name   Organizations, SSOAdmin, IdentityStore</pre>
<p>No credentials specified or obtained from persisted/shell defaults error</p>	<p>In <i>Prepare the script</i> in the <a href="#">Epics</a> section, confirm that you have correctly entered the <code>ProfileName</code> and <code>Region</code> variables. Make sure that the settings and credentials in the named profile have sufficient permissions to administer IAM Identity Center.</p>
<p>Authenticode Issuer ... error when installing the AWS.Tools modules</p>	<p>Add the <code>-SkipPublisherCheck</code> parameter to the end of the <code>Install-AWSToolsModule</code> command.</p>
<p>Get-ORGAccountList : Assembly AWSSDK.SSO could not be found or loaded. error</p>	<p>This error can occur when named AWS CLI profiles are specified, AWS CLI is configured to authenticate users with IAM Identity Center, and AWS CLI is configured to automatically retrieve refreshed authentication tokens. To resolve this error, do the following:</p> <ol style="list-style-type: none"><li>1. Enter the following command to confirm that the <code>SSO</code> and <code>SSO0IDC</code> modules are installed.</li></ol>

Issue	Solution
	<pre data-bbox="868 210 1507 289">Install-AWSToolsModule SS0, SS00IDC</pre> <p data-bbox="829 304 1442 388">2. Insert the following lines into the script below the param() block.</p> <pre data-bbox="868 426 1507 506">Import-Module AWS.Tools.SS0</pre> <pre data-bbox="868 537 1507 617">Import-Module AWS.Tools.SS00IDC</pre>

## Related resources

- [Where are configuration settings stored?](#) (AWS CLI documentation)
- [Configuring the AWS CLI to use AWS IAM Identity Center](#) (AWS CLI documentation)
- [Using named profiles](#) (AWS CLI documentation)

## Additional information

In the following script, determine whether you need to update the values for the following parameters:

- If you're using a named profile in AWS CLI to access the account in which IAM Identity Center is configured, update the `$ProfileName` value.
- If IAM Identity Center is deployed in a different AWS Region than the default Region for your AWS CLI or AWS SDK configuration, update the `$Region` value to use the Region where IAM Identity Center is deployed.
- If neither of these situations apply, then no script update is required.

```
param (  
    # The name of the output CSV file  
    [String] $OutputFile = "SS0-Assignments.csv",  
    # The AWS CLI named profile  
    [String] $ProfileName = "",
```



```

# The AWS Region in which IAM Identity Center is configured
[String] $Region      = ""
)
$Start = Get-Date; $OrgParams = @{}
If ($Region){ $OrgParams.Region = $Region}
if ($ProfileName){$OrgParams.ProfileName = $ProfileName}
$SSOParams      = $OrgParams.Clone(); $IdsParams = $OrgParams.Clone()
$AccountList    = Get-ORGAccountList @OrgParams | Select-Object Id, Name
$SSOInstance    = Get-SSOADMNIInstanceList @OrgParams
$SSOParams['InstanceArn']      = $SSOInstance.InstanceArn
$IdsParams['IdentityStoreId']  = $SSOInstance.IdentityStoreId
$PSsets         = @{}; $Principals = @{}
$Assignments    = @{}; $AccountCount = 1; Write-Host ""
foreach ($Account in $AccountList) {
    $Duration = New-Timespan -Start $Start -End (Get-Date) | ForEach-Object
    {[Timespan]::New($_.Days, $_.Hours, $_.Minutes, $_.Seconds)}
    Write-Host "`r$Duration - Account $AccountCount of $($AccountList.Count)
    (Assignments:$($Assignments.Count))          " -NoNewline
    $AccountCount++
    foreach ($PS in Get-SSOADMNPermissionSetsProvisionedToAccountList -AccountId
    $Account.Id @SSOParams) {
        if (-not $PSsets[$PS]) {$PSsets[$PS] = (Get-SSOADMNPermissionSet @SSOParams -
    PermissionSetArn $PS).Name;$APICalls++}
        $AssignmentsResponse = Get-SSOADMNAccountAssignmentList @SSOParams -
    PermissionSetArn $PS -AccountId $Account.Id
        if ($AssignmentsResponse.NextToken) {$AccountAssignments =
    $AssignmentsResponse.AccountAssignments}
        else {$AccountAssignments = $AssignmentsResponse}
        While ($AssignmentsResponse.NextToken) {
            $AssignmentsResponse = Get-SSOADMNAccountAssignmentList @SSOParams -
    PermissionSetArn $PS -AccountId $Account.Id -NextToken $AssignmentsResponse.NextToken
            $AccountAssignments += $AssignmentsResponse.AccountAssignments}
        foreach ($Assignment in $AccountAssignments) {
            if (-not $Principals[$Assignment.PrincipalId]) {
                $AssignmentType = $Assignment.PrincipalType.Value
                $Expression      = "Get-IDS"+$AssignmentType+" @IdsParams -"+
    $AssignmentType+"Id "+$Assignment.PrincipalId
                $Principal      = Invoke-Expression $Expression
                if ($Assignment.PrincipalType.Value -eq "GROUP")
            { $Principals[$Assignment.PrincipalId] = $Principal.DisplayName }
                else { $Principals[$Assignment.PrincipalId] = $Principal.UserName }
            }
            $Assignments += [PSCustomObject]@{
                AccountName      = $Account.Name

```

```
        PermissionSet = $PSsets[$PS]
        Principal      = $Principals[$Assignment.PrincipalId]
        Type           = $Assignment.PrincipalType.Value}
    }
}
$Duration = New-Timespan -Start $Start -End (Get-Date) | ForEach-Object
{[Timespan]::New($_.Days, $_.Hours, $_.Minutes, $_.Seconds)}
Write-Host "`r$($AccountList.Count) accounts done in $Duration. Outputting result to
$OutputFile"
$Assignments | Sort-Object Account | Export-CSV -Path $OutputFile -Force
```

# Monitor and remediate scheduled deletion of AWS KMS keys

Created by Mikesh Khanal (AWS) and Ramya Pulipaka (AWS)

**Environment:** Production

**Technologies:** Security, identity, compliance; Operations

**AWS services:** Amazon SNS; AWS CloudTrail; Amazon CloudWatch

## Summary

On the Amazon Web Services (AWS) Cloud, deleting an AWS Key Management Services (AWS KMS) key can result in data loss. Deletion removes the key material and all metadata associated with the AWS KMS key, and it is irreversible. After an AWS KMS key is deleted, you can no longer decrypt the data that were encrypted under that AWS KMS key, so that data cannot be recovered.

This pattern sets up monitoring, with notifications when an application or a user schedules an AWS KMS key for deletion. If you receive a notification, you might want to cancel deletion of the AWS KMS key and reconsider your decision to delete it. The pattern uses the AWS Systems Manager automation runbook [AWSConfigRemediation-CancelKeyDeletion](#) to facilitate canceling the deletion of an AWS KMS key.

**Note:** The pattern's CloudFormation template must be deployed in all AWS Regions where you want to monitor deletion of AWS KMS keys.

## Prerequisites and limitations

### Prerequisites

- An active AWS account
- Understanding of the following AWS services:
  - Amazon EventBridge
  - AWS KMS
  - Amazon Simple Notification Service (Amazon SNS)
  - AWS Systems Manager

### Limitations

- Any customization of the solution requires knowledge of AWS CloudFormation templates and the AWS services used in this pattern.
- Currently, this solution uses the default event bus, and it can be customized according to the requirements. For more information about the custom event bus, see the [AWS documentation](#).

## Architecture

### Target technology stack

- Amazon EventBridge
- AWS KMS
- Amazon SNS
- AWS Systems Manager
- Automation using the following:
  - AWS Command Line Interface (AWS CLI) or AWS SDK
  - AWS CloudFormation stack

### Target architecture

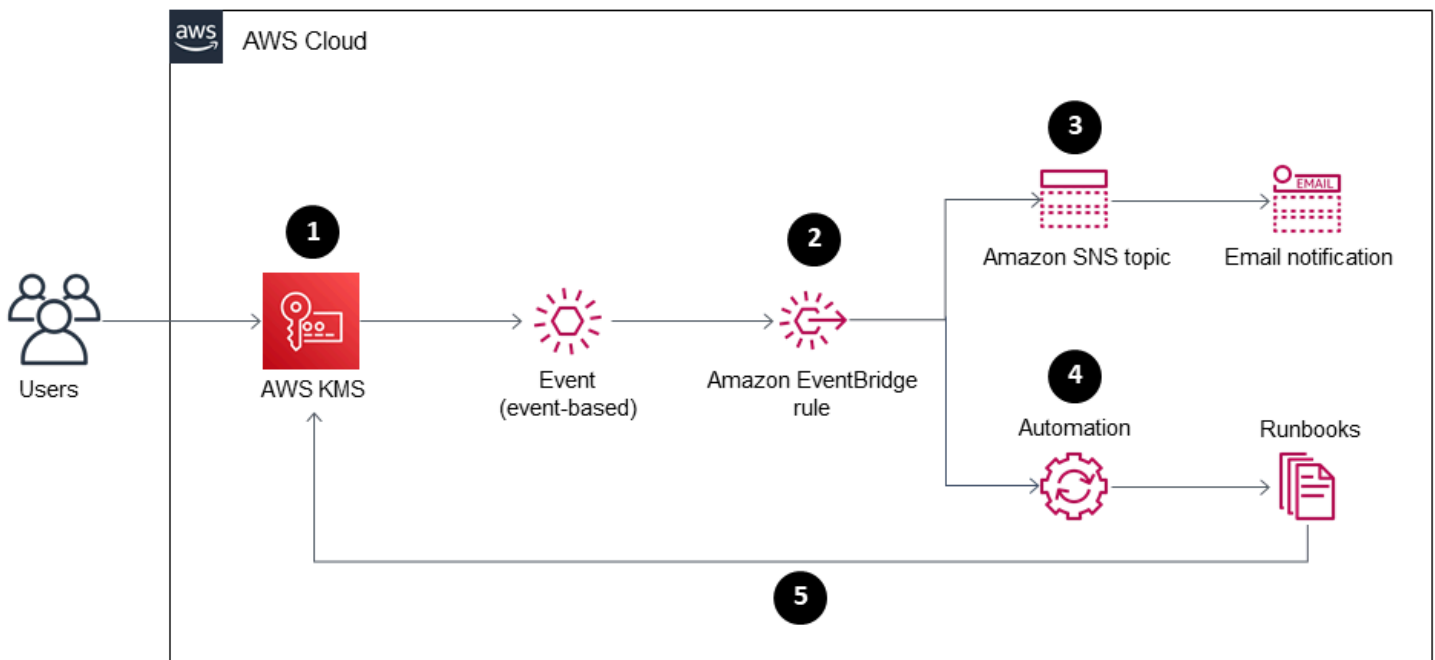

1. Deletion of an AWS KMS key is scheduled.

2. The scheduled-deletion event is evaluated by an EventBridge rule.
3. The EventBridge rule engages the Amazon SNS topic.
4. The EventBridge rule initiates the Systems Manager automation and runbooks.
5. The runbooks cancel the deletion.

## Automation and scale

The CloudFormation stack deploys all the necessary resources and services for this solution to work. The pattern can be run independently in a single account or run using AWS CloudFormation StackSets for multiple independent accounts or an organization.

```
aws cloudformation create-stack --stack-name <stack-name>\
  --template-body file://<Full-Path-of-file> \
  --parameters ParameterKey=,ParameterValue= \
  --capabilities CAPABILITY_NAMED_IAM
```

## Tools

### Tools

- [AWS CloudFormation](#) – AWS CloudFormation is a service that helps you model and set up your Amazon Web Services resources so that you can spend less time managing those resources and more time focusing on your applications that run on AWS. You can use a CloudFormation template to create stacks in an AWS account in an AWS Region. The template describes all the AWS resources that you want, and CloudFormation provisions and configures those resources for you.
- [AWS CLI](#) – The AWS Command Line Interface (AWS CLI) is an open source tool that you can use to interact with AWS services using commands in your command line shell.
- [Amazon EventBridge](#) – Amazon EventBridge is a serverless event bus service connecting your applications with data from a variety of sources. EventBridge delivers a stream of real-time data from your own applications and AWS services, and it routes that data to targets such as AWS Lambda. EventBridge simplifies the process of building event-driven architectures.
- [AWS KMS](#) – AWS Key Management Service (AWS KMS) is a managed service for creating and controlling AWS KMS keys, the encryption keys used to encrypt your data.
- [AWS SDKs](#) – AWS tools include SDKs so that you can develop and manage applications on AWS in the programming language of your choice.

- [Amazon SNS](#) – Amazon Simple Notification Service (Amazon SNS) is a managed service that provides message delivery from publishers to subscribers (also known as producers and consumers). Publishers communicate asynchronously with subscribers by sending messages to a topic, which is a logical access point and communication channel.
- [AWS Systems Manager](#) – AWS Systems Manager is an AWS service that you can use to view and control your infrastructure on AWS. Using the Systems Manager console, you can automate operational tasks across your AWS resources. Systems Manager helps you maintain security and compliance by scanning your managed instances and reporting on (or taking corrective action on) any policy violations it detects.

## Code

- The `alerting_ct_logs.yaml` CloudFormation template for the project is attached.

## Epics

### Prepare the AWS account

Task	Description	Skills required
Install and configure AWS CLI.	<p>Install AWS CLI version 2. Then configure the security credentials settings for an identity, the default output format, and the default AWS Region that AWS CLI uses to interact with AWS.</p> <p>The identity must have the required permissions to perform the tasks.</p>	Developer, Security engineer

## Deploy the AWS CloudFormation template

Task	Description	Skills required
Download the CloudFormation template.	Download the attachment to a local path on your computer and extract the <code>alerting_ct_logs.yaml</code> template file.	Developer, Security engineer
Deploy the template.	<p>In the terminal window where the AWS account profile has been configured, run the following command.</p> <pre data-bbox="597 821 1027 1734">aws cloudformation   create-stack --stack-name &lt;stack_name&gt; \   --capabilities &lt;Value&gt; \   --template-body file://&lt;Full_Path&gt; \   --parameters ParameterKey=DestinationEmailAddress,ParameterValue=&lt;Value&gt; \   ParameterKey=SNSTopicName,ParameterValue=&lt;Value&gt; \   ParameterKey=EnableRemediation,ParameterValue=&lt;Value&gt; \   ParameterKey=AutomationAssumeRole,ParameterValue=&lt;Value&gt;</pre> <p>In the next step, enter values for the template parameters.</p>	Developer, Security engineer

Task	Description	Skills required
Complete the template parameters.	<p>Enter the required values for the parameters.</p> <ul style="list-style-type: none"><li>• <code>DestinationEmailAddress</code> – The email address to receive an alert when an AWS KMS key is scheduled for deletion.</li><li>• <code>SNSTopicName</code> – The name of the Amazon SNS topic.</li><li>• <code>EnableRemediation</code> – Cancellation of the scheduled key deletion using a Systems Manager runbook. Allowed values are <code>true</code> and <code>false</code>.</li><li>• <code>AutomationAssumeRole</code> – The Amazon Resource Name (ARN) of the role that allows Systems Manager automation to perform the actions on your behalf. For more information, see the <i>Required IAM Permissions</i> section in the <a href="#">AWSConfig Remediation-Cancel KeyDeletion</a> documentation.</li><li>• <code>Capabilities</code> – For AWS CloudFormation to <a href="#">create the stack</a>, you must explicitly acknowledge that your</li></ul>	Developer, Security engineer



Task	Description	Skills required
	stack template contains certain capabilities.	

## Confirm the subscription

Task	Description	Skills required
Confirm the subscription.	Check your email inbox and choose <b>Confirm subscription</b> in the email message that you receive from Amazon SNS. A web browser window will open and display a subscription confirmation and your subscription ID.	Developer, Security engineer

## Related resources

### References

- [Creating a rule for an AWS service](#)
- [Creating an Amazon CloudWatch alarm to detect usage of an AWS KMS key that is pending deletion](#)

### Tutorials and videos

- [How to get started with Amazon EventBridge](#)
- [Deep dive on Amazon EventBridge](#) (AWS Online Tech Talks)

### AWS workshop

- [Working with EventBridge rules](#)

## Additional information

The following code provides examples for extending the solution to monitor and notify you of any changes in any AWS service. The examples include predefined patterns and custom patterns. For more information, see [Events and event patterns in EventBridge](#).

```
EventPattern:
  source:
  - aws.kms
  detail-type:
  - AWS API Call via CloudTrail
  detail:
    eventSource:
    - kms.amazonaws.com
    eventName:
    - ScheduleKeyDeletion
```

## Attachments

To access additional content that is associated with this document, unzip the following file: [attachment.zip](#)

# Identify public S3 buckets in AWS Organizations using Security Hub

Created by Mourad Cherfaoui (AWS), Arun Chandapillai (AWS), and Parag Nagwekar (AWS)

**Environment:** Production

**Technologies:** Security, identity, compliance; Storage & backup

**Workload:** All other workloads

**AWS services:** Amazon EventBridge; AWS Security Hub; Amazon SNS

## Summary

This pattern shows you how to build a mechanism for identifying public Amazon Simple Storage Service (Amazon S3) buckets in your AWS Organizations accounts. The mechanism works by using controls from the [AWS Foundational Security Best Practices \(FSBP\) standard](#) in AWS Security Hub to monitor S3 buckets. You can use Amazon EventBridge to process Security Hub [findings](#), and then post these findings to an Amazon Simple Notification Service (Amazon SNS) topic. Stakeholders in your organization can subscribe to the topic and get immediate email notifications about the findings.

New S3 buckets and their objects don't allow public access by default. You can use this pattern in scenarios where you must modify default Amazon S3 configurations based on your organization's requirements. For example, this could be a scenario where you have an S3 bucket that hosts a public-facing website or files that everyone on the internet must be able to read from your S3 bucket.

Security Hub is often deployed as a central service to consolidate all security findings, including those related to security standards and compliance requirements. There are other AWS services that you can use to detect public S3 buckets, but this pattern uses an existing Security Hub deployment with minimal configuration.

## Prerequisites and limitations

### Prerequisites

- An AWS multi-account setup with a dedicated [Security Hub administrator account](#)
- Security Hub and AWS Config, enabled in the AWS Region that you want to monitor (**Note:** You must enable [cross-Region aggregation](#) in Security Hub if you want to monitor multiple Regions from a single aggregation Region.)
- User permissions for accessing and updating the Security Hub administrator account, read access to all the S3 buckets in the organization, and permissions for turning off public access (if required)

## Architecture

### Technology stack

- AWS Security Hub
- Amazon EventBridge
- Amazon Simple Notification Service (Amazon SNS)
- Amazon Simple Storage Service (Amazon S3)

### Target architecture

The following diagram shows an architecture for using Security Hub to identify public S3 buckets.

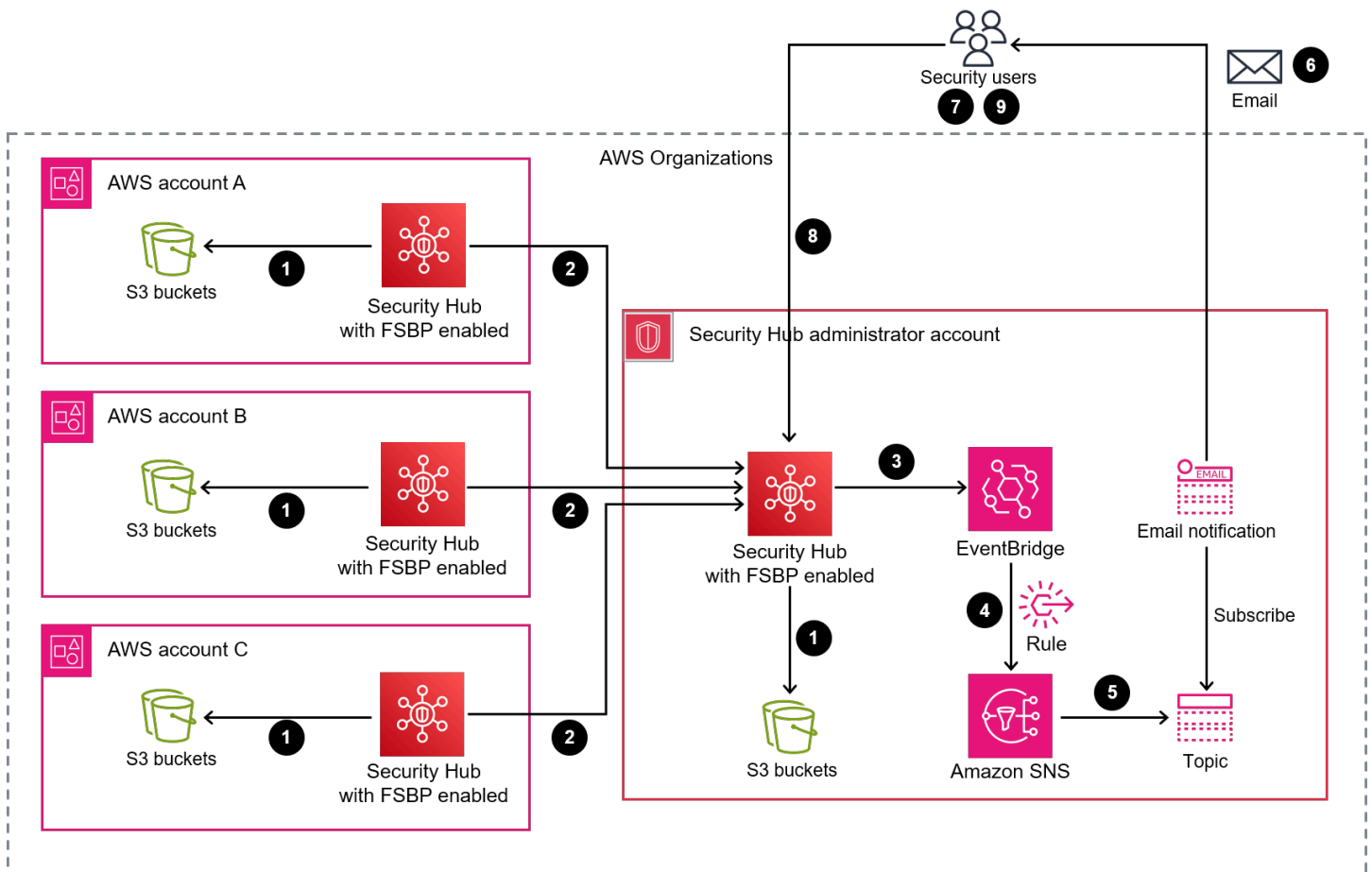

The diagram show the following workflow:

1. Security Hub monitors the configuration of S3 buckets in all AWS Organizations accounts (including the administrator account) by using the S3.2 and S3.3 controls from the FSBP security standard, and detects a finding if a bucket is configured as public.
2. The Security Hub administrator account accesses the findings (including those for S3.2 and S3.3) from all member accounts.
3. Security Hub automatically sends all new findings and all updates to existing findings to EventBridge as **Security Hub Findings - Imported** events. This includes events for findings from both the administrator and member accounts.
4. An EventBridge rule filters on findings from S3.2 and S3.3 that have a ComplianceStatus of FAILED, a workflow status of NEW, and a RecordState of ACTIVE.
5. Rules use the event patterns to identify events and send them to an SNS topic once matched.
6. An SNS topic sends the events to its subscribers (through email, for example).
7. Security analysts designated to receive the email notifications review the S3 bucket in question.

8. If the bucket is approved for public access, the security analyst sets the workflow status of the corresponding finding in Security Hub to SUPPRESSED. Otherwise, the analyst sets the status to NOTIFIED. This eliminates future notifications for the S3 bucket and reduces notification noise.
9. If the workflow status is set to NOTIFIED, the security analyst reviews the finding with the bucket owner to determine if public access is justified and complies with privacy and data protection requirements. The investigation results in either removing public access to the bucket or approving public access. In the latter case, the security analyst sets the workflow status to SUPPRESSED.

**Note:** The architecture diagram applies to both single Region and cross-Region aggregation deployments. In accounts A, B, and C in the diagram, Security Hub can belong to the same Region as the administrator account or belong to different Regions if cross-Region aggregation is enabled.

## Tools

### AWS tools

- [Amazon EventBridge](#) is a serverless event bus service that helps you connect your applications with real-time data from a variety of sources. EventBridge delivers a stream of real-time data from your own applications, software as a service (SaaS) applications, and AWS services. EventBridge routes that data to targets such as SNS topics and AWS Lambda functions if the data matches user-defined rules.
- [Amazon Simple Notification Service \(Amazon SNS\)](#) helps you coordinate and manage the exchange of messages between publishers and clients, including web servers and email addresses. Subscribers receive all messages published to the topics to which they subscribe, and all subscribers to a topic receive the same messages.
- [Amazon Simple Storage Service \(Amazon S3\)](#) is a cloud-based object storage service that helps you store, protect, and retrieve any amount of data.
- [AWS Security Hub](#) provides a comprehensive view of your security state in AWS. Security Hub also helps you check your AWS environment against security industry standards and best practices. Security Hub collects security data from across AWS accounts, services, and supported third-party partner products, and then helps to analyze security trends and identify the highest priority security issues.

# Epics

## Configure Security Hub accounts

Task	Description	Skills required
Enable Security Hub in AWS Organizations accounts.	To enable Security Hub in the organization accounts where you want to monitor S3 buckets, see the guidelines from <a href="#">Designating a Security Hub administrator account (console)</a> and <a href="#">Managing member accounts that belong to an organization</a> in the AWS Security Hub User Guide.	AWS administrator
(Optional) Enable cross-Region aggregation.	If you want to monitor S3 buckets in multiple Regions from a single Region, set up <a href="#">cross-Region aggregation</a> .	AWS administrator
Enable the S3.2 and S3.3 controls for the FSBP security standard.	<p>You must enable S3.2 and S3.3 controls for the FSBP security standard.</p> <ol style="list-style-type: none"> <li>To enable S3.2 controls, follow the instructions from <a href="#">[S3.2] S3 buckets should prohibit public read access</a> in the AWS Security Hub User Guide.</li> <li>To enable S3.3 controls, follow the instructions from <a href="#">[3] S3 buckets should prohibit public write access</a></li> </ol>	AWS administrator

Task	Description	Skills required
	in the AWS Security Hub User Guide.	

## Set up the environment

Task	Description	Skills required
Configure the SNS topic and email subscription.	<ol style="list-style-type: none"> <li>1. Sign in to the AWS Management Console and open the <a href="#">Amazon SNS console</a>.</li> <li>2. In the navigation pane, choose <b>Topics</b>, and then choose <b>Create topic</b>.</li> <li>3. For <b>Type</b>, choose <b>Standard</b>.</li> <li>4. For <b>Name</b>, enter a name for your topic (for example, <b>public-s3-buckets</b>).</li> <li>5. Choose <b>Create topic</b>.</li> <li>6. On the <b>Subscriptions</b> tab for your topic, choose <b>Create subscription</b>.</li> <li>7. For <b>Protocol</b>, select <b>Email</b>.</li> <li>8. For <b>Endpoint</b>, enter the email address that will receive the notifications. You can use the email address of an AWS administrator, IT professional, or Infosec professional.</li> <li>9. Choose <b>Create subscription</b>. To create additional</li> </ol>	AWS administrator



Task	Description	Skills required
	email subscriptions, repeat steps 6–8 as needed.	

Task	Description	Skills required
Configure the EventBridge rule.	<ol style="list-style-type: none"><li>1. Open the <a href="#">EventBridge console</a>.</li><li>2. In the <b>Get started</b> section, select <b>EventBridge Rule</b>, and then choose <b>Create rule</b>.</li><li>3. On the <b>Define rule detail</b> page, for <b>Name</b>, enter a name for your rule (for example, <b>public-s3-buckets</b>). Choose <b>Next</b>.</li><li>4. In the <b>Event pattern</b> section, choose <b>Edit pattern</b>.</li><li>5. Copy the following code, paste it into the <b>Event pattern</b> code editor, and then choose <b>Next</b>.</li></ol> <pre data-bbox="594 1188 1029 1873">{   "source": ["aws.securityhub"],   "detail-type": ["Security Hub Findings - Imported"],   "detail": {     "findings": {       "Compliance": {         "Status": ["FAILED"]       },       "RecordState": ["ACTIVE"],       "Workflow": {         "Status": ["NEW"]       }     }   } }</pre>	AWS administrator

Task	Description	Skills required
	<pre data-bbox="597 205 1023 583"> },   "ProductFields": {   "ControlId": ["S3.2", "S3.3"] } } } } } } } </pre> <p data-bbox="597 625 928 657">Then, do the following:</p> <ol data-bbox="597 699 1010 1119" style="list-style-type: none"> <li>1. On the <b>Select target(s)</b> page, for <b>Select a target</b>, select <b>SNS topic</b> as the target, and then select the topic that you created earlier.</li> <li>2. Choose <b>Next</b>, choose <b>Next</b> again, and then choose <b>Create rule</b>.</li> </ol>	

## Troubleshooting

Issue	Solution
<p data-bbox="110 1436 740 1562">I have an S3 bucket with public access enabled, but I'm not getting email notifications for it.</p>	<p data-bbox="829 1436 1507 1751">This could be because the bucket was created in another Region and cross-Region aggregation is not enabled in the Security Hub administrator account. To resolve this issue, enable cross-Region aggregation or implement this pattern's solution in the Region where your S3 bucket currently resides.</p>

## Related resources

- [What is AWS Security Hub?](#) (Security Hub documentation)
- [AWS Foundational Security Best Practices \(FSBP\) standard](#) (Security Hub documentation)
- [AWS Security Hub multi-account enable scripts](#) (AWS Labs)
- [Security best practices for Amazon S3](#) (Amazon S3 documentation)

## Additional information

### *Workflow for monitoring public S3 buckets*

The following workflow illustrates how you can monitor the public S3 buckets in your organization. The workflow assumes that you completed the steps in the *Configure the SNS topic and email subscription* story of this pattern.

1. You receive an email notification when an S3 bucket is configured with public access.
  - If the bucket is approved for public access, set the workflow status of the corresponding finding to SUPPRESSED in the Security Hub administrator account. This prevents Security Hub from issuing further notifications for this bucket and can eliminate duplicate alerts.
  - If the bucket isn't approved for public access, set the workflow status of the corresponding finding in the Security Hub administrator account to NOTIFIED. This prevents Security Hub from issuing further notifications for this bucket from Security Hub and can eliminate noise.
2. If the bucket might contain sensitive data, turn off public access immediately until the review is completed. If you turn off public access, then Security Hub changes the workflow status to RESOLVED. Then, email notifications for the bucket stop.
3. Find the user who configured the bucket as public (for example, by using AWS CloudTrail) and start a review. The review results in either removing public access to the bucket or approving public access. If public access is approved, then set the workflow status of the corresponding finding to SUPPRESSED.

# Ingest and analyze AWS security logs in Microsoft Sentinel

Created by Ivan Girardi (AWS) and Sebastian Wenzel (AWS)

<b>Code repository:</b> <a href="#">ingest-and-analyze-aws-security-logs-in-microsoft-sentinel</a>	<b>Environment:</b> Production	<b>Technologies:</b> Security, identity, compliance; Analytics
<b>Workload:</b> Microsoft	<b>AWS services:</b> AWS CloudTrail; Amazon CloudWatch; AWS Control Tower; AWS Organizations; Amazon S3; Amazon SNS; Amazon SQS	

## Summary

This pattern describes how to automate the ingestion of AWS security logs, such as AWS CloudTrail logs, Amazon CloudWatch Logs data, Amazon VPC Flow Logs data, and Amazon GuardDuty findings, into Microsoft Sentinel. If your organization uses Microsoft Sentinel as a security information and event management (SIEM) system, this helps you centrally monitor and analyze logs in order to detect security-related events. As soon as the logs are available, they are automatically delivered to an Amazon Simple Storage Service (Amazon S3) bucket in less than 5 minutes. This can help you quickly detect security events in your AWS environment.

Microsoft Sentinel ingests CloudTrail logs in a tabular format that includes the original timestamp for when the event was recorded. The structure of the ingested logs enables query capabilities by using [Kusto Query Language](#) in Microsoft Sentinel.

The pattern deploys a monitoring and alerting solution that detects ingestion failures in less than 1 minute. It also includes a notification system that the external SIEM can monitor. You use AWS CloudFormation to deploy the required resources in the logging account.

## Target audience

This pattern is recommended for users who have experience with AWS Control Tower, AWS Organizations, CloudFormation, AWS Identity and Access Management (IAM), and AWS Key Management Service (AWS KMS).

# Prerequisites and limitations

## Prerequisites

The following are the prerequisites for deploying this solution:

- Active AWS accounts that are managed as an organization in AWS Organizations and are part of an AWS Control Tower landing zone. The organization should include a dedicated account for logging. For instructions, see [Creating and configuring an organization](#) in the AWS Organizations documentation.
- A CloudTrail trail that logs events for the entire organization and stores logs in an Amazon S3 bucket in the logging account. For instructions, see [Creating a trail for an organization](#).
- In the logging account, permissions to assume an existing IAM role that has the following permissions:
  - Deploy the resources defined in the provided CloudFormation template.
  - Deploy the provided CloudFormation template.
  - Modify the AWS KMS key policy if the logs are encrypted with a customer managed key.
- AWS Command Line Interface (AWS CLI), [installed](#) and [configured](#).
- A Microsoft Azure account with a subscription to use Microsoft Sentinel.
- Enable and set up Microsoft Sentinel. For instructions, see [Enable Microsoft Sentinel and initial features and content](#) in the Microsoft Sentinel documentation.
- Meet the prerequisites for setting up the Microsoft Sentinel S3 connector.

## Limitations

- This solution forwards the security logs from an Amazon S3 bucket in the logging account to Microsoft Sentinel. Instructions for how to send the logs to Amazon S3 are not explicitly provided.
- This pattern provides instructions for deployment in an AWS Control Tower landing zone. However, use of AWS Control Tower is not required.
- This solution is compatible with an environment where the Amazon S3 logging bucket is restricted with [service control policies \(SCPs\)](#), such as [Disallow Changes to Bucket Policy for AWS Control Tower Created Amazon S3 Buckets in Log Archive](#).

- This pattern provides instructions for forwarding CloudTrail logs, but you can adapt this solution to send other logs that Microsoft Sentinel supports, such as logs from CloudWatch Logs, Amazon VPC Flow Logs, and GuardDuty.
- The instructions use the AWS CLI to deploy the CloudFormation template, but you could also use the AWS Management Console. For instructions, see [Using the AWS CloudFormation console](#). If you use the console to deploy the stack, deploy the stack in the same AWS Region as the logging bucket.
- This solution deploys an Amazon Simple Queue Service (Amazon SQS) queue to deliver Amazon S3 notifications. The queue contains messages with the paths of objects uploaded in the Amazon S3 bucket, not actual data. The queue uses SSE-SQS encryption to help protect the content of the messages. If you want to encrypt the SQS queue with SSE-KMS, you can use a customer managed KMS key. For more information, see [Encryption at rest in Amazon SQS](#).

## Architecture

This section provides a high-level overview of the architecture that the sample code establishes. The following diagram shows the resources deployed in the logging account in order to ingest logs from an existing Amazon S3 bucket into Microsoft Sentinel.

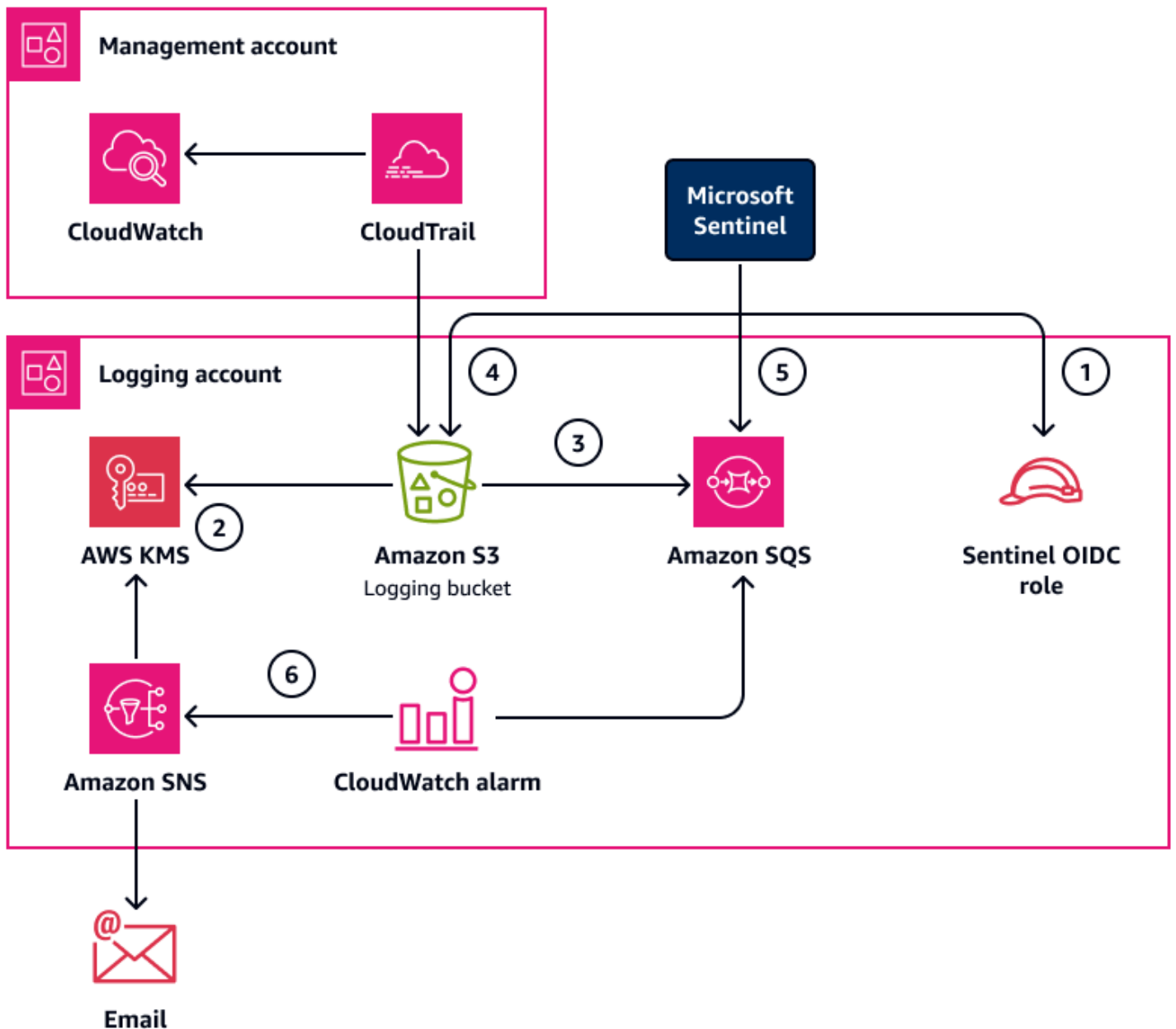

The architecture diagram shows the following resource interactions:

1. In the logging account, Microsoft Sentinel assumes an IAM role through OpenID Connect (OIDC) to access logs in a specific Amazon S3 bucket and Amazon SQS queue.
2. Amazon Simple Notification Service (Amazon SNS) and Amazon S3 use AWS KMS for encryption.
3. Amazon S3 sends notification messages to the Amazon SQS queue whenever it receives new logs.
4. Microsoft Sentinel checks Amazon SQS for new messages. The Amazon SQS queue uses SSE-SQS encryption. The message retention period is set to 14 days.



5. Microsoft Sentinel pulls messages from the Amazon SQS queue. The messages contain the path of the uploaded Amazon S3 objects. Microsoft Sentinel ingests those objects from the Amazon S3 bucket into the Microsoft Azure account.
6. A CloudWatch alarm monitors the Amazon SQS queue. If messages are not received and deleted from the Amazon SQS queue within 5 minutes, then it initiates an Amazon SNS notification that sends an email.

AWS Control Tower helps you set up the foundational organization unit (OU) structure and centralizes CloudTrail logs in the logging account. It also implements mandatory SCPs to protect the logging bucket.

We have provided the target architecture in an AWS Control Tower landing zone, but this is not strictly required. In this diagram, the resources in the management account reflect an AWS Control Tower deployment and a CloudTrail trail that logs events for the entire organization.

This pattern focuses on the deployment of resources in the logging account. If the logs stored in Amazon S3 in your AWS Control Tower landing zone are encrypted with a customer managed KMS key, then you must update the key policy to allow Microsoft Sentinel to decrypt the logs. In an AWS Control Tower landing zone, you manage the key policy from the management account, which is where the key was created.

## Tools

### AWS services

- [AWS CloudFormation](#) helps you set up AWS resources, provision them quickly and consistently, and manage them throughout their lifecycle across AWS accounts and Regions.
- [Amazon CloudWatch](#) helps you monitor the metrics of your AWS resources and the applications you run on AWS in real time.
- [AWS Control Tower](#) helps you set up and govern an AWS multi-account environment, following best practices.
- [AWS Key Management Service \(AWS KMS\)](#) helps you create and control cryptographic keys to help protect your data.
- [AWS Organizations](#) is an account management service that helps you consolidate multiple AWS accounts into an organization that you create and centrally manage.
- [Amazon Simple Queue Service \(Amazon SQS\)](#) provides a secure, durable, and available hosted queue that helps you integrate and decouple distributed software systems and components.

- [Amazon Simple Storage Service \(Amazon S3\)](#) is a cloud-based object storage service that helps you store, protect, and retrieve any amount of data.

## Other tools

- [Microsoft Sentinel](#) is a cloud-native SIEM system that provides security orchestration, automation, and response (SOAR).

## Code repository

The code for this pattern is available in the GitHub [Ingest and analyze AWS security logs in Microsoft Sentinel](#) repository.

## Best practices

- Follow the [principle of least-privilege](#) (IAM documentation).
- Follow the [Best practices for AWS Control Tower administrators](#) (AWS Control Tower documentation).
- Follow the [AWS CloudFormation best practices](#) (CloudFormation documentation).
- Use code analysis tools, such as [cfn\\_nag](#), to scan the generated CloudFormation templates. The `cfn_nag` tool identifies potential security issues in CloudFormation templates by searching for patterns.

## Epics

### Connect Microsoft Sentinel to Amazon S3

Task	Description	Skills required
Prepare the Microsoft Sentinel S3 connector.	<ol style="list-style-type: none"><li>1. In Microsoft Sentinel, choose <b>Data connectors</b>.</li><li>2. From the data connectors gallery, choose <b>Amazon Web Services S3</b>.</li></ol> <p><b>Note:</b> If you don't see the connector, install the</p>	DevOps engineer, General AWS

Task	Description	Skills required
	<p><a href="#">Amazon Web Services solution</a> from the Content Hub in Microsoft Sentinel.</p> <p>3. In the details pane for the connector, choose <b>Open connector page</b>.</p> <p>4. In the <b>Configuration</b> section, copy the <b>External ID</b>. You need this ID later.</p>	

## Deploy the CloudFormation stack

Task	Description	Skills required
Clone the repository.	<p>In a bash shell, enter the following command. This clones the <a href="#">Ingest and analyze AWS Security Logs in Microsoft Sentinel</a> repository.</p> <pre>git clone https://github.com/aws-samples/ingest-and-analyze-aws-security-logs-in-microsoft-sentinel.git</pre>	DevOps engineer, General AWS
Assume the IAM role in the logging account.	<p>In the logging account, assume the IAM role that has permissions to deploy the CloudFormation stack. For more information about assuming an IAM role in the</p>	DevOps engineer, General AWS

Task	Description	Skills required
	AWS CLI, see <a href="#">Use an IAM role in the AWS CLI</a> .	

Task	Description	Skills required
Deploy the stack.	<p>To deploy the CloudFormation stack enter the following command, where:</p> <ul style="list-style-type: none"><li>• <code>&lt;Bucket name&gt;</code> is the name of the logging Amazon S3 bucket.</li><li>• <code>&lt;Sentinel external ID&gt;</code> is the external ID of the Amazon S3 connector in Microsoft Sentinel.</li><li>• <code>&lt;Email address&gt;</code> is a valid email address where you want to receive notifications.</li><li>• <code>&lt;Customer managed key ARN&gt;</code> is the Amazon Resource Name (ARN) of the customer managed KMS key. Provide this parameter only if the logs are encrypted with a customer managed KMS key.</li><li>• <code>&lt;Suffix&gt;</code> is an optional parameter to avoid resource name conflicts.</li><li>• <code>&lt;ARN for the OIDC provider&gt;</code> is the ARN of the <a href="#">OIDC provider</a> if it already exists. If you do not provide this parameter, CloudFormation creates the OIDC provider.</li></ul>	DevOps engineer, General AWS

Task	Description	Skills required
	<p><b>Important:</b> If the AWS organization is monitored with <a href="#">Microsoft Code Defender</a>, the OIDC provider for Microsoft has been already deployed. You must provide this parameter and the ARN of the existing provider.</p> <pre data-bbox="592 703 1031 1837">aws cloudformation   deploy --stack-name     cloudtrail-sentinel-     integration \       --no-fail-on-empty     -changeset \       --template-file     template.yml \       --capabilities     CAPABILITY_IAM     CAPABILITY_NAMED_I     AM CAPABILITY_AUTO_EX     PAND \       --parameter-overri     des \       ControlTowerS3Buck     etName="&lt;Bucket name&gt;"     \       AzureWorkspaceID="     &lt;Sentinel external ID&gt;"     \       EmailAddress="&lt;Ema     il address&gt;" \       KMSKeyArn="&lt;Custom     er managed key ARN&gt;" \       Suffix="&lt;Suffix to     avoid name conflicts&gt;"     \</pre>	

Task	Description	Skills required
	<pre>OIDCProviderArn="&lt; ARN for the OIDC provider&gt;"</pre>	
Copy outputs.	From the output of the CloudFormation stack, copy the values for <code>SentinelRoleArn</code> and <code>SentinelSQS</code> . You use these values later to complete the configuration in Microsoft Sentinel.	DevOps engineer, General AWS

Task	Description	Skills required
Modify the key policy.	<p>If you aren't using a customer managed KMS key to encrypt the logs in the Amazon S3 bucket, you can skip this step.</p> <p>If the logs are encrypted with a customer managed KMS key, modify the key policy to grant Microsoft Sentinel permission to decrypt the logs. The following is an example key policy. This example policy allows cross-account access if the KMS key is in another AWS account.</p> <pre data-bbox="592 949 1027 1877">{   "Version":   "2012-10-17",   "Id": "key-policy",   "Statement": [     ...     {       "Sid":       "Grant access to       decrypt",       "Effect":       "Allow",       "Principa       1": {         "AWS":         "&lt;SentinelRoleArn&gt;"       },       "Action":       "kms:Decrypt",       "Resource":       "&lt;KeyArn&gt;"     }   ] }</pre>	DevOps engineer, General AWS

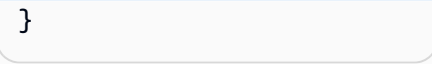

Task	Description	Skills required
	} 	

## Configure the connector in Microsoft Sentinel

Task	Description	Skills required
Complete the configuration in Microsoft Sentinel.	<ol style="list-style-type: none"> <li>1. In Microsoft Sentinel, choose <b>Data connectors</b>.</li> <li>2. From the data connectors gallery, choose <b>Amazon Web Services S3</b>.</li> <li>3. In the details pane for the connector, choose <b>Open connector page</b>.</li> <li>4. In the <b>Configuration</b> section, do the following: <ol style="list-style-type: none"> <li>a. In <b>Role to add</b>, enter the <code>SentinelRoleArn</code> value that you copied.</li> <li>b. In <b>SQS URL</b>, enter the <code>SentinelSQS</code> value that you copied.</li> <li>c. In the <b>Destination table</b> list, choose <code>AWSCloudTrail</code>.</li> </ol> </li> <li>5. Choose <b>Add connection</b>.</li> </ol>	DevOps engineer
Send Amazon S3 event notifications to Amazon SQS.	Follow the instructions in <a href="#">Enabling and configuring event notifications using the Amazon S3 console</a> to configure the Amazon S3 logging bucket to send event	DevOps engineer, General AWS

Task	Description	Skills required
	<p>notifications to the Amazon SQS queue. If CloudTrail has been configured for the whole organization, logs in the this bucket have the prefix &lt;OrgID&gt;/AWSLogs/&lt;OrgID&gt;/ , where &lt;OrgID&gt; is the organization ID. For more information, see <a href="#">Viewing details about your organization</a>.</p>	
<p>Confirm that the logs are ingested.</p>	<ol style="list-style-type: none"> <li>1. Wait until the logs are ingested in Microsoft Sentinel. This can take several minutes.</li> <li>2. In Microsoft Sentinel, open the Amazon S3 Data Connector page, and then do the following: <ul style="list-style-type: none"> <li>• Confirm that the Amazon S3 Data Connector status is <b>Connected</b> .</li> <li>• Check the data volume in the <b>Data received</b> graph.</li> </ul> <p>For more information about inspecting the data connector activity, see <a href="#">Data connector</a> in the Microsoft documentation.</p> </li> </ol>	<p>DevOps engineer</p>

## Validate the solution

Task	Description	Skills required
Compare CloudWatch and Sentinel logs.	<p>In the default configuration of AWS Control Tower, CloudTrail logs are sent to Amazon CloudWatch and stored in the AWS Control Tower management account. For more information, see <a href="#">Logging and monitoring in AWS Control Tower</a>. Use the following steps to confirm that that logs are automatically ingested into Microsoft Sentinel:</p> <ol style="list-style-type: none"><li>1. Open the <a href="#">CloudWatch console</a>.</li><li>2. In the navigation pane, choose <b>Logs</b>, and then choose <b>Logs Insights</b>.</li><li>3. For <b>Select log group(s)</b>, select the log group where the CloudTrail logs are stored, such as <code>aws-controltower/CloudTrail Logs</code>.</li><li>4. In the query editor box, enter <code>fields eventID</code>.</li><li>5. Choose <b>Run query</b>.</li><li>6. Choose <b>Export results</b>, and then choose <b>Copy table to clipboard (CSV)</b>.</li></ol>	DevOps engineer, General AWS

Task	Description	Skills required
	<p>7. Paste the results to a text editor.</p> <p>8. Change the format of the output so that it can be used in a Microsoft Sentinel query. The following is an example that uses the Kusto Query Language:</p> <pre data-bbox="630 674 1029 1031">AWSCloudTrail   where AwsEventId in ( 'aa08b5fe-3bfb-391a- a14e-5fcebe14dab2', '9decd805-269c-451c- b75b-762f5dce59f9' )</pre> <p>9. In Microsoft Sentinel, open the Amazon S3 Data Connector page. Next to the <b>Data received</b> graph, choose <b>Go to log analytics</b>.</p> <p>10. In the query editor box, enter the query, and then choose <b>Run</b>.</p> <p>11. In Microsoft Sentinel and CloudWatch, verify that the number of entries is the same. Adapt the time range if needed.</p>	

## Related resources

### AWS documentation and resources

- [AWS CLI Command Reference](#) (AWS CLI documentation)
- [Optionally configure AWS KMS keys](#) (AWS Control Tower documentation)
- [Encryption at rest in Amazon SQS](#) (Amazon SQS documentation)
- [How do I keep mailing list recipients from unsubscribing everyone on the list from my Amazon SNS topic emails?](#) (AWS Knowledge Center)

### Microsoft documentation

- [Connect Microsoft Sentinel to Amazon Web Services to ingest AWS service log data](#)
- [Kusto Query Language in Microsoft Sentinel](#)

# Manage AWS IAM Identity Center permission sets as code by using AWS CodePipeline

Created by Andre Cavalcante (AWS) and Claison Amorim (AWS)

**Code repository:** [aws-iam-identity-center-pipeline](#)

**Environment:** Production

**Technologies:** Security, identity, compliance; DevOps

**AWS services:** AWS CodeBuild; AWS CodeCommit; AWS CodePipeline; AWS IAM Identity Center

## Summary

AWS IAM Identity Center (successor to AWS Single Sign-On) helps you centrally manage single sign-on (SSO) access to all of your AWS accounts and applications. You can create and manage user identities in IAM Identity Center, or you can connect an existing identity source, such as a Microsoft Active Directory domain or an external identity provider (IdP). IAM Identity Center provides a unified administration experience to define, customize, and assign fine-grained access to your AWS environment by using [permission sets](#). Permission sets apply to the federated users and groups from your AWS IAM Identity Center identity store or your external IdP.

This pattern helps you to manage IAM Identity Center permission sets as code in your multi-account environment that is managed as an organization in AWS Organizations. With this pattern, you can achieve the following:

- Create, delete, and update permission sets
- Create, update, or delete permission set assignments to target AWS accounts, organizational units (OUs), or your organization root.

To manage IAM Identity Center permissions and assignments as code, this solution deploys a continuous integration and continuous delivery (CI/CD) pipeline that uses AWS CodeCommit, AWS CodeBuild, and AWS CodePipeline. You manage the permission sets and assignments in JSON templates that you store in the CodeCommit repository. When Amazon EventBridge rules detect a

change to the repository or detect modifications to the accounts in the target OU, it starts an AWS Lambda function. The Lambda function initiates the CI/CD pipeline that updates the permission sets and assignments in IAM Identity Center.

## Prerequisites and limitations

### Prerequisites

- A multi-account environment managed as an organization in AWS Organizations. For more information, see [Creating an organization](#).
- IAM Identity Center, enabled and configured with an identity source. For more information, see [Getting Started](#) in the IAM Identity Center documentation.
- A member account that is registered as the delegated administrator for IAM Identity Center. For instructions, see [Register a member account](#) in the IAM Identity Center documentation.
- Permissions to deploy AWS CloudFormation stacks in the IAM Identity Center delegated administrator account and in the organization's management account. For more information, see [Controlling access](#) in the CloudFormation documentation.
- An Amazon Simple Storage Service (Amazon S3) bucket in the Identity Center delegated administrator to upload the artifact code. For instructions, see [Creating a bucket](#).
- The account ID of the organization's management account. For instructions, see [Finding your AWS account ID](#).

### Limitations

- This pattern cannot be used to manage or assign permission sets for single-account environments or for accounts that are not managed as an organization in AWS Organizations.
- Permission set names, assignment IDs, and IAM Identity Center principal types and IDs cannot be modified after deployment.
- This pattern helps you create and manage [custom permissions](#). You cannot use this pattern to manage or assign [predefined permissions](#).
- This pattern cannot be used to manage a permission set for the organization's management account.

## Architecture

### Technology stack

- AWS CodeBuild
- AWS CodeCommit
- AWS CodePipeline
- Amazon EventBridge
- AWS Identity Center
- AWS Lambda
- AWS Organizations

### Target architecture

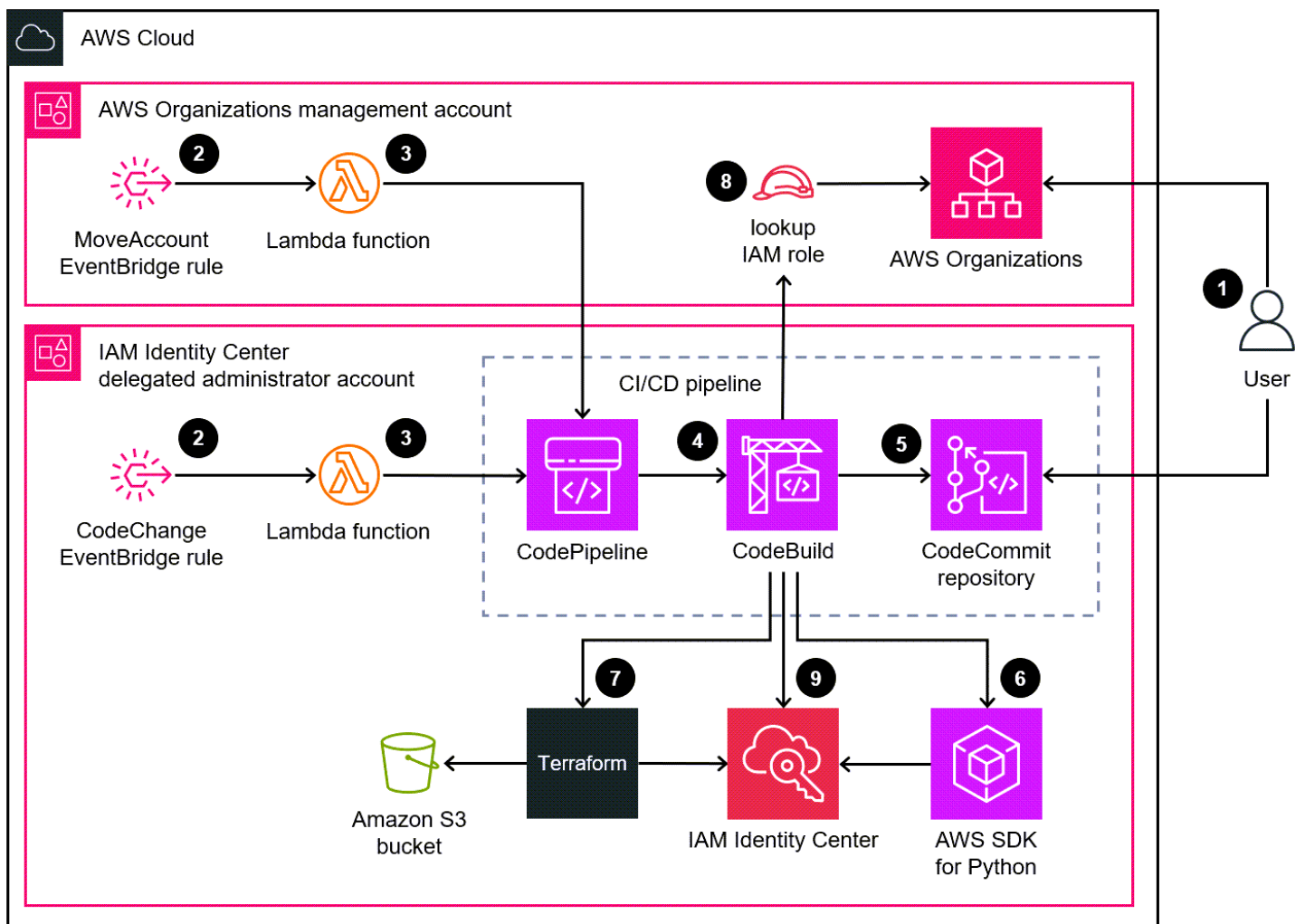

The diagram shows the following workflow:

1. A user makes one of the following changes:



- a. Commits one or more changes to the CodeCommit repository
  - b. Modifies the accounts in the organization unit (OU) in AWS Organizations
2. If the user committed a change to the CodeCommit repository, then the CodeChange EventBridge rule detects the change and starts a Lambda function in the IAM Identity Center delegated administrator account. The rule doesn't react to changes in certain files in the repository, such as the README .md file.

If the user modified the accounts in the organizational unit, then the MoveAccount EventBridge rule detects the change and starts a Lambda function in the organization's management account.

3. The initiated Lambda function starts the CI/CD pipeline in CodePipeline.
4. CodePipeline starts the CodebuildTemplateValidation CodeBuild project.
5. The CodebuildTemplateValidation CodeBuild project uses a Python script in the CodeCommit repository to validate the permission set templates. CodeBuild validates the following:
  - The permission set names are unique.
  - The assignment statement IDs (Sid) are unique.
  - Policy definitions in the CustomPolicy parameter are valid. (This validation uses AWS Identity and Access Management Access Analyzer.)
  - The Amazon Resource Names (ARNs) of the managed policies are valid.
6. The CodebuildPermissionSet CodeBuild project uses AWS SDK for Python (Boto3) to delete, create, or update the permission sets in IAM Identity Center. Only permission sets with the SSOPipeline:true tag are affected. All permission sets that are managed through this pipeline have this tag.
7. The CodebuildAssignments CodeBuild project uses Terraform to delete, create, or update the assignments in IAM Identity Center. The Terraform backend state files are stored in an S3 bucket in the same account.
8. CodeBuild assumes a Lookup IAM role in the organization's management account. It calls the organizations and [identitystore](#) APIs in order to list the resources required to grant or revoke permissions.
9. CodeBuild updates the permissions sets and assignments in IAM Identity Center.

## Automation and scale

Because all new accounts in a multi-account environment are moved to a specific organizational unit in AWS Organizations, this solution automatically runs and grants the required permission sets to all accounts that you specify in the assignment templates. No additional automations or scaling actions are necessary.

In large environments, the number of API requests to IAM Identity Center might cause this solution to run more slowly. Terraform and Boto3 automatically manage throttling to minimize any performance degradation.

## Tools

### AWS services

- [AWS CloudFormation](#) helps you set up AWS resources, provision them quickly and consistently, and manage them throughout their lifecycle across AWS accounts and Regions.
- [AWS CodeBuild](#) is a fully managed build service that helps you compile source code, run unit tests, and produce artifacts that are ready to deploy.
- [AWS CodeCommit](#) is a version control service that helps you privately store and manage Git repositories, without needing to manage your own source control system.
- [AWS CodePipeline](#) helps you quickly model and configure the different stages of a software release and automate the steps required to release software changes continuously.
- [Amazon EventBridge](#) is a serverless event bus service that helps you connect your applications with real-time data from a variety of sources. For example, AWS Lambda functions, HTTP invocation endpoints using API destinations, or event buses in other AWS accounts.
- [AWS IAM Identity Center](#) helps you centrally manage single sign-on (SSO) access to all of your AWS accounts and cloud applications.
- [AWS Organizations](#) is an account management service that helps you consolidate multiple AWS accounts into an organization that you create and centrally manage.
- [AWS SDK for Python \(Boto3\)](#) is a software development kit that helps you integrate your Python application, library, or script with AWS services.
- [Amazon Simple Storage Service \(Amazon S3\)](#) is a cloud-based object storage service that helps you store, protect, and retrieve any amount of data.

### Code repository

The code for this pattern is available in the [aws-iam-identity-center-pipeline](#) repository. The templates folder in the repository includes sample templates for both permission sets and assignments. It also includes AWS CloudFormation templates for deploying the CI/CD pipeline and AWS resources in the target accounts.

## Best practices

- Before you start modifying the permission set and assignment templates, we recommend that you plan permission sets for your organization. Consider what the permissions should be, which accounts or OUs the permission set should apply to, and which IAM Identity Center principals (users or groups) should be affected by the permission set. Permission set names, association IDs, and IAM Identity Center principal types and IDs cannot be modified after deployment.
- Adhere to the principle of least privilege and grant the minimum permissions required to perform a task. For more information, see [Grant least privilege](#) and [Security best practices](#) in the IAM documentation.

## Epics

### Plan permission sets and assignments

Task	Description	Skills required
Clone the repository.	<p>In a bash shell, enter the following command. This clones the <a href="#">aws-iam-identity-center-pipeline</a> repository from GitHub.</p> <pre>git clone https://github.com/aws-samples/aws-iam-identity-center-pipeline.git</pre>	DevOps engineer
Define the permission sets.	<ol style="list-style-type: none"> <li>1. In the cloned repository, navigate to the <code>templates/permissionsets</code> folder, and then</li> </ol>	DevOps engineer

Task	Description	Skills required
	<p>open one of the available templates.</p> <ol style="list-style-type: none"><li data-bbox="591 310 1027 590">2. In the Name parameter , enter a name for the permission set. This value must be unique, and it cannot be changed after deployment.</li><li data-bbox="591 611 1027 789">3. In the Description parameter, briefly describe the permission set, such as its use case.</li><li data-bbox="591 810 1027 1276">4. In the SessionDuration parameter, specify the length of time that a user can be signed in to an AWS account. Use <a href="#">ISO-8601 duration format</a> (Wikipedia), such as PT4H for 4 hours. If no value is defined, the default in IAM Identity Center is 1 hour.</li><li data-bbox="591 1297 1027 1717">5. Customize the policies in the permission set. All of the following parameter s are optional and can be modified after deployment. You must use at least one of the parameters in order to define the policies in the permission set:<ul style="list-style-type: none"><li data-bbox="630 1738 989 1873">• In the ManagedPolicies parameter, enter the ARNs of any</li></ul></li></ol>	

Task	Description	Skills required
	<p><a href="#">AWS managed policies</a> that you want to assign.</p> <ul style="list-style-type: none"><li>• In the <code>CustomerManagedPolicies</code> parameter, enter the names of any <a href="#">customer managed policies</a> that you want to assign. Do not use the ARN.</li><li>• In the <code>PermissionBoundary</code> parameter, do the following to assign a <a href="#">permission boundary</a>:<ul style="list-style-type: none"><li>• If you're using an AWS managed policy as a permission boundary, in <code>PolicyType</code> , enter <code>AWS</code>, and in <code>Policy</code>, enter the ARN of the policy.</li><li>• If you're using a customer managed policy as a permission boundary, in <code>PolicyType</code> , enter <code>Customer</code>, and in <code>Policy</code>, enter the name of the policy. Do not use the ARN.</li></ul></li><li>• In the <code>CustomPolicy</code> parameter, define any custom, JSON-formatted policies that you</li></ul>	

Task	Description	Skills required
	<p>want to assign. For more information about the JSON policy structure, see <a href="#">Overview of JSON policies</a>.</p> <ol style="list-style-type: none"><li>6. Save and close the permission set template. We recommend that you save the file with a name that matches the name of the permission set.</li><li>7. Repeat this process to create as many permission sets as needed for your organization, and delete any sample templates that aren't required.</li></ol>	

Task	Description	Skills required
Define the assignments.	<ol style="list-style-type: none"><li data-bbox="592 226 1027 693">1. In the cloned repository, navigate to the <code>templates/assignments</code> folder, and then open <code>iam-identitycenter-assignments.json</code>. This file describes how you want to assign the permission sets to AWS accounts or OUs.</li><li data-bbox="592 718 998 987">2. In the <code>SID</code> parameter, enter an identifier for the assignment. This value must be unique, and it cannot be modified after deployment.</li><li data-bbox="592 1012 1027 1806">3. In the <code>Target</code> parameter, define the accounts or organizations where you want to apply the permission set. Valid values are account IDs, OU IDs, OU names, or <code>root</code>. <code>root</code> assigns the permission set to all member accounts in the organization, excluding the management account. Enter the values in double quotation marks, and separate multiple values with commas. For instructions about how to find IDs, see <a href="#">Viewing details of an</a></li></ol>	DevOps engineer

Task	Description	Skills required
	<p><a href="#">account</a> or <a href="#">Viewing the details of an OU</a>.</p> <ol style="list-style-type: none"><li data-bbox="592 317 1015 730">4. In the <code>PrincipalType</code> parameter, enter the type of IAM Identity Center principal that will be affected by the permission set. Valid values are <code>USER</code> or <code>GROUP</code>. This value cannot be modified after deployment.</li><li data-bbox="592 758 1024 1125">5. In the <code>PrincipalID</code> parameter, enter the name of the user or group in the IAM Identity Center identity store that will be affected by the permission set. This value cannot be modified after deployment.</li><li data-bbox="592 1152 967 1373">6. In the <code>PermissionSetName</code> parameter, enter the name of the permission set that you want to assign.</li><li data-bbox="592 1400 1015 1768">7. Repeat steps 2–6 to create as many assignments as needed in this file. Typically, there is one assignment for each permission set. Delete any sample assignments that aren't required.</li></ol>	



Task	Description	Skills required
	8. Save and close the <code>iam-identitycenter-assignments.json</code> file.	

## Deploy the permission sets and assignments

Task	Description	Skills required
Upload the files to an S3 bucket.	<ol style="list-style-type: none"> <li>1. Compress the cloned repository into a .zip file.</li> <li>2. Sign in to the IAM Identity Center delegated administrator account.</li> <li>3. Open the Amazon S3 console at <a href="https://console.aws.amazon.com/s3/">https://console.aws.amazon.com/s3/</a>.</li> <li>4. In the left navigation pane, choose <b>Buckets</b>.</li> <li>5. Choose the bucket that you want to use to deploy this solution.</li> <li>6. Upload the .zip file to the target S3 bucket. For instructions, see <a href="#">Uploading objects</a>.</li> </ol>	DevOps engineer
Deploy resources in the IAM Identity Center delegated administrator account.	<ol style="list-style-type: none"> <li>1. In the IAM Identity Center delegated administrator account, open the CloudFormation console at <a href="https://console.aws.amazon.com/cloudformation/">https://console.aws.amazon.com/cloudformation/</a>.</li> </ol>	DevOps engineer

Task	Description	Skills required
	<p>2. Deploy the <code>iam-identitycenter-pipeline.yaml</code> template. Give the stack a clear and descriptive name, and update the parameters as instructed. For instructions, see <a href="#">Creating a stack</a> in the CloudFormation documentation.</p>	

Task	Description	Skills required
Deploy resources in AWS Organization management account.	<ol style="list-style-type: none"><li data-bbox="592 226 1027 308">1. Sign in to the organization's management account.</li><li data-bbox="592 329 1011 510">2. Open the CloudFormation console at <a href="https://console.aws.amazon.com/cloudformation/">https://console.aws.amazon.com/cloudformation/</a>.</li><li data-bbox="592 531 997 1045">3. In the navigation bar, choose the name of the currently displayed AWS Region. Then choose the us-east-1 Region. This Region is required so that the MoveAccount EventBridge rule can detect AWS CloudTrail events associated with organization changes.</li><li data-bbox="592 1066 1003 1524">4. Deploy the iam-identitycenter-organization template. Give the stack a clear and descriptive name, and update the parameters as instructed. For instructions, see <a href="#">Creating a stack</a> in the CloudFormation documentation.</li></ol>	DevOps engineer

## Updating the permission sets and assignments

Task	Description	Skills required
Update the permission sets and assignments.	<p>When the MoveAccount Amazon EventBridge rule detects modifications to the accounts in the organization, the CI/CD pipeline automatically starts and updates the permission sets. For example, if you add an account to an OU specified in the assignments JSON file, then the CI/CD pipeline will apply the permission set to the new account.</p> <p>If you want to modify the deployed permission sets and assignments, update the JSON files and then commit them to the CodeCommit repository in the IAM Identity Center delegated administrator account. For instructions, see <a href="#">Create a commit</a> in the CodeCommit documentation.</p> <p>Note the following when using the CI/CD pipeline to manage previously deployed permission sets and associations:</p> <ul style="list-style-type: none"><li>• If you change the name of a permission set, the CI/CD pipeline deletes the original</li></ul>	DevOps engineer

Task	Description	Skills required
	<p>permission set and creates a new one.</p> <ul style="list-style-type: none"> <li>• This pipeline manages only permission sets that have the <code>SSOPipeline:true</code> tag.</li> <li>• You can have multiple permission set and assignment templates in the same folder in the repository.</li> <li>• If you delete a template, the pipeline deletes the assignment or permission set.</li> <li>• If you delete an entire assignment JSON block, the pipeline deletes the assignment from IAM Identity Center.</li> <li>• You can't delete a permission set that is assigned to an AWS account. First, you must unassign the permission set.</li> </ul>	

## Troubleshooting

Issue	Solution
Access denied errors	Confirm that you have the permissions required to deploy the CloudFormation templates and the resources defined within

Issue	Solution
Pipeline errors in the validation phase	<p>them. For more information, see <a href="#">Controlling access</a> in the CloudFormation documentation.</p> <p>This error appears if there are any errors in the permission set or assignment templates.</p> <ol style="list-style-type: none"><li>1. In CodeBuild, view the <a href="#">build details</a>.</li><li>2. In the build log, find the validation error that provides more information about what caused the build to fail.</li><li>3. Update the permission set or assignment templates, and then commit them to the repository.</li><li>4. The CI/CD pipeline restarts the CodeBuild project. Monitor the status to confirm that the validation error is resolved.</li></ol>

## Related resources

- [Permission sets](#) (IAM Identity Center documentation)

# Manage credentials using AWS Secrets Manager

Created by Durga Prasad Cheepuri (AWS)

**Created by:** AWS

**Environment:** PoC or pilot

**Technologies:** Databases;  
Security, identity, compliance

**AWS services:** AWS Secrets  
Manager

## Summary

This pattern walks you through using AWS Secrets Manager to dynamically fetch database credentials for a Java Spring application.

In the past, when you created a custom application that retrieves information from a database, you typically had to embed the credentials (the secret) for accessing the database directly in the application. When it was time to rotate the credentials, you had to invest time to update the application to use the new credentials, and then distribute the updated application. If you had multiple applications that shared credentials and you missed updating one of them, the application would fail. Because of this risk, many users chose not to regularly rotate their credentials, which effectively substituted one risk for another.

Secrets Manager enables you to replace hard-coded credentials in your code (including passwords) with an API call to retrieve the secret programmatically. This helps ensure that the secret can't be compromised by someone who is examining your code, because the secret simply isn't there. You can also configure Secrets Manager to automatically rotate the secret according to a schedule that you specify. This enables you to replace long-term secrets with short-term ones, which helps significantly reduce the risk of compromise. For more information, see the [AWS Secrets Manager documentation](#).

## Prerequisites and limitations

### Prerequisites

- An AWS account with access to Secrets Manager

- A Java Spring application

## Architecture

### Source technology stack

- A Java Spring application with code that accesses a database, with DB credentials managed from the application.properties file.

### Target technology stack

- A Java Spring application with code that accesses a database, with DB credentials managed in Secrets Manager. The application.properties file holds the secrets to Secrets Manager.

### Secrets Manager integration with an application

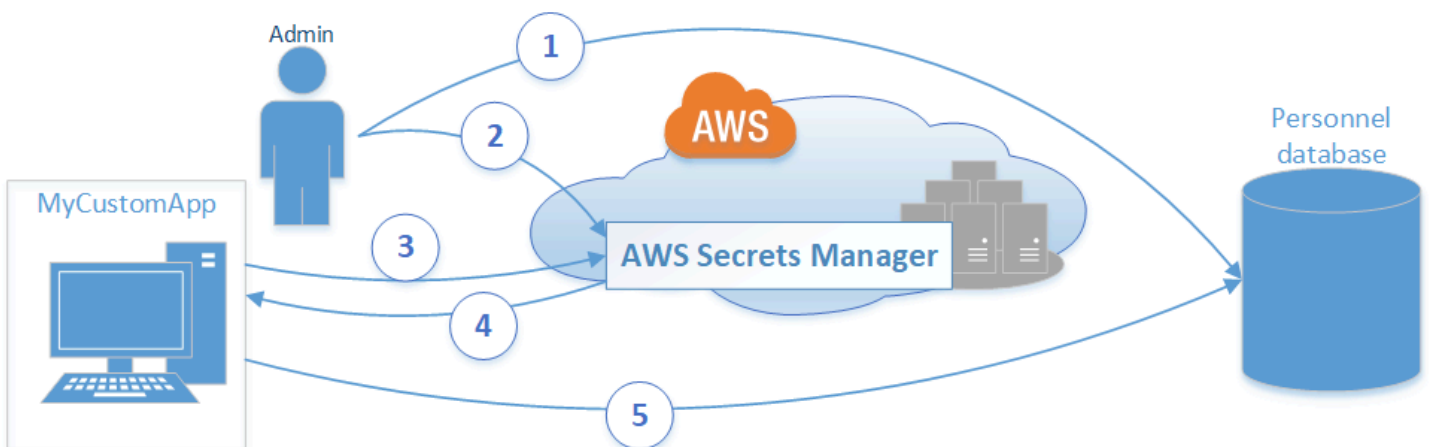

## Tools

- **Secrets Manager** – [AWS Secrets Manager](#) is an AWS service that makes it easier for you to manage secrets. Secrets can be database credentials, passwords, third-party API keys, and even arbitrary text. You can store and control access to these secrets centrally by using the Secrets Manager console, the Secrets Manager command-line interface (CLI), or the Secrets Manager API and SDKs.



# Epics

## Store secret in Secrets Manager

Task	Description	Skills required
Store the DB credentials as a secret in Secrets Manager.	Store Amazon Relational Database Service (Amazon RDS) or other DB credentials as a secret in Secrets Manager by following the steps in <a href="#">Creating a secret</a> in the Secrets Manager documentation.	Sys Admin
Set permissions for the Spring application to access Secrets Manager.	Set the appropriate permissions based on how the Java Spring application uses Secrets Manager. To control access to the secret, create a policy based on the information provided in the Secrets Manager documentation, in the sections <a href="#">Using identity-based policies (IAM Policies)</a> and <a href="#">ABAC for Secrets Manager</a> and <a href="#">Using resource-based policies for Secrets Manager</a> . Follow the steps in the section <a href="#">Retrieving the secret value</a> in the Secrets Manager documentation.	Sys Admin

## Update the Spring application

Task	Description	Skills required
Add JAR dependencies to use Secrets Manager.	See the <i>Additional information</i> section for details.	Java developer
Add the details of the secret to the Spring application.	Update the application.properties file with the secret name, endpoints, and AWS Region. For an example, see the <i>Additional information</i> section.	Java developer
Update the DB credentials retrieval code in Java.	In the application, update the Java code that fetches the DB credentials to fetch those details from Secrets Manager. For example code, see the <i>Additional information</i> section.	Java developer

## Related resources

- [AWS Secrets Manager documentation](#)
- [Using identity-based policies \(IAM Policies\) and ABAC for Secrets Manager](#)
- [Using resource-based policies for Secrets Manager](#)
- [Sample code](#)

## Additional information

### Adding JAR dependencies for using Secrets Manager

*Maven:*

```
<groupId>com.amazonaws</groupId>
```

```
<artifactId>aws-java-sdk-secretsmanager</artifactId>
<version>1.11.355 </version>
```

### Gradle:

```
compile group: 'com.amazonaws', name: 'aws-java-sdk-secretsmanager', version:
'1.11.355'
```

## Updating the application.properties file with the details of the secret

```
spring.aws.secretsmanager.secretName=postgres-local
spring.aws.secretsmanager.endpoint=secretsmanager.us-east-1.amazonaws.com
spring.aws.secretsmanager.region=us-east-1
```

## Updating the DB credentials retrieval code in Java

```
String secretName = env.getProperty("spring.aws.secretsmanager.secretName");
String endpoints = env.getProperty("spring.aws.secretsmanager.endpoint");
String AWS Region = env.getProperty("spring.aws.secretsmanager.region");
AwsClientBuilder.EndpointConfiguration config = new
    AwsClientBuilder.EndpointConfiguration(endpoints, AWS Region);
AWSSecretsManagerClientBuilder clientBuilder =
    AWSSecretsManagerClientBuilder.standard();
clientBuilder.setEndpointConfiguration(config);
AWSSecretsManager client = clientBuilder.build();

ObjectMapper objectMapper = new ObjectMapper();

JsonNode secretsJson = null;

ByteBuffer binarySecretData;

GetSecretValueRequest getSecretValueRequest = new
    GetSecretValueRequest().withSecretId(secretName);

GetSecretValueResult getSecretValueResponse = null;

try {
    getSecretValueResponse = client.getSecretValue(getSecretValueRequest);
}
```

```
catch (ResourceNotFoundException e) {
    log.error("The requested secret " + secretName + " was not found");
}

catch (InvalidRequestException e) {
    log.error("The request was invalid due to: " + e.getMessage());
}

catch (InvalidParameterException e) {
    log.error("The request had invalid params: " + e.getMessage());
}
if (getSecretValueResponse == null) {
    return null;
} // Decrypted secret using the associated KMS key // Depending on whether the
secret was a string or binary, one of these fields will be populated

String secret = getSecretValueResponse.getSecretString();

if (secret != null) {
    try {
        secretsJson = objectMapper.readTree(secret);
    }

    catch (IOException e) {
        log.error("Exception while retrieving secret values: " +
e.getMessage());
    }
}

else {
    log.error("The Secret String returned is null");

    return null;

}
String host = secretsJson.get("host").textValue();
String port = secretsJson.get("port").textValue();
String dbname = secretsJson.get("dbname").textValue();
String username = secretsJson.get("username").textValue();
String password = secretsJson.get("password").textValue();
}
```

# Monitor ElastiCache clusters for security groups

Created by Susanne Kangnoh (AWS) and Archit Mathur (AWS)

**Environment:** Production

**Technologies:** Security, identity, compliance; Databases; Infrastructure; CloudNative

**AWS services:** Amazon SNS; AWS CloudTrail; Amazon CloudWatch; Amazon ElastiCache

## Summary

Amazon ElastiCache is an Amazon Web Services (AWS) service that provides a high-performance, scalable, and cost-effective caching solution for distributing an in-memory data store or cache environment in the cloud. It retrieves data from high-throughput and low-latency, in-memory data stores. This functionality makes it a popular choice for real-time use cases such as caching, session stores, gaming, geo-spatial services, real-time analytics, and queuing. ElastiCache offers Redis and Memcached data stores, both of which provide sub-millisecond response times.

A *security group* acts as a virtual firewall for your ElastiCache instances by controlling inbound and outbound traffic. Security groups act at the instance level, not at the subnet level. For each security group, you add one set of rules that control the inbound traffic to instances, and a separate set of rules that control the outbound traffic. You can specify allow rules but not deny rules.

This pattern provides a security control that monitors for API calls and generates an event in Amazon CloudWatch Events on the **CreateReplicationGroup**, **CreateCacheCluster**, **ModifyCacheCluster**, and **ModifyReplicationGroup** operations. This event calls an AWS Lambda function, which runs a Python script. The function gets the replication group ID from the event JSON input, and performs the following checks to determine whether there's a security violation:

- Checks if the security group of the cluster matches the security group that's configured in the Lambda function.
- If the security group of the cluster doesn't match, the function sends a violation message to an email address you provide, by using an Amazon Simple Notification Service (Amazon SNS) notification.

## Prerequisites and limitations

### Prerequisites

- An active AWS account.
- An Amazon Simple Storage Service (Amazon S3) bucket to upload the provided Lambda code.
- An email address where you would like to receive violation notifications.
- ElastiCache logging enabled, for access to all the API logs.

### Limitations

- This detective control is regional and must be deployed in each AWS Region that you want to monitor.
- The control supports replication groups that are running in a virtual private cloud (VPC).

## Architecture

### Workflow architecture

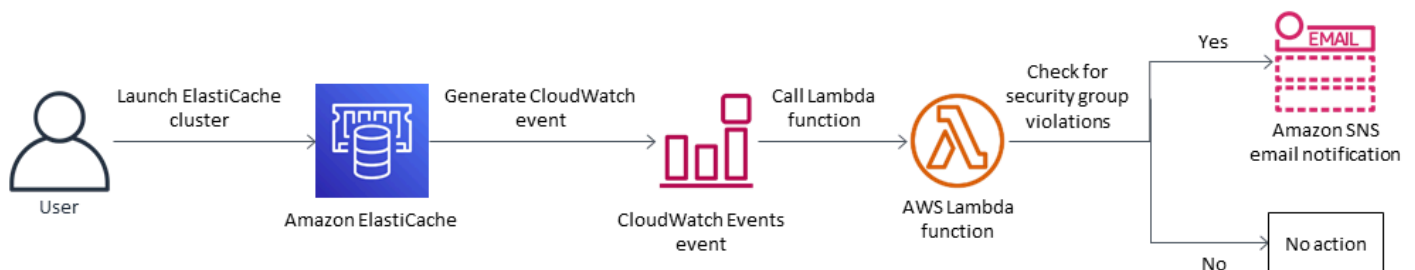

### Automation and scale

- If you are using AWS Organizations, you can use [AWS CloudFormation StackSets](#) to deploy this template into multiple accounts that you want to monitor.

## Tools

### AWS services

- [Amazon ElastiCache](#) makes it easy to set up, manage, and scale distributed in-memory cache environments in the AWS Cloud. It provides a high performance, resizable, and cost-effective in-memory cache, while removing complexity associated with deploying and managing a distributed cache environment. ElastiCache works with both the Redis and Memcached engines.
- [AWS CloudFormation](#) helps you model and set up your AWS resources, provision them quickly and consistently, and manage them throughout their lifecycle. You can use a template to describe your resources and their dependencies, and launch and configure them together as a stack, instead of managing resources individually. You can manage and provision stacks across multiple AWS accounts and AWS Regions.
- [Amazon CloudWatch Events](#) delivers a near real-time stream of system events that describe changes in AWS resources. CloudWatch Events becomes aware of operational changes as they occur and takes corrective action as necessary, by sending messages to respond to the environment, activating functions, making changes, and capturing state information.
- [AWS Lambda](#) is a compute service that supports running code without provisioning or managing servers. Lambda runs your code only when needed and scales automatically from a few requests per day to thousands per second. You pay only for the compute time that you consume—there is no charge when your code is not running.
- [Amazon Simple Notification Service \(Amazon SNS\)](#) coordinates and manages the sending of messages between publishers and clients, including web servers and email addresses. Subscribers receive all messages published to the topics to which they subscribe, and all subscribers to a topic receive the same messages.

## Code

This pattern includes an attachment with two files:

- `ElastiCacheAllowedSecurityGroup.zip` is a compressed file that includes the security control (Lambda code).
- `ElastiCacheAllowedSecurityGroup.yml` is a CloudFormation template that deploys the security control.

See the *Epics* section for information about how to use these files.

## Epics

### Deploy the security control

Task	Description	Skills required
Upload the code to an S3 bucket.	Create a new S3 bucket or use an existing S3 bucket to upload the attached <code>ElastiCacheAllowedSecurityGroup.zip</code> file (Lambda code). This bucket must be in the same AWS Region as the resources that you want to evaluate.	Cloud architect
Deploy the CloudFormation template.	Open the CloudFormation console in the same AWS Region as the S3 bucket, and deploy the <code>ElastiCacheAllowedSecurityControl.yml</code> file that's provided in the attachment. In the next epic, provide values for the template parameters.	Cloud architect

### Complete the parameters in the CloudFormation template

Task	Description	Skills required
Provide the S3 bucket name.	Enter the name of the S3 bucket that you created or selected in the first epic. This S3 bucket contains the <code>.zip</code> file for the Lambda code and	Cloud architect



Task	Description	Skills required
	must be in the same AWS Region as the CloudFormation template and the resource that will be evaluated.	
Provide the S3 key.	Provide the location of the Lambda code .zip file in your S3 bucket, without leading slashes (for example, ElasticCacheAllowedSecurityGroup.zip or controls/ElasticCacheAllowedSecurityGroup.zip ).	Cloud architect
Provide an email address.	Provide an active email address where you want to receive violation notifications.	Cloud architect
Specify a logging level.	Specify the logging level and verbosity. Info designates detailed informational messages on the application's progress and should be used only for debugging . Error designates error events that could still allow the application to continue running. Warning designates potentially harmful situations.	Cloud architect

## Confirm the subscription

Task	Description	Skills required
Confirm the email subscription.	When the CloudFormation template deploys successfully, it sends a subscription email message to the email address you provided. To receive notifications, you must confirm this email subscription.	Cloud architect

## Related resources

- [Creating a stack on the AWS CloudFormation console](#) (AWS CloudFormation documentation)
- [Amazon VPCs and ElastiCache security](#) (Amazon ElastiCache documentation)

## Attachments

To access additional content that is associated with this document, unzip the following file: [attachment.zip](#)

# Monitor Amazon EMR clusters for in-transit encryption at launch

Created by Susanne Kangnoh (AWS)

**Environment:** Production

**Technologies:** Analytics; Big data; CloudNative; Security, identity, compliance

**Workload:** Open-source

**AWS services:** Amazon EMR; Amazon SNS; AWS CloudTrail; Amazon CloudWatch

## Summary

This pattern provides a security control that monitors Amazon EMR clusters at launch and sends an alert if in-transit encryption hasn't been enabled.

Amazon EMR is a web service that makes it easy for you to run big data frameworks, such as Apache Hadoop, to process and analyze data. Amazon EMR enables you to process vast amounts of data in a cost-effective way by running mapping and reducing steps in parallel.

Data encryption prevents unauthorized users from accessing or reading data at rest or data in transit. *Data at rest* refers to data that is stored in media such as a local file system on each node, Hadoop Distributed File System (HDFS), or the EMR File System (EMRFS) through Amazon Simple Storage Service (Amazon S3). *Data in transit* refers to data that travels the network and is in flight between jobs. In-transit encryption supports open-source encryption features for Apache Spark, Apache TEZ, Apache Hadoop, Apache HBase, and Presto. You enable encryption by creating a security configuration from the AWS Command Line Interface (AWS CLI), the console, or AWS SDKs, and specifying the data encryption settings. You can provide the encryption artifacts for in-transit encryption in these two ways:

- By uploading a compressed file of certificates to Amazon S3.
- By referencing a custom Java class that provides encryption artifacts.

The security control that's included with this pattern monitors API calls and generates an Amazon CloudWatch Events event on the **RunJobFlow** action. The event calls an AWS Lambda function, which runs a Python script. The function gets the EMR cluster ID from the event JSON input, and performs the following checks to determine whether there's a security violation:

- Checks if the EMR cluster has an Amazon EMR-specific security configuration.
- If the cluster does have a security configuration, checks to see if encryption in transit is enabled.
- If the cluster doesn't have a security configuration, sends an alert to an email address that you provide, by using Amazon Simple Notification Service (Amazon SNS). The notification specifies the EMR cluster name, violation details, AWS Region and account information, and the AWS Lambda ARN (Amazon Resource Name) that the notification is sourced from.

## Prerequisites and limitations

### Prerequisites

- An active AWS account.
- An S3 bucket to upload the Lambda code that's provided with this pattern.
- An email address where you would like to receive violation notifications.
- Amazon EMR logging enabled, for access to all the API logs.

### Limitations

- This detective control is regional and must be deployed in each AWS Region that you want to monitor.

### Product versions

- Amazon EMR release 4.8.0 or later.

## Architecture

### Workflow architecture

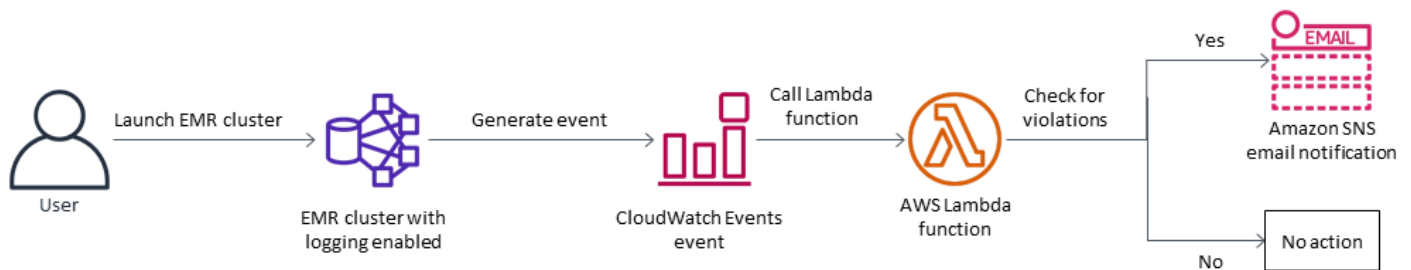

## Automation and scale

- If you are using AWS Organizations, you can use [AWS Cloudformation StackSets](#) to deploy the template in multiple accounts that you want to monitor.

## Tools

### AWS services

- [Amazon EMR](#) – Amazon EMR is a managed cluster platform that simplifies running big data frameworks, such as [Apache Hadoop](#) and [Apache Spark](#), on AWS to process and analyze vast amounts of data. By using these frameworks and related open-source projects, you can process data for analytics purposes and business intelligence workloads. Additionally, you can use Amazon EMR to transform and move large amounts of data into and out of other AWS data stores and databases, such as Amazon S3 and Amazon DynamoDB.
- [AWS Cloudformation](#) – AWS CloudFormation helps you model and set up your AWS resources, provision them quickly and consistently, and manage them throughout their lifecycle. You can use a template to describe your resources and their dependencies, and launch and configure them together as a stack, instead of managing resources individually. You can manage and provision stacks across multiple AWS accounts and AWS Regions.
- [AWS Cloudwatch Events](#) – Amazon CloudWatch Events delivers a near real-time stream of system events that describe changes in AWS resources. CloudWatch Events becomes aware of operational changes as they occur and takes corrective action as necessary, by sending messages to respond to the environment, activating functions, making changes, and capturing state information.
- [AWS Lambda](#) – AWS Lambda is a compute service that supports running code without provisioning or managing servers. Lambda runs your code only when needed and scales

automatically from a few requests per day to thousands per second. You pay only for the compute time that you consume—there is no charge when your code is not running.

- [AWS SNS](#) – Amazon Simple Notification Service (Amazon SNS) coordinates and manages the sending of messages between publishers and clients, including web servers and email addresses. Subscribers receive all messages published to the topics to which they subscribe, and all subscribers to a topic receive the same messages.

## Code

This pattern includes an attachment with two files:

- `EMRInTransitEncryption.zip` is a compressed file that includes the security control (Lambda code).
- `EMRInTransitEncryption.yml` is a CloudFormation template that deploys the security control.

See the *Epics* section for information about how to use these files.

## Epics

### Deploy the security control

Task	Description	Skills required
Upload the code to an S3 bucket.	Create a new S3 bucket or use an existing S3 bucket to upload the attached <code>EMRInTransitEncryption.zip</code> file (Lambda code). This bucket must be in the same AWS Region as the CloudFormation template and the resources that you want to evaluate.	Cloud architect
Deploy the CloudFormation template.	Open the Cloudformation console in the same AWS	Cloud architect,

Task	Description	Skills required
	Region as the S3 bucket, and deploy the EMRIInTransitEncryption.yml file that's provided in the attachment. In the next epic, provide values for the template parameters.	

### Complete the parameters in the CloudFormation template

Task	Description	Skills required
Provide the S3 bucket name.	Enter the name of the S3 bucket that you created or selected in the first epic. This S3 bucket contains the .zip file for the Lambda code and must be in the same AWS Region as the CloudFormation template and the resource that will be evaluated.	Cloud architect
Provide the S3 key.	Specify the location of the Lambda code .zip file in your S3 bucket, without leading slashes (for example, EMRIInTransitEncryption.zip or controls/EMRIInTransitEncryption.zip ).	Cloud architect
Provide an email address.	Specify an active email address where you want to	Cloud architect

Task	Description	Skills required
	receive violation notifications.	
Specify a logging level.	Specify the logging level and verbosity for the Lambda logs. Info designates detailed informational messages on the application's progress and should be used only for debugging. Error designates error events that could still allow the application to continue running. Warning designates potentially harmful situations.	Cloud architect

## Confirm the subscription

Task	Description	Skills required
Confirm the email subscription.	When the CloudFormation template deploys successfully, it sends a subscription email message to the email address you provided. To receive notifications, you must confirm this email subscription.	Cloud architect

## Related resources

- [Creating a stack on the AWS CloudFormation console](#) (AWS CloudFormation documentation)



- [Encryption options](#) (Amazon EMR documentation)

## Attachments

To access additional content that is associated with this document, unzip the following file:  
[attachment.zip](#)

# Monitor Amazon ElastiCache clusters for at-rest encryption

Created by Susanne Kangnoh (AWS)

**Environment:** Production

**Technologies:** Security, identity, compliance; Databases; Infrastructure; CloudNative

**Workload:** Open-source

**AWS services:** Amazon SNS; Amazon CloudWatch; Amazon ElastiCache

## Summary

Amazon ElastiCache is an Amazon Web Services (AWS) service that provides a high-performance, scalable, and cost-effective caching solution for distributing an in-memory data store or cache environment in the cloud. It retrieves data from high-throughput and low-latency, in-memory data stores. This functionality makes it a popular choice for real-time use cases such as caching, session stores, gaming, geo-spatial services, real-time analytics, and queuing. ElastiCache offers Redis and Memcached data stores, both of which provide sub-millisecond response times.

Data encryption helps prevent unauthorized users from reading sensitive data available on your Redis clusters and their associated cache storage systems. This includes data saved to persistent media, known as *data at rest*, and data that can be intercepted as it travels through the network between clients and cache servers, known as *data in transit*.

You can enable at-rest encryption for ElastiCache for Redis when you create a replication group, by setting the **AtRestEncryptionEnabled** parameter to **true**. When this parameter is enabled, it encrypts the disk during sync, backup, and swap operations, and encrypts backups stored in Amazon Simple Storage Service (Amazon S3). You cannot enable at-rest encryption on an existing replication group. When you create a replication group, you can enable encryption at rest in these two ways:

- By choosing the **Default** option, which uses service-managed encryption at rest.
- By using a customer managed key and providing the key ID or Amazon Resource Name (ARN) from AWS Key Management Service (AWS KMS).

This pattern provides a security control that monitors for API calls and generates an Amazon CloudWatch Events event on the **CreateReplicationGroup** operation. This event calls an AWS Lambda function, which runs a Python script. The function gets the replication group ID from the event JSON input, and performs the following checks to determine whether there's a security violation:

- Checks if the **AtRestEncryptionEnabled** key exists.
- If **AtRestEncryptionEnabled** exists, checks the value to see if it is **true**.
- If the **AtRestEncryptionEnabled** value is set to **false**, sets a variable that tracks violations and sends a violation message to an email address you provide, by using an Amazon Simple Notification Service (Amazon SNS) notification.

## Prerequisites and limitations

### Prerequisites

- An active AWS account.
- An S3 bucket to upload the provided Lambda code.
- An email address where you would like to receive violation notifications.
- ElastiCache logging enabled, for access to all the API logs.

### Limitations

- This detective control is regional and must be deployed in each AWS Region that you want to monitor.
- The control supports replication groups that are running in a virtual private cloud (VPC).
- The control supports replication groups that are running the following node types:
  - R5, R4, R3
  - M5, M4, M3
  - T3, T2

### Product versions

- ElastiCache for Redis version 3.2.6 or later

# Architecture

## Workflow architecture

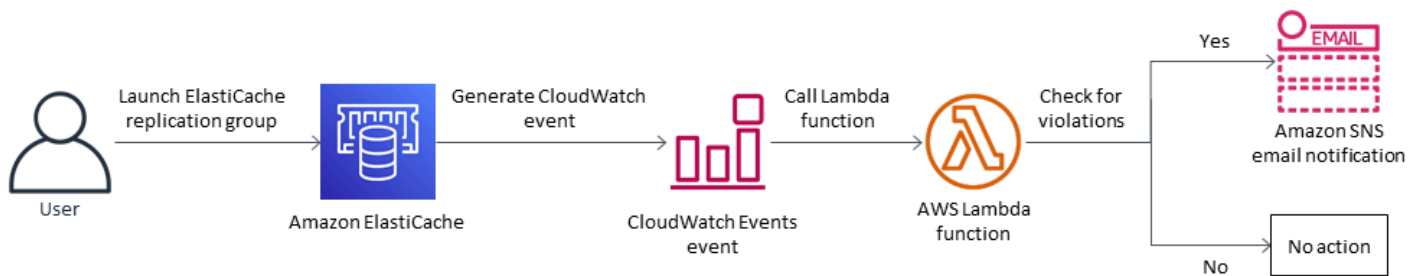

## Automation and scale

- If you are using AWS Organizations, you can use [AWS Cloudformation StackSets](#) to deploy this template in multiple accounts that you want to monitor.

## Tools

### AWS services

- [Amazon ElastiCache](#) – Amazon ElastiCache makes it easy to set up, manage, and scale distributed in-memory cache environments in the AWS Cloud. It provides a high performance, resizable, and cost-effective in-memory cache, while removing complexity associated with deploying and managing a distributed cache environment. ElastiCache works with both the Redis and Memcached engines.
- [AWS CloudFormation](#) – AWS CloudFormation helps you model and set up your AWS resources, provision them quickly and consistently, and manage them throughout their lifecycle. You can use a template to describe your resources and their dependencies, and launch and configure them together as a stack, instead of managing resources individually. You can manage and provision stacks across multiple AWS accounts and AWS Regions.
- [AWS Cloudwatch Events](#) – Amazon CloudWatch Events delivers a near real-time stream of system events that describe changes in AWS resources. CloudWatch Events becomes aware of operational changes as they occur and takes corrective action as necessary, by sending messages to respond to the environment, activating functions, making changes, and capturing state information.

- [AWS Lambda](#) – AWS Lambda is a compute service that supports running code without provisioning or managing servers. Lambda runs your code only when needed and scales automatically from a few requests per day to thousands per second. You pay only for the compute time that you consume—there is no charge when your code is not running.
- [Amazon SNS](#) – Amazon Simple Notification Service (Amazon SNS) coordinates and manages the sending of messages between publishers and clients, including web servers and email addresses. Subscribers receive all messages published to the topics to which they subscribe, and all subscribers to a topic receive the same messages.

## Code

This pattern includes an attachment with two files:

- `ElasticCache-EncryptionAtRest.zip` is a compressed file that includes the security control (Lambda code).
- `elasticache_encryption_at_rest.yml` is a CloudFormation template that deploys the security control.

See the *Epics* section for information about how to use these files.

## Epics

### Deploy the security control

Task	Description	Skills required
Upload the code to an S3 bucket.	Create a new S3 bucket or use an existing S3 bucket to upload the attached <code>ElasticCache-EncryptionAtRest.zip</code> file (Lambda code). This bucket must be in the same AWS Region as the resources that you want to evaluate.	Cloud architect

Task	Description	Skills required
Deploy the CloudFormation template.	Open the CloudFormation console in the same AWS Region as the S3 bucket, and deploy the <code>elasticache_encryption_at_rest.yml</code> file that's provided in the attachment. In the next epic, provide values for the template parameters.	Cloud architect

### Complete the parameters in the CloudFormation template

Task	Description	Skills required
Provide the S3 bucket name.	Enter the name of the S3 bucket that you created or selected in the first epic. This S3 bucket contains the .zip file for the Lambda code and must be in the same AWS Region as the CloudFormation template and the resource that will be evaluated.	Cloud architect
Provide the S3 key.	Provide the location of the Lambda code .zip file in your S3 bucket, without leading slashes (for example, <code>ElasticCache-EncryptionAtRest.zip</code> or <code>controls/ElasticCache-EncryptionAtRest.zip</code> ).	Cloud architect

Task	Description	Skills required
Provide an email address.	Provide an active email address where you want to receive violation notifications.	Cloud architect
Specify a logging level.	Specify the logging level and verbosity. <code>Info</code> designates detailed informational messages on the application's progress and should be used only for debugging. <code>Error</code> designates error events that could still allow the application to continue running. <code>Warning</code> designates potentially harmful situations.	Cloud architect

## Confirm the subscription

Task	Description	Skills required
Confirm the email subscription.	When the CloudFormation template deploys successfully, it sends a subscription email message to the email address you provided. To receive notifications, you must confirm this email subscription.	Cloud architect

## Related resources

- [Creating a stack on the AWS CloudFormation console](#) (AWS CloudFormation documentation)
- [At-Rest Encryption in ElastiCache for Redis](#) (Amazon ElastiCache documentation)

## Attachments

To access additional content that is associated with this document, unzip the following file:  
[attachment.zip](#)



# Monitor EC2 instance key pairs using AWS Config

*Created by Wassim Benhallam (AWS), Sergio Bilbao Lopez (AWS), and Vikrant Telkar (AWS)*

**Environment:** Production

**Technologies:** Security, identity, compliance

**AWS services:** Amazon SNS; AWS Config; AWS Lambda

## Summary

When launching an Amazon Elastic Compute Cloud (Amazon EC2) instance on the Amazon Web Services (AWS) Cloud, a best practice is to create or use an existing key pair to connect to the instance. The key pair, which consists of a public key stored in the instance and a private key provided to the user, allows secure access through Secure Shell (SSH) to the instance and avoids the use of passwords. However, users can sometimes inadvertently launch instances without attaching a key pair. Because key pairs can be assigned only during the launch of an instance, it's important to quickly identify and flag as noncompliant any instances launched without key pairs. This is particularly useful when working in accounts or environments that mandate the use of key pairs for instance access.

This pattern describes how to create a custom rule in AWS Config to monitor EC2 instance key pairs. When instances are identified as noncompliant, an alert is sent using Amazon Simple Notification Service (Amazon SNS) notifications initiated through an Amazon EventBridge event.

## Prerequisites and limitations

### Prerequisites

- An active AWS account
- AWS Config enabled for the AWS Region you want to monitor and configured to record all AWS resources

### Limitations

- This solution is Region-specific. All resources should be created in the same AWS Region.

# Architecture

## Target technology stack

- AWS Config
- Amazon EventBridge
- AWS Lambda
- Amazon SNS

## Target architecture

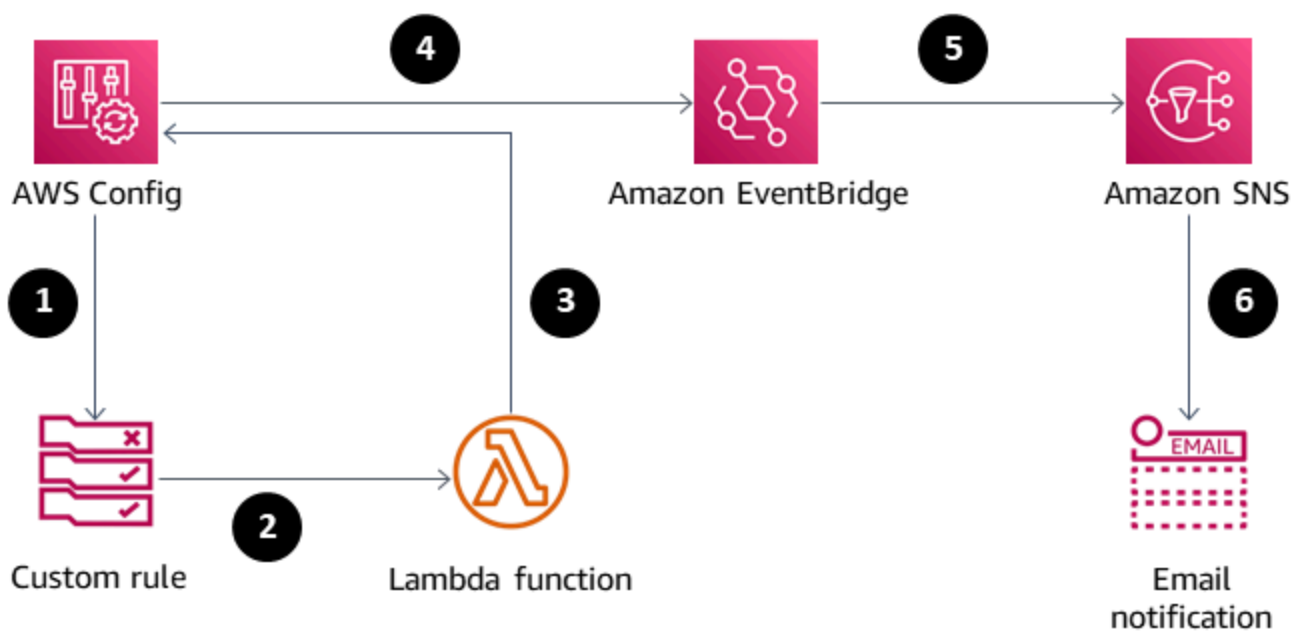

1. AWS Config initiates the rule.
2. The rule invokes the Lambda function to evaluate compliance of EC2 instances.
3. The Lambda function sends the updated compliance state to AWS Config.
4. AWS Config sends an event to EventBridge.
5. EventBridge publishes compliance change notifications to an SNS topic.
6. Amazon SNS sends an alert in email.

## Automation and scale

The solution can monitor any number of EC2 instances within a Region.

## Tools

### Tools

- [AWS Config](#) – AWS Config is a service that enables you to assess, audit, and evaluate the configurations of your AWS resources. AWS Config continuously monitors and records your AWS resource configurations and allows you to automate the evaluation of recorded configurations against desired configurations.
- [Amazon EventBridge](#) – Amazon EventBridge is a serverless event bus service for connecting your applications with data from a variety of sources.
- [AWS Lambda](#) – AWS Lambda is a serverless compute service that supports running code without provisioning or managing servers, creating workload-aware cluster scaling logic, maintaining event integrations, or managing runtimes.
- [Amazon SNS](#) – Amazon Simple Notification Service (Amazon SNS) is a fully managed messaging service for both application-to-application (A2A) and application-to-person (A2P) communication.

### Code

The code for the Lambda function is attached.

## Epics

### Create a Lambda function to evaluate Amazon EC2 compliance

Task	Description	Skills required
Create an AWS Identity and Access Management (IAM) role for Lambda.	On the AWS Management Console, choose <b>IAM</b> , and then create the role, using Lambda as the trusted entity and adding the <code>AmazonEventBridgeFullAccess</code> and <code>AWSConfigRulesExecutionRole</code> permissions. For more information, see the <a href="#">AWS documentation</a> .	DevOps

Task	Description	Skills required
Create and deploy the Lambda function.	<ol style="list-style-type: none"> <li>1. On the Lambda console, create a function, using <b>Author from scratch</b>, with <b>Python 3.6</b> as the runtime and the previously created IAM role. Note the Amazon Resource Name (ARN).</li> <li>2. On the <b>Code</b> tab, choose <code>lambda_function.py</code> , and paste the code that is attached to this pattern.</li> <li>3. To save your changes, choose <b>Deploy</b>.</li> </ol>	DevOps

### Create a custom AWS Config rule

Task	Description	Skills required
Add a custom AWS Config rule.	<p>On the AWS Config console, add a custom rule, using the following settings:</p> <ul style="list-style-type: none"> <li>• ARN – The ARN of the previously created Lambda function</li> <li>• Trigger type – Configuration changes</li> <li>• Scope of changes – Resources</li> <li>• Resource type – Amazon EC2 instance</li> </ul>	DevOps

Task	Description	Skills required
	For more information, see the <a href="#">AWS documentation</a> .	

## Configure email notifications when a compliance change event is detected

Task	Description	Skills required
Create the SNS topic and subscription.	<p>On the Amazon SNS console, create a topic using <b>Standard</b> as the type, and then create a subscription using <b>Email</b> as the protocol.</p> <p>When you receive the confirmation email message, choose the link to confirm the subscription.</p> <p>For more information, see the <a href="#">AWS documentation</a>.</p>	DevOps
Create an EventBridge rule to initiate Amazon SNS notifications.	<p>On the EventBridge console, create a rule, using the following settings:</p> <ul style="list-style-type: none"> <li>• Service name – AWS Config</li> <li>• Event type – Config Rules Compliance Change</li> <li>• Message type – Specific message types, ComplianceChangeNotification</li> <li>• Specific rule name – The name of your previously created AWS Config rule</li> </ul>	DevOps

Task	Description	Skills required
	<ul style="list-style-type: none"> <li>Target – SNS topic, your previously created topic</li> </ul> <p>For more information, see the <a href="#">AWS documentation</a>.</p>	

## Verify the rule and notifications

Task	Description	Skills required
Create EC2 instances.	Create two EC2 instances of any type and attach a key pair, and create one EC2 instance without a key pair.	DevOps
Verify the rule.	<ol style="list-style-type: none"> <li>On the AWS Config console, on the <b>Rules</b> page, select your rule.</li> <li>To see compliant and noncompliant EC2 instances, change <b>Resources in scope</b> to <b>All</b>. Verify that two instances are listed as compliant and that one instance is listed as noncompliant.</li> <li>Wait to receive Amazon SNS email notification regarding the compliance state of the EC2 instances.</li> </ol>	DevOps

## Related resources

- [Creating a role to delegate permissions to an AWS service](#)
- [Creating a custom rule in AWS Config](#)
- [Creating an Amazon SNS topic](#)
- [Subscribing to an Amazon SNS topic](#)
- [Create a rule in Amazon EventBridge](#)

## Attachments

To access additional content that is associated with this document, unzip the following file:  
[attachment.zip](#)

# Monitor IAM root user activity

Created by Mostefa Brougui (AWS)

**Code repository:** [aws-iam-root-user-activity-monitor](#)

**Environment:** PoC or pilot

**Technologies:** Security, identity, compliance; Management & governance

**Workload:** All other workloads

**AWS services:** Amazon EventBridge; AWS Lambda; Amazon SNS; AWS Identity and Access Management

## Summary

Every Amazon Web Services (AWS) account has a root user. As a [security best practice](#) for AWS Identity and Access Management (IAM), we recommend that you use the root user to complete the tasks that only the root user can perform. For the complete list, see [Tasks that require root user credentials](#) in the *AWS Account Management Reference Guide*. Because the root user has full access to all of your AWS resources and billing information, we recommend that you don't use this account and monitor it for any activity, which might indicate that the root user credentials have been compromised.

Using this pattern, you set up an [event-driven architecture](#) that monitors the IAM root user. This pattern sets up a hub-and-spoke solution that monitors multiple AWS accounts, the *spoke* accounts, and centralizes management and reporting in a single account, the *hub* account.

When the IAM root user credentials are used, Amazon CloudWatch and AWS CloudTrail record the activity in the log and trail, respectively. In the spoke account, an Amazon EventBridge rule sends the event to the central [event bus](#) in the hub account. In the hub account, an EventBridge rule sends the event to an AWS Lambda function. The function uses an Amazon Simple Notification Service (Amazon SNS) topic that notifies you of the root user activity.

In this pattern, you use an AWS CloudFormation template to deploy the monitoring and event-handling services in the spoke accounts. You use a HashiCorp Terraform template to deploy the event-management and notification services in the hub account.



## Prerequisites and limitations

### Prerequisites

1. Permissions to deploy AWS resources in your AWS environment.
2. Permissions to deploy CloudFormation stack sets. For more information, see [Prerequisites for stack set operations](#) (CloudFormation documentation).
3. Terraform installed and ready to use. For more information, see [Get Started – AWS](#) (Terraform documentation).
4. An existing trail in each spoke account. For more information, see [Getting started with AWS CloudTrail](#) (CloudTrail documentation).
5. The trail is configured to send events to CloudWatch Logs. For more information, see [Sending events to CloudWatch Logs](#) (CloudTrail documentation).
6. Your hub and spoke accounts must be managed by AWS Organizations.

### Architecture

The following diagram illustrates the building blocks of the implementation.

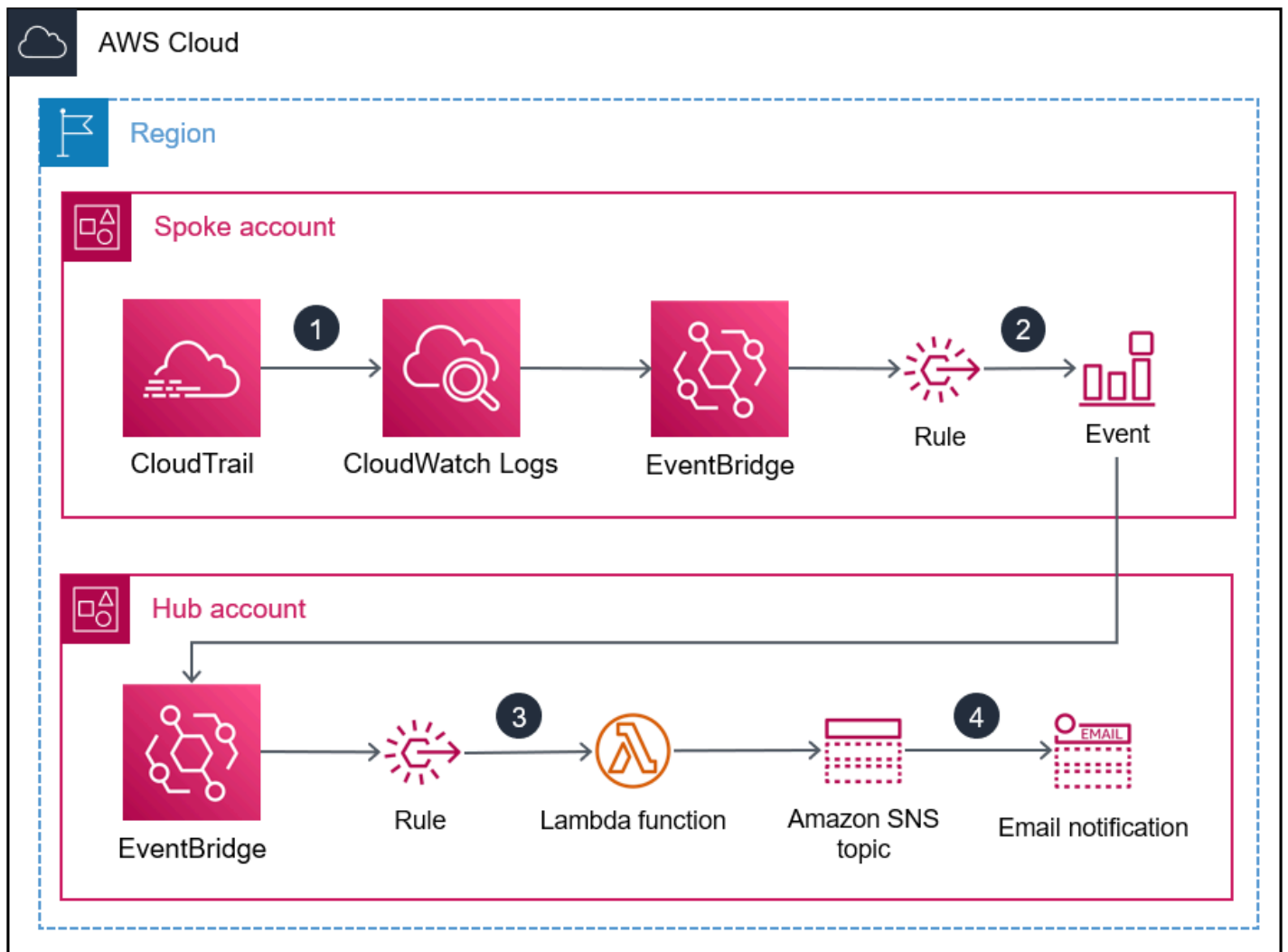

1. When the IAM root user credentials are used, CloudWatch and CloudTrail record the activity in the log and trail, respectively.
2. In the spoke account, an EventBridge rule sends the event to the central [event bus](#) in the hub account.
3. In the hub account, an EventBridge rule sends the event to a Lambda function.
4. The Lambda function uses an Amazon SNS topic that notifies you of the root user activity.

## Tools

### AWS services

- [AWS CloudFormation](#) helps you set up AWS resources, provision them quickly and consistently, and manage them throughout their lifecycle across AWS accounts and Regions.
- [AWS CloudTrail](#) helps you audit the governance, compliance, and operational risk of your AWS account.
- [Amazon CloudWatch Logs](#) helps you centralize the logs from all your systems, applications, and AWS services so you can monitor them and archive them securely.
- [Amazon EventBridge](#) is a serverless event bus service that helps you connect your applications with real-time data from a variety of sources. For example, AWS Lambda functions, HTTP invocation endpoints using API destinations, or event buses in other AWS accounts.
- [AWS Identity and Access Management \(IAM\)](#) helps you securely manage access to your AWS resources by controlling who is authenticated and authorized to use them.
- [AWS Lambda](#) is a compute service that helps you run code without needing to provision or manage servers. It runs your code only when needed and scales automatically, so you pay only for the compute time that you use.
- [Amazon Simple Notification Service \(Amazon SNS\)](#) helps you coordinate and manage the exchange of messages between publishers and clients, including web servers and email addresses.

## Other tools and services

- [Terraform](#) is a CLI application for provisioning and managing cloud infrastructure and resources by using code, in the form of configuration files.

## Code repository

The source code and templates for this pattern are available in a [GitHub repository](#). This pattern provides two templates:

- A Terraform template containing the resources you deploy in the hub account
- A CloudFormation template you deploy as a stack set instance in the spoke accounts

The repository has the following overall structure.

```
.  
|__README.md  
|__spoke-stackset.yaml
```

```

|__hub.tf
|__root-activity-monitor-module
  |__main.tf # contains Terraform code to deploy resources in the Hub account
  |__iam     # contains IAM policies JSON files
    |__ lambda-assume-policy.json          # contains trust policy of the IAM role
used by the Lambda function
    |__ lambda-policy.json                # contains the IAM policy attached to
the IAM role used by the Lambda function
  |__outputs # contains Lambda function zip code

```

The *Epics* section provides step-by-step instructions for deploying the templates.

## Epics

### Deploy resources to the hub account

Task	Description	Skills required
Clone the sample code repository.	<ol style="list-style-type: none"> <li>1. Open the <a href="#">AWS IAM Root User Activity Monitor</a> repository.</li> <li>2. On the Code tab, above the file list, choose <b>Code</b>, and then copy the HTTPS URL.</li> <li>3. In a command-line interface, change your working directory to the location where you want to store the sample files.</li> <li>4. Enter the following command: <div style="border: 1px solid #ccc; border-radius: 10px; padding: 5px; margin: 10px 0;"> <pre>git clone &lt;repoURL&gt;</pre> </div> </li> </ol>	General AWS
Update the Terraform template.	<ol style="list-style-type: none"> <li>1. Retrieve your organization ID. For instructions, see <a href="#">Viewing the details of an organization from</a></li> </ol>	General AWS

Task	Description	Skills required
	<p><a href="#">the management account</a> (AWS Organizations documentation).</p> <ol style="list-style-type: none"><li>In the cloned repository, open <code>hub.tf</code>.</li><li>Update the following with the appropriate values for your environment:<ul style="list-style-type: none"><li><code>OrganizationId</code> – Add your organization ID.</li><li><code>SNSTopicName</code> – Add a name for the Amazon SNS topic.</li><li><code>SNSSubscriptions</code> – Add the email to which Amazon SNS notifications should be sent.</li><li><code>Region</code> – Add the AWS Region code where you are deploying the resources. For example, <code>eu-west-1</code>.</li><li><code>Tags</code> – Add your tags. For more information, see <a href="#">Tagging AWS resources</a> (AWS General Reference).</li></ul></li><li>Save and close the <code>hub.tf</code> file.</li></ol>	

Task	Description	Skills required
Deploy the resources to the AWS hub account.	<ol style="list-style-type: none"> <li>In the Terraform command-line interface, navigate to the root folder of the cloned repository, and then enter the following command. <div style="border: 1px solid #ccc; border-radius: 10px; padding: 5px; margin: 10px 0;"> <pre>terraform init &amp;&amp; terraform plan</pre> </div> </li> <li>Review the output and confirm you want to create the resources described.</li> <li>Enter the following command. <div style="border: 1px solid #ccc; border-radius: 10px; padding: 5px; margin: 10px 0;"> <pre>terraform apply</pre> </div> </li> <li>When prompted, confirm the deployment by entering yes.</li> </ol>	General AWS

## Deploy resources to your spoke accounts

Task	Description	Skills required
Deploy the CloudFormation template.	<ol style="list-style-type: none"> <li>Sign in to the AWS Management Console, and open the <a href="#">CloudFormation console</a>.</li> <li>From the navigation pane, choose <b>StackSets</b>.</li> </ol>	General AWS

Task	Description	Skills required
	<ol style="list-style-type: none"><li>3. At the top of the <b>StackSets</b> page, choose <b>Create StackSet</b>.</li><li>4. Under <b>Permissions</b>, choose <b>Service-managed permissions</b>. CloudFormation automatically configures the permissions required to deploy to the target accounts managed by AWS Organizations.</li><li>5. Under <b>Prerequisite - Prepare template</b>, choose <b>Template is ready</b>.</li><li>6. Under <b>Specify Template</b>, choose <b>Upload a template file</b>.</li><li>7. Choose <b>Choose file</b>, and then in the cloned repository, select <code>spoke-stackset.yaml</code>.</li><li>8. Choose <b>Next</b>.</li><li>9. On the <b>Specify StackSet details</b> page, enter a name for the stack set.</li><li>10. Under <b>Parameters</b>, enter the account ID of the hub account, and then choose <b>Next</b>.</li><li>11. On the <b>Configure StackSet options</b> page, under <b>Tags</b>, add your tags.</li></ol>	

Task	Description	Skills required
	<p>12 Under <b>Execution configuration</b>, choose <b>Inactive</b>, and then choose <b>Next</b>.</p> <p>13 On the <b>Set deployment options</b> page, specify the organizational units and Regions where you want to deploy the stack set, then choose <b>Next</b>.</p> <p>14 On the Review page, select <b>I acknowledge that AWS CloudFormation might create IAM resources</b>, and then choose <b>Submit</b>. CloudFormation starts deploying your stack set.</p> <p>For more information and instructions, see <a href="#">Create a stack set</a> (CloudFormation documentation).</p>	

### (Optional) Test the notifications

Task	Description	Skills required
Use the root user credentials.	<ol style="list-style-type: none"> <li>1. Sign into a spoke account or the hub account by using the root user credentials.</li> <li>2. Confirm that the email account you specified</li> </ol>	General AWS



Task	Description	Skills required
	receives the Amazon SNS notification.	

## Related resources

- [Security best practices](#) (IAM documentation)
- [Working with StackSets](#) (CloudFormation documentation)
- [Get Started](#) (Terraform documentation)

## Additional information

[Amazon GuardDuty](#) is a continuous security monitoring service that analyzes and processes logs to identify unexpected and potentially unauthorized activity in your AWS environment. As an alternative to this solution, if you have enabled GuardDuty, it can alert you when the root user credentials have been used. The GuardDuty finding is `Policy:IAMUser/RootCredentialUsage`, and the default severity is **Low**. For more information, see [Managing Amazon GuardDuty findings](#).

# Send a notification when an IAM user is created

Created by Mansi Suratwala (AWS) and Sergiy Shevchenko (AWS)

<b>Environment:</b> Production	<b>Technologies:</b> Security, identity, compliance; Infrastructure	<b>Workload:</b> All other workloads
<b>AWS services:</b> Amazon SNS; AWS Identity and Access Management; AWS Lambda; Amazon CloudWatch		

## Summary

On Amazon Web Services (AWS), you can use this pattern to deploy an AWS CloudFormation template to receive notifications automatically when AWS Identity and Access Management (IAM) users are created.

Using IAM, you can manage access to AWS services and resources securely. You can create and manage AWS users and groups, and use permissions to allow and deny those users and groups access to AWS resources.

The CloudFormation template creates an Amazon CloudWatch Events event and an AWS Lambda function. The event uses AWS CloudTrail to monitor for any IAM user being created in the AWS account. If a user is created, the CloudWatch Events event initiates a Lambda function, which sends you an Amazon Simple Notification Service (Amazon SNS) notification informing you of the new user creation event.

## Prerequisites and limitations

### Prerequisites

- An active AWS account
- An AWS CloudTrail trail created and deployed

### Limitations

- The AWS CloudFormation template must be deployed for CreateUser only.

## Architecture

### Target technology stack

- IAM
- AWS CloudTrail
- Amazon CloudWatch Events
- AWS Lambda
- Amazon Simple Storage Service (Amazon S3)
- Amazon SNS

### Target architecture

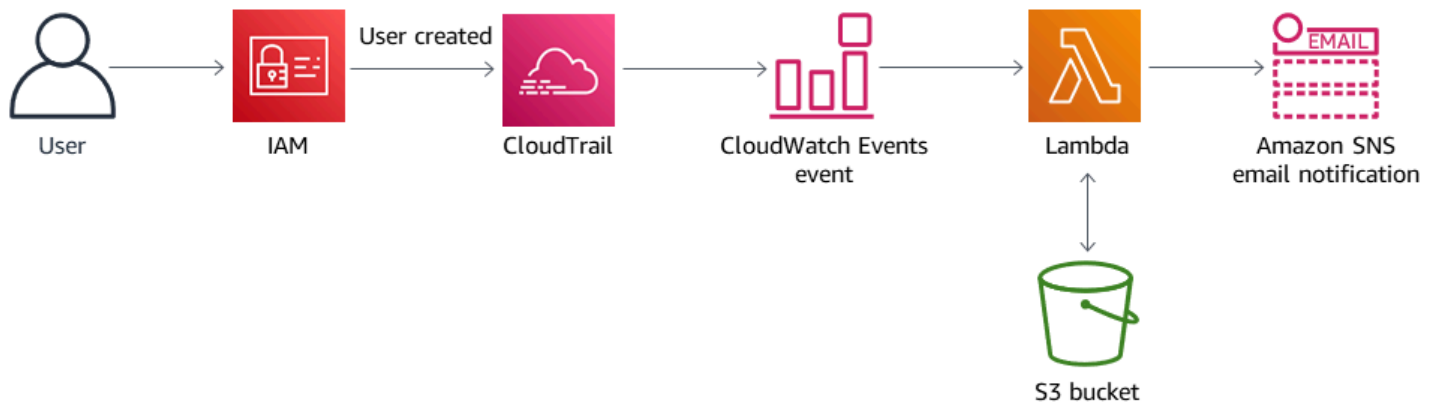

### Automation and scale

You can use the AWS CloudFormation template multiple times for different AWS Regions and accounts. You need to run it only once in each Region or account. To automate deployment to multiple accounts, use [AWS CloudFormation StackSets](#). The CloudFormation template will be able to deploy all the required resources in each account.

## Tools

### Tools

- [IAM](#) – AWS Identity and Access Management (IAM) is a web service that helps you securely control access to AWS resources. You use IAM to control who is authenticated (signed in) and authorized (has permissions) to use resources.
- [AWS CloudFormation](#) – AWS CloudFormation helps you model and set up your Amazon Web Services resources so that you can spend less time managing those resources and more time focusing on your applications that run in AWS. You create a template that describes all the AWS resources that you want, and CloudFormation takes care of provisioning and configuring those resources for you.
- [AWS CloudTrail](#) – AWS CloudTrail helps you manage governance, compliance, and operational and risk auditing of your AWS account. Actions taken by a user, a role, or an AWS service are recorded as events in CloudTrail. Events include actions taken in the AWS Management Console, AWS Command Line Interface, and AWS SDKs and APIs.
- [Amazon CloudWatch Events](#) – Amazon CloudWatch Events delivers a near-real-time stream of system events that describe changes in AWS resources.
- [AWS Lambda](#) – AWS Lambda is a compute service that supports running code without provisioning or managing servers. Lambda runs your code only when needed and scales automatically, from a few requests per day to thousands per second.
- [Amazon S3](#) – Amazon Simple Storage Service (Amazon S3) is storage for the internet. You can use Amazon S3 to store and retrieve any amount of data at any time, from anywhere on the web.
- [Amazon SNS](#) – Amazon Simple Notification Service (Amazon SNS) is a managed service that provides message delivery using Lambda, HTTP, email, mobile push notifications, and mobile text messages (SMS).

## Code

A .zip file of the project is available as an attachment.

## Epics

### Create the S3 bucket for the Lambda script

Task	Description	Skills required
Define the S3 bucket.	Open the Amazon S3 console, and choose or create an S3	Cloud architect

Task	Description	Skills required
	bucket. This S3 bucket will host the Lambda code .zip file. The S3 bucket name cannot contain leading slashes.	

### Upload the Lambda code to the S3 bucket

Task	Description	Skills required
Upload the Lambda code.	Upload the Lambda code .zip file provided in the <i>Attachments</i> section to the S3 bucket that you defined.	Cloud architect

### Deploy the CloudFormation template

Task	Description	Skills required
Deploy the CloudFormation template.	On the CloudFormation console, deploy the CloudFormation <code>createIAMUser.yaml</code> template that's provided as an attachment to this pattern. In the next epic, provide values for the template parameters.	Cloud architect

## Complete the parameters in the CloudFormation template

Task	Description	Skills required
Provide the S3 bucket name.	Enter the name of the S3 bucket that you created or chose in the first epic.	Cloud architect
Provide the S3 key.	Provide the location of the Lambda code .zip file in your S3 bucket, without leading slashes (for example, <directory>/<file-name>.zip ).	Cloud architect
Provide an email address.	Provide an active email address to receive Amazon SNS notifications.	Cloud architect
Define the logging level.	Define the logging level and frequency for your Lambda function. Info designates detailed informational messages on the application's progress. Error designates error events that could still allow the application to continue running. Warning designates potentially harmful situations.	Cloud architect

## Confirm the subscription

Task	Description	Skills required
Confirm the subscription.	When the template successfully deploys, it sends a	Cloud architect

Task	Description	Skills required
	subscription email message to the email address provided. To receive notifications, you must confirm this email subscription.	

## Related resources

- [Creating a trail](#)
- [Creating an S3 bucket](#)
- [Uploading files to an S3 bucket](#)
- [Deploying a CloudFormation template](#)
- [Creating an IAM user](#)
- [Creating a CloudWatch Events rule that triggers on an AWS API call using AWS CloudTrail](#)

## Attachments

To access additional content that is associated with this document, unzip the following file: [attachment.zip](#)

# Prevent internet access at the account level by using a service control policy

Created by Sergiy Shevchenko (AWS), Sean O'Sullivan (AWS), and Victor Mazeo Whitaker (AWS)

**Environment:** PoC or pilot

**Technologies:** Security, identity, compliance; Networking

**AWS services:** AWS Organizations

## Summary

Organizations frequently want to limit internet access for account resources that should remain private. In these accounts, the resources in virtual private clouds (VPCs) should not access the internet by any means. Many organizations choose a [centralized inspection architecture](#). For the east-west (VPC-to-VPC) traffic in a centralized inspection architecture, you need to make sure that the spoke accounts and their resources do not have access to the internet. For north-south (internet egress and on-premises) traffic, you want to allow internet access only through the inspection VPC.

This pattern uses a [service control policy \(SCP\)](#) to help prevent internet access. You can apply this SCP at the account or organizational unit (OU) level. The SCP limits internet connectivity by preventing the following:

- Creating or attaching an IPv4 or IPv6 [internet gateway](#) that allows direct internet access to the VPC
- Creating or accepting a [VPC peering connection](#) that might allow indirect internet access through another VPC
- Creating or updating an [AWS Global Accelerator](#) configuration that might allow direct internet access to VPC resources

## Prerequisites and limitations

### Prerequisites

- One or multiple AWS accounts managed as an organization in AWS Organizations.



- [All features are enabled](#) in AWS Organizations.
- [SCPs are enabled](#) in the organization.
- Permissions to:
  - Access the organization's management account.
  - Create SCPs. For more information about the minimum permissions, see [Creating an SCP](#).
  - Attach the SCP to the target accounts or organizational units (OUs). For more information about the minimum permissions, see [Attaching and detaching service control policies](#).

## Limitations

- SCPs don't affect users or roles in the management account. They affect only the member accounts in your organization.
- SCPs affect only AWS Identity and Access Management (IAM) users and roles that are managed by accounts that are part of the organization. For more information, see [SCP effects on permissions](#).

## Tools

### AWS services

- [AWS Organizations](#) is an account management service that helps you consolidate multiple AWS accounts into an organization that you create and centrally manage. In this pattern, you use [service control policies \(SCPs\)](#) in AWS Organizations.
- [Amazon Virtual Private Cloud \(Amazon VPC\)](#) helps you launch AWS resources into a virtual network that you've defined. This virtual network resembles a traditional network that you'd operate in your own data center, with the benefits of using the scalable infrastructure of AWS.

## Best practices

After establishing this SCP in your organization, make sure to update it frequently to address any new AWS services or features that might affect internet access.

# Epics

## Create and attach the SCP

Task	Description	Skills required
Create the SCP.	<ol style="list-style-type: none"><li>1. Sign in to the <a href="#">AWS Organizations console</a>. You must sign in to the organization's management account.</li><li>2. In the left pane, choose <b>Policies</b>.</li><li>3. On the policies page, choose <b>Service control policies</b>.</li><li>4. On the <b>Service control policies</b> page, choose <b>Create policy</b>.</li><li>5. On the <b>Create new service control policy</b> page, enter a <b>Policy name</b> and an optional <b>Policy description</b>.</li><li>6. (Optional) Add <a href="#">AWS tags</a> to your policy.</li><li>7. In the JSON editor, delete the placeholder policy.</li><li>8. Paste the following policy into the JSON editor.</li></ol> <pre data-bbox="630 1667 1029 1885">{   "Version":   "2012-10-17",   "Statement": [     {</pre>	AWS administrator

Task	Description	Skills required
	<pre>       "Action": [         "ec2:AttachInternetGateway",         "ec2:CreateInternetGateway",          "ec2:CreateVpcPeeringConnection",         "ec2:AcceptVpcPeeringConnection",         "ec2:CreateEgressOnlyInternetGateway"       ],       "Resource":         "*",       "Effect": "Deny"     },     {       "Action": [         "globalaccelerator:Create*",         "globalaccelerator:Update*"       ],       "Resource":         "*",       "Effect": "Deny"     }   ] } </pre> <p>9. Choose <b>Create</b> policy.</p>	

Task	Description	Skills required
Attach the SCP.	<ol style="list-style-type: none"><li>1. On the <b>Service control policies</b> page, choose the policy you created.</li><li>2. On the <b>Targets</b> tab, choose <b>Attach</b>.</li><li>3. Select the OU or account that you want to attach the policy to. You might have to expand the OUs to find the OU or account that you want.</li><li>4. Choose <b>Attach policy</b>.</li></ol>	AWS administrator

## Related resources

- [AWS Organizations documentation](#)
- [Service control policies \(SCPs\)](#)
- [Centralized inspection architecture with AWS Gateway Load Balancer and AWS Transit Gateway \(AWS blog post\)](#)

# Scan Git repositories for sensitive information and security issues by using git-secrets

Created by Saurabh Singh (AWS)

**Environment:** Production

**Technologies:** Security, identity, compliance

**Workload:** Open-source

## Summary

This pattern describes how to use the open-source [git-secrets](#) tool from AWS Labs to scan Git source repositories and find code that might potentially include sensitive information, such as user passwords or AWS access keys, or that has any other security issues.

`git-secrets` scans commits, commit messages, and merges to prevent sensitive information such as secrets from being added to your Git repositories. For example, if a commit, commit message, or any commit in a merge history matches one of your configured, prohibited regular expression patterns, the commit is rejected.

## Prerequisites and limitations

### Prerequisites

- An active AWS account
- A Git repository that requires a security scan
- A Git client (version 2.37.1 and later) installed

## Architecture

### Target architecture

- Git
- `git-secrets`

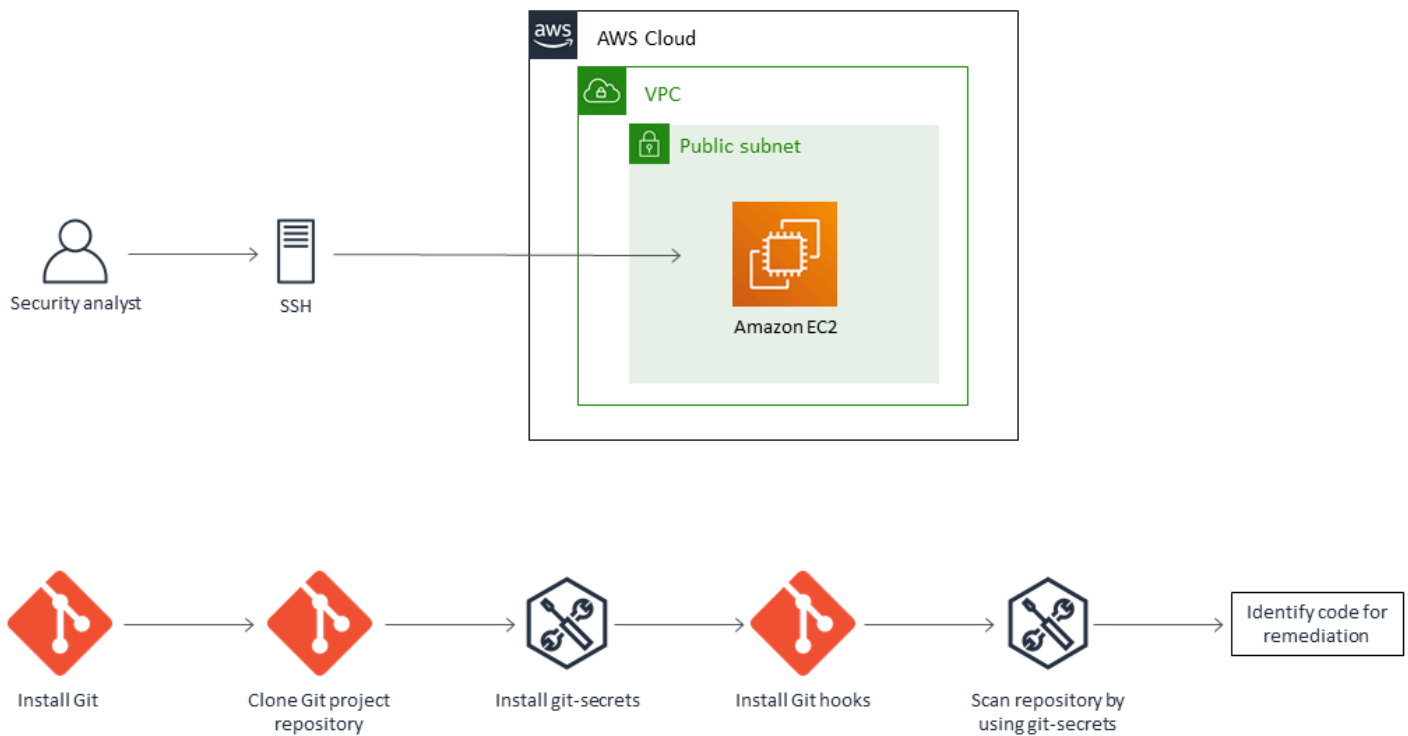

## Tools

- [git-secrets](#) is a tool that prevents you from committing sensitive information into Git repositories.
- [Git](#) is an open-source distributed version control system.

## Best practices

- Always scan a Git repository by including all revisions:

```
git secrets --scan-history
```

## Epics

### Connect to an EC2 instance

Task	Description	Skills required
Connect to an EC2 instance by using SSH.	<p>Connect to an Amazon Elastic Compute Cloud (Amazon EC2) instance by using SSH and a key pair file.</p> <p>You can skip this step if you are scanning a repository on your local machine.</p>	General AWS

### Install Git

Task	Description	Skills required
Install Git.	<p>Install Git by using the command:</p> <pre>yum install git -y</pre> <p>If you are using your local machine, you can install a Git client for a specific OS version. For more information, see the <a href="#">Git website</a>.</p>	General AWS

### Clone the source repository and install git-secrets

Task	Description	Skills required
Clone the Git source repository.	To clone the Git repository that you want to scan, choose	General AWS

Task	Description	Skills required
	the <b>Git clone</b> command from your home directory.	
Clone git-secrets.	<p>Clone the <code>git-secrets</code> Git repository.</p> <pre data-bbox="597 464 1026 621">git clone https://github.com/awslabs/git-secrets.git</pre> <p>Place <code>git-secrets</code> somewhere in your <code>PATH</code> so that Git picks it up when you run <code>git-secrets</code> .</p>	General AWS



Task	Description	Skills required
Install git-secrets.	<p><b>For Unix and variants (Linux/macOS):</b></p> <p>You can use the <code>install</code> target of the Makefile (provided in the <code>git-secrets</code> repository) to install the tool. You can customize the installation path by using the <code>PREFIX</code> and <code>MANPREFIX</code> variables.</p> <pre>make install</pre> <p><b>For Windows:</b></p> <p>Run the PowerShell <code>install.ps1</code> script provided in the <code>git-secrets</code> repository. This script copies the installation files to an installation directory (<code>%USERPROFILE%/.git-secrets</code> by default) and adds the directory to the current user <code>PATH</code>.</p> <pre>PS &gt; ./install.ps1</pre> <p><b>For Homebrew (macOS users):</b></p> <p>Run:</p>	General AWS

Task	Description	Skills required
	<pre>brew install git-secrets</pre> <p>For more information, see the <i>Related resources</i> section.</p>	

## Scan git code repository

Task	Description	Skills required
Go to the source repository.	Switch to the directory for the Git repository that you want to scan: <pre>cd my-git-repository</pre>	General AWS
Register the AWS rule set (Git hooks).	To configure <code>git-secrets</code> to scan your Git repository on each commit, run the command: <pre>git secrets --register-aws</pre>	General AWS
Scan the repository.	Run the following command to start scanning your repository: <pre>git secrets --scan</pre>	General AWS
Review the output file.	The tool generates an output file if it finds a vulnerability in your Git repository. For example:	General AWS

Task	Description	Skills required
	<pre>example.sh:4:AWS_S ECRET_ACCESS_KEY = *****  [ERROR] Matched one or more prohibited patterns  Possible mitigations: - Mark false positives as allowed using: git config --add secrets.a llowed ... - Mark false positives as allowed by adding regular expressions to .gitallowed at repository's root directory - List your configure d patterns: git config --get-all secrets.p atterns - List your configure d allowed patterns: git config --get-all secrets.allowed - List your configure d allowed patterns in .gitallowed at repository's root directory - Use --no-verify if this is a one-time false positive</pre>	

## Related resources

- [Git webhooks with AWS services](#) (AWS Quick Start)

- [git-secrets tool](#)
- [Migrate a Git Repository to AWS](#) (AWS hands-on tutorial)
- [AWS CodeCommit API Reference](#)

# Send alerts from AWS Network Firewall to a Slack channel

Created by Venki Srivatsav (AWS) and Aromal Raj Jayarajan (AWS)

**Code repository:** [NfwSlackIntegration](#)

**Environment:** PoC or pilot

**Technologies:** Security, identity, compliance; Networking

**AWS services:** AWS Lambda; AWS Network Firewall; Amazon S3

## Summary

This pattern describes how to deploy a firewall by using Amazon Web Services (AWS) Network Firewall with the distributed deployment model and how to propagate the alerts generated by AWS Network Firewall to a configurable Slack channel.

Compliance standards such as Payment Card Industry Data Security Standard (PCI DSS) require that you install and maintain a firewall to protect customer data. In the AWS Cloud, a virtual private cloud (VPC) is considered the same as a physical network in the context of these compliance requirements. You can use Network Firewall to monitor network traffic between VPCs and to protect your workloads that run in VPCs governed by a compliance standard. Network Firewall blocks access or generates alerts when it detects unauthorized access from other VPCs in the same account. However, Network Firewall supports a limited number of destinations for delivering the alerts. These destinations include Amazon Simple Storage Service (Amazon S3) buckets, Amazon CloudWatch log groups, and Amazon Data Firehose delivery streams. Any further action on these notifications requires offline analysis by using either Amazon Athena or Amazon Kinesis.

This pattern provides a method for propagating alerts that are generated by Network Firewall to a configurable Slack channel for further action in near real time. You can also extend the functionality to other alerting mechanisms such as PagerDuty, Jira, and email. (Those customizations are outside the scope of this pattern.)

## Prerequisites and limitations

### Prerequisites

- Slack channel (see [Getting started](#) in the Slack help center)
- Required privileges to send a message to the channel
- The Slack endpoint URL with an API token ([select your app](#) and choose an incoming webhook to see its URL; for more information, see [Creating an Incoming Webhook](#) in the Slack API documentation)
- An Amazon Elastic Compute Cloud (Amazon EC2) test instance in the workload subnets
- Test rules in Network Firewall
- Actual or simulated traffic to trigger the test rules
- An S3 bucket to hold the source files to be deployed

## Limitations

- Currently this solution supports only a single Classless Inter-Domain Routing (CIDR) range as a filter for source and destination IPs.

## Architecture

### Target technology stack

- One VPC
- Four subnets (two for the firewall and two for workloads)
- Internet gateway
- Four route tables with rules
- S3 bucket used as an alert destination, configured with a bucket policy and event settings to run a Lambda function
- Lambda function with an execution role, to send Slack notifications
- AWS Secrets Manager secret for storing the Slack URL
- Network firewall with alert configuration
- Slack channel

All components except for the Slack channel are provisioned by the CloudFormation templates and the Lambda function that are provided with this pattern (see the [Code](#) section).

### Target architecture

This pattern sets up a decentralized network firewall with Slack integration. This architecture consists of a VPC with two Availability Zones. The VPC includes two protected subnets and two firewall subnets with network firewall endpoints. All traffic going into and out of the protected subnets can be monitored by [creating firewall policies](#) and rules. The network firewall is configured to place all alerts in an S3 bucket. This S3 bucket is configured to call a Lambda function when it receives a put event. The Lambda function fetches the configured Slack URL from Secrets Manager and sends the notification message to the Slack workspace.

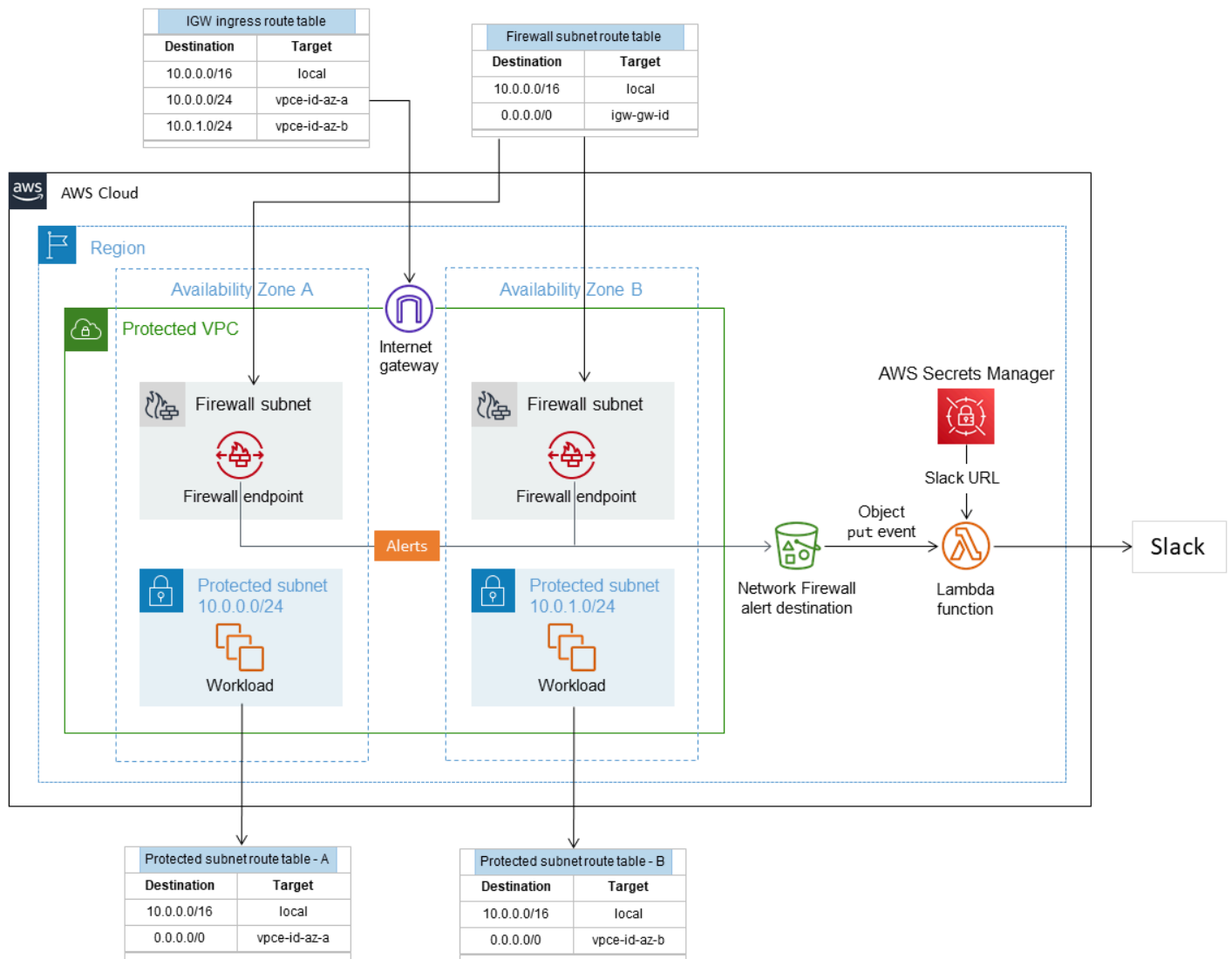

For more information about this architecture, see the AWS blog post [Deployment models for AWS Network Firewall](#).

# Tools

## AWS services

- [AWS Network Firewall](#) is a stateful, managed, network firewall and intrusion detection and prevention service for VPCs in the AWS Cloud. You can use Network Firewall to filter traffic at the perimeter of your VPC and protect your workloads on AWS.
- [AWS Secrets Manager](#) is a service for credential storage and retrieval. Using Secrets Manager, you can replace hardcoded credentials in your code, including passwords, with an API call to Secrets Manager to retrieve the secret programmatically. This pattern uses Secrets Manager to store the Slack URL.
- [Amazon Simple Storage Service \(Amazon S3\)](#) is an object storage service. You can use Amazon S3 to store and retrieve any amount of data at any time, from anywhere on the web. This pattern uses Amazon S3 to store the CloudFormation templates and Python script for the Lambda function. It also uses an S3 bucket as the network firewall alert destination.
- [AWS CloudFormation](#) helps you model and set up your AWS resources, provision them quickly and consistently, and manage them throughout their lifecycle. You can use a template to describe your resources and their dependencies, and launch and configure them together as a stack, instead of managing resources individually. This pattern uses AWS CloudFormation to automatically deploy a distributed architecture for Firewall Manager.

## Code

The code for this pattern is available on GitHub, in the [Network Firewall Slack Integration](#) repository. In the `src` folder of the repository, you'll find:

- A set of CloudFormation files in YAML format. You use these templates to provision the components for this pattern.
- A Python source file (`slack-lambda.py`) to create the Lambda function.
- A .zip archive deployment package (`slack-lambda.py.zip`) to upload your Lambda function code.

To use these files, follow the instructions in the next section.



# Epics

## Set up the S3 bucket

Task	Description	Skills required
Create an S3 bucket.	<ol style="list-style-type: none"> <li>1. Sign in to the AWS Management Console and open the Amazon S3 console at <a href="https://console.aws.amazon.com/s3/">https://console.aws.amazon.com/s3/</a>.</li> <li>2. Choose or create an S3 bucket to host the code. An S3 bucket name is globally unique, and the namespace is shared by all AWS accounts. The S3 bucket name cannot include leading slashes. We recommend that you use a <a href="#">prefix</a> to organize the code for this pattern.</li> </ol> <p>For more information, see <a href="#">Creating a bucket</a> in the Amazon S3 documentation.</p>	App developer, App owner, Cloud administrator
Upload the CloudFormation templates and Lambda code.	<ol style="list-style-type: none"> <li>1. Download the following files from the <a href="#">GitHub repository</a> for this pattern: <ul style="list-style-type: none"> <li>• <code>base.yml</code></li> <li>• <code>igw-ingress-route.yml</code></li> <li>• <code>slack-lambda.py</code></li> <li>• <code>slackLambda.yml</code></li> </ul> </li> </ol>	App developer, App owner, Cloud administrator

Task	Description	Skills required
	<ul style="list-style-type: none"> <li>decentralized-deployment.yml</li> <li>protected-subnet-route.yml</li> <li>slack-lambda.py.zip</li> </ul> <p>2. Upload the files to the S3 bucket you created.</p>	

## Deploy the CloudFormation template

Task	Description	Skills required
Launch the CloudFormation template.	<p>Open the <a href="#">AWS CloudFormation console</a> in the same AWS Region as your S3 bucket and deploy the template base.yml. This template creates the required AWS resources and Lambda functions for the alerts to be transmitted to the Slack channel.</p> <p>For more information about deploying CloudFormation templates, see <a href="#">Creating a stack on the AWS CloudFormation console</a> in the CloudFormation documentation.</p>	App developer, App owner, Cloud administrator
Complete the parameters in the template.	Specify the stack name and configure the parameter	App developer, App owner, Cloud administrator

Task	Description	Skills required
	values. For a list of parameters, their descriptions, and default values, see <i>CloudFormation parameters</i> in the <a href="#">Additional information</a> section.	
Create the stack.	<ol style="list-style-type: none"> <li>1. Review stack details and update values based on your environment requirements.</li> <li>2. Choose <b>Create stack</b> to deploy the template.</li> </ol>	App developer, App owner, Cloud administrator

## Verify the solution

Task	Description	Skills required
Test the deployment.	<p>Use the AWS CloudFormation console or the AWS Command Line Interface (AWS CLI) to verify that the resources listed in the <a href="#">Target technology stack</a> section have been created.</p> <p>If the CloudFormation template fails to deploy successfully, check the values you provided for the <code>pAvailabilityZone1</code> and <code>pAvailabilityZone2</code> parameters. These should be appropriate for the AWS Region you're</p>	App developer, App owner, Cloud administrator

Task	Description	Skills required
	deploying the solution in. For a list of Availability Zones for each Region, see <a href="#">Regions and Zones</a> in the Amazon EC2 documentation.	

Task	Description	Skills required
Test functionality.	<ol style="list-style-type: none"><li data-bbox="591 226 997 359">1. Open the Amazon EC2 console at <a href="https://console.aws.amazon.com/ec2/">https://console.aws.amazon.com/ec2/</a>.</li><li data-bbox="591 405 1024 768">2. Create an EC2 instance in one of the protected subnets. Choose an Amazon Linux 2 AMI (HVM) to use as an HTTPS server. For instructions, see <a href="#">Launch an instance</a> in the Amazon EC2 documentation.  <b>Note:</b> Amazon Linux 2 is nearing end of support. For more information, see the <a href="#">Amazon Linux 2 FAQs</a>.</li><li data-bbox="591 1037 1024 1169">3. Use the following user data to install a web server on the EC2 instance:  <pre data-bbox="607 1205 1024 1602">#!/bin/bash yum install httpd -y systemctl start httpd systemctl stop firewalld cd /var/www/html echo "Hello!! this is a NFW alert test page, 200 OK" &gt; index.html</pre></li><li data-bbox="591 1640 922 1717">4. Create the following network firewall rules:  <i>Stateless rule:</i></li></ol>	App developer, App owner, Cloud administrator

Task	Description	Skills required
	<p>Source: 0.0.0.0/0 Destination 10.0.3.65 /32 (private IP of the EC2 instance) Action: Forward</p> <p><i>Stateful rule:</i></p> <p>Protocol: HTTP Source ip/port: Any / Any Destination ip/port: Any /Any</p> <p>5. Get the public IP of the web server you created in step 3.</p> <p>6. Access the public IP in a browser. You should see the following message in the browser:</p> <pre>Hello!! this is a NFW alert test page, 200 OK</pre> <p>You will also get a notification in the Slack channel. The notification might be delayed, depending on the size of the message. For testing purposes, consider providing a CIDR filter that is not too narrow (for example, a CIDR value with /32 would</p>	

Task	Description	Skills required
	be considered too narrow, and /8 would be too broad). For more information, see the <i>Filter behavior</i> section in <a href="#">Additional information</a> .	

## Related resources

- [Deployment models for AWS Network Firewall](#) (AWS blog post)
- [AWS Network Firewall policies](#) (AWS documentation)
- [Network Firewall Slack Integration](#) (GitHub repository)
- [Create a Slack workspace](#) (Slack help center)

## Additional information

### CloudFormation parameters

Parameter	Description	Default or sample value
pVpcName	The name of the VPC to create.	Inspection
pVpcCidr	The CIDR range for the VPC to create.	10.0.0.0/16
pVpcInstanceTenancy	How EC2 instances are distributed across physical hardware. Options are <code>default</code> (shared tenancy) or <code>dedicated</code> (single tenancy).	default
pAvailabilityZone1	The first Availability Zone for the infrastructure.	us-east-2a

pAvailabilityZone2	The second Availability Zone for the infrastructure.	us-east-2b
pNetworkFirewallSubnet1Cidr	The CIDR range for the first firewall subnet (minimum /28).	10.0.1.0/24
pNetworkFirewallSubnet2Cidr	The CIDR range for the second firewall subnet (minimum /28).	10.0.2.0/24
pProtectedSubnet1Cidr	The CIDR range for the first protected (workload) subnet.	10.0.3.0/24
pProtectedSubnet2Cidr	The CIDR range for the second protected (workload) subnet.	10.0.4.0/24
pS3BucketName	The name of the existing S3 bucket where you uploaded the Lambda source code.	us-w2-yourname-lambda-functions
pS3KeyPrefix	The prefix of the S3 bucket where you uploaded the Lambda source code.	aod-test
pAWSSecretName4Slack	The name of the secret that holds the Slack URL.	SlackEndpoint-Cfn
pSlackChannelName	The name of the Slack channel you created.	somename-notifications
pSlackUserName	Slack user name.	Slack User
pSecretKey	This can be any key. We recommend that you use the default.	webhookUrl



<code>pWebHookUrl</code>	The value of the Slack URL.	<code>https://hooks.slack.com/services/T???9T??/A031885JRM7/9D4Y??????</code>
<code>pAlertS3Bucket</code>	The name of the S3 bucket to be used as the network firewall alert destination. This bucket will be created for you.	<code>us-w2-yourname-security-aod-alerts</code>
<code>pSecretTagName</code>	The tag name for the secret.	<code>AppName</code>
<code>pSecretTagValue</code>	The tag value for the specified tag name.	<code>LambdaSlackIntegration</code>
<code>pdestCidr</code>	The filter for the destination CIDR range. For more information, see the next section, <i>Filter behavior</i> .	<code>10.0.0.0/16</code>
<code>pdestCondition</code>	A flag to indicate whether to exclude or include the destination match. For more information, see the next section. Valid values are <code>include</code> and <code>exclude</code> .	<code>include</code>
<code>psrcCidr</code>	The filter for the source CIDR range to alert. For more information, see the next section.	<code>118.2.0.0/16</code>
<code>psrcCondition</code>	The flag to exclude or include the source match. For more information, see the next section.	<code>include</code>

## Filter behavior

If you haven't configured any filters in AWS Lambda, all generated alerts are sent to your Slack channel. The source and destination IPs of the generated alerts are matched against the CIDR ranges you configured when you deployed the CloudFormation template. If a match is found, the condition is applied. If either the source or the destination falls within the configured CIDR range and at least one of them is configured with the condition `include`, an alert is generated. The following tables provide examples of CIDR values, conditions, and results.

	Configured CIDR	Alert IP	Configured	Alert
<b>Source</b>	10.0.0.0/16	10.0.0.25	include	Yes
<b>Destination</b>	100.0.0.0/16	202.0.0.13	include	

	Configured CIDR	Alert IP	Configured	Alert
<b>Source</b>	10.0.0.0/16	10.0.0.25	exclude	No
<b>Destination</b>	100.0.0.0/16	202.0.0.13	include	

	Configured CIDR	Alert IP	Configured	Alert
<b>Source</b>	10.0.0.0/16	10.0.0.25	include	Yes
<b>Destination</b>	100.0.0.0/16	100.0.0.13	include	

	Configured CIDR	Alert IP	Configured	Alert
<b>Source</b>	10.0.0.0/16	90.0.0.25	include	Yes
<b>Destination</b>	Null	202.0.0.13	include	

	Configured CIDR	Alert IP	Configured	Alert
<b>Source</b>	10.0.0.0/16	90.0.0.25	include	No

---

<b>Destination</b>	100.0.0.0/16	202.0.0.13	include
--------------------	--------------	------------	---------

# Simplify private certificate management by using AWS Private CA and AWS RAM

Created by Everett Hinckley (AWS) and Vivek Goyal (AWS)

**Code repository:** [ACMPCA Hierarchy](#)

**Environment:** Production

**Technologies:** Security, identity, compliance; Infrastructure; Migration

**AWS services:** AWS Certificate Manager (ACM); AWS Organizations; AWS RAM

## Summary

You can use AWS Private Certificate Authority (AWS Private CA) to issue private certificates for authenticating internal resources and signing computer code. This pattern provides an AWS CloudFormation template for the rapid deployment of a multi-level CA hierarchy and consistent provisioning experience. Optionally, you can use AWS Resource Access Manager (AWS RAM) to securely share the CA within your organizations or organizational units (OUs) in AWS Organizations, and centralize the CA while using AWS RAM to manage permissions. There is no need for a private CA in every account, so this approach saves you money. Additionally, you can use Amazon Simple Storage Service (Amazon S3) to store the certificate revocation list (CRL) and access logs.

This implementation provides the following features and benefits:

- Centralizes and simplifies the management of the private CA hierarchy by using AWS Private CA.
- Exports certificates and keys to customer-managed devices on AWS and on premises.
- Uses an AWS CloudFormation template for a rapid deployment and consistent provisioning experience.
- Creates a private root CA along with 1, 2, 3, or 4 subordinate CA hierarchy.
- Optionally, uses AWS RAM to share the end-entity subordinate CA with other accounts at the organization or OU level.
- Saves money by removing the need for a private CA in every account by using AWS RAM.

- Creates an optional S3 bucket for the CRL.
- Creates an optional S3 bucket for CRL access logs.

## Prerequisites and limitations

### Prerequisites

If you want to share the CA within an AWS Organizations structure, identify or set up the following:

- A security account for creating the CA hierarchy and share.
- A separate OU or account for testing.
- Sharing enabled within the AWS Organizations management account. For more information, see [Enable resource sharing within AWS Organizations](#) in the AWS RAM documentation.

### Limitations

- CAs are regional resources. All CAs reside in a single AWS account and in a single AWS Region.
- User-generated certificates and keys are not supported. For this use case, we recommend that you customize this solution to use an external root CA.
- A public CRL bucket is not supported. We recommend that you keep the CRL private. If internet access to the CRL is required, see the section on using Amazon CloudFront to serve CRLs in [Enabling the S3 Block Public Access \(BPA\) feature](#) in the AWS Private CA documentation.
- This pattern implements a single-Region approach. If you require a multi-Region certificate authority, you can implement subordinates in a second AWS Region or on premises. That complexity is outside the scope of this pattern, because the implementation depends on your specific use case, workload volume, dependencies, and requirements.

## Architecture

### Target technology stack

- AWS Private CA
- AWS RAM
- Amazon S3
- AWS Organizations

- AWS CloudFormation

## Target architecture

This pattern provides two options for sharing to AWS Organizations:

**Option 1** – Create the share at the organization level. All accounts in the organization can issue the private certificates by using the shared CA, as shown in the following diagram.

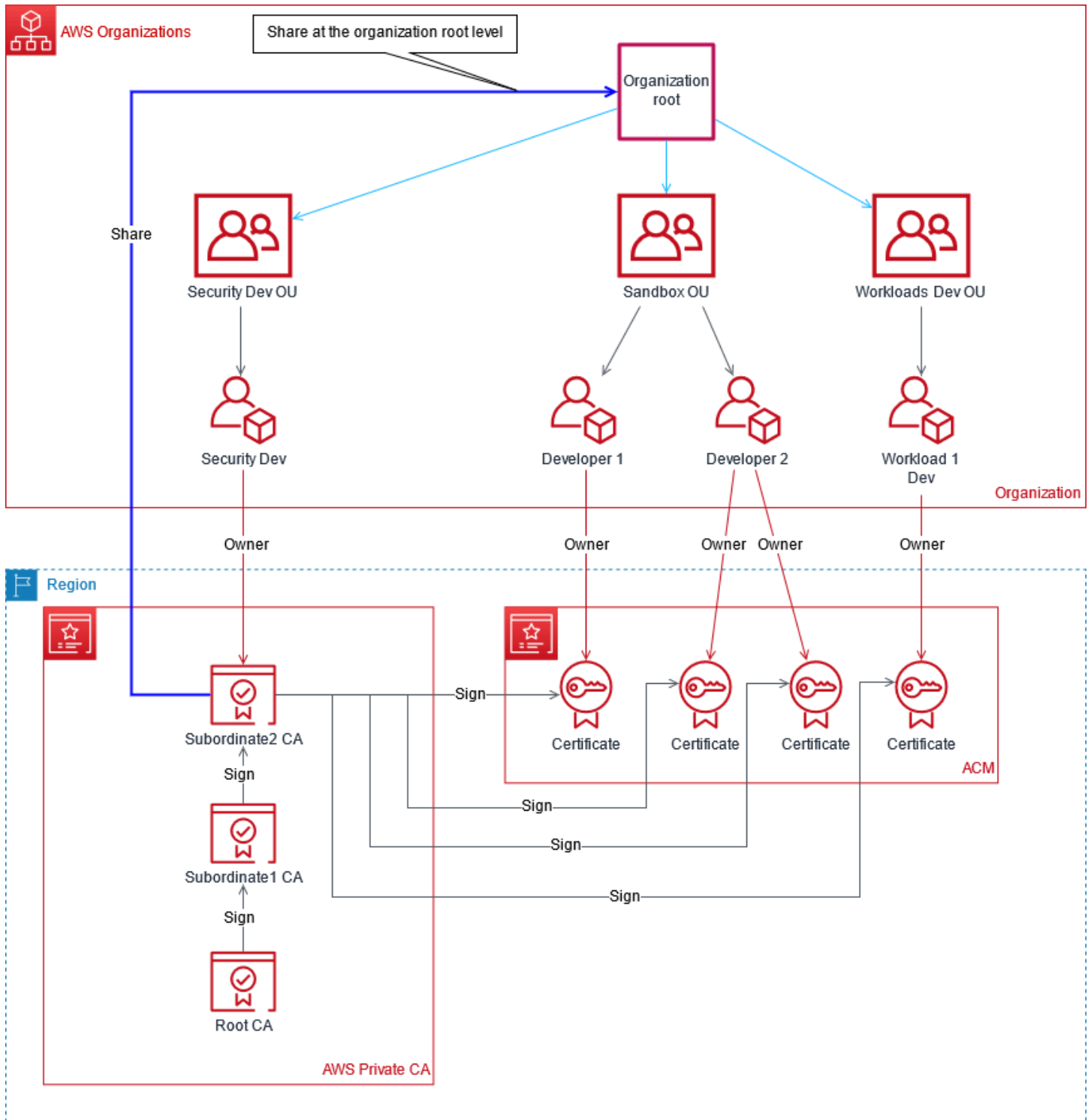

**Option 2** – Create the share at the organizational unit (OU) level. Only the accounts in the specified OU can issue the private certificates by using the shared CA. For example, in the following diagram, if the share is created at the Sandbox OU level, both Developer 1 and Developer 2 can issue private certificates by using the shared CA.

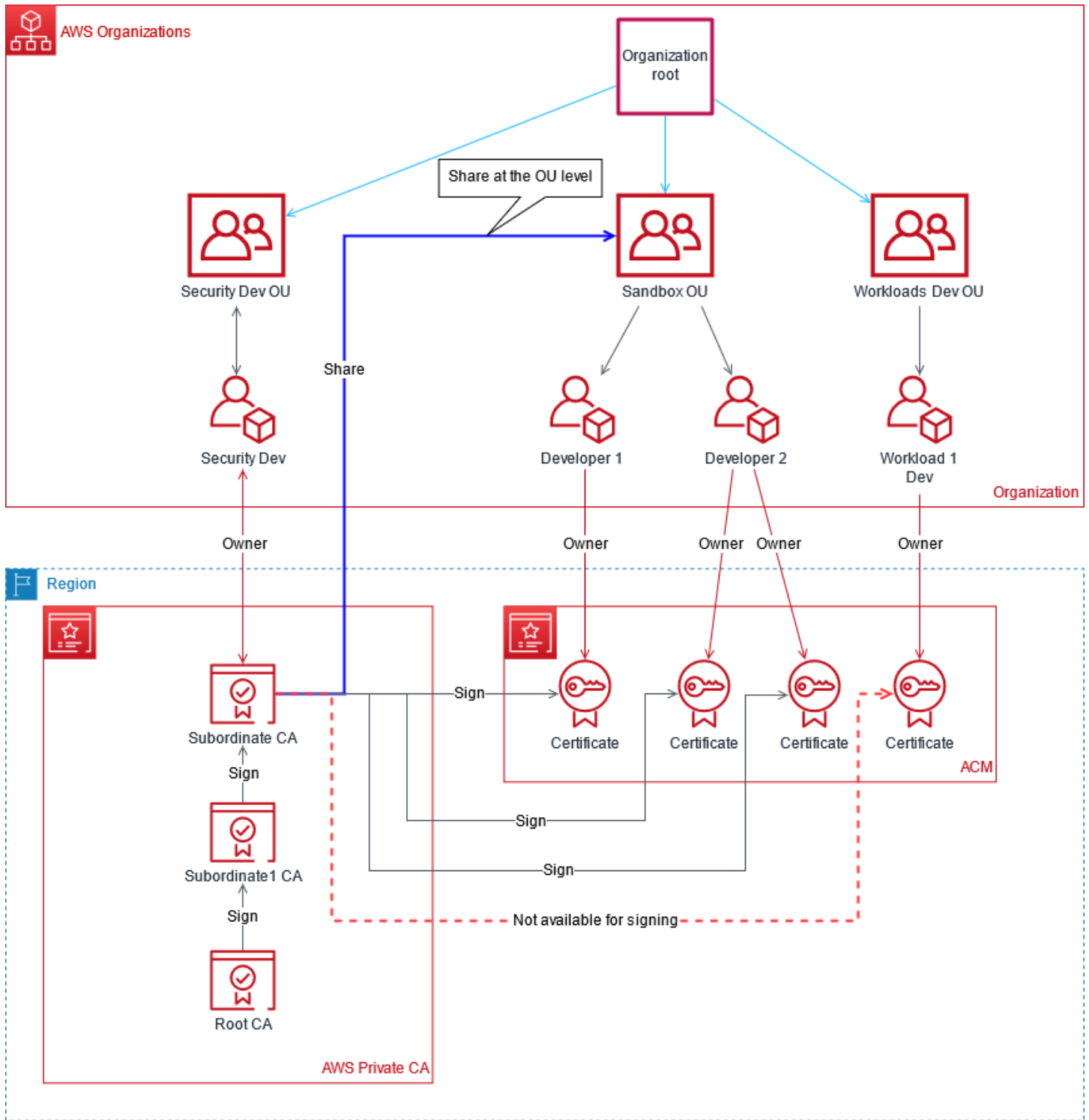

## Tools

### AWS services



- [AWS Private CA](#) – AWS Private Certificate Authority (AWS Private CA) is a hosted private CA service for issuing and revoking private digital certificates. It helps you create private CA hierarchies, including root and subordinate CAs, without the investment and maintenance costs of operating an on-premises CA.
- [AWS RAM](#) – AWS Resource Access Manager (AWS RAM) helps you securely share your resources across AWS accounts and within your organization or OUs in AWS Organizations. To reduce operational overhead in a multi-account environment, you can create a resource and use AWS RAM to share that resource across accounts.
- [AWS Organizations](#) – AWS Organizations is an account management service that enables you to consolidate multiple AWS accounts into an organization that you create and centrally manage.
- [Amazon S3](#) – Amazon Simple Storage Service (Amazon S3) is an object storage service. You can use Amazon S3 to store and retrieve any amount of data at any time, from anywhere on the web. This pattern uses Amazon S3 to store the certificate revocation list (CRL) and access logs.
- [AWS CloudFormation](#) – AWS CloudFormation helps you model and set up your AWS resources, provision them quickly and consistently, and manage them throughout their lifecycle. You can use a template to describe your resources and their dependencies, and launch and configure them together as a stack, instead of managing resources individually. This pattern uses AWS CloudFormation to automatically deploy a multi-level CA hierarchy.

## Code

The source code for this pattern is available on GitHub, in the [AWS Private CA hierarchy](#) repository. The repository includes:

- The AWS CloudFormation template `ACMPCA-RootCASubCA.yaml`. You can use this template to deploy the CA hierarchy for this implementation.
- Test files for use cases such as requesting, exporting, describing, and deleting a certificate.

To use these files, follow the instructions in the *Epics* section.

# Epics

## Architect the CA hierarchy

Task	Description	Skills required
Collect certificate subject information.	Gather certificate subject information about the certificate owner: organization name, organization unit, country, state, locality, and common name.	Cloud architect, Security architect, PKI engineer
Collect optional information about AWS Organizations.	If the CA will be part of an AWS Organizations structure and you want to share the CA hierarchy inside that structure, collect the management account number, the organization ID, and optionally the OU ID (if you want to share the CA hierarchy only with a specific OU). Also, determine the AWS Organizations accounts or OUs, if any, that you want to share the CA with.	Cloud architect, Security architect, PKI engineer
Design the CA hierarchy.	Determine which account will house the root and subordinate CAs. Determine how many subordinate levels the hierarchy requires between the root and the end-entity certificates. For more information, see <a href="#">Designing</a>	Cloud architect, Security architect, PKI engineer

Task	Description	Skills required
	<a href="#">a CA hierarchy</a> in the AWS Private CA documentation.	
Determine naming and tagging conventions for the CA hierarchy.	Determine the names for the AWS resources: the root CA and each subordinate CA. Determine which tags should be assigned to each CA.	Cloud architect, Security architect, PKI engineer
Determine required encryption and signing algorithms.	Determine the following: <ul style="list-style-type: none"> <li>Your organization's encryption algorithm requirements for the public keys that your CA uses when it issues a certificate. The default is RSA_2048.</li> <li>The key algorithm that your CA uses for certificate signing. The default is SHA256WITHRSA.</li> </ul>	Cloud architect, Security architect, PKI engineer
Determine certificate revocation requirements for the CA hierarchy.	If certificate revocation capabilities are required, establish a naming convention for the S3 bucket that contains the certificate revocation list (CRL).	Cloud architect, Security architect, PKI engineer
Determine the logging requirements for the CA hierarchy.	If access logging capabilities are required, establish a naming convention for the S3 bucket that contains the access logs.	Cloud architect, Security architect, PKI engineer

Task	Description	Skills required
Determine certificate expiration periods.	Determine the expiration date for the root certificate (the default is 10 years), end-entity certificates (the default is 13 months), and subordinate CA certificates (the default is 3 years). Subordinate CA certificates should expire earlier than the CA certificates at higher levels in the hierarchy. For more information, see <a href="#">Managing the private CA lifecycle</a> in the AWS Private CA documentation.	Cloud architect, Security architect, PKI engineer

## Deploy the CA hierarchy

Task	Description	Skills required
Complete prerequisites.	Complete the steps in the <a href="#">Prerequisites</a> section of this pattern.	Cloud administrator, Security engineers, PKI engineers
Create CA roles for various personas.	1. Determine the types of AWS Identity and Access Management (IAM) roles or users in AWS IAM Identity Center (successor to AWS Single Sign-On) required to administer the various levels of the CA hierarchy , such as RootCAAdmin,	Cloud administrator, Security engineers, PKI engineers

Task	Description	Skills required
	<p>SubordinateCAAdmin, and CertificateConsumer.</p> <ol style="list-style-type: none"> <li>Determine the granularity of policies needed to separate duties.</li> <li>Create the required IAM roles or users in IAM Identity Center in the account that the CA hierarchy resides in.</li> </ol>	
<p>Deploy the CloudFormation stack.</p>	<ol style="list-style-type: none"> <li>From the <a href="#">GitHub repository</a> for this pattern, download the AWSPCA-RootCASubCA .yaml template.</li> <li>Deploy the template from the <a href="#">AWS CloudFormation console</a> or from the AWS Command Line Interface (AWS CLI). For more information, see <a href="#">Working with stacks</a> in the CloudFormation documentation.</li> <li>Complete the parameters in the template, including the organization name, the OU name, the key algorithm, the signing algorithm, and other options.</li> </ol>	<p>Cloud administrator, Security engineers, PKI engineers</p>

Task	Description	Skills required
Architect a solution for updating certificates used by user-managed resources.	<p>Resources of integrated AWS services, such as Elastic Load Balancing, update certificates automatically before expiration. However, user-managed resources, such as web servers that are running on Amazon Elastic Compute Cloud (Amazon EC2) instances, require another mechanism.</p> <ol style="list-style-type: none"><li>1. Determine which user-managed resources require end-entity certificates from the private CA.</li><li>2. Plan a process to be notified about the expiration of user-managed resources and certificates. For examples, see the following:<ul style="list-style-type: none"><li>• <a href="#">Using an AWS Config managed rule</a></li><li>• <a href="#">Using Amazon CloudWatch and Amazon EventBridge</a></li></ul></li><li>3. Write custom scripts to update certificates on user-managed resources and integrate them with AWS services to automate the updates. For more information about integrated AWS Services,</li></ol>	Cloud administrator, Security engineers, PKI engineers

Task	Description	Skills required
	see <a href="#">Services integrated with AWS Certificate Manager</a> in the ACM documentation.	

## Validate and document the CA hierarchy

Task	Description	Skills required
Validate optional AWS RAM sharing.	If the CA hierarchy is shared with other accounts in AWS Organizations, log in to one of those accounts from the AWS Management Console, navigate to the <a href="#">AWS Private CA console</a> , and confirm that the newly created CA is shared to this account. Only the lowest-level CA in the hierarchy will be visible, because that is the CA that generates the end-entity certificates. Repeat for a sampling of the accounts that the CA is shared with.	Cloud administrator, Security engineers, PKI engineers
Validate the CA hierarchy with certificate lifecycle tests.	In the <a href="#">GitHub repository</a> for this pattern, locate the lifecycle tests. Run the tests from the AWS CLI to request a certificate, export a certificate, describe a certificate, and delete a certificate.	Cloud administrator, Security engineers, PKI engineers

Task	Description	Skills required
Import the certificate chain into trust stores.	For browsers and other applications to trust a certificate, the certificate's issuer must be included in the browser's trust store, which is a list of trusted CAs. Add the certificate chain for the new CA hierarchy to your browser's and application's trust store. Confirm that the end-entity certificates are trusted.	Cloud administrator, Security engineers, PKI engineers
Create a runbook to document the CA hierarchy.	Create a runbook document to describe the architecture of the CA hierarchy, the account structure that can request end-entity certificates, the build process, and basic management tasks such as issuing end-entity certificates (unless you want to allow self-service by child accounts), usage, and tracking.	Cloud administrator, Security engineers, PKI engineers

## Related resources

- [Designing a CA hierarchy](#) (AWS Private CA documentation)
- [Creating a private CA](#) (AWS Private CA documentation)
- [How to use AWS RAM to share your AWS Private CA cross-account](#) (AWS blog post)
- [AWS Private CA best practices](#) (AWS blog post)
- [Enable resource sharing within AWS Organizations](#) (AWS RAM documentation)
- [Managing the private CA lifecycle](#) (AWS Private CA documentation)



- [acm-certificate-expiration-check for AWS Config](#) (AWS Config documentation)
- [AWS Certificate Manager now provides certificate expiry monitoring through Amazon CloudWatch](#) (AWS announcement)
- [Services integrated with AWS Certificate Manager](#) (ACM documentation)

## Additional information

When you export certificates, use a passphrase that is cryptographically strong and aligns with your organization's data loss prevention strategy.

# Turn off security standard controls across all Security Hub member accounts in a multi-account environment

Created by Michael Fuellbier (AWS) and Ahmed Bakry (AWS)

**Environment:** Production

**Technologies:** Security, identity, compliance; Serverless

**AWS services:** Amazon DynamoDB; Amazon EventBridge; AWS Lambda; AWS Security Hub; AWS Step Functions

## Summary

**Important:** AWS Security Hub now supports central configuration for security standards and controls, across accounts. This new feature addresses many of the scenarios that are covered by the solution in this APG pattern. Before you deploy the solution in this pattern, see [Central configuration in Security Hub](#).

In the Amazon Web Services (AWS) Cloud, AWS Security Hub standard controls, such as [CIS AWS Foundations Benchmark](#) or [AWS Foundational Security Best Practices](#), can only be turned off (disabled) manually from within a single AWS account. In a multi-account environment, you can't turn off the controls across multiple Security Hub member accounts with "one click" (that is, one API call). This pattern demonstrates how to use one click to turn off the Security Hub standard controls across all the Security Hub member accounts managed by your Security Hub administrator account.

## Prerequisites and limitations

### Prerequisites

- A multi-account environment consisting of a Security Hub administrator account that manages multiple member accounts
- AWS Command Line Interface (AWS CLI) version 2, [installed](#)
- AWS Serverless Application Model Command Line Interface (AWS SAM CLI), [installed](#)

## Limitations

- This pattern works only in a multi-account environment where a single Security Hub administrator account manages multiple member accounts.
- The event initiation causes multiple parallel invocations if you change a lot of controls in a very short timeframe. This can lead to API throttling and cause the invocations to fail. For example, this scenario can happen if you programmatically change a lot of controls by using the [Security Hub Controls CLI](#).

## Architecture

### Target technology stack

- Amazon DynamoDB
- Amazon EventBridge
- AWS CLI
- AWS Lambda
- AWS SAM CLI
- AWS Security Hub
- AWS Step Functions

### Target architecture

The following diagram shows an example of a Step Functions workflow that turns off Security Hub standard controls across multiple Security Hub member accounts (as viewed from the Security Hub administrator account).

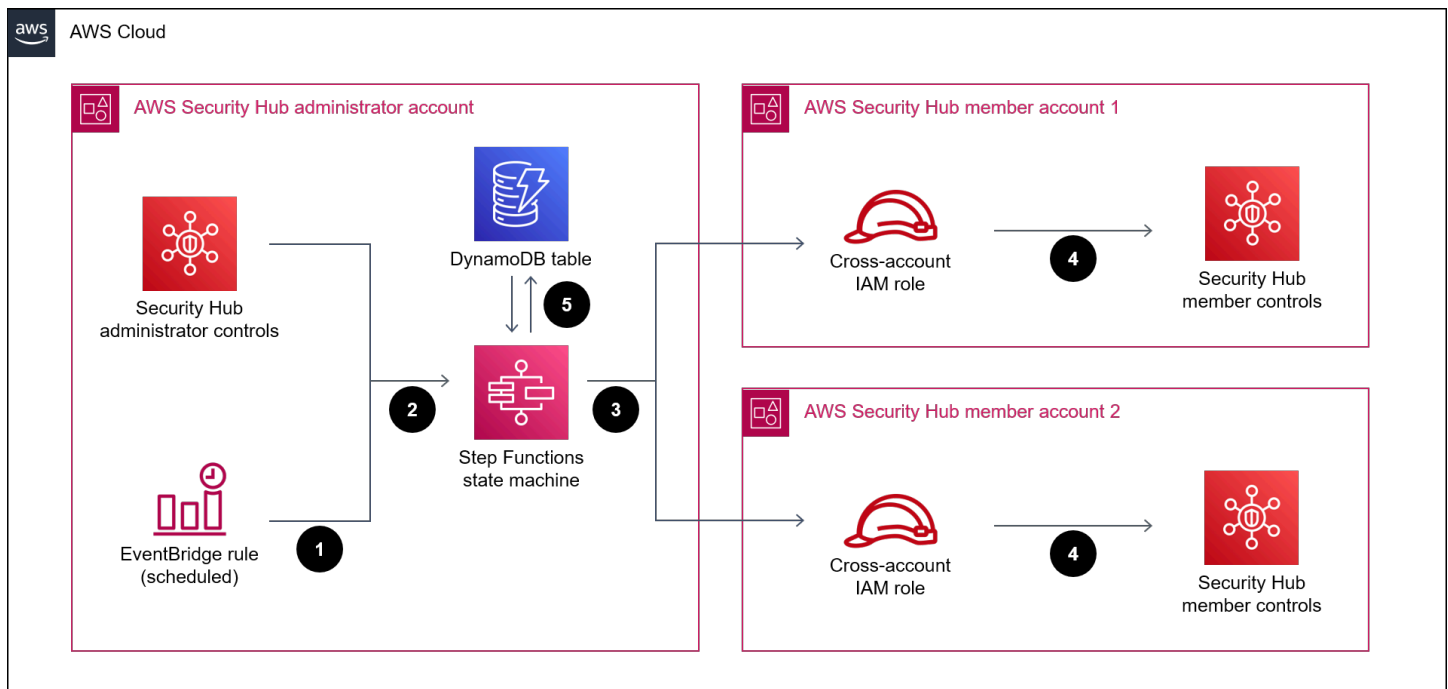

The diagram includes the following workflow:

1. An EventBridge rule is initiated on a daily schedule and invokes the state machine. You can modify the timing of the rule by updating the **Schedule** parameter in your AWS CloudFormation template.
2. An EventBridge rule is initiated whenever a control is turned on or off in the Security Hub administrator account.
3. A Step Functions state machine propagates the status of the security standard controls (that is, controls that are turned on or off) from the Security Hub administrator account to the member accounts.
4. A cross-account AWS Identity and Access Management (IAM) role is deployed in each member account and assumed by the state machine. The state machine turns the controls on or off in each member account.
5. A DynamoDB table contains exceptions and information about which controls to turn on or off in a particular account. This information overrides the configurations fetched from the Security Hub administrator account for the specified member account.

**Note:** The purpose of the scheduled EventBridge rule is to ensure that newly added Security Hub member accounts have the same control status as existing accounts.

## Tools

- [Amazon DynamoDB](#) is a fully managed NoSQL database service that provides fast, predictable, and scalable performance.
- [Amazon EventBridge](#) is a serverless event bus service that helps you connect your applications with real-time data from a variety of sources. For example, AWS Lambda functions, HTTP invocation endpoints using API destinations, or event buses in other AWS accounts.
- [AWS Command Line Interface \(AWS CLI\)](#) is an open-source tool that helps you interact with AWS services through commands in your command-line shell.
- [AWS Lambda](#) is a compute service that helps you run code without needing to provision or manage servers. It runs your code only when needed and scales automatically, so you pay only for the compute time that you use.
- [AWS Serverless Application Model \(AWS SAM\)](#) is an open-source framework that helps you build serverless applications in the AWS Cloud.
- [AWS Security Hub](#) provides a comprehensive view of your security state in AWS. It also helps you check your AWS environment against security industry standards and best practices.
- [AWS Step Functions](#) is a serverless orchestration service that helps you combine AWS Lambda functions and other AWS services to build business-critical applications.

## Code

The code for this pattern is available on the GitHub [AWS Security Hub Cross-Account Controls Disabler](#) repository. The code repository contains the following files and folders:

- `UpdateMembers/template.yaml` – This file contains components deployed in the Security Hub administrator account, including the Step Functions state machine and the EventBridge rules.
- `member-iam-role/template.yaml` – This file contains the code to deploy the cross-account IAM role in a member account.
- `stateMachine.json` – This file defines the state machine's workflow.
- `GetMembers/index.py` – This file contains the code for the **GetMembers** state machine. A script retrieves the status of the security standard controls in all existing Security Hub member accounts.
- `UpdateMember/index.py` – This file contains a script that updates the control status in each member account.

- `CheckResult/index.py` – This file contains a script that checks the status of the workflow invocation (accepted or failed).

## Epics

### Deploy a cross-account IAM role in the Security Hub member accounts

Task	Description	Skills required
Identify the account ID of the Security Hub administrator account.	Set up a <a href="#">Security Hub administrator account</a> and then note the account ID of the administrator account.	Cloud architect
Deploy the CloudFormation template that includes the cross-account IAM role in the member accounts.	<p>To deploy the <code>member-iam-role/template.yaml</code> template in all the member accounts managed by the Security Hub administrator account, run the following command:</p> <pre>aws cloudformation   deploy --template-   file member-iam-role/   template.yaml --   capabilities CAPABILIT   Y_NAMED_IAM --stack-n   ame &lt;your-stack-name&gt;   --parameter-overri   des SecurityHubAdminAc   countId=&lt;your-acco   unt-ID&gt;</pre> <p>The <code>SecurityHubAdminAc countId</code> parameter must match the Security Hub</p>	AWS DevOps

Task	Description	Skills required
	administrator account ID that you noted earlier.	

## Deploy a state machine in the Security Hub administrator account

Task	Description	Skills required
Package the CloudFormation template that includes the state machine with AWS SAM.	<p>To package the UpdateMembers/template.yaml template in the Security Hub administrator account, run the following command:</p> <pre>sam package --template-file UpdateMembers/template.yaml --output-template-file UpdateMembers/template-out.yaml --s3-bucket &lt;amzn-s3-demo-bucket&gt;</pre> <p><b>Note:</b> Your Amazon Simple Storage Service (Amazon S3) bucket must be in the same AWS Region where you deploy the CloudFormation template.</p>	AWS DevOps
Deploy the packaged CloudFormation template in the Security Hub administrator account.	<p>To deploy the CloudFormation template in the Security Hub administrator account, run the following command:</p> <pre>aws cloudformation deploy --template-</pre>	AWS DevOps

Task	Description	Skills required
	<pre data-bbox="597 205 1023 424">file UpdateMembers/ template-out.yaml -- capabilities CAPABILIT Y_IAM --stack-name &lt;your-stack-name&gt;</pre> <p data-bbox="597 466 1023 781">In the <code>member-iam-role/ template.yaml</code> template, the <b>MemberIAMRolePath</b> parameter must match the <b>IAMRolePath</b> parameter and <b>MemberIAMRoleName</b> must match <b>IAMRoleName</b>.</p> <p data-bbox="597 823 1023 1138"><b>Note:</b> Because Security Hub is a regional service, you must deploy the template individua lly in each AWS Region. Be sure to first package the solution into an S3 bucket in each Region.</p>	

## Related resources

- [Designating a Security Hub administrator account](#) (AWS Security Hub documentation)
- [Handling Errors, Retries, and adding Alerting to Step Function State Machine Executions](#) (AWS blog post)



# Update AWS CLI credentials from AWS IAM Identity Center by using PowerShell

Created by Chad Miles (AWS) and Andy Bowen (AWS)

**Environment:** Production

**Technologies:** Security, identity, compliance; CloudNative

**Workload:** Open-source

**AWS services:** AWS Tools for PowerShell; AWS IAM Identity Center

## Summary

If you want to use AWS IAM Identity Center (successor to AWS Single Sign-On) credentials with AWS Command Line Interface (AWS CLI), AWS SDKs, or AWS Cloud Development Kit (AWS CDK), you typically have to copy and paste the credentials from the IAM Identity Center console into the command line interface. This process can take a considerable amount of time and has to be repeated for each account that requires access.

One common solution is to use the AWS CLI `aws sso configure` command. This command adds an IAM Identity Center enabled profile to your AWS CLI or AWS SDK. However, the disadvantage of this solution is that you must run the command `aws sso login` for each AWS CLI profile or account that you have configured this way.

As an alternative solution, this pattern describes how to use AWS CLI [named profiles](#) and AWS Tools for PowerShell to store and refresh credentials for multiple accounts from a single IAM Identity Center instance simultaneously. The script also stores IAM Identity Center session data in memory for refreshing credentials without logging into IAM Identity Center again.

## Prerequisites and limitations

### Prerequisites

- PowerShell, installed and configured. For more information, see [Installing PowerShell](#) (Microsoft documentation).

- AWS Tools for PowerShell, installed and configured. For performance reasons, we highly recommend that you install the modularized version of AWS Tools for PowerShell, called `AWS.Tools`. Each AWS service is supported by its own individual, small module. In the PowerShell prompt, enter the following commands to install the modules needed for this pattern: `AWS.Tools.Installer`, `SSO`, and `SSOIDC`.

```
Install-Module AWS.Tools.Installer
Install-AWSToolsModule SSO, SSOIDC
```

For more information, see [Install AWS.Tools on Windows](#) or [Install AWS.Tools on Linux or macOS](#).

- AWS CLI or the AWS SDK must be previously configured with working credentials by doing one of the following:
  - Use the AWS CLI `aws configure` command. For more information, see [Quick configuration](#) (AWS CLI documentation).
  - Configure AWS CLI or AWS CDK to get temporary access through an IAM role. For more information, see [Getting IAM role credentials for CLI access](#) (IAM Identity Center documentation).

## Limitations

- This script can't be used in a pipeline or fully automated solution. When you deploy this script, you must manually authorize access from IAM Identity Center. The script then continues automatically.

## Product versions

- For all operating systems, it is recommended that you use [PowerShell version 7.0](#) or later.

## Architecture

You can use the script in this pattern to simultaneously refresh multiple IAM Identity Center credentials, and you can create a credential file for use with AWS CLI, AWS SDKs, or AWS CDK.

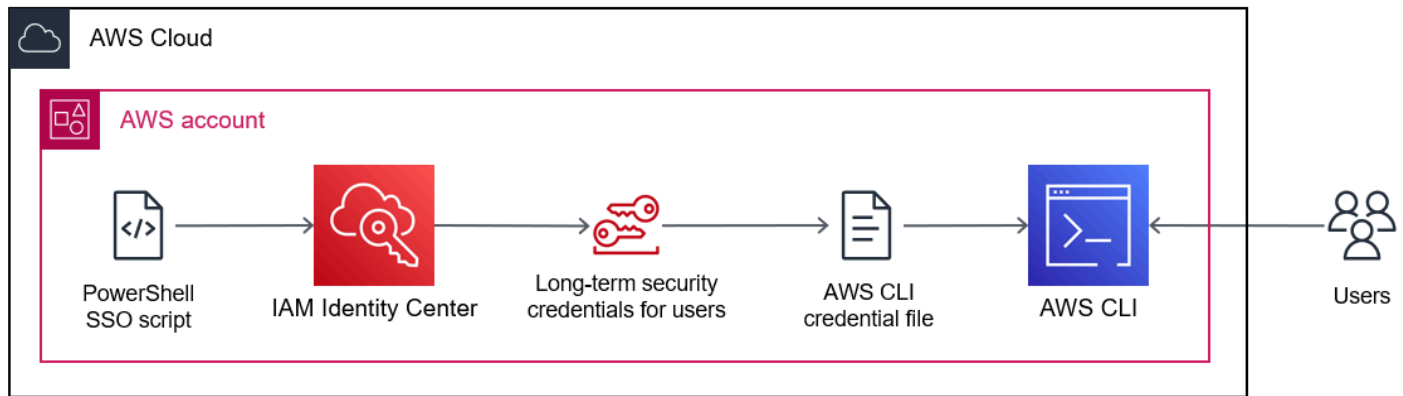

## Tools

### AWS services

- [AWS Command Line Interface \(AWS CLI\)](#) is an open-source tool that helps you interact with AWS services through commands in your command-line shell.
- [AWS IAM Identity Center](#) helps you centrally manage single sign-on (SSO) access to all of your AWS accounts and cloud applications.
- [AWS Tools for PowerShell](#) are a set of PowerShell modules that help you script operations on your AWS resources from the PowerShell command line.

### Other tools

- [PowerShell](#) is a Microsoft automation and configuration management program that runs on Windows, Linux, and macOS.

## Best practices

Keep one copy of this script for each IAM Identity Center instance. Using one script for multiple instances is not supported.

# Epics

## Run the SSO script

Task	Description	Skills required
Customize the SSO script.	<ol style="list-style-type: none"><li>1. Copy the SSO script in the <a href="#">Additional information</a> section.</li><li>2. In the Param section, for your AWS environment, define the values for the following variables:<ul style="list-style-type: none"><li>• DefaultRoleName – The IAM role or permission set to use by default.</li><li>• Region – The AWS Region in which IAM Identity Center is deployed. For a complete list of Regions and their codes, see <a href="#">Regional endpoints</a>.</li><li>• StartUrl – The URL used to access your IAM Identity Center login page. Use the same format as the example value in the script.</li><li>• EnvironmentName – A short name to reference this copy of the script, to be used when you're running multiple script</li></ul></li></ol>	Cloud administrator

Task	Description	Skills required
	<p>copies in the same session.</p> <p>3. Under line 10, which reads <code># Add your Account Information</code>, edit the following values in the hash tables to reflect your environment:</p> <ul style="list-style-type: none"><li>• <code>Profile</code> – The AWS CLI profile name in which to store the temporary credentials.</li><li>• <code>AccountId</code> – The ID of the AWS account for which you are retrieving credentials.</li><li>• <code>RoleName</code> – The name of the IAM Identity Center role or permission set you want to use. You can leave this as <code>\$DefaultRoleName</code> if you want to use the same role you defined in the <code>Param</code> section.</li></ul> <p>Each line in the hash table must end with a comma except the last one.</p>	

Task	Description	Skills required
Run the SSO script.	<p>It is recommended that you run your custom script in the PowerShell shell with the following command.</p> <pre>./Set-AwsCliSsoCredentials.ps1</pre> <p>Alternatively, you can run the script from another shell by entering the following command.</p> <pre>pwsh Set-AwsCliSsoCredentials.ps1</pre>	Cloud administrator

## Troubleshooting

Issue	Solution
No Access error	The IAM role that you are using doesn't have permissions to access the role or permission set that you defined in a RoleName parameter. Update the permissions for the role you are using, or define a different role or permission set in the script.

## Related resources

- [Where are configuration settings stored?](#) (AWS CLI documentation)
- [Configuring the AWS CLI to use AWS IAM Identity Center](#) (AWS CLI documentation)
- [Using named profiles](#) (AWS CLI documentation)

## Additional information

### SSO script

In the following script, replace placeholders in angle brackets (<>) with your own information and remove the angle brackets.

```
Set-AwsCliSsoCredentials.ps1
Param(
    $DefaultRoleName = '<AWSAdministratorAccess>',
    $Region           = '<us-west-2>',
    $StartUrl         = "<https://d-12345abcde.awsapps.com/start/>",
    $EnvironmentName = "<CompanyName>"
)
Try {$SsoAwsAccounts = (Get-Variable -name "$($EnvironmentName)SsoAwsAccounts" -Scope
    Global -ErrorAction 'SilentlyContinue').Value.Clone()}
Catch {$SsoAwsAccounts = $False}
if (-not $SsoAwsAccounts) { $SsoAwsAccounts = @(
# Add your account information in the list of hash tables below, expand as necessary,
and do not forget the commas
    @{Profile = "<Account1>"           ; AccountId = "<012345678901 >"; RoleName =
$DefaultRoleName },
    @{Profile = "<Account2>"           ; AccountId = "<123456789012>"; RoleName =
"<AWSReadOnlyAccess>" }
)}
$errorActionPreference = "Stop"
if (-not (Test-Path ~\.aws))      { New-Item ~\.aws -type Directory }
if (-not (Test-Path ~\.aws\credentials)) { New-Item ~\.aws\credentials -type File }
$CredentialFile = Resolve-Path ~\.aws\credentials
$PseudoCreds    = @{AccessKey =
    'AKAEXAMPLE123ACCESS';SecretKey='PseudoS3cret4cceSSKey123PseudoS3cretKey'} # Pseudo
Creds, do not edit.
Try {$SSOTokenExpire = (Get-Variable -Scope Global -Name
    "$($EnvironmentName)SSOTokenExpire" -ErrorAction 'SilentlyContinue').Value} Catch
    {$SSOTokenExpire = $False}
Try {$SSOToken      = (Get-Variable -Scope Global -Name "$($EnvironmentName)SSOToken"
    -ErrorAction 'SilentlyContinue').Value }      Catch {$SSOToken      = $False}
if ( $SSOTokenExpire -lt (Get-Date) ) {
    $SSOToken = $Null
    $Client   = Register-SS00IDCClient -ClientName cli-sso-client -ClientType public -
Region $Region @PseudoCreds
    $Device   = $Client | Start-SS00IDCDeviceAuthorization -StartUrl $StartUrl -Region
    $Region @PseudoCreds
```

```

Write-Host "A Browser window should open. Please login there and click ALLOW." -
NoNewLine
Start-Process $Device.VerificationUriComplete
While (-Not $SSOToken){
    Try {$SSOToken = $Client | New-SSO0IDCToken -DeviceCode $Device.DeviceCode -
GrantType "urn:ietf:params:oauth:grant-type:device_code" -Region $Region @PsuedoCreds}
    Catch {If ($_.Exception.Message -notlike "*AuthorizationPendingException*")}
{Write-Error $_.Exception} ; Start-Sleep 1}
}
$SSOTokenExpire = (Get-Date).AddSeconds($SSOToken.ExpiresIn)
Set-Variable -Name "$($EnvironmentName)SSOToken" -Value $SSOToken -Scope Global
Set-Variable -Name "$($EnvironmentName)SSOTokenExpire" -Value $SSOTokenExpire -
Scope Global
}
$CredsTime = $SSOTokenExpire - (Get-Date)
$CredsTimeText = ('{0:D2}:{1:D2}:{2:D2} left on SSO Token' -f $CredsTime.Hours,
    $CredsTime.Minutes, $CredsTime.Seconds).TrimStart("0 :")
for ($i = 0; $i -lt $SsoAwsAccounts.Count; $i++) {
    if (([DateTimeOffset]::FromUnixTimeSeconds($SsoAwsAccounts[$i].CredsExpiration /
1000)).DateTime -lt (Get-Date).ToUniversalTime()) {
        Write-host "`r
`rRegistering Profile $($SsoAwsAccounts[$i].Profile)" -NoNewLine
        $TempCreds = $SSOToken | Get-SSORoleCredential -AccountId
$SsoAwsAccounts[$i].AccountId -RoleName $SsoAwsAccounts[$i].RoleName -Region $Region
@PsuedoCreds
        [PSCustomObject]@{AccessKey = $TempCreds.AccessKeyId; SecretKey =
$TempCreds.SecretAccessKey; SessionToken = $TempCreds.SessionToken
        } | Set-AWSCredential -StoreAs $SsoAwsAccounts[$i].Profile -ProfileLocation
$CredentialFile
        $SsoAwsAccounts[$i].CredsExpiration = $TempCreds.Expiration
    }
}
Set-Variable -name "$($EnvironmentName)SsoAwsAccounts" -Value $SsoAwsAccounts.Clone() -
Scope Global
Write-Host "`r$(($SsoAwsAccounts.Profile) Profiles registered, $CredsTimeText"

```



# Use AWS Config to monitor Amazon Redshift security configurations

Created by Lucas Kauffman (AWS) and abhishek sengar (AWS)

**Code repository:** [awslabs/aws-config-rules](#)

**Environment:** Production

**Technologies:** Security, identity, compliance

**AWS services:** AWS Config; Amazon Redshift; AWS Lambda

## Summary

Using AWS Config, you can evaluate the security configurations for your AWS resources. AWS Config can monitor the resources, and if configuration settings violate your defined rules, AWS Config flags the resource as *noncompliant*.

You can use AWS Config to evaluate and monitor your Amazon Redshift clusters and databases. For more information about security recommendations and features, see [Security in Amazon Redshift](#). This pattern includes custom AWS Lambda rules for AWS Config. You can deploy these rules in your account to monitor the security configurations of your Amazon Redshift clusters and databases. The rules in this pattern help you use AWS Config to confirm that:

- Audit logging is enabled for the databases in the Amazon Redshift cluster
- SSL is required to connect to the Amazon Redshift cluster
- Federal Information Processing Standards (FIPS) ciphers are in use
- Databases in the Amazon Redshift cluster are encrypted
- User activity monitoring is enabled

## Prerequisites and limitations

### Prerequisites

- An active AWS account.

- AWS Config must be enabled in your AWS account. For more information, see [Setting Up AWS Config with the Console](#) or [Setting Up AWS Config with the AWS CLI](#).
- Python version 3.9 or later must be used for the AWS Lambda handler. For more information, see [Working with Python](#) (AWS Lambda documentation).

## Product versions

- Python version 3.9 or later

## Architecture

### Target technology stack

- AWS Config

### Target architecture

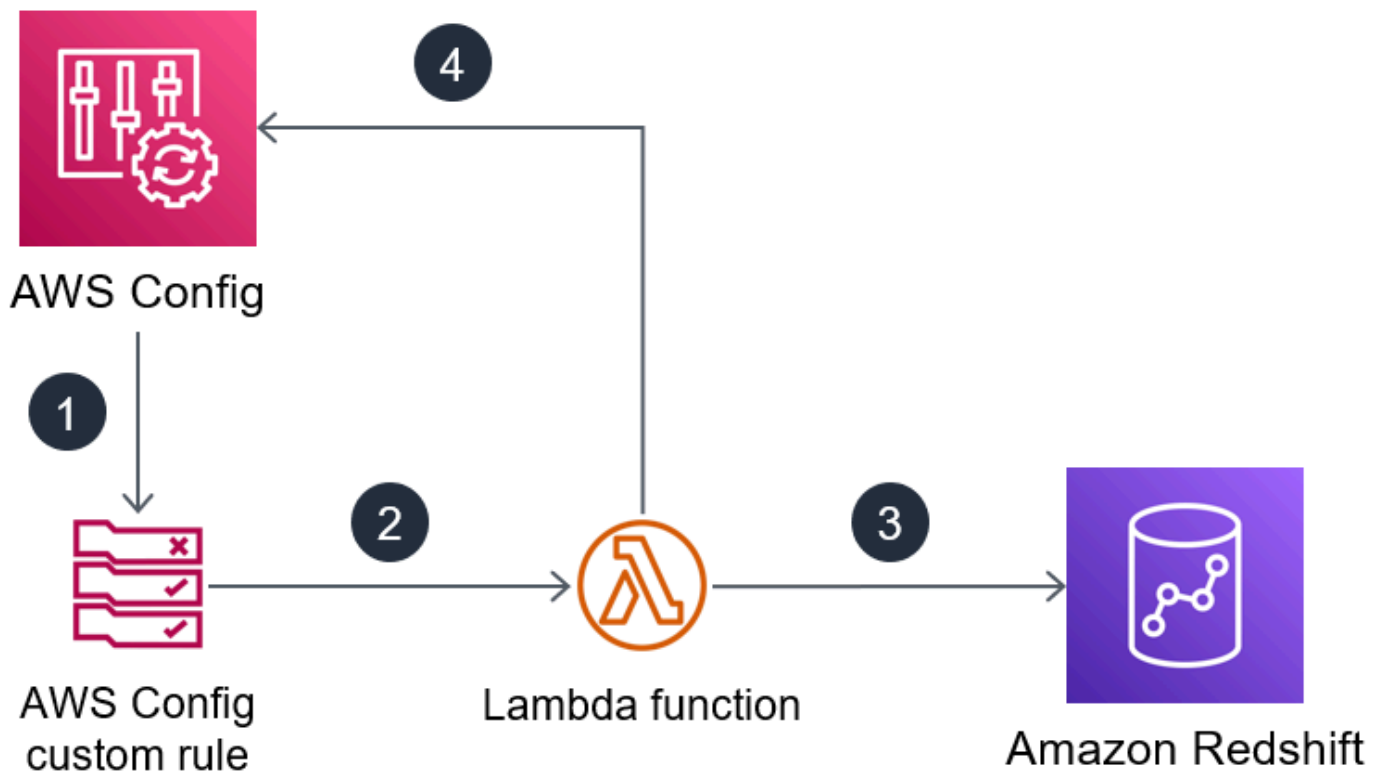

1. AWS Config periodically runs the custom rule.

2. The custom rule invokes the Lambda function.
3. The Lambda function checks the Amazon Redshift clusters for non-compliant configurations.
4. The Lambda function reports the compliance state of each Amazon Redshift cluster to AWS Config.

## Automation and scale

The AWS Config custom rules scale to assess all Amazon Redshift clusters in your account. No additional action is required to scale this solution.

## Tools

### AWS services

- [AWS Config](#) provides a detailed view of the resources in your AWS account and how they're configured. It helps you identify how resources are related to one another and how their configurations have changed over time.
- [AWS Identity and Access Management \(IAM\)](#) helps you securely manage access to your AWS resources by controlling who is authenticated and authorized to use them.
- [AWS Lambda](#) is a compute service that helps you run code without needing to provision or manage servers. It runs your code only when needed and scales automatically, so you pay only for the compute time that you use.
- [Amazon Redshift](#) is a managed petabyte-scale data warehouse service in the AWS Cloud.

### Code repository

The code for this pattern is available in the GitHub [aws-config-rules](#) repository. The custom rules in this repository are Lambda rules in the Python programming language. This repository contains many custom rules for AWS Config. Only the following rules are used in this pattern:

- REDSHIFT\_AUDIT\_ENABLED – Confirm that audit logging is enabled on the Amazon Redshift cluster. If you also want to confirm that user activity monitoring is enabled, deploy the REDSHIFT\_USER\_ACTIVITY\_MONITORING\_ENABLED rule instead.
- REDSHIFT\_SSL\_REQUIRED – Confirm that SSL is required to connect to the Amazon Redshift cluster. If you also want to confirm that Federal Information Processing Standards (FIPS) ciphers are in use, deploy the REDSHIFT\_FIPS\_REQUIRED rule instead.
- REDSHIFT\_FIPS\_REQUIRED – Confirm that SSL is required and FIPS ciphers are in use.

- REDSHIFT\_DB\_ENCRYPTED – Confirm that the databases in the Amazon Redshift cluster are encrypted.
- REDSHIFT\_USER\_ACTIVITY\_MONITORING\_ENABLED – Confirm that audit logging and user activity monitoring is enabled.

## Epics

### Prepare to deploy the rules

Task	Description	Skills required
Configure IAM policies.	<p>1. Create a custom IAM identity-based policy that allows the Lambda execution role to read the Amazon Redshift cluster configurations. For more information, see <a href="#">Managing access to resources</a> (Amazon Redshift documentation) and <a href="#">Creating IAM policies</a> (IAM documentation).</p> <pre data-bbox="630 1297 1029 1871"> {   "Version":   "2012-10-17",   "Statement": [     {       "Effect":       "Allow",       "Action": [         "redshift :DescribeClusterPa rameterGroups",         "redshift :DescribeClusterPa rameters", </pre>	AWS administrator

Task	Description	Skills required
	<pre data-bbox="646 205 1026 1138"> "redshift :DescribeClusters", "redshift :DescribeClusterSe curityGroups", "redshift :DescribeClusterSn apshots", "redshift :DescribeClusterSu bnetGroups", "redshift :DescribeEventSubs criptions", "redshift :DescribeLoggingSt atus" ], "Resource": "*" } ] } </pre> <p data-bbox="591 1155 1026 1570">2. Assign the <a href="#">AWSLambdaExecute</a> and <a href="#">AWSConfigRulesExecutionRole</a> managed policies as a permissions policy for the <a href="#">Lambda execution role</a>. For instructions, see <a href="#">Adding IAM identity permissions</a> (IAM documentation).</p>	

Task	Description	Skills required
Clone the repository.	<p>In a Bash shell, run the following command. This clones the <a href="#">aws-config-rules</a> repository from GitHub.</p> <pre>git clone https://github.com/awslabs/aws-config-rules.git</pre>	General AWS

## Deploy the rules in AWS Config

Task	Description	Skills required
Deploy the rules in AWS Config.	<p>Following the instructions in <a href="#">Creating custom Lambda rules</a> (AWS Config documentation), deploy one or more of the following rules in your account:</p> <ul style="list-style-type: none"> <li>• REDSHIFT_AUDIT_ENABLED</li> <li>• REDSHIFT_SSL_REQUIRED</li> <li>• REDSHIFT_FIPS_REQUIRED</li> <li>• REDSHIFT_DB_ENCRYPTED</li> <li>• REDSHIFT_USER_ACTIVITY_MONITORING_ENABLED</li> </ul>	AWS administrator
Verify the rules are functional.	After deploying the rules, follow the instructions in	General AWS

Task	Description	Skills required
	<a href="#">Evaluating your resources</a> (AWS Config documentation) to confirm that AWS Config is correctly evaluating your Amazon Redshift resources.	

## Related resources

### AWS service documentation

- [Security in Amazon Redshift](#) (Amazon Redshift documentation)
- [Managing database security](#) (Amazon Redshift documentation)
- [AWS Config custom rules](#) (AWS Config documentation)

### AWS Prescriptive Guidance

- [Verify that new Amazon Redshift clusters have required SSL endpoints](#)
- [Ensure an Amazon Redshift cluster is encrypted upon creation](#)

## Additional information

You can use the following AWS Managed Rules in AWS Config to confirm the following security configurations for Amazon Redshift:

- [redshift-cluster-configuration-check](#) – Use this rule to confirm that audit logging is enabled for the databases in the Amazon Redshift cluster and confirm that the databases are encrypted.
- [redshift-require-tls-ssl](#) – Use this rule to confirm that SSL is required to connect to the Amazon Redshift cluster.

# Use Network Firewall to capture the DNS domain names from the Server Name Indication (SNI) for outbound traffic

Created by Kirankumar Chandrashekar (AWS)

**Environment:** PoC or pilot

**Technologies:** Security, identity, compliance; Networking; Web & mobile apps

**Workload:** All other workloads

**AWS services:** AWS Lambda; AWS Network Firewall; Amazon VPC; Amazon CloudWatch Logs

## Summary

This pattern shows you how to use Amazon Web Services (AWS) Network Firewall to collect the DNS domain names that are provided by the Server Name Indication (SNI) in the HTTPS header of your outbound network traffic. Network Firewall is a managed service that makes it easy to deploy critical network protections for Amazon Virtual Private Cloud (Amazon VPC), including the ability to secure outbound traffic with a firewall that blocks packets that fail to meet certain security requirements. Securing outbound traffic to specific DNS domain names is called egress filtering, which is the practice of monitoring and potentially restricting the flow of outbound information from one network to another.

After you capture the SNI data that passes through Network Firewall, you can use Amazon CloudWatch Logs and AWS Lambda to publish the data to an Amazon Simple Notification Service (Amazon SNS) topic that generates email notifications. The email notifications include the server name and other relevant SNI information. Additionally, you can use the output of this pattern to allow or restrict outbound traffic by domain name in the SNI by using firewall rules. For more information, see [Working with stateful rule groups in AWS Network Firewall](#) in the Network Firewall documentation.



## Prerequisites and limitations

### Prerequisites

- An active AWS account
- [AWS Command Line Interface \(AWS CLI\)](#) version 2, installed and configured on Linux, macOS, or Windows
- [Network Firewall](#), set up and configured in Amazon VPC and in use for inspecting outbound traffic

**Note:** Network Firewall can use any of the following VPC configurations:

- [Simple single zone architecture with an internet gateway](#)
- [Multi zone architecture with an internet gateway](#)
- [Architecture with an internet gateway and a NAT gateway](#)

## Architecture

The following diagram shows how to use Network Firewall to collect SNI data from outbound network traffic, and then publish that data to an SNS topic by using CloudWatch Logs and Lambda.

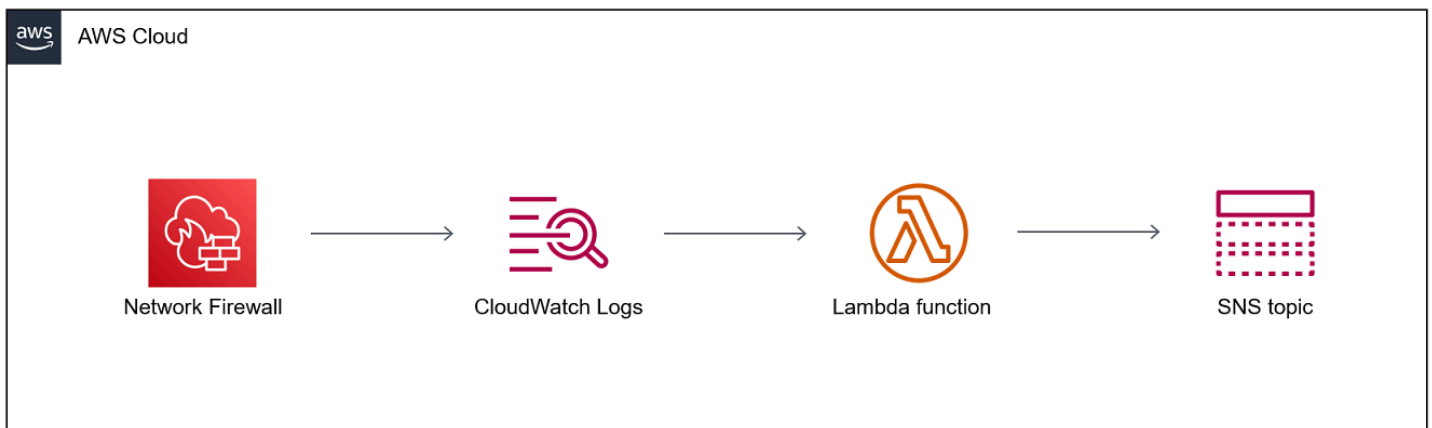

The diagram shows the following workflow:

1. Network Firewall collects domain names from the SNI data in the HTTPS header of your outbound network traffic.

2. CloudWatch Logs monitors the SNI data and invokes a Lambda function whenever the outbound network traffic passes through Network Firewall.
3. The Lambda function reads the SNI data captured by CloudWatch Logs and then publishes that data to an SNS topic.
4. The SNS topic sends you an email notification that includes the SNI data.

## Automation and scale

- You can use [AWS CloudFormation](#) to create this pattern by using [infrastructure as code](#).

## Technology stack

- Amazon CloudWatch Logs
- Amazon SNS
- Amazon VPC
- AWS Lambda
- AWS Network Firewall

## Tools

### AWS services

- [Amazon CloudWatch Logs](#) – You can use Amazon CloudWatch Logs to monitor, store, and access your log files from Amazon Elastic Compute Cloud (Amazon EC2) instances, AWS CloudTrail, Amazon Route 53, and other sources.
- [Amazon SNS](#) – Amazon Simple Notification Service (Amazon SNS) is a managed service that provides message delivery from publishers to subscribers (also known as producers and consumers).
- [Amazon VPC](#) – Amazon Virtual Private Cloud (Amazon VPC) provisions a logically isolated section of the AWS Cloud where you can launch AWS resources in a virtual network that you've defined. This virtual network closely resembles a traditional network that you'd operate in your own data center, with the benefits of using the scalable infrastructure of AWS.
- [AWS Lambda](#) – AWS Lambda is a compute service that lets you run code without provisioning or managing servers.

- [AWS Network Firewall](#) – AWS Network Firewall is a managed service that makes it easy to deploy essential network protections for all of your Amazon VPCs.

## Epics

### Create a CloudWatch log group for Network Firewall

Task	Description	Skills required
Create a CloudWatch log group.	<ol style="list-style-type: none"> <li>1. Sign in to the AWS Management Console and open the <a href="#">CloudWatch console</a>.</li> <li>2. In the navigation pane, choose <b>Log groups</b>.</li> <li>3. Choose <b>Actions</b>, and then choose <b>Create log group</b>.</li> <li>4. Enter a name for the log group, and then choose <b>Create log group</b>.</li> </ol> <p>For more information, see <a href="#">Working with log groups and log streams</a> in the CloudWatch documentation.</p>	Cloud administrator

### Create an SNS topic and subscription

Task	Description	Skills required
Create an SNS topic.	To create an SNS topic, follow the instructions in the <a href="#">Amazon SNS documentation</a> .	Cloud administrator

Task	Description	Skills required
Subscribe an endpoint to the SNS topic.	To subscribe an email address as an endpoint to the SNS topic that you created, follow the instructions in the <a href="#">Amazon SNS documentation</a> . For <b>Protocol</b> , choose <a href="#">Email/Email-JSON</a> . <b>Note:</b> You can also choose a different endpoint based on your requirements.	Cloud administrator

## Set up logging in Network Firewall

Task	Description	Skills required
Enable firewall logging.	<ol style="list-style-type: none"> <li>1. Sign in to the AWS Management Console and open the <a href="#">Amazon VPC console</a>.</li> <li>2. In the navigation pane, under <b>NETWORK FIREWALL</b>, choose <b>Firewalls</b>.</li> <li>3. In the <b>Firewalls</b> section, choose the firewall where you want to capture the server name from the SNI for outbound traffic.</li> <li>4. Choose the <b>Firewall details</b> tab, and then choose <b>Edit</b> in the <b>Logging</b> section.</li> </ol>	Cloud administrator

Task	Description	Skills required
	<p>5. For <b>Log type</b>, select <b>Alert</b>. For <b>Log destination for alerts</b>, select <b>CloudWatch log group</b>.</p> <p>6. For <b>CloudWatch log group</b>, search for and choose the log group that you created earlier, and then choose <b>Save</b>.</p> <p>For more information about using CloudWatch Logs as a log destination for Network Firewall, see <a href="#">Amazon CloudWatch Logs</a> in the Network Firewall documentation.</p>	

## Set up a stateful rule in Network Firewall

Task	Description	Skills required
Create a stateful rule.	<ol style="list-style-type: none"> <li>1. Sign in to the AWS Management Console and open the <a href="#">Amazon VPC console</a>.</li> <li>2. In the navigation pane, under <b>NETWORK FIREWALL</b>, choose <b>Network Firewall Rule Groups</b>.</li> <li>3. Choose <b>Create Network Firewall rule group</b>.</li> </ol>	Cloud administrator

Task	Description	Skills required
	<ol style="list-style-type: none"><li data-bbox="591 212 1024 579">4. On the <b>Create Network Firewall rule group</b> page, for the <b>Rule group type</b>, choose <b>Stateful rule group</b>. <b>Note:</b> For more information, see <a href="#">Working with stateful rule groups in AWS Network Firewall</a>.</li><li data-bbox="591 600 1008 779">5. In the <b>Stateful rule group</b> section, enter a name and description for the rule group.</li><li data-bbox="591 800 1024 1503">6. For <b>Capacity</b>, set the maximum capacity that you want to allow for the stateful rule group (up to the maximum of 30,000). <b>Note:</b> You can't change this setting after you create the rule group. For information about how to calculate capacity, see <a href="#">Setting rule group capacity in AWS Network Firewall</a>. For information about the maximum setting, see <a href="#">AWS Network Firewall quotas</a>.</li><li data-bbox="591 1524 971 1608">7. For <b>Stateful rule group options</b>, select <b>5-tuple</b>.</li><li data-bbox="591 1629 1003 1713">8. In the <b>Stateful rule order</b> section, choose <b>Default</b>.</li><li data-bbox="591 1734 1000 1860">9. In the <b>Rule variables</b> section, keep the default values.</li></ol>	

Task	Description	Skills required
	<p>10In the <b>Add rule</b> section, choose <b>TLS</b> for <b>Protocol</b>. For <b>Source</b>, choose <b>Any</b>. For <b>Source port</b>, choose <b>Any port</b>. For <b>Destination</b>, choose <b>Any</b>. For <b>Destination port</b>, choose <b>Any port</b>. For <b>Traffic direction</b>, choose <b>Forward</b>. For <b>Action</b>, choose <b>Alert</b>. Choose <b>Add rule</b>.</p> <p>11Choose <b>Create stateful rule group</b>.</p>	

Task	Description	Skills required
Associate the stateful rule to Network Firewall.	<ol style="list-style-type: none"> <li>1. Sign in to the AWS Management Console and open the <a href="#">Amazon VPC console</a>.</li> <li>2. In the navigation pane, under <b>NETWORK FIREWALL</b>, choose <b>Firewalls</b>.</li> <li>3. Choose the firewall where you want to capture the server name from the SNI for outbound traffic.</li> <li>4. In the <b>Stateful rule groups</b> section, choose <b>Actions</b>, and then choose <b>Add unmanaged stateful rule groups</b>.</li> <li>5. On the <b>Add unmanaged stateful rule groups</b> page, select the stateful rule group that you created earlier, and then choose <b>Add stateful rule group</b>.</li> </ol>	Cloud administrator

### Create a Lambda function to read the logs

Task	Description	Skills required
Create the code for the Lambda function.	In an integrated development environment (IDE) that can read the CloudWatch Logs event from Network Firewall for outbound traffic, paste in	App developer



Task	Description	Skills required
	<p>the following Python 3 code and replace &lt;SNS-topic-ARN&gt; with your value:</p> <pre data-bbox="592 380 1029 1862">import json import gzip import base64 import boto3 sns_client = boto3.client('sns') def lambda_handler(event, context):     decoded_event =     json.loads(gzip.decompress(base64.b64decode(event['awslogs']['data'])))     body = ''     {filtermatch}     ''.format(         loggroup=         decoded_event['logGroup'],         logstream         =decoded_event['logStream'],         filtermat         ch=decoded_event['logEvents'][0]['message'],     )     print(body)     filterMatch =     json.loads(body)     data = []     if 'http' in     filterMatch['event']:         data.append(filterMatch['event']['http']['hostname'])</pre>	

Task	Description	Skills required
	<pre> elif 'tls' in   filterMatch['event']:     data.append(       filterMatch['event']['tls']['sni'])     result = 'Domain accessed ' + 1* ' ' + (data[0]) + 1* ' ' + 'via AWS Network Firewall ' + 1* ' ' + (filterMa tch['firewall_name'])     print(result)     message = {'ServerName': result}     send_to_sns = sns_client.publish(     TargetArn=&lt;SNS- topic-ARN&gt;,     #Replace with the SNS topic ARN     Message=json.dumps({'default': json.dumps(message),  'sms': json.dumps(message),  'email': json.dumps(message)}),     Subject='Server Name passed through the Network Firewall',     MessageStructure='json' ) </pre> <p>This code sample parses the CloudWatch Logs content and captures the server name</p>	

Task	Description	Skills required
	provided by the SNI in the HTTPS header.	
Create the Lambda function.	To create the Lambda function, follow the instructions in the <a href="#">Lambda documentation</a> and choose <b>Python 3.9</b> for Runtime.	Cloud administrator
Add the code to the Lambda function.	To add your Python code to the Lambda function that you created earlier, follow the instructions in the <a href="#">Lambda documentation</a> .	Cloud administrator

Task	Description	Skills required
Add CloudWatch Logs as a trigger to the Lambda function.	<ol style="list-style-type: none"><li>1. Sign in to the AWS Management Console and open the <a href="#">Lambda console</a>.</li><li>2. In the navigation pane, choose <b>Functions</b>, and then choose the function that you created earlier.</li><li>3. In the <b>Function overview</b> section, choose <b>Add trigger</b>.</li><li>4. On the <b>Add trigger</b> page, in the <b>Trigger configuration</b> section, choose <b>CloudWatch Logs</b>, and then choose <b>Add</b>.</li><li>5. For <b>Log group</b>, choose the CloudWatch log group that you created earlier.</li><li>6. For <b>Filter name</b>, enter a name for your filter.</li><li>7. Choose <b>Add</b>.</li><li>8. On the <b>Configuration</b> tab of your function's page, in the <b>Triggers</b> section, select the trigger that you just added, and then choose <b>Enable</b>.</li></ol> <p>For more information, see <a href="#">Using Lambda with CloudWatch Logs</a> in the Lambda documentation.</p>	Cloud administrator

Task	Description	Skills required
Add SNS publish permissions.	<p>Add the <b>sns:Publish</b> permission to the Lambda execution role, so that Lambda can make API calls to publish messages to SNS.</p> <ol style="list-style-type: none"><li>1. <a href="#">Find the execution role</a> of the Lambda function that you created earlier.</li><li>2. <a href="#">Add the following policy</a> to your AWS Identity and Access Management (IAM) role:</li></ol> <pre data-bbox="592 898 1027 1869">{   "Version":     "2012-10-17",   "Statement": [     {       "Sid":         "AllowSNSPublish",       "Effect":         "Allow",       "Action": [         "sns:GetTopicAttri butes",         "sns:Subscribe",         "sns:Unsubscribe",         "sns:Publish"       ],       "Resource":         "*"     }   ] }</pre>	Cloud administrator

Task	Description	Skills required
	}	

## Test the functionality of your SNS notification

Task	Description	Skills required
Send traffic through Network Firewall.	<ol style="list-style-type: none"> <li>1. Send or wait for HTTPS traffic to pass through Network Firewall.</li> <li>2. Check the SNS notification email that you receive from AWS when traffic passes through Network Firewall. The email includes the SNI details for outbound traffic. For example, the email generated from the Lambda code above will have the following content if the accessed domain name is <b>https://aws.amazon.com</b> and the subscription protocol is <b>EMAIL-JSON</b>: </li> </ol> <pre> {   "Type": "Notifica tion",   "MessageId": "&lt;messageID&gt;",   "TopicArn": "arn:aws:sns:us-we st-2:123456789:tes tSNSTopic", </pre>	Test engineer

Task	Description	Skills required
	<pre data-bbox="609 210 1015 1144">    "Subject": "Server Name passed through the Network Firewall",     "Message":     "{\"ServerName\":     \"Domain 'aws.amaz on.com' accessed via AWS Network Firewall 'AWS-Network-Firew all-Multi-AZ-firewall \"}\",     "Timestamp":     "2022-03-22T04:10: 04.217Z",     "SignatureVersion" : "1",     "Signature":     "&lt;Signature&gt;",     "SigningCertURL":     "&lt;SigningCertUrl&gt;",     "UnsubscribeURL":     "&lt;UnsubscribeURL&gt;" }</pre> <p data-bbox="592 1176 1015 1501">Then, check the Network Firewall alert log in Amazon CloudWatch by following the instructions in the <a href="#">Amazon CloudWatch documentation</a>. The alert log shows the following output:</p> <pre data-bbox="609 1533 1015 1827">{   "firewall_name":   "AWS-Network-Firew all-Multi-AZ-firew all",   "availability_zone ": "us-east-2b",</pre>	

Task	Description	Skills required
	<pre> "event_timestamp": "&lt;event timestamp&gt;", "event": {   "timestamp": "2021-03-22T04:10: 04.214222+0000",   "flow_id": &lt;flow ID&gt;,   "event_type": "alert",   "src_ip": "10.1.3.76",   "src_port": 22761,   "dest_ip": "99.86.59.73",   "dest_port": 443,   "proto": "TCP",   "alert": {     "action": "allowed",     "signature_id": 2,     "rev": 0,     "signature": "",     "category": "",     "severity": 3   },   "tls": {     "subject": "CN=aws.amazon.com",     "issuerdn": "C=US, O=Amazon, OU=Server CA 1B, CN=Amazon",     "serial": "&lt;serial number&gt;", </pre>	



Task	Description	Skills required
	<pre>        "fingerprint": "&lt;fingerprint ID&gt;",         "sni":           "aws.amazon.com",         "version":           "TLS 1.2",         "notbefore": "2020-09-30T00:00:00",         "notafter": "2021-09-23T12:00:00",         "ja3": {},         "ja3s": {}       },       "app_proto":         "tls"     }   }</pre>	

# Use Terraform to automatically enable Amazon GuardDuty for an organization

Created by Arthi Kannan (AWS)

<b>Code repository:</b> <a href="#">amazon-guardduty-for-aws-organizations-with-terraform</a>	<b>Environment:</b> Production	<b>Technologies:</b> Security, identity, compliance; DevOps
<b>Workload:</b> All other workloads	<b>AWS services:</b> Amazon GuardDuty; AWS Organizations	

## Summary

Amazon GuardDuty continuously monitors your Amazon Web Services (AWS) accounts and uses threat intelligence to identify unexpected and potentially malicious activity within your AWS environment. Manually enabling GuardDuty for multiple accounts or organizations, across multiple AWS Regions, or through the AWS Management Console can be cumbersome. You can automate the process by using an infrastructure as code (IaC) tool, such as Terraform, which can provision and manage multi-account, multi-Region services and resources in the cloud.

AWS recommends using AWS Organizations to set up and manage multiple accounts in GuardDuty. This pattern adheres to that recommendation. One benefit of this approach is that, when new accounts are created or added to the organization, GuardDuty will be auto-enabled in these accounts for all supported Regions, without the need for manual intervention.

This pattern demonstrates how to use HashiCorp Terraform to enable Amazon GuardDuty for three or more Amazon Web Services (AWS) accounts in an organization. The sample code provided with this pattern does the following:

- Enables GuardDuty for all AWS accounts that are current members of the target organization in AWS Organizations
- Turns on the *Auto-Enable* feature in GuardDuty, which automatically enables GuardDuty for any accounts that are added to the target organization in the future

- Allows you select the Regions where you want to enable GuardDuty
- Uses the organization's security account as the GuardDuty delegated administrator
- Creates an Amazon Simple Storage Service (Amazon S3) bucket in the logging account and configures GuardDuty to publish the aggregated findings from all accounts in this bucket
- Assigns a life-cycle policy that transitions findings from the S3 bucket to Amazon S3 Glacier Flexible Retrieval storage after 365 days, by default

You can manually run this sample code, or you can integrate it into your continuous integration and continuous delivery (CI/CD) pipeline.

### Target audience

This pattern is recommended for users who have experience with Terraform, Python, GuardDuty, and AWS Organizations.

## Prerequisites and limitations

### Prerequisites

- An active AWS account.
- An organization is set up in AWS Organizations, and it contains at least the following three accounts:
  - **A management account** – This is the account from which you deploy the Terraform code, either standalone or as part of the CI/CD pipeline. The Terraform state is also stored in this account.
  - **A security account** – This account is used as the GuardDuty delegated administrator. For more information, see [Important considerations for GuardDuty delegated administrators](#) (GuardDuty documentation).
  - **A logging account** – This account contains the S3 bucket where GuardDuty publishes the aggregated findings from all member accounts.

For more information about how to set up the organization with the required configuration, see [Create an account structure](#) (AWS Well-Architected Labs).

- An Amazon S3 bucket and an Amazon DynamoDB table that serve as a remote backend to store Terraform's state in the management account. For more information on using remote backends for the Terraform state, see [S3 Backends](#) (Terraform documentation). For a code sample that

sets up remote state management with an S3 backend, see [remote-state-s3-backend](#) (Terraform Registry). Note the following requirements:

- The S3 bucket and DynamoDB table must be in the same Region.
- When creating the DynamoDB table, the partition key must be LockID (case-sensitive), and the partition key type must be **String**. All other table settings must be at their default values. For more information, see [About primary keys](#) and [Create a table](#) (DynamoDB documentation).
- An S3 bucket that will be used to store access logs for the S3 bucket in which GuardDuty will publish findings. For more information, see [Enabling Amazon S3 server access logging](#) (Amazon S3 documentation). If you're deploying to an AWS Control Tower landing zone, you can reuse the S3 bucket in the **log archive** account for this purpose.
- Terraform version 0.14.6 or later is installed and configured. For more information, see [Get Started – AWS](#) (Terraform documentation).
- Python version 3.9.6 or later is installed and configured. For more information, see [Source releases](#) (Python website).
- AWS SDK for Python (Boto3) is installed. For more information, see [Installation](#) (Boto3 documentation).
- jq is installed and configured. For more information, see [Download jq](#) (jq documentation).

## Limitations

- This pattern supports macOS and Amazon Linux 2 operating systems. This pattern has not been tested for use in Windows operating systems.

**Note:** Amazon Linux 2 is nearing end of support. For more information, see the [Amazon Linux 2 FAQs](#).

- GuardDuty must not already be enabled in any of the accounts, in any of the target Regions.
- The IaC solution in this pattern does not deploy the prerequisites.
- This pattern is designed for an AWS landing zone that adheres to the following best practices:
  - The landing zone was created by using AWS Control Tower.
  - Separate AWS accounts are used for security and logging.

## Product versions

- Terraform version 0.14.6 or later. The sample code has been tested for version 1.2.8.

- Python version 3.9.6 or later.

## Architecture

This section gives a high-level overview of this solution and the architecture established by the sample code. The following diagram shows the resources deployed across the various accounts in the organization, within a single AWS Region.

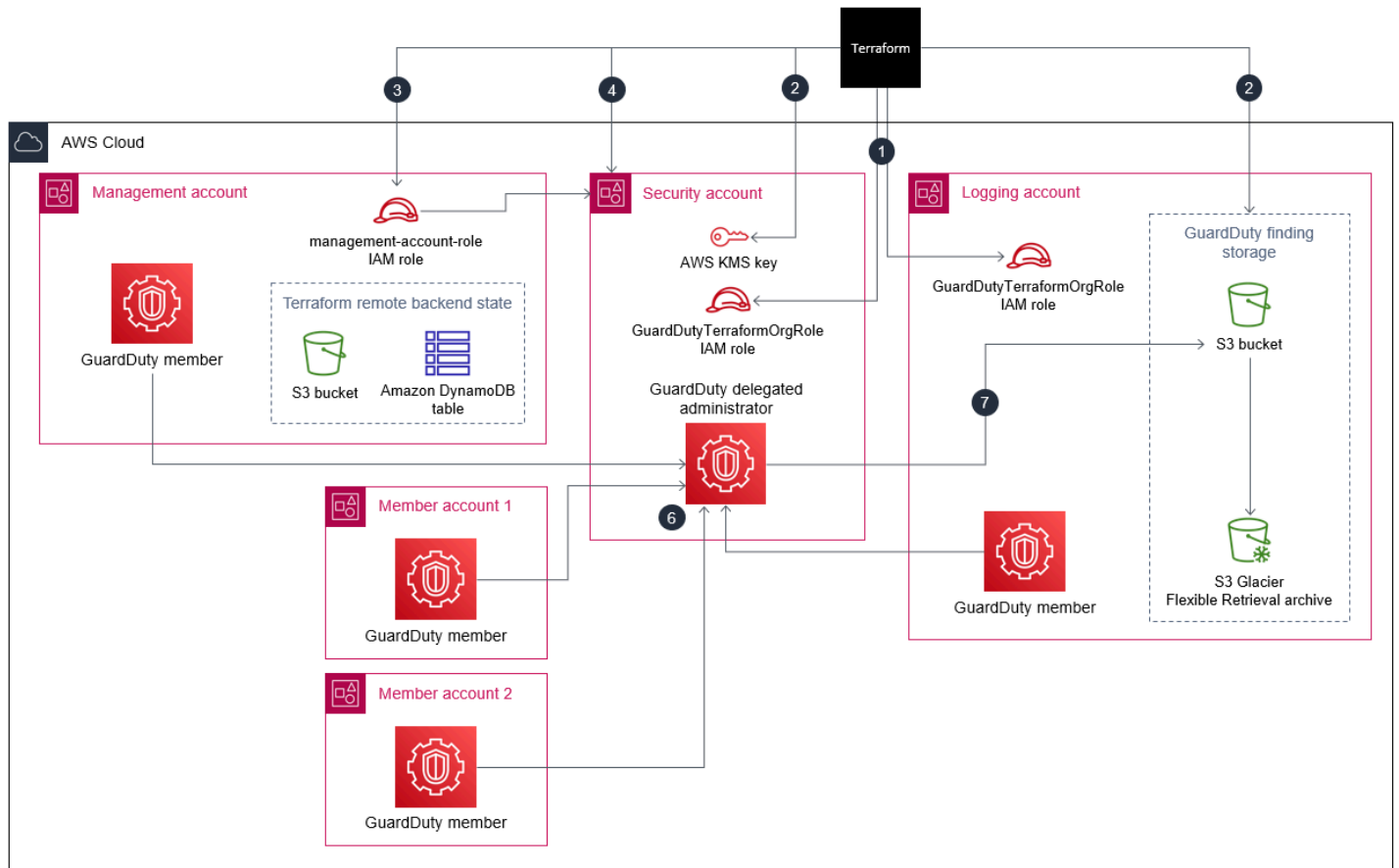

1. Terraform creates the **GuardDutyTerraformOrgRole** AWS Identity and Access Management (IAM) role in the security account and the logging account.
2. Terraform creates an S3 bucket in the default AWS Region in the logging account. This bucket is used as the publishing destination to aggregate all GuardDuty findings across all Regions and from all accounts in the organization. Terraform also creates an AWS Key Management Service (AWS KMS) key in the security account that is used to encrypt the findings in the S3 bucket and configures automatic archiving of findings from the S3 bucket into S3 Glacier Flexible Retrieval storage.

3. From the management account, Terraform designates the security account as the delegated administrator for GuardDuty. This means that the security account now manages the GuardDuty service for all member accounts, including the management account. Individual member accounts cannot suspend or disable GuardDuty by themselves.
4. Terraform creates the GuardDuty detector in the security account, for the GuardDuty delegated administrator.
5. If it is not already enabled, Terraform enables S3 protection in GuardDuty. For more information, see [Amazon S3 protection in Amazon GuardDuty](#) (GuardDuty documentation).
6. Terraform enrolls all current, active member accounts in the organization as GuardDuty members.
7. Terraform configures the GuardDuty delegated administrator to publish the aggregated findings from all member accounts to the S3 bucket in the logging account.
8. Terraform repeats steps 3 through 7 for each AWS Region you choose.

## Automation and scale

The sample code provided is modularized so that you can integrate it into your CI/CD pipeline for automated deployment.

## Tools

### AWS services

- [Amazon DynamoDB](#) is a fully managed NoSQL database service that provides fast, predictable, and scalable performance.
- [Amazon GuardDuty](#) is a continuous security monitoring service that analyzes and processes logs to identify unexpected and potentially unauthorized activity in your AWS environment.
- [AWS Identity and Access Management \(IAM\)](#) helps you securely manage access to your AWS resources by controlling who is authenticated and authorized to use them.
- [AWS Key Management Service \(AWS KMS\)](#) helps you create and control cryptographic keys to protect your data.
- [AWS Organizations](#) is an account management service that helps you consolidate multiple AWS accounts into an organization that you create and centrally manage.
- [Amazon Simple Storage Service \(Amazon S3\)](#) is a cloud-based object storage service that helps you store, protect, and retrieve any amount of data.

- [AWS SDK for Python \(Boto3\)](#) is a software development kit that helps you integrate your Python application, library, or script with AWS services.

## Other tools and services

- [HashiCorp Terraform](#) is a command-line interface application that helps you use code to provision and manage cloud infrastructure and resources.
- [Python](#) is a general-purpose programming language.
- [jq](#) is a command-line processor that helps you work with JSON files.

## Code repository

The code for this pattern is available on GitHub, in the [amazon-guardduty-for-aws-organizations-with-terraform](#) repository.

## Epics

### Enable GuardDuty in the organization

Task	Description	Skills required
Clone the repository.	<p>In a Bash shell, run the following command. In <i>Clone the repository</i> in the <a href="#">Additional information</a> section, you can copy the full command containing the URL of the GitHub repository. This clones the <a href="#">amazon-guardduty-for-aws-organizations-with-terraform</a> repository from GitHub.</p> <pre>git clone &lt;github-repository-url&gt;</pre>	DevOps engineer

Task	Description	Skills required
Edit the Terraform configuration file.	<ol style="list-style-type: none"><li data-bbox="591 226 1027 453">1. In the root folder of the cloned repository, replicate the <b>configuration.json.sample</b> file by running the following command. <pre data-bbox="634 491 1027 646">cp configuration.json.sample configuration.json</pre></li><li data-bbox="591 663 1027 1793">2. Edit the new <b>configuration.json</b> file, and define the values for each of the following variables:<ul style="list-style-type: none"><li data-bbox="630 867 990 995">• <code>management_acc_id</code> – Account ID of the management account.</li><li data-bbox="630 1020 990 1148">• <code>delegated_admin_acc_id</code> – Account ID of the security account.</li><li data-bbox="630 1173 990 1302">• <code>logging_acc_id</code> – Account ID of the logging account.</li><li data-bbox="630 1327 990 1549">• <code>target_regions</code> – Comma-separated list of AWS Regions where you want to enable GuardDuty.</li><li data-bbox="630 1575 990 1799">• <code>organization_id</code> – AWS Organizations ID of the organization in which you are enabling GuardDuty.</li></ul></li></ol>	DevOps engineer, General AWS, Terraform, Python



Task	Description	Skills required
	<ul style="list-style-type: none"><li>• <code>default_region</code> – The Region where your Terraform state is stored in the management account. This is the same Region where you deployed the S3 bucket and DynamoDB table for the Terraform backend.</li><li>• <code>role_to_assume_for_role_creation</code> – Name that you want to assign to a new IAM role in the security and logging accounts. You create this new role in the next story. Terraform assumes this role to create the GuardDuty TerraformOrgRole IAM role in the security and logging accounts.</li><li>• <code>finding_publishing_frequency</code> – Frequency at which GuardDuty publishes findings to the S3 bucket.</li><li>• <code>guardduty_findings_bucket_region</code> – Preferred Region where you want to create the S3 bucket for published findings.</li></ul>	

Task	Description	Skills required
	<ul style="list-style-type: none"><li>• <code>logging_acc_s3_bucket_name</code> – Preferred name for the S3 bucket for published findings.</li><li>• <code>security_acc_kms_key_alias</code> – AWS KMS alias for the key used to encrypt GuardDuty findings.</li><li>• <code>s3_access_log_bucket_name</code> – Name of a preexisting S3 bucket where you want to collect access logs for the S3 bucket used for GuardDuty findings. This bucket should be in the same AWS Region as the GuardDuty findings bucket.</li><li>• <code>tfm_state_backend_s3_bucket</code> – Name of the preexisting S3 bucket to store the Terraform remote backend state.</li><li>• <code>tfm_state_backend_dynamodb_table</code> – Name of the preexisting DynamoDB table for locking the Terraform state.</li></ul> <p>3. Save and close the configuration file.</p>	

Task	Description	Skills required
Generate CloudFormation templates for new IAM roles.	<p>This pattern includes an IaC solution to create two CloudFormation templates. These templates create two IAM roles that Terraform uses during the setup process. These templates adhere to the security best practice of <a href="#">least-privilege permissions</a>.</p> <ol style="list-style-type: none"><li>1. In a Bash shell, in the repository root folder, navigate to <code>cfn-templates/</code>. This folder contains CloudFormation templates files with stubs.</li><li>2. Run the following command. This replaces the stubs with the values you provided in the <b>configuration.json</b> file. <pre>bash scripts/replace_config_stubs.sh</pre></li><li>3. Confirm that the following CloudFormation templates were created in the <code>cfn-templates/</code> folder:<ul style="list-style-type: none"><li>• <b>management-account-role.yaml</b> – This file contains the role definition and the associated permissions</li></ul></li></ol>	DevOps engineer, General AWS

Task	Description	Skills required
	<p>for the IAM role in the management account, which has the minimum permissions required to complete this pattern.</p> <ul style="list-style-type: none"><li>• <b>role-to-assume-for-role-creation.yaml</b> – This file contains the role definition and the associated permissions for the IAM role in the security and logging accounts. Terraform assumes this role in order to create the <b>GuardDutyTerraformOrgRole</b> role in these accounts.</li></ul>	

Task	Description	Skills required
Create the IAM roles.	<p>Following the instructions in <a href="#">Creating a stack</a> (CloudFormation documentation), do the following:</p> <ol style="list-style-type: none"><li>1. Deploy the <b>role-to-assume-for-role-creation.yaml</b> stack in both the security and logging accounts.</li><li>2. Deploy the <b>management-account-role.yaml</b> stack in the management account. When you successfully create the stack and see the CREATE_COMPLETE stack status, in the output, make note of the Amazon Resource Name (ARN) of this new role.</li></ol>	DevOps engineer, General AWS
Assume the IAM role in the management account.	<p>As a security best practice, we recommend that you assume the new <b>management-account-role</b> IAM role before proceeding. In the AWS Command Line Interface (AWS CLI), enter the command in <i>Assume the management account IAM role</i> in the <a href="#">Additional Information</a> section.</p>	DevOps engineer, General AWS

Task	Description	Skills required
Run the setup script.	<p>In the repository root folder, run the following command to start the setup script.</p> <pre data-bbox="597 394 1026 512">bash scripts/full-setup .sh</pre> <p>The <b>full-setup.sh</b> script performs the following actions:</p> <ul data-bbox="597 730 1026 1822" style="list-style-type: none"><li>• Exports all configuration values as environment variables</li><li>• Generates the <b>backend.tf</b> and <b>terraform.tfvars</b> code files for each Terraform module</li><li>• Enables trusted access for GuardDuty in the organization through the AWS CLI.</li><li>• Imports the organization state into the Terraform state</li><li>• Creates the S3 bucket for publishing findings in the logging account</li><li>• Creates the AWS KMS key for encrypting findings in the security account</li><li>• Enables GuardDuty across the organization, in all selected Regions, as</li></ul>	DevOps engineer, Python

Task	Description	Skills required
	described in the <a href="#">Architecture</a> section	

### (Optional) Disable GuardDuty in the organization

Task	Description	Skills required
Run the clean-up script.	<p>If you used this pattern to enable GuardDuty for the organization and want to disable GuardDuty, in the repository root folder, run the following command to start the <b>cleanup-gd.sh</b> script.</p> <pre data-bbox="594 989 1029 1108">bash scripts/cleanup-gd .sh</pre> <p>This script disables GuardDuty in the target organization, removes any deployed resources, and restores the organization to its previous state before using Terraform to enable GuardDuty.</p> <p><b>Note</b> This script does not remove the Terraform state files or lock files from the local and remote backends. If you need to do so, you must perform these actions manually. Also, this script does not delete the imported</p>	DevOps engineer, General AWS, Terraform, Python

Task	Description	Skills required
	organization or the accounts managed by it. Trusted access for GuardDuty isn't disabled as part of the clean-up script.	
Remove IAM roles.	Delete the stacks that were created with the <b>role-to-assume-for-role-creation.yaml</b> and <b>management-account-role.yaml</b> CloudFormation templates. For more information, see <a href="#">Deleting a stack</a> (CloudFormation documentation).	DevOps engineer, General AWS

## Related resources

### *AWS documentation*

- [Managing multiple accounts](#) (GuardDuty documentation)
- [Granting least privilege](#) (IAM documentation)

### *AWS marketing*

- [Amazon GuardDuty](#)
- [AWS Organizations](#)

### *Other resources*

- [Terraform](#)
- [Terraform CLI Documentation](#)



## Additional information

### Clone the repository

Run the following command to clone the GitHub repository.

```
git clone https://github.com/aws-samples/amazon-guardduty-for-aws-organizations-with-terraform
```

### Assume the management account IAM role

To assume the IAM role in the management account, run the following command. Replace <IAM role ARN> with the ARN of the IAM role.

```
export ROLE_CREDENTIALS=$(aws sts assume-role --role-arn <IAM role ARN> --role-session-name AWSCLI-Session --output json)
export AWS_ACCESS_KEY_ID=$(echo $ROLE_CREDENTIALS | jq .Credentials.AccessKeyId | sed 's/"//g')
export AWS_SECRET_ACCESS_KEY=$(echo $ROLE_CREDENTIALS | jq .Credentials.SecretAccessKey | sed 's/"//g')
export AWS_SESSION_TOKEN=$(echo $ROLE_CREDENTIALS | jq .Credentials.SessionToken | sed 's/"//g')
```

# Verify that new Amazon Redshift clusters have required SSL endpoints

Created by Priyanka Chaudhary (AWS)

**Environment:** Production

**Technologies:** Security, identity, compliance; Analytics

**AWS services:** AWS CloudTrail; Amazon CloudWatch Events; Amazon Redshift; Amazon SNS; AWS Lambda

## Summary

This pattern provides an Amazon Web Services (AWS) CloudFormation template that automatically notifies you when a new Amazon Redshift cluster is launched without Secure Sockets Layer (SSL) endpoints.

Amazon Redshift is a fully managed, petabyte-scale, cloud-based data warehouse service. It is designed for large-scale dataset storage and analysis. It is also used to perform large-scale database migrations. For security, Amazon Redshift supports SSL to encrypt the connection between the user's SQL Server client application and the Amazon Redshift cluster. To configure your cluster to require an SSL connection, you set the `require_ssl` parameter to `true` in the parameter group that is associated with the cluster during launch.

The security control provided with this pattern monitors Amazon Redshift API calls in AWS CloudTrail logs and initiates an Amazon CloudWatch Events event for the [CreateCluster](#), [ModifyCluster](#), [RestoreFromClusterSnapshot](#), [CreateClusterParameterGroup](#), and [ModifyClusterParameterGroup](#) APIs. When the event detects one of these APIs, it calls AWS Lambda, which runs a Python script. The Python function analyzes the CloudWatch event for the listed CloudTrail events. When an Amazon Redshift cluster is created, modified, or restored from an existing snapshot, a new parameter group is created for the cluster, or an existed parameter group is modified, the function checks the `require_ssl` parameter for the cluster. If the parameter value is `false`, the function sends an Amazon Simple Notification Service (Amazon SNS) notification to the user with the relevant information: the Amazon Redshift cluster name, AWS Region, AWS account, and Amazon Resource Name (ARN) for Lambda that this notification is sourced from.

## Prerequisites and limitations

### Prerequisites

- An active AWS account.
- A virtual private cloud (VPC) with a cluster subnet group, and an associated security group.

### Limitations

- This security control is regional. You must deploy it in each AWS Region you want to monitor.

## Architecture

### Target architecture

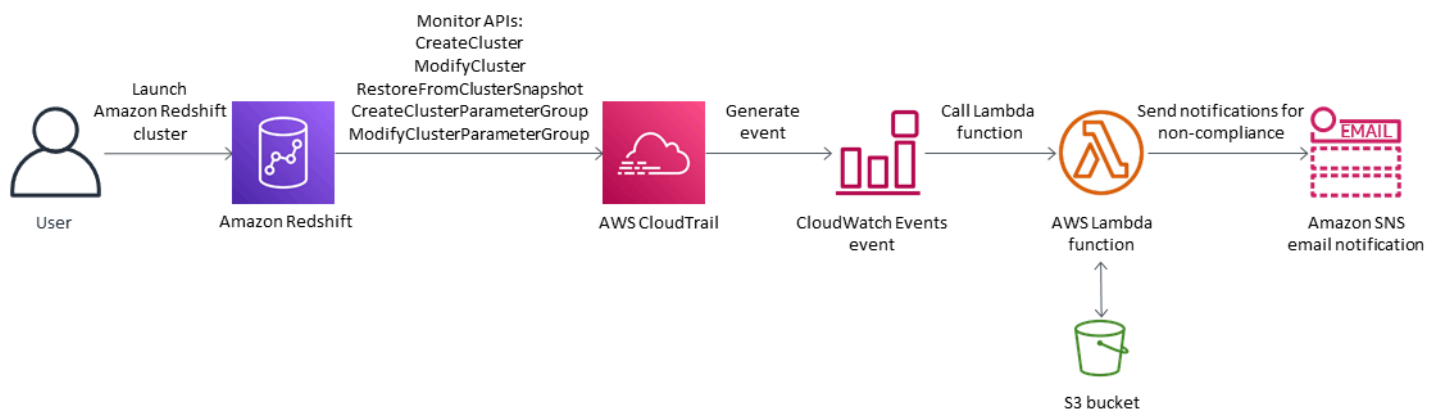

### Automation and scale

- If you are using [AWS Organizations](#), you can use [AWS CloudFormation StackSets](#) to deploy this template in multiple accounts that you want to monitor.

## Tools

### AWS services

- [AWS CloudFormation](#) – AWS CloudFormation helps you model and set up your AWS resources, provision them quickly and consistently, and manage them throughout their lifecycle. You can

use a template to describe your resources and their dependencies, and launch and configure them together as a stack, instead of managing resources individually.

- [Amazon CloudWatch Events](#) – Amazon CloudWatch Events delivers a near real-time stream of system events that describe changes in AWS resources.
- [AWS Lambda](#) – AWS Lambda is a compute service that supports running code without provisioning or managing servers.
- [Amazon Redshift](#) – Amazon Redshift is a fully managed, petabyte-scale data warehouse service in the cloud.
- [Amazon S3](#) – Amazon Simple Storage Service (Amazon S3) is an object storage service. You can use Amazon S3 to store and retrieve any amount of data at any time, from anywhere on the web.
- [Amazon SNS](#) – Amazon Simple Notification Service (Amazon SNS) coordinates and manages the delivery or sending of messages between publishers and clients, including web servers and email addresses. Subscribers receive all messages published to the topics to which they subscribe, and all subscribers to a topic receive the same messages.

## Code

This pattern includes the following attachments:

- `RedshiftSSLEndpointsRequired.zip` – The Lambda code for the security control.
- `RedshiftSSLEndpointsRequired.yml` – The CloudFormation template that sets up the event and Lambda function.

## Epics

### Set up the S3 bucket

Task	Description	Skills required
Define the S3 bucket.	On the <a href="#">Amazon S3 console</a> , choose or create an S3 bucket to host the Lambda code .zip file. This S3 bucket must be in the same AWS Region as	Cloud architect

Task	Description	Skills required
	the Amazon Redshift cluster you want to monitor. An S3 bucket name is globally unique, and the namespace is shared by all AWS accounts. The S3 bucket name cannot include leading slashes.	
Upload the Lambda code.	Upload the Lambda code .zip file provided in the <i>Attachments</i> section to the S3 bucket.	Cloud architect

## Deploy the CloudFormation template

Task	Description	Skills required
Launch the AWS CloudFormation template.	Open the <a href="#">AWS CloudFormation console</a> in the same AWS Region as your S3 bucket and deploy the attached template <code>RedshiftSSLEndpointsRequired.yml</code> . For more information about deploying AWS CloudFormation templates, see <a href="#">Creating a stack on the AWS CloudFormation console</a> in the CloudFormation documentation.	Cloud architect
Complete the parameters in the template.	When you launch the template, you'll be prompted for the following information:	Cloud architect

Task	Description	Skills required
	<ul style="list-style-type: none"> <li>• <b>S3 bucket:</b> Specify the bucket that you created or selected in the first epic. This is where you uploaded the attached Lambda code (.zip file).</li> <li>• <b>S3 key:</b> Specify the location of the Lambda .zip file in your S3 bucket (for example, <i>filename.zip</i> or <i>controls/filename.zip</i>). Do not include leading slashes.</li> <li>• <b>Notification email:</b> Provide an active email address where you want to receive Amazon SNS notifications.</li> <li>• <b>Lamba logging level:</b> Specify the logging level and frequency for the Lambda function. Use <b>Info</b> to log detailed informational messages on progress, <b>Error</b> for error events that would still allow the deployment to continue, and <b>Warning</b> for potentially harmful situations.</li> </ul>	

## Confirm the subscription

Task	Description	Skills required
Confirm the subscription.	When the CloudFormation template deploys successfully	Cloud architect

Task	Description	Skills required
	lly, it sends a subscription email to the email address you provided. You must confirm this email subscription to start receiving violation notifications.	

## Related resources

- [Creating an S3 bucket](#) (Amazon S3 documentation)
- [Uploading files to an S3 bucket](#) (Amazon S3 documentation)
- [Creating a stack on the AWS CloudFormation console](#) (AWS CloudFormation documentation)
- [Creating a CloudWatch Events rule that triggers on an AWS API call using AWS CloudTrail](#) (AWS CloudTrail documentation)
- [Creating an Amazon Redshift cluster](#) (Amazon Redshift documentation)
- [Configuring security options for connections](#) (Amazon Redshift documentation)

## Attachments

To access additional content that is associated with this document, unzip the following file: [attachment.zip](#)

# Verify that new Amazon Redshift clusters launch in a VPC

Created by Priyanka Chaudhary (AWS)

**Environment:** Production

**Technologies:** Security, identity, compliance; Analytics; Databases

**AWS services:** Amazon CloudWatch; AWS Lambda; Amazon Redshift

## Summary

This pattern provides an Amazon Web Services (AWS) CloudFormation template that automatically notifies you when an Amazon Redshift cluster is launched outside a virtual private cloud (VPC).

Amazon Redshift is a fully managed, petabyte-scale, cloud-based data warehouse product. It is designed for large-scale dataset storage and analysis. It is also used to perform large-scale database migrations. Amazon Virtual Private Cloud (Amazon VPC) lets you provision a logically isolated section of the AWS Cloud where you can launch AWS resources such as Amazon Redshift clusters in a virtual network that you define.

The security control provided with this pattern monitors Amazon Redshift API calls in AWS CloudTrail logs, and initiates an Amazon CloudWatch Events event for the [CreateCluster](#) and [RestoreFromClusterSnapshot](#) APIs. When the event detects one of these APIs, it calls AWS Lambda, which runs a Python script. The Python function analyzes the CloudWatch event. If an Amazon Redshift cluster is created or restored from a snapshot and appears outside the Amazon VPC network, the function sends an Amazon Simple Notification Service (Amazon SNS) notification to the user with the relevant information: the Amazon Redshift cluster name, AWS Region, AWS account, and Amazon Resource Name (ARN) for Lambda that this notification is sourced from.

## Prerequisites and limitations

### Prerequisites

- An active AWS account.
- A VPC with a cluster subnet group, and an associated security group.



## Limitations

- The AWS CloudFormation template supports the [CreateCluster](#) and [RestoreFromClusterSnapshot](#) actions (new clusters) only. It does not detect existing Amazon Redshift clusters that were created outside a VPC.
- This security control is regional. You must deploy it in each AWS Region you want to monitor.

## Architecture

### Target architecture

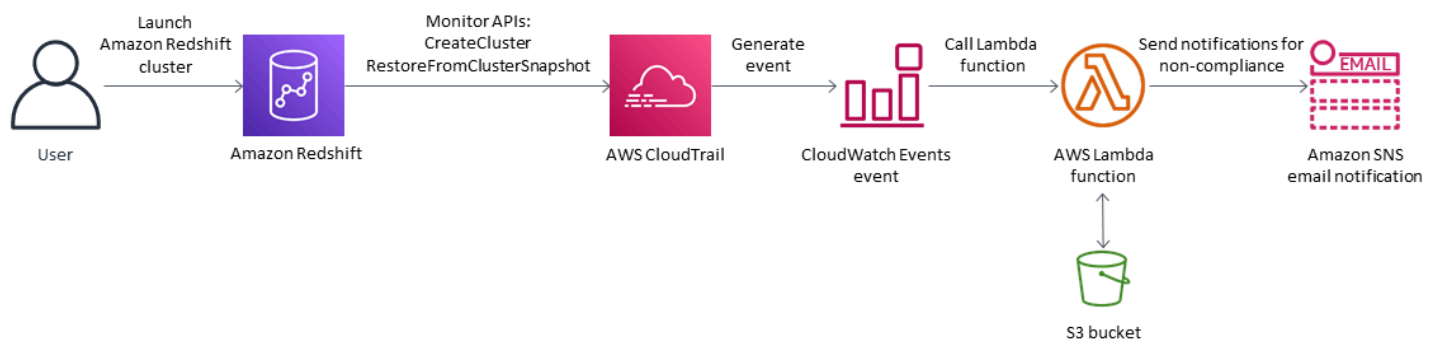

### Automation and scale

If you are using [AWS Organizations](#), you can use [AWS Cloudformation StackSets](#) to deploy this template in multiple accounts that you want to monitor.

## Tools

### AWS services

- [AWS CloudFormation](#) – AWS CloudFormation helps you model and set up your AWS resources, provision them quickly and consistently, and manage them throughout their lifecycle. You can use a template to describe your resources and their dependencies, and launch and configure them together as a stack, instead of managing resources individually.
- [AWS CloudTrail](#) – AWS CloudTrail helps you implement governance, compliance, and operational and risk auditing of your AWS account. Actions taken by a user, role, or an AWS service are recorded as events in CloudTrail.

- [Amazon CloudWatch Events](#) – Amazon CloudWatch Events delivers a near real-time stream of system events that describe changes in AWS resources.
- [AWS Lambda](#) – AWS Lambda is a compute service that supports running code without provisioning or managing servers. AWS Lambda runs your code only when needed and scales automatically, from a few requests per day to thousands per second.
- [Amazon Redshift](#) – Amazon Redshift is a fully managed, petabyte-scale data warehouse service in the cloud. Amazon Redshift is integrated with your data lake, which enables you to use your data to acquire new insights for your business and customers.
- [Amazon S3](#) – Amazon Simple Storage Service (Amazon S3) is a highly scalable object storage service that you can use for a wide range of storage solutions, including websites, mobile applications, backups, and data lakes.
- [Amazon SNS](#) – Amazon Simple Notification Service (Amazon SNS) coordinates and manages the delivery or sending of messages between publishers and clients, including web servers and email addresses.

## Code

This pattern includes the following attachments:

- `RedshiftMustBeInVPC.zip` – The Lambda code for the security control.
- `RedshiftMustBeInVPC.yml` – The CloudFormation template that sets up the event and Lambda function.

To use these files, follow the instructions in the next section.

## Epics

### Set up the S3 bucket

Task	Description	Skills required
Define the S3 bucket.	On the <a href="#">Amazon S3 console</a> , choose or create an S3 bucket to host the Lambda code .zip file. This S3 bucket must be in the same AWS Region as	Cloud architect

Task	Description	Skills required
	the Amazon Redshift cluster that you want to monitor. An S3 bucket name is globally unique, and the namespace is shared by all AWS accounts. The S3 bucket name cannot include leading slashes.	
Upload the Lambda code.	Upload the Lambda code (RedshiftMustBeInVP C.zip file) provided in the <i>Attachments</i> section to the S3 bucket.	Cloud architect

## Deploy the CloudFormation template

Task	Description	Skills required
Launch the CloudFormation template.	Open the <a href="#">AWS CloudFormation console</a> in the same AWS Region as your S3 bucket and deploy the attached template (RedshiftMustBeInVP C.yml ). For more information about deploying AWS CloudFormation templates , see <a href="#">Creating a stack on the AWS CloudFormation console</a> in the CloudFormation documentation.	Cloud architect
Complete the parameters in the template.	When you launch the template, you'll be prompted for the following information:	Cloud architect

Task	Description	Skills required
	<ul style="list-style-type: none"> <li>• <b>S3 bucket:</b> Specify the bucket that you created or selected in the first epic. This is where you uploaded the attached Lambda code (.zip file).</li> <li>• <b>S3 key:</b> Specify the location of the Lambda .zip file in your S3 bucket (for example, <i>filename.zip</i> or <i>controls/filename.zip</i>). Do not include leading slashes.</li> <li>• <b>Notification email:</b> Provide an active email address where you want to receive Amazon SNS notifications.</li> <li>• <b>Lamba logging level:</b> Specify the logging level and frequency for the Lambda function. Use <b>Info</b> to log detailed informational messages on progress, <b>Error</b> for error events that would still allow the deployment to continue, and <b>Warning</b> for potentially harmful situations.</li> </ul>	

## Confirm the subscription

Task	Description	Skills required
Confirm the subscription.	When the CloudFormation template deploys successfu	Cloud architect

Task	Description	Skills required
	lly, it sends a subscription email to the email address you provided. You must confirm this email subscription to start receiving violation notifications.	

## Related resources

- [Creating an S3 bucket](#) (Amazon S3 documentation)
- [Uploading files to an S3 bucket](#) (Amazon S3 documentation)
- [Creating a stack on the AWS CloudFormation console](#) (AWS CloudFormation documentation)
- [Creating a CloudWatch Events rule that triggers on an AWS API call using AWS CloudTrail](#) (AWS CloudTrail documentation)
- [Creating an Amazon Redshift cluster](#) (Amazon Redshift documentation)

## Attachments

To access additional content that is associated with this document, unzip the following file: [attachment.zip](#)

## More patterns

- [Access a bastion host by using Session Manager and Amazon EC2 Instance Connect](#)
- [Access container applications privately on Amazon ECS by using AWS Fargate, AWS PrivateLink, and a Network Load Balancer](#)
- [Access container applications privately on Amazon ECS by using AWS PrivateLink and a Network Load Balancer](#)
- [Access container applications privately on Amazon EKS using AWS PrivateLink and a Network Load Balancer](#)
- [Allow EC2 instances write access to S3 buckets in AWS accounts](#)
- [Associate an AWS CodeCommit repository in one AWS account with SageMaker Studio in another account](#)
- [Authenticate existing React application users by using Amazon Cognito and AWS Amplify UI](#)
- [Automate adding or updating Windows registry entries using AWS Systems Manager](#)
- [Automate encryption enforcement in AWS Glue using an AWS CloudFormation template](#)
- [Automatically attach an AWS managed policy for Systems Manager to EC2 instance profiles using Cloud Custodian and AWS CDK](#)
- [Automatically encrypt existing and new Amazon EBS volumes](#)
- [Block public access to Amazon RDS by using Cloud Custodian](#)
- [Centralize DNS resolution by using AWS Managed Microsoft AD and on-premises Microsoft Active Directory](#)
- [Implement centralized custom Checkov scanning to enforce policy before deploying AWS infrastructure](#)
- [Check AWS CDK applications or CloudFormation templates for best practices by using cdk-nag rule packs](#)
- [Check EC2 instances for mandatory tags at launch](#)
- [Configure cross-account access to Amazon DynamoDB](#)
- [Configure HTTPS encryption for Oracle JD Edwards EnterpriseOne on Oracle WebLogic by using an Application Load Balancer](#)
- [Configure logging and monitoring for security events in your AWS IoT environment](#)
- [Configure mutual TLS authentication for applications running on Amazon EKS](#)
- [Connect by using an SSH tunnel in pgAdmin](#)

- [Create a React app by using AWS Amplify and add authentication with Amazon Cognito](#)
- [Create a report of Network Access Analyzer findings for inbound internet access in multiple AWS accounts](#)
- [Customize Amazon CloudWatch alerts for AWS Network Firewall](#)
- [Deploy a firewall using AWS Network Firewall and AWS Transit Gateway](#)
- [Deploy a ChatOps solution to manage SAST scan results by using AWS Chatbot custom actions and AWS CloudFormation](#)
- [Document your AWS landing zone design](#)
- [Enable encrypted connections for PostgreSQL DB instances in Amazon RDS](#)
- [Encrypt an existing Amazon RDS for PostgreSQL DB instance](#)
- [Enforce automatic tagging of Amazon RDS databases at launch](#)
- [Enforce tagging of Amazon EMR clusters at launch](#)
- [Ensure Amazon EMR logging to Amazon S3 is enabled at launch](#)
- [Find AWS resources based on their creation date by using AWS Config advanced queries](#)
- [Generate an AWS CloudFormation template containing AWS Config managed rules using Troposphere](#)
- [Get Amazon SNS notifications when the key state of an AWS KMS key changes](#)
- [Help enforce DynamoDB tagging](#)
- [Identify and alert when Amazon Data Firehose resources are not encrypted with an AWS KMS key](#)
- [Improve operational performance by enabling Amazon DevOps Guru across multiple AWS Regions, accounts, and OUs with the AWS CDK](#)
- [Ingest and migrate EC2 Windows instances into an AWS Managed Services account](#)
- [Migrate Amazon RDS for Oracle to Amazon RDS for PostgreSQL in SSL mode by using AWS DMS](#)
- [Migrate an ELK Stack to Elastic Cloud on AWS](#)
- [Migrate an F5 BIG-IP workload to F5 BIG-IP VE on the AWS Cloud](#)
- [Monitor Amazon Aurora for instances without encryption](#)
- [Rotate database credentials without restarting containers](#)
- [Secure and streamline user access in a Db2 federation database on AWS by using trusted contexts](#)
- [Send AWS WAF logs to Splunk by using AWS Firewall Manager and Amazon Data Firehose](#)
- [Serve static content in an Amazon S3 bucket through a VPC by using Amazon CloudFront](#)

- [Set up end-to-end encryption for applications on Amazon EKS using cert-manager and Let's Encrypt](#)
- [Verify that ELB load balancers require TLS termination](#)
- [View AWS Network Firewall logs and metrics by using Splunk](#)
- [Visualize IAM credential reports for all AWS accounts using Amazon QuickSight](#)



# Serverless

## Topics

- [Build a serverless React Native mobile app by using AWS Amplify](#)
- [Manage tenants across multiple SaaS products on a single control plane](#)
- [Create a cross-account Amazon EventBridge connection in an organization](#)
- [Deliver DynamoDB records to Amazon S3 using Kinesis Data Streams and Firehose with AWS CDK](#)
- [Integrate Amazon API Gateway with Amazon SQS to handle asynchronous REST APIs](#)
- [Process events asynchronously with Amazon API Gateway and AWS Lambda](#)
- [Process events asynchronously with Amazon API Gateway and Amazon DynamoDB Streams](#)
- [Process events asynchronously with Amazon API Gateway, Amazon SQS, and AWS Fargate](#)
- [Run AWS Systems Manager Automation tasks synchronously from AWS Step Functions](#)
- [Run parallel reads of S3 objects by using Python in an AWS Lambda function](#)
- [Send telemetry data from AWS Lambda to OpenSearch for real-time analytics and visualization](#)
- [Set up private access to an Amazon S3 bucket through a VPC endpoint](#)
- [Chain AWS services together using a serverless approach](#)
- [More patterns](#)

# Build a serverless React Native mobile app by using AWS Amplify

Created by Deekshitulu Pentakota (AWS)

<b>Code repository:</b> <a href="#">aws-amplify-react-native-ios-todo-app</a>	<b>Environment:</b> Production	<b>Source:</b> NA
<b>Target:</b> AWS Amplify, AWS AppSync, Amazon Cognito, Amazon DynamoDB	<b>R Type:</b> Re-architect	<b>Workload:</b> Open-source
<b>Technologies:</b> Serverless; Web & mobile apps	<b>AWS services:</b> AWS Amplify; AWS AppSync; Amazon Cognito; Amazon DynamoDB	

## Summary

This pattern shows how to create a serverless backend for a React Native mobile app by using AWS Amplify and the following AWS services:

- AWS AppSync
- Amazon Cognito
- Amazon DynamoDB

After you configure and deploy the app's backend by using Amplify, Amazon Cognito authenticates app users and authorizes them to access the app. AWS AppSync then interacts with the frontend app and with a backend DynamoDB table to create and fetch data.

**Note:** This pattern uses a simple "ToDoList" app as an example, but you can use a similar procedure to create any React Native mobile app.

## Prerequisites and limitations

### Prerequisites

- An active AWS Account
- [Amplify Command Line Interface \(Amplify CLI\)](#), installed and configured
- XCode (any version)
- Microsoft Visual Studio (any version, any code editor, any text editor)
- Familiarity with Amplify
- Familiarity with Amazon Cognito
- Familiarity with AWS AppSync
- Familiarity with DynamoDB
- Familiarity with Node.js
- Familiarity with npm
- Familiarity with React and React Native
- Familiarity with JavaScript and ECMAScript 6 (ES6)
- Familiarity with GraphQL

## Architecture

The following diagram shows an example architecture for running a React Native mobile app's backend in the AWS Cloud:

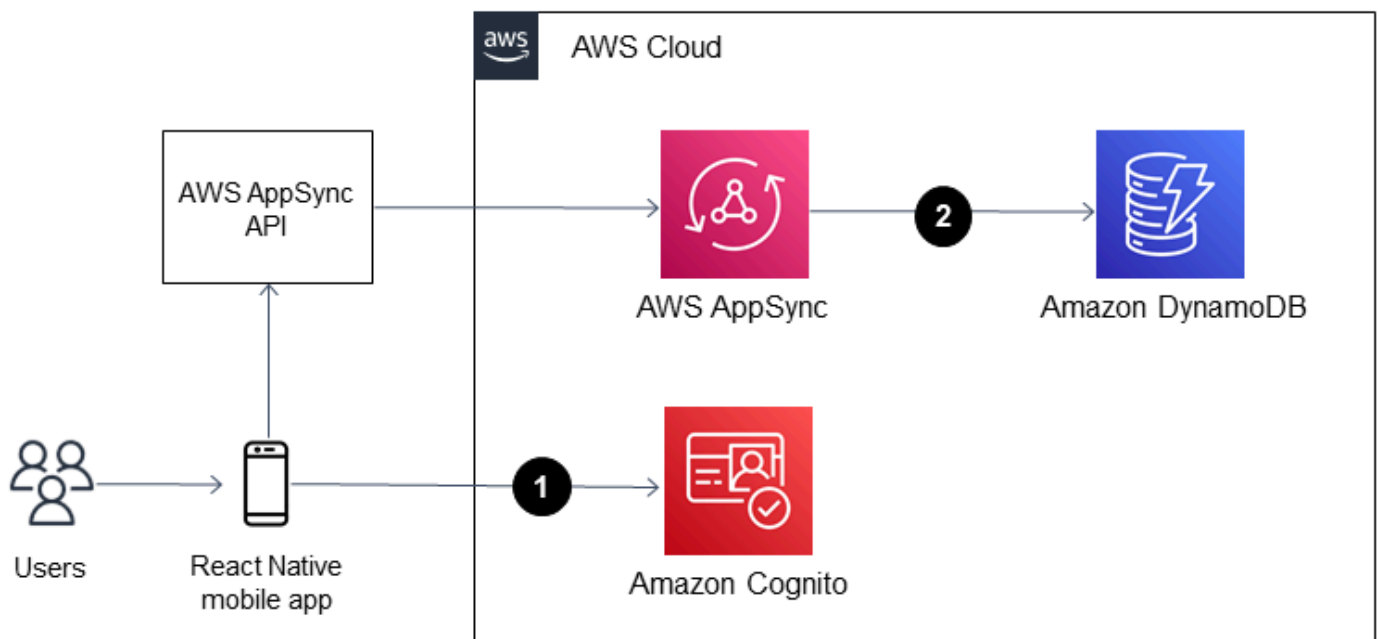

The diagram shows the following architecture:

1. Amazon Cognito authenticates app users and authorizes them to access the app.
2. To create and fetch data, AWS AppSync uses a GraphQL API to interact with the frontend app and a backend DynamoDB table.

## Tools

### AWS services

- [AWS Amplify](#) is a set of purpose-built tools and features that helps frontend web and mobile developers quickly build full-stack applications on AWS.
- [AWS AppSync](#) provides a scalable GraphQL interface that helps application developers combine data from multiple sources, including Amazon DynamoDB, AWS Lambda, and HTTP APIs.
- [Amazon Cognito](#) provides authentication, authorization, and user management for web and mobile apps.
- [Amazon DynamoDB](#) is a fully managed NoSQL database service that provides fast, predictable, and scalable performance.

### Code

The code for the sample application that's used in this pattern is available in the GitHub [aws-amplify-react-native-ios-todo-app](#) repository. To use the sample files, follow the instructions in the **Epics** section of this pattern.

## Epics

### Create and run your React Native app

Task	Description	Skills required
Set up a React Native development environment.	For instructions, see <a href="#">Setting up the development environment</a> in the React Native documentation.	App developer

Task	Description	Skills required
Create and run the ToDoList React Native mobile app in iOS Simulator.	<ol style="list-style-type: none"><li>1. Create a new React Native mobile app project directory in your local environment by running the following command in a new terminal window:  <pre>npx react-native init ToDoListAmplify</pre></li><li>2. Navigate to the project's root directory by running the following command:  <pre>cd ToDoListAmplify</pre></li><li>3. Run the app by running the following command:  <pre>npx react-native run-ios</pre></li></ol>	App developer

### Initialize a new backend environment for the app

Task	Description	Skills required
Create the backend services needed to support the app in Amplify.	<ol style="list-style-type: none"><li>1. In your local environment, run the following command from the project's root directory (<b>ToDoListAmplify</b>):  <pre>amplify init</pre></li><li>2. A prompt appears that asks you to provide information about the app. Enter the</li></ol>	App developer

Task	Description	Skills required
	<p>required information based on your use case. Then, press <b>Enter</b>.</p> <p>For the ToDoList app setup used in this pattern, apply the following example configuration.</p> <p><b>Example React Native Amplify app configuration settings</b></p> <pre data-bbox="592 808 1031 1766">? Name: ToDoListAmplify  ? Environment: dev  ? Default editor: Visual Studio Code  ? App type: javascript  ? Javascript framework : react-native  ? Source Directory Path: src  ? Distribution Directory Path: /  ? Build Command: npm run-script build  ? Start Command: npm run-script start</pre>	

Task	Description	Skills required
	<pre>? Select the authentication method you want to use: AWS profile  ? Please choose the profile you want to use: default</pre> <p>For more information, see <a href="#">Create a new Amplify backend</a> in the Amplify Dev Center documentation.</p> <p><b>Note:</b> The <code>amplify init</code> command provisions the following resources by using <a href="#">AWS CloudFormation</a>:</p> <ul style="list-style-type: none"><li>• AWS Identity and Access Management (IAM) roles for authenticated and unauthenticated users (<b>Auth Role</b> and <b>Unauth Role</b>)</li><li>• An Amazon Simple Storage Service (Amazon S3) bucket for deployment (for this pattern's example app, <b>Amplify-meta.json</b>)</li><li>• A backend environment in <a href="#">Amplify Hosting</a></li></ul>	

## Add Amazon Cognito authentication to your Amplify React Native app

Task	Description	Skills required
Create an Amazon Cognito authentication service.	<ol style="list-style-type: none"><li data-bbox="592 317 1027 541">1. In your local environment, run the following command from the project's root directory (<b>ToDoListAmplify</b>):  <code>amplify add auth</code></li><li data-bbox="592 646 1027 961">2. A prompt appears that asks you to provide information about the authentication service's configuration settings. Enter the required information based on your use case. Then, press <b>Enter</b>.</li></ol> <p data-bbox="592 1045 1027 1213">For the ToDoList app setup used in this pattern, apply the following example configuration.</p> <p data-bbox="592 1266 950 1392"><b>Example authentication service configuration settings</b></p> <pre data-bbox="609 1434 1015 1854">? Do you want to use the   default authentication   and security configura   tion? \ Default configuration  ? How do you want users   to be able to sign in?   \ Username</pre>	App developer



Task	Description	Skills required
	<pre>? Do you want to configure advanced settings? \ No, I am done</pre> <p><b>Note:</b> The <code>amplify add auth</code> command creates the necessary folders, files, and dependency files in a local folder (<b>amplify</b>) within the project's root directory. For the ToDoList app setup used in this pattern, the <b>aws-exports.js</b> is created for this purpose.</p>	
Deploy the Amazon Cognito service to the AWS Cloud.	<ol style="list-style-type: none"><li>1. From the project's root directory, run the following Amplify CLI command:  <pre>amplify push</pre></li><li>2. A prompt to confirm deployment appears. Enter <b>Yes</b>. Then, press <b>Enter</b>.</li></ol> <p><b>Note:</b> To see the deployed services in your project, go to the Amplify console by running the following command:</p> <pre>amplify console</pre>	App developer

Task	Description	Skills required
<p>Install the required Amplify libraries for React Native and the CocoaPods dependencies for iOS.</p>	<ol style="list-style-type: none"><li>1. Install the required Amplify open-source client libraries by running the following command from the project's root directory:  <pre>npm install aws-amplify aws-amplify-react-native \amazon-cognito-identity-js @react-native-community/netinfo \ @react-native-async-storage/async-storage</pre></li><li>2. Install the required CocoaPods dependencies for iOS by running the following command:  <pre>npx pod-install</pre></li></ol>	<p>App developer</p>

Task	Description	Skills required
Import and configure the Amplify service.	<p>In the app's entry point file (for example, <b>App.js</b>), import and load the Amplify service's configuration file by entering the following lines of code:</p> <pre data-bbox="597 489 1027 768">import Amplify from   'aws-amplify' import config from './ src/aws-exports' Amplify.configure(   config)</pre> <p><b>Note:</b> If you receive an error after importing the Amplify service in the app's entry point file, stop the app. Then, open XCode and select the <b>ToDoListAmplify.xcworkspace</b> from the project's iOS folder and run the app.</p>	App developer

Task	Description	Skills required
Update your app's entry point file to use the <code>withAuthenticator</code> Higher-order component (HOC).	<p><b>Note:</b> The <code>withAuthenticator</code> HOC provides sign-in, sign-up, and forgot password workflows in your app by using only a few lines of code. For more information, see <a href="#">Option 1: Use pre-build UI components</a> in the Amplify Dev Center. Also, <a href="#">Higher-order components</a> in the React documentation.</p> <ol style="list-style-type: none"><li>1. In the app's entry point file (for example, <b>App.js</b>), import the <code>withAuthenticator</code> HOC by entering the following lines of code: <pre>import { withAuthenticator } from 'aws-amplify-react-native'</pre></li><li>2. Export the <code>withAuthenticator</code> HOC by entering the following code: <pre>export default withAuthenticator(App)</pre></li></ol> <p><b>withAuthenticator HOC code example</b></p>	App developer

Task	Description	Skills required
	<pre data-bbox="597 226 1026 1003">import Amplify from   'aws-amplify' import config from './ src/aws-exports' Amplify.configure e(config) import { withAuthenticator } from   'aws-amplify-react- native';  const App = () =&gt; {   return null; };  export default withAuthenticator(App);</pre> <p data-bbox="597 1045 1026 1213"><b>Note:</b> In iOS Simulator, the app shows the login screen that's provided by the Amazon Cognito service.</p>	

Task	Description	Skills required
Test the authentication service setup.	<p>In iOS Simulator, do the following:</p> <ol style="list-style-type: none"> <li>1. Create a new account in the app by using a real email address. A verification code is then sent to the registered email.</li> <li>2. Verify the account set up by using the code that you receive in the verification email.</li> <li>3. Enter the username and password that you created. Then, choose <b>Sign In</b>. A welcome screen appears.</li> </ol> <p><b>Note:</b> You can also open the <a href="#">Amazon Cognito console</a> and check if a new user has been created in the <b>Identity Pool</b> or not.</p>	App developer

### Connect an AWS AppSync API and DynamoDB database to the app

Task	Description	Skills required
Create an AWS AppSync API and DynamoDB database.	<ol style="list-style-type: none"> <li>1. Add an AWS AppSync API to your app and automatically provision a DynamoDB database by running the following Amplify CLI command from the project's root directory:</li> </ol>	App developer

Task	Description	Skills required
	<p>amplify add api</p> <p>2. A prompt appears that asks you to provide information about the API and database configuration settings. Enter the required information based on your use case. Then, press <b>Enter</b>. The Amplify CLI opens the GraphQL schema file in your text editor.</p> <p>For the ToDoList app setup used in this pattern, apply the following example configuration.</p> <p><b>Example API and database configuration settings</b></p> <pre data-bbox="609 1155 1031 1848"> ? Please select from one of the below mentioned services: \ GraphQL  ? Provide API name: todolistamplify  ? Choose the default authorization type for the API \ Amazon Cognito User Pool  Do you want to use the default authentication and security configura tion </pre>	

Task	Description	Skills required
	<p>? Default configuration How do you want users to be able to sign in? \</p> <p>Username</p> <p>Do you want to configure advanced settings? \ No, I am done.</p> <p>? Do you want to configure advanced settings for the GraphQL API \ No, I am done.</p> <p>? Do you have an annotated GraphQL schema? \ No</p> <p>? Choose a schema template: \ Single object with fields (e.g., "Todo" with ID, name, description)</p> <p>? Do you want to edit the schema now? \ Yes</p> <p><b>Example GraphQL schema</b></p> <pre>type Todo @model {   id: ID!   name: String!   description: String }</pre>	



Task	Description	Skills required
Deploy the AWS AppSync API.	<ol style="list-style-type: none"><li data-bbox="592 226 1027 359">1. In the project's root directory, run the following Amplify CLI command:  <code>amplify push</code></li><li data-bbox="592 457 1027 919">2. A prompt appears that asks you to provide more information about the API and database configuration settings. Enter the required information based on your use case. Then, press <b>Enter</b>. Your app can now interact with the AWS AppSync API.</li></ol> <p data-bbox="592 1003 1027 1178">For the ToDoList app setup used in this pattern, apply the following example configuration.</p> <p data-bbox="592 1224 1027 1308"><b>Example AWS AppSync API configuration settings</b></p> <p data-bbox="592 1354 1027 1528"><b>Note:</b> The following configuration creates the GraphQL API in AWS AppSync and a <b>Todo</b> table in Dynamo DB.</p> <div data-bbox="592 1570 1027 1816" style="border: 1px solid #ccc; border-radius: 10px; padding: 10px;"><pre data-bbox="613 1591 1006 1816">? Are you sure you want to continue? Yes ? Do you want to generate code for your newly created GraphQL API Yes</pre></div>	App developer

Task	Description	Skills required
	<pre>? Choose the code generation language target javascript ? Enter the file name pattern of graphql queries, mutations and subscriptions src/ graphql/**/*.js ? Do you want to generate/update all possible GraphQL operations - \ queries, mutations and subscriptions Yes ? Enter maximum statement depth \ [increase from default if your schema is deeply nested] 2</pre>	

Task	Description	Skills required
Connect the app's frontend to the AWS AppSync API.	<p>To use the example ToDoList app provided in this pattern, copy the code from the <b>App.js</b> file in the <a href="#">aws-amplify-react-native-ios-todo-app</a> GitHub repository. Then, integrate the example code into your local environment.</p> <p>The example code provided in the repository's <b>App.js</b> file does the following:</p> <ul style="list-style-type: none"><li>• Shows the form for creating a <b>ToDo Item</b> with <b>Title</b> and <b>Description</b> fields</li><li>• Displays the list of to-do items (<b>Title</b> and <b>Description</b>)</li><li>• Posts and fetches data by using <code>aws-amplify</code> methods</li></ul>	App developer

## Related resources

- [AWS Amplify](#)
- [Amazon Cognito](#)
- [AWS AppSync](#)
- [Amazon DynamoDB](#)
- [React](#) (React documentation)

# Manage tenants across multiple SaaS products on a single control plane

*Created by Ramanna Avancha (AWS), Jenifer Pascal (AWS), Kishan Kavala (AWS), and Anusha Mandava (AWS)*

**Environment:** PoC or pilot

**Technologies:** Serverless

**AWS services:** Amazon API Gateway; Amazon Cognito; AWS Lambda; AWS Step Functions; Amazon DynamoDB

## Summary

This pattern shows how to manage tenant lifecycles across multiple software as a service (SaaS) products on a single control plane in the AWS Cloud. The reference architecture provided can help organizations reduce the implementation of redundant, shared features across their individual SaaS products and provide governance efficiencies at scale.

Large enterprises can have multiple SaaS products across various business units. These products often need to be provisioned for use by external tenants at different subscription levels. Without a common tenant solution, IT administrators must spend time managing undifferentiated features across multiple SaaS APIs, instead of focusing on core product feature development.

The common tenant solution provided in this pattern can help centralize the management of many of an organization's shared SaaS product features, including the following:

- Security
- Tenant provisioning
- Tenant data storage
- Tenant communications
- Product management
- Metrics logging and monitoring

## Prerequisites and limitations

### Prerequisites

- An active AWS account
- Knowledge of Amazon Cognito or a third-party identity provider (IdP)
- Knowledge of Amazon API Gateway
- Knowledge of AWS Lambda
- Knowledge of Amazon DynamoDB
- Knowledge of AWS Identity and Access Management (IAM)
- Knowledge of AWS Step Functions
- Knowledge of AWS CloudTrail and Amazon CloudWatch
- Knowledge of Python libraries and code
- Knowledge of SaaS APIs, including the different types of users (organizations, tenants, administrators, and application users), subscription models, and tenant isolation models
- Knowledge of your organization's multi-product SaaS requirements and multi-tenant subscriptions

### Limitations

- Integrations between the common tenant solution and individual SaaS products aren't covered in this pattern.
- This pattern deploys the Amazon Cognito service in a single AWS Region only.

## Architecture

### Target technology stack

- Amazon API Gateway
- Amazon Cognito
- AWS CloudTrail
- Amazon CloudWatch
- Amazon DynamoDB
- IAM

- AWS Lambda
- Amazon Simple Storage Service (Amazon S3)
- Amazon Simple Notification Service (Amazon SNS)
- AWS Step functions

## Target architecture

The following diagram shows an example workflow for managing tenant lifecycles across multiple SaaS products on a single control plane in the AWS Cloud.

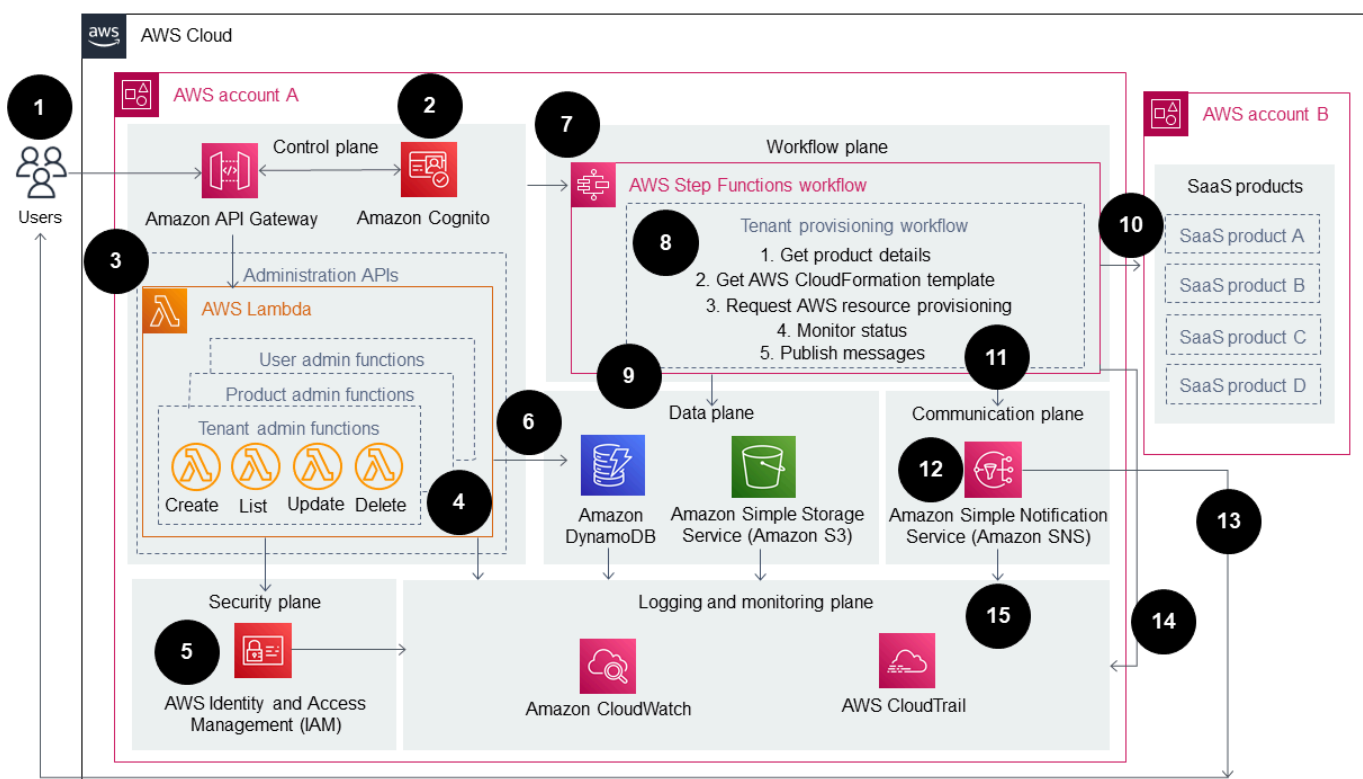

The diagram shows the following workflow:

1. An AWS user initiates tenant provisioning, product provisioning, or administration-related actions by making a call to an API Gateway endpoint.
2. The user is authenticated by an access token that's retrieved from an Amazon Cognito user pool, or another IdP.
3. Individual provisioning or administration tasks are run by Lambda functions that are integrated with API Gateway API endpoints.

4. Administration APIs for the common tenant solution (for tenants, products, and users) gather all of the required input parameters, headers, and tokens. Then, the administration APIs invoke the associated Lambda functions.
5. IAM permissions for both the administration APIs and the Lambda functions are validated by the IAM service.
6. Lambda functions store and retrieve data from the catalogs (for tenants, products, and users) in DynamoDB and Amazon S3.
7. After permissions are validated, an AWS Step Functions workflow is invoked to perform a specific task. The example in the diagram shows a tenant provisioning workflow.
8. Individual AWS Step Functions workflow tasks are run in a predetermined workflow (state machine).
9. Any essential data that's needed to run the Lambda function associated with each workflow task is retrieved from either DynamoDB or Amazon S3. Other AWS resources might need to be provisioned by using an AWS CloudFormation template.
- 10 If needed, the workflow sends a request to provision additional AWS resources for a specific SaaS product to that product's AWS account.
- 11 When the request succeeds or fails, the workflow publishes the status update as a message to an Amazon SNS topic.
- 12 Amazon SNS is subscribed to the Step Functions workflow's Amazon SNS topic.
- 13 Amazon SNS then sends the workflow status update back to the AWS user.
- 14 Logs of each AWS service's actions, including an audit trail of API calls, are sent to CloudWatch. Specific rules and alarms can be configured in CloudWatch for each use case.
- 15 Logs are archived in Amazon S3 buckets for auditing purposes.

## Automation and scale

This pattern uses a CloudFormation template to help automate the deployment of the common tenant solution. The template can also help you quickly scale the associated resources up or down.

For more information, see [Working with AWS CloudFormation templates](#) in the *AWS CloudFormation User Guide*.

## Tools

### AWS services

- [Amazon API Gateway](#) helps you create, publish, maintain, monitor, and secure REST, HTTP, and WebSocket APIs at any scale.
- [Amazon Cognito](#) provides authentication, authorization, and user management for web and mobile apps.
- [AWS CloudTrail](#) helps you audit the governance, compliance, and operational risk of your AWS account.
- [Amazon CloudWatch](#) helps you monitor the metrics of your AWS resources and the applications you run on AWS in real time.
- [Amazon DynamoDB](#) is a fully managed NoSQL database service that provides fast, predictable, and scalable performance.
- [AWS Identity and Access Management \(IAM\)](#) helps you securely manage access to your AWS resources by controlling who is authenticated and authorized to use them.
- [AWS Lambda](#) is a compute service that helps you run code without needing to provision or manage servers. It runs your code only when needed and scales automatically, so you pay only for the compute time that you use.
- [Amazon Simple Storage Service \(Amazon S3\)](#) is a cloud-based object storage service that helps you store, protect, and retrieve any amount of data.
- [Amazon Simple Notification Service \(Amazon SNS\)](#) helps you coordinate and manage the exchange of messages between publishers and clients, including web servers and email addresses.
- [AWS Step Functions](#) is a serverless orchestration service that helps you combine AWS Lambda functions and other AWS services to build business-critical applications.

## Best practices

The solution in this pattern uses a single control plane to manage the onboarding of multiple tenants and to provision access to multiple SaaS products. The control plane helps administrative users manage four other, feature-specific planes:

- Security plane
- Workflow plane
- Communication plane
- Logging and monitoring plane



# Epics

## Configure the security plane

Task	Description	Skills required
Establish the requirements for your multi-tenant SaaS platform.	<p>Establish detailed requirements for the following:</p> <ul style="list-style-type: none"> <li>• Tenants</li> <li>• Users</li> <li>• Roles</li> <li>• SaaS products</li> <li>• Subscriptions</li> <li>• Profile exchanges</li> </ul>	Cloud architect, AWS systems administrator
Set up the Amazon Cognito service.	<p>Follow the instructions in <a href="#">Getting started with Amazon Cognito</a> in the <i>Amazon Cognito Developer Guide</i>.</p>	Cloud architect
Configure the required IAM policies.	<p>Create the required IAM policies for your use case. Then, map the policies to IAM roles in Amazon Cognito.</p> <p>For more information, see <a href="#">Managing access using policies</a> and <a href="#">Role-based access control</a> in the <i>Amazon Cognito Developer Guide</i>.</p>	Cloud administrator, Cloud architect, AWS IAM security
Configure the required API permissions.	<p>Set up API Gateway access permissions by using IAM roles and policies, and Lambda authorizers.</p>	Cloud administrator, Cloud architect

Task	Description	Skills required
	<p>For instructions, see the following sections of the <i>Amazon API Gateway Developer Guide</i>:</p> <ul style="list-style-type: none"> <li>• <a href="#">Control access to an API with IAM permissions</a></li> <li>• <a href="#">Use API Gateway Lambda authorizers</a></li> </ul>	

## Configure the data plane

Task	Description	Skills required
<p>Create the required data catalogs.</p>	<ol style="list-style-type: none"> <li>1. Create DynamoDB tables to store data for the user catalogs. Make sure that you include user attributes and roles. Also, make sure that you perform data modeling on the catalog tables to maintain the required and optional attributes for each user and role.</li> <li>2. Create DynamoDB tables to store data for the product catalogs. Make sure that you model the specific use cases for your SaaS products.</li> <li>3. Create DynamoDB tables to store data for the tenant catalogs. Make sure</li> </ol>	<p>DBA</p>

Task	Description	Skills required
	<p>that you set up subscription models for tenants, products and licensing for multi-SaaS subscriptions, and tags.</p> <p>For more information, see <a href="#">Setting up DynamoDB</a> in the <i>Amazon DynamoDB Developer Guide</i>.</p>	

## Configure the control plane

Task	Description	Skills required
<p>Create Lambda functions and API Gateway APIs to run required control plane tasks.</p>	<p>Create separate Lambda functions and API Gateway APIs to add, delete, and manage the following:</p> <ul style="list-style-type: none"> <li>• Users</li> <li>• Tenants</li> <li>• Products</li> </ul> <p>For more information, see <a href="#">Using AWS Lambda with Amazon API Gateway</a> in the <i>AWS Lambda Developer Guide</i>.</p>	<p>App developer</p>

## Configure the workflow plane

Task	Description	Skills required
Identify the tasks that AWS Step Functions workflows must run.	<p>Identify and document the detailed AWS Step Functions workflow requirements for the following:</p> <ul style="list-style-type: none"><li>• Users</li><li>• Tenants</li><li>• Products</li></ul> <p><b>Important:</b> Make sure that key stakeholders approve the requirements.</p>	App owner
Create the required AWS Step Functions workflows.	<ol style="list-style-type: none"><li>1. Create the required workflows for users, tenants, and products in AWS Step Functions. For more information, see the <a href="#">AWS Step Functions Developer Guide</a>.</li><li>2. Identify the retry and error handling mechanisms. For more information, see <a href="#">Handling errors, retries, and adding alerting to Step Function State Machines</a> on the AWS Blog.</li><li>3. Implement the workflow steps by using Lambda functions. For instructions, see <a href="#">Creating a Step Functions state machine</a></li></ol>	App developer, Build lead

Task	Description	Skills required
	<p><a href="#">that uses Lambda</a> in the <i>AWS Step Functions Developer Guide</i>.</p> <p>4. Integrate any external services with AWS Step Functions as needed.</p> <p>5. Maintain each workflow's status in a DynamoDB table and communicate each workflow's status by using Amazon SNS.</p>	

## Configure the communication plane

Task	Description	Skills required
Create Amazon SNS topics.	<p>Create Amazon SNS topics to receive notifications about the following:</p> <ul style="list-style-type: none"> <li>Workflow statuses</li> <li>Errors</li> <li>Retries</li> </ul> <p>For more information, see <a href="#">Creating an SNS topic</a> in the <i>Amazon SNS Developer Guide</i>.</p>	App owner, Cloud architect
Subscribe endpoints to each Amazon SNS topic.	To receive messages published to an Amazon SNS topic, you must subscribe an endpoint to each topic.	App developer, Cloud architect

Task	Description	Skills required
	<p>For more information, see <a href="#">Subscribing to an Amazon SNS topic</a> in the <i>Amazon SNS Developer Guide</i>.</p>	

## Configure the logging and monitoring plane

Task	Description	Skills required
<p>Activate logging for each component of the common tenant solution.</p>	<p>Activate logging at the component level for each resource in the common tenant solution that you created.</p> <p>For instructions, see the following:</p> <ul style="list-style-type: none"> <li>• <a href="#">How do I turn on CloudWatch Logs for troubleshooting my API Gateway REST API or WebSocket API?</a> (AWS Knowledge Center)</li> <li>• <a href="#">Logging using CloudWatch Logs</a> (<i>AWS Step Functions Developer Guide</i>)</li> <li>• <a href="#">AWS Lambda function logging in Python</a> (<i>AWS Lambda Developer Guide</i>)</li> <li>• <a href="#">Logging and monitoring in Amazon Cognito</a> (<i>Amazon Cognito Developer Guide</i>)</li> </ul>	<p>App developer, AWS systems administrator, Cloud administrator</p>

Task	Description	Skills required
	<ul style="list-style-type: none"> <li>• <a href="#">Monitoring with Amazon CloudWatch</a> (<i>Amazon DynamoDB Developer Guide</i>)</li> </ul> <p><b>Note:</b> You can consolidate logs for each resource into a centralized logging account by using IAM policies. For more information, see <a href="#">Centralized logging and multiple-account security guardrails</a>.</p>	

## Provision and deploy the common tenant solution

Task	Description	Skills required
Create CloudFormation templates.	<p>Automate the deployment and maintenance of the full common tenant solution and all its components by using CloudFormation templates.</p> <p>For more information, see the <a href="#">AWS CloudFormation User Guide</a>.</p>	App developer, DevOps engineer, CloudFormation developer

## Related resources

- [Control access to a REST API using Amazon Cognito user pools as authorizer](#) (*Amazon API Gateway Developer Guide*)
- [Use API Gateway Lambda authorizers](#) (*Amazon API Gateway Developer Guide*)

- [Amazon Cognito user pools](#) (*Amazon Cognito Developer Guide*)
- [Cross-account cross-Region CloudWatch console](#) (*Amazon CloudWatch User Guide*)



# Create a cross-account Amazon EventBridge connection in an organization

Created by Sam Wilson (AWS) and Robert Stone (AWS)

**Code repository:** [Cross Account EventBridge in an AWS Organization CDK python example](#)

**Environment:** Production

**Technologies:** Serverless; Infrastructure

**AWS services:** AWS CDK; Amazon EventBridge; AWS Lambda; AWS Organizations

## Summary

Large distributed systems use Amazon EventBridge to communicate changes in state between various Amazon Web Services (AWS) accounts in an AWS Organizations organization. However, EventBridge is generally able to target only endpoints or consumers in the same AWS account. The exception is an event bus in a different account. That event bus is a valid target. To consume events from an event bus in another account, the events must be pushed from the source account's event bus to the destination account's event bus. To avoid challenges when managing critical events across applications within different AWS accounts, use the recommended approach presented in this pattern.

This pattern illustrates how to implement an event-driven architecture with EventBridge that involves multiple AWS accounts in an AWS Organizations organization. The pattern uses AWS Cloud Development Kit (AWS CDK) Toolkit and AWS CloudFormation.

EventBridge offers a serverless event bus that helps you receive, filter, transform, route, and deliver events. A critical component of event-driven architectures, EventBridge supports separation between producers of messages and consumers of those messages. In a single account, this is straight forward. A multi-account structure requires additional considerations for events on the event bus in one account to be consumed in other accounts within the same organization.

For information about account-specific considerations for producers and consumers, see the [Additional information](#) section.

## Prerequisites and limitations

### Prerequisites

- An AWS Organizations organization with at least two associated AWS accounts
- An AWS Identity and Access Management (IAM) role in both AWS accounts that allows you to provision infrastructure in both AWS accounts by using AWS CloudFormation
- Git [installed locally](#)
- AWS Command Line Interface (AWS CLI) [installed locally](#)
- AWS CDK [installed locally](#) and [bootstrapped](#) in both AWS accounts

### Product versions

This pattern has been built and tested by using the following tools and versions:

- AWS CDK Toolkit 2.126.0
- Node.js 18.19.0
- npm 10.2.3
- Python 3.12

This pattern should work with any version of AWS CDK v2 or npm. Node.js versions 13.0.0 through 13.6.0 are not compatible with AWS CDK.

## Architecture

### Target architecture

The following diagram shows the architecture workflow for pushing an event from one account and consuming it in another account.

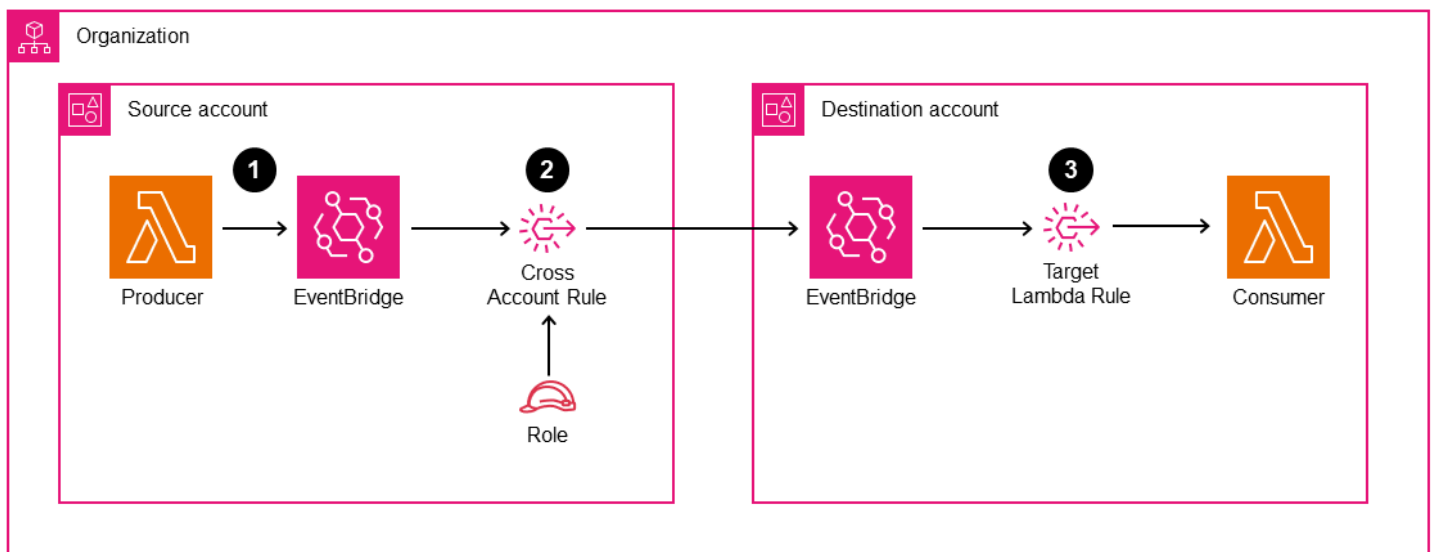

The workflow contains the following steps:

1. The Producer AWS Lambda function in the Source account puts an event on the account's EventBridge event bus.
2. The cross-account EventBridge rule routes the event to an EventBridge event bus in the Destination account.
3. The EventBridge event bus in the Destination account has a target Lambda rule that invokes the Consumer Lambda function.

A best practice is to use a [Dead Letter Queue \(DLQ\)](#) for handling failed invocations of the Consumer Lambda function. However, the DLQ was omitted from this solution for clarity. To learn more about how to implement a DLQ in your workflows and improve your workflows' ability to recover from failures, see the [Implementing AWS Lambda error handling patterns](#) blog post.

## Automation and scale

AWS CDK automatically provisions the required architecture. EventBridge can scale to thousands of records per second depending on the AWS Region. For more information, see the [Amazon EventBridge quotas documentation](#).

## Tools

### AWS services

- [AWS Cloud Development Kit \(AWS CDK\)](#) is a software development framework that helps you define and provision AWS Cloud infrastructure in code. This pattern uses the [AWS CDK Toolkit](#), a command line cloud development kit that helps you interact with your AWS CDK app.
- [Amazon EventBridge](#) is a serverless event bus service that helps you connect your applications with real-time data from a variety of sources. For example, AWS Lambda functions, HTTP invocation endpoints using API destinations, or event buses in other AWS accounts.
- [AWS Lambda](#) is a compute service that helps you run code without needing to provision or manage servers. It runs your code only when needed and scales automatically, so you pay only for the compute time that you use.
- [AWS Organizations](#) is an account management service that helps you consolidate multiple AWS accounts into an organization that you create and centrally manage.

### Other tools

- [Node.js](#) is an event-driven JavaScript runtime environment designed for building scalable network applications.
- [npm](#) is a software registry that runs in a Node.js environment and is used to share or borrow packages and manage deployment of private packages.
- [Python](#) is a general-purpose computer programming language.

### Code repository

The code for this pattern is available in the GitHub [cross-account-eventbridge-in-organization](#) repository.

### Best practices

For best practices when working with EventBridge, see the following resources:

- [Best practices for Amazon EventBridge event patterns](#)
- [Best practices when defining rules in Amazon EventBridge](#)

# Epics

## Prepare your local AWS CDK deployment environment

Task	Description	Skills required
Configure local credentials for the Source account and Destination account.	<p>Review <a href="#">Setting up new configuration and credentials</a>, and use the authentication and credential method that makes the most sense to your environment.</p> <p><b>Important:</b> Be sure to configure the AWS CLI for both Source account and Destination account authentication.</p> <p>These instructions assume that you have configured two AWS profiles locally: <code>sourceAccount</code> and <code>destinationAccount</code>.</p>	App developer
Bootstrap both AWS accounts.	<p>To bootstrap the accounts, run the following commands:</p> <pre>cdk bootstrap --profile sourceAccount cdk bootstrap --profile destinationAccount</pre>	App developer
Clone the pattern code.	<p>To clone the repository, run the following command:</p>	App developer

Task	Description	Skills required
	<pre data-bbox="594 212 1024 365">git clone git@github.com:aws-samples/aws-cdk-examples.git</pre> <p data-bbox="594 407 992 533">Then, change the directory to the newly cloned project folder:</p> <pre data-bbox="594 575 1024 770">cd aws-cdk-examples/python/cross-account-eventbridge-in-organization</pre>	

## Deploy ProducerStack to the Source account

Task	Description	Skills required
<p data-bbox="110 1060 526 1186">Modify <code>cdk.json</code> with your AWS Organizations and account details.</p>	<p data-bbox="594 1060 992 1186">In the root folder of the project, make the following changes to <code>cdk.json</code>:</p> <ul data-bbox="594 1228 1024 1770" style="list-style-type: none"> <li data-bbox="594 1228 1024 1417">• <code>organization_id</code> – The Organizations ID of the accounts involved in your deployment</li> <li data-bbox="594 1438 1024 1564">• <code>event_bus_name</code> – <code>CrossAccount</code>, or you can rename it</li> <li data-bbox="594 1585 1024 1770">• <code>rules[].targets[].arn</code> – The AWS account ID of the consuming account (Destination account)</li> </ul>	<p data-bbox="1065 1060 1284 1092">App developer</p>

Task	Description	Skills required
Deploy the ProducerStack resources.	<p>Run the following command from the project's root directory:</p> <pre data-bbox="597 394 1026 554">cdk deploy ProducerStack --profile sourceAccount</pre> <p>When prompted, accept the new IAM roles and other security-related permissions created through AWS CloudFormation.</p>	App developer
Verify that ProducerStack resources are deployed.	<p>To verify the resources, do the following:</p> <ol style="list-style-type: none"><li>1. On the AWS Management Console for the Source account, choose <b>CloudFormation</b>.</li><li>2. From the list of stacks, choose <b>ProducerStack</b>.</li><li>3. On the <b>Stack Info</b> tab, verify that the stack status is <b>CREATE_COMPLETE</b> . Optionally, on the <b>Resources</b> tab, review the configured resources.</li></ol>	App developer

## Deploy ConsumerStack to the Destination account

Task	Description	Skills required
Deploy the ConsumerStack resources.	<p>Run the following command from the project's root directory:</p> <pre data-bbox="594 499 1027 659">cdk deploy ConsumerStack --profile destinationAccount</pre> <p>When prompted, accept the new IAM roles and other security-related permissions created through AWS CloudFormation.</p>	App developer
Verify that ConsumerStack resources are deployed	<ol style="list-style-type: none"><li>1. On the console for the Destination account, choose <b>CloudFormation</b>.</li><li>2. From the list of stacks, choose <b>ConsumerStack</b>.</li><li>3. On the <b>Stack Info</b> tab, verify that the stack status is <b>CREATE_COMPLETE</b> . Optionally, on the <b>Resources</b> tab, review the configured resources.</li></ol>	App developer



## Produce and consume events

Task	Description	Skills required
<p>Invoke the Producer Lambda function.</p>	<ol style="list-style-type: none"> <li>1. On the console for the Source account, choose <b>Lambda</b>.</li> <li>2. From the list of functions , choose <b>ProducerStack-ProducerLambdaXXXX</b> (XXXX represents a sequence of characters automatically generated by AWS CDK).</li> <li>3. Choose the <b>Test</b> tab.</li> <li>4. In the <b>Test event</b> section, choose <b>Test</b>.</li> </ol> <p>The Event JSON text area content can be any valid JSON that is provided to the Lambda function as the payload. In this case, the default provided JSON is sufficient.</p> <ol style="list-style-type: none"> <li>5. Verify that the <b>Executing function: succeeded</b> message appears in a green banner above the <b>Test event</b> section.</li> </ol>	<p>App developer</p>
<p>Verify that the event was received.</p>	<ol style="list-style-type: none"> <li>1. On the console for the Destination account, choose <b>Lambda</b>.</li> <li>2. From the list of functions , choose <b>ConsumerStack</b></li> </ol>	<p>App developer</p>

Task	Description	Skills required
	<p><b>tack-ConsumerLambd</b> <b>aXXXX</b> (XXXX represents a sequence of characters automatically generated by AWS CDK).</p> <ol style="list-style-type: none"> <li>Choose the <b>Monitor</b> tab.</li> <li>In the <b>Monitor</b> section, choose <b>View CloudWatch logs</b>.</li> <li>In the newly opened tab, choose the log stream name of the most recent log stream.</li> <li>Verify that a log statement such as the following appears:</li> </ol> <pre>[DEBUG]      2024-04-0 8T19:08:10.091Z     9c16844a- f9de-444d-b621-86a fe64d4cc8    Event: {'version':'0', 'id':'0b9faa96-973 f-8be2-ecf8-75e4f3 28b980', 'detail-t ype':'TestType', 'source':'Producer ', 'account' :'XXXXXXXXXXXX', 'time':'2024-04-08 T19:08:09Z', 'region':'us-east- 1', 'resource</pre>	

Task	Description	Skills required
	<pre>s': [], 'detail': {'key1': 'value1', 'key2': 'value2', 'key3': 'value3'}}</pre>	

## Cleanup

Task	Description	Skills required
Destroy the ConsumerStack resources.	<p>If you are using this pattern as a test, clean up the deployed resources to avoid incurring additional costs.</p> <p>Run the following command from the project's root directory:</p> <pre>cdk destroy ConsumerStack --profile destinationAccount</pre> <p>You will be prompted to confirm deletion of the stack.</p>	App developer
Destroy the ProducerStack resources.	<p>Run the following command from the project's root directory:</p> <pre>cdk destroy ProducerStack --profile sourceAccount</pre> <p>You will be prompted to confirm deletion of the stack.</p>	App developer

## Troubleshooting

Issue	Solution
No event was received in the Destination account.	<ol style="list-style-type: none"><li>1. Verify that the provided Organizations ID is correct.</li><li>2. Verify that the Source account is part of the provided organization.</li><li>3. Verify that the event bus rules in the Source account map to the correct information in the Destination account.</li></ol>
Invoking a Lambda function from the console returns the following error:  User: arn:aws:iam::123456789012:user/XXXXX is not authorized to perform: lambda:Invoke	Contact your AWS account administrator to receive the appropriate <code>lambda:Invoke</code> action permissions on the <code>ProducerStack-ProducerLambdaXXXX</code> Lambda function.

## Related resources

### References

- [AWS Organizations User Guide](#)
- [Amazon EventBridge event patterns](#)
- [Rules in Amazon EventBridge](#)

### Tutorials and videos

- [Tutorial: Creating and configuration an organization](#)
- [AWS re:Invent 2023 - Advanced event-driven patterns with Amazon EventBridge \(COM301-R\)](#)

## Additional information

### Producer rule

In the Source account, an EventBridge event bus is created to accept messages from producers (as shown in the *Architecture* section). A rule with accompanying IAM permissions is created on this event bus. The rules target the EventBridge event bus in the Destination account based on the following `cdk.json` structure:

```
"rules": [  
  {  
    "id": "CrossAccount",  
    "sources": ["Producer"],  
    "detail_types": ["TestType"],  
    "targets": [  
      {  
        "id": "ConsumerEventBus",  
        "arn": "arn:aws:events:us-east-2:012345678901:event-bus/CrossAccount"  
      }  
    ]  
  }  
]
```

For each consuming event bus, the event pattern and the target event bus must be included.

### *Event Pattern*

[Event patterns](#) filter which events this rule will apply to. For purposes of this example, the event sources and the record `detail_types` identify which events to transmit from the Source account's event bus to the Destination account's event bus.

### *Target event bus*

This rule targets an event bus that exists in another account. The full `arn` (Amazon Resource Name) is needed to uniquely identify the target event bus, and the `id` is the [logical ID](#) used by AWS CloudFormation. The target event bus need not actually exist at the time of target rule creation.

## **Destination account-specific considerations**

In the Destination account, an EventBridge event bus is created to receive messages from the Source account's event bus. To allow events to be published from the Source account, you must create a [resource-based policy](#):

```
{  
  "Version": "2012-10-17",
```

```
"Statement": [{
  "Sid": "AllowOrgToPutEvents",
  "Effect": "Allow",
  "Principal": "*",
  "Action": "events:PutEvents",
  "Resource": "arn:aws:events:us-east-2:012345678901:event-bus/CrossAccount",
  "Condition": {
    "StringEquals": {
      "aws:PrincipalOrgID": "o-XXXXXXXXXX"
    }
  }
}]
}
```

It's especially important to grant the `events:PutEvents` permission, which allows any other account in the same organization to publish events to this event bus. Setting `aws:PrincipalOrgId` as the organization ID grants the needed permissions.

## Event pattern

You can modify the included event pattern to meet your use case:

```
rule = events.Rule(
    self,
    self.id + 'Rule' + rule_definition['id'],
    event_bus=event_bus,
    event_pattern=events.EventPattern(
        source=rule_definition['sources'],
        detail_type=rule_definition['detail_types'],
    )
)
```

To reduce unnecessary processing, the event pattern should specify that only events to be processed by the Destination account are transmitted to the Destination account's event bus.

### *Resource-based policy*

This example uses the organization ID to control which accounts are allowed to put events on the Destination account's event bus. Consider using a more restrictive policy, such as specifying the Source account.

### *EventBridge quotas*

Keep in mind the following [quotas](#):

- 300 rules per event bus is the default quota. This can be expanded if necessary, but it should fit most use cases.
- Five targets per rule is the maximum allowed. We recommend that application architects should use a distinct rule for each Destination account to support fine-grained control over the event pattern.

# Deliver DynamoDB records to Amazon S3 using Kinesis Data Streams and Firehose with AWS CDK

Created by Shashank Shrivastava (AWS) and Daniel Matuki da Cunha (AWS)

**Code repository:** [Amazon DynamoDB ingestion into Amazon S3](#)

**Environment:** PoC or pilot

**Technologies:** Serverless; Data lakes; Databases; Storage & backup

**AWS services:** AWS CDK; Amazon DynamoDB; Amazon Data Firehose; Amazon Kinesis Data Streams; AWS Lambda; Amazon S3

## Summary

This pattern provides sample code and an application for delivering records from Amazon DynamoDB to Amazon Simple Storage Service (Amazon S3) by using Amazon Kinesis Data Streams and Amazon Data Firehose. The pattern's approach uses [AWS Cloud Development Kit \(AWS CDK\) L3 constructs](#) and includes an example of how to perform data transformation with AWS Lambda before data is delivered to the target S3 bucket on the Amazon Web Services (AWS) Cloud.

Kinesis Data Streams records item-level modifications in DynamoDB tables and replicates them to the required Kinesis data stream. Your applications can access the Kinesis data stream and view the item-level changes in near-real time. Kinesis Data Streams also provides access to other Amazon Kinesis services, such as Firehose and Amazon Managed Service for Apache Flink. This means that you can build applications that provide real-time dashboards, generate alerts, implement dynamic pricing and advertising, and perform sophisticated data analysis.

You can use this pattern for your data integration use cases. For example, transportation vehicles or industrial equipment can send high volumes of data to a DynamoDB table. This data can then be transformed and stored in a data lake hosted in Amazon S3. You can then query and process the data and predict any potential defects by using serverless services such as Amazon Athena, Amazon Redshift Spectrum, Amazon Rekognition, and AWS Glue.



## Prerequisites and limitations

### Prerequisites

- An active AWS account.
- AWS Command Line Interface (AWS CLI), installed and configured. For more information, see [Getting started with the AWS CLI](#) in the AWS CLI documentation.
- Node.js (18.x+) and npm, installed and configured. For more information, see [Downloading and installing Node.js and npm](#) in the npm documentation.
- aws-cdk (2.x+), installed and configured. For more information, see [Getting started with the AWS CDK](#) in the AWS CDK documentation.
- The GitHub [aws-dynamodb-kinesisfirehose-s3-ingestion](#) repository, cloned and configured on your local machine.
- Existing sample data for the DynamoDB table. The data must use the following format:  

```
{"SourceDataId": {"S": "123"}, "MessageData": {"S": "Hello World"}}
```

## Architecture

The following diagram shows an example workflow for delivering records from DynamoDB to Amazon S3 by using Kinesis Data Streams and Firehose.

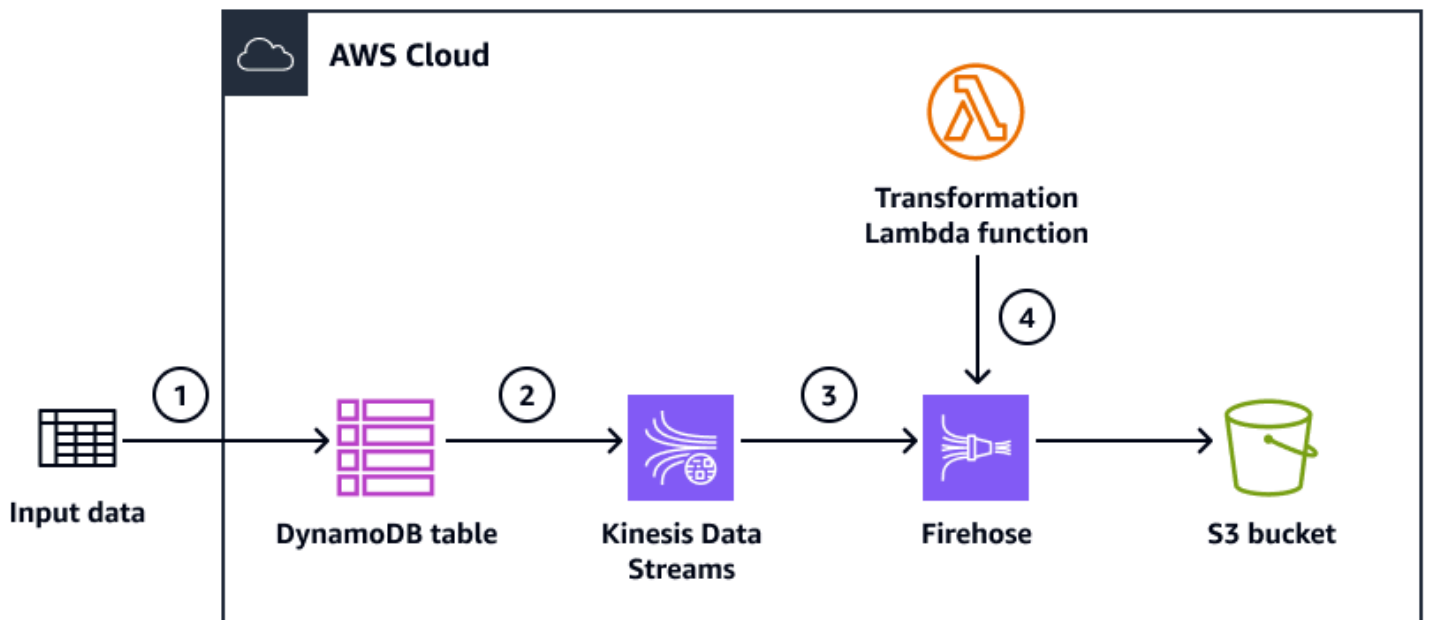

The diagram shows the following workflow:

1. Data is ingested using Amazon API Gateway as a proxy for DynamoDB. You can also use any other source to ingest data into DynamoDB.
2. Item-level changes are generated in near-real time in Kinesis Data Streams for delivery to Amazon S3.
3. Kinesis Data Streams sends the records to Firehose for transformation and delivery.
4. A Lambda function converts the records from a DynamoDB record format to JSON format, which contains only the record item attribute names and values.

## Tools

### *AWS services*

- [AWS Cloud Development Kit \(AWS CDK\)](#) is a software development framework that helps you define and provision AWS Cloud infrastructure in code.
- [AWS CDK Toolkit](#) is a command line cloud development kit that helps you interact with your AWS CDK app.
- [AWS Command Line Interface \(AWS CLI\)](#) is an open-source tool that helps you interact with AWS services through commands in your command-line shell.
- [AWS CloudFormation](#) helps you set up AWS resources, provision them quickly and consistently, and manage them throughout their lifecycle across AWS accounts and AWS Regions.

### *Code repository*

The code for this pattern is available in the GitHub [aws-dynamodb-kinesisfirehose-s3-ingestion](#) repository.

## Epics

### Set up and configure the sample code

Task	Description	Skills required
Install the dependencies.	On your local machine, install the dependencies from the package .json files in the pattern/a	App developer, General AWS

Task	Description	Skills required
	<p>ws-dynamodb-kinesisstreams-s3 and sample-application directories by running the following commands:</p> <pre>cd &lt;project_root&gt;/pattern/aws-dynamodb-kinesisstreams-s3</pre> <pre>npm install &amp;&amp; npm run build</pre> <pre>cd &lt;project_root&gt;/sample-application/</pre> <pre>npm install &amp;&amp; npm run build</pre>	

Task	Description	Skills required
Generate the CloudFormation template.	<ol style="list-style-type: none"><li>1. Run the <code>cd &lt;project_root&gt;/sample-application/</code> command.</li><li>2. Run the <code>cdk synth</code> command to generate the CloudFormation template.</li><li>3. The <code>AwsDynamo dbKinesisfirehoseS3IngestionStack.template.json</code> output is stored in the <code>cdk.out</code> directory.</li><li>4. Use AWS CDK or the AWS Management Console to process the template in CloudFormation.</li></ol>	App developer, General AWS, AWS DevOps

## Deploy the resources

Task	Description	Skills required
Check and deploy the resources.	<ol style="list-style-type: none"><li>1. Run the <code>cdk diff</code> command to identify the resource types that are created by the AWS CDK construct.</li><li>2. Run the <code>cdk deploy</code> command to deploy the resources.</li></ol>	App developer, General AWS, AWS DevOps

## Ingest data into the DynamoDB table to test the solution

Task	Description	Skills required
Ingest your sample data into the DynamoDB table.	<p>Send a request to your DynamoDB table by running the following command in AWS CLI:</p> <pre>aws dynamodb put-item --table-name &lt;your_table_name&gt; --item '{"&lt;table_partition_key&gt;": {"S": "&lt;partition_key_ID&gt;"},"MessageData":{"S": "&lt;data&gt;"}}'</pre> <p>example:</p> <pre>aws dynamodb put-item --table-name SourceData_table --item '{"SourceDataId": {"S": "123"},"MessageData":{"S": "Hello World"}}'</pre> <p>By default, the <code>put-item</code> doesn't return any value as output if the operation succeeds. If the operation fails, it returns an error. The data is stored in DynamoDB and then sent to Kinesis Data Streams and Firehose.</p>	App developer

Task	Description	Skills required
	<p><b>Note:</b> You use different approaches to add data into a DynamoDB table. For more information, see <a href="#">Load data into tables</a> in the DynamoDB documentation.</p>	
Verify that a new object is created in the S3 bucket.	<p>Sign in to the AWS Management Console and monitor the S3 bucket to verify that a new object was created with the data that you sent.</p> <p>For more information, see <a href="#">GetObject</a> in the Amazon S3 documentation.</p>	App developer, General AWS

## Clean up resources

Task	Description	Skills required
Clean up resources.	Run the <code>cdk destroy</code> command to delete all the resources used by this pattern.	App developer, General AWS

## Related resources

- [s3-static-site-stack.ts](#) (GitHub repository)
- [aws-apigateway-dynamodb module](#) (GitHub repository)
- [aws-kinesisstreams-kinesisfirehose-s3 module](#) (GitHub repository)
- [Change data capture for DynamoDB Streams](#) (DynamoDB documentation)

- [Using Kinesis Data Streams to capture changes to DynamoDB](#) (DynamoDB documentation)

# Integrate Amazon API Gateway with Amazon SQS to handle asynchronous REST APIs

*Created by Natalia Colantonio Favero (AWS) and Gustavo Martim (AWS)*

**Environment:** PoC or pilot

**Technologies:** Serverless;  
Messaging & communications

**AWS services:** Amazon API  
Gateway; Amazon SQS

## Summary

When you deploy REST APIs, sometimes you need to expose a message queue that client applications can publish. For example, you might have problems with the latency of third-party APIs and delays in responses, or you might want to avoid the response time of database queries or avoid scaling the server when there are a large number of concurrent APIs. In these scenarios, the client applications that publish to the queue only need to know that the API received the data—not what happens after the data was received.

This pattern creates a REST API endpoint by using [Amazon API Gateway](#) to send a message to [Amazon Simple Queue Service \(Amazon SQS\)](#). It creates an easy-to-implement integration between the two services that avoids direct access to the SQS queue.

## Prerequisites and limitations

- An [active AWS account](#)

## Architecture



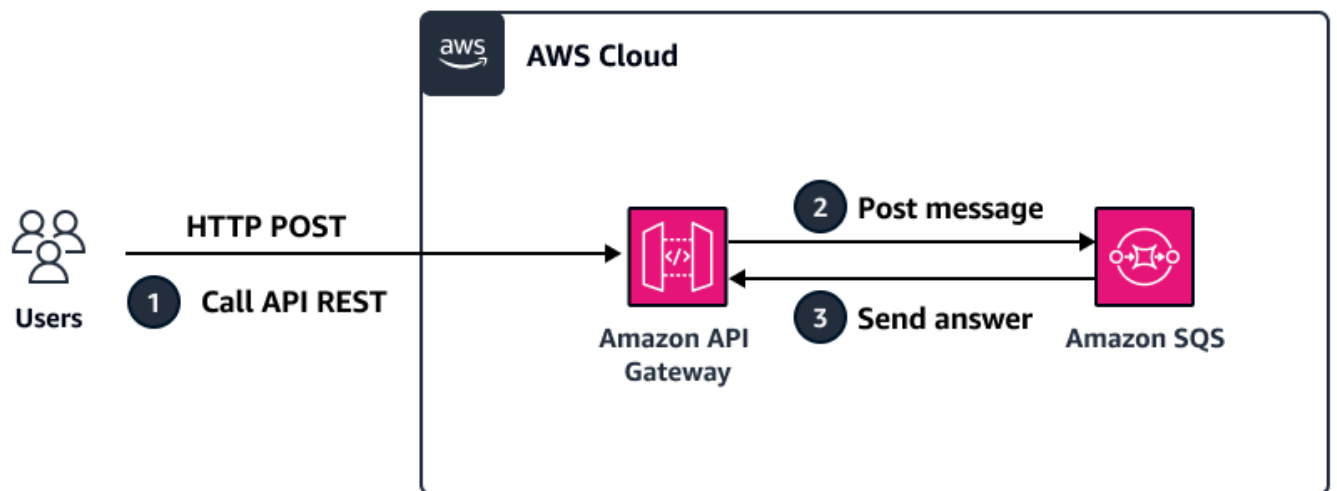

The diagram illustrates these steps:

1. Request a POST REST API endpoint by using a tool such as Postman, another API, or other technologies.
2. API Gateway posts a message, which is received on the request's body, on the queue.
3. Amazon SQS receives the message and sends an answer to API Gateway with a success or failure code.

## Tools

- [Amazon API Gateway](#) helps you create, publish, maintain, monitor, and secure REST, HTTP, and WebSocket APIs at any scale.
- [AWS Identity and Access Management \(IAM\)](#) helps you securely manage access to your AWS resources by controlling who is authenticated and authorized to use them.
- [Amazon Simple Queue Service \(Amazon SQS\)](#) provides a secure, durable, and available hosted queue that helps you integrate and decouple distributed software systems and components.

# Epics

## Create an SQS queue

Task	Description	Skills required
Create a queue.	<p>To create an SQS queue that receives the messages from the REST API:</p> <ol style="list-style-type: none"><li>1. Sign in to your <a href="#">AWS account</a>.</li><li>2. Open the Amazon SQS console at <a href="https://console.aws.amazon.com/sqs/">https://console.aws.amazon.com/sqs/</a>.</li><li>3. Choose <b>Create queue</b>.</li><li>4. On the <b>Create queue</b> page, choose the correct AWS Region from the <b>Region</b> dropdown list.</li><li>5. For <b>Type</b>, keep the default setting (<b>Standard</b>).</li><li>6. Enter a <b>Name</b> for your queue.</li><li>7. Keep the default values for all other settings.</li><li>8. Choose <b>Create queue</b>.</li></ol>	App developer

## Provide access to Amazon SQS

Task	Description	Skills required
Create an IAM role.	<p>This IAM role gives API Gateway resources full access to Amazon SQS.</p> <ol style="list-style-type: none"><li>1. Open the IAM console at <a href="https://console.aws.amazon.com/iam/">https://console.aws.amazon.com/iam/</a>.</li><li>2. In the navigation pane, choose <b>Roles, Create role</b>.</li><li>3. For <b>Trusted entity type</b>, choose <b>AWS service</b>.</li><li>4. For <b>Use case</b>, choose <b>API Gateway</b> from the dropdown list, and then choose <b>Next, Next</b>.</li><li>5. For <b>Role name</b>, enter <b>AWSGatewayRoleForSQS</b> and an optional description, and then choose <b>Create role</b>.</li><li>6. In the <b>Roles</b> pane, search for <b>AWSGatewayRoleForSQS</b>, and select its checkbox.</li><li>7. In the <b>Permissions policies</b> section, choose <b>Add permissions, Attach policies</b>.</li><li>8. Search for <b>AmazonSQS FullAccess</b> and select it.</li><li>9. Choose <b>Add permissions</b>.</li></ol>	App developer, AWS administrator

Task	Description	Skills required
	10 In the <b>Summary</b> section of <b>AWSGatewayRoleForSQS</b> , copy the Amazon Resource Number (ARN). You will use this ID in a later step.	

## Create a REST API

Task	Description	Skills required
Create a REST API.	<p>This is the REST API that HTTP requests are sent to.</p> <ol style="list-style-type: none"> <li>1. Open the API Gateway console at <a href="https://console.aws.amazon.com/apigateway/">https://console.aws.amazon.com/apigateway/</a>.</li> <li>2. In the <b>REST API</b> section, choose <b>Build</b>.</li> <li>3. For <b>API name</b>, enter a name and an optional description for your API, keep all other default settings, and then choose <b>Create API</b>.</li> </ol>	App developer
Connect API Gateway to Amazon SQS.	<p>This step enables the message to flow from inside the HTTP request's body to Amazon SQS.</p> <ol style="list-style-type: none"> <li>1. On the <a href="#">API Gateway console</a>, choose the API that you created.</li> </ol>	App developer

Task	Description	Skills required
	<ol style="list-style-type: none"> <li>2. On the <b>Resources</b> page, in the <b>Methods</b> section, choose <b>Create method</b>.</li> <li>3. For <b>Method type</b>, choose <b>POST</b>.</li> <li>4. For <b>Integration type</b>, choose <b>AWS service</b>.</li> <li>5. For <b>AWS Region</b>, choose the Region where you created your SQS queue.</li> <li>6. For <b>AWS service</b>, choose <b>Simple Queue Service (SQS)</b>.</li> <li>7. For HTTP method, choose <b>POST</b>.</li> <li>8. For <b>Action type</b>, choose <b>Use path override</b>.</li> <li>9. For <b>Path override</b>, enter <b>&lt;AWS account ID&gt;/&lt;name of SQS queue&gt;</b>.</li> <li>10 For <b>Execution role</b>, paste the ARN of the role that you created earlier.</li> <li>11 Choose <b>Create method</b>.</li> </ol>	

## Test the REST API

Task	Description	Skills required
Test the REST API.	Run a test to check for missing configuration:	App developer

Task	Description	Skills required
	<ol style="list-style-type: none"><li>1. On the <a href="#">API Gateway console</a>, choose the REST API that you created.</li><li>2. In the <b>Resources</b> pane, choose the <b>POST</b> method.</li><li>3. Choose the <b>Test</b> tab. (Use the right arrow if the tab isn't displayed.)</li><li>4. For <b>Request body</b>, paste the following JSON code:<pre data-bbox="630 739 1029 940">{   "message":   "lorem ipsum" }</pre></li><li>5. Choose <b>Test</b>.</li></ol> <p>You will receive an error that's similar to the following:</p> <pre data-bbox="630 1201 1029 1323">&lt;UnknownOperationE xception/&gt;</pre>	

Task	Description	Skills required
Change the API integration to forward the request properly to Amazon SQS.	<p>Complete the configuration to fix the integration error:</p> <ol style="list-style-type: none"><li>1. On the <a href="#">API Gateway console</a>, choose the API you created, and then choose <b>POST</b>.</li><li>2. The <b>Method Execution</b> section shows the visual mapping between API Gateway and Amazon SQS. From this section, choose <b>Integration request</b>, and then choose <b>Edit</b>.</li><li>3. Expand the <b>HTTP headers</b> section, and then choose the <b>Add request header</b> parameter.<ul style="list-style-type: none"><li>• For <b>Name</b>, specify <b>Content-Type</b>.</li><li>• For <b>Mapped from</b>, enter <b>'application/x-www-form-urlencoded'</b>. Make sure to include the single quotation marks.</li><li>• Select the <b>Caching</b> checkbox.</li></ul></li><li>4. Expand the <b>Mapping templates</b> section.<ul style="list-style-type: none"><li>• Choose <b>Add mapping template</b>.</li><li>• For <b>Content type</b>, enter <b>application/json</b>.</li></ul></li></ol>	App developer

Task	Description	Skills required
	<ul style="list-style-type: none"><li>For <b>Template body</b>, paste this code: <pre>Action=SendMessage &amp;MessageBody=\$input.body</pre></li><li>Choose <b>Save</b>.</li></ul>	



Task	Description	Skills required
Test and validate the message in Amazon SQS.	<p>Run a test to confirm that the test completed successfully:</p> <ol style="list-style-type: none"><li>1. On the <a href="#">API Gateway console</a>, choose the REST API you created.</li><li>2. In the <b>Resources</b> pane, choose the <b>POST</b> method.</li><li>3. Choose the <b>Test</b> tab. (Use the right arrow if the tab isn't displayed.)</li><li>4. For <b>Request body</b>, paste the following JSON code:<pre data-bbox="630 884 1029 1083">{   "message":   "lorem ipsum" }</pre></li><li>5. Choose <b>Test</b>.</li><li>6. Open the <a href="#">Amazon SQS console</a>.</li><li>7. In the navigation pane, choose <b>Queues</b>, and then choose your queue.</li><li>8. Choose <b>Send and receive messages</b>.</li><li>9. Choose <b>Poll for messages</b>.</li><li>10 Choose <b>Message</b>. It should display the following:<pre data-bbox="630 1696 1029 1814">Body { "message":       "lorem ipsum" }</pre></li></ol>	App developer

Task	Description	Skills required
Test API Gateway with a special character.	<p>Run a test that includes special characters (such as &amp;) that aren't acceptable in a message:</p> <ol style="list-style-type: none"><li>1. On the <a href="#">API Gateway console</a>, choose your API.</li><li>2. Repeat the test from the earlier step by using the following JSON code:</li></ol> <pre data-bbox="634 722 1029 919">{   "message":   "lorem ipsum &amp;" }</pre> <ol style="list-style-type: none"><li>3. Choose <b>Test</b>.</li></ol> <p>You will receive an error such as the following:</p>	App developer

Task	Description	Skills required
	<pre data-bbox="630 205 1029 268">}</pre> <p data-bbox="591 338 1019 800">This is because special characters aren't supported by default in the message body. In the next step, you'll configure API Gateway to support special characters. For more information about content type conversions, see the <a href="#">API Gateway documentation</a>.</p>	

Task	Description	Skills required
Change the API configuration to support special characters.	<p>Adjust the configuration to accept special characters in the message:</p> <ol style="list-style-type: none"><li>1. On the <a href="#">API Gateway console</a>, choose the API you created, and then choose <b>POST</b>.</li><li>2. Choose <b>Integration request</b>, and then choose <b>Edit</b>.</li><li>3. Change <b>Content Handling</b> to <b>Convert to text</b>.</li><li>4. In the <b>Mapping templates</b> section:<ul style="list-style-type: none"><li>• For <b>Content type</b>, enter <b>application/json</b>.</li><li>• For <b>Template body</b>, specify:<pre data-bbox="662 1188 1029 1388">Action=SendMessage &amp;MessageBody=\$util .urlEncode(\$input. body)</pre></li><li>• Choose <b>Save</b>.</li></ul></li><li>5. Choose the <b>Test</b> tab.</li><li>6. For <b>Request body</b>, enter the JSON code from earlier:<pre data-bbox="630 1686 1029 1843">{   " message":   "lorem ipsum &amp;" }</pre></li></ol>	App developer

Task	Description	Skills required
	<ol style="list-style-type: none"> <li>7. Choose <b>Test</b>.</li> <li>8. Open the <a href="#">Amazon SQS console</a>.</li> <li>9. Select your queue, and then choose <b>Send and receive messages, Poll for messages, Message</b> as earlier.</li> </ol> <p>The new message should include the special character.</p>	

## Deploy the REST API

Task	Description	Skills required
Deploy the API.	<p>To deploy the REST API:</p> <ol style="list-style-type: none"> <li>1. Open the <a href="#">API Gateway console</a>.</li> <li>2. Choose your API.</li> <li>3. Choose <b>Deploy API</b>. For more information about this step, see the <a href="#">API Gateway documentation</a>.</li> </ol>	App developer
Test with an external tool.	Run a test with an external tool to confirm that the message is received successfully:	App developer

Task	Description	Skills required
	<ol style="list-style-type: none"><li>1. Open a tool such as Postman, Insomnia, or cURL.</li><li>2. Run your API.</li><li>3. Open the <a href="#">Amazon SQS console</a>.</li><li>4. Select your queue.</li><li>5. Load messages to see the new message.</li></ol>	

## Clean Up

Task	Description	Skills required
Delete the API.	On the <a href="#">API Gateway console</a> , choose the API you created, and then choose <b>Delete</b> .	App developer
Delete the IAM role.	On the <a href="#">IAM console</a> , in the <b>Roles</b> pane, select <b>AWSGatewayRoleForSQS</b> , and then choose <b>Delete</b> .	App developer
Delete the SQS queue.	On the <a href="#">Amazon SQS console</a> , in the <b>Queues</b> pane, choose the SQS queue you created, and then choose <b>Delete</b> .	App developer

## Related resources

- [SQS-SendMessage](#) (API Gateway documentation)
- [Content type conversions in API Gateway](#) (API Gateway documentation)
- [\\$util variables](#) (API Gateway documentation)

- [How do I integrate an API Gateway REST API with Amazon SQS and resolve common errors?](#)  
(AWS re:Post article)

# Process events asynchronously with Amazon API Gateway and AWS Lambda

Created by Andrea Meroni (AWS), Nadim Majed (AWS), Mariem Kthiri (AWS), and Michael Wallner (AWS)

**Code repository:** [Asynchronous Event Processing with API Gateway and Lambda](#)

**Environment:** PoC or pilot

**Technologies:** Serverless

**AWS services:** Amazon API Gateway; Amazon DynamoDB; AWS Lambda

## Summary

[Amazon API Gateway](#) is a fully managed service that developers can use to create, publish, maintain, monitor, and secure APIs at any scale. It handles the tasks involved in accepting and processing up to hundreds of thousands of concurrent API calls.

An important service quota of API Gateway is the integration timeout. The timeout is the maximum time in which a backend service must return a response before the REST API returns an error. The hard limit of 29 seconds is generally acceptable for synchronous workloads. However, that limit represents a challenge for those developers who want to use API Gateway with asynchronous workloads.

This pattern shows an example architecture to process events asynchronously using API Gateway and AWS Lambda. The architecture supports running processing jobs of duration up to 15 minutes, and it uses a basic REST API as the interface.

[Projen](#) is used to set up the local development environment and to deploy the example architecture to a target AWS account, in combination with the [AWS Cloud Development Kit \(AWS CDK\) Toolkit](#), [Docker](#), and [Node.js](#). Projen automatically sets up a [Python](#) virtual environment with [pre-commit](#) and the tools that are used for code quality assurance, security scanning, and unit testing. For more information, see the [Tools](#) section.



# Prerequisites and limitations

## Prerequisites

- An active AWS account
- The following tools installed on your workstation:
  - [AWS Cloud Development Kit \(AWS CDK\) Toolkit](#) version 2.85.0
  - [Docker](#) version 20.10.21
  - [Node.js](#) version 18.13.0
  - [Projen](#) version 0.71.111
  - [Python](#) version 3.9.16

## Limitations

- The maximum runtime of a job is limited by the maximum runtime for Lambda functions (15 minutes).
- The maximum number of concurrent job requests is limited by the reserved concurrency of the Lambda function.

## Architecture

The following diagram shows the interaction of the jobs API with the event-processing and error-handling Lambda functions, with events stored in an Amazon EventBridge event archive.

A typical workflow includes the following steps:

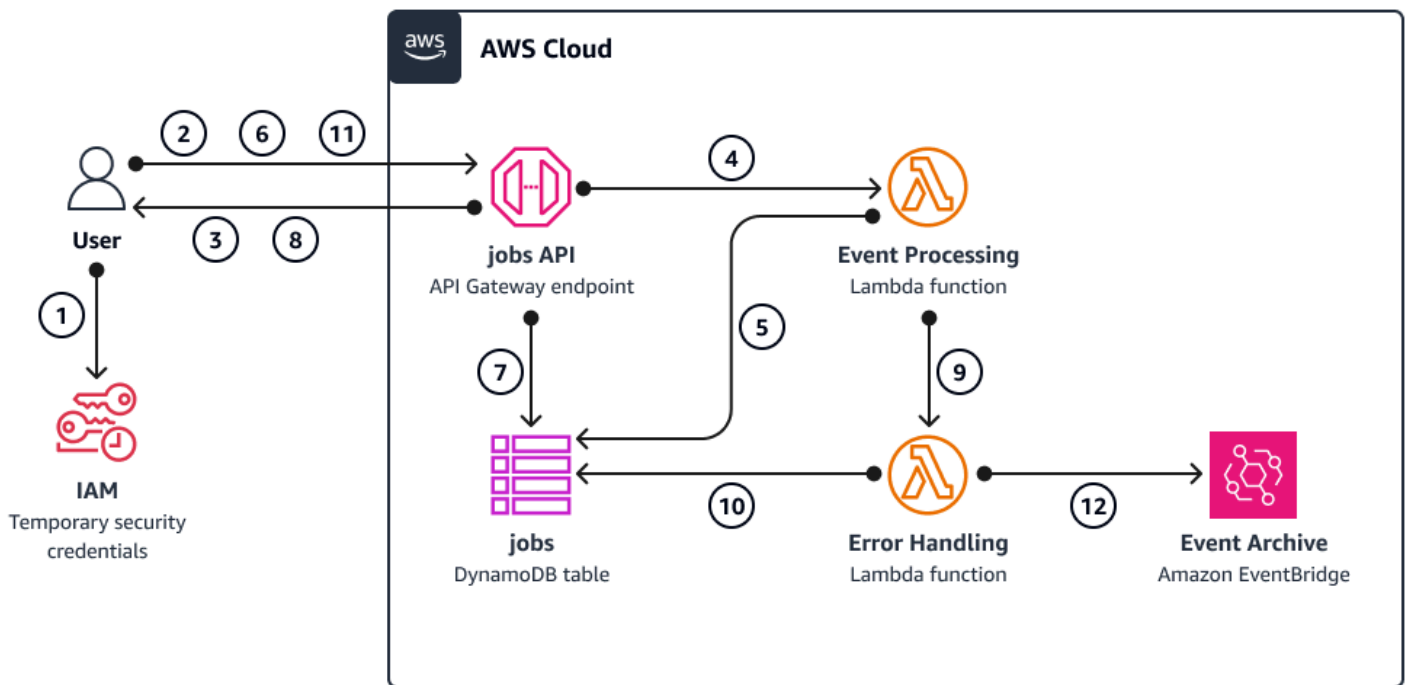

1. You authenticate against AWS Identity and Access Management (IAM) and obtain security credentials.
2. You send an HTTP POST request to the /jobs jobs API endpoint, specifying the job parameters in the request body.
3. The jobs API, which is an API Gateway REST API, returns to you an HTTP response that contains the job identifier.
4. The jobs API invokes asynchronously the event-processing Lambda function.
5. The event-processing function processes the event, and then it puts the job results in the jobs Amazon DynamoDB table
6. You send an HTTP GET request to the /jobs/{jobId} jobs API endpoint, with the job identifier from step 3 as {jobId}.
7. The jobs API queries the jobs DynamoDB table to retrieve the job results.
8. The jobs API returns an HTTP response that contains the job results.
9. If the event processing fails, the event-processing function sends the event to the error-handling function.
10. The error-handling function puts the job parameters in the jobs DynamoDB table.
11. You can retrieve the job parameters by sending an HTTP GET request to the /jobs/{jobId} jobs API endpoint.

12 If the error handling fails, the error-handling function sends the event to an EventBridge event archive.

You can replay the archived events by using EventBridge.

## Tools

### AWS services

- [AWS Cloud Development Kit \(AWS CDK\)](#) is a software development framework that helps you define and provision AWS Cloud infrastructure in code.
- [AWS Command Line Interface \(AWS CLI\)](#) is an open source tool that helps you interact with AWS services through commands in your command-line shell.
- [Amazon DynamoDB](#) is a fully managed NoSQL database service that provides fast, predictable, and scalable performance.
- [Amazon EventBridge](#) is a serverless event bus service that helps you connect your applications with real-time data from a variety of sources. For example, Lambda functions, HTTP invocation endpoints using API destinations, or event buses in other AWS accounts.
- [AWS Lambda](#) is a compute service that helps you run code without needing to provision or manage servers. It runs your code only when needed and scales automatically, so you pay only for the compute time that you use.

### Other tools

- [autopep8](#) automatically formats Python code based on the Python Enhancement Proposal (PEP) 8 style guide.
- [Bandit](#) scans Python code to find common security issues.
- [Commitizen](#) is a Git commit checker and CHANGELOG generator.
- [cfn-lint](#) is an AWS CloudFormation linter
- [Checkov](#) is a static code-analysis tool that checks infrastructure as code (IaC) for security and compliance misconfigurations.
- [jq](#) is a command-line tool for parsing JSON.
- [Postman](#) is an API platform.
- [pre-commit](#) is a Git hooks manager.
- [Projen](#) is a project generator.

- [pytest](#) is a Python framework for writing small, readable tests.

## Code repository

This example architecture code can be found in the GitHub [Asynchronous Event Processing with API Gateway and Lambda](#) repository.

## Best practices

- This example architecture doesn't include monitoring of the deployed infrastructure. If your use case requires monitoring, evaluate adding [CDK Monitoring Constructs](#) or another monitoring solution.
- This example architecture uses [IAM permissions](#) to control the access to the jobs API. Anyone authorized to assume the `JobsAPIInvokeRole` will be able to invoke the jobs API. As such, the access control mechanism is binary. If your use case requires a more complex authorization model, evaluate using a different [access control mechanism](#).
- When a user sends an HTTP POST request to the `/jobs` jobs API endpoint, the input data is validated at two different levels:
  - Amazon API Gateway is in charge of the first [request validation](#).
  - The event processing function performs the second request.

No validation is performed when the user does an HTTP GET request to the `/jobs/{jobId}` jobs API endpoint. If your use case requires additional input validation and an increased level of security, evaluate [using AWS WAF to protect your API](#).

## Epics

### Set up the environment

Task	Description	Skills required
Clone the repository.	To clone the repository locally, run the following command: <pre>git clone https://github.com/aws-samp</pre>	DevOps engineer

Task	Description	Skills required
	<pre>les/asynchronous-event-processing-api-gateway-lambda-cdk.git</pre>	
Set up the project.	<p>Change the directory to the repository root and set up the Python virtual environment and all the tools by using <a href="#">Projen</a>:</p> <pre>cd asynchronous-event-processing-api-gateway-lambda-cdk npx projen</pre>	DevOps engineer
Install pre-commit hooks.	<p>To install pre-commit hooks, do the following:</p> <ol style="list-style-type: none"> <li>1. Activate the <a href="#">Python virtual environment</a>: <pre>source .env/bin/activate</pre> </li> <li>2. Install the <a href="#">pre-commit hooks</a>: <pre>pre-commit install pre-commit install --hook-type commit-msg</pre> </li> </ol>	DevOps engineer

## Deploy the example architecture

Task	Description	Skills required
Bootstrap AWS CDK.	<p>To bootstrap AWS CDK in your AWS account, run the following command:</p> <pre>AWS_PROFILE=\$YOUR_ AWS_PROFILE npx projen bootstrap</pre>	AWS DevOps
Deploy the example architecture.	<p>To deploy the example architecture in your AWS account, run the following command:</p> <pre>AWS_PROFILE=\$YOUR_ AWS_PROFILE npx projen deploy</pre>	AWS DevOps

## Test the architecture

Task	Description	Skills required
Install test prerequisites.	<p>Install on your workstation on the <a href="#">AWS Command Line Interface (AWS CLI)</a>, <a href="#">Postman</a>, and <a href="#">jq</a>.</p> <p>Using <a href="#">Postman</a> to test this example architecture is suggested but not mandatory. If you choose an alternative API testing tool, make sure that it supports <a href="#">AWS Signature Version 4 authentication</a>.</p>	DevOps engineer

Task	Description	Skills required
	<p><a href="#">ation</a>, and refer to the exposed API endpoints that can be inspected by <a href="#">exporting the REST API</a>.</p>	
Assume the JobsAPIInvokeRole .	<p><a href="#">Assume</a> the JobsAPIInvokeRole that was printed as output from the deploy command:</p> <pre>CREDENTIALS=\$(AWS_PROFILE=\$&lt;YOUR_AWS_PROFILE&gt; aws sts assume-role \ --no-cli-pager \ --role-arn \$&lt;JOBS_API_INVOKE_ROLE_ARN&gt; \ --role-session-name JobsAPIInvoke) export AWS_ACCESS_KEY_ID=\$(cat \$CREDENTIALS   jq '.Credentials'.AccessKeyId) export AWS_SECRET_ACCESS_KEY=\$(cat \$CREDENTIALS   jq '.Credentials'.SecretAccessKey) export AWS_SESSION_TOKEN=\$(cat \$CREDENTIALS   jq '.Credentials'.SessionToken)</pre>	AWS DevOps

Task	Description	Skills required
Configure Postman.	<ol style="list-style-type: none"><li data-bbox="592 226 1027 457">1. To <a href="#">import</a> the Postman collection that's included in the repository, follow the instructions in the <a href="#">Postman documentation</a>.</li><li data-bbox="592 478 1027 1843">2. <a href="#">Set</a> the JobsAPI variables with the following values:<ul style="list-style-type: none"><li data-bbox="630 583 1027 856">• <code>accessKey</code> – The value of the <code>Credentials.AccessKeyId</code> attribute from the <code>assume-role</code> command</li><li data-bbox="630 877 1027 1150">• <code>baseUrl</code> – The value of the <code>JobsApiJobsAPIEndpoint</code> output from the <code>deploy</code> command, without the trailing slash</li><li data-bbox="630 1171 1027 1360">• <code>region</code> – The value of the AWS Region where you deployed the example architecture</li><li data-bbox="630 1381 1027 1570">• <code>seconds</code> – The value of the input parameter for the example job. It must be a positive integer</li><li data-bbox="630 1591 1027 1843">• <code>secretKey</code> – The value of the <code>Credentials.SecretAccessKey</code> attribute from the <code>assume-role</code> command</li></ul></li></ol>	AWS DevOps



Task	Description	Skills required
	<ul style="list-style-type: none"> <li>sessionToken           <ul style="list-style-type: none"> <li>The value of the Credentials.SessionToken attribute from the assume-role command</li> </ul> </li> </ul>	
Test the example architecture.	To test the example architecture, <a href="#">send requests</a> to the jobs API. For more information, see the <a href="#">Postman documentation</a> .	DevOps engineer

## Troubleshooting

Issue	Solution
Destruction and subsequent redeployment of the example architecture fails because the <a href="#">Amazon CloudWatch Logs log group</a> /aws/apigateway/JobsAPIAccessLogs already exists.	<ol style="list-style-type: none"> <li>If necessary, <a href="#">export your log data to Amazon S3</a>.</li> <li>Delete the CloudWatch Logs log group /aws/apigateway/JobsAPIAccessLogs .</li> <li>Redeploy the example architecture.</li> </ol>

## Related resources

- [API Gateway mapping template and access logging variable reference](#)
- [Set up asynchronous invocation of the backend Lambda function](#)

# Process events asynchronously with Amazon API Gateway and Amazon DynamoDB Streams

Created by Andrea Meroni (AWS), Alessandro Trisolini (AWS), Nadim Majed (AWS), Mariem Kthiri (AWS), and Michael Wallner (AWS)

**Code repository:** [Asynchronous Processing with API Gateway and DynamoDB Streams](#)

**Environment:** PoC or pilot

**Technologies:** Serverless

**AWS services:** Amazon API Gateway; Amazon DynamoDB; Amazon DynamoDB Streams; AWS Lambda; Amazon SNS

## Summary

[Amazon API Gateway](#) is a fully managed service that developers can use to create, publish, maintain, monitor, and secure APIs at any scale. It handles the tasks involved in accepting and processing up to hundreds of thousands of concurrent API calls.

An important service quota of API Gateway is the integration timeout. The timeout is the maximum time in which a backend service must return a response before the REST API returns an error. The hard limit of 29 seconds is generally acceptable for synchronous workloads. However, that limit represents a challenge for those developers who want to use API Gateway with asynchronous workloads.

This pattern shows an example architecture for processing events asynchronously using API Gateway, Amazon DynamoDB Streams, and AWS Lambda. The architecture supports running parallel processing jobs with the same input parameters, and it uses a basic REST API as the interface. In this example, using Lambda as the backend limits the duration of jobs to 15 minutes. You can avoid this limit by using an alternative service to process incoming events (for example, AWS Fargate).

[Projen](#) is used to set up the local development environment and to deploy the example architecture to a target AWS account, in combination with the [AWS Cloud Development Kit \(AWS CDK\) Toolkit](#), [Docker](#) and [Node.js](#). Projen automatically sets up a [Python](#) virtual environment with [pre-commit](#) and the tools that are used for code quality assurance, security scanning, and unit testing. For more information, see the [Tools](#) section.

## Prerequisites and limitations

### Prerequisites

- An active AWS account
- The following tools installed on your workstation:
  - [AWS Cloud Development Kit \(AWS CDK\) Toolkit](#) version 2.85.0 or later
  - [Docker](#) version 20.10.21 or later
  - [Node.js](#) version 18 or later
  - [Projen](#) version 0.71.111 or later
  - [Python](#) version 3.9.16 or later

### Limitations

- The advised maximum number of readers for DynamoDB Streams is two to avoid throttling.
- The maximum runtime of a job is limited by the maximum runtime for Lambda functions (15 minutes).
- The maximum number of concurrent job requests is limited by the reserved concurrency of the Lambda functions.

## Architecture

### Architecture

The following diagram shows the interaction of the jobs API with DynamoDB Streams and the event-processing and error-handling Lambda functions, with events stored in an Amazon EventBridge event archive.

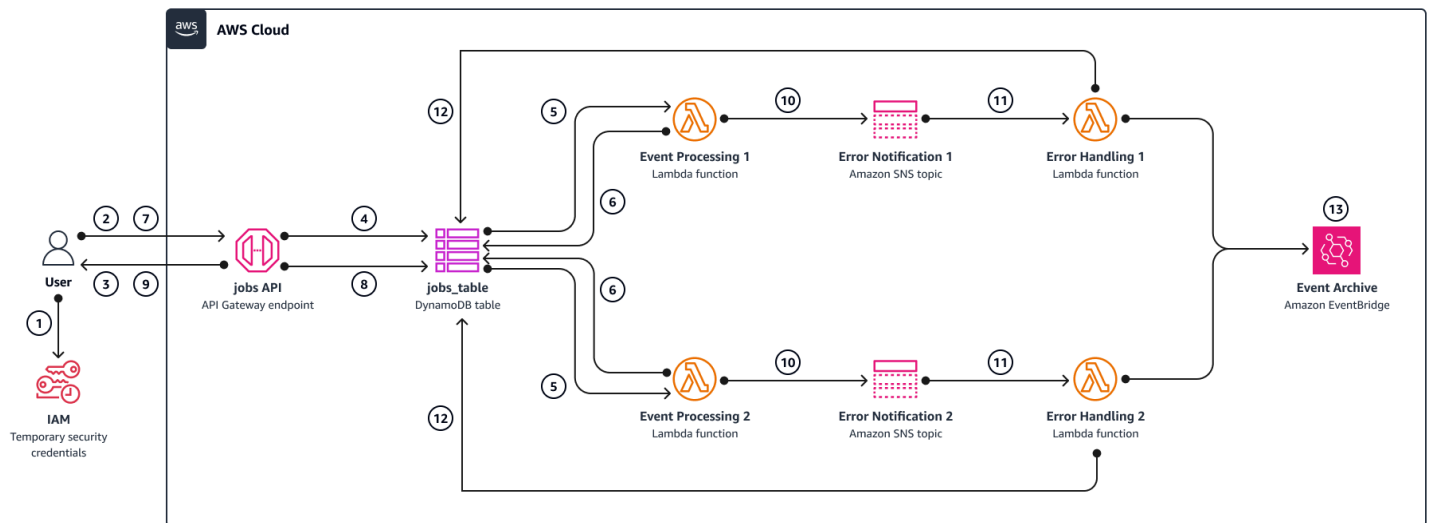

A typical workflow includes the following steps:

1. You authenticate against AWS Identity and Access Management (IAM) and obtain security credentials.
2. You send an HTTP POST request to the /jobs jobs API endpoint, specifying the job parameters in the request body.
3. The jobs API returns to you an HTTP response that contains the job identifier.
4. The jobs API puts the job parameters in the jobs\_table Amazon DynamoDB table.
5. The jobs\_table DynamoDB table DynamoDB stream invokes the event-processing Lambda functions.
6. The event-processing Lambda functions process the event and then put the job results in the jobs\_table DynamoDB table. To help ensure consistent results, the event-processing functions implement an [optimistic locking](#) mechanism.
7. You send an HTTP GET request to the /jobs/{jobId} jobs API endpoint, with the job identifier from step 3 as {jobId}.
8. The jobs API queries the jobs\_table DynamoDB table to retrieve the job results.
9. The jobs API returns an HTTP response that contains the job results.
10. If the event processing fails, the event-processing function's source mapping sends the event to the error-handling Amazon Simple Notification Service (Amazon SNS) topic.
11. The error-handling SNS topic asynchronously pushes the event to the error-handling function.
12. The error-handling function puts the job parameters in the jobs\_table DynamoDB table.

You can retrieve the job parameters by sending an HTTP GET request to the `/jobs/{jobId}` jobs API endpoint.

13 If the error handling fails, the error-handling function sends the event to an Amazon EventBridge archive.

You can replay the archived events by using EventBridge.

## Tools

### AWS services

- [AWS Cloud Development Kit \(AWS CDK\)](#) is a software development framework that helps you define and provision AWS Cloud infrastructure in code.
- [Amazon DynamoDB](#) is a fully managed NoSQL database service that provides fast, predictable, and scalable performance.
- [Amazon EventBridge](#) is a serverless event bus service that helps you connect your applications with real-time data from a variety of sources. For example, AWS Lambda functions, HTTP invocation endpoints using API destinations, or event buses in other AWS accounts.
- [AWS Lambda](#) is a compute service that helps you run code without needing to provision or manage servers. It runs your code only when needed and scales automatically, so you pay only for the compute time that you use.
- [Amazon Simple Notification Service \(Amazon SNS\)](#) helps you coordinate and manage the exchange of messages between publishers and clients, including web servers and email addresses.

### Other tools

- [autopep8](#) automatically formats Python code based on the Python Enhancement Proposal (PEP) 8 style guide.
- [Bandit](#) scans Python code to find common security issues.
- [Commitizen](#) is a Git commit checker and CHANGELOG generator.
- [cfn-lint](#) is an AWS CloudFormation linter
- [Checkov](#) is a static code-analysis tool that checks infrastructure as code (IaC) for security and compliance misconfigurations.

- [jq](#) is a command-line tool for parsing JSON.
- [Postman](#) is an API platform.
- [pre-commit](#) is a Git hooks manager.
- [Projen](#) is a project generator.
- [pytest](#) is a Python framework for writing small, readable tests.

## Code repository

This example architecture code can be found in the GitHub [Asynchronous Processing with API Gateway and DynamoDB Streams](#) repository.

## Best practices

- This example architecture doesn't include monitoring of the deployed infrastructure. If your use case requires monitoring, evaluate adding [CDK Monitoring Constructs](#) or another monitoring solution.
- This example architecture uses [IAM permissions](#) to control the access to the jobs API. Anyone authorized to assume the `JobsAPIInvokeRole` will be able to invoke the jobs API. As such, the access control mechanism is binary. If your use case requires a more complex authorization model, evaluate using a different [access control mechanism](#).
- When a user sends an HTTP POST request to the `/jobs` jobs API endpoint, the input data is validated at two different levels:
  - API Gateway is in charge of the first [request validation](#).
  - The event processing function performs the second request.

No validation is performed when the user does an HTTP GET request to the `/jobs/{jobId}` jobs API endpoint. If your use case requires additional input validation and an increased level of security, evaluate [using AWS WAF to protect your API](#).

- To avoid throttling, the [DynamoDB Streams documentation](#) discourages users from reading with more than two consumers from the same stream's shard. To scale out the number of consumers, we recommend using [Amazon Kinesis Data Streams](#).
- [Optimistic locking](#) has been used in this example to ensure consistent updates of items in the `jobs_table` DynamoDB table. Depending on the use-case requirement, you might need to implement more reliable locking mechanisms, such as pessimistic locking.

# Epics

## Set up the environment

Task	Description	Skills required
Clone the repository.	<p>To clone the repository locally, run the following command:</p> <pre>git clone https://github.com/aws-samples/asynchronous-event-processing-api-gateway-dynamodb-streams-cdk.git</pre>	DevOps engineer
Set up the project.	<p>Change the directory to the repository root, and set up the Python virtual environment and all the tools by using <a href="#">Projen</a>:</p> <pre>cd asynchronous-event-processing-api-gateway-api-gateway-dynamodb-streams-cdk npm projen</pre>	DevOps engineer
Install pre-commit hooks.	<p>To install pre-commit hooks, do the following:</p> <ol style="list-style-type: none"><li>1. Activate the <a href="#">Python virtual environment</a>:</li></ol> <pre>source .env/bin/activate</pre>	DevOps engineer

Task	Description	Skills required
	<p>2. Install the <a href="#">pre-commit</a> hooks:</p> <pre>pre-commit install pre-commit install -- hook-type commit-msg</pre>	

## Deploy the example architecture

Task	Description	Skills required
Bootstrap AWS CDK.	<p>To bootstrap <a href="#">AWS CDK</a> in your AWS account, run the following command:</p> <pre>AWS_PROFILE=\$YOUR_ AWS_PROFILE npx projen bootstrap</pre>	AWS DevOps
Deploy the example architecture.	<p>To deploy the example architecture in your AWS account, run the following command:</p> <pre>AWS_PROFILE=\$YOUR_ AWS_PROFILE npx projen deploy</pre>	AWS DevOps

## Test the architecture

Task	Description	Skills required
Install test prerequisites.	<p>Install on your workstation on the <a href="#">AWS Command Line</a></p>	DevOps engineer



Task	Description	Skills required
	<p><a href="#">Interface (AWS CLI)</a>, <a href="#">Postman</a>, and <a href="#">jq</a>.</p> <p>Using <a href="#">Postman</a> to test this example architecture is suggested but not mandatory . If you choose an alternative API testing tool, make sure that it supports <a href="#">AWS Signature Version 4 authentication</a>, and refer to the exposed API endpoints that can be inspected by <a href="#">exporting the REST API</a>.</p>	

Task	Description	Skills required
Assume the JobsAPIInvokeRole .	<p><a href="#">Assume</a> the JobsAPIInvokeRole that was printed as output from the deploy command:</p> <pre>CREDENTIALS=\$(AWS_PROFILE=\$&lt;YOUR_AWS_PROFILE&gt; aws sts assume-role \ --no-cli-pager \ --role-arn \$&lt;JOBS_API_INVOKE_ROLE_ARN&gt; \ --role-session-name JobsAPIInvoke) export AWS_ACCESS_KEY_ID=\$(cat \$CREDENTIALS   jq '.Credentials'.AccessKeyId) export AWS_SECRET_ACCESS_KEY=\$(cat \$CREDENTIALS   jq '.Credentials'.SecretAccessKey) export AWS_SESSION_TOKEN=\$(cat \$CREDENTIALS   jq '.Credentials'.SessionToken)</pre>	AWS DevOps

Task	Description	Skills required
Configure Postman.	<ul style="list-style-type: none"><li>• To import the Postman collection that's included in the repository, follow the instructions in the <a href="#">Postman documentation</a>.</li><li>• Set the JobsAPI <a href="#">variables</a> with the following values:<ul style="list-style-type: none"><li>• <code>accessKey</code> – The value of the <code>Credentials.AccessKeyId</code> attribute from the <code>assume-role</code> command.</li><li>• <code>baseUrl</code> – The value of the <code>JobsApiJobsAPIEndpoint</code> output from the <code>deploy</code> command, without the trailing slash.</li><li>• <code>region</code> – The value of the AWS Region where you deployed the example architecture.</li><li>• <code>seconds</code> – The value of the input parameter for the example job. It must be a positive integer.</li><li>• <code>secretKey</code> – The value of the <code>Credentials.SecretAccessKey</code> attribute from the <code>assume-role</code> command.</li></ul></li></ul>	AWS DevOps

Task	Description	Skills required
	<ul style="list-style-type: none"> <li>sessionToken               <ul style="list-style-type: none"> <li>The value of the Credentials.SessionToken attribute from the assume-role command.</li> </ul> </li> </ul>	
Test the example architecture.	To test the example architecture, send requests to the jobs API. For more information, see the <a href="#">Postman documentation</a> .	DevOps engineer

## Troubleshooting

Issue	Solution
Destruction and subsequent redeployment of the example architecture fails because the <a href="#">Amazon CloudWatch Logs log group /aws/apigateway/JobsAPIAccessLogs</a> already exists.	<ol style="list-style-type: none"> <li>If necessary, <a href="#">export your log data to Amazon Simple Storage Service (Amazon S3)</a>.</li> <li>Delete the CloudWatch Logs log group <code>/aws/apigateway/JobsAPIAccessLogs</code>.</li> <li>Redeploy the example architecture.</li> </ol>

## Related resources

- [API Gateway mapping template and access logging variable reference](#)
- [Change data capture for DynamoDB Streams](#)
- [Optimistic locking with version number](#)
- [Using Kinesis Data Streams to capture changes to DynamoDB](#)

# Process events asynchronously with Amazon API Gateway, Amazon SQS, and AWS Fargate

Created by *Andrea Meroni (AWS)*, *Alessandro Trisolini (AWS)*, *Nadim Majed (AWS)*, *Mariem Kthiri (AWS)*, and *Michael Wallner (AWS)*

**Code repository:** [Asynchronous Event Processing with API Gateway and SQS](#)

**Environment:** PoC or pilot

**Technologies:** Serverless

**AWS services:** Amazon API Gateway; Amazon DynamoDB; AWS Fargate; Amazon SQS; AWS Lambda

## Summary

[Amazon API Gateway](#) is a fully managed service that developers can use to create, publish, maintain, monitor, and secure APIs at any scale. It handles the tasks involved in accepting and processing up to hundreds of thousands of concurrent API calls.

An important service quota of API Gateway is the integration timeout. The timeout is the maximum time in which a backend service must return a response before the REST API returns an error. The hard limit of 29 seconds is generally acceptable for synchronous workloads. However, that limit represents a challenge for those developers who want to use API Gateway with asynchronous workloads.

This pattern shows an example architecture to process events asynchronously using API Gateway, Amazon Simple Queue Service (Amazon SQS) and AWS Fargate. The architecture supports running processing jobs without duration restrictions, and it uses a basic REST API as the interface.

[Projen](#) is used to set up the local development environment and to deploy the example architecture to a target AWS account, in combination with the [AWS Cloud Development Kit \(AWS CDK\)](#), [Docker](#), and [Node.js](#). Projen automatically sets up a [Python](#) virtual environment with [pre-commit](#) and the tools that are used for code quality assurance, security scanning, and unit testing. For more information, see the [Tools](#) section.

## Prerequisites and limitations

### Prerequisites

- An active AWS account
- The following tools installed on your workstation:
  - [AWS Cloud Development Kit \(AWS CDK\) Toolkit](#) version 2.85.0 or later
  - [Docker](#) version 20.10.21 or later
  - [Node.js](#) version 18 or later
  - [Projen](#) version 0.71.111 or later
  - [Python](#) version 3.9.16 or later

### Limitations

- Concurrent jobs are limited to 500 tasks per minute, which is the maximum number of tasks that Fargate can provision.

## Architecture

The following diagram shows the interaction of the jobs API with the jobs Amazon DynamoDB table, the event-processing Fargate service, and the error-handling AWS Lambda function. Events are stored in an Amazon EventBridge event archive.

A typical workflow includes the following steps:

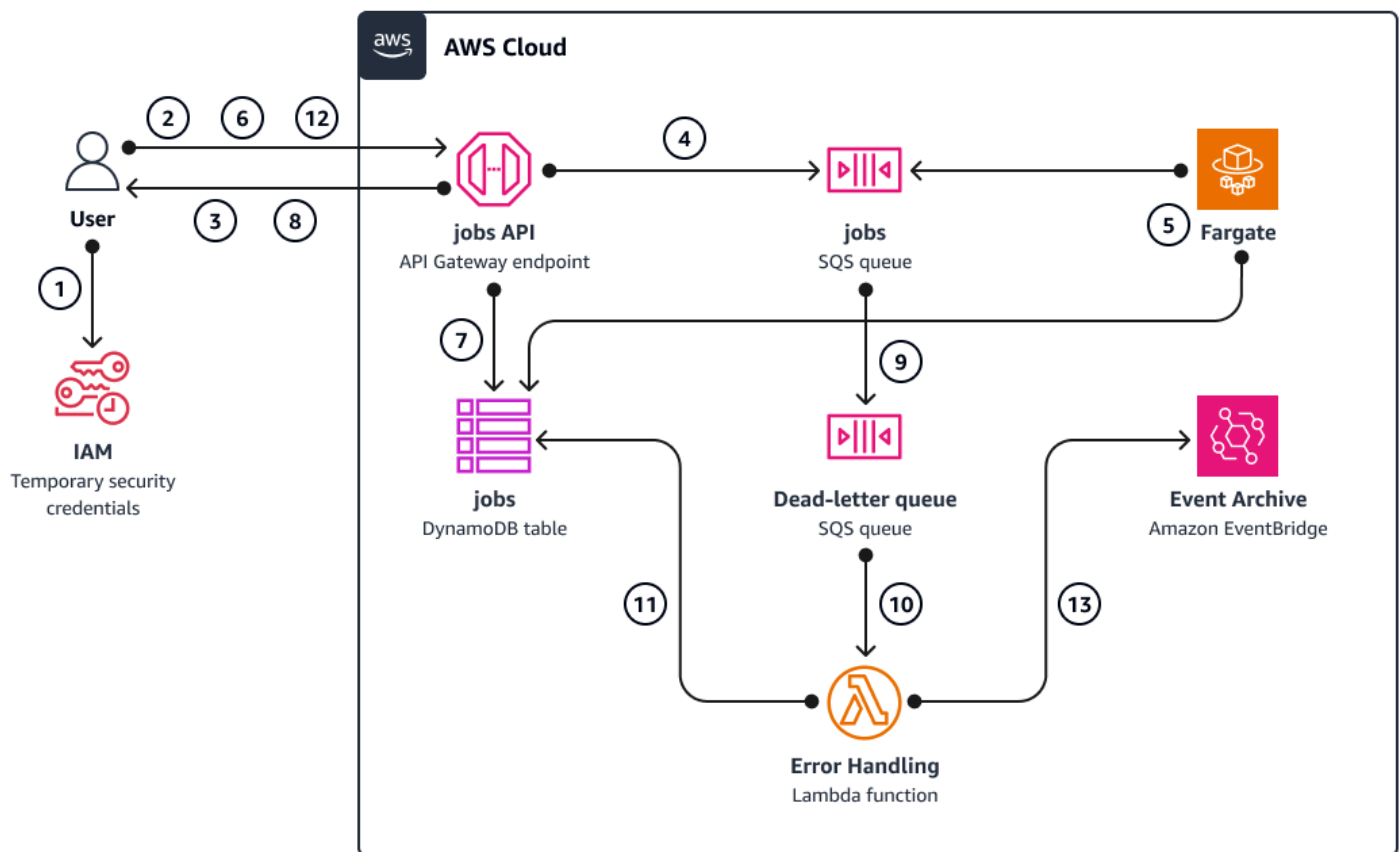

1. You authenticate against AWS Identity and Access Management (IAM) and obtain security credentials.
2. You send an HTTP POST request to the /jobs jobs API endpoint, specifying the job parameters in the request body.
3. The jobs API, which is an API Gateway REST API, returns to you an HTTP response that contains the job identifier.
4. The jobs API sends a message to the SQS queue.
5. Fargate pulls the message from the SQS queue, processes the event, and then puts the job results in the jobs DynamoDB table.
6. You send an HTTP GET request to the /jobs/{jobId} jobs API endpoint, with the job identifier from step 3 as {jobId}.
7. The jobs API queries the jobs DynamoDB table to retrieve the job results.
8. The jobs API returns an HTTP response that contains the job results.
9. If the event processing fails, the SQS queue sends the event to the dead-letter queue (DLQ).
10. An EventBridge event initiates the error-handling function.

11. The error-handling function puts the job parameters in the jobs DynamoDB table.
12. You can retrieve the job parameters by sending an HTTP GET request to the `/jobs/{jobId}` jobs API endpoint.
13. If the error handling fails, the error-handling function sends the event to an EventBridge archive.

You can replay the archived events by using EventBridge.

## Tools

### AWS services

- [AWS Cloud Development Kit \(AWS CDK\)](#) is a software development framework that helps you define and provision AWS Cloud infrastructure in code.
- [Amazon DynamoDB](#) is a fully managed NoSQL database service that provides fast, predictable, and scalable performance.
- [AWS Fargate](#) helps you run containers without needing to manage servers or Amazon Elastic Compute Cloud (Amazon EC2) instances. It's used in conjunction with Amazon Elastic Container Service (Amazon ECS).
- [Amazon EventBridge](#) is a serverless event bus service that helps you connect your applications with real-time data from a variety of sources. For example, Lambda functions, HTTP invocation endpoints using API destinations, or event buses in other AWS accounts.
- [AWS Lambda](#) is a compute service that helps you run code without needing to provision or manage servers. It runs your code only when needed and scales automatically, so you pay only for the compute time that you use.
- [Amazon Simple Queue Service \(Amazon SQS\)](#) provides a secure, durable, and available hosted queue that helps you integrate and decouple distributed software systems and components.

### Other tools

- [autopep8](#) automatically formats Python code based on the Python Enhancement Proposal (PEP) 8 style guide.
- [Bandit](#) scans Python code to find common security issues.
- [Commitizen](#) is a Git commit checker and CHANGELOG generator.
- [cfn-lint](#) is an AWS CloudFormation linter



- [Checkov](#) is a static code-analysis tool that checks infrastructure as code (IaC) for security and compliance misconfigurations.
- [jq](#) is a command-line tool for parsing JSON.
- [Postman](#) is an API platform.
- [pre-commit](#) is a Git hooks manager.
- [Projen](#) is a project generator.
- [pytest](#) is a Python framework for writing small, readable tests.

## Code repository

This example architecture code can be found in the GitHub [Asynchronous Processing with API Gateway and SQS](#) repository.

## Best practices

- This example architecture doesn't include monitoring of the deployed infrastructure. If your use case requires monitoring, evaluate adding [CDK Monitoring Constructs](#) or another monitoring solution.
- This example architecture uses [IAM permissions](#) to control the access to the jobs API. Anyone authorized to assume the `JobsAPIInvokeRole` will be able to invoke the jobs API. As such, the access control mechanism is binary. If your use case requires a more complex authorization model, evaluate using a different [access control mechanism](#).
- When a user sends an HTTP POST request to the `/jobs` jobs API endpoint, the input data is validated at two different levels:
  - API Gateway is in charge of the first [request validation](#).
  - The event processing function performs the second request.

No validation is performed when the user does an HTTP GET request to the `/jobs/{jobId}` jobs API endpoint. If your use case requires additional input validation and an increased level of security, evaluate [using AWS WAF to protect your API](#).

# Epics

## Set up the environment

Task	Description	Skills required
Clone the repository.	<p>To clone the repository locally, run the following command:</p> <pre>git clone https://github.com/aws-samples/asynchronous-event-processing-api-gateway-sqs-cdk.git</pre>	DevOps engineer
Set up the project.	<p>Change the directory to the repository root, and set up the Python virtual environment and all the tools by using <a href="#">Projen</a>:</p> <pre>cd asynchronous-event-processing-api-gateway-api-gateway-sqs-cdk npm projen</pre>	DevOps engineer
Install pre-commit hooks.	<p>To install pre-commit hooks, do the following:</p> <ol style="list-style-type: none"><li>1. Activate the <a href="#">Python virtual environment</a>:</li></ol> <pre>source .env/bin/activate</pre> <ol style="list-style-type: none"><li>2. Install the <a href="#">pre-commit hooks</a>:</li></ol>	DevOps engineer

Task	Description	Skills required
	<pre>pre-commit install pre-commit install -- hook-type commit-msg</pre>	

## Deploy the example architecture

Task	Description	Skills required
Bootstrap AWS CDK.	<p>To bootstrap <a href="#">AWS CDK</a> in your AWS account, run the following command:</p> <pre>AWS_PROFILE=\$YOUR_ AWS_PROFILE npx projen bootstrap</pre>	AWS DevOps
Deploy the example architecture.	<p>To deploy the example architecture in your AWS account, run the following command:</p> <pre>AWS_PROFILE=\$YOUR_ AWS_PROFILE npx projen deploy</pre>	AWS DevOps

## Test the architecture

Task	Description	Skills required
Install test prerequisites.	<p>Install on your workstation on the <a href="#">AWS Command Line Interface (AWS CLI)</a>, <a href="#">Postman</a>, and <a href="#">jq</a>.</p>	DevOps engineer

Task	Description	Skills required
	<p>Using <a href="#">Postman</a> to test this example architecture is suggested but not mandatory . If you choose an alternative API testing tool, make sure that it supports <a href="#">AWS Signature Version 4 authentication</a>, and refer to the exposed API endpoints that can be inspected by <a href="#">exporting the REST API</a>.</p>	

Task	Description	Skills required
Assume the JobsAPIInvokeRole .	<p><a href="#">Assume</a> the JobsAPIInvokeRole that was printed as output from the deploy command:</p> <pre>CREDENTIALS=\$(AWS_PROFILE=\$&lt;YOUR_AWS_PROFILE&gt; aws sts assume-role \ --no-cli-pager \ --role-arn \$&lt;JOBS_API_INVOKE_ROLE_ARN&gt; \ --role-session-name JobsAPIInvoke) export AWS_ACCESS_KEY_ID=\$(cat \$CREDENTIALS   jq '.Credentials'.AccessKeyId) export AWS_SECRET_ACCESS_KEY=\$(cat \$CREDENTIALS   jq '.Credentials'.SecretAccessKey) export AWS_SESSION_TOKEN=\$(cat \$CREDENTIALS   jq '.Credentials'.SessionToken)</pre>	AWS DevOps

Task	Description	Skills required
Configure Postman.	<ul style="list-style-type: none"><li>• To import the Postman collection that's included in the repository, follow the instructions in the <a href="#">Postman documentation</a>.</li><li>• Set the JobsAPI <a href="#">variables</a> with the following values:<ul style="list-style-type: none"><li>• <code>accessKey</code> – The value of the <code>Credentials.AccessKeyId</code> attribute from the <code>assume-role</code> command.</li><li>• <code>baseUrl</code> – The value of the <code>JobsApiJobsAPIEndpoint</code> output from the <code>deploy</code> command, without the trailing slash.</li><li>• <code>region</code> – The value of the AWS Region where you deployed the example architecture.</li><li>• <code>seconds</code> – The value of the input parameter for the example job. It must be a positive integer.</li><li>• <code>secretKey</code> – The value of the <code>Credentials.SecretAccessKey</code> attribute from the <code>assume-role</code> command.</li></ul></li></ul>	AWS DevOps

Task	Description	Skills required
	<ul style="list-style-type: none"> <li>sessionToken           <ul style="list-style-type: none"> <li>The value of the Credentials.SessionToken attribute from the assume-role command.</li> </ul> </li> </ul>	
Test the example architecture.	To test the example architecture, send requests to the jobs API. For more information, see the <a href="#">Postman documentation</a> .	DevOps engineer

## Troubleshooting

Issue	Solution
Destruction and subsequent redeployment of the example architecture fails because the <a href="#">Amazon CloudWatch Logs log group</a> /aws/apigateway/JobsAPIAccessLogs already exists.	<ol style="list-style-type: none"> <li>If necessary, <a href="#">export your log data to Amazon Simple Storage Service (Amazon S3)</a>.</li> <li>Delete the CloudWatch Logs log group /aws/apigateway/JobsAPIAccessLogs .</li> <li>Redeploy the example architecture.</li> </ol>
Destruction and subsequent redeployment of the example architecture fails because the <a href="#">CloudWatch Logs log group</a> /aws/ecs/EventProcessingServiceLogs already exists.	<ol style="list-style-type: none"> <li>If necessary, <a href="#">export your log data to Amazon S3</a>.</li> <li>Delete the CloudWatch Logs log group /aws/ecs/EventProcessingServiceLogs .</li> <li>Redeploy the example architecture.</li> </ol>

## Related resources

- [API Gateway mapping template and access logging variable reference](#)
- [How do I integrate an API Gateway REST API with Amazon SQS and resolve common errors?](#)



# Run AWS Systems Manager Automation tasks synchronously from AWS Step Functions

Created by Elie El khoury (AWS)

**Code repository:** [amazon-stepfunctions-ssm-waitfortask-token](#)

**Environment:** Production

**Technologies:** Serverless; DevOps; End-user computing; Operations

**AWS services:** AWS Step Functions; AWS Systems Manager

## Summary

This pattern explains how to integrate AWS Step Functions with AWS Systems Manager. It uses AWS SDK service integrations to call the Systems Manager **startAutomationExecution** API with a task token from a state machine workflow, and pauses until the token returns with a success or failure call. To demonstrate the integration, this pattern implements an Automation document (runbook) wrapper around the `AWS-RunShellScript` or `AWS-RunPowerShellScript` document, and uses `.waitForTaskToken` to synchronously call `AWS-RunShellScript` or `AWS-RunPowerShellScript`. For more information about AWS SDK service integrations in Step Functions, see the [AWS Step Functions Developer Guide](#).

Step Functions is a low-code, visual workflow service that you can use to build distributed applications, automate IT and business processes, and build data and machine learning pipelines by using AWS services. Workflows manage failures, retries, parallelization, service integrations, and observability so you can focus on higher-value business logic.

Automation, a capability of AWS Systems Manager, simplifies common maintenance, deployment, and remediation tasks for AWS services such as Amazon Elastic Compute Cloud (Amazon EC2), Amazon Relational Database Service (Amazon RDS), Amazon Redshift, and Amazon Simple Storage Service (Amazon S3). Automation gives you granular control over the concurrency of your automations. For example, you can specify how many resources to target concurrently, and how many errors can occur before an automation is stopped.

For implementation details, including runbook steps, parameters, and examples, see the [Additional information](#) section.

## Prerequisites and limitations

### Prerequisites

- An active AWS account
- AWS Identity and Access Management (IAM) permissions to access Step Functions and Systems Manager
- An EC2 instance with Systems Manager Agent (SSM Agent) [installed](#) on the instance
- [An IAM instance profile for Systems Manager](#) attached to the instance where you plan to run the runbook
- A Step Functions role that has the following IAM permissions (which follow the principle of least privilege):

```
{
    "Effect": "Allow",
    "Action": "ssm:StartAutomationExecution",
    "Resource": "*"
}
```

### Product versions

- SSM document schema version 0.3 or later
- SSM Agent version 2.3.672.0 or later

## Architecture

### Target technology stack

- AWS Step Functions
- AWS Systems Manager Automation

### Target architecture

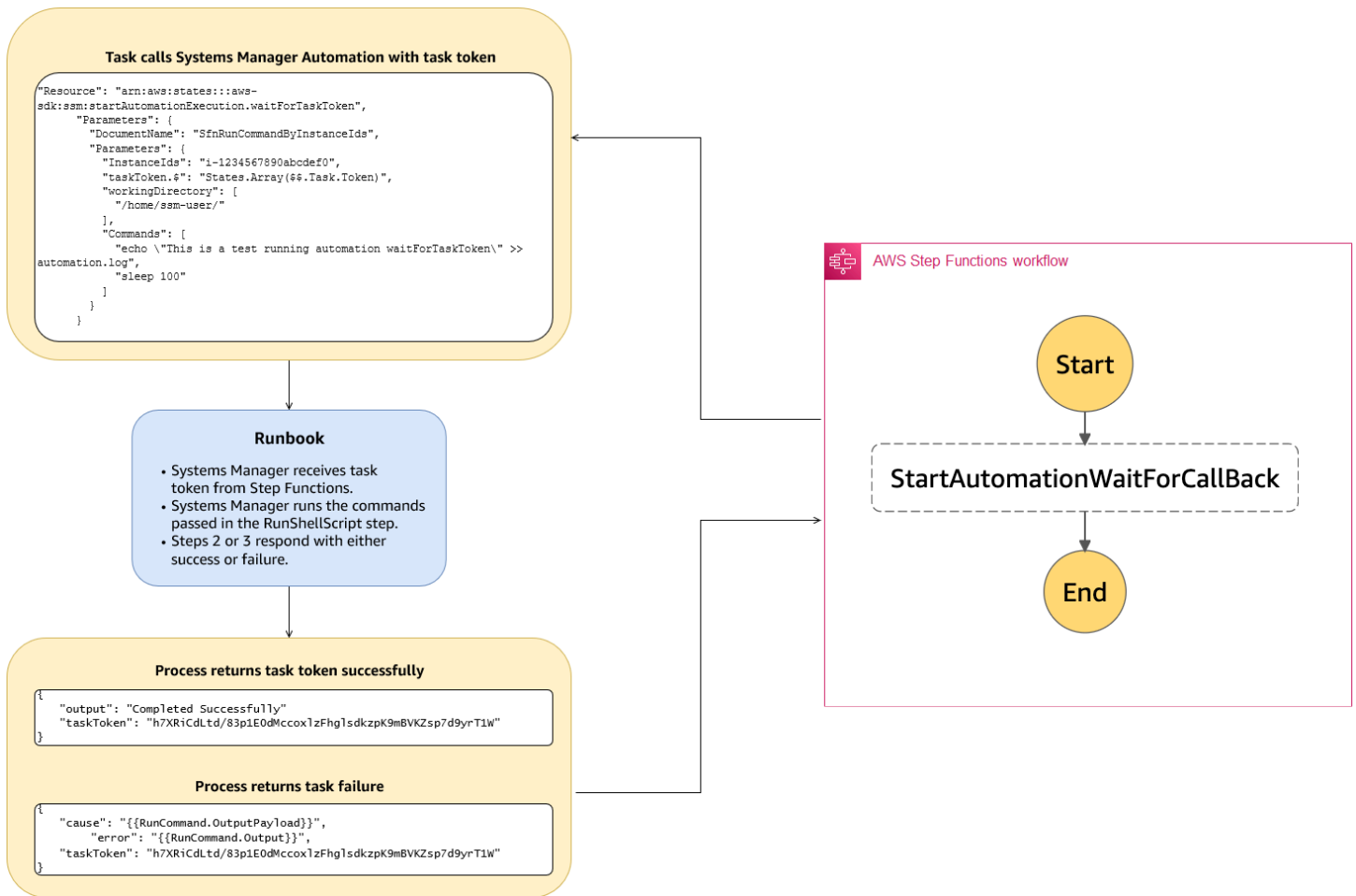

## Automation and scale

- This pattern provides an AWS CloudFormation template that you can use to deploy the runbooks on multiple instances. (See the GitHub [Step Functions and Systems Manager implementation repository](#).)

## Tools

### AWS services

- [AWS CloudFormation](#) helps you set up AWS resources, provision them quickly and consistently, and manage them throughout their lifecycle across AWS accounts and Regions.
- [AWS Identity and Access Management \(IAM\)](#) helps you securely manage access to your AWS resources by controlling who is authenticated and authorized to use them.
- [AWS Step Functions](#) is a serverless orchestration service that helps you combine AWS Lambda functions and other AWS services to build business-critical applications.

- [AWS Systems Manager](#) helps you manage your applications and infrastructure running in the AWS Cloud. It simplifies application and resource management, shortens the time to detect and resolve operational problems, and helps you manage your AWS resources securely at scale.

## Code

The code for this pattern is available in the GitHub [Step Functions and Systems Manager implementation](#) repository.

## Epics

### Create runbooks

Task	Description	Skills required
Download the CloudFormation template.	Download the <code>ssm-automation-documents.cf</code> template from the <code>cloudformation</code> folder of the GitHub repository.	AWS DevOps
Create runbooks.	<p>Sign in to the AWS Management Console, open the <a href="#">AWS CloudFormation console</a>, and deploy the template. For more information about deploying CloudFormation templates, see <a href="#">Creating a stack on the AWS CloudFormation console</a> in the CloudFormation documentation.</p> <p>The CloudFormation template deploys three resources:</p> <ul style="list-style-type: none"> <li>• <code>SfnRunCommandByInstanceIds</code> – Runbook that</li> </ul>	AWS DevOps

Task	Description	Skills required
	<p>lets you run <code>AWS-RunShellScript</code> or <code>AWS-RunPowerShellScript</code> by using instance IDs.</p> <ul style="list-style-type: none"> <li><code>SfnRunCommandByTargets</code> – Runbook that lets you run <code>AWS-RunShellScript</code> or <code>AWS-RunPowerShellScript</code> by using targets.</li> <li><code>SSMSyncRole</code> – The IAM role assumed by the runbooks.</li> </ul>	

## Create a sample state machine

Task	Description	Skills required
Create a test state machine.	<p>Follow the instructions in the <a href="#">AWS Step Functions Developer Guide</a> to create and run a state machine. For the definition, use the following code. Make sure to update the <code>InstanceIds</code> value with the ID of a valid Systems Manager-enabled instance in your account.</p> <pre>{   "Comment": "A description of my state machine",</pre>	AWS DevOps

Task	Description	Skills required
	<pre>       "StartAt": "StartAutomationWaitForCallback",       "States": {         "StartAutomationWaitForCallback": {           "Type": "Task",           "Resource":             "arn:aws:states:::aws-sdk:ssm:startAutomationExecution.waitForTaskToken",           "Parameters": {             "DocumentName":               "SfnRunCommandByInstanceIds",             "Parameters": {               "InstanceIds": [                 "i-1234567890abcdef0",                 "taskToken.\$": "States.Array(\$.Task.Token)",                 "workingDirectory": [                   "/home/ssm-user/"                 ],                 "Commands": [                   "echo \"This is a test running automation waitForTaskToken\" &gt;&gt; automation.log",                   "sleep 100"                 ],                 "executionTimeout": [                   "10800"                 ], </pre>	

Task	Description	Skills required
	<pre data-bbox="592 205 1031 745">        "delivery Timeout": [             "30"         ],         "shell": [             "Shell"         ]     } }, "End": true } }</pre> <p data-bbox="592 777 1031 1008">This code calls the runbook to run two commands that demonstrate the <code>waitForTaskToken</code> call to Systems Manager Automation.</p> <p data-bbox="592 1050 1031 1375">The <code>shell</code> parameter value (<code>Shell</code> or <code>PowerShell</code>) determines whether the Automation document runs <code>AWS-RunShellScript</code> or <code>AWS-RunPowerShellScript</code>.</p> <p data-bbox="592 1417 1031 1833">The task writes "This is a test running automation <code>waitForTaskToken</code>" into the <code>/home/ssm-user/automation.log</code> file, and then sleeps for 100 seconds before it responds with the task token and releases the next task in the workflow.</p>	

Task	Description	Skills required
	<p>If you want to call the <code>SfnRunCommandByTargets</code> instead, replace the <code>Parameters</code> section of the previous code with the following:</p> <pre data-bbox="594 520 1029 1163">"Parameters": {   "Targets": [     {       "Key":         "InstanceIds",       "Values":         [           "i-02573cafcfEXAMPLE",           "i-0471e04240EXAMPLE"         ]     }   ],</pre>	



Task	Description	Skills required
Update the IAM role for the state machine.	<p>The previous step automatically creates a dedicated IAM role for the state machine. However, it doesn't grant permissions to call the runbook. Update the role by adding the following permissions:</p> <pre data-bbox="597 632 1027 951">{   "Effect": "Allow",   "Action":     "ssm:StartAutomationExecution",   "Resource": "*" }</pre>	AWS DevOps
Validate the synchronous calls.	<p>Run the state machine to validate the synchronous call between Step Functions and Systems Manager Automation.</p> <p>For sample output, see the <a href="#">Additional information</a> section.</p>	AWS DevOps

## Related resources

- [Getting started with AWS Step Functions](#) (*AWS Step Functions Developer Guide*)
- [Wait for a callback with the task token](#) (*AWS Step Functions Developer Guide*, service integration patterns)
- [send\\_task\\_success](#) and [send\\_task\\_failure](#) API calls (*Boto3 documentation*)
- [AWS Systems Manager Automation](#) (*AWS Systems Manager User Guide*)

## Additional information

### Implementation details

This pattern provides a CloudFormation template that deploys two Systems Manager runbooks:

- `SfnRunCommandByInstanceIds` runs the `AWS-RunShellScript` or `AWS-RunPowerShellScript` command by using instance IDs.
- `SfnRunCommandByTargets` runs the `AWS-RunShellScript` or `AWS-RunPowerShellScript` command by using targets.

Each runbook implements four steps to achieve a synchronous call when using the `.waitForTaskToken` option in Step Functions.

Step	Action	Description
1	Branch	Checks the <code>shell</code> parameter value ( <code>Shell</code> or <code>PowerShell</code> ) to decide whether to run <code>AWS-RunShellScript</code> for Linux or <code>AWS-RunPowerShellScript</code> for Windows.
2	<code>RunCommand_Shell</code> or <code>RunCommand_PowerShell</code>	Takes several inputs and runs the <code>RunShellScript</code> or <code>RunPowerShellScript</code> command. For more information, check the <b>Details</b> tab for the <code>RunCommand_Shell</code> or <code>RunCommand_PowerShell</code> Automation document on the Systems Manager console.
3	<code>SendTaskFailure</code>	Runs when step 2 is aborted or canceled. It calls the Step Functions <a href="#">send_task_failure</a>

API, which accepts three parameters as input: the token passed by the state machine, the failure error, and a description of the cause of the failure.

<b>4</b>	SendTaskSuccess	Runs when step 2 is successful. It calls the Step Functions <a href="#">send_task_success</a> API, which accepts the token passed by the state machine as input.
----------	-----------------	--

## Runbook parameters

SfnRunCommandByInstanceIds runbook:

Parameter name	Type	Optional or required	Description
shell	String	Required	The instances shell to decide whether to run AWS-RunShellScript for Linux or AWS-RunPowerShellScript for Windows.
deliveryTimeout	Integer	Optional	The time, in seconds, to wait for a command to deliver to the SSM Agent on an instance. This parameter has a minimum value of 30 (0.5 minute) and a maximum value of 2592000 (720 hours).

<code>executionTimeout</code>	String	Optional	The time, in seconds, for a command to complete before it is considered to have failed. The default value is 3600 (1 hour). The maximum value is 172800 (48 hours).
<code>workingDirectory</code>	String	Optional	The path to the working directory on your instance.
<code>Commands</code>	StringList	Required	The shell script or command to run.
<code>InstanceIds</code>	StringList	Required	The IDs of the instances where you want to run the command.
<code>taskToken</code>	String	Required	The task token to use for callback responses.

#### SfnRunCommandByTargets runbook:

<b>Name</b>	<b>Type</b>	<b>Optional or required</b>	<b>Description</b>
<code>shell</code>	String	Required	The instances shell to decide whether to run <code>AWS-RunShellScript</code> for Linux or <code>AWS-RunPowerShellScript</code> for Windows.

<code>deliveryTimeout</code>	Integer	Optional	The time, in seconds, to wait for a command to deliver to the SSM Agent on an instance. This parameter has a minimum value of 30 (0.5 minute) and a maximum value of 2592000 (720 hours).
<code>executionTimeout</code>	Integer	Optional	The time, in seconds, for a command to complete before it is considered to have failed. The default value is 3600 (1 hour). The maximum value is 172800 (48 hours).
<code>workingDirectory</code>	String	Optional	The path to the working directory on your instance.
<code>Commands</code>	StringList	Required	The shell script or command to run.

Targets	MapList	Required	An array of search criteria that identifies instances by using key-value pairs that you specify. For example: [{"Key": "InstanceIDs", "Values": ["i-02573cafcfEXAMPLE", "i-0471e04240EXAMPLE"]}]]
taskToken	String	Required	The task token to use for callback responses.

## Sample output

The following table provides sample output from the step function. It shows that the total run time is over 100 seconds between step 5 (TaskSubmitted) and step 6 (TaskSucceeded). This demonstrates that the step function waited for the `sleep 100` command to finish before moving to the next task in the workflow.

ID	Type	Step	Resource	Elapsed Time (ms)	Timestamp
1	Execution Started		-	0	Mar 11, 2022 02:50:34.303 PM
2	TaskState Entered	StartAutomationWaitForCallback	-	40	Mar 11, 2022 02:50:34.343 PM

---

<b>3</b>	TaskScheduled	StartAutomationWaitForCallBack	-	40	Mar 11, 2022 02:50:34.343 PM
<b>4</b>	TaskStarted	StartAutomationWaitForCallBack	-	154	Mar 11, 2022 02:50:34.457 PM
<b>5</b>	TaskSubmitted	StartAutomationWaitForCallBack	-	657	Mar 11, 2022 02:50:34.960 PM
<b>6</b>	TaskSucceeded	StartAutomationWaitForCallBack	-	103835	Mar 11, 2022 02:52:18.138 PM
<b>7</b>	TaskStateExited	StartAutomationWaitForCallBack	-	103860	Mar 11, 2022 02:52:18.163 PM
<b>8</b>	ExecutionSucceeded		-	103897	Mar 11, 2022 02:52:18.200 PM

# Run parallel reads of S3 objects by using Python in an AWS Lambda function

Created by Eduardo Bortoluzzi

**Code repository:** [aws-lambda-a-parallel-download](#)

**Environment:** PoC or pilot

**Technologies:** Serverless

**AWS services:** AWS Lambda; Amazon S3; AWS Step Functions

## Summary

You can use this pattern to retrieve and summarize a list of documents from Amazon Simple Storage Service (Amazon S3) buckets in real time. The pattern provides example code to parallel read objects from S3 buckets on Amazon Web Services (AWS). The pattern showcases how to efficiently run I/O bound tasks with AWS Lambda functions using Python.

A financial company used this pattern in an interactive solution to manually approve or reject correlated financial transactions in real time. The financial transaction documents were stored in an S3 bucket related to the market. An operator selected a list of documents from the S3 bucket, analyzed the total value of the transactions that the solution calculated, and decided to approve or reject the selected batch.

I/O bound tasks support multiple threads. In this example code, the [concurrent.futures.ThreadPoolExecutor](#) is used with a maximum of 1,000 simultaneous threads. Lambda functions support up to 1,024 threads, and one of those threads is your main process. You also need to increase the maximum pool connections in `botocore` so that all threads can perform the S3 object download simultaneously.

The example code uses one 8.3 KB object, with JSON data, in an S3 bucket. The object is read multiple times. After the Lambda function reads the object, the JSON data is decoded to a Python object. The result after running this example was 1,000 reads processed in 2.3 seconds and 10,000 reads processed in 26 seconds using a Lambda function configured with 2,048 MB of memory. Increasing the Lambda memory didn't help to decrease the time to run the task.



The [AWS Lambda Power Tuning](#) tool was used to test different Lambda memory configurations and verify the best performance-to-cost ratio for the task. For test results, see the Additional information section.

## Prerequisites and limitations

### Prerequisites

- An active AWS account
- Proficiency with Python development

### Limitations

- A Lambda function can have at most [1,024 execution processes or threads](#).
- New AWS accounts have a Lambda memory limit of 3,008 MB. Adjust the AWS Lambda Power Tuning tool accordingly. For more information, see the [Troubleshooting](#) section.
- Python version 3.8 is the minimum recommended version because it introduced [thread reuse from the thread execution pool](#).
- Amazon S3 has a limit of [5,500 GET/HEAD requests per second per partitioned prefix](#).

### Product versions

- Python 3.8 or later
- AWS Cloud Development Kit (AWS CDK) v2
- AWS Command Line Interface (AWS CLI) version 2
- AWS Lambda Power Tuning 4.3.3 (optional)

## Architecture

### Target technology stack

- AWS Lambda
- Amazon S3
- AWS Step Functions (if AWS Lambda Power Tuning is deployed)

## Target architecture

The following diagram shows a Lambda function that reads objects from an S3 bucket in parallel. The diagram also has a Step Functions workflow for the AWS Lambda Power Tuning tool to fine-tune the Lambda function memory. This fine-tuning helps to achieve a good balance between cost and performance.

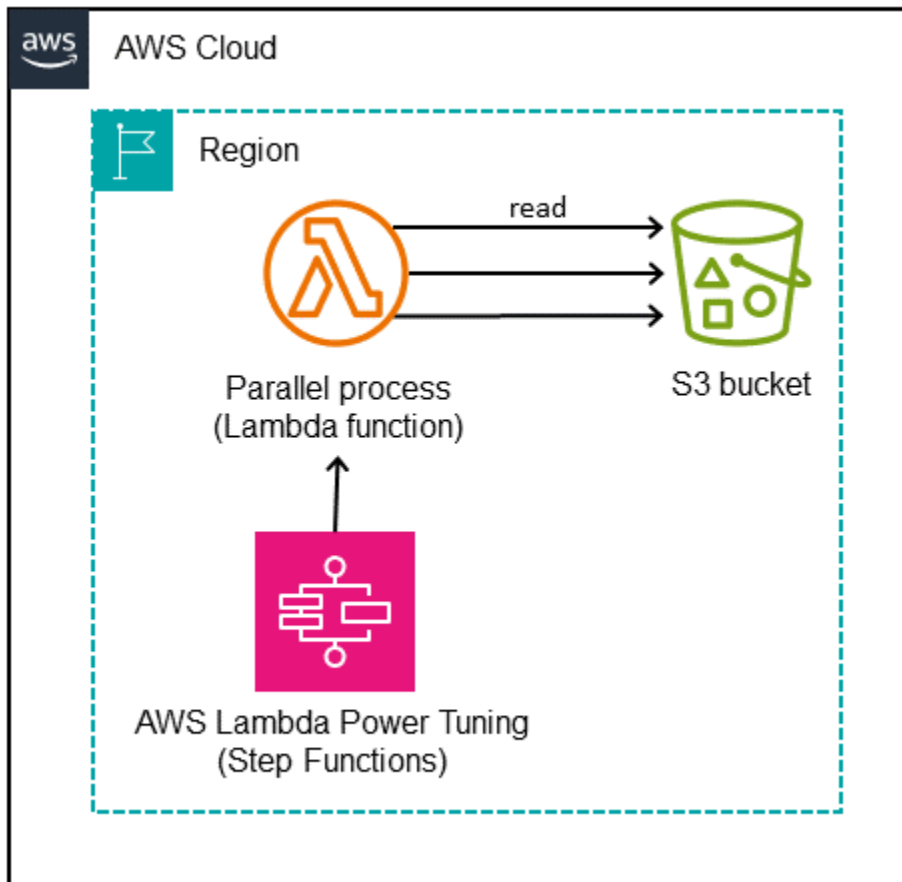

## Automation and scale

The Lambda functions scale fast when required. To avoid 503 Slow Down errors from Amazon S3 during high demand, we recommend putting some limits on the scaling.

## Tools

### AWS services

- [AWS Cloud Development Kit \(AWS CDK\) v2](#) is a software development framework that helps you define and provision AWS Cloud infrastructure in code. The example infrastructure was created to be deployed with AWS CDK.

- [AWS Command Line Interface \(AWS CLI\)](#) is an open source tool that helps you interact with AWS services through commands in your command-line shell. In this pattern, AWS CLI version 2 is used to upload an example JSON file.
- [AWS Lambda](#) is a compute service that helps you run code without needing to provision or manage servers. It runs your code only when needed and scales automatically, so you pay only for the compute time that you use.
- [Amazon Simple Storage Service \(Amazon S3\)](#) is a cloud-based object storage service that helps you store, protect, and retrieve any amount of data.
- [AWS Step Functions](#) is a serverless orchestration service that helps you combine AWS Lambda functions and other AWS services to build business-critical applications.

### Other tools

- [Python](#) is a general-purpose computer programming language. The reuse of idle worker threads was introduced in Python version 3.8, and the Lambda function code in this pattern was created for this version.

### Code repository

The code for this pattern is available in the [aws-lambda-parallel-download](#) GitHub repository.

### Best practices

- This AWS CDK construct relies on your AWS account's user permissions to deploy the infrastructure. If you plan to use AWS CDK Pipelines or cross-account deployments, see [Stack synthesizers](#).
- This example application doesn't have the access logs enabled at the S3 bucket. It's a best practice to enable access logs in production code.

# Epics

## Prepare the development environment

Task	Description	Skills required
Check the Python installed version.	<p>The provided code was created and tested on Python 3.8 and later. To verify your installed Python version, run <code>python3 -V</code>. If needed, <a href="#">download</a> and install a newer version.</p> <p>To verify that the required modules are installed, run <code>python3 -c "import pip, venv"</code>. If the modules are installed, no error will be returned.</p>	Cloud architect
Install and configure AWS CDK.	<p>To install the AWS CDK and bootstrap it if it isn't already configured, follow the instructions at <a href="#">Getting started with the AWS CDK</a>. To confirm that the installed AWS CDK version is 2.0 or later, run <code>cdk -version</code>:</p> <p>When bootstrapping, pass the <code>--cloudformation-execution-policies "arn:aws:iam::aws:policy/job-function/ViewOnlyAccess"</code> parameter to <code>cdk bootstrap</code>. This example</p>	Cloud architect

Task	Description	Skills required
	doesn't use the defined role to deploy the stack, and this parameter makes your deployment more secure.	

## Clone the example repository

Task	Description	Skills required
Clone the repository.	To clone the latest version of the repository, run the following command: <pre>git clone --depth 1 --branch v1.1.2 \ git@github.com:aws-samples/aws-lambda-parallel-download.git</pre>	Cloud architect
Change the working directory to the cloned repository.	Run the following command: <pre>cd aws-lambda-parallel-download</pre>	Cloud architect
Create the Python virtual environment.	To create a Python virtual environment, run the following command: <pre>python3 -m venv .venv</pre>	Cloud architect
Activate the virtual environment.	To activate the virtual environment, run the following command:	Cloud architect

Task	Description	Skills required
	<pre>source .venv/bin/ activate</pre>	
Install the dependencies.	<p>To install the Python dependencies, run the pip command:</p> <pre>pip install -r requirements.txt</pre>	Cloud architect
Browse the code.	<p>(Optional) The example code that downloads an object from the S3 bucket is at <code>resources/parallel.py</code>.</p> <p>The infrastructure code is in the <code>parallel_download</code> folder.</p>	Cloud architect

## Deploy and test the app

Task	Description	Skills required
Deploy the app.	<p>Run <code>cdk deploy</code>.</p> <p>Write down the AWS CDK outputs:</p> <ul style="list-style-type: none"> <li>ParallelDownloadStack.LambdaFunction ARN</li> <li>ParallelDownloadStack.SampleS3Bucket Name</li> </ul>	Cloud architect

Task	Description	Skills required
	<ul style="list-style-type: none"><li>ParallelDownloadStack.StateMachineARN</li></ul>	
Upload an example JSON file.	<p>The repository contains an example JSON file of about 9 KB. To upload the file to the S3 bucket of the created stack, run the following command:</p> <pre>aws s3 cp sample.json s3://&lt;ParallelDownloadStack.SampleS3BucketName&gt;</pre> <p>Replace &lt;ParallelDownloadStack.SampleS3BucketName&gt; with the corresponding value from the AWS CDK output.</p>	Cloud architect

Task	Description	Skills required
Run the app.	<ol style="list-style-type: none"><li>1. Sign in to the AWS Management Console, navigate to the <a href="#">Lambda console</a>, and locate the Lambda function that has the ARN from the AWS CDK output <code>ParallelDownloadStack.LambdaFunctionARN</code> .</li><li>2. On the <b>Test</b> tab, change the <b>Event JSON</b> to the following: <pre>{"objectKey": "sample.json"}</pre></li><li>3. Choose <b>Test</b>.</li><li>4. To see the result, choose <b>details</b>. The details will show the statistics of the parallel download, the information of the run, and the logs.</li></ol>	Cloud architect
Add the number of downloads.	<p>(Optional) To run 1,500 get object calls, use the following JSON in <b>Event JSON</b> of the Test parameter:</p> <pre>{"repeat": 1500, "objectKey": "sample.json"}</pre>	Cloud architect



## Optional: Run AWS Lambda Power Tuning

Task	Description	Skills required
Run the AWS Lambda Power Tuning tool.	<ol style="list-style-type: none"><li data-bbox="591 331 1027 464">1. Sign in to the console, and navigate to <a href="#">Step Functions</a>.</li><li data-bbox="591 485 1027 758">2. Locate the State machine with the ARN from the AWS CDK output <code>ParallelDownloadStack.StateMachineARN</code>.</li><li data-bbox="591 779 1027 911">3. Choose <b>Start execution</b>, and paste the following JSON:<pre data-bbox="630 947 1027 1423">{   "lambdaARN":   "&lt;ParallelDownloadStack.LambdaFunctionARN&gt;",   "num": 5,   "payload":   {"repeat": 2000,   "objectKey":   "sample.json"} }</pre></li></ol> <p data-bbox="630 1465 1027 1696">Remember to replace <code>&lt;ParallelDownloadStack.LambdaFunctionARN&gt;</code> with the value from the CDK output.</p> <p data-bbox="591 1766 1027 1852">At the end of the run, the result will be on the</p>	Cloud architect

Task	Description	Skills required
	<b>Execution input &amp; output</b> tab.	
View the AWS Lambda Power Tuning results in a graph.	On the <b>Execution input and output</b> tab, copy the <b>visualization</b> property link, and paste it in a new browser tab.	Cloud architect

## Clean up

Task	Description	Skills required
Remove the objects from the S3 bucket.	<p>Before you destroy the deployed resources, you remove all the objects from the S3 bucket:</p> <pre>aws s3 rm s3://&lt;ParallelDownloadStack .SampleS3BucketName&gt; \ --recursive</pre> <p>Remember to replace <code>&lt;ParallelDownloadStack.SampleS3BucketName&gt;</code> with the value from the AWS CDK outputs.</p>	Cloud architect
Destroy the resources.	To destroy all the resources that were created for this pilot, run the following command:	Cloud architect

Task	Description	Skills required
	<code>cdk destroy</code>	

## Troubleshooting

Issue	Solution
'MemorySize' value failed to satisfy constraint: Member must have value less than or equal to 3008	<p>For new accounts, you might not be able to configure more than 3,008 MB in your Lambda functions. To test using AWS Lambda Power Tuning, add the following property at the input JSON when you are starting the Step Functions execution:</p> <pre>"powerValues": [   512,   1024,   1536,   2048,   2560,   3008 ]</pre>

## Related resources

- [Python – concurrent.futures.ThreadPoolExecutor](#)
- [Lambda quotas – Function configuration, deployment, and execution](#)
- [Working with the AWS CDK in Python](#)
- [Profiling functions with AWS Lambda Power Tuning](#)

## Additional information

### Code

The following code snippet performs the parallel I/O processing:

```
with ThreadPoolExecutor(max_workers=MAX_WORKERS) as executor:
    for result in executor.map(a_function, (the_arguments)):
        ...
```

The `ThreadPoolExecutor` reuses the threads when they become available.

## Testing and results

The first test processed 2,500 object reads, with the following result.

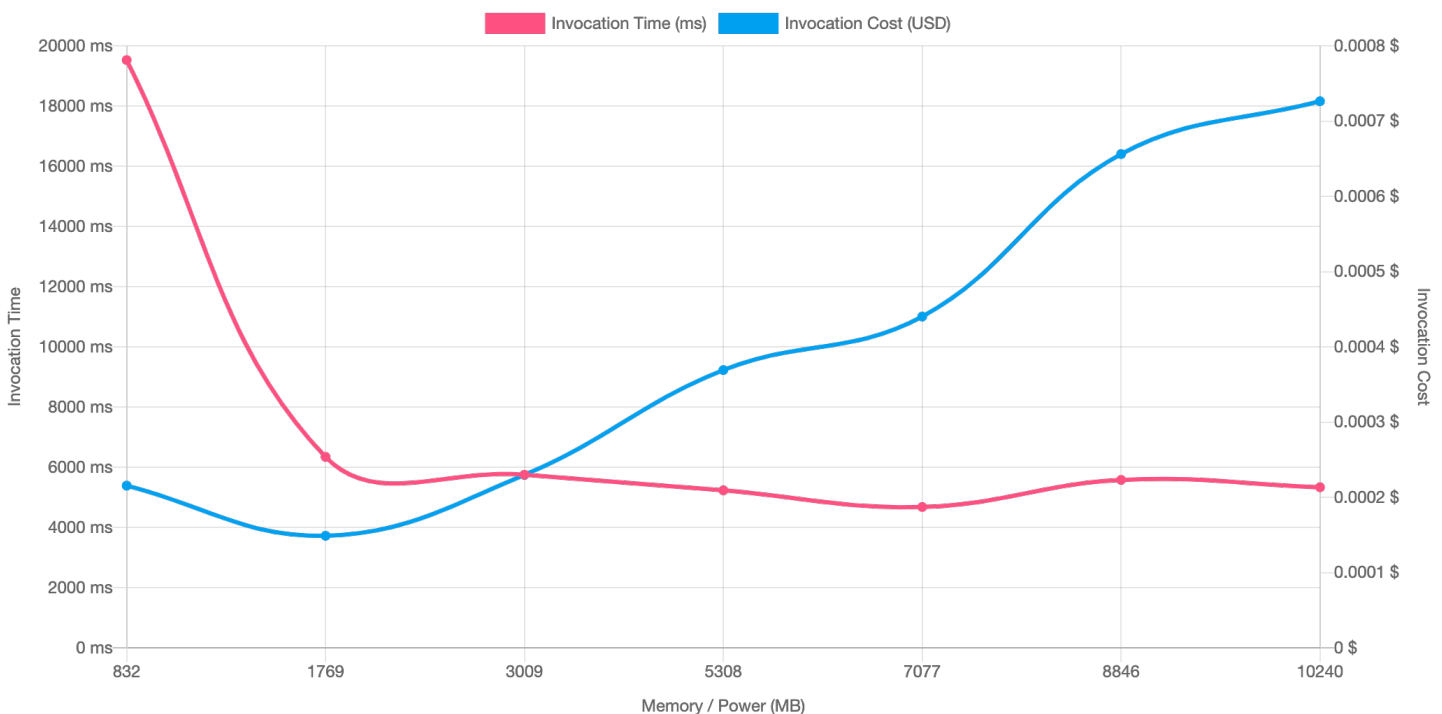

Starting at 3,009 MB, the processing-time level stayed the same for any memory increase, but the cost increased as the memory size increased.

Another test investigated the range between 1,536 MB and 3,072 MB of memory, using values that were multiples of 256 MB and processing 10,000 object reads, with the following results.

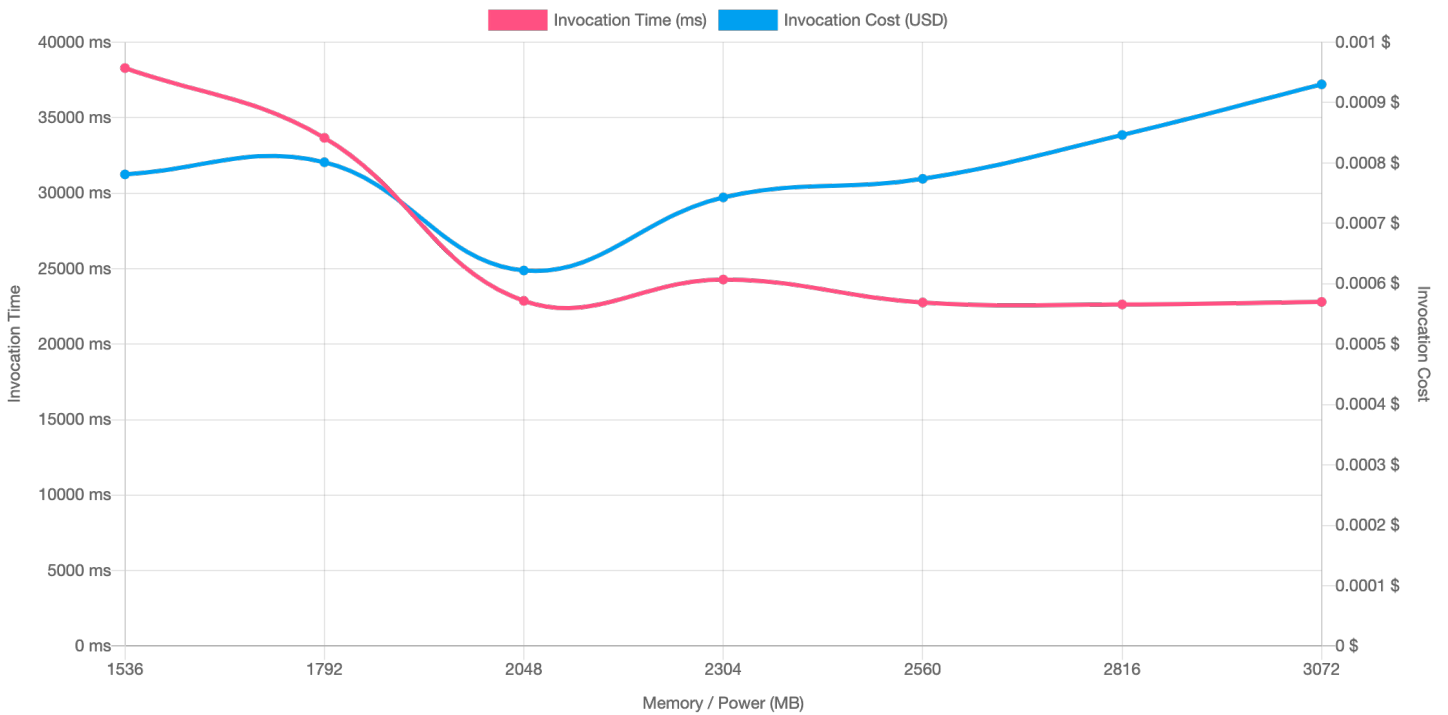

The best performance-to-cost ratio was with the 2,048 MB memory Lambda configuration.

For comparison, a sequential process of 2,500 object reads took 40 seconds. The parallel process using the 2,048 MB Lambda configuration took 5.8 seconds, which is 85 percent less.

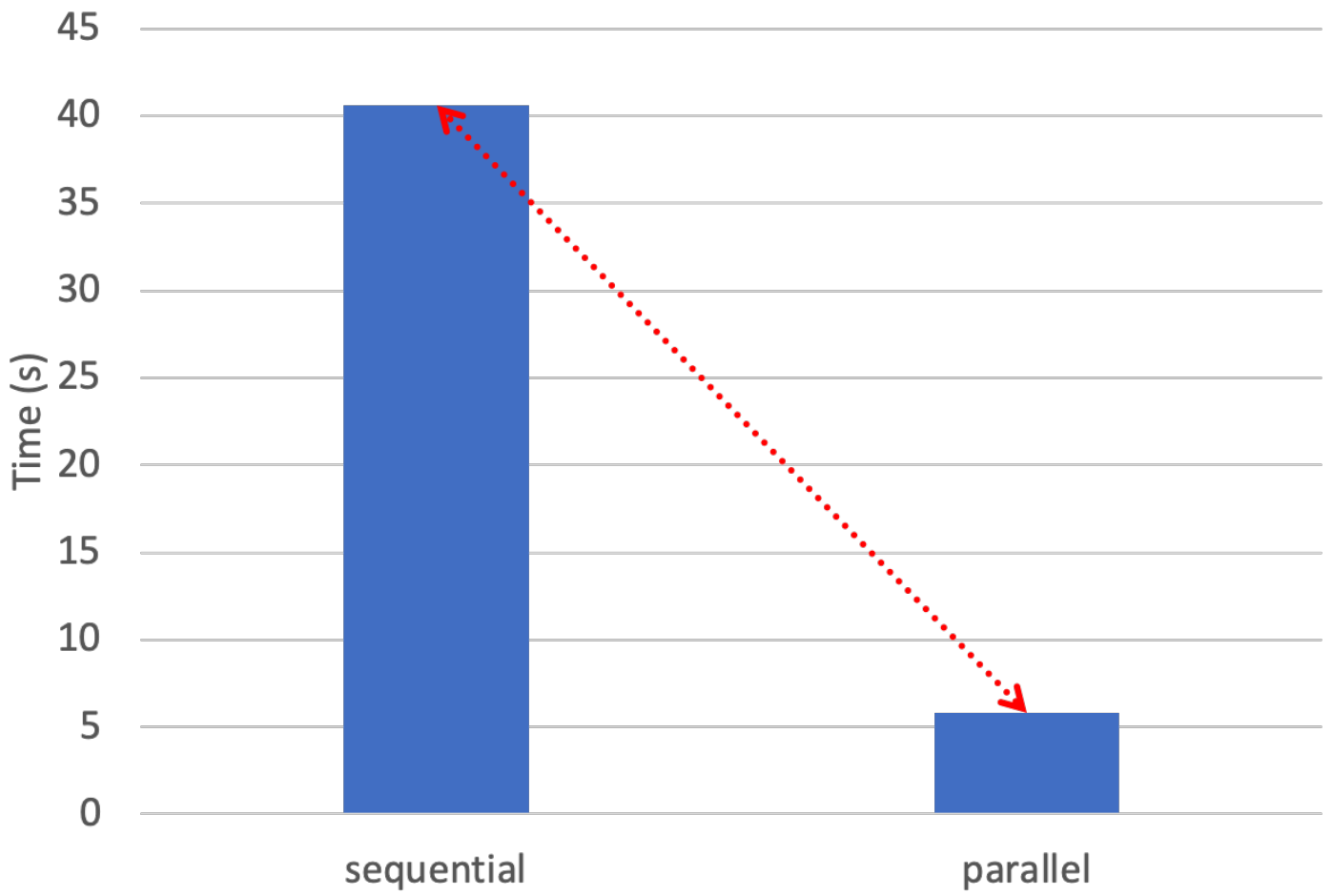

# Send telemetry data from AWS Lambda to OpenSearch for real-time analytics and visualization

Created by Tabby Ward (AWS), Guy Bachar (AWS), and David Kilzer (AWS)

**Environment:** PoC or pilot

**Technologies:** Serverless;  
CloudNative; Modernization

**AWS services:** AWS Lambda;  
Amazon OpenSearch Service

## Summary

Modern applications are becoming increasingly distributed and event-driven, which reinforces the need for real-time monitoring and observability. AWS Lambda is a serverless computing service that plays a crucial role in building scalable and event-driven architectures. However, monitoring and troubleshooting Lambda functions can be challenging if you rely solely on Amazon CloudWatch Logs, which can introduce latency and limited retention periods.

To address this challenge, AWS introduced the Lambda Telemetry API, which enables Lambda functions to send telemetry data directly to third-party monitoring and observability tools. This API supports real-time streaming of logs, metrics, and traces, and provides a comprehensive and timely view of the performance and health of your Lambda functions.

This pattern explains how to integrate the Lambda Telemetry API with [OpenSearch](#), which is an open-source, distributed search and analytics engine. OpenSearch offers a powerful and scalable platform for ingesting, storing, and analyzing large volumes of data, which makes it an ideal choice for Lambda telemetry data. Specifically, this pattern demonstrates how to send logs from a Lambda function that's written in Python directly to an OpenSearch cluster by using a Lambda extension that's provided by AWS. This solution is flexible and customizable, so you can create your own Lambda extension or alter the sample source code to change the output format as desired.

The pattern explains how to set up and configure the Lambda Telemetry API integration with OpenSearch, and includes best practices for security, cost optimization, and scalability. The objective is to help you gain deeper insights into your Lambda functions and enhance the overall observability of your serverless applications.

**Note:** This pattern focuses on integrating the Lambda Telemetry API with managed OpenSearch. However, the principles and techniques discussed are also applicable to self-managed OpenSearch and Elasticsearch.

## Prerequisites and limitations

Before you begin the integration process, make sure that you have the following prerequisites in place:

**AWS account:** An active AWS account with appropriate permissions to create and manage the following AWS resources:

- AWS Lambda
- AWS Identity and Access Management (IAM)
- Amazon OpenSearch Service (if you're using a managed OpenSearch cluster)

### OpenSearch cluster:

- You can use an existing self-managed OpenSearch cluster or a managed service such as OpenSearch Service.
- If you're using OpenSearch Service, set up your OpenSearch cluster by following the instructions in [Getting started with Amazon OpenSearch Service](#) in the OpenSearch Service documentation.
- Make sure that the OpenSearch cluster is accessible from your Lambda function and is configured with the necessary security settings, such as access policies, encryption, and authentication.
- Configure the OpenSearch cluster with the necessary index mappings and settings to ingest the Lambda telemetry data. For more information, see [Loading streaming data into Amazon OpenSearch Service](#) in the OpenSearch Service documentation.

### Network connectivity:

- Ensure that your Lambda function has the necessary network connectivity to access the OpenSearch cluster. For guidance on how to configure virtual private cloud (VPC) settings, see [Launching your Amazon OpenSearch Service domains within a VPC](#) in the OpenSearch Service documentation.



**IAM roles and policies:**

- Create an IAM role with the necessary permissions for your Lambda function to access the OpenSearch cluster and access your credentials stored in AWS Secrets Manager.
- Attach the appropriate IAM policies to the role, such as the `AWSLambdaBasicExecutionRole` policy and any additional permissions required to interact with OpenSearch.
- Verify that the IAM permissions granted to your Lambda function allow it to write data to the OpenSearch cluster. For information about managing IAM permissions, see [Defining Lambda function permissions with an execution role](#) in the Lambda documentation.

**Programming language knowledge:**

- You will need basic knowledge of Python (or the programming language of your choice) to understand and modify the sample code for the Lambda function and the Lambda extension.

**Development environment:**

- Set up a local development environment or an [AWS Cloud9 environment](#) with the necessary tools and dependencies for building and deploying Lambda functions and extensions. For tutorials, see the [AWS Cloud9 documentation](#).

**AWS CLI or AWS Management Console:**

- Install and configure the [AWS Command Line Interface \(AWS CLI\)](#) or use the AWS Management Console with appropriate credentials to interact with the required AWS services.

**Monitoring and logging:**

- Become familiar with monitoring and logging best practices on AWS, including services such as Amazon CloudWatch and AWS CloudTrail for monitoring and auditing purposes.
- Check CloudWatch Logs for your Lambda function to identify any errors or exceptions related to the Lambda Telemetry API integration. For troubleshooting guidance, see the [Lambda Telemetry API documentation](#).

## Architecture

This pattern uses OpenSearch Service to store logs and telemetry data that are generated by Lambda functions. This approach enables you to quickly stream logs directly to your OpenSearch cluster, which reduces the latency and costs associated with using CloudWatch Logs as an intermediary.

**Note:** Your Lambda extension code can push telemetry to OpenSearch Service, either by directly using the OpenSearch API or by using an [OpenSearch client library](#). The Lambda extension can use the bulk operations supported by the OpenSearch API to batch telemetry events together and send them to OpenSearch Service in a single request.

The following workflow diagram illustrates the log workflow for Lambda functions when you use an OpenSearch cluster as the endpoint.

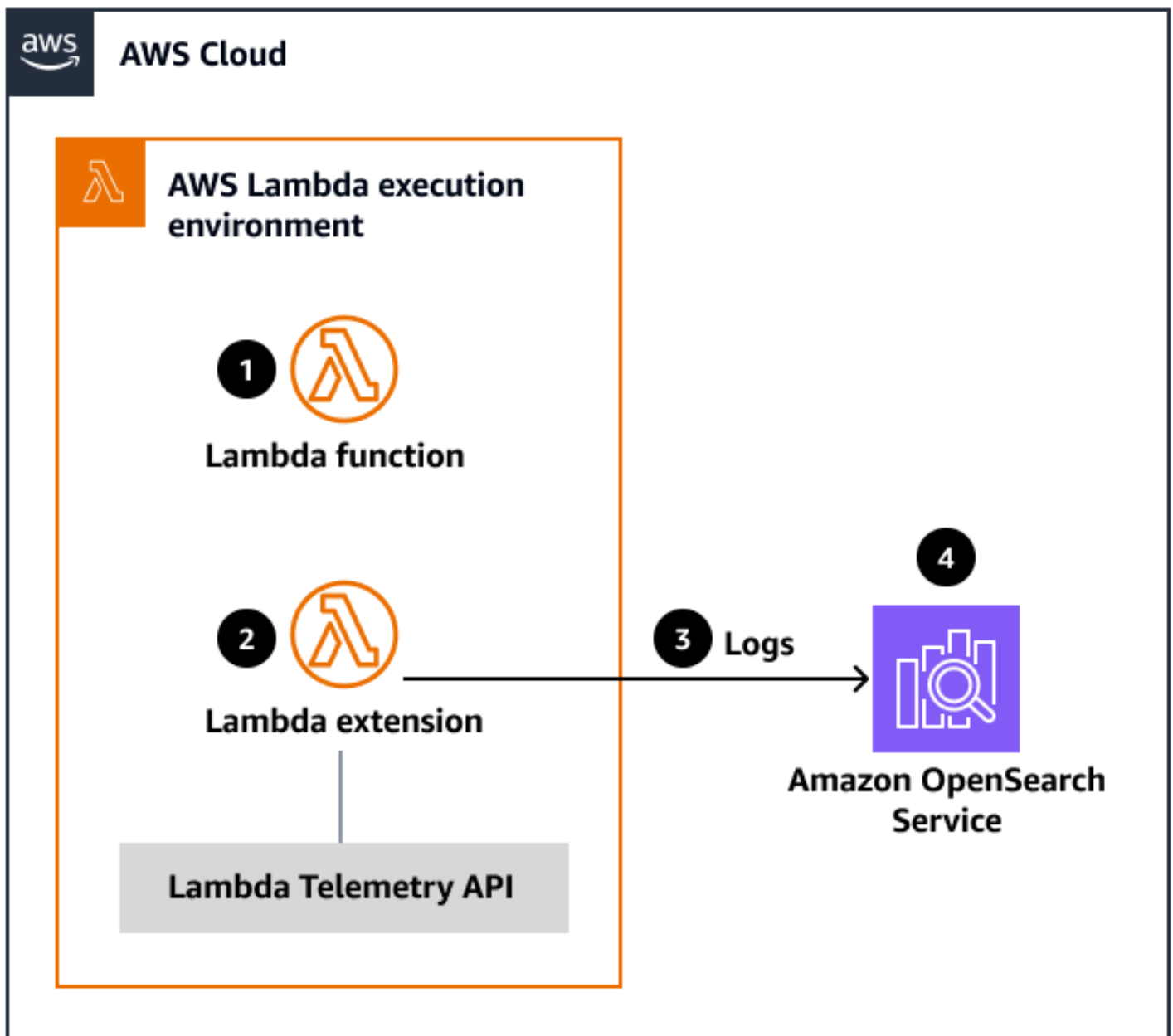

The architecture includes these components:

- **Lambda function:** The serverless function that generates logs and telemetry data during execution.
- **Lambda extension:** A Python-based extension that uses the Lambda Telemetry API to integrate directly with the OpenSearch cluster. This extension runs alongside the Lambda function in the same execution environment.
- **Lambda Telemetry API:** The API that enables Lambda extensions to send telemetry data, including logs, metrics, and traces, directly to third-party monitoring and observability tools.

- **Amazon OpenSearch Service cluster:** A managed OpenSearch cluster that's hosted on AWS. This cluster is responsible for ingesting, storing, and indexing the log data streamed from the Lambda function through the Lambda extension.

The workflow consists of these steps:

1. The Lambda function is called, and generates logs and telemetry data during its execution.
2. The Lambda extension runs alongside the function to capture the logs and telemetry data by using the Lambda Telemetry API.
3. The Lambda extension establishes a secure connection with the OpenSearch Service cluster and streams the log data in real time.
4. The OpenSearch Service cluster ingests, indexes, and stores the log data to make it available for search, analysis, and visualization through the use of tools such as Kibana or other compatible applications.

By circumventing CloudWatch Logs and sending log data directly to the OpenSearch cluster, this solution provides several benefits:

- Real-time log streaming and analysis, enabling faster troubleshooting and improved observability.
- Reduced latency and potential retention limitations associated with CloudWatch Logs.
- Flexibility to customize the Lambda extension or create your own extension for specific output formats or additional processing.
- Integration with the search, analytics, and visualization capabilities of OpenSearch Service for log analysis and monitoring.

The [Epics](#) section provides step-by-step instructions for setting up the Lambda extension, configuring the Lambda function, and integrating with the OpenSearch Service cluster. For security considerations, cost optimization strategies, and tips for monitoring and troubleshooting the solution, see the [Best practices](#) section.

## Tools

### AWS services

- [AWS Lambda](#) is a compute service that lets you run code without provisioning or managing servers. Lambda runs your code only when needed and scales automatically, from a few requests per day to thousands per second.
- [Amazon OpenSearch Service](#) is a fully managed service provided by AWS that makes it easy to deploy, operate, and scale OpenSearch clusters in the cloud.
- [Lambda extensions](#) extends the functionality of your Lambda functions by running custom code alongside them. You can use Lambda extensions to integrate Lambda with various monitoring, observability, security, and governance tools.
- [AWS Lambda Telemetry API](#) enables you to use extensions to capture enhanced monitoring and observability data directly from Lambda and send it to a destination of your choice.
- [AWS CloudFormation](#) helps you model and set up your AWS resources so that you can spend less time managing those resources and more time focusing on your applications.

## Code repositories

- [AWS Lambda Extensions](#) includes demos and sample projects from AWS and AWS Partners to help you get started with building your own extensions.
- [Example Lambda Telemetry Integrations for OpenSearch](#) provides a sample Lambda extension that demonstrates how to send logs from a Lambda function to an OpenSearch cluster.

## Other tools

- [OpenSearch](#) is an open-source distributed search and analytics engine that provides a powerful platform for ingesting, storing, and analyzing large volumes of data.
- Kibana is an open-source data visualization and exploration tool that you can use with OpenSearch. Note that the implementation of visualization and analytics is beyond the scope of this pattern. For more information, see the [Kibana documentation](#) and other resources.

## Best practices

When you integrate the Lambda Telemetry API with OpenSearch, consider the following best practices.

### Security and access control

- **Secure communication:** Encrypt all communications between your Lambda functions and the OpenSearch cluster by using HTTPS. Configure the necessary SSL/TLS settings in your Lambda extension and OpenSearch configuration.
- **IAM permissions:**
  - Extensions run in the same execution environment as the Lambda function, so they inherit the same level of access to resources such as the file system, networking, and environment variables.
  - Grant the minimum necessary IAM permissions to your Lambda functions to access the Lambda Telemetry API and write data to the OpenSearch cluster. Use the [principle of least privilege](#) to limit the scope of permissions.
- **OpenSearch access control:** Implement fine-grained access control in your OpenSearch cluster to restrict access to sensitive data. Use the built-in security features, such as user authentication, role-based access control, and index-level permissions, in OpenSearch.
- **Trusted extensions:** Always install extensions from a trusted source only. Use infrastructure as code (IaC) tools such as AWS CloudFormation to simplify the process of attaching the same extension configuration, including IAM permissions, to multiple Lambda functions. IaC tools also provide an audit record of the extensions and versions used previously.
- **Sensitive data handling:** When building extensions, avoid logging sensitive data. Sanitize payloads and metadata before logging or persisting them for audit purposes.

## Cost optimization

- **Monitoring and alerting:** Set up monitoring and alerting mechanisms to track the volume of data being sent to OpenSearch from your Lambda functions. This will help you identify and address any potential cost overruns.
- **Data retention:** Carefully consider the appropriate data retention period for your Lambda telemetry data in OpenSearch. Longer retention periods can increase storage costs, so balance your observability needs with cost optimization.
- **Compression and indexing:** Enable data compression and optimize your OpenSearch indexing strategy to reduce the storage footprint of your Lambda telemetry data.
- **Reduced reliance on CloudWatch:** By integrating the Lambda Telemetry API directly with OpenSearch, you can potentially reduce your reliance on CloudWatch Logs, which can result in cost savings. This is because the Lambda Telemetry API enables you to send logs directly to OpenSearch, which bypasses the need to store and process the data in CloudWatch.

## Scalability and reliability

- **Asynchronous processing:** Use asynchronous processing patterns, such as Amazon Simple Queue Service (Amazon SQS) or Amazon Kinesis, to decouple the Lambda function execution from the OpenSearch data ingestion. This helps maintain the responsiveness of your Lambda functions and improves the overall reliability of the system.
- **OpenSearch cluster scaling:** Monitor the performance and resource utilization of your OpenSearch cluster, and scale it up or down as needed to handle the increasing volume of Lambda telemetry data.
- **Failover and disaster recovery:** Implement a robust disaster recovery strategy for your OpenSearch cluster, including regular backups and the ability to quickly restore data in the event of a failure.

## Observability and monitoring

- **Dashboards and visualizations:** Use Kibana or other dashboard tools to create custom dashboards and visualizations that provide insights into the performance and health of your Lambda functions based on the telemetry data in OpenSearch.
- **Alerting and notifications:** Set up alerts and notifications to proactively monitor for anomalies, errors, or performance issues in your Lambda functions. Integrate these alerts and notifications with your existing incident management processes.
- **Tracing and correlation:** Ensure that your Lambda telemetry data includes relevant tracing information, such as request IDs or correlation IDs, to enable end-to-end observability and troubleshooting across your distributed serverless applications.

By following these best practices, you can ensure that your integration of the Lambda Telemetry API with OpenSearch is secure, cost-effective, and scalable, and provides comprehensive observability for your serverless applications.

# Epics

## Build and deploy the Lambda extension layer

Task	Description	Skills required
Download the source code.	Download the sample extensions from the <a href="#">AWS Lambda Extensions</a> repository.	App developer, Cloud architect
Navigate to the <code>python-example-telemetry-opensearch-extension</code> folder.	The <a href="#">AWS Lambda Extension</a> repository that you downloaded contains numerous examples for several use cases and language runtimes. Navigate to the <a href="#">python-example-telemetry-opensearch-extension</a> folder to use the Python OpenSearch extension, which sends logs to OpenSearch.	App developer, Cloud architect
Add permissions to execute the extension endpoint.	Run the following command to make the extension endpoint executable: <pre>chmod +x python-example-telemetry-opensearch-extension/extension.py</pre>	App developer, Cloud architect
Install the extension dependencies locally.	Run the following command to install local dependencies for the Python code: <pre>pip3 install -r python-example-telemetry-op</pre>	App developer, Cloud architect



Task	Description	Skills required
	<pre data-bbox="597 212 1026 426">ensearch-extension /requirements.txt - t ./python-example-t elemetry-opensearch- extension/</pre> <p data-bbox="597 464 1026 590">These dependencies will be mounted along with the extension code.</p>	
<p data-bbox="115 638 529 764">Create a .zip package for the extension to deploy it as a layer.</p>	<p data-bbox="597 638 1026 1150">The extension .zip file should contain a root directory called <code>extensions/</code> , where the extension executable is located, and another root directory called <code>python-example-telemetry-opensearch-extension/</code> , where the core logic of the extension and its dependencies are located.</p> <p data-bbox="597 1199 1026 1276">Create the .zip package for the extension:</p> <pre data-bbox="597 1318 1026 1675">chmod +x extensions/python-example-telemetry-opensearch-extension zip -r extension.zip extensions python-example-telemetry-opensearch-extension</pre>	<p data-bbox="1070 638 1382 716">App developer, Cloud architect</p>

Task	Description	Skills required
Deploy the extension as a Lambda layer.	<p>Publish the layer by using your extension .zip file and the following command:</p> <pre>aws lambda publish-l ayer-version \ --layer-name "python- example-telemetry-o pensearch-extension" \ --zip-file "fileb:// extension.zip"</pre>	App developer, Cloud architect

## Integrate the extension into your function

Task	Description	Skills required
Add the layer to your function.	<ol style="list-style-type: none"> <li>1. Sign in to the AWS Management Console and open the <a href="#">Functions page</a> of the AWS Lambda console.</li> <li>2. Select your function.</li> <li>3. Under <b>Layers</b>, choose <b>Add a layer</b>.</li> <li>4. Under <b>Choose a layer</b>, choose <b>Custom layers</b> as a layer source and add your layer.</li> </ol> <p>For more information about adding a layer to your Lambda function, see the <a href="#">Lambda documentation</a>.</p>	App developer, Cloud architect

Task	Description	Skills required
Set the environment variables for the function.	<p>On the function page, choose the <b>Configuration</b> tab and add the following environment variables to your function:</p> <ul style="list-style-type: none"><li>• URL – The URI of your OpenSearch endpoint where your logs will be sent.</li><li>• AUTH_SECRET – The ARN of your OpenSearch credentials stored in AWS Secrets Manager. This should be stored as a key-value pair and have two keys: <code>username</code> and <code>password</code>.</li><li>• PLATFORM_INDEX , FUNCTION_INDEX , and EXTENSION_INDEX – The names of indexes that will store your telemetry data, function logs, and extension logs. Make sure that they adhere to the proper <a href="#">naming criteria</a>. Otherwise, your indexes won't be created.</li><li>• DISPATCH_MIN_BATCH_SIZE – The number of log events that you want to batch. However, when the function shuts down,</li></ul>	App developer, Cloud architect

Task	Description	Skills required
	your logs will be dispatched regardless of this setting.	

## Add logging statements and test your function

Task	Description	Skills required
Add logging statements to your function.	<p>Add logging statements to your function by using one of the <a href="#">built-in logging mechanisms</a> or your logging module of choice.</p> <p>Here are examples of logging messages in Python:</p> <pre>print("Your Log Message Here") logger = logging.getLogger(__name__)  logger.info("Test Info Log.") logger.error("Test Error Log.")</pre>	App developer, Cloud architect
Test your function.	<ol style="list-style-type: none"> <li>1. On the function page, choose the <b>Test</b> tab.</li> <li>2. Create a test event for your function and run the test. For more information, see <a href="#">Testing Lambda functions in the console</a> in the Lambda documentation.</li> </ol>	App developer, Cloud architect

Task	Description	Skills required
	You should see <b>Executing function: succeeded</b> if everything works properly.	

## View your logs in OpenSearch

Task	Description	Skills required
Query your indexes.	<p>In OpenSearch, run the following command to query your indexes:</p> <pre>SELECT * FROM index-name</pre> <p>Your logs should be displayed in the query results.</p>	Cloud architect

## Troubleshooting

Issue	Solution
Connectivity issues	<ul style="list-style-type: none"> <li>Confirm that your Lambda function has the necessary network connectivity to access the OpenSearch cluster. See the <a href="#">OpenSearch Service documentation</a> for guidance on configuring VPC settings.</li> <li>Verify that the IAM permissions granted to your Lambda function allow it to write data to the OpenSearch cluster. Review the <a href="#">Lambda documentation</a> for information about managing IAM permissions.</li> </ul>

Issue	Solution
Data ingestion errors	<ul style="list-style-type: none"><li>• Check CloudWatch Logs for your Lambda function to identify any errors or exceptions related to the Lambda Telemetry API integration. See the <a href="#">Lambda Telemetry API documentation</a> for troubleshooting guidance.</li><li>• Verify that the OpenSearch cluster is configured correctly and has the necessary index mappings and settings to ingest the Lambda telemetry data. Consult the <a href="#">OpenSearch documentation</a> for more information.</li></ul>

## Related resources

- [Example Lambda Telemetry Integrations for OpenSearch](#) (GitHub repository)
- [Augment Lambda functions using Lambda extensions](#) (Lambda documentation)
- [Lambda Telemetry API](#) (Lambda documentation)
- [Introducing the AWS Lambda Telemetry API](#) (AWS blog post)
- [Integrating the AWS Lambda Telemetry API with Prometheus and OpenSearch](#) (AWS blog post)

## Additional information

### Altering the log structure

The extension sends logs as a nested document to OpenSearch by default. This allows you to perform nested queries to retrieve individual column values.

If the default log output doesn't meet your specific needs, you can customize it by modifying the source code of the Lambda extension that's provided by AWS. AWS encourages customers to adapt the output to suit their business requirements. To change the log output, locate the `dispatch_to_opensearch` function in the `telemetry_dispatcher.py` file within the extension's source code and make the necessary alterations.

# Set up private access to an Amazon S3 bucket through a VPC endpoint

*Created by Martin Maritsch (AWS), Gabriel Rodriguez Garcia (AWS), Shukhrat Khodjaev (AWS), Nicolas Jacob Baer (AWS), Mohan Gowda Purushothama (AWS), and Joaquin Rinaudo (AWS)*

**Code repository:** [Private S3 VPCE](#)

**Environment:** Production

**Technologies:** Serverless

**AWS services:** Amazon API Gateway; Amazon S3; Amazon VPC; Elastic Load Balancing (ELB)

## Summary

In Amazon Simple Storage Service (Amazon S3), presigned URLs enable you to share files of arbitrary size with target users. By default, Amazon S3 presigned URLs are accessible from the internet within an expiration time window, which makes them convenient to use. However, corporate environments often require access to Amazon S3 presigned URLs to be limited to a private network only.

This pattern presents a serverless solution for securely interacting with S3 objects by using presigned URLs from a private network without internet traversal. In the architecture, users access an Application Load Balancer through an internal domain name. Traffic is routed internally through Amazon API Gateway and a virtual private cloud (VPC) endpoint for the S3 bucket. The AWS Lambda function generates presigned URLs for file downloads through the private VPC endpoint, which helps enhance security and privacy for sensitive data.

## Prerequisites and limitations

### Prerequisites

- A VPC that includes a subnet deployed in an AWS account that is connected to the corporate network (for example, through AWS Direct Connect).

## Limitations

- The S3 bucket must have the same name as the domain, so we recommend that you check [Amazon S3 bucket naming rules](#).
- This sample architecture doesn't include monitoring features for the deployed infrastructure. If your use case requires monitoring, consider adding [AWS monitoring services](#).
- This sample architecture doesn't include input validation. If your use case requires input validation and an increased level of security, consider [using AWS WAF to protect your API](#).
- This sample architecture doesn't include access logging with the Application Load Balancer. If your use case requires access logging, consider enabling [load balancer access logs](#).

## Versions

- Python version 3.11 or later
- Terraform version 1.6 or later

## Architecture

### Target technology stack

The following AWS services are used in the target technology stack:

- **Amazon S3** is the core storage service used for uploading, downloading, and storing files securely.
- **Amazon API Gateway** exposes resources and endpoints for interacting with the S3 bucket. This service plays a role in generating presigned URLs for downloading or uploading data.
- **AWS Lambda** generates presigned URLs for downloading files from Amazon S3. The Lambda function is called by API Gateway.
- **Amazon VPC** deploys resources within a VPC to provide network isolation. The VPC includes subnets and routing tables to control traffic flow.
- **Application Load Balancer** routes incoming traffic either to API Gateway or to the VPC endpoint of the S3 bucket. It allows users from the corporate network to access resources internally.
- **VPC endpoint for Amazon S3** enables direct, private communication between resources in the VPC and Amazon S3 without traversing the public internet.



- **AWS Identity and Access Management (IAM)** controls access to AWS resources. Permissions are set up to ensure secure interactions with the API and other services.

## Target architecture

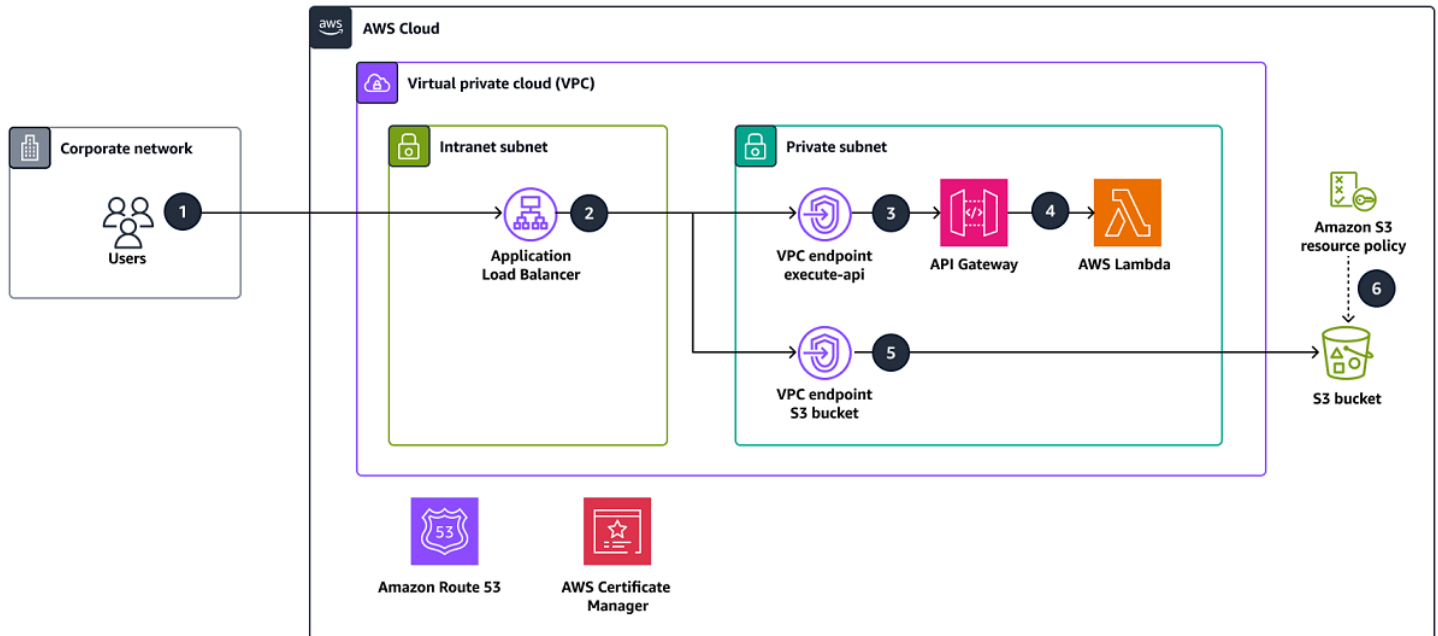

The diagram illustrates the following:

1. Users from the corporate network can access the Application Load Balancer through an internal domain name. We assume that a connection exists between the corporate network and the intranet subnet in the AWS account (for example, through a AWS Direct Connect connection).
2. The Application Load Balancer routes incoming traffic either to API Gateway to generate presigned URLs to download or upload data to Amazon S3, or to the VPC endpoint of the S3 bucket. In both scenarios, requests are routed internally and do not need to traverse the internet.
3. API Gateway exposes resources and endpoints to interact with the S3 bucket. In this example, we provide an endpoint to download files from the S3 bucket, but this could be extended to provide upload functionality as well.
4. The Lambda function generates the presigned URL to download a file from Amazon S3 by using the domain name of the Application Load Balancer instead of the public Amazon S3 domain.
5. The user receives the presigned URL and uses it to download the file from Amazon S3 by using the Application Load Balancer. The load balancer includes a default route to send traffic that's not intended for the API toward the VPC endpoint of the S3 bucket.

- The VPC endpoint routes the presigned URL with the custom domain name to the S3 bucket. The S3 bucket must have the same name as the domain.

## Automation and scale

This pattern uses Terraform to deploy the infrastructure from the code repository into an AWS account.

## Tools

### Tools

- [Python](#) is a general-purpose computer programming language.
- [Terraform](#) is an infrastructure as code (IaC) tool from HashiCorp that helps you create and manage cloud and on-premises resources.
- [AWS Command Line Interface \(AWS CLI\)](#) is an open source tool that helps you interact with AWS services through commands in your command-line shell.

### Code repository

The code for this pattern is available in a GitHub repository at <https://github.com/aws-samples/private-s3-vpce>.

## Best practices

The sample architecture for this pattern uses [IAM permissions](#) to control access to the API. Anyone who has valid IAM credentials can call the API. If your use case requires a more complex authorization model, you might want to [use a different access control mechanism](#).

## Epics

### Deploy the solution in an AWS account

Task	Description	Skills required
Obtain AWS credentials.	Review your AWS credentials and your access to your account. For instructions, see	AWS DevOps, General AWS

Task	Description	Skills required
	<p><a href="#">Configuration and credential file settings</a> in the AWS CLI documentation.</p>	
Clone the repository.	<p>Clone the GitHub repository provided with this pattern:</p> <pre>git clone https://github.com/aws-samples/private-s3-vpce</pre>	AWS DevOps, General AWS
Configure variables.	<ol style="list-style-type: none"><li>1. On your computer, in the GitHub repository, open the <code>terraform</code> folder:<pre>cd terraform</pre></li><li>2. Open the <code>example.tfvars</code> file and customize the parameters according to your needs.</li></ol>	AWS DevOps, General AWS
Deploy solution.	<ol style="list-style-type: none"><li>1. In the <code>terraform</code> folder, run Terraform and pass in the variables that you customized:<pre>terraform apply -var-file="example.tfvars"</pre></li><li>2. Confirm that the resources shown in the architecture diagram were deployed successfully.</li></ol>	AWS DevOps, General AWS

## Test the solution

Task	Description	Skills required
Create a test file.	<p>Upload a file to Amazon S3 to create a test scenario for the file download. You can use the <a href="#">Amazon S3 console</a> or the following AWS CLI command:</p> <pre>aws s3 cp /path/to/testfile s3://your-bucket-name/testfile</pre>	AWS DevOps, General AWS
Test presigned URL functionality.	<ol style="list-style-type: none"><li>1. Send a request to the Application Load Balancer to create a presigned URL for the test file by using <a href="#">awscurl</a>:<pre>awscurl https://your-domain-name/api/get_url?key=testfile</pre><p>This step creates a valid signature from your credentials, which will be validated by API Gateway.</p></li><li>2. Parse the link from the response you receive from the previous step, and open the presigned URL to download the file.</li></ol>	AWS DevOps, General AWS
Clean up.	Make sure to remove the resources when they are no longer required:	AWS DevOps, General AWS

Task	Description	Skills required
	<code>terraform destroy</code>	

## Troubleshooting

Issue	Solution
S3 object key names with special characters such as number signs (#) break URL parameters and lead to errors.	Encode URL parameters properly, and make sure that the S3 object key name follows <a href="#">Amazon S3 guidelines</a> .

## Related resources

Amazon S3:

- [Sharing objects with presigned URLs](#)
- [Controlling access from VPC endpoints with bucket policies](#)

Amazon API Gateway:

- [Use VPC endpoint policies for private APIs in API Gateway](#)

Application Load Balancer:

- [Hosting Internal HTTPS Static Websites with ALB, S3, and PrivateLink](#) (AWS blog post)

# Chain AWS services together using a serverless approach

Created by Aniket Braganza (AWS)

**Environment:** Production

**Technologies:** Serverless;  
CloudNative; DevelopmentAndTesting; DevOps;  
Modernization; Infrastructure

**AWS services:** Amazon S3;  
Amazon SNS; Amazon SQS;  
AWS Lambda

## Summary

This pattern demonstrates a scalable, serverless approach for processing an uploaded file by chaining together Amazon Simple Storage Service (Amazon S3), Amazon Simple Notification Service (Amazon SNS), Amazon Simple Queue Service (Amazon SQS), and AWS Lambda. The uploaded file example is for demonstration purposes. You can use a serverless approach to complete other tasks by chaining together the combination of AWS services that are necessary to meet your business goals. The serverless approach employs an asynchronous workflow that relies on event-driven notifications, resilient storage, and function as a service (FaaS) computing to process requests. You can use the serverless approach to scale to meet demand while minimizing costs.

**Note:** There are several options for chaining AWS services together through a serverless approach. For example, you can use an approach that combines Lambda with Amazon S3 instead of Amazon SNS and Amazon SQS. However, this pattern uses Amazon SNS and Amazon SQS because this approach makes it possible to add multiple integration points into the Lambda invocation process during an event notification and to extend the implementation to include multiple listeners in a serverless orchestration while minimizing the amount of processing overhead.

## Prerequisites and limitations

### Prerequisites

- An active AWS account
- Programmatic access to the AWS account. For more information, see:
  - [Prerequisites](#) in the AWS Cloud Development Kit (AWS CDK) documentation
  - [Prerequisites](#) in the AWS Command Line Interface (AWS CLI) documentation

- AWS CDK, [installed](#)
- AWS CLI, [installed](#) and [configured](#)
- [Python 3.9](#)

## Product versions

- AWS CDK 2.x
- Python 3.9

## Architecture

The following diagram illustrates how chained AWS services can enable a user to upload a file to an S3 bucket for processing.

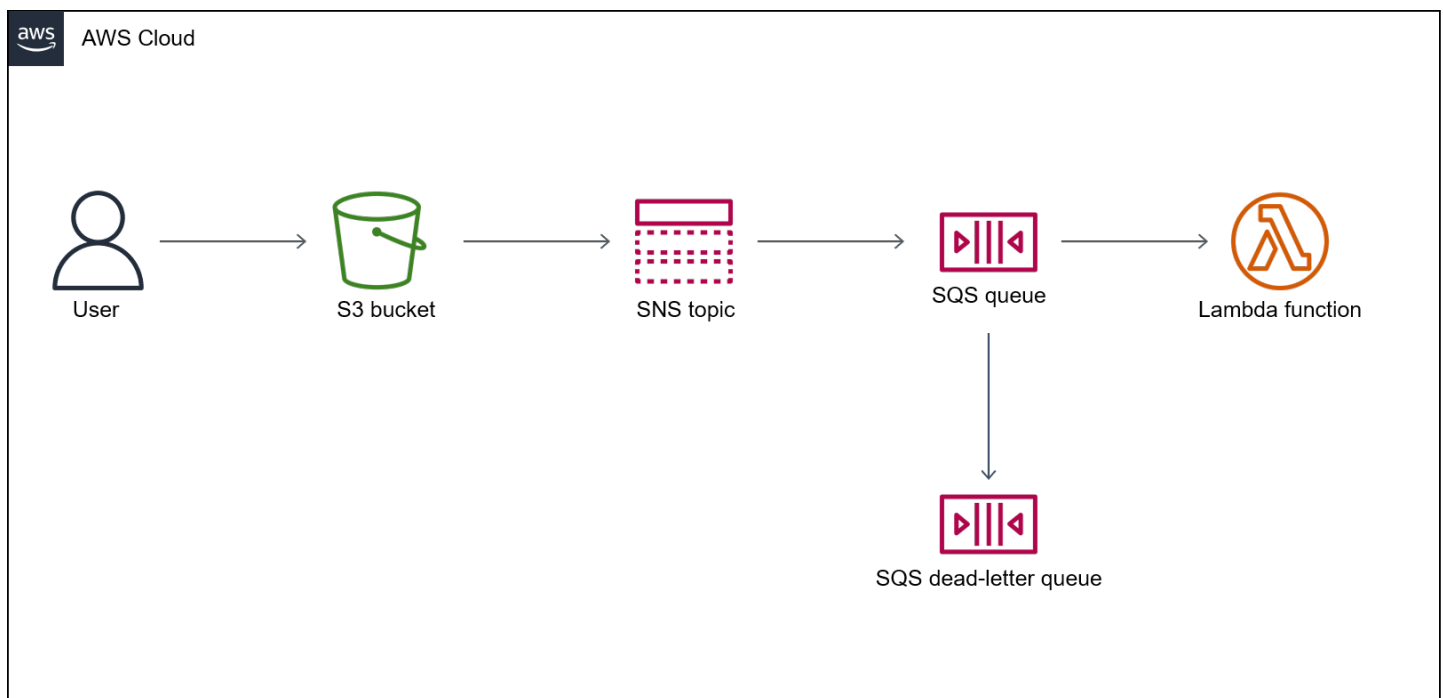

The diagram shows the following workflow:

1. A user uploads a file to the S3 bucket.
2. The upload initiates an S3 event that publishes a message to an SNS topic. The message contains the details of the S3 event.
3. The message published to the SNS topic is inserted into an SQS queue, which is subscribed to and receives notifications for that topic.

4. A Lambda function polls the SQS queue (as its event source) and waits for messages to process.
5. When the Lambda function receives messages from the SQS queue, it processes them and acknowledges receipt of those messages.
6. If a message isn't processed by Lambda, then that message is returned to the SQS queue and is eventually transferred to an [SQS dead-letter queue](#).

## Technology stack

- Amazon S3
- Amazon SNS
- Amazon SQS
- AWS Lambda

## Tools

### AWS services

- [Amazon Simple Storage Service \(Amazon S3\)](#) is a cloud-based object storage service that helps you store, protect, and retrieve any amount of data.
- [Amazon Simple Notification Service \(Amazon SNS\)](#) helps you coordinate and manage the exchange of messages between publishers and clients, including web servers and email addresses.
- [Amazon Simple Queue Service \(Amazon SQS\)](#) provides a secure, durable, and available hosted queue that helps you integrate and decouple distributed software systems and components.
- [AWS Lambda](#) is a compute service that helps you run code without needing to provision or manage servers. It runs your code only when needed and scales automatically, so you pay only for the compute time that you use.

### Other tools

- [AWS Cloud Development Kit \(AWS CDK\)](#) is the primary tool for interacting with your AWS CDK app. It executes your app, interrogates the application model you defined, and produces and deploys the AWS CloudFormation templates generated by the AWS CDK.
- [AWS Command Line Interface \(AWS CLI\)](#) is an open-source tool that helps you interact with AWS services through commands in your command-line shell.



- [Python](#) is a high-level, interpreted general purpose programming language.

## Code

The code for this pattern is available in the GitHub [Chaining S3 to SNS to SQS to Lambda](#) repository.

## Epics

### Develop your serverless environment

Task	Description	Skills required
Clone the repository.	Clone the <a href="#">repository</a> and navigate to the <code>python/s3-sns-sqs-lambda-chain</code> folder.	App developer
Set up a virtual environment.	<ol style="list-style-type: none"><li>1. In the AWS CDK, run the <code>python3 -m venv .venv</code> command.</li><li>2. Run the source <code>.venv/bin/activate</code> command on MacOS/Linux or <code>.venv\Scripts\activate.bat</code> on Windows.</li></ol>	App developer
Install dependencies.	Run the <code>pip install -r requirements.txt</code> command.	App developer

## Test the CloudFormation stack

Task	Description	Skills required
Run unit tests.	<ol style="list-style-type: none"><li>1. Run the <code>pip install -r requirements-dev.txt</code> command.</li><li>2. (Optional) Run the <code>cdk synth --no-staging &gt; template.yml</code> command to generate the CloudFormation stack. <b>Important:</b> You can inspect the stack, but avoid generating the staged resources and artifacts.</li><li>3. Run the <code>pytest</code> command to run all unit tests.</li><li>4. (Optional) Run the <code>pytest tests/unit/&lt;test_filename&gt;</code> command to run tests for a specific file.</li></ol>	App developer, Test engineer

## Deploy the CloudFormation stack

Task	Description	Skills required
Set up the bootstrap environment.	Follow the instructions in <a href="#">Bootstrapping</a> in the AWS documentation to bootstrap the environment for AWS CDK deployment in each AWS Region where the CloudFormation stack will be deployed.	App developer, DevOps engineer, Data engineer

Task	Description	Skills required
	<b>Note:</b> This step requires that you have credentials with programmatic access.	
Deploy the CloudFormation stack.	Run the <code>cdk deploy</code> command to build and deploy the stack to the AWS account.	App developer, DevOps engineer, AWS DevOps

### Clean up your environment's resources

Task	Description	Skills required
Delete the CloudFormation stack and remove associated resources.	To delete the CloudFormation stack that was created and remove all associated resources, run the <code>run cdk destroy</code> command.	App developer

## More patterns

- [Access, query, and join Amazon DynamoDB tables using Athena](#)
- [Aggregate data in Amazon DynamoDB for ML forecasting in Athena](#)
- [Automate AWS resource assessment](#)
- [Automate deployment of nested applications using AWS SAM](#)
- [Automate the replication of Amazon RDS instances across AWS accounts](#)
- [Automatically archive items to Amazon S3 using DynamoDB TTL](#)
- [Automatically detect changes and initiate different CodePipeline pipelines for a monorepo in CodeCommit](#)
- [Build a loosely coupled architecture with microservices using DevOps practices and AWS Cloud9](#)
- [Build a multi-tenant serverless architecture in Amazon OpenSearch Service](#)
- [Build an advanced mainframe file viewer in the AWS Cloud](#)
- [Calculate value at risk \(VaR\) by using AWS services](#)
- [Copy AWS Service Catalog products across different AWS accounts and AWS Regions](#)
- [Create dynamic CI pipelines for Java and Python projects automatically](#)
- [Decompose monoliths into microservices by using CQRS and event sourcing](#)
- [Deploy a React-based single-page application to Amazon S3 and CloudFront](#)
- [Deploy an Amazon API Gateway API on an internal website using private endpoints and an Application Load Balancer](#)
- [Deploy and debug Amazon EKS clusters](#)
- [Deploy and manage a serverless data lake on the AWS Cloud by using infrastructure as code](#)
- [Deploy Lambda functions with container images](#)
- [Develop a fully automated chat-based assistant by using Amazon Bedrock agents and knowledge bases](#)
- [Develop advanced generative AI chat-based assistants by using RAG and ReAct prompting](#)
- [Dynamically generate an IAM policy with IAM Access Analyzer by using Step Functions](#)
- [Ensure Amazon EMR logging to Amazon S3 is enabled at launch](#)
- [Estimate the cost of a DynamoDB table for on-demand capacity](#)
- [Generate personalized and re-ranked recommendations using Amazon Personalize](#)
- [Generate test data using an AWS Glue job and Python](#)

- [Implement the serverless saga pattern by using AWS Step Functions](#)
- [Improve operational performance by enabling Amazon DevOps Guru across multiple AWS Regions, accounts, and OUs with the AWS CDK](#)
- [Launch a CodeBuild project across AWS accounts using Step Functions and a Lambda proxy function](#)
- [Migrate Apache Cassandra workloads to Amazon Keyspaces by using AWS Glue](#)
- [Monitor use of a shared Amazon Machine Image across multiple AWS accounts](#)
- [Orchestrate an ETL pipeline with validation, transformation, and partitioning using AWS Step Functions](#)
- [Run event-driven and scheduled workloads at scale with AWS Fargate](#)
- [Serve static content in an Amazon S3 bucket through a VPC by using Amazon CloudFront](#)
- [Structure a Python project in hexagonal architecture using AWS Lambda](#)
- [Turn off security standard controls across all Security Hub member accounts in a multi-account environment](#)
- [Unload data from an Amazon Redshift cluster across accounts to Amazon S3](#)

# Storage & backup

## Topics

- [Allow EC2 instances write access to S3 buckets in AMS accounts](#)
- [Automate data stream ingestion into a Snowflake database by using Snowflake Snowpipe, Amazon S3, Amazon SNS, and Amazon Data Firehose](#)
- [Automatically encrypt existing and new Amazon EBS volumes](#)
- [Back up Sun SPARC servers in the Stromasys Charon-SSP emulator on the AWS Cloud](#)
- [Back up and archive data to Amazon S3 with Veeam Backup & Replication](#)
- [Configure Veritas NetBackup for VMware Cloud on AWS](#)
- [Copy data from an S3 bucket to another account and Region by using the AWS CLI](#)
- [Copy data from an S3 bucket to another account and Region by using S3 Batch Replication](#)
- [Migrate data from an on-premises Hadoop environment to Amazon S3 using DistCp with AWS PrivateLink for Amazon S3](#)
- [Use CloudEndure for disaster recovery of an on-premises database](#)
- [More patterns](#)

# Allow EC2 instances write access to S3 buckets in AMS accounts

Created by Mansi Suratwala (AWS)

**Environment:** Production

**Technologies:** Storage & backup; Databases; Operations; Security, identity, compliance

**AWS services:** Amazon S3; AWS Managed Services

## Summary

AWS Managed Services (AMS) helps you operate your AWS infrastructure more efficiently and securely. AMS accounts have security guardrails for standardized administration of your AWS resources. One guardrail is that default Amazon Elastic Compute Cloud (Amazon EC2) instance profiles don't allow write access to Amazon Simple Storage Service (Amazon S3) buckets. However, your organization might have multiple S3 buckets and require more control over access by EC2 instances. For example, you might want to store database backups from EC2 instances in an S3 bucket.

This pattern explains how to use requests for change (RFCs) to allow your EC2 instances write access to S3 buckets in your AMS account. An RFC is a request created by you or AMS to make a change in your managed environment and that includes a [change type](#) (CT) ID for a particular operation.

## Prerequisites and limitations

### Prerequisites

- An AMS Advanced account. For more information about this, see [AMS operations plans](#) in the AMS documentation.
- Access to the AWS Identity and Access Management (IAM) `customer-mc-user-role` role to submit RFCs.
- AWS Command Line Interface (AWS CLI), installed and configured with the EC2 instances in your AMS account.
- An understanding of how to create and submit RFCs in AMS. For more information about this, see [What are AMS change types?](#) in the AMS documentation.

- An understanding of manual and automated change types (CTs). For more information about this, see [Automated and manual CTs](#) in the AMS documentation.

## Architecture

### Technology stack

- AMS
- AWS CLI
- Amazon EC2
- Amazon S3
- IAM

### Tools

- [AWS Command Line Interface \(AWS CLI\)](#) is an open-source tool that helps you interact with AWS services through commands in your command-line shell.
- [AWS Identity and Access Management \(IAM\)](#) helps you securely manage access to your AWS resources by controlling who is authenticated and authorized to use them.
- [AWS Managed Services \(AMS\)](#) helps you operate your AWS infrastructure more efficiently and securely.
- [Amazon Simple Storage Service \(Amazon S3\)](#) is a cloud-based object storage service that helps you store, protect, and retrieve any amount of data.
- [Amazon Elastic Compute Cloud \(Amazon EC2\)](#) provides scalable computing capacity in the AWS Cloud. You can launch as many virtual servers as you need and quickly scale them up or down.

## Epics

### Create an S3 bucket with an RFC

Task	Description	Skills required
Create an S3 bucket by using an automated RFC.	1. Sign in to your AMS account, choose the <b>Choose change type</b> page,	AWS systems administrator, AWS developer



Task	Description	Skills required
	<p>choose <b>RFCs</b>, and then choose <b>Create RFC</b>.</p> <p>2. Submit the <b>Create S3 Bucket</b> automated RFC.</p> <p><b>Note:</b> Make sure that you record the S3 bucket's name.</p>	

### Create an IAM instance profile and associate it with the EC2 instances

Task	Description	Skills required
Submit a manual RFC to create an IAM role.	<p>When an AMS account is onboarded, a default IAM instance profile named <code>customer-mc-ec2-instance-profile</code> is created and associated with each EC2 instance in your AMS account. However, the instance profile doesn't have write permissions to your S3 buckets.</p> <p>To add the write permissions, submit the <b>Create IAM Resource</b> manual RFC to create an IAM role that has the following three policies: <code>customer_ec2_instance_</code>, <code>customer_deny_policy</code>, and <code>customer_ec2_s3_integration_policy</code>.</p>	AWS systems administrator, AWS developer

Task	Description	Skills required
	<p><b>Important:</b> The <code>customer_ec2_instance_</code> and <code>customer_deny_policy</code> policies already exist in your AWS account. However, you need to create <code>customer_ec2_s3_integration_policy</code> by using the following sample policy:</p> <pre data-bbox="592 667 1031 1873">{   "Version": "2012-10-17",   "Statement": [     {       "Sid": "",       "Effect": "Allow",       "Principal": {         "Service": "ec2.amazonaws.com"       },       "Action": "sts:AssumeRole"     }   ] }  Role Permissions: {   "Version": "2012-10-17",   "Statement": [     {       "Action": [  "s3:ListBucket",  "s3:GetBucketLocat ion"</pre>	

Task	Description	Skills required
	<pre> ],   "Resource": "arn:aws:s3::",   "Effect": "Allow" }, {   "Action": [     "s3:GetObject",     "s3:PutObject",     "s3:ListMultipartUploadParts",     "s3:AbortMultipartUpload"   ],   "Resource": "arn:aws:s3::*/*",   "Effect": "Allow" } ] } </pre>	
Submit a manual RFC to replace the IAM instance profile.	Submit a manual RFC to associate the target EC2 instances with the new IAM instance profile.	AWS systems administrator, AWS developer
Test a copy operation to the S3 bucket.	<p>Test a copy operation to the S3 bucket by running the following command in the AWS CLI:</p> <pre>aws s3 cp test.txt s3://&lt;S3 bucket&gt;/test2.txt</pre>	AWS systems administrator, AWS developer

## Related resources

- [Create an IAM instance profile for your Amazon EC2 instances](#)
- [Creating an S3 bucket \(using the Amazon S3 console, AWS SDKs, or AWS CLI\)](#)

# Automate data stream ingestion into a Snowflake database by using Snowflake Snowpipe, Amazon S3, Amazon SNS, and Amazon Data Firehose

*Created by Bikash Chandra Rout (AWS)*

**Environment:** PoC or pilot

**Technologies:** Storage & backup

## Summary

This pattern describes how you can use services on the Amazon Web Services (AWS) Cloud to process a continuous stream of data and load it into a Snowflake database. The pattern uses Amazon Data Firehose to deliver the data to Amazon Simple Storage Service (Amazon S3), Amazon Simple Notification Service (Amazon SNS) to send notifications when new data is received, and Snowflake Snowpipe to load the data into a Snowflake database.

By following this pattern, you can have continuously generated data available for analysis in seconds, avoid multiple manual COPY commands, and have full support for semi-structured data on load.

## Prerequisites and limitations

### Prerequisites

- An active AWS account.
- A data source that is continuously sending data to a Firehose delivery stream.
- An existing S3 bucket that is receiving the data from the Firehose delivery stream.
- An active Snowflake account.

### Limitations

- Snowflake Snowpipe doesn't connect directly to Firehose.

# Architecture

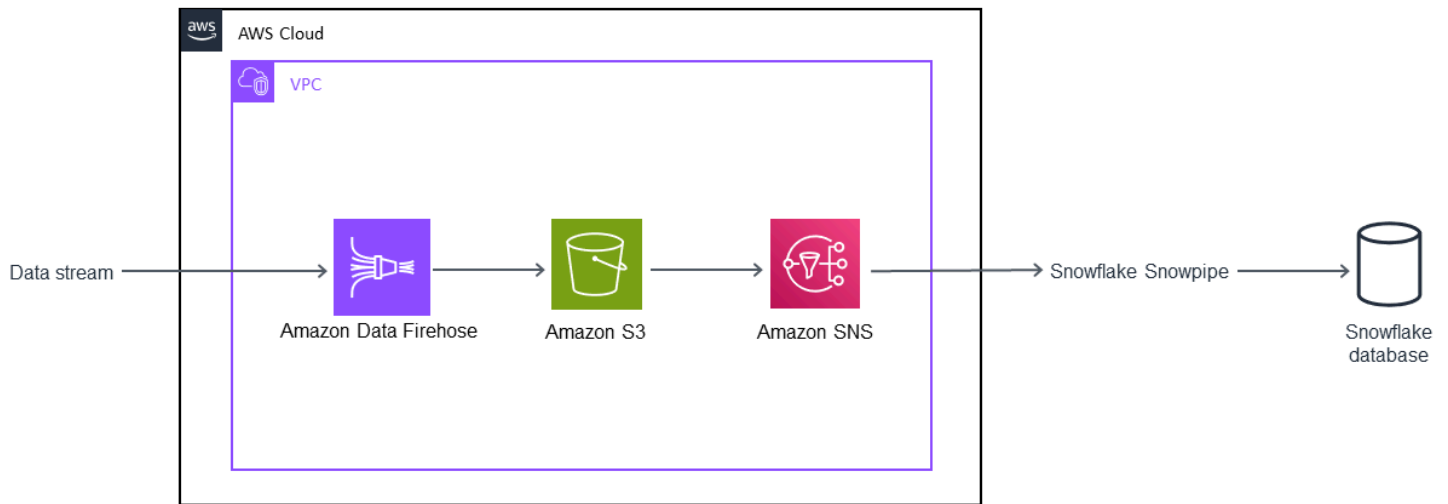

## Technology stack

- Amazon Data Firehose
- Amazon SNS
- Amazon S3
- Snowflake Snowpipe
- Snowflake database

## Tools

- [Amazon Data Firehose](#) is a fully managed service for delivering real-time streaming data to destinations such as Amazon S3, Amazon Redshift, Amazon OpenSearch Service, Splunk, and any custom HTTP endpoint or HTTP endpoints owned by supported third-party service providers.
- [Amazon Simple Storage Service \(Amazon S3\)](#) is storage for the internet.
- [Amazon Simple Notification Service \(Amazon SNS\)](#) coordinates and manages the delivery or sending of messages to subscribing endpoints or clients.
- [Snowflake](#) – Snowflake is an analytic data warehouse provided as Software-as-a-Service (SaaS).
- [Snowflake Snowpipe](#) – Snowpipe loads data from files as soon as they're available in a Snowflake stage.

# Epics

## Set up a Snowflake Snowpipe

Task	Description	Skills required
Create a CSV file in Snowflake .	Sign in to Snowflake and run the <code>CREATE FILE FORMAT</code> command to create a CSV file with a specified field delimiter . For more information about this and other Snowflake commands, see the <a href="#">Additional information</a> section.	Developer
Create an external Snowflake stage.	Run the <code>CREATE STAGE</code> command to create an external Snowflake stage that references the CSV file you created earlier. Important: You will need the URL for the S3 bucket, your AWS access key, and your AWS secret access key. Run the <code>SHOW STAGES</code> command to verify that the Snowflake stage is created.	Developer
Create the Snowflake target table.	Run the <code>CREATE TABLE</code> command to create the Snowflake table.	Developer
Create a pipe.	Run the <code>CREATE PIPE</code> command; make sure that <code>auto_ingest=true</code> is in the command. Run the <code>SHOW PIPES</code> command to verify that the pipe is created. Copy	Developer

Task	Description	Skills required
	and save the notification_channel column value. This value will be used to configure Amazon S3 event notifications.	

## Configure the S3 bucket

Task	Description	Skills required
Create a 30-day lifecycle policy for the S3 bucket.	Sign in to the AWS Management Console and open the Amazon S3 console. Choose the S3 bucket that contains the data from Firehose. Then choose the <b>Management</b> tab in the S3 bucket and choose <b>Add lifecycle rule</b> . Enter a name for your rule in the <b>Lifecycle rule</b> dialog box, and configure a 30-day lifecycle rule for your bucket. For help with this and other stories, see the <a href="#">Related resources</a> section.	System Administrator, Developer
Create an IAM policy for the S3 bucket.	Open the AWS Identity and Access Management (IAM) console and choose <b>Policies</b> . Choose <b>Create policy</b> , and choose the <b>JSON</b> tab. Copy and paste the policy from the <a href="#">Additional information</a> section into the JSON field. This policy will grant	System Administrator, Developer



Task	Description	Skills required
	PutObject and DeleteObject permissions, as well as GetObject, GetObjectVersion, and ListBucket permissions. Choose <b>Review policy</b> , enter a policy name, and then choose <b>Create policy</b> .	
Assign the policy to an IAM role.	Open the IAM console, choose <b>Roles</b> , and then choose <b>Create role</b> . Choose <b>Another AWS account</b> as the trusted entity. Enter your AWS account ID, and choose <b>Require external ID</b> . Enter a placeholder ID that you will change it later. Choose <b>Next</b> , and assign the IAM policy you created earlier. Then create the IAM role.	System Administrator, Developer
Copy the Amazon Resource Name (ARN) for the IAM role.	Open the IAM console, and choose <b>Roles</b> . Choose the IAM role you created earlier, and then copy and store the <b>Role ARN</b> .	System Administrator, Developer

## Set up a storage integration in Snowflake

Task	Description	Skills required
Create a storage integration in Snowflake.	Sign in to Snowflake and run the CREATE STORAGE INTEGRATION command.	System Administrator, Developer

Task	Description	Skills required
	This will modify the trusted relationship, grant access to Snowflake, and provide the external ID for your Snowflake stage.	
Retrieve the IAM role for your Snowflake account.	Run the <code>DESC INTEGRATION</code> command to retrieve the ARN for the IAM role.  <b>Important:</b> <code>&lt;integration_name&gt;</code> is the name of the Snowflake storage integration you created earlier.	System Administrator, Developer
Record two column values.	Copy and save the values for the <code>storage_aws_iam_user_arn</code> and <code>storage_aws_external_id</code> columns.	System Administrator, Developer

### Allow Snowflake Snowpipe to access the S3 bucket

Task	Description	Skills required
Modify the IAM role policy.	Open the IAM console and choose <b>Roles</b> . Choose the IAM role you created earlier and choose the <b>Trust relationships</b> tab. Choose <b>Edit trust relationship</b> . Replace <code>snowflake_external_id</code> with the <code>storage_aws_external_id</code> value	System Administrator, Developer

Task	Description	Skills required
	you copied earlier. Replace <code>snowflake_user_arn</code> with the <code>storage_aws_iam_user_arn</code> value you copied earlier. Then choose <b>Update trust policy</b> .	

### Turn on and configure SNS notifications for the S3 bucket

Task	Description	Skills required
Turn on event notifications for the S3 bucket.	Open the Amazon S3 console and choose your bucket. Choose <b>Properties</b> , and under <b>Advanced settings</b> , choose <b>Events</b> . Choose <b>Add notification</b> , and enter a name for this event. If you don't enter a name, a globally unique identifier (GUID) will be used.	System Administrator, Developer
Configure Amazon SNS notifications for the S3 bucket.	Under <b>Events</b> , choose <b>ObjectCreate (All)</b> , and then choose <b>SQS Queue</b> in the <b>Send to</b> dropdown list. In the <b>SNS</b> list, choose <b>Add SQS queue ARN</b> , and paste the <code>notification_channel</code> value you copied earlier. Then choose <b>Save</b> .	System Administrator, Developer
Subscribe the Snowflake SQS queue to the SNS topic.	Subscribe the Snowflake SQS queue to the SNS topic you created. For help with	System Administrator, Developer

Task	Description	Skills required
	this step, see the <a href="#">Related resources</a> section.	

## Check the Snowflake stage integration

Task	Description	Skills required
Check and test Snowpipe.	Sign in to Snowflake and open the Snowflake stage. Drop files into your S3 bucket and check if the Snowflake table loads them. Amazon S3 will send SNS notifications to Snowpipe when new objects appear in the S3 bucket.	System Administrator, Developer

## Related resources

- [Managing your storage lifecycle](#)
- [Subscribe the Snowflake SQS Queue to the Amazon SNS Topic](#)

## Additional information

### Create a file format:

```
CREATE FILE FORMAT <name>
TYPE = 'CSV'
FIELD_DELIMITER = '|'
SKIP_HEADER = 1;
```

### Create an external stage:

```
externalStageParams (for Amazon S3) ::=
  URL = 's3://[//]'
```

```
[ { STORAGE_INTEGRATION = } | { CREDENTIALS = ( { { AWS_KEY_ID = `` AWS_SECRET_KEY
= `` [ AWS_TOKEN = `` ] } | AWS_ROLE = `` } ) ) } ` ]
[ ENCRYPTION = ( [ TYPE = 'AWS_CSE' ] [ MASTER_KEY = '' ] |
                  [ TYPE = 'AWS_SSE_S3' ] |
                  [ TYPE = 'AWS_SSE_KMS' [ KMS_KEY_ID = '' ] ] |
                  [ TYPE = NONE ] )
```

## Create a table:

```
CREATE [ OR REPLACE ] [ { [ LOCAL | GLOBAL ] TEMP[ORARY] | VOLATILE } | TRANSIENT ]
TABLE [ IF NOT EXISTS ]
<table_name>
( <col_name> <col_type> [ { DEFAULT <expr>
                          | { AUTOINCREMENT | IDENTITY } [ ( <start_num> ,
<step_num> ) | START <num> INCREMENT <num> ] } ] ]
/* AUTOINCREMENT / IDENTITY supported only for numeric
data types (NUMBER, INT, etc.) */
[ inlineConstraint ]
[ , <col_name> <col_type> ... ]
[ , outoflineConstraint ]
[ , ... ] )
[ CLUSTER BY ( <expr> [ , <expr> , ... ] ) ]
[ STAGE_FILE_FORMAT = ( { FORMAT_NAME = '<file_format_name>'
                        | TYPE = { CSV | JSON | AVRO | ORC | PARQUET | XML }
[ formatTypeOptions ] } ) ]
[ STAGE_COPY_OPTIONS = ( copyOptions ) ]
[ DATA_RETENTION_TIME_IN_DAYS = <num> ]
[ COPY GRANTS ]
[ COMMENT = '<string_literal>' ]
```

## Show stages:

```
SHOW STAGES;
```

## Create a pipe:

```
CREATE [ OR REPLACE ] PIPE [ IF NOT EXISTS ]
[ AUTO_INGEST = [ TRUE | FALSE ] ]
[ AWS_SNS_TOPIC = ]
[ INTEGRATION = '' ]
[ COMMENT = '' ]
```

```
AS
```

## Show pipes:

```
SHOW PIPES [ LIKE '<pattern>' ]  
           [ IN { ACCOUNT | [ DATABASE ] <db_name> | [ SCHEMA ] <schema_name> } ]
```

## Create a storage integration:

```
CREATE STORAGE INTEGRATION <integration_name>  
  TYPE = EXTERNAL_STAGE  
  STORAGE_PROVIDER = S3  
  ENABLED = TRUE  
  STORAGE_AWS_ROLE_ARN = '<iam_role>'  
  STORAGE_ALLOWED_LOCATIONS = ('s3://<bucket>/<path>', 's3://<bucket>/<path>')  
  [ STORAGE_BLOCKED_LOCATIONS = ('s3://<bucket>/<path>', 's3://<bucket>/<path>') ]
```

## Example:

```
create storage integration s3_int  
  type = external_stage  
  storage_provider = s3  
  enabled = true  
  storage_aws_role_arn = 'arn:aws:iam::001234567890:role/myrole'  
  storage_allowed_locations = ('s3://amzn-s3-demo-bucket1/mypath1/', 's3://amzn-s3-  
demo-bucket2/mypath2/')  
  storage_blocked_locations = ('s3://amzn-s3-demo-bucket1/mypath1/sensitivedata/',  
's3://amzn-s3-demo-bucket2/mypath2/sensitivedata/');
```

For more information about this step, see [Configuring a Snowflake storage integration to access Amazon S3](#) from the Snowflake documentation.

## Describe an integration:

```
DESC INTEGRATION <integration_name>;
```

## S3 bucket policy:

```
{  
  "Version": "2012-10-17",
```

```
"Statement": [  
  {  
    "Effect": "Allow",  
    "Action": [  
      "s3:PutObject",  
      "s3:GetObject",  
      "s3:GetObjectVersion",  
      "s3:DeleteObject",  
      "s3:DeleteObjectVersion"  
    ],  
    "Resource": "arn:aws:s3:::/*"  
  },  
  {  
    "Effect": "Allow",  
    "Action": "s3:ListBucket",  
    "Resource": "arn:aws:s3:::",  
    "Condition": {  
      "StringLike": {  
        "s3:prefix": [  
          "/*"  
        ]  
      }  
    }  
  }  
]
```

# Automatically encrypt existing and new Amazon EBS volumes

Created by Tony DeMarco (AWS) and Josh Joy (AWS)

**Code repository:** <https://github.com/aws-samples/aws-system-manager-automation-unencrypted-to-encrypted-resources/tree/main/ebs>

**Environment:** Production

**Technologies:** Storage & backup; Security, identity, compliance; Management & governance

**AWS services:** AWS Config; Amazon EBS; AWS KMS; AWS Organizations; AWS Systems Manager

## Summary

Encryption of Amazon Elastic Block Store (Amazon EBS) volumes is important to an organization's data protection strategy. It is an important step in establishing a well-architected environment. Although there is no direct way to encrypt existing unencrypted EBS volumes or snapshots, you can encrypt them by creating a new volume or snapshot. For more information, see [Encrypt EBS resources](#) in the Amazon EC2 documentation. This pattern provides preventative and detective controls for encrypting your EBS volumes, both new and existing. In this pattern, you configure account settings, create automated remediation processes, and implement access controls.

## Prerequisites and limitations

### Prerequisites

- An active Amazon Web Services (AWS) account
- [AWS Command Line Interface \(AWS CLI\)](#), installed and configured on macOS, Linux, or Windows
- [jq](#), installed and configured on macOS, Linux, or Windows
- AWS Identity and Access Management (IAM) permissions are provisioned to have read and write access to AWS CloudFormation, Amazon Elastic Compute Cloud (Amazon EC2), AWS Systems Manager, AWS Config, and AWS Key Management Service (AWS KMS)



- AWS Organizations is configured with all features enabled, a requirement for service control policies
- AWS Config is enabled in the target accounts

## Limitations

- In your target AWS account, there must be no AWS Config rules named **encrypted-volumes**. This solution deploys a rule with this name. Preexisting rules with this name can cause the deployment to fail and result in unnecessary charges related to processing the same rule more than once.
- This solution encrypts all EBS volumes with the same AWS KMS key.
- If you enable encryption of EBS volumes for the account, this setting is Region-specific. If you enable it for an AWS Region, you cannot disable it for individual volumes or snapshots in that Region. For more information, see [Encryption by default](#) in the Amazon EC2 documentation.
- When you remediate existing, unencrypted EBS volumes, ensure that the EC2 instance is not in use. This automation shuts down the instance in order to detach the unencrypted volume and attach the encrypted one. There is downtime while the remediation is in progress. If this is a critical piece of infrastructure for your organization, make sure that [manual](#) or [automatic](#) high-availability configurations are in place so as to not impact the availability of any applications running on the instance. We recommend that you remediate critical resources only during standard maintenance windows.

## Architecture

### Automation workflow

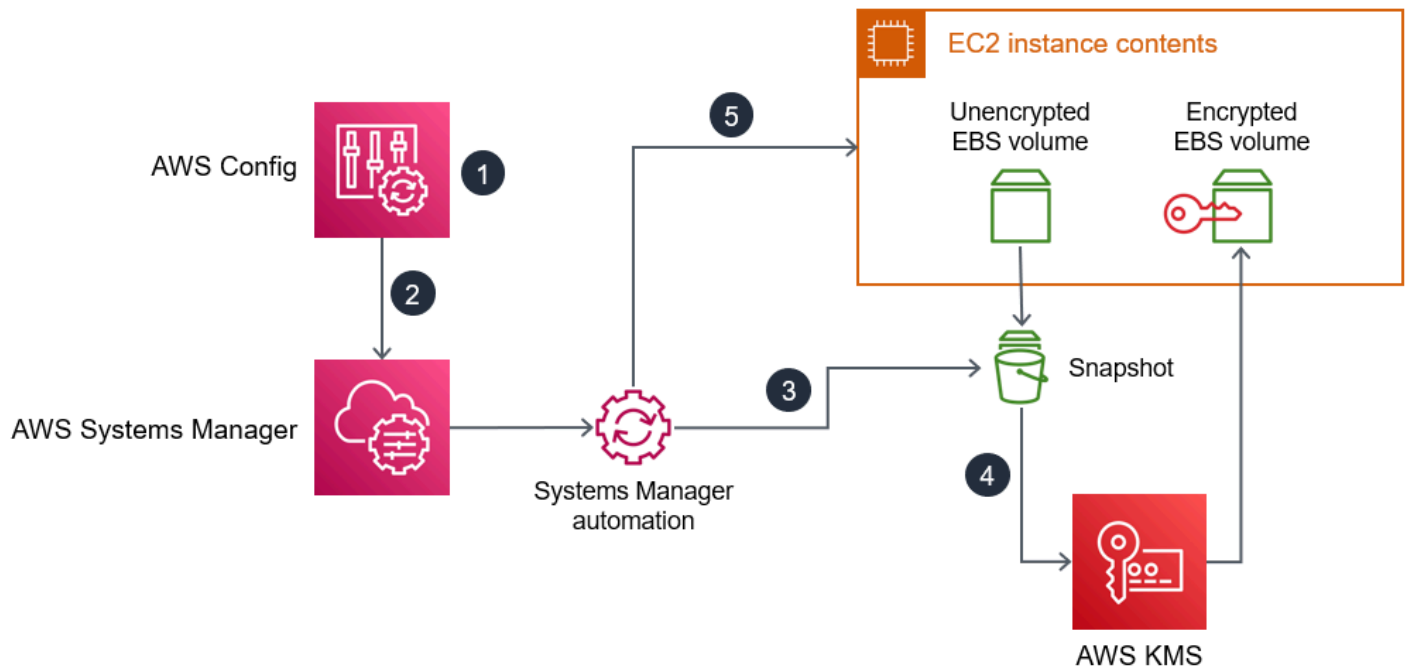

1. AWS Config detects an unencrypted EBS volume.
2. An administrator uses AWS Config to send a remediation command to Systems Manager.
3. The Systems Manager automation takes a snapshot of the unencrypted EBS volume.
4. The Systems Manager automation uses AWS KMS to create an encrypted copy of the snapshot.
5. The Systems Manager automation does the following:
  - a. Stops the affected EC2 instance if it is running
  - b. Attaches the new, encrypted copy of the volume to the EC2 instance
  - c. Returns the EC2 instance to its original state

## Tools

### AWS services

- [AWS CLI](#) – The AWS Command Line Interface (AWS CLI) provides direct access to the public application programming interfaces (APIs) of AWS services. You can explore a service's capabilities with the AWS CLI and develop shell scripts to manage your resources. In addition to the low-level API-equivalent commands, several AWS services provide customizations for the AWS CLI. Customizations can include higher-level commands that simplify using a service with a complex API.

- [AWS CloudFormation](#) – AWS CloudFormation is a service that helps you model and set up your AWS resources. You create a template that describes all the AWS resources that you want (such as Amazon EC2 instances), and CloudFormation provisions and configures those resources for you.
- [AWS Config](#) – AWS Config provides a detailed view of the configuration of AWS resources in your AWS account. This includes how the resources are related to one another and how they were configured in the past so that you can see how the configurations and relationships change over time.
- [Amazon EC2](#) – Amazon Elastic Compute Cloud (Amazon EC2) is a web service that provides resizable computing capacity that you use to build and host your software systems.
- [AWS KMS](#) – AWS Key Management Service (AWS KMS) is an encryption and key management service scaled for the cloud. AWS KMS keys and functionality are used by other AWS services, and you can use them to protect data in your AWS environment.
- [AWS Organizations](#) – AWS Organizations is an account management service that enables you to consolidate multiple AWS accounts into an organization that you create and centrally manage.
- [AWS Systems Manager Automation](#) – Systems Manager Automation simplifies common maintenance and deployment tasks for Amazon EC2 instances and other AWS resources.

## Other services

- [jq](#) – jq is a lightweight and flexible command-line JSON processor. You use this tool to extract key information from the AWS CLI output.

## Code

- The code for this pattern is available in the GitHub [Automatically remediate unencrypted EBS Volumes using customer KMS keys](#) repository.

## Epics

### Automate remediation of unencrypted volumes

Task	Description	Skills required
Download scripts and CloudFormation templates.	Download the shell script, JSON file, and CloudFormation templates from the GitHub <a href="#">Automatically remediate unencrypted EBS Volumes using customer KMS keys</a> repository.	AWS administrator, General AWS
Identify the administrator for the AWS KMS key.	<ol style="list-style-type: none"><li>1. Sign in to the AWS Management Console and open the IAM console at <a href="https://console.aws.amazon.com/iam/">https://console.aws.amazon.com/iam/</a>.</li><li>2. Identify a user or role who will be the AWS KMS key administrator. If a new user or role needs to be created for this purpose, create it now. For more information, see <a href="#">IAM Identities</a> in the IAM documentation. This automation creates a new AWS KMS key.</li><li>3. Once identified, copy the user's or role's Amazon Resource Name (ARN). For more information, see <a href="#">IAM ARNs</a> in the IAM documentation. You use this ARN in the next step.</li></ol>	AWS administrator, General AWS

Task	Description	Skills required
Deploy the Stack1 CloudFormation template.	<ol style="list-style-type: none"><li data-bbox="592 226 1027 405">1. Open the AWS CloudFormation console at <a href="https://console.aws.amazon.com/cloudformation/">https://console.aws.amazon.com/cloudformation/</a>.</li><li data-bbox="592 426 1027 1245">2. In CloudFormation, deploy the Stack1.yaml template. Note the following deployment details:<ul style="list-style-type: none"><li data-bbox="630 678 990 898">• Give the stack a clear and descriptive name. Note the stack name because you need this value in the next step.</li><li data-bbox="630 919 1024 1245">• Paste the ARN of the key administrator into the only parameter field in Stack1. This user or role becomes the administrator for the AWS KMS key created by the stack.</li></ul></li></ol> <p data-bbox="592 1325 1000 1591">For more information about deploying a CloudFormation template, see <a href="#">Working with AWS CloudFormation templates</a> in the CloudFormation documentation.</p>	AWS administrator, General AWS

Task	Description	Skills required
Deploy the Stack2 CloudFormation template.	<p>In CloudFormation, deploy the <code>Stack2.yaml</code> template. Note the following deployment details:</p> <ul style="list-style-type: none"><li>• Give the stack a clear and descriptive name.</li><li>• For the only parameter of Stack2, enter the name of the stack you created in the previous step. This allows Stack2 to reference the new AWS KMS key and role deployed by the stack in the previous step.</li></ul>	AWS administrator, General AWS
Create an unencrypted volume for testing.	<p>Create an EC2 instance with an unencrypted EBS volume. For instructions, see <a href="#">Create an Amazon EBS volume</a> in the Amazon EC2 documentation. The instance type does not matter, and access to the instance is not needed. You can create a <code>t2.micro</code> instance to stay in the free tier, and you don't need to create a key pair.</p>	AWS administrator, General AWS

Task	Description	Skills required
Test the AWS Config rule.	<ol style="list-style-type: none"><li>1. Open the AWS Config console at <a href="https://console.aws.amazon.com/config/">https://console.aws.amazon.com/config/</a>. On the <b>Rules</b> page, choose the <b>encrypted-volumes</b> rule.</li><li>2. Confirm that your new, unencrypted test instance appears in the list of non-compliant resources. If the volume does not appear immediately, wait a few minutes and refresh the results. The AWS Config rule detects the resource changes shortly after the instance and volume are created.</li><li>3. Select the resource, and then then choose <b>Remediate</b>.</li></ol> <p>You can view the remediation progress and status in Systems Manager as follows:</p> <ol style="list-style-type: none"><li>1. Open the AWS Systems Manager console at <a href="https://console.aws.amazon.com/systems-manager/">https://console.aws.amazon.com/systems-manager/</a>.</li><li>2. In the navigation pane, choose <b>Automation</b>.</li></ol>	AWS administrator, General AWS

Task	Description	Skills required
	3. Choose the <b>Execution ID</b> link to view the steps and the status.	
Configure additional accounts or AWS Regions.	As needed for your use case, repeat this epic for any additional accounts or AWS Regions.	AWS administrator, General AWS

### Enable account-level encryption of EBS volumes

Task	Description	Skills required
Run the enable script.	<ol style="list-style-type: none"> <li>1. In a bash shell, use the <code>cd</code> command to navigate into the cloned repository.</li> <li>2. Enter the following command to run the <code>enable-ebs-encryption-for-account</code> script.</li> </ol> <pre>./Bash/enable-ebs-encryption-for-account.sh</pre>	AWS administrator, General AWS, bash
Confirm the settings are updated.	<ol style="list-style-type: none"> <li>1. Open the Amazon EC2 console at <a href="https://console.aws.amazon.com/ec2/">https://console.aws.amazon.com/ec2/</a>.</li> <li>2. On the right side of the screen, under <b>Settings</b>,</li> </ol>	AWS administrator, General AWS



Task	Description	Skills required
	<p>choose <b>Data protection and security</b>.</p> <p>3. Under the <b>EBS encryption</b> section, confirm that <b>Always encrypt new EBS volumes</b> is turned on and that the <b>Default encryption key</b> is set to the ARN that you specified previously.</p> <p><b>Note:</b> If the <b>Always encrypt new EBS volumes</b> setting is turned off or the key is still set to <b>alias/aws/ebs</b>, confirm that you are logged into the same account and AWS Region where you ran the shell script, and check your shell for error messages.</p>	
Configure additional accounts or AWS Regions.	As needed for your use case, repeat this epic for any additional accounts or AWS Regions.	AWS administrator, General AWS

### Prevent creation of unencrypted instances

Task	Description	Skills required
Create a service control policy.	1. Open the AWS Organizations console at <a href="https://console.aws.amazon.com/organizations/v2/">https://console.aws.amazon.com/organizations/v2/</a> .	AWS administrator, General AWS

Task	Description	Skills required
	<ol style="list-style-type: none"><li data-bbox="591 212 997 485">2. Create a new service control policy. For more information, see <a href="#">Creating a service control policy</a> in the AWS Organizations documentation.</li><li data-bbox="591 506 997 831">3. Add the contents of DenyUnencryptedEC2.json to the policy and save it. You downloaded this JSON file from the GitHub repository in the first epic.</li><li data-bbox="591 852 1016 1266">4. Attach this policy to the organization root or any necessary organizational units (OUs). For more information, see <a href="#">Attaching and detaching service control policies</a> in the AWS Organizations documentation.</li></ol>	

## Related resources

### AWS service documentation

- [AWS CLI](#)
- [AWS Config](#)
- [AWS CloudFormation](#)
- [Amazon EC2](#)
- [AWS KMS](#)
- [AWS Organizations](#)

- [AWS Systems Manager Automation](#)

### Other resources

- [jq manual](#) (jq website)
- [jq download](#) (GitHub)

# Back up Sun SPARC servers in the Stromasys Charon-SSP emulator on the AWS Cloud

Created by Kevin Yung (AWS), Luis Ramos (Stromasys), and Rohit Darji (AWS)

**Environment:** Production

**Technologies:** Storage & backup; Operating systems; DevOps

**Workload:** Oracle

**AWS services:** Amazon EFS; Amazon S3; AWS Storage Gateway; AWS Systems Manager; Amazon EC2

## Summary

This pattern provides four options for backing up your Sun Microsystems SPARC servers after a migration from an on-premises environment to the Amazon Web Services (AWS) Cloud. These backup options help you to implement a backup plan that meets your organization's recovery point objective (RPO) and recovery time objective (RTO), uses automated approaches, and lowers your overall operational costs. The pattern provides an overview of the four backup options and steps to implement them.

If you use a Sun SPARC server hosted as a guest on a [Stromasys Charon-SSP emulator](#), you can use one of the following three backup options:

- **Backup option 1: Stromasys virtual tape** – Use the Charon-SSP virtual tape feature to set up a backup facility in the Sun SPARC server and archive your backup files to [Amazon Simple Storage Service \(Amazon S3\)](#) and [Amazon Simple Storage Service Glacier](#) using [AWS Systems Manager Automation](#).
- **Backup option 2: Stromasys snapshot** – Use the Charon-SSP snapshot feature to set up a backup facility for the Sun SPARC guest servers in Charon-SSP.
- **Backup option 3: Amazon Elastic Block Store (Amazon EBS) volume snapshot** – If you host the Charon-SSP emulator on Amazon Elastic Compute Cloud (Amazon EC2), you can use an [Amazon EBS volume snapshot](#) to create backups for a Sun SPARC file system.

If you use a Sun SPARC server hosted as a guest on hardware and Charon-SSP on Amazon EC2, you can use the following backup option:

- **Backup option 4: AWS Storage Gateway virtual tape library (VTL)** – Use a backup application with a [Storage Gateway](#) VTL Tape Gateway to back up the Sun SPARC servers.

If you use a Sun SPARC server hosted as a branded zone in a Sun SPARC server, you can use backup options 1, 2, and 4.

[Stromasys](#) provides software and services to emulate legacy SPARC, Alpha, VAX, and PA-RISC critical systems. For more information about migrating to the AWS Cloud using Stromasys emulation, see [Rehosting SPARC, Alpha, or other legacy systems to AWS with Stromasys](#) on the AWS Blog.

## Prerequisites and limitations

### Prerequisites

- An active AWS account.
- Existing Sun SPARC servers.
- Existing licenses for Charon-SSP. Licenses for Charon-SSP are available from AWS Marketplace and licenses for Stromasys Virtual Environment (VE) are available from Stromasys. For more information, contact [Stromasys sales](#).
- Familiarity with Sun SPARC servers and Linux backups.
- Familiarity with Charon-SSP emulation technology. For more information about this, see [Stromasys legacy server emulation](#) in the Stromasys documentation.
- If you want to use the virtual tape facility or backup applications for your Sun SPARC servers file systems, you must create and configure the backup facilities for the Sun SPARC server file system.
- An understanding of RPO and RTO. For more information about this, see [Disaster recovery objectives](#) from the [Reliability Pillar](#) whitepaper in the AWS Well-Architected Framework documentation.
- To use **Backup option 4**, you must have the following:
  - A software-based backup application that supports a Storage Gateway VTL Tape Gateway. For more information about this, see [Working with VTL devices](#) in the AWS Storage Gateway documentation.

- Bacula Director or a similar backup application, installed and configured. For more information about this, see the [Bacula Director](#) documentation.

The following table provides information about the four backup options in this pattern.

Backup options	Achieves crash consistency?	Achieves application consistency?	Virtual backup appliance solution?	Typical use cases
<b>Option 1</b> – <b>Stromasys virtual tape</b>	<b>Yes</b>  You can automate Sun SPARC file system snapshots to back up data in a virtual tape. For example, you can use UFS or ZFS snapshots.	<b>Yes</b>  This backup option requires an automated script to flush in-flight transactions, configure a read-only or temporary offline mode during the file system snapshot, or take an application data dump. You might also require application downtime or read-only mode.	<b>Yes</b>	Sun SPARC server file systems backup with .tar or .zip files  Application data backup
<b>Option 2</b> – <b>Stromasys snapshot</b>	<b>Yes</b>  You must configure <a href="#">Charon-SSP Manager</a> or use a command-	<b>Yes</b>  This backup option creates a snapshot of the emulated guest server, including	<b>No</b>	Sun SPARC server snapshot  Application data backup

line startup argument to enable this feature.

You must also run a Linux command to ask the Charon-SS P emulator to save the Sun SPARC guest server state into a snapshot file.

**Important:** You must shut down the Sun SPARC guest server.

its virtual disks and memory dump.

**Important**

: You must shut down the Sun SPARC guest server during the snapshot.

**Option 3**  
**– Amazon**  
**EBS volume**  
**snapshot****Yes**

You can use AWS Backup to automate the Amazon EBS snapshot.

**Yes**

This backup option requires an automated script to flush in-flight transactions and configure a read-only or temporary stop of the EC2 instance during the Amazon EBS volume snapshot.

**Important:**

This backup option might require application downtime or read-only mode to achieve application consistency.

**No**

Sun SPARC server file systems snapshot

Application data backup



<b>Option 4 – AWS Storage Gateway VTL</b>	<b>Yes</b> You can automatically back up Sun SPARC file system backup data to the VTL by using a backup agent.	<b>Yes</b> This backup option requires an automated script to flush in-flight transactions and configure a read-only or temporary offline mode during the file system snapshot or application data dump.  <b>Important:</b> This backup option might require application downtime or read-only mode.	<b>Yes</b>	A large fleet of Sun SPARC server file system backups  Application data backup
---	---	---	------------	--

## Limitations

- You can use this pattern's approaches to back up individual Sun SPARC servers, but you can also use these backup options for shared data if you have applications that run in a cluster.

## Tools

### Backup option 1: Stromasys virtual tape

- [Stromasys Charon-SSP emulator](#) – Charon-SSP emulator creates the virtual replica of the original SPARC hardware inside a standard 64-bit x86 compatible computer system. It runs the original SPARC binary code, including operating systems (OSs) such as SunOS or Solaris, their layered products, and applications.

- [Amazon EC2](#) – Amazon Elastic Compute Cloud (Amazon EC2) is a web service that provides resizable computing capacity that you use to build and host your software systems.
- [Amazon EFS](#) – Amazon Elastic File System (Amazon EFS) provides a simple, serverless, set-and-forget elastic file system for use with AWS Cloud services and on-premises resources.
- [Amazon S3](#) – Amazon Simple Storage Service (Amazon S3) is storage for the internet.
- [Amazon S3 Glacier](#) – Amazon Simple Storage Service Glacier is a secure, durable, and extremely low-cost Amazon S3 storage class for data archiving and long-term backup.
- [AWS Systems Manager Automation](#) – Automation, a capability of AWS Systems Manager, simplifies common maintenance and deployment tasks of EC2 instances and other AWS resources.

### Backup option 2: Stromasys snapshot

- [Stromasys Charon-SSP emulator](#) – Charon-SSP emulator creates the virtual replica of the original SPARC hardware inside a standard 64-bit x86 compatible computer system. It runs the original SPARC binary code, including OSs such as SunOS or Solaris, their layered products, and applications.
- [Amazon EC2](#) – Amazon Elastic Compute Cloud (Amazon EC2) is a web service that provides resizable computing capacity that you use to build and host your software systems.
- [Amazon EFS](#) – Amazon Elastic File System (Amazon EFS) provides a simple, serverless, set-and-forget elastic file system for use with AWS Cloud services and on-premises resources.
- [Amazon S3](#) – Amazon Simple Storage Service (Amazon S3) is storage for the internet.
- [Amazon S3 Glacier](#) – Amazon Simple Storage Service Glacier is a secure, durable, and extremely low-cost Amazon S3 storage class for data archiving and long-term backup.
- [AWS Systems Manager Automation](#) – Automation, a capability of AWS Systems Manager, simplifies common maintenance and deployment tasks of EC2 instances and other AWS resources.

### Backup option 3: Amazon EBS volume snapshot

- [Stromasys Charon-SSP emulator](#) – Charon-SSP emulator creates the virtual replica of the original SPARC hardware inside a standard 64-bit x86 compatible computer system. It runs the

original SPARC binary code, including OSs such as SunOS or Solaris, their layered products, and applications.

- [AWS Backup](#) – AWS Backup is a fully-managed data protection service that makes it easy to centralize and automate across AWS services, in the cloud, and on premises.
- [Amazon EBS](#) – Amazon Elastic Block Store (Amazon EBS) provides block level storage volumes for use with EC2 instances.
- [Amazon EC2](#) – Amazon Elastic Compute Cloud (Amazon EC2) is a web service that provides resizable computing capacity that you use to build and host your software systems.

#### Backup option 4: AWS Storage Gateway VTL

- [Stromasys Charon-SSP emulator](#) – Charon-SSP emulator creates the virtual replica of the original SPARC hardware inside a standard 64-bit x86 compatible computer system. It runs the original SPARC binary code, including OSs such as SunOS or Solaris, their layered products, and applications.
- [Bacula](#) – Bacula is an open-source, enterprise-level computer backup system. For more information about whether your existing backup application supports Tape Gateway, see [Supported third-party backup applications for a Tape Gateway](#) in the AWS Storage Gateway documentation.
- [Amazon EC2](#) – Amazon Elastic Compute Cloud (Amazon EC2) is a web service that provides resizable computing capacity that you use to build and host your software systems.
- [Amazon RDS for MySQL](#) – Amazon Relational Database Service (Amazon RDS) supports DB instances running several versions of MySQL.
- [Amazon S3](#) – Amazon Simple Storage Service (Amazon S3) is storage for the internet.
- [Amazon S3 Glacier](#) – Amazon Simple Storage Service Glacier is a secure, durable, and extremely low-cost Amazon S3 storage class for data archiving and long-term backup.
- [AWS Storage Gateway](#) – Storage Gateway connects an on-premises software appliance with cloud-based storage to provide seamless integration with data security features between your on-premises IT environment and the AWS storage infrastructure.

## Epics

### Backup option 1 – Create a Stromasys virtual tape backup

Task	Description	Skills required
<p>Create an Amazon EFS shared file system for virtual tape file storage.</p>	<p>Sign in to the AWS Management Console or use AWS CLI to create an Amazon EFS file system.</p> <p>For more information about this, see <a href="#">Create an Amazon EFS file system</a> in the Amazon EFS documentation.</p>	<p>Cloud architect</p>
<p>Configure the Linux host to mount the shared file system.</p>	<p>Install the Amazon EFS driver on the Amazon EC2 Linux instance and configure the Linux OS to mount the Amazon EFS shared file system during startup.</p> <p>For more information about this, see <a href="#">Mounting file systems using the EFS mount helper</a> in the Amazon EFS documentation.</p>	<p>DevOps engineer</p>
<p>Install the Charon-SSP emulator.</p>	<p>Install the Charon-SSP emulator on the Amazon EC2 Linux instance.</p> <p>For more information about this, see <a href="#">Setting up an AWS Cloud instance for Charon-SSP</a> in the Stromasys documentation.</p>	<p>DevOps engineer</p>

Task	Description	Skills required
Create a virtual tape file container in the shared file system for each Sun SPARC guest server.	Run the touch <vtape-container-name> command to create a virtual tape file container in the shared file system for each Sun SPARC guest server deployed in the Charon-SSP emulator.	DevOps engineer
Configure Charon-SSP Manager to create virtual tape devices for the Sun SPARC guest servers.	<p>Log in to Charon-SSP Manager, create virtual tape devices, and configure them to use the virtual tape container files for each Sun SPARC guest server.</p> <p>For more information about this, see the <a href="#">Charon-SSP 5.2 for Linux user guide</a> in the Stromasys documentation.</p>	DevOps engineer
Validate that the virtual tape device is available in the Sun SPARC guest servers.	Log in to each Sun SPARC guest server and run the <code>mt -f /dev/rmt/1</code> command to validate that the virtual tape device is configured in the OS.	DevOps engineer

Task	Description	Skills required
Develop the Systems Manager Automation runbook and automation.	<p>Develop the Systems Manager Automation runbook and set up maintenance windows and associations in Systems Manager for scheduling the backup process.</p> <p>For more information about this, see <a href="#">Automation walkthroughs</a> and <a href="#">Setting up maintenance windows</a> in the AWS Systems Manager documentation.</p>	Cloud architect
Configure Systems Manager Automation to archive rotated virtual tape container files.	<p>Use the code sample from <b>Back option 1</b> in the <i>Additional information</i> section to develop a Systems Manager Automation runbook to archive rotated virtual tape container files to Amazon S3 and Amazon S3 Glacier.</p>	Cloud architect
Deploy the Systems Manager Automation runbook for archiving and scheduling.	<p>Deploy the Systems Manager Automation runbook and schedule it to automatically run in Systems Manager.</p> <p>For more information about this, see <a href="#">Automation walkthroughs</a> in the Systems Manager documentation.</p>	Cloud architect

## Backup option 2 – Create a Stromasys snapshot

Task	Description	Skills required
<p>Create an Amazon EFS shared file system for virtual tape file storage.</p>	<p>Sign in to the AWS Management Console or use AWS CLI to create an Amazon EFS file system.</p> <p>For more information about this, see <a href="#">Create your Amazon EFS file system</a> in the Amazon EFS documentation.</p>	<p>Cloud architect</p>
<p>Configure the Linux host to mount the shared file system.</p>	<p>Install the Amazon EFS driver in the Amazon EC2 Linux instance and configure the Linux OS to mount the Amazon EFS shared file system during startup.</p> <p>For more information about this, see <a href="#">Mounting file systems using the EFS mount helper</a> in the Amazon EFS documentation.</p>	<p>DevOps engineer</p>
<p>Install the Charon-SSP emulator.</p>	<p>Install the Charon-SSP emulator on the Amazon EC2 Linux instance.</p> <p>For more information about this, see <a href="#">Setting up an AWS Cloud instance for Charon-SSP</a> in the Stromasys documentation.</p>	<p>DevOps engineer</p>

Task	Description	Skills required
Configure the Sun SPARC guest servers to start up with the snapshot option.	<p>Use Charon-SSP Manager to set up the snapshot option for each Sun SPARC guest servers.</p> <p>For more information about this, see the <a href="#">Charon-SSP 5.2 for Linux user guide</a> in the Stromasys documentation.</p>	DevOps engineer
Develop the Systems Manager Automation runbook.	<p>Use the code sample from <b>Backup option 2</b> in the <i>Additional information</i> section to develop a Systems Manager Automation runbook to remotely run the snapshot command on a Sun SPARC guest server during a maintenance window.</p>	Cloud architect
Deploy the Systems Manager Automation runbook and set up the association to the Amazon EC2 Linux hosts.	<p>Deploy the Systems Manager Automation runbook and set up maintenance windows and associations in Systems Manager for scheduling the backup process.</p> <p>For more information about this, see <a href="#">Automation walkthroughs</a> and <a href="#">Setting up Maintenance Windows</a> in the AWS Systems Manager documentation.</p>	Cloud architect



Task	Description	Skills required
Archive snapshots into long-term storage.	Use the runbook sample code from the <i>Additional information</i> section to develop a Systems Manager Automation runbook to archive snapshot files to Amazon S3 and Amazon S3 Glacier.	Cloud architect

### Backup option 3 – Create an Amazon EBS volume snapshot

Task	Description	Skills required
Install the Charon-SSP emulator.	<p>Install the Charon-SSP emulator on the Amazon EC2 Linux instance.</p> <p>For more information about this, see <a href="#">Setting up an AWS Cloud instance for Charon-SSP</a> in the Stromasys documentation.</p>	DevOps engineer
Create EBS volumes for the Sun SPRAC guest servers.	<p>Sign in to the AWS Management Console, open the Amazon EBS console, and then create EBS volumes for the Sun SPRAC guest servers.</p> <p>For more information about this, see <a href="#">Setting up an AWS Cloud instance for Charon-SSP</a> in the Stromasys documentation.</p>	Cloud architect

Task	Description	Skills required
Attach the EBS volumes to the Amazon EC2 Linux instance.	<p>On the Amazon EC2 console, attach the EBS volumes to the Amazon EC2 Linux instance.</p> <p>For more information about this, see <a href="#">Attach an Amazon EBS volume to an instance</a> in the Amazon EC2 documentation.</p>	AWS DevOps
Map EBS volumes as SCSI drives in the Charon-SSP emulator.	<p>Configure Charon-SSP Manager to map the EBS volumes as SCSI drives in the Sun SPARC guest servers.</p> <p>For more information about this, see the <i>SCSI storage configuration</i> section of the <a href="#">Charon-SSP V5.2 for Linux</a> guide in the Stromasys documentation.</p>	AWS DevOps
Configure the AWS Backup schedule for snapshotting the EBS volumes.	<p>Set up AWS Backup policy and schedules to snapshot the EBS volumes.</p> <p>For more information about this, see the <a href="#">Amazon EBS backup and restore using AWS Backup</a> tutorial in the AWS Developer Center documentation.</p>	AWS DevOps

## Backup option 4 – Create an AWS Storage Gateway VTL

Task	Description	Skills required
<p>Create a Tape Gateway device.</p>	<p>Sign in to the AWS Management Console, open the AWS Storage Gateway console, and then create a Tape Gateway device in a VPC.</p> <p>For more information about this, see <a href="#">Creating a gateway</a> in the AWS Storage Gateway documentation.</p>	<p>Cloud architect</p>
<p>Create an Amazon RDS DB instance for the Bacula Catalog.</p>	<p>Open the Amazon RDS console and create an Amazon RDS for MySQL DB instance.</p> <p>For more information about this, see <a href="#">Creating a MySQL DB instance and connecting to a database on a MySQL DB instance</a> in the Amazon RDS documentation.</p>	<p>Cloud architect</p>
<p>Deploy the backup application on controller in the VPC.</p>	<p>Install Bacula on the EC2 instance, deploy the backup application controller, and then configure the backup storage to connect with the Tape Gateway device. You can use the sample Bacula Director storage daemon configuration in the Bacula-</p>	<p>AWS DevOps</p>

Task	Description	Skills required
	<p>storage-daemon-config.txt file (attached).</p> <p>For more information about this, see the <a href="#">Bacula documentation</a>.</p>	
Set up backup application on the Sun SPARC guest servers.	Set up a second client to install and set up the backup application on the Sun SPARC guest servers by using the sample Bacula configuration in the SUN-SPARC-Guest-Bacula-Config.txt file (attached).	DevOps engineer
Set up the backup configuration and schedule.	<p>Set up backup configuration and schedules in the backup application controller by using the sample Bacula Director configuration in the Bacula-Directory-Config.txt file (attached).</p> <p>For more information about this, see the <a href="#">Bacula documentation</a>.</p>	DevOps engineer

Task	Description	Skills required
Validate that the backup configuration and schedules are correct.	<p>Follow the instruction from the <a href="#">Bacula documentation</a> to perform the validation and backup testing for your setup in the Sun SPARC guest servers.</p> <p>For example, you can use the following commands to validate the configuration files:</p> <ul style="list-style-type: none"><li>• <code>bacula-dir -t -c bacula-dir.conf</code></li><li>• <code>bacula-fd -t -c bacula-fd.conf</code></li><li>• <code>bacula-sd -t -c bacula-sd.conf</code></li></ul>	DevOps engineer

## Related resources

- [Charon virtual SPARC with VE licensing](#)
- [Charon virtual SPARC](#)
- [Using cloud services and object storage with Bacula Enterprise Edition](#)
- [Disaster recovery \(DR\) objectives](#)
- [Charon legacy system emulation solutions](#)

## Additional information

### Backup option 1 – Create a Stromasys virtual tape

You can use the following sample Systems Manager Automation runbook code to automatically start the backup and then swap the tapes:

```

...
# example backup script saved in SUN SPARC Server
#!/usr/bin/bash
mt -f rewind
tar -cvf
mt -f offline
...

mainSteps:
- action: aws:runShellScript
  name:
  inputs:
    onFailure: Abort
    timeoutSeconds: "1200"
    runCommand:
      - |
        # Validate tape backup container file exists
        if [ ! -f {{TapeBackupContainerFile}} ]; then
          logger -s -p local3.warning "Tape backup container file is not exists
- {{TapeBackupContainerFile}}, create a new one"
          touch {{TapeBackupContainerFile}}
        fi
      - action: aws:runShellScript
        name: startBackup
        inputs:
          onFailure: Abort
          timeoutSeconds: "1200"
          runCommand:
            - |
              user={{BACKUP_USER}}
              keypair={{KEYPAIR_PATH}}
              server={{SUN_SPARC_IP}}
              backup_script={{BACKUP_SCRIPT}}
              ssh -i $keypair $user@$server -c "/usr/bin/bash $backup_script"
            - action: aws:runShellScript
              name: swapVirtualDiskContainer
              inputs:
                onFailure: Abort
                timeoutSeconds: "1200"
                runCommand:
                  - |
                    mv {{TapeBackupContainerFile}} {{TapeBackupContainerFile}}.$(date +%s)
                    touch {{TapeBackupContainerFile}}
            - action: aws:runShellScript

```

```

name: uploadBackupArchiveToS3
inputs:
  onFailure: Abort
  timeoutSeconds: "1200"
  runCommand:
  - |
    aws s3 cp {{TapeBackupContainerFile}} s3://{{BACKUP_BUCKET}}/
    {{SUN_SPARC_IP}}/$(date '+%Y-%m-%d')/
    ...

```

## Backup option 2 – Stromasys snapshot

You can use the following sample Systems Manager Automation runbook code to automate the backup process:

```

...

mainSteps:
- action: aws:runShellScript
  name: startSnapshot
  inputs:
    onFailure: Abort
    timeoutSeconds: "1200"
    runCommand:
    - |
      # You may consider some graceful stop of the application before taking a
      snapshot
      # Query SSP PID by configuration file
      # Example: ps ax | grep ssp-4 | grep Solaris10.cfg | awk '{print $1"
"$5}' | grep ssp4 | cut -f1 -d" "
      pid=`ps ax | grep ssp-4 | grep {{SSP_GUEST_CONFIG_FILE}} | awk '{print
$1" "$5}' | grep ssp4 | cut -f1 -d" "`
      if [ -n "${pid}" ]; then
        kill -SIGTSTP ${pid}
      else
        echo "No PID found for SPARC guest with config
{{SSP_GUEST_CONFIG_FILE}}"
        exit 1
      fi
    - action: aws:runShellScript
      name: startBackup
      inputs:
        onFailure: Abort

```

```

        timeoutSeconds: "1200"
        runCommand:
        - |
          # upload snapshot and virtual disk files into S3
          aws s3 sync {{SNAPSHOT_FOLDER}} s3://{{BACKUP_BUCKET}}/$(date '+%Y-%m-%d')/
          aws s3 cp {{VIRTUAL_DISK_FILE}} s3://{{BACKUP_BUCKET}}/$(date '+%Y-%m-%d')/
    - action: aws:runShellScript
      name: restratSPARCGuest
      inputs:
        onFailure: Abort
        timeoutSeconds: "1200"
        runCommand:
        - |
          /opt/charon-ssp/ssp-4u/ssp4u -f {{SSP_GUEST_CONFIG_FILE}} -d -a
          {{SPARC_GUEST_NAME}} --snapshot {{SNAPSHOT_FOLDER}}
    ...

```

## Backup option 4 – AWS Storage Gateway VTL

If you use Solaris non-global zones to run virtualized legacy Sun SPARC servers, the backup application approach can be applied to non-global zones running in the Sun SPARC servers (for example, the backup client can run inside the non-global zones). However, the backup client can also run in the Solaris host and take snapshots of the non-global zones. The snapshots can then be backed up on a tape.

The following sample configuration adds the file system that hosts the Solaris non-global zones into the backup configuration for the Solaris host:

```

FileSet {
  Name = "Branded Zones"
  Include {
    Options {
      signature = MD5
    }
    File = /zones
  }
}

```



## Attachments

To access additional content that is associated with this document, unzip the following file:

[attachment.zip](#)

# Back up and archive data to Amazon S3 with Veeam Backup & Replication

Created by Jeanna James, Anthony Fiore (AWS) (AWS), and William Quigley

**Environment:** Production

**Technologies:** Storage & backup

**AWS services:** Amazon EC2; Amazon S3; Amazon S3 Glacier

## Summary

This pattern details the process for sending backups created by Veeam Backup & Replication to supported Amazon Simple Storage Service (Amazon S3) object storage classes by using the Veeam scale-out backup repository capability.

Veeam supports multiple Amazon S3 storage classes to best fit your specific needs. You can choose the type of storage based on the data access, resiliency, and cost requirements of your backup or archive data. For example, you can store data that you don't plan to use for 30 days or longer in Amazon S3 infrequent access (IA) for lower cost. If you're planning to archive data for 90 days or longer, you can use Amazon Simple Storage Service Glacier (Amazon S3 Glacier) Flexible Retrieval or S3 Glacier Deep Archive with Veeam's archive tier. You can also use S3 Object Lock to make backups immutable within Amazon S3.

This pattern doesn't cover how to set up Veeam Backup & Replication with a tape gateway in AWS Storage Gateway. For information about that topic, see [Veeam Backup & Replication using AWS VTL Gateway - Deployment Guide](#) on the Veeam website.

**Warning:** This scenario requires IAM users with programmatic access and long-term credentials, which present a security risk. To help mitigate this risk, we recommend that you provide these users with only the permissions they require to perform the task and that you remove these users when they are no longer needed. Access keys can be updated if necessary. For more information, see [Updating access keys](#) in the *IAM User Guide*.

## Prerequisites and limitations

### Prerequisites

- Veeam Backup & Replication, including Veeam Availability Suite or Veeam Backup Essentials, installed (you can register for a [free trial](#))
- Veeam Backup & Replication license with Enterprise or Enterprise Plus functionality, which includes Veeam Universal License (VUL)
- An active AWS Identity and Access Management (IAM) user with access to an Amazon S3 bucket
- An active IAM user with access to Amazon Elastic Compute Cloud (Amazon EC2) and Amazon Virtual Private Cloud (Amazon VPC) (if utilizing archive tier)
- Network connectivity from on premises to AWS services with available bandwidth for backup and restore traffic through a public internet connection or an AWS Direct Connect public virtual interface (VIF)
- The following network ports and endpoints opened to ensure proper communication with object storage repositories:
  - Amazon S3 storage – TCP – port 443: Used to communicate with Amazon S3 storage.
  - Amazon S3 storage – cloud endpoints – \*.amazonaws.com for AWS Regions and the AWS GovCloud (US) Regions, or \*.amazonaws.com.cn for China Regions: Used to communicate with Amazon S3 storage. For a complete list of connection endpoints, see [Amazon S3 endpoints](#) in the AWS documentation.
  - Amazon S3 storage – TCP HTTP – port 80: Used to verify certificate status. Consider that certificate verification endpoints—certificate revocation list (CRL) URLs and Online Certificate Status Protocol (OCSP) servers—are subject to change. The actual list of addresses can be found in the certificate itself.
  - Amazon S3 storage – certificate verification endpoints – \*.amazontrust.com: Used to verify certificate status. Consider that certificate verification endpoints (CRL URLs and OCSP servers) are subject to change. The actual list of addresses can be found in the certificate itself.

### Limitations

- Veeam doesn't support S3 Lifecycle policies on any S3 buckets that are used as Veeam object storage repositories. These include policies with Amazon S3 storage class transitions and S3 Lifecycle expiration rules. Veeam **must** be the sole entity that manages these objects. Enabling S3 Lifecycle policies might have unexpected results, including data loss.

## Product versions

- Veeam Backup & Replication v9.5 Update 4 or later (backup only or capacity tier)
- Veeam Backup & Replication v10 or later (backup or capacity tier and S3 Object Lock)
- Veeam Backup & Replication v11 or later (backup or capacity tier, archive or archive tier, and S3 Object Lock)
- Veeam Backup & Replication v12 or later (performance tier, backup or capacity tier, archive or archive tier, and S3 Object Lock)
- S3 Standard
- S3 Standard-IA
- S3 One Zone-IA
- S3 Glacier Flexible Retrieval (v11 and later only)
- S3 Glacier Deep Archive (v11 and later only)
- S3 Glacier Instant Retrieval (v12 and later only)

## Architecture

### Source technology stack

- On-premises Veeam Backup & Replication installation with connectivity from a Veeam backup server or a Veeam gateway server to Amazon S3

### Target technology stack

- Amazon S3
- Amazon VPC and Amazon EC2 (if using archive tier)

### Target architecture: SOBR

The following diagram shows the scale-out backup repository (SOBR) architecture.

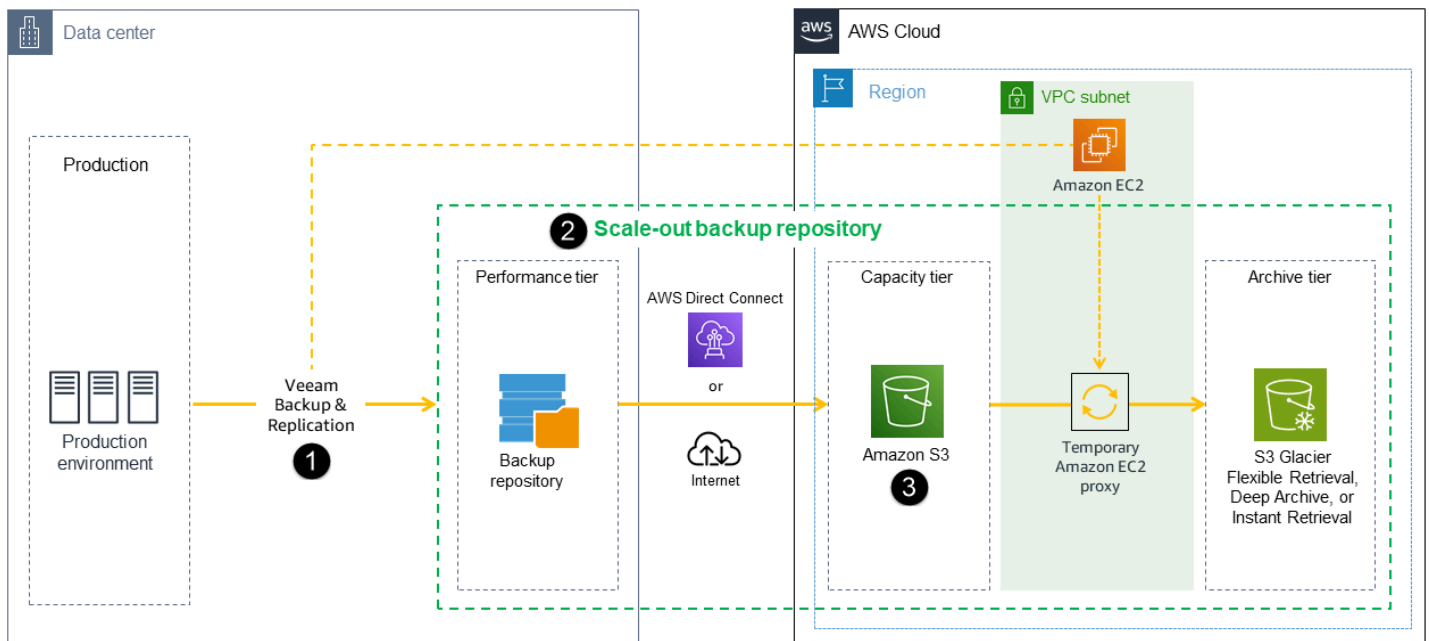

Veeam Backup and Replication software protects data from logical errors such as system failures, application errors, or accidental deletion. In this diagram, backups are run on premises first, and a secondary copy is sent directly to Amazon S3. A backup represents a point-in-time copy of the data.

The workflow consists of three primary components that are required for tiering or copying backups to Amazon S3, and one optional component:

- Veeam Backup & Replication (1) – The backup server that is responsible for coordinating, controlling, and managing backup infrastructure, settings, jobs, recovery tasks, and other processes.
- Veeam gateway server (not shown in the diagram) – An optional on-premises gateway server that is required if the Veeam backup server doesn't have outbound connectivity to Amazon S3.
- Scale-out backup repository (2) – Repository system with horizontal scaling support for multi-tier storage of data. The scale-out backup repository consists of one or more backup repositories that provide fast access to data and can be expanded with Amazon S3 object storage repositories for long-term storage (capacity tier) and archiving (archive tier). Veeam uses the scale-out backup repository to tier data automatically between local (performance tier) and Amazon S3 object storage (capacity and archive tiers).
- Amazon S3 (3) – AWS object storage service that offers scalability, data availability, security, and performance.

## Target architecture: DTO

The following diagram shows the direct-to-object (DTO) architecture.

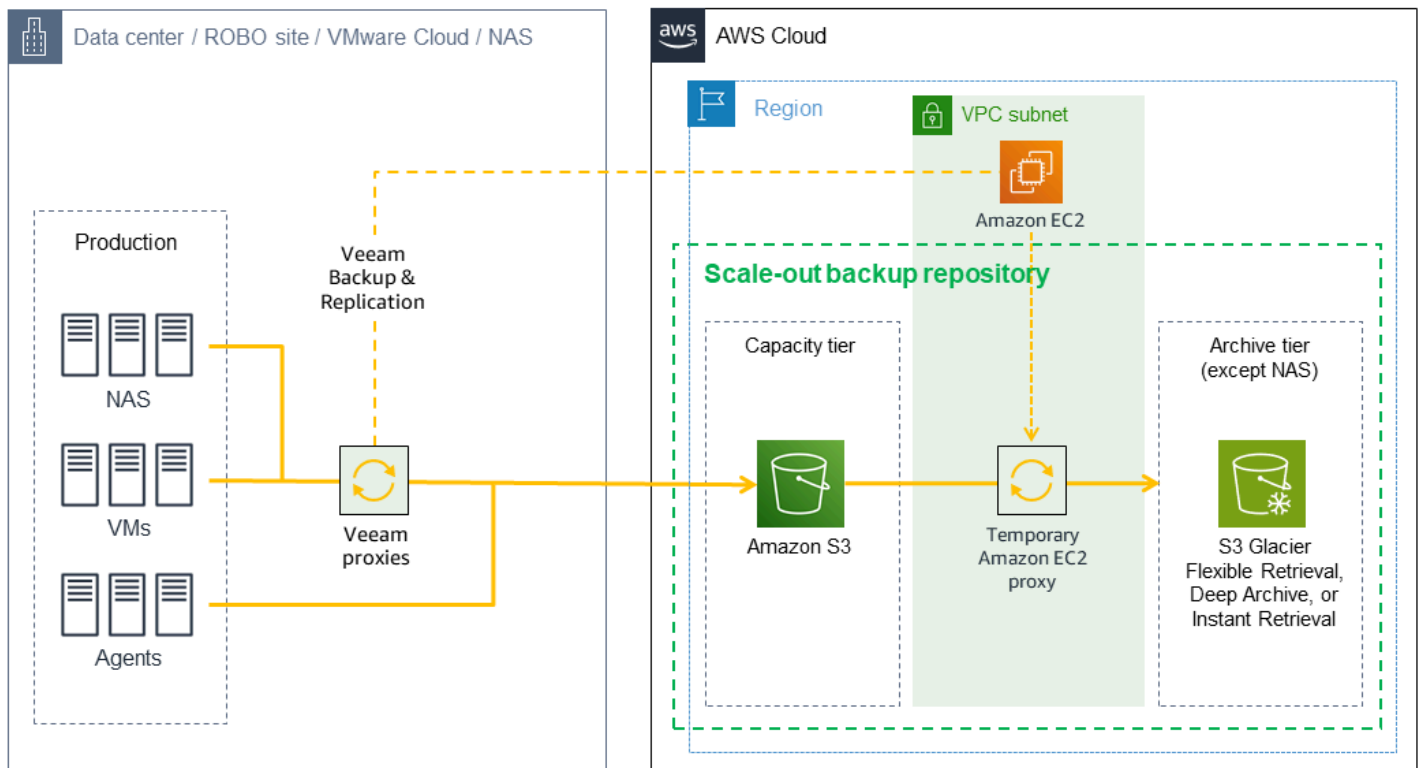

In this diagram, backup data goes directly to Amazon S3 without being stored on premises first. Secondary copies can be stored in S3 Glacier.

### Automation and scale

You can automate the creation of IAM resources and S3 buckets by using the AWS CloudFormation templates provided in the [VeeamHub GitHub repository](#). The templates include both standard and immutable options.

## Tools

### Tools and AWS services

- [Veeam Backup & Replication](#) is a solution from Veeam for protecting, backing up, replicating, and restoring your virtual and physical workloads.
- [AWS CloudFormation](#) helps you model and set up your AWS resources, provision them quickly and consistently, and manage them throughout their lifecycle. You can use a template to

describe your resources and their dependencies, and launch and configure them together as a stack, instead of managing resources individually. You can manage and provision stacks across multiple AWS accounts and AWS Regions.

- [Amazon Elastic Compute Cloud \(Amazon EC2\)](#) provides scalable computing capacity in the AWS Cloud. You can use Amazon EC2 to launch as many or as few virtual servers as you need, and you can scale out or scale in.
- [AWS Identity and Access Management \(IAM\)](#) is a web service for securely controlling access to AWS services. With IAM, you can centrally manage users, security credentials such as access keys, and permissions that control which AWS resources users and applications can access.
- [Amazon Simple Storage Service \(Amazon S3\)](#) is an object storage service. You can use Amazon S3 to store and retrieve any amount of data at any time, from anywhere on the web.
- [Amazon S3 Glacier \(S3 Glacier\)](#) is a secure and durable service for low-cost data archiving and long-term backup.
- [Amazon Virtual Private Cloud \(Amazon VPC\)](#) provisions a logically isolated section of the AWS Cloud where you can launch AWS resources in a virtual network that you've defined. This virtual network closely resembles a traditional network that you'd operate in your own data center, with the benefits of using the scalable infrastructure of AWS.

## Code

Use the CloudFormation templates provided in the [VeeamHub GitHub repository](#) to automatically create the IAM resources and S3 buckets for this pattern. If you prefer to create these resources manually, follow the steps in the *Epics* section.

## Best practices

- In accordance with IAM best practices, we strongly recommend that you regularly rotate long-term IAM user credentials, such as the IAM user that you use for writing Veeam Backup & Replication backups to Amazon S3. For more information, see [Security best practices](#) in the IAM documentation.

# Epics

## Configure Amazon S3 storage in your account

Task	Description	Skills required
Create an IAM user.	<p>Follow the <a href="#">instructions in the IAM documentation</a> to create an IAM user. This user should not have AWS console access, and you will need to create an access key for this user. Veeam uses this entity to authenticate with AWS to read and write to your S3 buckets. You must grant least privilege (that is, grant only the permissions required to perform a task) so the user doesn't have more authority than it needs. For example IAM policies to attach to your Veeam IAM user, see the <a href="#">Additional information</a> section.</p> <p><b>Note</b> Alternatively, you can use the CloudFormation templates provided in the <a href="#">VeeamHub GitHub repository</a> to create an IAM user and S3 bucket for this pattern.</p>	AWS administrator
Create an S3 bucket.	<ol style="list-style-type: none"><li>1. Sign in to the AWS Management Console and open the Amazon</li></ol>	AWS administrator



Task	Description	Skills required
	<p>S3 console at <a href="https://console.aws.amazon.com/s3/">https://console.aws.amazon.com/s3/</a>.</p> <p>2. If you don't already have an existing S3 bucket to use as the target storage, choose <b>Create bucket</b>, and specify a bucket name, AWS Region, and bucket settings.</p> <ul style="list-style-type: none"><li>• We recommend that you enable the <a href="#">Block Public Access option</a> for the S3 bucket and set up the access and user permission policies to meet your organization's requirements. For an example, see the <a href="#">Amazon S3 documentation</a>.</li><li>• We recommend that you enable <a href="#">S3 Object Lock</a>, even if you don't intend to use it right away. This setting can be enabled only at the time of S3 bucket creation.</li></ul> <p>For more information, see <a href="#">Creating a bucket</a> in the Amazon S3 documentation.</p>	

## Add Amazon S3 and S3 Glacier Flexible Retrieval (or S3 Glacier Deep Archive) to Veeam Backup & Replication

Task	Description	Skills required
<p>Launch the New Object Repository wizard.</p>	<p>Before you set up the object storage and scale-out backup repositories in Veeam, you must add the Amazon S3 and Amazon S3 Glacier storage repositories that you want to use for the capacity and archive tiers. In the next epic, you'll connect these storage repositories to your scale-out backup repository.</p> <ol style="list-style-type: none"> <li>1. On the Veeam console, open the <b>Backup Infrastructure</b> view.</li> <li>2. In the inventory pane, choose the <b>Backup Repositories</b> node, and then choose <b>Add Repository</b>.</li> <li>3. In the <b>Add Backup Repository</b> dialog box, choose <b>Object Storage, Amazon S3</b>.</li> </ol>	<p>AWS administrator, App owner</p>
<p>Add Amazon S3 storage for the capacity tier.</p>	<ol style="list-style-type: none"> <li>1. In the <b>Amazon Cloud Storage Services</b> dialog box, choose <b>Amazon S3</b>.</li> <li>2. At the <b>Name</b> step of the wizard, specify the object storage name and a brief</li> </ol>	<p>AWS administrator, App owner</p>

Task	Description	Skills required
	<p>description, such as the creator and creation date.</p> <p>3. At the <b>Account</b> step of the wizard, specify the object storage account.</p> <ul style="list-style-type: none"><li>• For <b>Credentials</b>, choose the IAM user that you created in the first epic to access your Amazon S3 object storage.</li><li>• For <b>AWS region</b>, choose the AWS Region where the Amazon S3 bucket is located.</li></ul> <p>4. At the <b>Bucket</b> step of the wizard, specify object storage settings.</p> <ul style="list-style-type: none"><li>• For <b>Data center region</b>, choose the AWS Region where the Amazon S3 bucket is located.</li><li>• For <b>Bucket</b>, choose the S3 bucket that you created in the first epic.</li><li>• For <b>Folder</b>, create or select a cloud folder to map your object storage repository to.</li><li>• If you want to enable immutability, choose <b>Make recent backups immutable for X days</b> and set the period</li></ul>	

Task	Description	Skills required
	<p>of time during which your backups should be locked. Note that enabling immutability results in increased costs because of the increased number of API calls to Amazon S3 from Veeam.</p> <p>5. At the <b>Summary</b> step of the wizard, review the configuration information, and then choose <b>Finish</b>.</p>	

Task	Description	Skills required
Add S3 Glacier storage for the archive tier.	<p>If you want to create an archive tier, use the IAM permissions detailed in the <a href="#">Additional information</a> section.</p> <ol style="list-style-type: none"><li>1. Launch the New Object Repository wizard as described previously.</li><li>2. In the <b>Amazon Cloud Storage Services</b> dialog box, choose <b>Amazon S3 Glacier</b>.</li><li>3. At the <b>Name</b> step of the wizard, specify the object storage name and a brief description, such as the creator and creation date.</li><li>4. At the <b>Account</b> step of the wizard, specify the object storage account.<ul style="list-style-type: none"><li>• For <b>Credentials</b>, choose the IAM user that you created in the first epic to access your Amazon S3 Glacier object storage.</li><li>• For <b>AWS region</b>, choose the AWS Region where the Amazon S3 bucket is located.</li></ul></li><li>5. At the <b>Bucket</b> step of the wizard, specify object storage settings.</li></ol>	AWS administrator, App owner

Task	Description	Skills required
	<ul style="list-style-type: none"><li>• For <b>Data center region</b>, choose the AWS Region.</li><li>• For <b>Bucket</b>, choose an S3 bucket to store your backup data. This can be the same bucket you used for the capacity tier.</li><li>• For <b>Folder</b>, create or select a cloud folder to map your object storage repository to.</li><li>• If you want to enable immutability, choose <b>Make recent backups immutable for the entire duration of their retention policy</b>. Note that enabling immutability results in increased costs because of the increased number of API calls to Amazon S3 from Veeam.</li><li>• If you want to use S3 Glacier Deep Archive as your archival storage class, choose <b>Use the Deep Archive Storage Class</b>.</li></ul> <p>6. At the <b>Proxy Appliance</b> step of the wizard, configure the auxiliary instance that is used to transfer the</p>	

Task	Description	Skills required
	<p>data from Amazon S3 to Amazon S3 Glacier. You can use the default settings or configure each setting manually. To configure the settings manually:</p> <ul style="list-style-type: none"><li>• Choose <b>Customize</b>.</li><li>• For <b>EC2 instance type</b>, choose the instance type for the proxy appliance, based on your speed and cost requirements for transferring the backup files to the archive tier of your scale-out backup repository.</li><li>• For <b>Amazon VPC</b>, choose the VPC for the target instance.</li><li>• For <b>Subnet</b>, choose the subnet for the proxy appliance.</li><li>• For <b>Security group</b>, choose the security group to associate with the proxy appliance.</li><li>• For <b>Redirector port</b>, specify the TCP port for routing requests between the proxy appliance and backup infrastructure components.</li></ul>	

Task	Description	Skills required
	<ul style="list-style-type: none"> <li>Choose <b>OK</b> to confirm your settings.</li> </ul> <p>7. At the <b>Summary</b> step of the wizard, review the configuration information, and then choose <b>Finish</b>.</p>	

## Add scale-out backup repositories

Task	Description	Skills required
Launch the New Scale-Out Backup Repository wizard.	<ol style="list-style-type: none"> <li>On the Veeam console, open the <b>Backup Infrastructure</b> view.</li> <li>In the inventory pane, choose <b>Scale-out Repositories</b>, and then choose <b>Add Scale-out Repository</b>.</li> </ol>	App owner, AWS systems administrator
Add a scale-out backup repository and configure capacity and archive tiers.	<ol style="list-style-type: none"> <li>At the <b>Name</b> step of the wizard, specify the name and a brief description of the scale-out backup repository.</li> <li>If needed, add performance extents. You can also use your existing Veeam local backup repository as your performance tier. Starting with Veeam version 12, you can add an S3 bucket as a performance extent for direct-to-object (DTO)</li> </ol>	App owner, AWS systems administrator



Task	Description	Skills required
	<p>backups, bypassing a local performance tier.</p> <p>3. Choose <b>Advanced</b>, and specify additional options for the scale-out backup repository.</p> <ul style="list-style-type: none"><li>• Choose <b>Use per-machine backup files</b> to create a separate backup file for each machine and write these files to the backup repository in multiple streams simultaneously. This option is recommended for better storage and compute resource utilization.</li><li>• Choose <b>Perform full backup when required extent is offline</b> to create a full backup file in case an extent that contains restore points for an incremental backup goes offline. This option requires free space in the scale-out backup repository to host a full backup file.</li></ul> <p>4. At the <b>Policy</b> step of the wizard, specify the backup placement policy for the repository.</p>	

Task	Description	Skills required
	<ul style="list-style-type: none"><li>• Choose <b>Data locality</b> to store full and incremental backup files that belong to the same chain together, to the same performance extent. You can store files that belong to a new backup chain to the same performance extent or to another one (unless you use a deduplicating storage appliance as a performance extent).</li><li>• Choose <b>Performance</b> to store full and incremental backup files to different performance extents. This option requires a fast and reliable network connection. If you choose <b>Performance</b>, you can restrict the types of backup files to store on each performance extent. For example, you can store full backup files on one extent and incremental backup files on other extents. To choose file types:<ul style="list-style-type: none"><li>• Choose <b>Customize</b>.</li></ul></li></ul>	

Task	Description	Skills required
	<ul style="list-style-type: none"><li>• In the <b>Backup Placement Settings</b> dialog box, choose a performance extent, and then choose <b>Edit</b>.</li><li>• Choose the type of backup files you want to store on the extent.</li></ul> <p>5. At the <b>Capacity Tier</b> step of the wizard, configure the long-term storage tier that you want to attach to the scale-out backup repository.</p> <ul style="list-style-type: none"><li>• Choose <b>Extend scale-out backup repository capacity with object storage</b>. For the object storage repository, choose the Amazon S3 storage for the capacity tier that you added in the previous epic.</li><li>• Choose <b>Window</b> to select a time window for moving or copying data.</li><li>• Choose <b>Copy backups to object storage as soon as they are created</b> to copy all or only recently created backup files to the capacity extent.</li></ul>	

Task	Description	Skills required
	<ul style="list-style-type: none"><li>• Choose <b>Move backups to object storage as they age out of the operational restores window</b> to transfer inactive backup chains to the capacity extent. In the <b>Move backup files older than X days</b> field, specify a duration after which backup files should be offloaded . (To offload inactive backup chains on the day they were created, specify 0 days.) You can also choose <b>Override</b> to move backup files sooner if the scale-out backup repository has reached a threshold that you specify.</li><li>• Choose <b>Encrypt data uploaded to object storage</b> and specify a password to encrypt all data and their metadata for offloading. Choose <b>Add</b> or <b>Manage passwords</b> to specify a new password.</li></ul> <p>6. At the <b>Archive Tier</b> step of the wizard, configure the archive storage tier</p>	

Task	Description	Skills required
	<p>that you want to attach to the scale-out backup repository. (This step doesn't appear if you skipped adding Amazon S3 Glacier storage.)</p> <ul style="list-style-type: none"><li>• Choose <b>Archive GFS full backups to object storage</b>. For the object storage repository, choose the Amazon S3 Glacier storage you added in the previous epic.</li><li>• For <b>Archive GFS backups older than N days</b>, choose a time window for moving files to the archive extent. (To archive inactive backup chains on the day they were created, specify 0 days.)</li></ul> <p>7. At the <b>Summary</b> step of the wizard, review the configuration of the scale-out backup repository, and then choose <b>Finish</b>.</p>	

## Related resources

- [Creating an IAM user in your AWS account](#) (IAM documentation)
- [Creating a bucket](#) (Amazon S3 documentation)

- [Blocking public access to your Amazon S3 storage](#) (Amazon S3 documentation)
- [Using S3 Object Lock](#) (Amazon S3 documentation)
- [Veeam technical documentation](#)
- [How to Create Secure IAM Policy for Connection to S3 Object Storage](#) (Veeam documentation)

## Additional information

The following sections provide sample IAM policies you can use when you create an IAM user in the [Epics](#) section of this pattern.

### IAM policy for capacity tier

**Note** Change the name of the S3 buckets in the example policy from <yourbucketname> to the name of the S3 bucket that you want to use for Veeam capacity tier backups.

```
{
  "Version": "2012-10-17",
  "Statement": [
    {
      "Sid": "VisualEditor0",
      "Effect": "Allow",
      "Action": [
        "s3:GetObjectVersion",
        "s3:ListBucketVersions",
        "s3:ListBucket",
        "s3:PutObjectLegalHold",
        "s3:GetBucketVersioning",
        "s3:GetObjectLegalHold",
        "s3:GetBucketObjectLockConfiguration",
        "s3:PutObject*",
        "s3:GetObject*",
        "s3:GetEncryptionConfiguration",
        "s3:PutObjectRetention",
        "s3:PutBucketObjectLockConfiguration",
        "s3:DeleteObject*",
        "s3:DeleteObjectVersion",
        "s3:GetBucketLocation"
      ],
      "Resource": [
        "arn:aws:s3::/*",

```

```

        "arn:aws:s3:::"
    ]
},
{
    "Sid": "VisualEditor1",
    "Effect": "Allow",
    "Action": [
        "s3:ListAllMyBuckets",
        "s3:ListBucket"
    ],
    "Resource": "*"
}
]
}

```

## IAM policy for archive tier

**Note** Change the name of the S3 buckets in the example policy from <yourbucketname> to the name of the S3 bucket that you want to use for Veeam archive tier backups.

## To use your existing VPC, subnet, and security groups:

```

{
  "Version": "2012-10-17",
  "Statement": [
    {
      "Sid": "VisualEditor0",
      "Effect": "Allow",
      "Action": [
        "s3:DeleteObject",
        "s3:PutObject",
        "s3:GetObject",
        "s3:RestoreObject",
        "s3:ListBucket",
        "s3:AbortMultipartUpload",
        "s3:GetBucketVersioning",
        "s3:ListAllMyBuckets",
        "s3:GetBucketLocation",
        "s3:GetBucketObjectLockConfiguration",
        "s3:PutObjectRetention",
        "s3:GetObjectVersion",
        "s3:PutObjectLegalHold",
        "s3:GetObjectRetention",

```

```

        "s3:DeleteObjectVersion",
        "s3:ListBucketVersions",
        "ec2:DescribeInstances",
        "ec2:CreateKeyPair",
        "ec2:DescribeKeyPairs",
        "ec2:RunInstances",
        "ec2>DeleteKeyPair",
        "ec2:DescribeVpcAttribute",
        "ec2:CreateTags",
        "ec2:DescribeSubnets",
        "ec2:TerminateInstances",
        "ec2:DescribeSecurityGroups",
        "ec2:DescribeImages",
        "ec2:DescribeVpcs"
    ],
    "Resource": "*"
}
]
}

```

### To create new VPC, subnet, and security groups:

```

{
  "Version": "2012-10-17",
  "Statement": [
    {
      "Sid": "VisualEditor0",
      "Effect": "Allow",
      "Action": [
        "s3:DeleteObject",
        "s3:PutObject",
        "s3:GetObject",
        "s3:RestoreObject",
        "s3:ListBucket",
        "s3:AbortMultipartUpload",
        "s3:GetBucketVersioning",
        "s3:ListAllMyBuckets",
        "s3:GetBucketLocation",
        "s3:GetBucketObjectLockConfiguration",
        "s3:PutObjectRetention",
        "s3:GetObjectVersion",
        "s3:PutObjectLegalHold",
        "s3:GetObjectRetention",

```



```
    "s3:DeleteObjectVersion",
    "s3:ListBucketVersions",
    "ec2:DescribeInstances",
    "ec2:CreateKeyPair",
    "ec2:DescribeKeyPairs",
    "ec2:RunInstances",
    "ec2>DeleteKeyPair",
    "ec2:DescribeVpcAttribute",
    "ec2:CreateTags",
    "ec2:DescribeSubnets",
    "ec2:TerminateInstances",
    "ec2:DescribeSecurityGroups",
    "ec2:DescribeImages",
    "ec2:DescribeVpcs",
    "ec2:CreateVpc",
    "ec2:CreateSubnet",
    "ec2:DescribeAvailabilityZones",
    "ec2:CreateRoute",
    "ec2:CreateInternetGateway",
    "ec2:AttachInternetGateway",
    "ec2:ModifyVpcAttribute",
    "ec2:CreateSecurityGroup",
    "ec2>DeleteSecurityGroup",
    "ec2:AuthorizeSecurityGroupIngress",
    "ec2:AuthorizeSecurityGroupEgress",
    "ec2:DescribeRouteTables",
    "ec2:DescribeInstanceTypes"
  ],
  "Resource": "*"
}
]
```

# Configure Veritas NetBackup for VMware Cloud on AWS

Created by Shubham Salani (AWS)

**Environment:** Production

**Technologies:** Storage & backup; CloudNative

**Workload:** All other workloads

**AWS services:** Amazon S3; AWS Transit Gateway; Amazon VPC; Amazon EBS

## Summary

**Notice:** As of April 30, 2024, VMware Cloud on AWS is no longer resold by AWS or its channel partners. The service will continue to be available through Broadcom. We encourage you to reach out to your AWS representative for details.

Many enterprises use Veritas NetBackup as a backup and recovery solution for their on-premises VMware vSphere-based workloads. Once enterprises migrate their workloads to software-defined data centers (SDDCs) in the VMware Cloud on Amazon Web Services (AWS) infrastructure, there is no clear lift-and-shift procedure to integrate NetBackup. This pattern describes how you can set up Veritas NetBackup in your AWS account and configure it to back up the workloads in your VMware SDDCs.

This pattern does not include instructions for migrating your workloads. For more information, see [Migrate VMware SDDC to VMware Cloud on AWS using VMware HCX](#). When setting up your workloads to VMware Cloud on AWS, use a [stretched cluster](#) (VMware documentation). In this configuration, your cluster spans two AWS Availability Zones within a single Region. This provides high availability and resiliency in the event that one of the Availability Zones becomes unavailable. [Elastic DRS](#) and a [vSAN witness host](#) (VMware documentation) seamlessly copy the data to a third Availability Zone, known as a *fault domain*. This parity solution can help you recover the data in the event of a failure. Because this approach requires three Availability Zones, when selecting an AWS Region for your VMware Cloud environment, make sure that it has three or more Availability Zones. For more information, see [Regions and Availability Zones](#).

In this pattern, each SDDC has a backup host, which is a proxy server. Using Amazon Elastic Compute Cloud (Amazon EC2) instances, you set up the NetBackup master and media servers in a separate virtual private cloud (VPC), one for each SDDC. Because elastic network interfaces provide high bandwidth and low latency, you use them to configure connectivity between the backup hosts and their corresponding NetBackup master and media servers. The EC2 instances direct the backups to Amazon Elastic Block Store (Amazon EBS) volumes, which is the first point of backup. You can use AWS DataSync to keep your EBS volumes for the SDDCs synchronized.

You can also use AWS Transit Gateway and an interface VPC endpoint to connect the EBS volumes to another storage service, such as Amazon Simple Storage Service (Amazon S3). According to your retention policy, you can use S3 Intelligent-Tiering S3 Glacier storage classes to optimize your storage costs. For more information, see [Using Amazon S3 storage classes](#) (Amazon S3 documentation).

## Prerequisites and limitations

### Prerequisites

- Your VMware Cloud on AWS environment uses a stretched cluster that spans two Availability Zones.
- The backup host must reside on the VMware Cloud on AWS SDDC that has access to the datastore where the VMware Virtual Machine Disk File (VMDK) files are deployed.
- HotAdd transport mode must be enabled on the NetBackup client to back up and restore virtual machines (VMs), and it must permit restores from user-directed files and folders.

### Limitations

- The NetBackup master server must use DNS resolution to a private IP address for the vCenter backup host in the SDDC.
- The hosts files on the NetBackup master server and backup host should contain the following:
  - The private IP address and private DNS name of the master server
  - The private IP address and private DNS name of the backup host
- If you are configuring interface VPC endpoints to an S3 bucket, the SDDC Compute Gateway firewall must be configured to allow HTTPS from a Classless Inter-Domain Routing (CIDR) block source. For more information, see [Access an S3 Bucket Using an S3 Endpoint](#) (VMware documentation).

- VMware Cloud on AWS does not support the following features of NetBackup:
  - Backing up or restoring VM templates
  - Using NetBackup vSphere Client (HTML5 plug-in)
  - Locking and unlocking VMs for backups or restores
  - Backups cannot be stored in a vSAN datastore
  - Network block device (NBD), NBDSSL, and SAN transport modes

## Product versions

- VMware Cloud on AWS SDDC version 1.0 or later
- Veritas NetBackup version 8.1.2 or later
- Linux version 6.8 or later
- VMware vSphere version 6.0 or later

## Architecture

The following diagram shows the configuration of NetBackup for VMware Cloud on AWS. The NetBackup master and media servers are deployed in a separate VPC and are connected to the backup hosts in the SDDCs by elastic network interfaces. The NetBackup master and media servers store the backups in Amazon EBS volumes. You can optionally configure additional storage in Amazon S3 buckets by using AWS Transit Gateway and an AWS PrivateLink interface VPC endpoint.

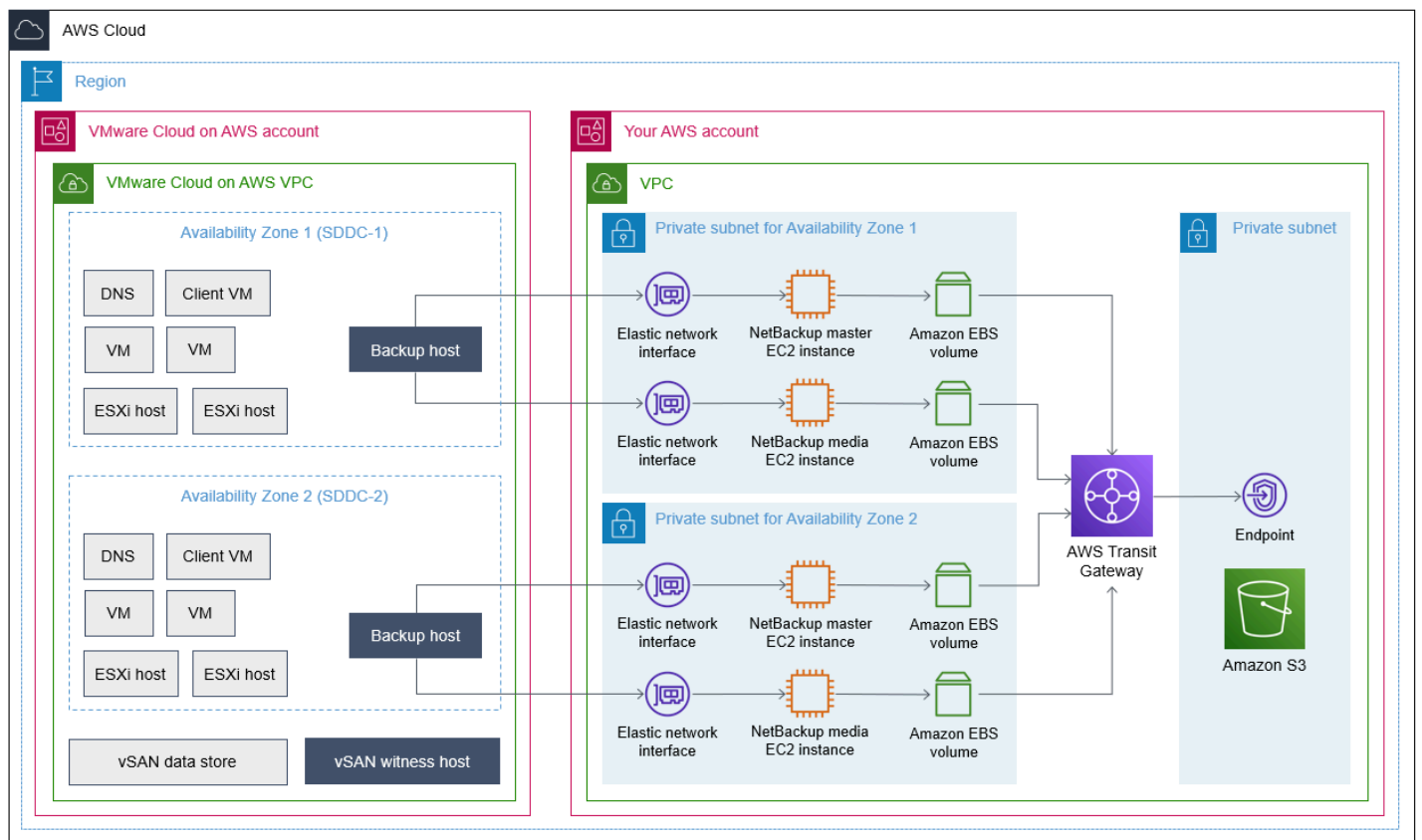

## Tools

### AWS services and tools

- [Amazon Elastic Block Store \(Amazon EBS\)](#) provides block-level storage volumes for use with Amazon Elastic Compute Cloud (Amazon EC2) instances.
- [AWS PrivateLink](#) helps you create unidirectional, private connections from your virtual private clouds (VPCs) to services outside of the VPC.
- [Amazon Simple Storage Service \(Amazon S3\)](#) is a cloud-based object storage service that helps you store, protect, and retrieve any amount of data.
- [Amazon Virtual Private Cloud \(Amazon VPC\)](#) helps you launch AWS resources into a virtual network that you've defined. This virtual network resembles a traditional network that you'd operate in your own data center, with the benefits of using the scalable infrastructure of AWS.

### Other services

- [VMware Cloud on AWS](#) is an integrated cloud offering jointly developed by Amazon Web Services (AWS) and VMware.
- [NetBackup for VMware](#) backs up and restores the VMware virtual machines that run on VMware ESXi hosts.

## Epics

### Configure the NetBackup servers

Task	Description	Skills required
Update the firewall rules.	<p>Update the firewall rules to establish connectivity between the VMware Cloud on AWS SDDC and the NetBackup master and media servers. Do the following:</p> <ol style="list-style-type: none"><li>1. Log in to VMware Cloud on AWS at <a href="https://vmc.vmware.com/">https://vmc.vmware.com/</a></li><li>2. On the <b>Networking and Security</b> tab, choose <b>Gateway Firewall</b>.</li><li>3. On the <b>Gateway Firewall</b> page, choose <b>Compute Gateway</b>.</li><li>4. Choose <b>ADD Rule</b>, and then create a new rule with the necessary firewall port settings. For more information, see <a href="#">NetBackup firewall port requirements</a> (Veritas documentation).</li></ol>	Network administrator, Cloud administrator

Task	Description	Skills required
Launch the NetBackup master and media servers.	<ol style="list-style-type: none"><li>1. Sign in to the AWS Management Console, and open the Amazon EC2 console at <a href="https://console.aws.amazon.com/ec2/">https://console.aws.amazon.com/ec2/</a></li><li>2. <a href="#">Launch an EC2 instance</a> (Amazon EC2 documentation), and use the following configuration details:<ol style="list-style-type: none"><li>a. For the NetBackup master and media servers, select the NBU-Linux-GA-8-1-2-Setup-f032d23e-881b-4dee-ba70-b9ca3e915910-ami-072509a7ffc156938.4 Amazon Machine Image (AMI). This preconfigured AMI is available through the <a href="#">AWS Marketplace</a>.</li><li>b. Select an <a href="#">instance type</a>. NetBackup recommends m5.2xlarge for the master and media servers.</li></ol></li></ol>	Cloud administrator, Backup administrator

Task	Description	Skills required
Configure the backup host for NetBackup.	<ol style="list-style-type: none"> <li>1. Log in to VMware Cloud on AWS at <a href="https://vmc.vmware.com/">https://vmc.vmware.com/</a></li> <li>2. Select the SDDC.</li> <li>3. Choose the <b>Open VCENTER</b> tab. This opens the SDDC vCenter.</li> <li>4. Note the fully qualified domain name (FQDN) of the backup host.</li> <li>5. Log in to the NetBackup Administration Console. For more information, see <a href="#">Logging in to the NetBackup Administration Console</a> (Veritas documentation).</li> <li>6. Select the master and media servers, and then choose <b>VMware Access Hosts</b>.</li> <li>7. Add the FQDN of the backup host.</li> <li>8. Choose <b>Apply</b>, and then choose <b>OK</b>.</li> </ol>	Cloud administrator, Backup administrator

### (Optional) Set up Amazon S3 storage

Task	Description	Skills required
Configure storage in Amazon S3.	<ol style="list-style-type: none"> <li>1. Review the <a href="#">Amazon S3 cloud storage options</a> (Veritas documentation)</li> </ol>	Cloud administrator, General AWS



Task	Description	Skills required
	<p>and select the appropriate storage class for your requirements.</p> <p>2. Configure NetBackup to use Amazon S3 for cloud storage according to the instructions in <a href="#">Configuring cloud storage in NetBackup</a> (Veritas documentation).</p>	

## Related resources

### AWS documentation

- [Create an interface VPC endpoint](#) (AWS PrivateLink documentation)

### Veritas documentation

- [NetBackup firewall port requirements](#)

### VMware documentation

- [Deploy a VM from an OVF Template in a Content Library](#)
- [VMware Cloud on AWS data transfer charges: How it works?](#) (VMware blog post)
- [VMware Cloud on AWS: Stretched Clusters](#)

# Copy data from an S3 bucket to another account and Region by using the AWS CLI

Created by Appasaheb Bagali (AWS) and Purushotham G K (AWS)

**Environment:** Production

**Technologies:** Storage & backup

**AWS services:** AWS CLI; AWS Identity and Access Management; Amazon S3

## Summary

This pattern describes how to migrate data from an Amazon Simple Storage Service (Amazon S3) bucket in an AWS source account to a destination S3 bucket in another AWS account, either in the same AWS Region or in a different Region.

The source S3 bucket allows AWS Identity and Access Management (IAM) access by using an attached resource policy. A user in the destination account has to assume a role that has `PutObject` and `GetObject` permissions for the source bucket. Finally, you run `copy` and `sync` commands to transfer data from the source S3 bucket to the destination S3 bucket.

Accounts own the objects that they upload to S3 buckets. If you copy objects across accounts and Regions, you grant the destination account ownership of the copied objects. You can change the ownership of an object by changing its [access control list \(ACL\)](#) to `bucket-owner-full-control`. However, we recommend that you grant programmatic cross-account permissions to the destination account because ACLs can be difficult to manage for multiple objects.

**Warning:** This scenario requires IAM users with programmatic access and long-term credentials, which present a security risk. To help mitigate this risk, we recommend that you provide these users with only the permissions they require to perform the task and that you remove these users when they are no longer needed. Access keys can be updated if necessary. For more information, see [Updating access keys](#) in the *IAM User Guide*.

This pattern covers one-time migration. For scenarios that require continuous and automatic migration of new objects from a source bucket to a destination bucket, you can use S3 Batch

Replication instead, as described in the pattern [Copy data from an S3 bucket to another account and Region by using S3 Batch Replication](#).

## Prerequisites and limitations

- Two active AWS accounts in the same or different AWS Regions.
- An existing S3 bucket in the source account.
- If your source or destination Amazon S3 bucket has [default encryption](#) enabled, you must modify the AWS Key Management Service (AWS KMS) key permissions. For more information, see the [AWS re:Post article](#) on this topic.
- Familiarity with cross-account permissions.

## Architecture

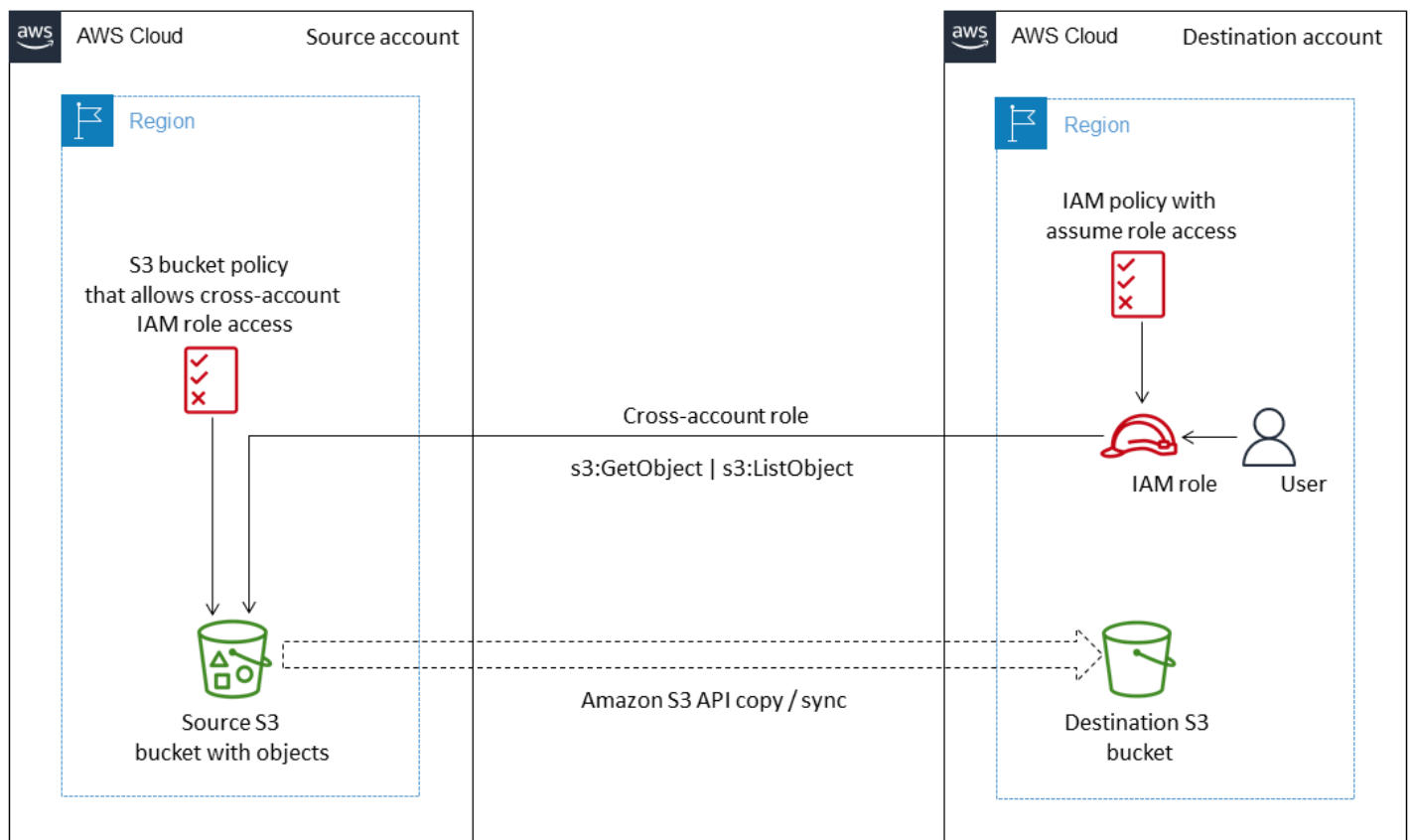

## Tools

- [Amazon Simple Storage Service \(Amazon S3\)](#) is a cloud-based object storage service that helps you store, protect, and retrieve any amount of data.
- [AWS Command Line Interface \(AWS CLI\)](#) is an open-source tool that helps you interact with AWS services through commands in your command line shell.
- [AWS Identity and Access Management \(IAM\)](#) helps you securely manage access to your AWS resources by controlling who is authenticated and authorized to use them.

## Best practices

- [Security best practices in IAM](#) (IAM documentation)
- [Applying least-privilege permissions](#) (IAM documentation)

## Epics

### Create an IAM user and role in the destination AWS account

Task	Description	Skills required
Create an IAM user and get the access key.	<ol style="list-style-type: none"><li>1. Sign in to the AWS Management Console and create an IAM user that has programmatic access. For detailed steps, see <a href="#">Creating IAM users</a> in the IAM documentation. There is no need to attach any policies for this user.</li><li>2. Generate an access key and secret key for this user. For instructions, see <a href="#">AWS Account and Access Keys</a> in the AWS documentation.</li></ol>	AWS DevOps

Task	Description	Skills required
Create an IAM identity-based policy.	<p>Create an IAM Identity-based policy named <code>S3MigrationPolicy</code> by using the following permissions. For detailed steps, see <a href="#">Creating IAM policies</a> in the IAM documentation.</p> <pre data-bbox="594 583 1027 1871">{   "Version":     "2012-10-17",   "Statement": [     {       "Effect":         "Allow",       "Action": [         "s3:ListBucket",         "s3:GetObject",         "s3:GetObjectTagging",         "s3:GetObjectVersion",         "s3:GetObjectVersionTagging"       ],       "Resource":         [           "arn:aws:s3:::awsexamplesourcebucket",           "arn:aws:s3:::awsexamplesourcebucket/*"         ]     }   ], }</pre>	AWS DevOps

Task	Description	Skills required
	<pre data-bbox="594 212 1026 1696"> {   "Effect":     "Allow",   "Action": [     "s3:ListBucket",     "s3:PutObject",     "s3:PutObjectAcl",     "s3:PutObjectTagging",     "s3:GetObjectTagging",     "s3:GetObjectVersion",     "s3:GetObjectVersionTagging"   ],   "Resource": [     "arn:aws:s3:::awsexampledestinationbucket",     "arn:aws:s3:::awsexampledestinationbucket/*"   ] } </pre> <p data-bbox="594 1738 1026 1864"><b>Note:</b> Modify the source and destination bucket names according to your use case.</p>	

Task	Description	Skills required
	This identity-based policy allows the user who is assuming this role to access the source bucket and destination bucket.	

Task	Description	Skills required
Create an IAM role.	<p>Create an IAM role named <code>S3MigrationRole</code> by using the following trust policy, and then attach the previously created <code>S3MigrationPolicy</code>. For detailed steps, see <a href="#">Creating a role to delegate permissions to an IAM user</a> in the IAM documentation.</p> <pre data-bbox="592 730 1027 1606">{   "Version":   "2012-10-17",   "Statement": [     {       "Effect":       "Allow",       "Principal": {         "AWS":         "arn:aws:iam::&lt;destination_account&gt;:         user/&lt;user_name&gt;"       },       "Action":       "sts:AssumeRole",       "Condition": {}     }   ] }</pre> <p><b>Note:</b> Modify the Amazon Resource Name (ARN) of the destination IAM role or user name in the trust policy according to your use case.</p>	AWS DevOps



Task	Description	Skills required
	This trust policy allows the newly created IAM user to assume S3MigrationRole .	

## Create and attach the S3 bucket policy in the source account

Task	Description	Skills required
Create and attach an S3 bucket policy.	<p>Sign in to the AWS Management Console for your source account and open the Amazon S3 console. Choose your source S3 bucket and then choose <b>Permissions</b>. Under <b>Bucket policy</b>, choose <b>Edit</b> and then paste the following bucket policy. Choose <b>Save</b>.</p> <pre> {   "Version":   "2012-10-17",   "Statement": [     {       "Sid":       "DelegateS3Access",       "Effect":       "Allow",       "Principal": {"AWS": "arn:aws:iam:&lt;destination_account&gt;:role/&lt;RoleName&gt;"},       "Action":       ["s3:ListBucket",       "s3:GetObject", </pre>	Cloud administrator

Task	Description	Skills required
	<pre> "s3:GetObjectTagging",  "s3:GetObjectVersion",  "s3:GetObjectVersionTagging"  ],     "Resource":     [  "arn:aws:s3:::awsexamplesourcebucket/*",  "arn:aws:s3:::awsexamplesourcebucket"     ] } </pre> <p><b>Note:</b> Make sure that you include the AWS account ID for the destination account and configure the bucket policy template according to your requirements.</p> <p>This resource-based policy allows the destination role <code>S3MigrationRole</code> to access S3 objects in the source account.</p>	

## Configure the destination S3 bucket

Task	Description	Skills required
Create a destination S3 bucket.	Sign in to the AWS Management Console for your destination account, open the Amazon S3 console, and then choose <b>Create bucket</b> . Create an S3 bucket according to your requirements. For more information, see <a href="#">Creating a bucket</a> in the Amazon S3 documentation.	Cloud administrator

## Copy data to the destination S3 bucket

Task	Description	Skills required
Configure AWS CLI with the newly created user credentials.	<ol style="list-style-type: none"> <li>1. Install the latest release of the AWS CLI. For instructions, see <a href="#">Installing or updating the latest version of the AWS CLI</a> in the AWS CLI documentation.</li> <li>2. Run <code>\$ aws configure</code> and update CLI with the AWS access key of the user you created. For more information, see <a href="#">Configuration and credential file settings</a> in the AWS CLI documentation.</li> </ol>	AWS DevOps
Assume the S3 migration role.	1. Use the AWS CLI to assume S3MigrationRole :	AWS administrator

Task	Description	Skills required
	<pre data-bbox="633 210 1023 604">aws sts assume-role \   --role-arn \   "arn:aws:iam::&lt;des   tination_account&gt;:   role/S3MigrationRo   le" \   --role-session-   name AWSCLI-Session</pre> <p data-bbox="630 646 1019 1684">This command outputs several pieces of information. Inside the credentials block you need the <code>AccessKeyId</code> , <code>SecretAccessKey</code> , and <code>SessionToken</code> . This example uses the environment variables <code>RoleAccessKeyID</code> , <code>RoleSecretKey</code> , and <code>RoleSessionToken</code> . Note that the timestamp of the expiration field is in the UTC time zone. The timestamp indicates when the temporary credentials of the IAM role expire. If the temporary credentials expire, you must call the <code>sts:AssumeRole</code> API again.</p> <ol data-bbox="591 1705 1019 1843" style="list-style-type: none"><li>2. Create three environment variables to assume the IAM role. These environme</li></ol>	

Task	Description	Skills required
	<p>Environment variables are filled out with the following output:</p> <pre data-bbox="634 331 1027 1163"># Linux export AWS_ACCESS_KEY_ID=RoleAccessKeyID export AWS_SECRET_ACCESS_KEY=RoleSecretKey export AWS_SESSION_TOKEN=RoleSessionToken # Windows set AWS_ACCESS_KEY_ID=RoleAccessKeyID set AWS_SECRET_ACCESS_KEY=RoleSecretKey set AWS_SESSION_TOKEN=RoleSessionToken</pre> <p>3. Verify that you assumed the IAM role by running the following command:</p> <pre data-bbox="634 1350 1027 1467">aws sts get-caller-identity</pre> <p>For more information, see the <a href="#">AWS Knowledge Center</a>.</p>	

Task	Description	Skills required
<p>Copy and synchronize data from the source S3 bucket to the destination S3 bucket.</p>	<p>When you have assumed the role <code>S3MigrationRole</code> you can copy the data using the copy (<b>cp</b>) or synchronize (<b>sync</b>) command.</p> <p>Copy (see the <a href="#">AWS CLI Command Reference</a> for details):</p> <pre>aws s3 cp s3:// DOC-EXAMPLE-BUCKET-SOURCE / \     s3:// DOC-EXAMPLE-BUCKET-TARGET / \     --recursive -- source-region SOURCE-REGION-NAME --region DESTINATION-REGION-NAME</pre> <p>Synchronize (see the <a href="#">AWS CLI Command Reference</a> for details):</p> <pre>aws s3 sync s3:// DOC-EXAMPLE-BUCKET-SOURCE / \     s3:// DOC-EXAMPLE-BUCKET-TARGET / \     --source-region SOURCE-REGION-NAME --region DESTINATION-REGION-NAME</pre>	Cloud administrator

## Troubleshooting

Issue	Solution
An error occurred (AccessDenied ) when calling the ListObjects operation: Access Denied	<ul style="list-style-type: none"><li>• Make sure that you have assumed the role <code>S3MigrationRole</code> .</li><li>• Run <code>aws sts get-caller-identity</code> to check the role used. If the output doesn't display the ARN for <code>S3MigrationRole</code> , assume the role again and retry.</li></ul>

## Related resources

- [Creating an S3 bucket](#) (Amazon S3 documentation)
- [Amazon S3 bucket policies and user policies](#) (Amazon S3 documentation)
- [IAM identities \(users, groups, and roles\)](#) (IAM documentation)
- [cp command](#) (AWS CLI documentation)
- [sync command](#) (AWS CLI documentation)

# Copy data from an S3 bucket to another account and Region by using S3 Batch Replication

*Created by Appasaheb Bagali (AWS), Lakshmikanth B D (AWS), Purushotham G K (AWS), Shubham Harsora (AWS), and Suman Rajotia (AWS)*

**Environment:** PoC or pilot

**Technologies:** Storage & backup

**AWS services:** Amazon S3; AWS Identity and Access Management

## Summary

This pattern explains how you can use Amazon Simple Storage Service (Amazon S3) Batch Replication to copy the contents of an S3 bucket to another S3 bucket automatically, without any manual intervention, after you set up the buckets. The source and destination buckets can be in the same or in different AWS accounts or Regions.

S3 Batch Replication gives you a way to replicate Amazon S3 objects that existed before a replication configuration was in place, objects that were previously replicated, and objects that failed replication. This method uses an S3 Batch Operations job. When the job finishes, you receive a completion report.

You can use S3 Batch Replication in scenarios that require continuous and automatic migration of new objects from a source bucket to a destination bucket. For one-time migration, you can use the AWS Command Line Interface (AWS CLI) instead, as described in the pattern [Copy data from an S3 bucket to another account and Region by using the AWS CLI](#).

## Prerequisites and limitations

- A source AWS account.
- A destination AWS account.
- An S3 bucket in the source account with a few objects (files or folders).
- One or more S3 buckets in the destination account.
- [S3 Versioning](#) enabled on the source and destination buckets.



- AWS Identity and Access Management (IAM) permissions to create an IAM policy, IAM role, and S3 bucket policy on the source and destination accounts.
- [Amazon S3 Lifecycle rules](#) disabled while the S3 Batch Replication job is active. This ensures parity between the source and destination buckets. Otherwise, the destination bucket might not be an exact replica of the source bucket.

## Architecture

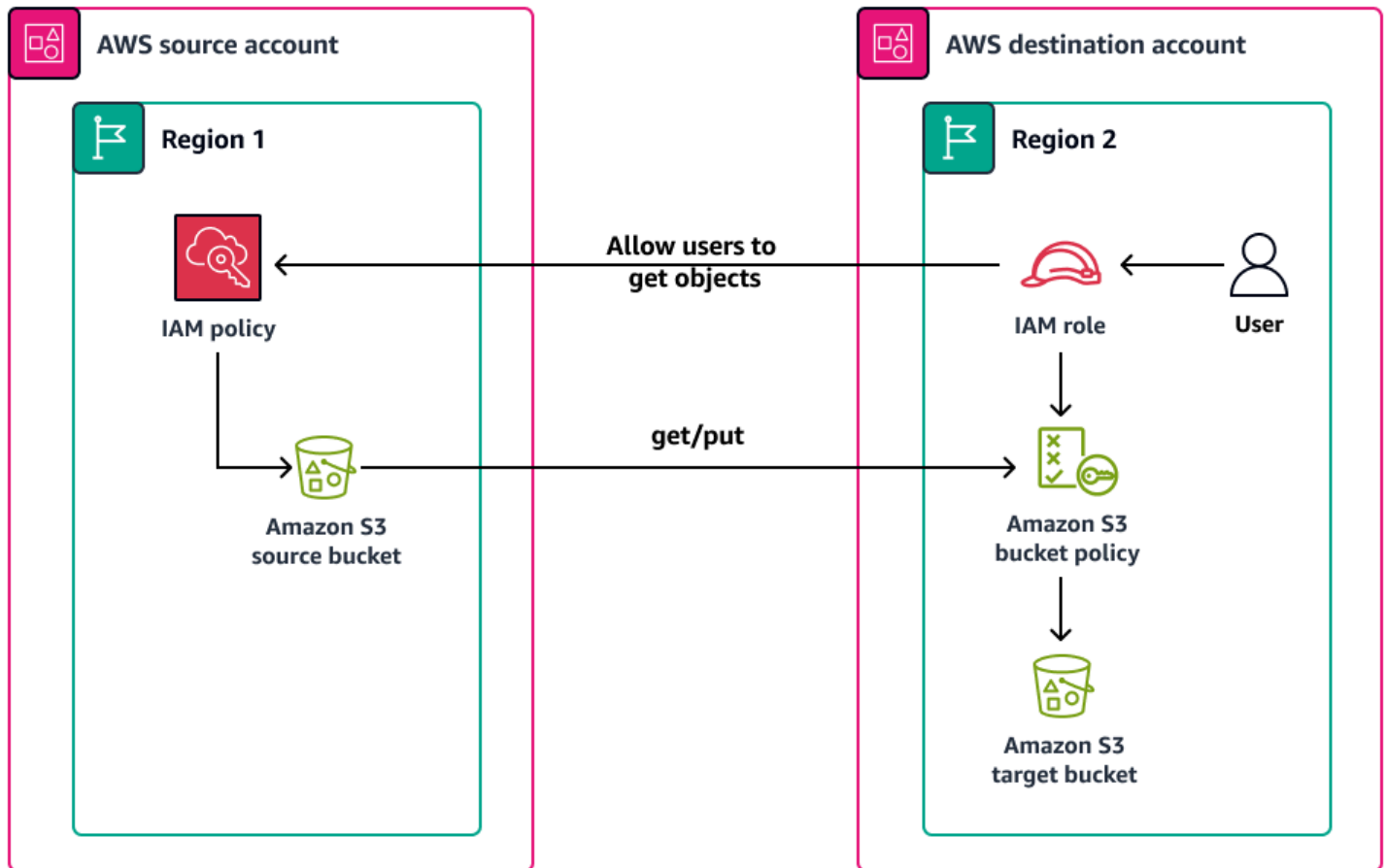

## Tools

### AWS services

- [AWS Identity and Access Management \(IAM\)](#) helps you securely manage access to your AWS resources by controlling who is authenticated and authorized to use them.
- [Amazon Simple Storage Service \(Amazon S3\)](#) is a cloud-based object storage service that helps you store, protect, and retrieve any amount of data.

## Best practices

The following video from AWS re:Invent 2022 discusses best practices for using Amazon S3 replication for regulatory compliance, data protection, and increased application performance.

## Epics

### Create an IAM policy and role for cross-account replication in the source account

Task	Description	Skills required
Create an IAM policy for cross-account replication.	<p>In the AWS source account:</p> <ol style="list-style-type: none"><li>1. Open the <a href="#">IAM console</a>.</li><li>2. Create a new IAM policy.</li><li>3. In the <b>Policy editor</b> section, choose <b>JSON</b>, and paste the following code.</li></ol> <pre>{   "Version":     "2012-10-17",   "Statement": [     {       "Sid":         "GetSourceBucketCo nfiguration",       "Effect":         "Allow",       "Action":         [           "s3:ListBucket",           "s3:GetBucketLocat ion",           "s3:GetBucketAcl",</pre>	Cloud administrator, AWS administrator

Task	Description	Skills required
	<pre> "s3:GetReplication Configuration",  "s3:GetObjectVersi onForReplication",  "s3:GetObjectVersi onAcl",  "s3:GetObjectVersi onTagging"       ],       "Resource ": [    "arn:aws:s3:::sour ce-bucket-name",    "arn:aws:s3:::sour ce-bucket-name/*"       ]     },     {       "Sid": "ReplicateToDestin ationBuckets",       "Effect": "Allow",       "Action": [  "s3:List*",  "s3:*Object",  "s3:ReplicateObjec t",  "s3:ReplicateDelet e", </pre>	

Task	Description	Skills required
	<pre> "s3:ReplicateTags"     ],     "Resource": [       "arn:aws:s3:::destination-bucket-name*",       "arn:aws:s3:::destination-bucket-name/*"     ]   },   {     "Sid": "PermissionToOverrideBucketOwner",     "Effect": "Allow",     "Action": [       "s3:ObjectOwnerOverrideToBucketOwner"     ],     "Resource": [       "arn:aws:s3:::destination-bucket-name*",       "arn:aws:s3:::destination-bucket-name/*"     ]   } ] } </pre>	

Task	Description	Skills required
	<p>This policy includes three statements:</p> <ul style="list-style-type: none"><li>• <code>GetSourceBucketConfiguration</code> provides access to the replication configuration and object version for replication on the source bucket.</li><li>• <code>ReplicateToDestinationBuckets</code> provides access to replicate to the destination bucket. You can specify multiple destination buckets in the array.</li><li>• <code>PermissionToOverrideBucketOwner</code> provides access to <code>ObjectOwnerOverrideToBucketOwner</code> so that the destination bucket can own the objects in the destination account that were replicated from the source account.</li></ul> <p>4. Choose <b>Next</b>, provide a policy name such as <code>cross-account-bucket-replication-policy</code>, and then choose <b>Create policy</b>.</p>	

Task	Description	Skills required
	<p>For more information, see <a href="#">Creating IAM policies</a> in the IAM documentation.</p>	
<p>Create an IAM role for cross-account replication.</p>	<p>In the AWS source account:</p> <ol style="list-style-type: none"> <li>1. On the <a href="#">IAM console</a>, create an IAM role with the following information:               <ol style="list-style-type: none"> <li>a. For <b>Trusted entity type</b>, choose <b>AWS service</b>.</li> <li>b. For service, choose <b>S3</b>.</li> <li>c. For use case, choose <b>S3 Batch Operations</b>.</li> <li>d. Choose the policy you created in the previous step.</li> </ol> </li> <li>2. Provide a role name such as cross-account-bucket-replication-role, and then choose <b>Create role</b>.</li> </ol> <p>For more information, see <a href="#">Creating IAM roles</a> in the IAM documentation.</p>	<p>Cloud administrator, AWS administrator</p>

## Create a replication rule in the source account

Task	Description	Skills required
<p>Create a replication rule against the source bucket in the source account.</p>	<p>In the AWS source account:</p> <ol style="list-style-type: none"> <li>1. Open the <a href="#">Amazon S3 console</a>.</li> </ol>	<p>AWS administrator, Cloud administrator</p>

Task	Description	Skills required
	<ol style="list-style-type: none"><li data-bbox="592 212 964 342">2. Navigate to the source bucket, and choose the <b>Management</b> tab.</li><li data-bbox="592 363 1024 1845">3. Create a replication rule with the following configuration:<ol style="list-style-type: none"><li data-bbox="630 516 954 646">a. Provide a rule name such as <code>s3-replication-rule</code> .</li><li data-bbox="630 667 935 747">b. For <b>Status</b>, choose <b>Enabled</b>.</li><li data-bbox="630 768 1019 898">c. For rule scope, choose <b>Applies to all objects in the bucket</b>.</li><li data-bbox="630 919 1024 1192">d. For <b>Destination</b>, choose <b>Specify a bucket in another account</b>, and then enter the destination AWS account number and the bucket name.</li><li data-bbox="630 1213 1029 1398">e. Choose the option to change object ownership to the destination bucket owner.</li><li data-bbox="630 1419 1024 1549">f. For <b>IAM role</b>, choose the role you created earlier in the source account.</li><li data-bbox="630 1570 1016 1843">g. For <b>Additional replication options</b>, select all available options. These provide the ability to replicate content quickly, monitor the</li></ol></li></ol>	

Task	Description	Skills required
	<p>progress of replication through Amazon CloudWatch metrics, replicate delete markers, and replicate metadata changes.</p> <p>h. Choose <b>Save</b>.</p> <p>4. If you have multiple destination buckets, create additional replication rules.</p> <p>For more information, see <a href="#">Configuring replication when source and destination buckets are owned by different accounts</a> in the Amazon S3 documentation.</p>	

### Apply a bucket policy to the destination bucket

Task	Description	Skills required
Apply a bucket policy to the destination bucket.	<p>This step has to be performed for each destination bucket individually in AWS destination accounts.</p> <p>In the AWS destination account:</p> <ol style="list-style-type: none"> <li>1. Open the <a href="#">IAM console</a>, navigate to the destination bucket, and choose the <b>Permissions</b> tab.</li> </ol>	AWS administrator, AWS systems administrator, Cloud administrator



Task	Description	Skills required
	<p>2. Edit the bucket policy by providing the following JSON code, and save the policy:</p> <pre data-bbox="592 464 1029 1869">{   "Version":     "2012-10-17",   "Id": "PolicyForDestinationBucket",   "Statement": [     {       "Sid":         "Permissions on         objects and buckets",       "Effect":         "Allow",       "Principal": {         "AWS":           "arn:aws:iam::SourceAWSAccountNumber:role/IAM-Role-created-in-step1-in-source-account"       },       "Action": [         "s3:List*",         "s3:GetBucketVersioning",         "s3:PutBucketVersioning",         "s3:ReplicateDelete",         "s3:ReplicateObject"       ],</pre>	

Task	Description	Skills required
	<pre data-bbox="609 212 1015 1577">           "Resource":             [               "arn:aws:s3:::destination-bucket",               "arn:aws:s3:::destination-bucket/*"             ]           },           {             "Sid":               "Permission to override bucket owner",             "Effect":               "Allow",             "Principal": {               "AWS":                 "arn:aws:iam::SourceAWSAccountNumber:role/IAM-Role-created-in-step1-in-source-account"             },             "Action":               "s3:ObjectOwnerOverrideToBucketOwner",             "Resource": "arn:aws:s3:::destination-bucket/*"           }         ]       }     </pre> <p data-bbox="592 1619 938 1696">This policy includes two statements:</p> <ul data-bbox="592 1745 1015 1875" style="list-style-type: none"> <li>• Permissions on objects and buckets indicates that the destinati</li> </ul>	

Task	Description	Skills required
	<p>on bucket can replicate content based on the role defined in the source account. The role provides permissions to the source bucket.</p> <ul style="list-style-type: none"> <li>• Permission to override bucket owner indicates that the destination bucket has permissions to override the ownership from the source account.</li> </ul>	

### Test Amazon S3 cross-account replication

Task	Description	Skills required
Verify that replication works correctly.	<ol style="list-style-type: none"> <li>1. Add an object to the source bucket.</li> <li>2. Verify that the new object appears in the S3 buckets in the destination accounts.</li> <li>3. View CloudWatch metrics: <ol style="list-style-type: none"> <li>a. In the source bucket, choose the <b>Metrics</b> tab.</li> <li>b. In the <b>Replication metrics</b> section, select a replication rule.</li> <li>c. Choose <b>Display charts</b>. The charts reflect the state of replication by displaying the operations that are pending</li> </ol> </li> </ol>	AWS administrator, Cloud administrator

Task	Description	Skills required
	<p>replication, the replicati on latency, and the bytes pending replicati on.</p> <p>For more information, see <a href="#">Monitoring metrics with Amazon CloudWatch</a> in the Amazon S3 documentation.</p>	

## Related resources

- [When do I use IAM?](#) (IAM documentation)
- [How IAM works](#) (IAM documentation)
- [Creating IAM roles](#) (IAM documentation)
- [Creating IAM policies](#) (IAM documentation)
- [Overview of access management: Permissions and policies](#) (IAM documentation)
- [Creating, configuring, and working with Amazon S3 buckets](#) (Amazon S3 documentation)
- [Uploading, downloading, and working with objects in Amazon S3](#) (Amazon S3 documentation)
- [Replicating objects](#) (Amazon S3 documentation)

# Migrate data from an on-premises Hadoop environment to Amazon S3 using DistCp with AWS PrivateLink for Amazon S3

Created by Jason Owens (AWS), Andres Cantor (AWS), Jeff Klopfenstein (AWS), Bruno Rocha Oliveira (AWS), and Samuel Schmidt (AWS)

<b>Environment:</b> Production	<b>Source:</b> Hadoop	<b>Target:</b> Any
<b>R Type:</b> Replatform	<b>Workload:</b> Open-source	<b>Technologies:</b> Storage & backup; Analytics
<b>AWS services:</b> Amazon S3; Amazon EMR		

## Summary

This pattern demonstrates how to migrate nearly any amount of data from an on-premises Apache Hadoop environment to the Amazon Web Services (AWS) Cloud by using the Apache open-source tool [DistCp](#) with AWS PrivateLink for Amazon Simple Storage Service (Amazon S3). Instead of using the public internet or a proxy solution to migrate data, you can use [AWS PrivateLink for Amazon S3](#) to migrate data to Amazon S3 over a private network connection between your on-premises data center and an Amazon Virtual Private Cloud (Amazon VPC). If you use DNS entries in Amazon Route 53 or add entries in the `/etc/hosts` file in all nodes of your on-premises Hadoop cluster, then you are automatically directed to the correct interface endpoint.

This guide provides instructions for using DistCp for migrating data to the AWS Cloud. DistCp is the most commonly used tool, but other migration tools are available. For example, you can use offline AWS tools like [AWS Snowball](#) or [AWS Snowmobile](#), or online AWS tools like [AWS Storage Gateway](#) or [AWS DataSync](#). Additionally, you can use other open-source tools like [Apache NiFi](#).

## Prerequisites and limitations

### Prerequisites

- An active AWS account with a private network connection between your on-premises data center and the AWS Cloud

- [Hadoop](#), installed on premises with [DistCp](#)
- A Hadoop user with access to the migration data in the Hadoop Distributed File System (HDFS)
- AWS Command Line Interface (AWS CLI), [installed](#) and [configured](#)
- [Permissions](#) to put objects into an S3 bucket

## Limitations

Virtual private cloud (VPC) limitations apply to AWS PrivateLink for Amazon S3. For more information, see [Interface endpoint properties and limitations](#) and [AWS PrivateLink quotas](#) (AWS PrivateLink documentation).

AWS PrivateLink for Amazon S3 doesn't support the following:

- [Federal Information Processing Standard \(FIPS\) endpoints](#)
- [Website endpoints](#)
- [Legacy global endpoints](#)

## Architecture

### Source technology stack

- Hadoop cluster with DistCp installed

### Target technology stack

- Amazon S3
- Amazon VPC

### Target architecture

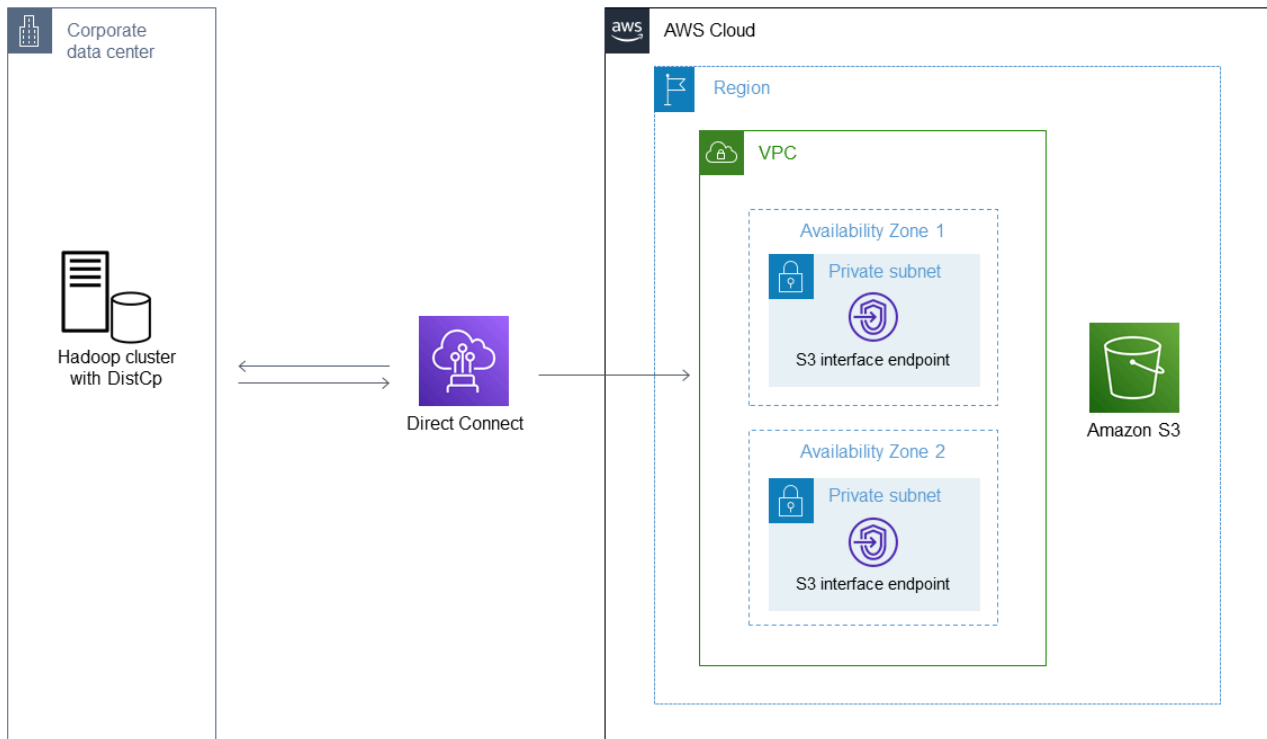

The diagram shows how the Hadoop administrator uses DistCp to copy data from an on-premises environment through a private network connection, such as AWS Direct Connect, to Amazon S3 through an Amazon S3 interface endpoint.

## Tools

### AWS services

- [AWS Identity and Access Management \(IAM\)](#) helps you securely manage access to your AWS resources by controlling who is authenticated and authorized to use them.
- [Amazon Simple Storage Service \(Amazon S3\)](#) is a cloud-based object storage service that helps you store, protect, and retrieve any amount of data.
- [Amazon Virtual Private Cloud \(Amazon VPC\)](#) helps you launch AWS resources into a virtual network that you've defined. This virtual network resembles a traditional network that you'd operate in your own data center, with the benefits of using the scalable infrastructure of AWS.

### Other tools

- [Apache Hadoop DistCp](#) (distributed copy) is a tool used for copying large inter-clusters and intra-clusters. DistCp uses Apache MapReduce for distribution, error handling and recovery, and reporting.

## Epics

### Migrate data to the AWS Cloud

Task	Description	Skills required
Create an endpoint for AWS PrivateLink for Amazon S3.	<ol style="list-style-type: none"><li>1. Sign in to the AWS Management Console and open the <a href="#">Amazon VPC console</a>.</li><li>2. On the navigation pane, choose <b>Endpoints</b>, and then choose <b>Create Endpoint</b>.</li><li>3. For <b>Service category</b>, choose <b>AWS services</b>.</li><li>4. In the search box, enter <b>s3</b>, and then press <b>Enter</b>.</li><li>5. In the search results, choose the <b>com.amazonaws.&lt;your-aws-region&gt;.s3</b> service name where the value in the <b>Type</b> column is <b>Interface</b>.</li><li>6. For <b>VPC</b>, choose your VPC. For <b>Subnets</b>, choose your subnets.</li><li>7. For <b>Security group</b>, choose or create a security group that allows TCP 443.</li></ol>	AWS administrator



Task	Description	Skills required
	8. Add tags based on your requirements and then choose <b>Create endpoint</b> .	
Verify the endpoints and find the DNS entries.	<ol style="list-style-type: none"><li>1. Open the <a href="#">Amazon VPC console</a>, choose <b>Endpoints</b>, and then select the endpoint that you created earlier.</li><li>2. On the <b>Details</b> tab, find the first DNS entry for <b>DNS names</b>. This is the Regional DNS entry. When you use this DNS name, requests alternate between DNS entries specific to Availability Zones.</li><li>3. Choose the <b>Subnets</b> tab. You can find the address of the endpoint's elastic network interface in each Availability Zone.</li></ol>	AWS administrator

Task	Description	Skills required
Check the firewall rules and routing configurations.	<p>To confirm that your firewall rules are open and that your networking configuration is correctly set up, use Telnet to test the endpoint on port 443. For example:</p> <pre data-bbox="594 537 1029 1612">\$ telnet vpce-&lt;you r-VPC-endpoint-ID&gt; .s3.us-east-2.vpce .amazonaws.com 443  Trying 10.104.88.6...  Connected to vpce-&lt;you r-VPC-endpoint-ID&gt; .s3.us-east-2.vpce .amazonaws.com.  ...  \$ telnet vpce-&lt;you r-VPC-endpoint-ID&gt; .s3.us-east-2.vpce .amazonaws.com 443  Trying 10.104.71 .141...  Connected to vpce-&lt;you r-VPC-endpoint-ID&gt; .s3.us-east-2.vpce .amazonaws.com.</pre> <p><b>Note:</b> If you use the Regional entry, a successful test shows that the DNS is alternating between the two IP addresses that you can see on the</p>	Network administrator, AWS administrator

Task	Description	Skills required
	<b>Subnets</b> tab for your selected endpoint in the Amazon VPC console.	

Task	Description	Skills required
Configure the name resolution.	<p>You must configure the name resolution to allow Hadoop to access the Amazon S3 interface endpoint. You can't use the endpoint name itself. Instead, you must resolve <code>&lt;your-bucket-name&gt;.s3.&lt;your-aws-region&gt;.amazonaws.com</code> or <code>*.s3.&lt;your-aws-region&gt;.amazonaws.com</code>. For more information on this naming limitation, see <a href="#">Introducing the Hadoop S3A client</a> (Hadoop website).</p> <p>Choose one of the following configuration options:</p> <ul style="list-style-type: none"><li>• Use on-premises DNS to resolve the private IP address of the endpoint. You can override behavior for all buckets or selected buckets. For more information, see "Option 2: Access Amazon S3 using Domain Name System Response Policy Zones (DNS RPZ)" in <a href="#">Secure hybrid access to Amazon S3 using AWS PrivateLink</a> (AWS blog post).</li><li>• Configure on-premises DNS to conditionally forward</li></ul>	AWS administrator

Task	Description	Skills required
	<p>traffic to the resolver inbound endpoints in the VPC. Traffic is forwarded to Route 53. For more information, see “Option 3: Forwarding DNS requests from on premises using Amazon Route 53 Resolver Inbound Endpoints” in <a href="#">Secure hybrid access to Amazon S3 using AWS PrivateLink</a> (AWS blog post).</p> <ul style="list-style-type: none"><li>• Edit the <b>/etc/hosts</b> file on all the nodes in your Hadoop cluster. This is a temporary solution for testing and isn't recommended for production. To edit the <b>/etc/hosts</b> file, add an entry for either <code>&lt;your-bucket-name&gt;.s3.&lt;your-aws-region&gt;.amazonaws.com</code> or <code>s3.&lt;your-aws-region&gt;.amazonaws.com</code>. The <b>/etc/hosts</b> file can't have multiple IP addresses for an entry. You must choose a single IP address from one of the Availability Zones, which then becomes a single point of failure.</li></ul>	

Task	Description	Skills required
Configure authentication for Amazon S3.	<p>To authenticate to Amazon S3 through Hadoop, we recommend that you export temporary role credentials to the Hadoop environment. For more information, see <a href="#">Authenticating with S3</a> (Hadoop website). For long-running jobs, you can create a user and assign a policy that has permissions to put data into an S3 bucket only. The access key and secret key can be stored on Hadoop, accessible only to the DistCp job itself and to the Hadoop administrator. For more information on storing secrets, see <a href="#">Storing secrets with Hadoop Credential Providers</a> (Hadoop website). For more information on other authentication methods, see <a href="#">How to get credentials of an IAM role for use with CLI access to an AWS account</a> in the documentation for AWS IAM Identity Center (successor to AWS Single Sign-On).</p> <p>To use temporary credentials, add the temporary credentials to your credentials file, or run the following commands</p>	AWS administrator

Task	Description	Skills required
	<p>to export the credentials to your environment:</p> <pre>export AWS_SESSION_TOKEN=SECRET-SESSION-TOKEN export AWS_ACCESS_KEY_ID=SESSION-ACCESS-KEY export AWS_SECRET_ACCESS_KEY=SESSION-SECRET-KEY</pre> <p>If you have a traditional access key and secret key combination, run the following commands:</p> <pre>export AWS_ACCESS_KEY_ID=my.aws.key export AWS_SECRET_ACCESS_KEY=my.secret.key</pre> <p><b>Note:</b> If you use an access key and secret key combination, then change the credentials provider in the DistCp commands from "org.apache.hadoop.fs.s3a.TemporaryAWSCredentialsProvider" to "org.apache.hadoop.fs.s3a.SimpleAWSCredentialsProvider" .</p>	

Task	Description	Skills required
Transfer data by using DistCp.	<p>To use DistCp to transfer data, run the following commands:</p> <pre data-bbox="597 394 1026 1507">hadoop distcp -Dfs.s3a.aws.credentials.provider=\ "org.apache.hadoop.fs.s3a.TemporaryAWSCredentialsProvider" \ -Dfs.s3a.access.key="\${AWS_ACCESS_KEY_ID}" \ -Dfs.s3a.secret.key="\${AWS_SECRET_ACCESS_KEY}" \ -Dfs.s3a.session.token="\${AWS_SESSION_TOKEN}" \ -Dfs.s3a.path.style.access=true \ -Dfs.s3a.connection.ssl.enabled=true \ -Dfs.s3a.endpoint=s3.&lt;your-aws-region&gt;.amazonaws.com \ hdfs:///user/root/s3a://&lt;your-bucket-name&gt;</pre> <p><b>Note:</b> The AWS Region of the endpoint isn't automatically discovered when you use the DistCp command with AWS PrivateLink for Amazon S3. Hadoop 3.3.2 and later versions resolve this issue</p>	Migration engineer, AWS administrator



Task	Description	Skills required
	<p>by enabling the option to explicitly set the AWS Region of the S3 bucket. For more information, see <a href="#">S3A to add option fs.s3a.endpoint.region to set AWS region</a> (Hadoop website).</p> <p>For more information on additional S3A providers, see <a href="#">General S3A Client configuration</a> (Hadoop website). For example, if you use encryption, you can add the following option to the series of commands above depending on your type of encryption:</p> <pre data-bbox="594 1031 1027 1230">-Dfs.s3a.server-side-encryption-algorithm=AES-256 [or SSE-C or SSE-KMS]</pre> <p><b>Note:</b> To use the interface endpoint with S3A, you must create a DNS alias entry for the S3 Regional name (for example, <code>s3.&lt;your-aws-region&gt;.amazonaws.com</code>) to the interface endpoint. See the <i>Configure authentication for Amazon S3</i> section for instructions. This workaround is required for Hadoop 3.3.2 and earlier versions. Future versions</p>	

Task	Description	Skills required
	<p>of S3A won't require this workaround.</p> <p>If you have signature issues with Amazon S3, add an option to use Signature Version 4 (SigV4) signing:</p> <pre data-bbox="597 554 1026 751">-Dmapreduce.map.java.opts="-Dcom.amazonaws.services.s3.enableV4=true"</pre>	

# Use CloudEndure for disaster recovery of an on-premises database

*Created by Nishant Jain (AWS) and Anuraag Deekonda (AWS)*

**Environment:** PoC or pilot

**Technologies:** Storage & backup; Modernization; Databases

## Summary

**Warning:** IAM users have long-term credentials, which presents a security risk. To help mitigate this risk, we recommend that you provide these users with only the permissions they require to perform the task and that you remove these users when they are no longer needed.

This pattern uses CloudEndure Disaster Recovery and the CloudEndure Failback Client for disaster recovery (DR). It sets up DR for an on-premises data center host, using an Amazon Elastic Compute Cloud (Amazon EC2) instance.

You must use the CloudEndure Failback Client for replicating from a non-cloud or other cloud infrastructure to the Amazon Web Services (AWS) Cloud. After your disaster event is over, you will want to fail back your machines. CloudEndure prepares you for failback by reversing the direction of data replication from the target machine back to the source machine. The CloudEndure User Console treats the currently launched target machines as source machines. Replication is reversed from your selected target machines back to your original source infrastructure.

**Important:** In November 2021, AWS launched [AWS Elastic Disaster Recovery](#), which is now the recommended service for disaster recovery on AWS.

Following the successful launch of Elastic Disaster Recovery, AWS will begin to limit the availability of CloudEndure Disaster Recovery in all AWS Regions, including AWS GovCloud (US) Regions (AWS China Regions will continue to be supported). This will take place according to the following schedule:

1. September 1, 2023 – Customers will no longer be able to register for new CloudEndure DR accounts in any AWS Region (except for AWS China Regions).
2. December 1, 2023 – New CloudEndure DR agent installations will no longer be supported in any AWS Region (except for AWS China Regions). Note that upgrades of existing agents will be supported.
3. March 31, 2024 – CloudEndure DR will be discontinued in all AWS Regions (except for AWS China Regions).
4. For any updated timelines for CloudEndure Disaster Recovery EOL, see the [CloudEndure documentation](#).

This publication will be removed on March 31, 2024. If you need it for a migration project in progress, please download and save the PDF file by using the PDF link that is below the title on this page.

## Prerequisites and limitations

### Prerequisites

- An active AWS account
- An on-premises database

## Architecture

### Source technology stack

- A database in an on-premises data center

### Target technology stack

- A database on an EC2 instance (for a complete list of supported operating system versions, see [Amazon EC2 FAQs](#))

### Source and target network architecture

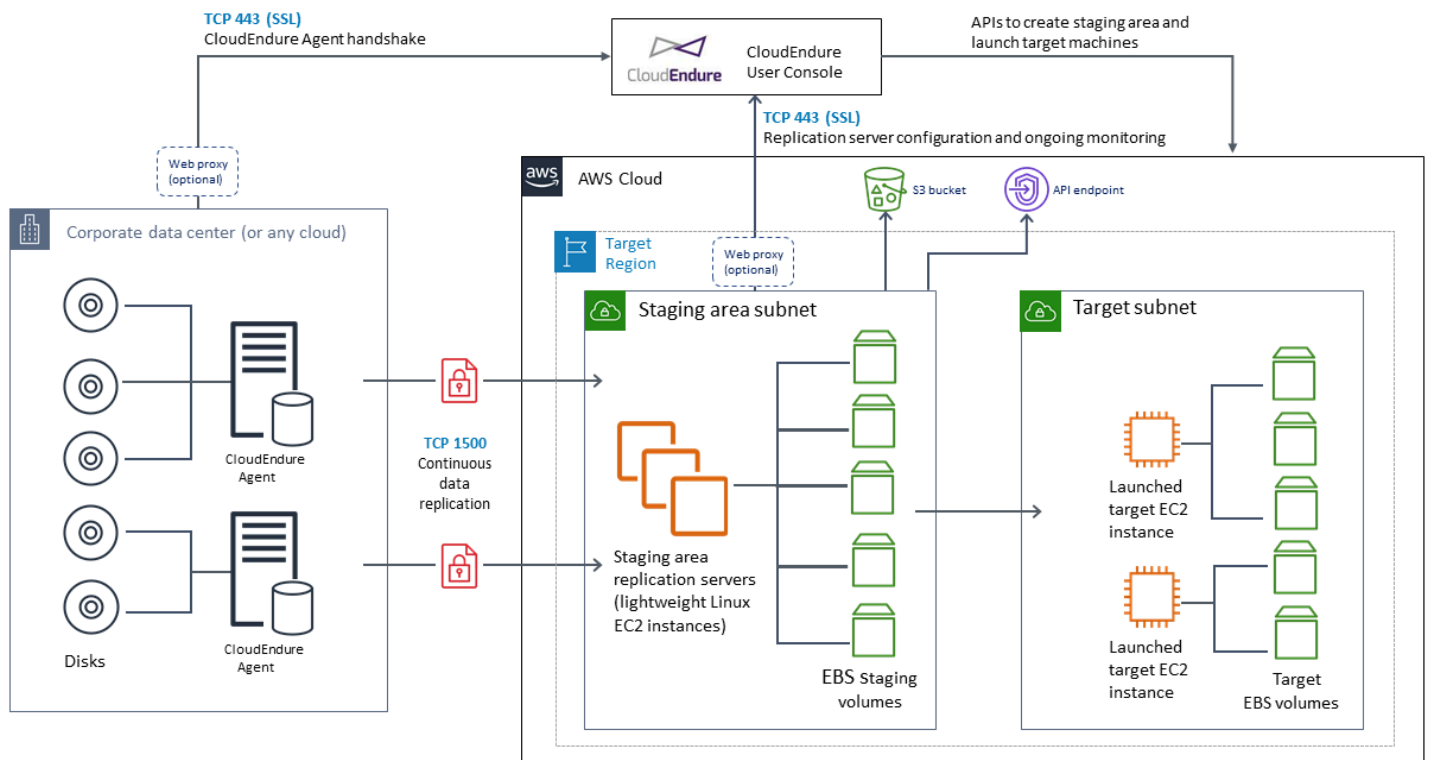

## Tools

- [CloudEndure Disaster Recovery](#) – CloudEndure Disaster Recovery reduces downtime and data loss by providing fast, reliable recovery of physical, virtual, and cloud-based servers into AWS. CloudEndure Disaster Recovery continuously replicates your machines (including operating system, system state configuration, databases, applications, and files) into a low-cost staging area in your target AWS account and preferred Region. If there is a disaster, you can instruct CloudEndure Disaster Recovery to automatically launch thousands of machines in their fully provisioned state in minutes.

## Epics

### Subscribe to CloudEndure Disaster Recovery

Task	Description	Skills required
Subscribe to CloudEndure Disaster Recovery.	CloudEndure Disaster Recovery is available in the <a href="#">AWS Marketplace</a> .	General AWS

Task	Description	Skills required
Create a CloudEndure account.	Register for CloudEndure and create an account. Then, in email, confirm the subscription.	General AWS
Set the account password and accept terms and conditions.	Passwords must be at least eight characters long and must contain at least one uppercase letter, one lowercase letter, one digit, and one special character.	General AWS

## Create a CloudEndure project

Task	Description	Skills required
Sign in to the CloudEndure User Console.	On the <a href="#">CloudEndure User Console</a> , sign in with the credentials you created in the previous step.	CloudEndure administrator
Create a new project.	In the upper-left corner of the console, choose the plus (+) button to create a project. Select <b>Disaster Recovery</b> as the project type. You can acquire a license through AWS Marketplace.	CloudEndure administrator

## Generate and use AWS credentials

Task	Description	Skills required
<p>Create an IAM policy for the CloudEndure solution.</p>	<p>The AWS Identity and Access Management (IAM) policy that you must create for running CloudEndure solution is based on a predefined <a href="#">CloudEndure policy</a>. This CloudEndure policy contains the necessary permissions for using AWS as your target infrastructure.</p>	<p>AWS systems administrator</p>
<p>Create a new IAM user and generate AWS credentials.</p>	<p>To generate the required AWS credentials for the CloudEndure User Console, create at least one IAM user and assign the CloudEndure permissions policy to this user. The console requires an <a href="#">access key ID and a secret access key</a>.</p> <p>To follow best practices for managing AWS access keys, you should <a href="#">rotate IAM keys</a> periodically. Changing IAM keys will cause replication servers to restart, resulting in a temporary lag.</p>	<p>AWS systems administrator</p>
<p>Set up the staging area account credentials.</p>	<p>Sign in to the <a href="#">CloudEndure User Console</a>, and select your migration project.</p> <p>On the <b>Setup &amp; Info</b> tab, navigate to AWS credentials,</p>	<p>AWS systems administrator</p>

Task	Description	Skills required
	and provide your AWS access key ID and secret access key ID.	

## Configure replication settings

Task	Description	Skills required
Define the replication servers.	For more information, see the <a href="#">CloudEndure documentation</a> .	CloudEndure administrator

## Installing CloudEndure Agents on your source machine

Task	Description	Skills required
Locate your Agent installation token.	<p>On the CloudEndure User Console, navigate to <b>Machines, Machine Actions, Add Machines</b>.</p> <p>When you run the installer file on a source machine, you are first asked to enter your installation token. The token is a unique string of characters that is automatically generated for you when your CloudEndure account is activated. You can use one installation token to install the Agent on as many source machines as your project allows.</p>	CloudEndure administrator



Task	Description	Skills required
On Linux machines, run the installer.	<p>For Linux machines, copy the installer command, log in to your source machines, and run the installer.</p> <p>For detailed instructions, see the <a href="#">CloudEndure documentation</a>.</p>	CloudEndure administrator
On Windows machines, run the installer.	<p>For Windows machines, download the installer file to each machine, and then run the installer command.</p> <p>For detailed instructions, see the <a href="#">CloudEndure documentation</a>.</p>	CloudEndure administrator
Replicate the data.	<p>After the Agent is installed , CloudEndure starts to replicate the source machine starts to the staging area. When the initial sync is completed, the machine appears on the <b>Machines</b> tab on the CloudEndure User Console.</p>	CloudEndure administrator

### Configure the target machine's Blueprint

Task	Description	Skills required
Choose the source machine for the Blueprint.	On the CloudEndure User Console, on the <b>Machines</b> tab, choose the source machine to	CloudEndure administrator

Task	Description	Skills required
	access the <b>Machine Details</b> pane.	
Configure the Blueprint for the target machine.	On the <b>Blueprint</b> tab, configure the settings for your target machine based on your requirements. For detailed instructions, see the <a href="#">CloudEndure documentation</a> .	CloudEndure administrator

### Test your DR solution

Task	Description	Skills required
Use Test Mode to test the solution.	For detailed instructions on Test Mode and test cutover verification, see the <a href="#">CloudEndure documentation</a> .	CloudEndure administrator
Test your target instance launched on the Amazon EC2 server.	To test each of your target machines, choose the machine's name. Then open the <b>Target</b> tab, copy the new IP address, and log in to the newly launched server on the Amazon EC2 instance.	CloudEndure administrator

### Perform a failover with CloudEndure

Task	Description	Skills required
Verify source machine status.	On the CloudEndure User Console <b>Machines</b> page, verify that the source	CloudEndure administrator

Task	Description	Skills required
	<p>machine you want to fail over has the following status indications:</p> <ul style="list-style-type: none"><li>• <b>Data Replication Progress – Continuous Data Protection</b></li><li>• <b>Status</b> – Rocket icon, which indicates that the target machine can be launched</li><li>• <b>Disaster Recovery Lifecycle – Tested Recently</b></li></ul>	
Start the cutover.	<ol style="list-style-type: none"><li>1. On the <b>Machines</b> page, choose your source machine.</li><li>2. On the <b>Launch Target Machines</b> tab, choose <b>Recovery Mode</b>.</li><li>3. Choose the recovery point for the target machine. The system will use the recovery point when launching the new target machines for the failover. You can use the latest recovery point or choose a previous recovery point from the list.</li><li>4. Choose <b>Continue with Launch</b>.</li></ol>	CloudEndure administrator

Task	Description	Skills required
Check the job progress and completion status.	<p>The <b>Job Progress</b> window displays details for the target machine launch process.</p> <p>After the failover is complete, the <b>Disaster Recovery Lifecycle</b> status on the CloudEndure User Console changes to <b>Failed over</b> to indicate successful completion.</p>	CloudEndure administrator

### Perform a failback with the CloudEndure Failback Client

Task	Description	Skills required
Review the CloudEndure Failback Client requirements.	<p>Use the CloudEndure Failback Client for replicating from an on-premises or other cloud infrastructure to AWS. The CloudEndure Failback Client has the following requirements:</p> <ul style="list-style-type: none"> <li>• Machines must be configured to boot in BIOS mode, supporting MBR boot. Machines configured to boot in UEFI mode, supporting GPT boot only, are not supported.</li> <li>• The CloudEndure Failback Client requires at least 4 GB of dedicated RAM.</li> </ul>	CloudEndure administrator

Task	Description	Skills required
Prepare for failback.	<p>Before you can initiate the Prepare for Failback action, all source machines must have launched target machines in either Test Mode or Recovery Mode.</p> <p>On the <b>Project Actions</b> menu, choose <b>Prepare for Failback</b>, and then choose <b>Continue</b>. When <b>Pair the CloudEndure Agent with the Failback Client</b> is displayed , the machines are ready for failback.</p>	CloudEndure administrator

Task	Description	Skills required
<p>Download the CloudEndure Failback Client in your on-premises environment.</p>	<p>To download the CloudEndure Failback Client into your source environment, do the following:</p> <ol style="list-style-type: none"><li data-bbox="594 449 1019 533">1. In your DR project, choose <b>Setup &amp; Info</b>.</li><li data-bbox="594 554 1019 777">2. On the <b>Replication Settings</b> page, choose the <b>Learn about failing back to “Other Infrastructure”</b> link.</li><li data-bbox="594 798 1019 1020">3. In the <b>Failing Back to an Unidentified Cloud/Other Infrastructure</b> dialog box, choose <b>download from here</b>.</li></ol> <p>The file will automatically be downloaded.</p>	<p>CloudEndure administrator</p>

Task	Description	Skills required
Initiate replication of the on-premises machine.	<p>To initiate replication of source machine, the target machine must be booted into the CloudEndure Failback Client Image (<code>failback_client.iso</code> ). If the client can't fetch the networking settings using the Dynamic Host Configuration Protocol (DHCP), enter the settings manually.</p> <p>The CloudEndure Failback Client connects to <code>console.cloudendure.com</code> over TCP port 443, and authenticates using the CloudEndure credentials that you are prompted to enter.</p>	CloudEndure administrator

Task	Description	Skills required
Follow the instructions to provide the necessary details.	<p>Provide the following details:</p> <ul style="list-style-type: none"><li>• Installation token</li><li>• Machine ID of the source machine</li><li>• Disk mapping between source and target</li></ul> <p>Make sure that the CloudEndure Failback Client has connectivity to the CloudEndure User Console and the target machine through public or private IP addresses.</p>	CloudEndure administrator
Locate the source machine ID.	To locate the source machine ID, choose the machine name on the <b>Machines</b> tab, and copy the ID from the <b>Source</b> tab.	CloudEndure administrator



Task	Description	Skills required
Connect the source machine to the target machine.	<p>Provide the source machine ID (the server on AWS is now the source for the failback) in the on-premises server (target machine). The AWS machine (source) connects to the on-premises server (target) on TCP port 1500 to start the replication.</p> <p>After the initial replication is complete, the CloudEndure User Console indicates that replication is in <b>Continuous Data Protection</b> mode.</p>	CloudEndure administrator
Edit the failback settings, if necessary.	To edit the failback settings, choose the machine name, and then choose the <b>Failback Settings</b> tab.	CloudEndure administrator

Task	Description	Skills required
Launch the target machine.	<p>To launch the target machine, do the following:</p> <p>Select the check box to the left of each machine name, and choose <b>Launch x Target Machine</b>, and then choose <b>Recovery Mode</b>.</p> <p>In the dialog box, choose <b>Next</b>.</p> <p>Choose the <b>Latest</b> recovery point, and then choose <b>Continue with Launch</b>.</p> <p>After the launch process is complete, the CloudEndure User Console displays the status <b>Pair the CloudEndure Agent with the Replication Server</b> under <b>Data Replication Progress</b>.</p>	CloudEndure administrator

Task	Description	Skills required
Return the machines to normal operation.	<p>Now change the direction of data replication so that the on-premises machine is the source and the AWS machine is the target. Choose Project Actions, and then choose <b>Return to Normal</b> and <b>Continue</b>.</p> <p>The direction of data replication is reversed, and the machines undergo the initial sync process. The failback process is complete when the <b>Data Replication Progress</b> column displays the <b>Continuous Data Protection</b> status for all machines.</p>	CloudEndure administrator

## Related resources

### AWS Marketplace

- [CloudEndure Disaster Recovery](#)

### CloudEndure documentation

- [Signing in to the console](#)
- [Creating a project](#)
- [Generating and using credentials](#)
- [Configuring replication settings](#)
- [Installing CloudEndure Agents](#)
- [Performing Disaster Recovery failover](#)

## Tutorials and videos

- [CloudEndure troubleshooting playbook](#)
- [CloudEndure videos](#)
- [Disaster Recovery to AWS demo](#)

## More patterns

- [Access AWS services from IBM z/OS by installing the AWS CLI](#)
- [Automate event-driven backups from CodeCommit to Amazon S3 using CodeBuild and CloudWatch Events](#)
- [Automatically archive items to Amazon S3 using DynamoDB TTL](#)
- [Automatically back up SAP HANA databases using Systems Manager and EventBridge](#)
- [Back up and archive mainframe data to Amazon S3 using BMC AMI Cloud Data](#)
- [Build an ETL service pipeline to load data incrementally from Amazon S3 to Amazon Redshift using AWS Glue](#)
- [Convert and unpack EBCDIC data to ASCII on AWS by using Python](#)
- [Convert VARCHAR2\(1\) data type for Oracle to Boolean data type for Amazon Aurora PostgreSQL](#)
- [Create an Amazon ECS task definition and mount a file system on EC2 instances using Amazon EFS](#)
- [Deliver DynamoDB records to Amazon S3 using Kinesis Data Streams and Firehose with AWS CDK](#)
- [Deploy a Lustre file system for high-performance data processing by using Terraform and DRA](#)
- [Estimate storage costs for an Amazon DynamoDB table](#)
- [Identify public S3 buckets in AWS Organizations using Security Hub](#)
- [Migrate Amazon RDS for Oracle DB instances to other accounts that use AMS](#)
- [Migrate an on-premises SFTP server to AWS using AWS Transfer for SFTP](#)
- [Migrate an Oracle partitioned table to PostgreSQL by using AWS DMS](#)
- [Migrate data from Microsoft Azure Blob to Amazon S3 by using Rclone](#)
- [Migrate Oracle CLOB values to individual rows in PostgreSQL on AWS](#)
- [Migrate shared file systems in an AWS large migration](#)
- [Migrate small sets of data from on premises to Amazon S3 using AWS SFTP](#)
- [Monitor Amazon Aurora for instances without encryption](#)
- [Move mainframe files directly to Amazon S3 using Transfer Family](#)
- [Remove Amazon EC2 entries in the same AWS account from AWS Managed Microsoft AD by using AWS Lambda automation](#)
- [Run stateful workloads with persistent data storage by using Amazon EFS on Amazon EKS with AWS Fargate](#)
- [Successfully import an S3 bucket as an AWS CloudFormation stack](#)

- [Synchronize data between Amazon EFS file systems in different AWS Regions by using AWS DataSync](#)
- [View EBS snapshot details for your AWS account or organization](#)

# Web & mobile apps

## Topics

- [Authenticate existing React application users by using Amazon Cognito and AWS Amplify UI](#)
- [Continuously deploy a modern AWS Amplify web application from an AWS CodeCommit repository](#)
- [Create a React app by using AWS Amplify and add authentication with Amazon Cognito](#)
- [Deploy a React-based single-page application to Amazon S3 and CloudFront](#)
- [Deploy an Amazon API Gateway API on an internal website using private endpoints and an Application Load Balancer](#)
- [Embed an Amazon QuickSight dashboard in a local Angular application](#)
- [Explore full-stack cloud-native web application development with Green Boost](#)
- [Run unit tests for a Node.js application from GitHub by using AWS CodeBuild](#)
- [More patterns](#)

# Authenticate existing React application users by using Amazon Cognito and AWS Amplify UI

Created by Daniel Kozhemyako (AWS)

**Environment:** Production

**Technologies:** Web & mobile apps; Security, identity, compliance; Business productivity; Analytics

**AWS services:** Amazon Cognito; AWS Amplify; Amazon Connect; AWS Management Console

## Summary

This pattern shows how to add authentication capabilities to an existing frontend React application by using an AWS Amplify UI library and an Amazon Cognito user pool.

The pattern uses Amazon Cognito to provide authentication, authorization, and user management for the application. It also uses a component from [Amplify UI](#), an open-source library that extends the capabilities of AWS Amplify to user interface (UI) development. The [Authenticator UI](#) component manages login sessions and runs the cloud-connected workflow that authenticates users through Amazon Cognito.

After you implement this pattern, users can sign in by using any of the following credentials:

- User name and password
- Social identity providers, such as Apple, Facebook, Google, and Amazon
- Enterprise identity providers that are either SAML 2.0 compatible or OpenID Connect (OIDC) compatible

**Note:** To create a custom authentication UI component, you can run the Authenticator UI component in headless mode.

## Prerequisites and limitations

### Prerequisites

- An active AWS account



- A React 18.2.0 or later web application
- Node.js and npm 6.14.4 or later, [installed](#)

## Limitations

- This pattern applies to React web applications only.
- This pattern uses a prebuilt Amplify UI component. The solution doesn't cover the steps required to implement a custom UI component.

## Product versions

- Amplify UI 6.1.3 or later (Gen 1)
- Amplify 6.0.16 or later (Gen 1)

## Architecture

### Target architecture

The following diagram shows an architecture that uses Amazon Cognito to authenticate users for a React web application.

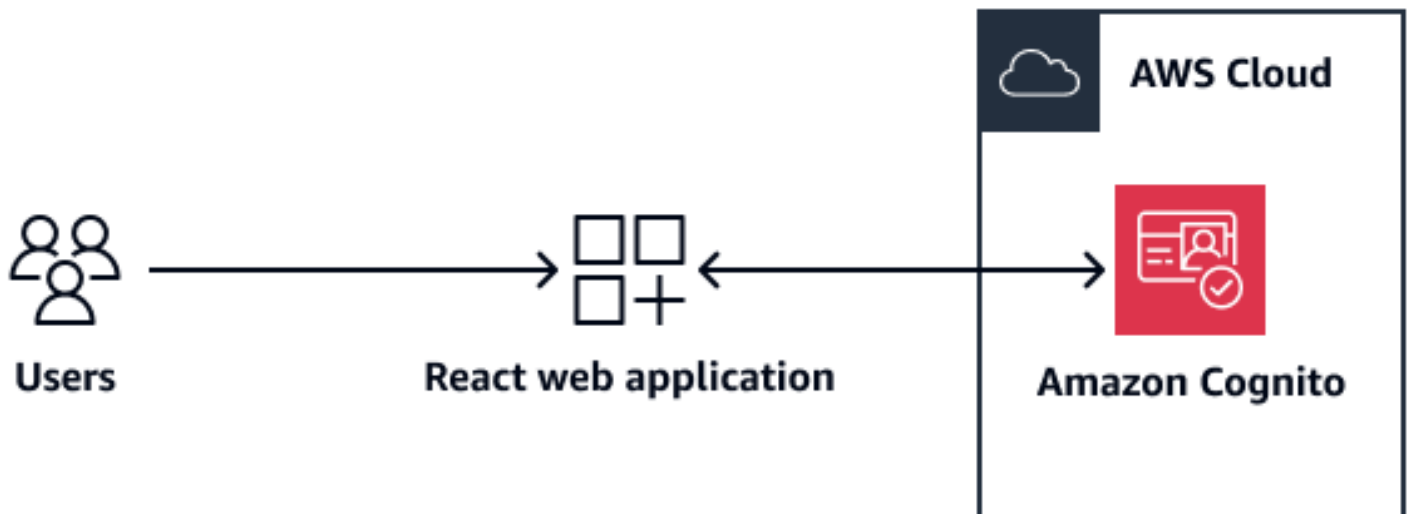

## Tools

### AWS services

- [Amazon Cognito](#) provides authentication, authorization, and user management for web and mobile apps.

## Other tools

- [Amplify UI](#) is an open-source UI library that provides customizable components that you can connect to the cloud.
- [Node.js](#) is an event-driven JavaScript runtime environment designed for building scalable network applications.
- [npm](#) is a software registry that runs in a Node.js environment and is used to share or borrow packages and manage deployment of private packages.

## Best practices

If you're building a new application, we recommend that you use Amplify Gen 2.

## Epics

### Create an Amazon Cognito user pool

Task	Description	Skills required
Create a user pool.	<a href="#">Create an Amazon Cognito user pool</a> . Configure the user pool's sign-in options and security requirements to fit your use case.	App developer
Add an app client.	<a href="#">Configure a user pool app client</a> . This client is required for your application to interact with the Amazon Cognito user pool.	App developer

## Integrate your Amazon Cognito user pool with the Authenticator UI component

Task	Description	Skills required
Install dependencies.	<p>To install the <code>aws-amplify</code> and <code>@aws-amplify/ui-react</code> packages, run the following command from your application's root directory:</p> <pre>npm i @aws-amplify/ui-react aws-amplify</pre>	App developer
Configure the user pool.	<p>Based on the following example, create an <code>aws-exports.js</code> file and save in the <code>src</code> folder. The file should include the following information:</p> <ul style="list-style-type: none"><li>• AWS Region that your Amazon Cognito user pool is in</li><li>• Amazon Cognito user pool ID</li><li>• App client ID</li></ul> <pre>// replace the user pool region, id, and app client id details const awsmobile = {   "aws_project_region": "put_your_region_here",   "aws_cognito_region": "put_your_region_here",</pre>	App developer

Task	Description	Skills required
	<pre>        "aws_user_pools_id": "put_your_user_pool_id_here",         "aws_user_pools_web_client_id": "put_your_user_pool_app_id_here"     }      export default awsmobile;</pre>	

Task	Description	Skills required
Import and configure the Amplify service.	<ol style="list-style-type: none"><li data-bbox="592 226 1027 499">1. In the application's entry point file (for example, <code>App.js</code>), import and load the <code>aws-exports.js</code> file by entering the following lines of code: <pre data-bbox="634 537 1029 779">import { Amplify }   from 'aws-amplify'; import awsExports   from './aws-exports';</pre></li><li data-bbox="592 793 1027 972">2. Based on the following example, configure the Amplify client by using the <code>aws-exports.js</code> file: <pre data-bbox="634 1010 1029 1287">// Configure Amplify   in index file or root   file Amplify.configure({   ...awsExports });</pre></li></ol> <p data-bbox="630 1325 997 1503">For more information, see <a href="#">Configure Amplify categories</a> in the Amplify documentation.</p>	App developer

Task	Description	Skills required
Add the Authenticator UI component.	<p>To display the Authenticator UI component, add the following lines of code to the application's entry point file (App.js):</p> <pre data-bbox="597 491 1027 730">import { Authenticator } from '@aws-amplify/ui-react'; import '@aws-amplify/ui-react/styles.css';</pre> <p><b>Note:</b> The example code snippet imports the Authenticator UI component and the Amplify UI styles.css file, which is required when using the component's prebuilt themes.</p> <p>The Authenticator UI component provides two return values:</p> <ul data-bbox="597 1310 1027 1451" style="list-style-type: none"><li>• User details</li><li>• A function that can be invoked to sign the user out</li></ul> <p>See the following example component:</p> <pre data-bbox="597 1646 1027 1858">function App() {   return (     &lt;Authenticator&gt;       {{{ signOut,         user }}} =&gt; (</pre>	App developer

Task	Description	Skills required
	<pre data-bbox="597 205 1023 781">&lt;div&gt;   &lt;p&gt;Welcome {user.userName}&lt;/p&gt;   &lt;button onClick={signOut}&gt;Sign out&lt;/button&gt; &lt;/div&gt; }) &lt;/Authenticator&gt; ); }</pre> <p data-bbox="597 823 1023 1003"><b>Note:</b> For an example <code>App.js</code> file, see the <a href="#">Additional information</a> section of this pattern.</p>	

Task	Description	Skills required
(Optional) Retrieve session information.	<p>After a user is authenticated, you can retrieve data from the Amplify client about their session. For example, you can retrieve the JSON web token (JWT) from a user's session so that you can authenticate the requests from their session to a backend API.</p> <p>See the following example of a request header that includes a JWT:</p> <pre data-bbox="597 856 1026 1129">import { fetchAuthSession } from 'aws-amplify/auth'; (await fetchAuthSession()).tokens?.idToken?.toString();</pre>	App developer

## Troubleshooting

Issue	Solution
New users can't sign up for the application.	<p>As follows, make sure that your Amazon Cognito user pool is configured to allow users to sign themselves up to be in the user pool:</p> <ul style="list-style-type: none"> <li>• Sign in to the AWS Management Console, and then open the <a href="#">Amazon Cognito console</a>.</li> <li>• In the left navigation pane, choose <b>User pools</b>.</li> <li>• Choose your user pool from the list.</li> </ul>



Issue	Solution
Auth component stopped working after upgrading from v5 to v6.	<ul style="list-style-type: none"><li>• Under <b>General Settings</b>, choose <b>Policies</b>.</li><li>• Choose <b>Allow users to sign themselves up</b>.</li></ul> <p>The Auth category has moved to a functional approach and named parameters in Amplify v6. You must now import the functional APIs directly from the <code>aws-amplify/auth</code> path. For more information, see <a href="#">Migrate from v5 to v6</a> in the Amplify documentation.</p>

## Related resources

- [Getting started with Amazon Cognito](#) (AWS website)
- [Create a new React app](#) (React documentation)
- [What is Amazon Cognito?](#) (Amazon Cognito documentation)
- [Amplify UI library](#) (Amplify documentation)

## Additional information

The `App.js` file should contain the following code:

```
import './App.css';
import { Amplify } from 'aws-amplify';
import awsExports from './aws-exports';
import { fetchAuthSession } from 'aws-amplify/auth';
import { Authenticator } from '@aws-amplify/ui-react';
import '@aws-amplify/ui-react/styles.css';
Amplify.configure({ ...awsExports });
let token = (await fetchAuthSession()).tokens?.idToken?.toString();
function App() {
  return (
    <Authenticator>
      {{{ signOut, user }}} => (
        <div>
          <p>Welcome {user.username}</p>
          <p>Your token is: {token}</p>
        </div>
      )
    </Authenticator>
  );
}
```

```
        <button onClick={signOut}>Sign out</button>
      </div>
    )}
  </Authenticator>
);
}

export default App;
```

# Continuously deploy a modern AWS Amplify web application from an AWS CodeCommit repository

Created by Deekshitulu Pentakota (AWS) and Sai Katakam (AWS)

**Environment:** PoC or pilot

**Technologies:** Web & mobile apps; DevOps; Modernization

**AWS services:** AWS Amplify; AWS CodeCommit

## Summary

[Modern web applications](#) are constructed as single-page applications (SPAs) that package all application components into static files. By using AWS Amplify Hosting, you can build a continuous integration and continuous deployment (CI/CD) pipeline that builds, deploys, and hosts a modern web application that is managed in a Git-based repository. When you connect Amplify Hosting to the code repository, each commit initiates a single workflow to deploy the application frontend and backend. The benefit of this approach is that the web application is updated only after the deployment is successfully completed, which prevents inconsistencies between the frontend and backend.

In this pattern, you use an AWS CodeCommit repository to manage your modern web application. The sample web application in these instructions uses the React SPA framework. However, Amplify Hosting supports many other SPA frameworks, such as Angular, Vue, Next.js, and it also support single-site generators, such as Gatsby, Hugo, and Jekyll.

This pattern is intended for AWS builders who have experience with the following services and concepts:

- AWS CodeCommit
- AWS Amplify Hosting
- React
- JavaScript
- Node.js
- npm
- Git

# Prerequisites and limitations

## Prerequisites

- An active AWS account.
- Permissions to create resources in Amplify and CodeCommit. For more information, see [Identity and Access Management for Amplify](#) and [Identity and Access Management for AWS CodeCommit](#).
- AWS Command Line Interface (AWS CLI), [installed](#) and [configured](#).
- A text editor or code editor.
- CodeCommit, [set up for HTTPS users using Git credentials](#).
- An [IAM service role](#) for Amplify.
- npm and Node.js, [installed](#) (npm documentation).

## Limitations

- This pattern doesn't discuss development and integration of a backend for the Amplify application, such as an API, authentication, or database. For more information about backends, see [Create a backend](#) in the Amplify documentation.

## Product versions

- AWS CLI version 2.0
- Node.js version 16.x or later

## Architecture

### Target technology stack

- AWS CodeCommit repository containing a React SPA
- AWS Amplify Hosting workflow

### Target architecture

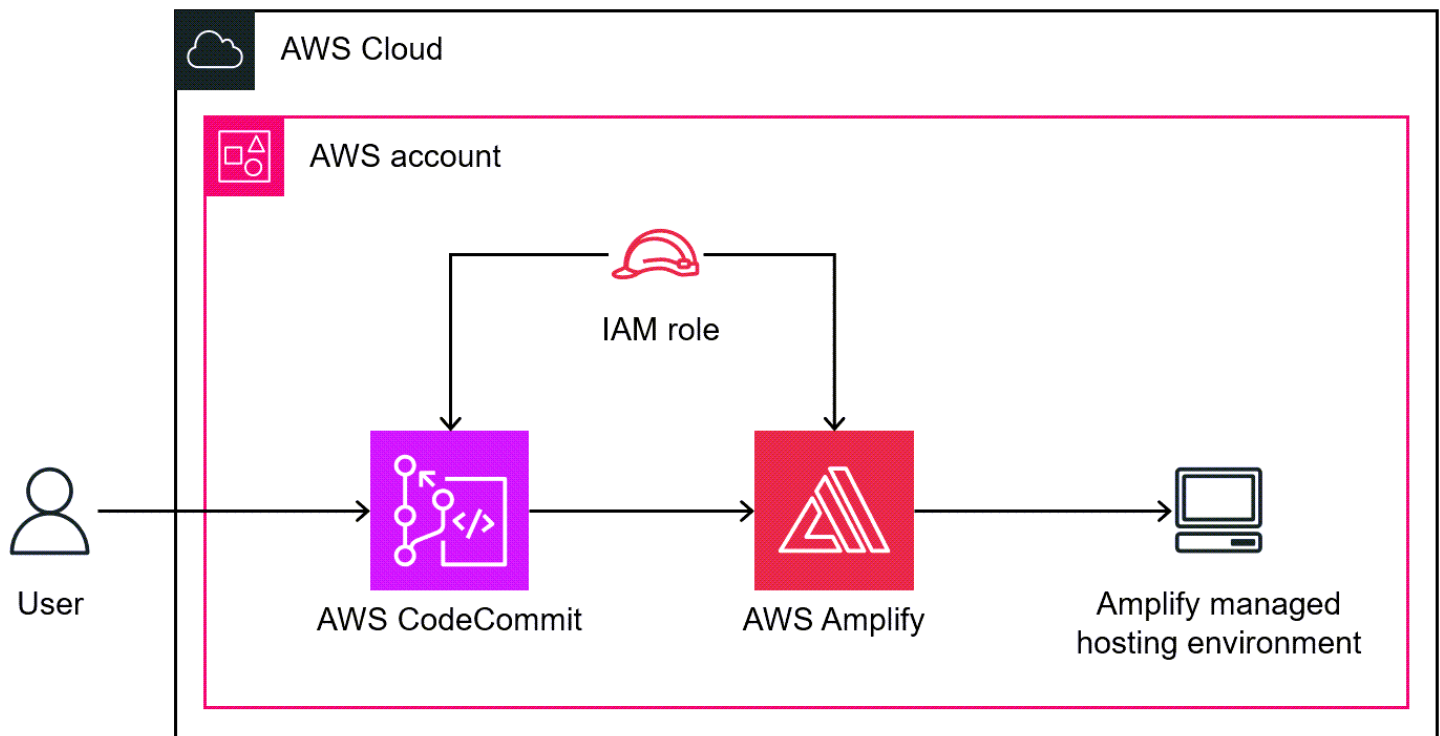

## Tools

### AWS services

- [AWS Amplify Hosting](#) provides a Git-based workflow for hosting full-stack serverless web applications with continuous deployment.
- [AWS CodeCommit](#) is a version control service that helps you privately store and manage Git repositories, without needing to manage your own source control system.
- [AWS Identity and Access Management \(IAM\)](#) helps you securely manage access to your AWS resources by controlling who is authenticated and authorized to use them.

### Other tools

- [Node.js](#) is an event-driven JavaScript runtime environment designed for building scalable network applications.
- [npm](#) is a software registry that runs in a Node.js environment and is used to share or borrow packages and manage deployment of private packages.

# Epics

## Create a CodeCommit repository

Task	Description	Skills required
Create a repository.	For instructions, see <a href="#">Create an AWS CodeCommit repository</a> in the CodeCommit documentation.	AWS DevOps
Clone the repository.	For instructions, see <a href="#">Connect to the CodeCommit repository by cloning the repository</a> in the CodeCommit documentation. If you are prompted, provide the Git credentials.	App developer

## Create a React application

Task	Description	Skills required
Create a new React application.	<ol style="list-style-type: none"><li>Enter the following command to navigate into cloned repo. Replace <code>&lt;repo name&gt;</code> with the name of your CodeCommit repo. <pre>\$ cd &lt;repo name&gt;</pre></li><li>Enter the following command to create a new React application in the cloned repository.</li></ol>	App developer

Task	Description	Skills required
	<pre data-bbox="634 212 1029 327">\$ npx create-react-app .</pre> <p data-bbox="592 344 1003 474">3. Code the application, and then enter the following command to start it.</p> <pre data-bbox="634 512 1029 590">\$ npm start</pre> <p data-bbox="592 659 1010 1171">For more information about creating a custom React application, see the <a href="#">Create React App</a> instructions in the <i>Create React App</i> documentation. You can also deploy a sample React application to your Amplify account by following the instructions in <a href="#">Deploy a frontend</a> in the Amplify documentation.</p>	

Task	Description	Skills required
Create a branch and push the code.	<ol style="list-style-type: none"> <li>1. Enter the following command to create a new branch locally, where <code>&lt;branch&gt;</code> is the name you want to assign to the new branch. <div style="border: 1px solid #ccc; border-radius: 10px; padding: 10px; margin: 10px 0;"> <pre>\$ git checkout -b &lt;branch&gt;</pre> </div> </li> <li>2. Enter the following command to push the branch to the CodeCommit repository, where <code>&lt;branch&gt;</code> is the name you assigned in the previous step. For more information, see <a href="#">Working with commits</a>. <div style="border: 1px solid #ccc; border-radius: 10px; padding: 10px; margin: 10px 0;"> <pre>\$ git push --set-upstream origin &lt;branch&gt;</pre> </div> </li> </ol>	App developer

## Deploy the application in AWS Amplify Hosting

Task	Description	Skills required
Connect Amplify to the repository.	For instructions, see <a href="#">Connect a repository</a> in the Amplify Hosting documentation. Select AWS CodeCommit and the repository and branch you created previously.	App developer
Define the frontend build settings.	For instructions, see <a href="#">Confirm build settings for the</a>	App developer



Task	Description	Skills required
	<p><a href="#">frontend</a> in the Amplify Hosting documentation. Accept the defaults or enter the following.</p> <pre> Build settings: version: 0.1 frontend:   phases:     preBuild:       commands:         - npm ci     build:       commands:         - npm run build   artifacts:     baseDirectory:       build     files:       - '**/*'   cache:     paths:       - node_modules/       **/* </pre>	
Review and deploy.	For instructions, see <a href="#">Save and deploy</a> in the Amplify Hosting documentation. Wait until the deployment process is complete.	App developer

### Validate continuous deployment

Task	Description	Skills required
Verify initial deployment.	When the deployment process is complete, under	App developer

Task	Description	Skills required
	<b>Domain</b> , choose the link. Verify that the application is operating as expected.	
Push a change to the code repository.	Edit the code on your local workstation and push the changes to CodeCommit repository. Amplify Hosting detects the change in the repository and automatically starts the build and deployment process. Confirm that the application updates are visible on the domain.	App developer

## Related resources

### AWS CodeCommit documentation

- [Setting up for AWS CodeCommit](#)
  - [Setup for HTTPS users using Git credentials](#)
  - [Setup steps for HTTPS connections to AWS CodeCommit repositories on Linux, macOS, or Unix with the AWS CLI credential helper](#)
- [Getting started with AWS CodeCommit](#)

### AWS Amplify Hosting documentation

- [Getting started with existing code](#)
- [Setting up custom domains](#)

### React resources

- [Create React App website](#)
- [Create React App documentation](#)

- [Create React App repository](#) (GitHub)

# Create a React app by using AWS Amplify and add authentication with Amazon Cognito

*Created by Rishi Singla (AWS)*

**Environment:** PoC or pilot

**Technologies:** Web & mobile apps; Security, identity, compliance

**Workload:** All other workloads

**AWS services:** AWS Amplify; Amazon Cognito

## Summary

This pattern demonstrates how to use AWS Amplify to create a React-based app and how to add authentication to the frontend by using Amazon Cognito. AWS Amplify consists of a set of tools (open source framework, visual development environment, console) and services (web app and static website hosting) to accelerate the development of mobile and web apps on AWS.

## Prerequisites and limitations

### Prerequisites

- An active AWS account
- [Node.js](#) and [npm](#) installed on your machine

### Product versions

- Node.js version 10.x or later (to verify your version, run `node -v` in a terminal window)
- npm version 6.x or later (to verify your version, run `npm -v` in a terminal window)

## Architecture

### Target technology stack

- AWS Amplify
- Amazon Cognito

## Tools

- [Amplify Command Line Interface \(CLI\)](#)
- [Amplify Libraries](#) (open source client libraries)
- [Amplify Studio](#) (visual interface)

## Epics

### Install AWS Amplify CLI

Task	Description	Skills required
Install the Amplify CLI.	<p>The Amplify CLI is a unified toolchain for creating AWS Cloud services for your React app. To install the Amplify CLI, run:</p> <pre>npm install -g @aws-amplify/cli</pre> <p>npm will notify you if a new major version is available . If so, use the following command to upgrade your version of npm:</p> <pre>npm install -g npm@9.8.0</pre> <p>where 9.8.0 refers to the version you want to install.</p>	App developer

## Create a React app

Task	Description	Skills required
Create a React app.	<p>To create a new React app, use the command:</p> <pre data-bbox="594 449 1027 611">npx create-react-app amplify-react-application</pre> <p>where <code>amplify-react-application</code> is the name of the app.</p> <p>When the app has been created successfully, you will see the message:</p> <pre data-bbox="594 989 1027 1150">Success! Created amplify-react-application</pre> <p>A directory with various subfolders will be created for the React app.</p>	App developer
Launch the app on your local machine.	<p>Go to the directory <code>amplify-react-application</code> that was created in the previous step and run the command:</p> <pre data-bbox="594 1581 1027 1703">amplify-react-application% npm start</pre> <p>This launches the React app on your local machine.</p>	App developer

## Configure the Amplify CLI

Task	Description	Skills required
Configure Amplify to connect to your AWS account.	<p>Configure Amplify by running the command:</p> <pre data-bbox="594 451 1027 611">amplify-react-application % amplify configure</pre> <p>The Amplify CLI asks you to follow these steps to set up access to your AWS account:</p> <ol data-bbox="594 825 1027 1717" style="list-style-type: none"><li>1. Sign in to your AWS administrator account.</li><li>2. Specify the AWS Region you want to use.</li><li>3. Create an AWS Identity and Access Management (IAM) user with programmatic access, and attach the AdministratorAccess-Amplify permissions policy to the user.</li><li>4. Create and then copy the access key ID and secret access key.</li><li>5. Enter these details in the terminal.</li><li>6. Create a profile name or use the default profile.</li></ol> <p><b>Warning:</b> This scenario requires IAM users with</p>	General AWS, App developer

Task	Description	Skills required
	<p>programmatic access and long-term credentials, which present a security risk. To help mitigate this risk, we recommend that you provide these users with only the permissions they require to perform the task and that you remove these users when they are no longer needed. Access keys can be updated if necessary. For more information, see <a href="#">Updating access keys</a> in the <i>IAM User Guide</i>.</p> <p>These steps appear in the terminal as follows.</p> <pre>Follow these steps to set up access to your AWS account: Sign in to your AWS administrator account: https://console.aws.amazon.com/ Press Enter to continue Specify the AWS Region ? region: us-east-1 Follow the instructions at https://docs.amazonaws.com/cli/start/install/#configure-the-amplify-cli to complete the user creation in the AWS console</pre>	



Task	Description	Skills required
	<pre> https://console.aws .amazon.com/iamv2/ home#/users/create Press Enter to continue Enter the access key of the newly created user: ? accessKeyId: ***** ? secretAccessKey: ***** ***** ****  This would update/cr eate the AWS Profile in your local machine ? Profile Name: new  Successfully set up the new user. </pre> <p>For more information about these steps, see the <a href="#">documentation</a> in the Amplify Dev Center.</p>	

## Initialize Amplify

Task	Description	Skills required
Initialize Amplify.	<ol style="list-style-type: none"> <li>To initialize Amplify in the new directory, run: <div data-bbox="630 1612 1029 1692" style="border: 1px solid #ccc; border-radius: 10px; padding: 5px; margin: 10px 0;"> <pre>amplify init</pre> </div> Amplify prompts you for the project name and configuration parameters </li> </ol>	App developer, General AWS

Task	Description	Skills required
	<p>2. Specify all parameters, and then press <b>Y</b> to initialize the project with the specified configuration.</p> <pre data-bbox="630 424 1029 1499">Project information   Name: amplifyre actproject    Environment: dev    Default editor: Visual Studio Code    App type: javascript    Javascript framework: react    Source Directory Path: src    Distribution Directory Path: build    Build Command: npm run-script build    Start Command: npm run-script start</pre>	
	<p>3. Select the profile you created in the previous step. The resources will be deployed into the dev environment in the Amplify project you created.</p>	

Task	Description	Skills required
	<p>4. To confirm that the resources have been created, you can open the <a href="#">AWS Amplify console</a> and view the AWS CloudFormation template that was used to create the resources and the details.</p> <pre data-bbox="630 615 1029 1770"> Deploying root stack amplifyreactproject [ ===== ===== ---- ] 2/4 amplify-amplif yreactproject-d...   AWS::CloudFormatio n::Stack   CREATE_IN_PROGRESS  UnauthRole       AWS::IAM: :Role   CREATE_COMPLETE  DeploymentBucket       AWS::S3:: Bucket   CREATE_IN_PROGRESS  AuthRole       AWS::IAM: :Role   CREATE_COMPLETE </pre>	

## Add authentication to the frontend

Task	Description	Skills required
Adding authentication.	<p>You can use the <code>amplify add &lt;category&gt;</code> command to add features such as a user login or a backend API. In this step you will use the command to add authentication.</p> <p>Amplify provides a backend authentication service with Amazon Cognito, frontend libraries, and a drop-in Authenticator UI component . Features include user sign-up, user sign-in, multi-factor authentication, user sign-out, and passwordless sign-in. You can also authenticate users by integrating with federated identity providers such as Amazon, Google, and Facebook. The Amplify authentication category integrates seamlessly with other Amplify categories such as API, analytics, and storage, so you can define authorization rules for authenticated and unauthenticated users.</p> <ol style="list-style-type: none"><li>1. To configure authentication for your React app, run the command:</li></ol>	App developer, General AWS

Task	Description	Skills required
	<pre>amplify-react-application1 % amplify add auth</pre> <p>This displays the following information and prompts. You can choose the appropriate configuration depending on your business and security requirements.</p> <pre>Using service: Cognito, provided by: awscloudformation The current configured provider is Amazon Cognito. Do you want to use the default authentication and security configuration? (Use arrow keys)  # Default configuration  Default configuration with Social Provider (Federation)  Manual configuration  I want to learn more.</pre>	

Task	Description	Skills required
	<p>2. For a simple example, choose the default configuration and then select the sign-in mechanism for users (in this case, email):</p> <div data-bbox="630 520 1029 1117" style="border: 1px solid #ccc; border-radius: 10px; padding: 10px;"><pre>How do you want users to be able to sign in? Username  # Email  Phone Number  Email or Phone Number  I want to learn more.</pre></div> <p>3. Bypass the advanced settings to complete adding authentication resources:</p> <div data-bbox="630 1348 1029 1747" style="border: 1px solid #ccc; border-radius: 10px; padding: 10px;"><pre>Do you want to configure advanced settings? (Use arrow keys) # No, I am done.  Yes, I want to make some additional changes.</pre></div>	

Task	Description	Skills required
	<p>4. Build your local backend resources and provision them in the cloud:</p> <pre data-bbox="630 380 1029 537">amplify-react-application1 % amplify push</pre> <p>This command makes the appropriate changes to the Congito user pools in your account.</p> <p>5. Press <b>Y</b> to configure the auth resource by using CloudFormation.</p> <p>This configures the following resources:</p> <pre data-bbox="630 1073 1029 1808">UserPool     AWS::Cognito::UserPool     CREATE_COMPLETE UserPoolClientWeb     AWS::Cognito::UserPoolClient     CREATE_COMPLETE  UserPoolClientWeb     AWS::Cognito::UserPoolClient     CREATE_COMPLETE  UserPoolClientRole     AWS::IAM::Role     CREATE_COMPLETE</pre>	

Task	Description	Skills required
	<pre data-bbox="630 205 1029 863"> UserPoolClientLambda     AWS::Lamb da::Function     CREATE_COMPLETE UserPoolClientLam bdaPolicy     AWS::IAM::Policy         CREATE_CO MPLETE  UserPoolClientLog Policy     AWS::IAM::Policy         CREATE_IN _PROGRESS </pre> <p data-bbox="630 898 1000 1129">You can also use the <a href="#">AWS Cognito console</a> to view these resources (look for Cognito user pools and identity pools).</p> <p data-bbox="630 1171 1024 1444">This step updates the <code>aws-exports.js</code> file in the <code>src</code> folder for your React app with the Cognito user pool and identity pool configurations.</p>	

## Change the App.js file

Task	Description	Skills required
Change the App.js file.	In the <code>src</code> folder, open and revise the <code>App.js</code> file. The	App developer



Task	Description	Skills required
	<p>modified file should look like this:</p> <pre data-bbox="597 331 1026 1759">{ App.js File after modifications: import React from 'react'; import logo from './ logo.svg'; import './App.css'; import { Amplify } from 'aws-amplify'; import { withAuthenticator, Button, Heading } from '@aws- amplify/ui-react'; import awsconfig from './aws-exports'; Amplify.configure(a wsconfig); function App({ signOut }) { return ( &lt;div&gt; &lt;h1&gt;Thankyou for doing verification&lt;/ h1&gt; &lt;h2&gt;My Content&lt;/ h2&gt; &lt;button onClick={ signOut}&gt;Sign out&lt;/ button&gt; &lt;/div&gt; ); } export default withAuthenticator( App);</pre>	

Task	Description	Skills required
Import React packages.	<p>The App.js file imports two React packages. Install these packages by using the command:</p> <pre>amplify-react-application1 % npm install --save aws-amplify @aws-amplify/ui-react</pre>	App developer

### Launch the React app and check authentication

Task	Description	Skills required
Launch the app.	<p>Launch the React app on your local machine:</p> <pre>amplify-react-application1 % npm start</pre>	App developer, General AWS
Check authentication.	<p>Check whether the app prompts for authentication parameters. (In our example, we've configured email as the sign-in method.)</p> <p>The frontend UI should prompt you for sign-in credentials and provide an option to create an account.</p> <p>You can also configure the Amplify build process to add the backend as part of a continuous deployment.</p>	App developer, General AWS

Task	Description	Skills required
	t workflow. However, this pattern doesn't cover that option.	

## Related resources

- [Getting started](#) (npm documentation)
- [Create a standalone AWS account](#) (AWS Account Management documentation)
- [AWS Amplify documentation](#)
- [Amazon Cognito documentation](#)

# Deploy a React-based single-page application to Amazon S3 and CloudFront

Created by Jean-Baptiste Guillois (AWS)

<b>Code repository:</b> <a href="#">React-based CORS single-page application</a>	<b>Environment:</b> Production	<b>Technologies:</b> Web & mobile apps; CloudNative; Serverless
<b>Workload:</b> All other workloads	<b>AWS services:</b> Amazon CloudFront; Amazon S3; Amazon API Gateway	

## Summary

A single-page application (SPA) is a website or web application that dynamically updates the contents of a displayed webpage by using JavaScript APIs. This approach enhances the user experience and performance of a website because it updates only new data instead of reloading the entire webpage from the server.

This pattern provides a step-by-step approach to coding and hosting an SPA that's written in React on Amazon Simple Storage Service (Amazon S3) and Amazon CloudFront. The SPA in this pattern uses a REST API that's exposed by Amazon API Gateway and also demonstrates best practices for [cross-origin resource sharing \(CORS\)](#).

## Prerequisites and limitations

### Prerequisites

- An active AWS account.
- An integrated development environment (IDE), such as [AWS Cloud9](#).
- Node.js and npm, installed and configured. For more information, see the [Downloads](#) section of the Node.js documentation.
- Yarn, installed and configured. For more information, see the [Yarn documentation](#).
- Git, installed and configured. For more information, see the [Git documentation](#).

# Architecture

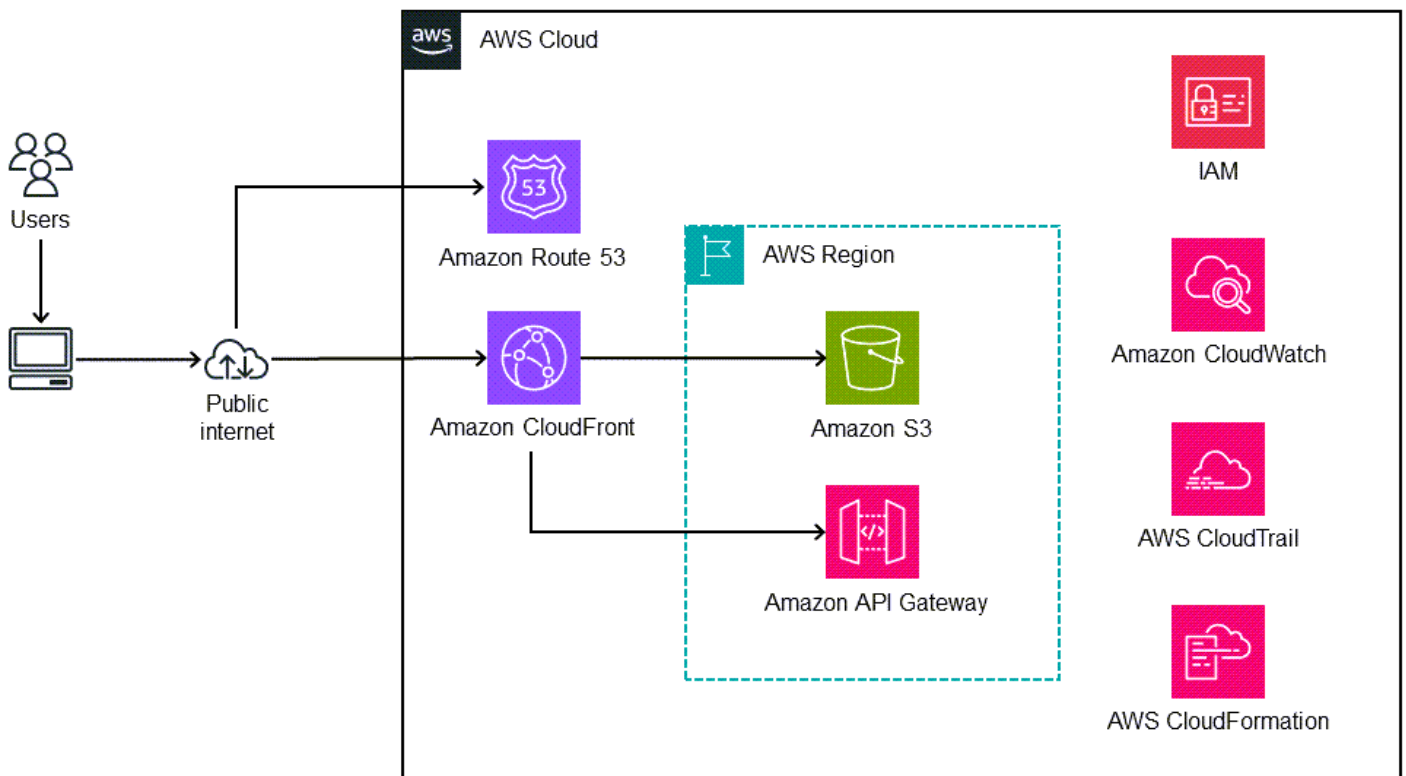

This architecture is automatically deployed by using AWS CloudFormation (infrastructure as code). It uses Regional services such as Amazon S3 to store the static assets and Amazon API Gateway to expose Regional API (REST) endpoints. The application logs are collected by using Amazon CloudWatch. All AWS API calls are audited in AWS CloudTrail. All security configuration (for example, identities and permissions) is managed in Amazon Identity and Access Management (IAM). Static content is delivered through the Amazon CloudFront content delivery network (CDN), and DNS queries are handled by Amazon Route 53.

## Technology stack

- Amazon API Gateway
- Amazon CloudFront
- Amazon Route 53
- Amazon S3
- IAM
- Amazon CloudWatch

- [AWS CloudTrail](#)
- [AWS CloudFormation](#)

## Tools

### AWS services

- [Amazon API Gateway](#) helps you create, publish, maintain, monitor, and secure REST, HTTP, and WebSocket APIs at any scale.
- [AWS Cloud9](#) is an IDE that helps you code, build, run, test, and debug software. It also helps you release software to the AWS Cloud.
- [AWS CloudFormation](#) helps you set up AWS resources, provision them quickly and consistently, and manage them throughout their lifecycle across AWS accounts and Regions.
- [Amazon CloudFront](#) speeds up distribution of your web content by delivering it through a worldwide network of data centers, which lowers latency and improves performance.
- [AWS CloudTrail](#) helps you audit the governance, compliance, and operational risk of your AWS account.
- [Amazon CloudWatch](#) helps you monitor the metrics of your AWS resources and the applications you run on AWS in real time.
- [AWS Identity and Access Management \(IAM\)](#) helps you securely manage access to your AWS resources by controlling who is authenticated and authorized to use them.
- [Amazon Route 53](#) is a highly available and scalable DNS web service.
- [Amazon Simple Storage Service \(Amazon S3\)](#) is a cloud-based object storage service that helps you store, protect, and retrieve any amount of data.

### Code

This pattern's sample application code is available in the GitHub [React-based CORS single-page application](#) repository.

# Epics

## Locally build and deploy your application

Task	Description	Skills required
Clone the repository.	<p>We recommend using AWS Cloud9 as the IDE for this pattern, but you can also use another IDE (for example, Visual Studio Code or IntelliJ IDEA).</p> <p>Run the following command to clone the sample application's repository into your IDE:</p> <pre>git clone https://github.com/aws-samples/react-cors-spa react-cors-spa &amp;&amp; cd react-cors-spa</pre>	App developer, AWS DevOps
Locally deploy the application.	<ol style="list-style-type: none"><li>1. In the project directory, run the <code>npm install</code> command to initiate the application dependencies.</li><li>2. Run the <code>yarn start</code> command to start the application locally.</li></ol>	App developer, AWS DevOps
Locally access the application.	Open a browser window and enter the <code>http://localhost:3000</code> URL to access the application.	App developer, AWS DevOps

## Deploy the application

Task	Description	Skills required
Deploy the AWS CloudFormation template.	<ol style="list-style-type: none"><li>1. Sign in to the AWS Management Console, and then open the AWS CloudFormation console.</li><li>2. Choose <b>Create Stack</b>, and then choose <b>With new resources (standard)</b>.</li><li>3. Choose <b>Upload a template file</b>.</li><li>4. Choose <b>Choose file</b>, choose the <code>react-cors-spa-stack.yaml</code> file from the cloned repository, and then choose <b>Next</b>.</li><li>5. Enter a name for your stack, and then choose <b>Next</b>.</li><li>6. Keep all default options, and then choose <b>Next</b>.</li><li>7. Review the final settings for your stack, and then choose <b>Create stack</b>.</li></ol>	App developer, AWS DevOps
Customize your application source files.	<ol style="list-style-type: none"><li>1. After your stack is deployed, open the <b>Output</b> tab and identify the APIEndpoint URL, Bucket name, and CFDistributionURL .</li><li>2. Copy the API endpoint URL.</li></ol>	App developer



Task	Description	Skills required
	3. Navigate to <code>&lt;project_root&gt;/src/App.js</code> , and then paste the URL into the <code>APIEndPoint</code> variable value on line 26 of the <code>App.js</code> file.	
Build the application package.	In your project directory, run the <code>yarn build</code> command to build the application package.	App developer
Deploy the application package.	<ol style="list-style-type: none"><li>1. Open the Amazon S3 console.</li><li>2. Identify and choose the S3 bucket that you created earlier.</li><li>3. Choose <b>Upload</b>, and then choose <b>Add files</b>.</li><li>4. Choose the content of your build folder.</li><li>5. Choose <b>Add folder</b>, and then choose the static directory. <b>Important:</b> Don't choose the contents; choose the directory.</li><li>6. Choose <b>Upload</b> to upload the files and directory to your S3 bucket.</li></ol>	App developer, AWS DevOps

## Test the application

Task	Description	Skills required
Access and test the application.	Open a browser window, and then paste the URL (the <code>CFDistributionURL</code> output from the CloudFormation stack that you deployed previously) to access the application.	App developer, AWS DevOps

## Clean up the resources

Task	Description	Skills required
Delete the S3 bucket contents.	<ol style="list-style-type: none"> <li>1. Open the Amazon S3 console and choose the bucket that was created earlier by the stack (the first bucket whose name starts with <code>react-cors-spa-</code>).</li> <li>2. Choose <b>Empty</b> to delete the bucket's contents.</li> <li>3. Choose the second bucket that was created earlier by the stack (the second bucket whose name starts with <code>react-cors-spa-</code> and ends with <code>-logs</code>).</li> <li>4. Choose <b>Empty</b> to delete the bucket's contents.</li> </ol>	AWS DevOps, App developer
Delete the AWS CloudFormation stack.	1. Open the AWS CloudFormation console and choose	AWS DevOps, App developer

Task	Description	Skills required
	<p>the stack that you created earlier.</p> <ol style="list-style-type: none"><li>2. Choose <b>Delete</b> to delete the stack and all related resources.</li></ol>	

## Additional information

To deploy and host your web application, you can also use [AWS Amplify Hosting](#), which provides a Git-based workflow for hosting full-stack, serverless web apps with continuous deployment. Amplify Hosting is part of [AWS Amplify](#), which provides a set of purpose-built tools and features that enable frontend web and mobile developers to quickly and easily build full-stack applications on AWS.

# Deploy an Amazon API Gateway API on an internal website using private endpoints and an Application Load Balancer

Created by Saurabh Kothari (AWS)

**Environment:** Production

**Technologies:** Web & mobile apps; Networking; Serverless; Infrastructure

**AWS services:** Amazon API Gateway; Amazon Route 53; AWS Certificate Manager (ACM)

## Summary

This pattern shows you how to deploy an Amazon API Gateway API on an internal website that's accessible from an on-premises network. You learn to create a custom domain name for a private API by using an architecture that's designed with private endpoints, an Application Load Balancer, AWS PrivateLink, and Amazon Route 53. This architecture prevents the unintended consequences of using a custom domain name and proxy server to help with domain-based routing on an API. For example, if you deploy a virtual private cloud (VPC) endpoint in a non-routable subnet, your network can't reach API Gateway. A common solution is to use a custom domain name and then deploy the API in a routable subnet, but this can break other internal sites when the proxy configuration passes traffic (`execute-api.{region}.vpce.amazonaws.com`) to AWS Direct Connect. Finally, this pattern can help you meet organizational requirements for using a private API that's unreachable from the internet and a custom domain name.

## Prerequisites and limitations

### Prerequisites

- An active AWS account
- A Server Name Indication (SNI) certificate for your website and API
- A connection from an on-premises environment to an AWS account that's set up by using AWS Direct Connect or AWS Site-to-Site VPN
- A [private hosted zone](#) with a corresponding domain (for example, `domain.com`) that's resolved from an on-premises network and forwards DNS queries to Route 53

- A routable private subnet that's reachable from an on-premises network

## Limitations

For more information about quotas (formerly referred to as limits) for load balancers, rules, and other resources, see [Quotas for your Application Load Balancers](#) in the Elastic Load Balancing documentation.

## Architecture

### Technology stack

- Amazon API Gateway
- Amazon Route 53
- Application Load Balancer
- AWS Certificate Manager
- AWS PrivateLink

### Target architecture

The following diagram shows how an Application Load Balancer is deployed in a VPC that directs web traffic to a website target group or API Gateway target group based on Application Load Balancer listener rules. The API Gateway target group is a list of IP addresses for the VPC endpoint in API Gateway. API Gateway is configured to make the API private with its resource policy. The policy denies all calls that are not from a specific VPC endpoint. Custom domain names in API gateway are updated to use `api.domain.com` for the API and its stage. Application Load Balancer rules are added to route traffic based on the host name.

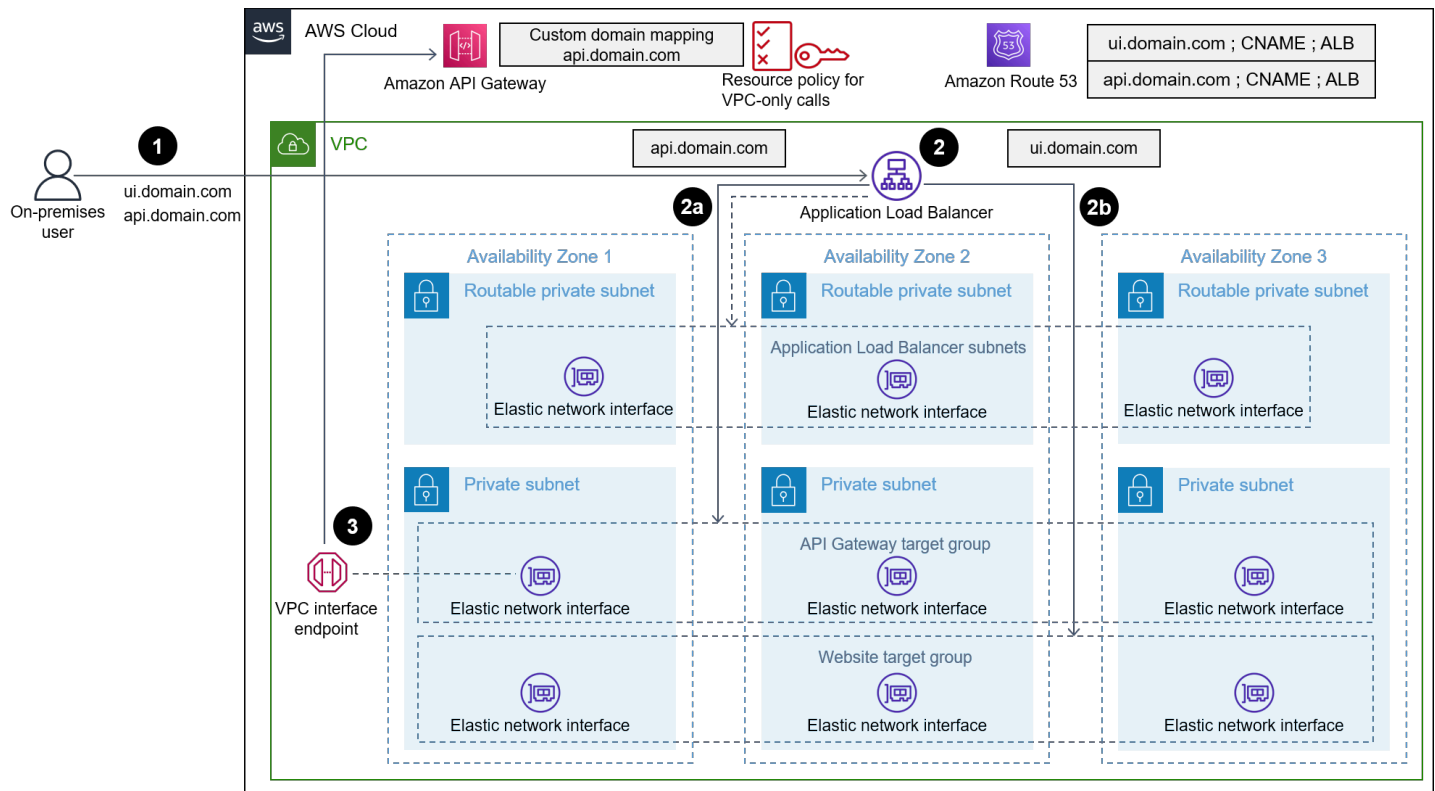

The diagram shows the following workflow:

1. A user from an on-premises network tries to access an internal website. The request is sent to `ui.domain.com` and `api.domain.com`. Then, the request is resolved to the internal Application Load Balancer of the routable private subnet. The SSL is terminated at the Application Load Balancer for `ui.domain.com` and `api.domain.com`.
2. Listener rules, configured on the Application Load Balancer, check for the host header.
  - a. If the host header is `api.domain.com`, the request is forwarded to the API Gateway target group. The Application Load Balancer initiates a new connection to API Gateway over port 443.
  - b. If the host header is `ui.domain.com`, the request is forwarded to the website target group.
3. When the request reaches API Gateway, the custom domain mapping configured in API Gateway determines the hostname and which API to run.

## Automation and scale

The steps in this pattern can be automated by using AWS CloudFormation or the AWS Cloud Development Kit (AWS CDK). To configure the target group of the API Gateway calls, you must use a custom resource to retrieve the IP address of the VPC endpoint. API calls to [describe-vpc-](#)

[endpoints](#) and [describe-network-interfaces](#) return the IP addresses and the security group, which can be used to create the API target group of IP addresses.

## Tools

- [Amazon API Gateway](#) helps you create, publish, maintain, monitor, and secure REST, HTTP, and WebSocket APIs at any scale.
- [Amazon Route 53](#) is a highly available and scalable DNS web service.
- [AWS Certificate Manager \(ACM\)](#) helps you create, store, and renew public and private SSL/TLS X.509 certificates and keys that protect your AWS websites and applications.
- [AWS Cloud Development Kit \(AWS CDK\)](#) is a software development framework that helps you define and provision AWS Cloud infrastructure in code.
- [AWS PrivateLink](#) helps you create unidirectional, private connections from your VPCs to services outside of the VPC.

## Epics

### Create an SNI certificate

Task	Description	Skills required
Create an SNI certificate and import the certificate into ACM.	<ol style="list-style-type: none"><li>1. Create an SNI certificate for ui.domain.com and api.domain.com. For more information, see <a href="#">Choosing how CloudFront serves HTTPS requests</a> in the Amazon CloudFront documentation.</li><li>2. Import the SNI certificates into AWS Certificate Manager (ACM). For more information, see <a href="#">Importing certificates into AWS Certificate Manager</a> in the ACM documentation.</li></ol>	Network administrator

## Deploy a VPC endpoint in a non-routable private subnet

Task	Description	Skills required
Create an interface VPC endpoint in API Gateway.	To create an interface VPC endpoint, follow the instructions from <a href="#">Access an AWS service using an interface VPC endpoint</a> in the Amazon Virtual Private Cloud (Amazon VPC) documentation.	Cloud administrator

## Configure the Application Load Balancer

Task	Description	Skills required
Create a target group for your application.	<a href="#">Create a target group</a> for the UI resources of your application.	Cloud administrator
Create a target group for the API Gateway endpoint.	<ol style="list-style-type: none"> <li><a href="#">Create a target group with an IP address type</a>, and then add the IP address of the VPC endpoint for the API Gateway endpoint to the target group.</li> <li><a href="#">Configure health checks</a> for your target groups with success code 403. 403 is required because the VPC endpoint for the API Gateway returns a 403 code when it is invoked without any headers by the target group health check.</li> </ol>	Cloud administrator



Task	Description	Skills required
Create an Application Load Balancer.	<ol style="list-style-type: none"> <li>1. <a href="#">Create an Application Load Balancer</a> (internal) in a routable private subnet.</li> <li>2. Add the 443 listener to the Application Load Balancer, and choose the certificate from ACM.</li> </ol>	Cloud administrator
Create listeners rules.	<p>Create <a href="#">listener rules</a> to do the following:</p> <ol style="list-style-type: none"> <li>1. Forward the host api.domain.com to the API Gateway target group</li> <li>2. Forward the host ui.domain.com to the target group for the UI resources</li> </ol>	Cloud administrator

### Configure Route 53

Task	Description	Skills required
Create a private hosted zone.	<a href="#">Create a private hosted zone</a> for domain.com.	Cloud administrator
Create domain records.	<p><a href="#">Create CNAME records</a> for the following:</p> <ul style="list-style-type: none"> <li>• An API with the value set to the DNS name of the Application Load Balancer</li> </ul>	Cloud administrator

Task	Description	Skills required
	<ul style="list-style-type: none"> <li>A UI with the value set to the DNS name of the Application Load Balancer</li> </ul>	

## Create a private API endpoint in API Gateway

Task	Description	Skills required
Create and configure a private API endpoint.	<ol style="list-style-type: none"> <li>To create a private API endpoint, follow the instructions from <a href="#">Creating a private API in Amazon API Gateway</a> in the API Gateway documentation.</li> <li>Configure the resource policy to allow calls to only the API from the VPC endpoint. For more information, see <a href="#">Controlling access to an API with API Gateway resource policies</a> in the API Gateway documentation.</li> </ol>	App developer, Cloud administrator
Create a custom domain name.	<ol style="list-style-type: none"> <li>Create a custom domain name for api.domain.com. For more information, see <a href="#">Setting up custom domain names for REST APIs</a> in the API Gateway documentation.</li> <li>Select the created API and stage. For more information, see <a href="#">Working with</a></li> </ol>	Cloud administrator

Task	Description	Skills required
	<a href="#">API mappings for REST APIs</a> in the API Gateway documentation.	

## Related resources

- [Amazon API Gateway](#)
- [Amazon Route 53](#)
- [Application Load Balancer](#)
- [AWS PrivateLink](#)
- [AWS Certificate Manager](#)

# Embed an Amazon QuickSight dashboard in a local Angular application

Created by Sean Griffin (AWS) and Milena Godau (AWS)

**Environment:** PoC or pilot

**Technologies:** Web & mobile apps; Analytics

**AWS services:** AWS Lambda; Amazon QuickSight; Amazon API Gateway

## Summary

This pattern provides guidance for embedding an Amazon QuickSight dashboard into a locally hosted Angular application for development or testing. The [embedded analytics feature](#) in QuickSight doesn't support this functionality natively. It requires an QuickSight account with an existing dashboard and knowledge of Angular.

When you work with embedded QuickSight dashboards, you would typically have to host your application on a web server to view the dashboard. This makes development more difficult, because you have to continuously push your changes to the web server to make sure everything is behaving correctly. This pattern shows how to run a locally hosted server and use QuickSight embedded analytics to make the development process easier and more streamlined.

## Prerequisites and limitations

### Prerequisites

- [An active Amazon Web Services \(AWS\) account](#)
- [An active QuickSight account with session capacity pricing](#)
- [QuickSight Embedding SDK installed](#)
- [Angular CLI installed](#)
- [Familiarity with Angular](#)
- [mkcert installed](#)

### Limitations

- This pattern provides guidance on embedding a QuickSight dashboard by using the ANONYMOUS (publicly accessible) authentication type. If you are using AWS Identity and Access Management (IAM) or QuickSight authentication with your embedded dashboards, the provided code won't apply. However, the steps for hosting the Angular application in the [Epics](#) section are still valid.
- Using the **GetDashboardEmbedUrl** API with the ANONYMOUS identity type requires a QuickSight capacity pricing plan.

## Versions

- [Angular CLI version 13.3.4](#)
- [QuickSight Embedding SDK version 2.3.1](#)

## Architecture

### Technology stack

- Angular frontend
- AWS Lambda and Amazon API Gateway backend

### Architecture

In this architecture, the HTTP APIs in API Gateway enable the local Angular application to call the Lambda function. The Lambda function returns the URL for embedding the QuickSight dashboard.

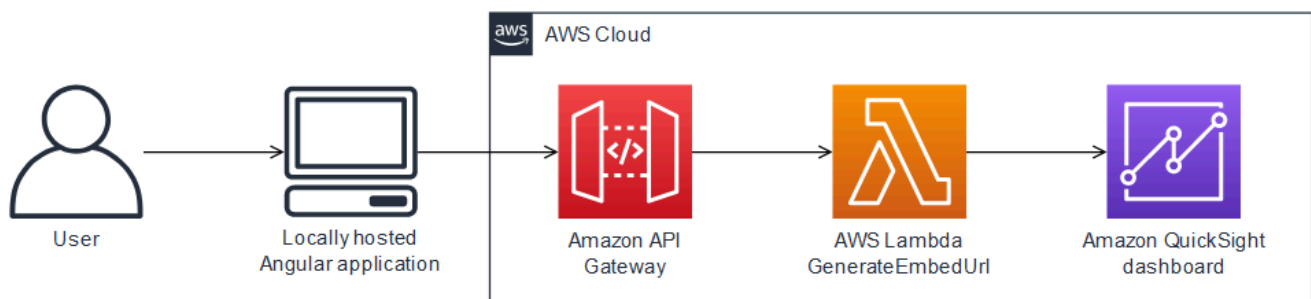

### Automation and scale

You can automate the backend deployment by using AWS CloudFormation or AWS Serverless Application Model (AWS SAM).

## Tools

### Tools

- [Angular CLI](#) is a command-line interface tool that you use to initialize, develop, scaffold, and maintain Angular applications directly from a command shell.
- [QuickSight Embedding SDK](#) is used to embed QuickSight dashboards into your HTML.
- [mkcert](#) is a simple tool for creating locally trusted development certificates. It requires no configuration. mkcert is required because QuickSight allows only HTTPS requests for embedding dashboards.

### AWS services

- [Amazon API Gateway](#) is an AWS service for creating, publishing, maintaining, monitoring, and securing REST, HTTP, and WebSocket APIs at any scale.
- [AWS Lambda](#) is a compute service that supports running code without provisioning or managing servers. Lambda runs your code only when needed and scales automatically, from a few requests per day to thousands per second. You pay only for the compute time that you consume—there is no charge when your code is not running.
- [Amazon QuickSight](#) is a business analytics service for building visualizations, performing ad hoc analyses, and getting business insights from your data.

## Epics

### Generate EmbedURL

Task	Description	Skills required
Create an EmbedUrl policy.	Create an IAM policy named <b>QuicksightGetDashboardEmbedUrl</b> that has the following properties.  <pre>{</pre>	AWS administrator

Task	Description	Skills required
	<pre>        "Version":         "2012-10-17",         "Statement": [             {                 "Effect": "Allow",                 "Action": [                     "quicksight:GetDas                     hboardEmbedUrl",                     "quickSight:GetAno                     nymousUserEmbedUrl"                 ],                 "Resource": "*"             }         ]     }</pre>	

Task	Description	Skills required
Create the Lambda function.	<ol style="list-style-type: none"><li>1. On the Lambda console, open the <a href="#">Functions page</a>.</li><li>2. Choose <b>Create Function</b>.</li><li>3. Choose <b>Author from scratch</b>.</li><li>4. For <b>Function name</b>, enter <code>get-qs-embed-url</code> .</li><li>5. For <b>Runtime</b>, choose <b>Python 3.9</b>.</li><li>6. Choose <b>Create Function</b>.</li><li>7. On the <b>Code</b> tab, copy the following code into the Lambda function.</li></ol> <pre data-bbox="597 1066 1026 1831">import json import boto3 from botocore.exceptions import ClientError import time from os import environ  qs = boto3.client('quicksight', region_name='us-east-1') sts = boto3.client('sts')  ACCOUNT_ID = boto3.client('sts').get_caller_identity().get('Account')</pre>	App developer



Task	Description	Skills required
	<pre>DASHBOARD_ID =   environ['DASHBOARD _ID']  def getDashboardURL(ac countId, dashboardId, quicksightNamespac e, resetDisabled, undoRedoDisabled):   try:     response = qs.get_da shboard_embed_url(     AwsAccountId = accountId,     DashboardId = dashboardId,     Namespace = quicksightNamespace,     IdentityType = 'ANONYMOUS',     SessionLi fetimeInMinutes = 600,     UndoRedoDisabled = undoRedoDisabled,     ResetDisabled = resetDisabled     )     return response    except ClientError as e:     print(e)     return "Error generating embeddedU RL: " + str(e)  def lambda_handler(eve nt, context):     url = getDashbo ardURL(ACCOUNT_ID, DASHBOARD_ID,</pre>	

Task	Description	Skills required
	<pre>"default", True, True) ['EmbedUrl'] return {     'statusCode': 200,     'url': url }</pre> <p>8. Choose <b>Deploy</b>.</p>	

Task	Description	Skills required
Add the dashboard ID as an environment variable.	<p>Add DASHBOARD_ID as an environment variable to your Lambda function:</p> <ol style="list-style-type: none"><li>1. On the <b>Configuration</b> tab, choose <b>Environment variables, Edit, Add environment variable</b>.</li><li>2. Add an environment variable with the key DASHBOARD_ID .</li><li>3. To get the value of DASHBOARD_ID , navigate to your dashboard in QuickSight and copy the UUID at the end of the URL in your browser. For example, if the URL is <code>https://us-east-1.quicksight.aws.amazon.com/sn/dashboards/&lt;dashboard-id&gt;</code> , specify the <code>&lt;dashboard-id&gt;</code> part of the URL as the key value.</li><li>4. Choose <b>Save</b>.</li></ol>	App developer

Task	Description	Skills required
Add permissions for the Lambda function.	<p>Modify the execution role of the Lambda function and add the <b>QuicksightGetDashboardEmbedUrl</b> policy to it.</p> <ol style="list-style-type: none"><li>1. On the <b>Configuration</b> tab, choose <b>Permissions</b>, and then choose the role name.</li><li>2. Choose <b>Attach policies</b>, search for <b>QuicksightGetDashboardEmbedUrl</b> , select its check box, and then choose <b>Attach policy</b>.</li></ol>	App developer

Task	Description	Skills required
Test the Lambda function.	<p>Create and run a test event. You can use the "Hello World" template, because the function won't use any of the data in the test event.</p> <ol style="list-style-type: none"><li>1. Choose the <b>Test</b> tab.</li><li>2. Give your test event a name, and then choose <b>Save</b>.</li><li>3. To test your Lambda function, choose <b>Test</b>. The response should look similar to the following.</li></ol> <pre data-bbox="594 957 1029 1356">{   "statusCode": 200,   "url": "\"https://us-east-1.quicksight.aws.amazon.com/embed/f1acc0786687783b9a4543a05ba929b3a/dashboards/...\"" }</pre> <p><b>Note:</b> As mentioned in the <i>Prerequisites and limitations</i> section, your QuickSight account must be under a session capacity pricing plan. Otherwise, this step will display an error message.</p>	App developer

Task	Description	Skills required
Create an API in API Gateway.	<ol style="list-style-type: none"><li>1. On the <a href="#">API Gateway console</a>, choose <b>Create API</b>, and then choose <b>REST API, Build</b>.<ul style="list-style-type: none"><li>• For API name, enter <code>qs-embed-api</code> .</li><li>• Choose <b>Create API</b>.</li></ul></li><li>2. In <b>Actions</b>, choose <b>Create Method</b>.<ul style="list-style-type: none"><li>• Choose <b>GET</b> and confirm by choosing the checkmark.</li><li>• Choose <b>Lambda Function</b> as the integration type.</li><li>• For <b>Lambda Function</b>, enter <code>get-qs-embed-url</code>.</li><li>• Choose <b>Save</b>.</li><li>• In the <b>Add Permission to Lambda Function</b> box, choose <b>OK</b>.</li></ul></li><li>3. Enable CORS.<ul style="list-style-type: none"><li>• In <b>Actions</b>, choose <b>Enable CORS</b>.</li><li>• For <b>Access-Control-Allow-Origin</b>, enter <code>'https://my-qs-app.net:4200'</code> .</li><li>• Choose <b>Enable CORS and replace existing</b></li></ul></li></ol>	App developer

Task	Description	Skills required
	<p><b>CORS headers</b>, and confirm.</p> <p>4. Deploy the API.</p> <ul style="list-style-type: none"> <li>• For <b>Actions</b>, choose <b>Deploy API</b>.</li> <li>• For <b>Deployment stage</b>, choose <b>[New Stage]</b>.</li> <li>• For <b>Stage name</b>, enter dev.</li> <li>• Choose <b>Deploy</b>.</li> <li>• Copy the <b>Invoke URL</b>.</li> </ul> <p><b>Note:</b> <code>my-qs-app.net</code> can be any domain. If you want to use a different domain name, make sure to update the <b>Access-Control-Allow-Origin</b> information in step 3, and change <code>my-qs-app.net</code> in subsequent steps.</p>	

## Create the Angular application

Task	Description	Skills required
Create the application with the Angular CLI.	<p>1. Create the application.</p> <pre data-bbox="630 1581 1029 1780">ng new quicksight-app --defaults cd quicksight-app/src /app</pre> <p>2. Create the dashboard component.</p>	App developer

Task	Description	Skills required
	<pre>ng g c dashboard</pre> <p>3. Navigate to your <code>src/environments/environment.ts</code> file and add <code>apiUrl: '&lt;Invoke URL from previous steps&gt;'</code> to the environment object.</p> <pre>export const environment = {   production: false,   apiUrl: '&lt;Invoke URL from previous steps&gt;', };</pre>	
Add the QuickSight Embedding SDK.	<p>1. Install the QuickSight Embedding SDK by running the following command in your project's root folder.</p> <pre>npm i amazon-quicksight-embedding-sdk</pre> <p>2. Create a new <code>decl.d.ts</code> file in the <code>src</code> folder with the following content.</p> <pre>declare module 'amazon-quicksight-embedding-sdk';</pre>	App developer



Task	Description	Skills required
Add code to your dashboard .component.ts file.	<pre>import { Component,   OnInit } from '@angular /core'; import { HttpClient }   from '@angular/common/ http'; import * as Quicksigh tEmbedding from   'amazon-quicksight- embedding-sdk'; import { environme nt } from "../..en vironments/envIRON ment"; import { take } from   'rxjs'; import { Embedding Context } from 'amazon- quicksight-embedding- sdk/dist/types'; import { createEmb beddingContext } from   'amazon-quicksight- embedding-sdk';  @Component({   selector: 'app-dash board',   templateUrl: './ dashboard.compo nent.html',   styleUrls: ['./dashb oard.component.scss'] }) export class Dashboard Component implements   OnInit {    constructor(private     http: HttpClient) { }</pre>	App developer

Task	Description	Skills required
	<pre>loadingError = false; dashboard: any;  ngOnInit() {   this.GetDashboardU RL(); }  public GetDashbo ardURL() {   this.http.get(envi ronment.apiUrl)   .pipe(     take(1),   )   .subscribe((data: any) =&gt; this.Dash board(data.url)); }  public async Dashboard (embeddedURL: any) {   var containerDiv = document.getElemen tById("dashboardCo ntainer")    '';   const frameOptions = {     url: embeddedURL,     container: containerDiv,     height: "850px",     width: "100%",     resizeHei ghtOnSizeChangedEv ent: true,   }   const embedding Context: Embedding Context = await createEmbeddingCon text();</pre>	

Task	Description	Skills required
	<pre> this.dashboard =   embeddingContext.e mbedDashboard(fram eOptions); } } </pre>	
<p>Add code to your dashboard .component.html file.</p>	<p>Add the following code to your src/app/dashboard/dashboard.component.html file.</p> <pre> &lt;div id="dashboardConta iner"&gt;&lt;/div&gt; </pre>	<p>App developer</p>
<p>Modify your app.component.html file to load your dashboard component.</p>	<ol style="list-style-type: none"> <li>1. Delete the contents of the src/app/app.component.html file.</li> <li>2. Add the following.</li> </ol> <pre> &lt;app-dashboard&gt;&lt;/a pp-dashboard&gt; </pre>	<p>App developer</p>
<p>Import HttpClientModule into your app.module.ts file.</p>	<ol style="list-style-type: none"> <li>1. At the top of the src/app/app.module.ts file, add the following.</li> </ol> <pre> import { HttpClien tModule } from  '@angular/common/h ttp'; </pre> <ol style="list-style-type: none"> <li>2. Add HttpClientModule in the imports array for your AppModule .</li> </ol>	<p>App developer</p>

## Host the Angular application

Task	Description	Skills required
Configure mkcert.	<p><b>Note:</b> The following commands are for Unix or MacOS machines. If you're using Windows, see the <a href="#">Additional information</a> section for the equivalent <b>echo</b> command.</p> <ol style="list-style-type: none"> <li>1. Create a local certificate authority (CA) on your machine.</li> </ol> <pre>mkcert -install</pre> <ol style="list-style-type: none"> <li>2. Configure <code>my-qs-app.net</code> to always redirect to your local PC.</li> </ol> <pre>echo "127.0.0.1 my-qs-app.net"   sudo tee -a /private/etc/hosts</pre> <ol style="list-style-type: none"> <li>3. Make sure that you're in the <code>src</code> directory of the Angular project.</li> </ol> <pre>mkcert my-qs-app.net 127.0.0.1</pre>	App developer
Configure QuickSight to allow your domain.	<ol style="list-style-type: none"> <li>1. In QuickSight, choose your name in the upper-right corner, and then choose <b>Manage Quicksight</b>.</li> </ol>	AWS administrator

Task	Description	Skills required
	<ol style="list-style-type: none"> <li>2. Navigate to <b>Domains and Embedding</b>.</li> <li>3. Add <code>https://my-qs-app.net:4200</code> as an allowed domain.</li> </ol>	
Test the solution.	<p>Start a local Angular development server by running the following command.</p> <pre style="border: 1px solid #ccc; border-radius: 10px; padding: 10px; background-color: #f9f9f9;">ng serve --host my-qs-app.net --port 4200 --ssl --ssl-key "./src/my-qs-app.net-key.pem" --ssl-cert "./src/my-qs-app.net.pem" -o</pre> <p>This enables Secure Sockets Layer (SSL) with the custom certificate that you created earlier.</p> <p>When the build is complete, it opens a browser window and you can view your embedded QuickSight dashboard hosted locally in Angular.</p>	App developer

## Related resources

- [Angular website](#)
- [Embedding QuickSight data dashboards for anonymous \(unregistered\) users](#) (QuickSight documentation)
- [QuickSight Embedding SDK](#)

- [mkcert tool](#)

## Additional information

If you're using Windows, run the Command Prompt window as an administrator, and configure my-qs-app.net to always redirect to your local PC by using the following command.

```
echo 127.0.0.1 my-qs-app.net >> %WINDIR%\System32\Drivers\Etc\Hosts
```

# Explore full-stack cloud-native web application development with Green Boost

Created by Ben Stickley (AWS) and Amiin Samatar (AWS)

**Environment:** PoC or pilot

**Technologies:** Web & mobile apps

**Workload:** Open-source

**AWS services:** Amazon Aurora; AWS CDK; Amazon CloudFront; AWS Lambda; AWS WAF

## Summary

In response to the evolving needs of developers, Amazon Web Services (AWS) recognizes the critical demand for an efficient approach to developing cloud-native web applications. The AWS focus is on helping you to overcome common roadblocks associated with deploying web apps on the AWS Cloud. By harnessing the capabilities of modern technologies such as TypeScript, AWS Cloud Development Kit (AWS CDK), React, and Node.js, this pattern aims to streamline and expedite the development process.

Underpinned by the Green Boost (GB) toolkit, the pattern offers a practical guide to constructing web applications that fully use the extensive capabilities of AWS. It acts as a comprehensive roadmap, leading you through the process of deploying a fundamental CRUD (Create, Read, Update, Delete) web application integrated with Amazon Aurora PostgreSQL-Compatible Edition. This is accomplished by using the Green Boost command line interface (Green Boost CLI) and establishing a local development environment.

Following the successful deployment of the application, the pattern delves into key components of the web app, including infrastructure design, backend and frontend development, and essential tools such as cdk-dia for visualization, facilitating efficient project management.

## Prerequisites and limitations

### Prerequisites

- [Git](#) installed
- [Visual Studio Code \(VS Code\)](#) installed
- [AWS Command Line Interface \(AWS CLI\)](#) installed
- [AWS CDK Toolkit](#) installed
- [Node.js 18](#) installed, or [Node.js 18 with pnpm](#) activated
- [pnpm](#) installed, if it isn't part of your Node.js installation
- Basic familiarity with TypeScript, AWS CDK, Node.js, and React
- An [active AWS account](#)
- [An AWS account bootstrapped](#) by using AWS CDK in us-east-1. The us-east-1 AWS Region is required for support of the Amazon CloudFront Lambda@Edge functions.
- [AWS security credentials](#), including `AWS_ACCESS_KEY_ID`, correctly configured in your terminal environment
- For Windows users, a terminal in administrator mode (to accommodate the way pnpm handles node modules)

## Product versions

- AWS SDK for JavaScript version 3
- AWS CDK version 2
- AWS CLI version 2.2
- Node.js version 18
- React version 18

## Architecture

### Target technology stack

- Amazon Aurora PostgreSQL-Compatible Edition
- Amazon CloudFront
- Amazon CloudWatch
- Amazon Elastic Compute Cloud (Amazon EC2)
- AWS Lambda



- AWS Secrets Manager
- Amazon Simple Notification Service (Amazon SNS)
- Amazon Simple Storage Service (Amazon S3)
- AWS WAF

## Target Architecture

The following diagram shows that user requests pass through Amazon CloudFront, AWS WAF, and AWS Lambda before interacting with an S3 bucket, an Aurora database, an EC2 instance, and ultimately reaching developers. Administrators, on the other hand, use Amazon SNS and Amazon CloudWatch for notifications and monitoring purposes.

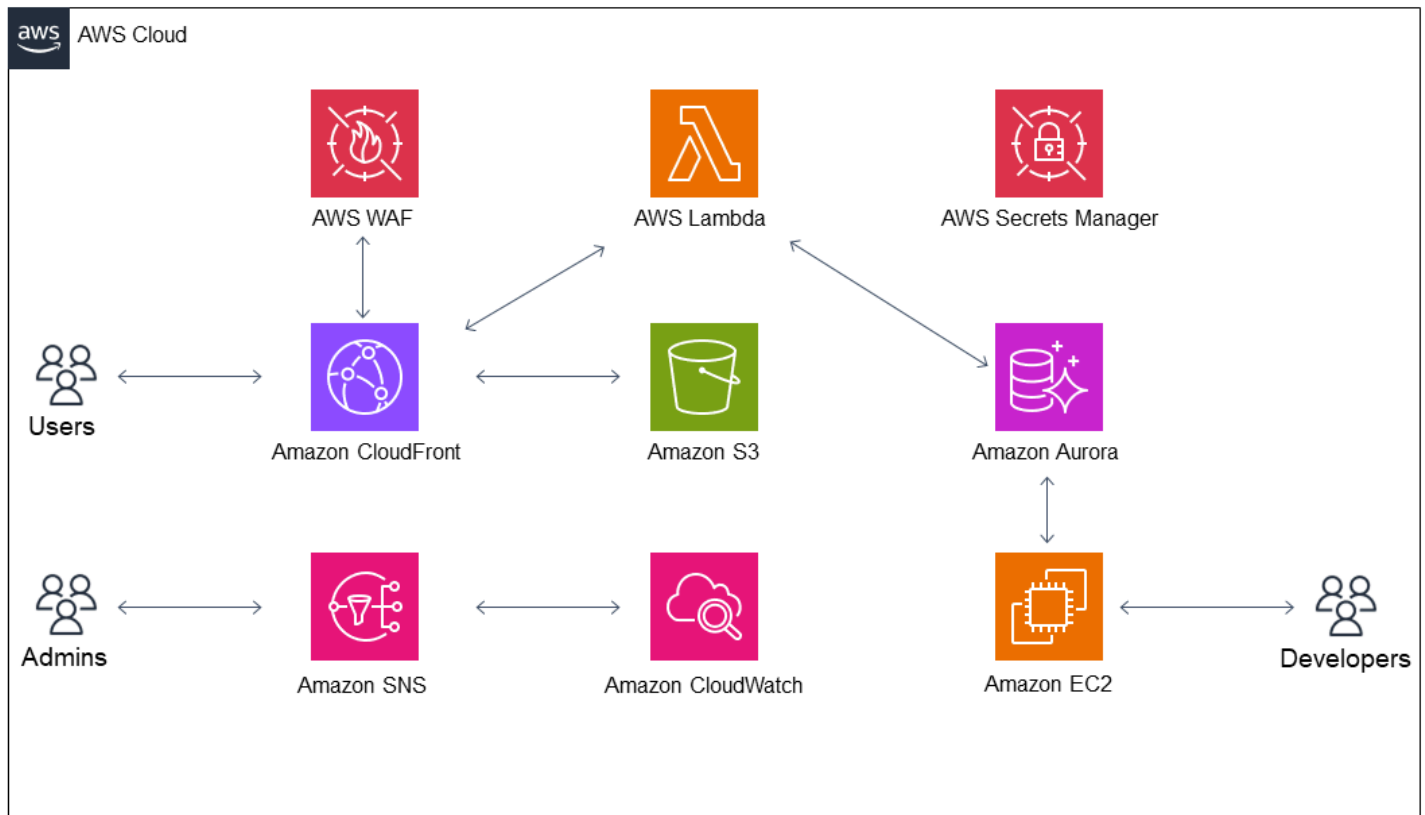

To gain a more in-depth look at the application after deployment, you can create diagram by using [cdk-dia](#), as shown in the following example.

These diagrams showcase the web application architecture from two distinct angles. The `cdk-dia` diagram offers a detailed technical view of the AWS CDK infrastructure, highlighting specific AWS services such as Amazon Aurora PostgreSQL-Compatible and AWS Lambda. In contrast, the other

diagram takes a broader perspective, emphasizing the logical flow of data and user interactions. The key distinction lies in the level of detail: The cdk-dia delves into technical intricacies, while the first diagram provides a more user-centric view.

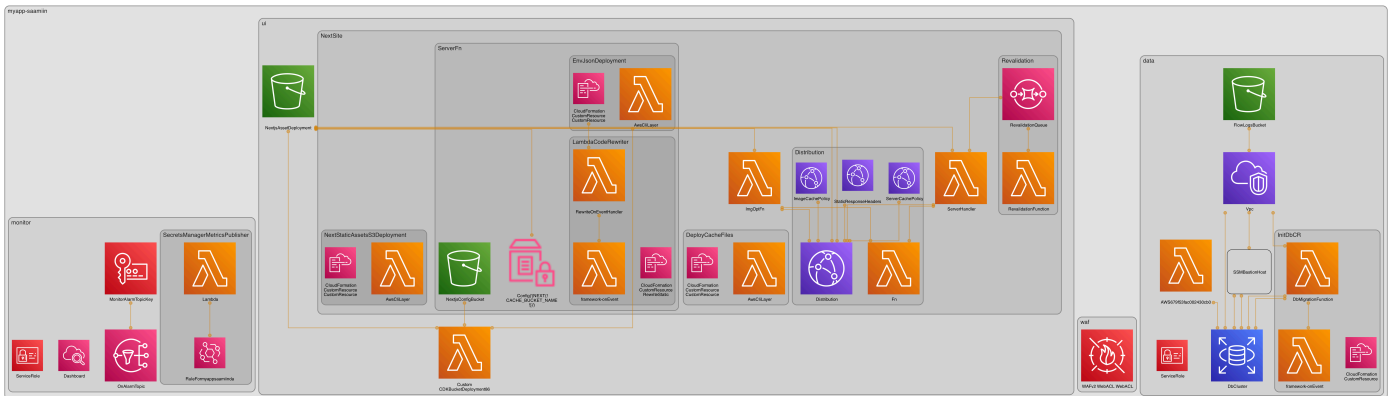

Creation of the cdk-dia diagram is covered in the epic *Understand the app infrastructure by using AWS CDK*.

## Tools

### AWS services

- [Amazon Aurora PostgreSQL-Compatible Edition](#) is a fully managed, ACID-compliant relational database engine that helps you set up, operate, and scale PostgreSQL deployments.
- [AWS Cloud Development Kit \(AWS CDK\)](#) is a software development framework that helps you define and provision AWS Cloud infrastructure in code.
- [AWS Command Line Interface \(AWS CLI\)](#) is an open-source tool that helps you interact with AWS services through commands in your command-line shell.
- [Amazon CloudFront](#) speeds up distribution of your web content by delivering it through a worldwide network of data centers, which lowers latency and improves performance.
- [Amazon CloudWatch](#) helps you monitor the metrics of your AWS resources and the applications you run on AWS in real time.
- [Amazon Elastic Compute Cloud \(Amazon EC2\)](#) provides scalable computing capacity in the AWS Cloud. You can launch as many virtual servers as you need and quickly scale them up or down.
- [AWS Lambda](#) is a compute service that helps you run code without needing to provision or manage servers. It runs your code only when needed and scales automatically, so you pay only for the compute time that you use.

- [AWS Secrets Manager](#) helps you replace hardcoded credentials in your code, including passwords, with an API call to Secrets Manager to retrieve the secret programmatically.
- [AWS Systems Manager](#) helps you manage your applications and infrastructure running in the AWS Cloud. It simplifies application and resource management, shortens the time to detect and resolve operational problems, and helps you manage your AWS resources securely at scale. This pattern uses AWS Systems Manager Session Manager.
- [Amazon Simple Storage Service \(Amazon S3\)](#) is a cloud-based object storage service that helps you store, protect, and retrieve any amount of data. [Amazon Simple Notification Service \(Amazon SNS\)](#) helps you coordinate and manage the exchange of messages between publishers and clients, including web servers and email addresses.
- [AWS WAF](#) is a web application firewall that helps you monitor HTTP and HTTPS requests that are forwarded to your protected web application resources

## Other tools

- [Git](#) is an open-source, distributed version control system.
- [Green Boost](#) is a toolkit for building web apps on AWS.
- [Next.js](#) is a React framework for adding features and optimizations.
- [Node.js](#) is an event-driven JavaScript runtime environment designed for building scalable network applications.
- [pgAdmin](#) is an open-source management tool for PostgreSQL. It provides a graphical interface that helps you create, maintain, and use database objects.
- [pnpm](#) is a package manager for Node.js project dependencies.

## Best practices

See the [Epics](#) section for more information about the following recommendations:

- Monitor infrastructure by using Amazon CloudWatch Dashboards and alarms.
- Enforce AWS best practices by using cdk-nag to run static infrastructure as code (IaC) analysis.
- Establish DB port forwarding through SSH (Secure Shell) tunneling with Systems Manager Session Manager, which is more secure than having a publicly exposed IP address.
- Manage vulnerabilities by running `pnpm audit`.

- Enforce best practices by using [ESLint](#) to perform static TypeScript code analysis, and [Prettier](#) to standardize code formatting.

## Epics

### Deploy a CRUD web app with Aurora PostgreSQL-Compatible

Task	Description	Skills required
Install the Green Boost CLI.	To install Green Boost CLI, run the following command.  <pre>pnpm add -g gboost</pre>	App developer
Create a GB app.	<ol style="list-style-type: none"> <li>To create an app by using Green Boost, run the command <code>gboost create</code>.</li> <li>Choose the CRUD App with Aurora PostgreSQL template.</li> </ol>	App developer
Install dependencies and deploy the app.	<ol style="list-style-type: none"> <li>Navigate to the project directory: <code>cd &lt;your directory&gt; .</code></li> <li>To install dependencies, run the command <code>pnpm i</code>.</li> <li>Navigate to the infra directory: <code>cd infra</code>.</li> <li>To deploy the app locally, run the command <code>pnpm deploy:local .</code></li> </ol> <p>This is an alias for a <code>cdk deploy ...</code> command</p>	App developer

Task	Description	Skills required
	<p>defined in <code>infra/package.json</code> .</p> <p>Wait for deployment to finish (approximately 20 minutes). While you're waiting, monitor AWS CloudFormation stacks in the CloudFormation console. Notice how the constructs defined in the code map to the resource deployed. Review the <a href="#">CDK Construct tree view</a> in the CloudFormation console.</p>	

Task	Description	Skills required
Access the app.	<p>After deploying your GB app locally, you can access it using the CloudFront URL. The URL is printed in the terminal output, but it can be a bit overwhelming to find. To find it more quickly, use the following steps:</p> <ol style="list-style-type: none"><li>1. Open the terminal where you ran the <code>pnpm deploy:local</code> command.</li><li>2. Look for a section in the terminal output that resembles the following text.</li></ol> <pre data-bbox="634 1058 1029 1295">myapp5stickbui9C39 A55A.CloudFrontDom ainName = d1q16n5po f924c.cloudfront.n et</pre> <p>The URL will be unique to your deployment.</p> <p>Alternatively, you can find the CloudFront URL by accessing the Amazon CloudFront console:</p> <ol style="list-style-type: none"><li>1. Sign in to the AWS Management Console and</li></ol>	App developer

Task	Description	Skills required
	<p>navigate to the CloudFront service.</p> <p>2. Look for the latest deployed distribution in the list.</p> <p>Copy the <b>Domain Name</b> that is associated with the distribution. It will look similar to <code>your-unique-id.cloudfront.net</code> .</p>	

### Monitor by using Amazon CloudWatch

Task	Description	Skills required
View the CloudWatch Dashboard.	<ol style="list-style-type: none"> <li>1. Open the CloudWatch console and choose <b>Dashboards</b>.</li> <li>2. Select the dashboard that has the name <code>&lt;appId&gt;-&lt;stageName&gt;-dashboard</code>.</li> <li>3. Review the dashboard . What resources are being monitored? What metrics are being recorded? This dashboard is made possible by the open-source construct <a href="#">cdk-monitoring-constructs</a>.</li> </ol>	App developer
Enable alerts.	A CloudWatch Dashboard helps you to actively monitor your web app. To passively	App developer

Task	Description	Skills required
	<p>monitor your web app, you can enable alerting.</p> <ol style="list-style-type: none"><li>1. Navigate to <code>/infra/src/app/stateless/monitor-stack.ts</code>, which defines the monitor stack.</li><li>2. Uncomment the following line, and replace <code>admin@example.com</code> with your email address.</li></ol> <pre>onAlarmTopic.addSubscription(new EmailSubscription("admin@example.com"));</pre> <ol style="list-style-type: none"><li>3. Add the following import information to the top of the file.</li></ol> <pre>import { EmailSubscription } from "aws-cdk-lib/aws-sns-subscriptions";</pre> <ol style="list-style-type: none"><li>4. Within <code>infra/</code>, run the following command.</li></ol> <pre>cdk deploy "*/monitor" --exclusively.</pre> <ol style="list-style-type: none"><li>5. To confirm your subscription to the SNS topic that is initiated when a monitoring alarm is initiated, choose</li></ol>	



Task	Description	Skills required
	the link in the email message.	

## Understand the app infrastructure by using AWS CDK

Task	Description	Skills required
Create an architecture diagram.	<p>Generate an architecture diagram of your web app by using <a href="#">cdk-dia</a>. Visualizing the architecture helps improve understanding and communication among team members. It provides a clear overview of the system's components and their relationships.</p> <ol style="list-style-type: none"> <li>1. Install <a href="#">Graphviz</a>.</li> <li>2. Within <code>infra/</code>, run the command <code>pnpm cdk-dia</code>.</li> <li>3. View your <code>infra/diagram.png</code>.</li> </ol>	App developer
Use <code>cdk-nag</code> to enforce best practices.	<p>Use <a href="#">cdk-nag</a> to help you maintain secure and compliant infrastructure by enforcing best practices, reducing the risk of security vulnerabilities and misconfigurations.</p> <ol style="list-style-type: none"> <li>1. Explore <code>cdk-nag</code>'s best practice enforcement through its <a href="#">rules</a> section,</li> </ol>	App developer

Task	Description	Skills required
	<p>including checks from the AWS Solutions Library's Rules Pack.</p> <ol style="list-style-type: none"><li data-bbox="591 365 1027 785">2. To see how cdk-nag enforces rules, make a change in the code. For example, in <code>infra/src/app/stateful/data-stacks.ts</code>, change <code>storageEncrypted: true</code> to <code>storageEncrypted: false</code>.</li><li data-bbox="591 806 1027 1121">3. Within <code>infra/</code>, run the command <code>cdk synth "*/data"</code>. During synthesis, you will encounter a build error that indicates a rule violation.  <code>AwsSolutions-RDS2: The RDS instance or Aurora DB cluster does not have storage encryption enabled.</code>  This error showcases how cdk-nag is a security mechanism for enforcing infrastructure best practices and preventing security misconfigurations.</li><li data-bbox="591 1793 1027 1875">4. If needed, you can also <a href="#">suppress rules</a> at different</li></ol>	

Task	Description	Skills required
	<p>scopes. For example, to suppress AwsSolutions-RDS2, add the following code below the instantiation of <code>DbIamCluster</code> .</p> <pre data-bbox="634 474 1029 1188"> NagSuppressions.addResourceSuppressions(     cluster.node.findChild("Resource"),     [         {             id: "AwsSolutions-RDS2",             reason:                 "Customer requirement necessitates having unencrypted DB storage",         },     ], ); </pre> <p>5. After suppression, run <code>cdk synth "*/data"</code> again. Your AWS CDK app should now synthesize successfully. You can find all suppressed rules in <code>infra/cdk.out/assembly-&lt;appId&gt;-&lt;stageName&gt;/AwsSolutions-&lt;appId&gt;-&lt;stageName&gt;-\${stackId}-NagReport.csv</code> .</p>	

## Evaluate the database configuration and schema

Task	Description	Skills required
Acquire environment variables.	<p>To obtain the required environment variables, use the following steps:</p> <ol style="list-style-type: none"> <li>1. To find the DB_BASTION_ID , sign in to the console, and navigate to the EC2 console. Choose <b>Instances (running)</b>, and find the row that contains <b>&lt;stageName&gt;-ssm-db-bastion Name</b>. The instance ID starts with <b>i-</b>.</li> <li>2. To find the DB_ENDPOINT , on the Amazon Relational Database Service (Amazon RDS) console, choose <b>DB Instances</b>, and select the regional cluster that has a DB identifier starting with <b>&lt;appId&gt;-&lt;stageName&gt;-data-</b>. Locate the writer instance endpoint, which ends with <b>rds.amazonaws.com</b>.</li> </ol>	App developer
Establish port forwarding.	To establish port forwarding, use the following steps:	App developer

Task	Description	Skills required
	<ol style="list-style-type: none"> <li>1. Install the AWS Systems Manager <a href="#">Session Manager plugin</a>.</li> <li>2. Start port forwarding by running <code>pnpm db:connect</code> within <code>core/</code> to establish a secure connection through the bastion host.</li> <li>3. After you see the text <code>Waiting for connections...</code>, in your terminal, an SSH tunnel has been successfully established between your local machine and the Aurora server through the EC2 bastion host.</li> </ol>	
Adjust the Systems Manager Session Manager timeout.	(Optional) If the default 20-minute session timeout is too short, you can increase it up to 60 minutes in the Systems Manager console by choosing <b>Session Manager, Preferences, Edit, Idle session timeout</b> .	App developer

Task	Description	Skills required
Visualize the database.	<p>pgAdmin is a user-friendly open-source tool for managing PostgreSQL databases. It simplifies database tasks, allowing you to efficiently create, manage, and optimize databases. This section guides you through <a href="#">installing pgAdmin</a> and using its features for PostgreSQL database management.</p> <ol style="list-style-type: none"><li>1. In the Object Explorer, open the context (right-click) menu for <b>Servers</b>, and then choose <b>Register, Server</b>.</li><li>2. On the <b>General</b> tab, enter <b>&lt;appId&gt;-&lt;stageName&gt;</b> for the <b>Name</b> field.</li><li>3. To fetch the DB password, open the AWS Secrets Manager console, select the secret that has the description <b>Generated by the CDK for the stack: &lt;appId&gt;-&lt;stageName&gt;-data</b>, and choose the <b>Secret Value</b> card. Choose <b>Retrieve Secret Value</b>, and copy the <b>Secret value</b> with a key of <b>password</b>.</li><li>4. On the <b>Connection</b> tab, enter <b>0.0.0</b> for the <b>Host</b></li></ol>	App developer

Task	Description	Skills required
	<p><b>name/address</b> field, and enter <b>&lt;appId&gt;_admin</b> for the <b>Username</b> field. For the <b>Password</b> field, use the secret that you fetched previously. Choose <b>yes</b> for the <b>Save password?</b> field.</p> <p>5. Choose <b>Save</b>.</p> <p>6. To view the tables, navigate to <b>&lt;appId&gt;-&lt;stageName&gt;, Databases, &lt;appId&gt;_db, Schemas, &lt;appId&gt;, Tables</b>.</p> <p>7. Open the context (right-click) menu for the <b>item</b> table, and then select <b>View/Edit Data, All Rows</b>.</p> <p>8. Explore the table.</p>	

## Debug with Node.js

Task	Description	Skills required
<p>Debug the create item use case.</p>	<p>To debug the create item use case, follow these steps:</p> <ol style="list-style-type: none"> <li>1. Open the <code>core/src/modules/item/create-item.use-case.ts</code> file, and insert the following code.</li> </ol>	<p>App developer</p>

Task	Description	Skills required
	<pre data-bbox="634 212 1029 1045">import { fileURLToPath } from "node:url";  // existing create-item.use-case.ts code here  if (process.argv[1] === fileURLToPath(import.meta.url)) {   createItemUseCase(     {       description: "Item 1's Description",       name: "Item 1",     }); }</pre> <p data-bbox="592 1058 1029 1524">2. The code added in the previous step ensures the <code>createItemUseCase</code> function will be called when this module is run directly. Set <a href="#">breakpoints</a> on the lines within this code block where you want to initiate line-by-line debugging.</p> <p data-bbox="592 1598 1029 1829">1. Open the <a href="#">VS Code JavaScript Debug Terminal</a>, and then run <code>pnpm tsx core/src/modules/item/create-item.us</code></p>	



Task	Description	Skills required
	<p><code>e-case.ts</code> to run the code with line-by-line debugging. Alternatively, you can use <code>console.log</code> statements, but print statements can be inadequate when you're working with complex business logic. Line-by-line debugging gives you more context.</p>	

## Develop the frontend

Task	Description	Skills required
Set up the development server.	<ol style="list-style-type: none"> <li>1. Navigate to <code>ui/</code>, and run <code>pnpm dev</code> to start the <a href="#">Next.js</a> development server.</li> <li>2. Access your web app locally at <code>http://localhost:3000</code>. The Next.js development server is set up with <a href="#">Fast Refresh</a> instantaneous feedback on edits made to your React components.</li> <li>3. Experiment with customizing the app bar color. Open the <code>ui/src/components/theme/theme.tsx</code> file and locate the section that defines</li> </ol>	App developer

Task	Description	Skills required
	<p>the theme for the app bar. In the <code>colorSchemes.light.palette.primary</code> section, update the main value from <code>colors.lagoon</code> to <code>colors.carrot</code>. After making this change, save the file and observe the update in your browser.</p> <p>4. Experiment by modifying text, components, and adding new pages.</p>	

## Tooling with Green Boost

Task	Description	Skills required
Set up monorepo and the pnpm package manager.	<ol style="list-style-type: none"> <li>Review <code>pnpm-workspace.yaml</code> in the root of your GB repository, and notice how workspaces are defined. For more information about workspaces, see the <a href="#">pnpm documentation</a>.</li> <li>Review <code>ui/package.json</code>, and notice how it references the workspace in <code>core/</code> with the package name <code>"&lt;appId&gt;/core": "workspace:^",</code></li> </ol>	App developer

Task	Description	Skills required
	<p>3. Observe how TypeScript and ESLint configuration is centralized in utility packages defined within packages/. This configuration is then used by application packages such as core/, infra/, and ui/. This is helpful when your app scales and you define more application packages, which can reference the utility packages without duplicating configuration code.</p>	

Task	Description	Skills required
Run pnpm scripts.	<p>Run the following commands in the root of your repository:</p> <ol style="list-style-type: none"><li>1. Run <code>pnpm lint</code>. This command runs static code analysis with <a href="#">ESLint</a>.</li><li>2. Run <code>pnpm typecheck</code>. This command runs the <a href="#">TypeScript compiler</a> to check the types of your code.</li><li>3. Run <code>pnpm test</code>. This command runs <a href="#">Vitest</a> to run unit tests.</li></ol> <p>Notice how these commands are run in all workspaces. The commands are defined in each workspace's <code>package.json#scripts</code> field.</p>	App developer

Task	Description	Skills required
Use ESLint for static code analysis.	<p>To test the static code analysis capability of ESLint, do the following:</p> <ol style="list-style-type: none"><li>1. First, ensure the <a href="#">VS Code ESLint extension</a> (ID: <code>dbaeumer.vscode-eslint</code>) is installed. We recommend also installing <a href="#">VS Code Error Lens</a> (ID: <code>usernamehw.errorlens</code>) to see errors inline.</li><li>2. In your code, purposefully include a line of code that uses the <code>eval()</code> function, as shown in the following example.</li></ol> <pre data-bbox="630 1058 1029 1417">const userInput =   "import('fs').then   ((fs) =&gt; console.l   og(fs.readFileSync   ('/etc/passwd',   { encoding:   'utf8' })))"; eval(userInput);</pre> <p><b>Important:</b> This is for testing purposes only. Using <code>eval()</code> is considered potentially dangerous and should be avoided because of security risks.</p> <ol style="list-style-type: none"><li>3. After you include the <code>eval()</code> line, open your</li></ol>	App developer

Task	Description	Skills required
	<p>code editor to confirm that ESLint indicated the code smell by using red squiggles.</p> <ol style="list-style-type: none"><li>4. Review ESLint plugins and configuration at <code>packages/eslint-config-{node,next}/.eslintrc.cjs</code> .</li></ol>	
Manage dependencies and vulnerabilities.	<ol style="list-style-type: none"><li>1. To identify any Common Vulnerabilities and Exposures (CVEs), run <code>pnpm audit</code> in the root of your repository.  You should see <b>No known vulnerabilities found.</b></li><li>2. Install an intentionally vulnerable package within <code>core/</code> by running <code>pnpm add minimist@0.2.3</code> , and then run <code>pnpm audit</code>. Notice the vulnerability being reported.</li><li>3. Uninstall the vulnerable package within <code>core/</code> by running <code>pnpm remove minimist</code>.</li></ol>	App developer

Task	Description	Skills required
Pre-commit hooks with Husky.	<ol style="list-style-type: none"><li data-bbox="592 226 1027 457">1. Make a couple small changes in TypeScript files throughout the repository. The changes can be as basic as adding comments.</li><li data-bbox="592 478 1027 657">2. Stage and commit these changes by using <code>git add -A</code> and then <code>git commit -m "test husky"</code>.  The <a href="#">Husky</a> pre-commit hook trigger, which is defined in <code>.husky/pre-commit</code>, runs the command <code>npm lint-staged</code>.</li><li data-bbox="592 1003 1027 1276">3. Observe how <a href="#">lint-staged</a> runs commands specified in <code>*/.lintstagedrc.js</code> files throughout the repository on files that have been staged by Git.</li></ol> <p data-bbox="592 1350 1027 1528">These tools are mechanisms to help prevent bad code from making its way into your application.</p>	App developer

## Tear down the infrastructure

Task	Description	Skills required
Remove the deployment from your account.	<ol style="list-style-type: none"> <li>To tear down the infrastructure that you provisioned in the first epic, by run <code>pnpm destroy:local</code> in <code>infra/</code>.</li> <li>Wait 15 minutes after <code>pnpm destroy:local</code> is complete, and then delete the retained Lambda@Edge function by searching for your app ID in the Lambda console. Lambda@Edge functions are replicated, which makes them difficult to delete. For more information about deleting Lambda@Edge functions , see the <a href="#">CloudFront documentation</a>.</li> </ol>	App developer

## Troubleshooting

Issue	Solution
Unable to establish port forwarding	<p>Ensure that your AWS credentials are properly configured and have the necessary permissions.</p> <p>Double-check that the bastion host ID (<code>DB_BASTION_ID</code> ) and database endpoint</p>



Issue	Solution
	<p>(DB_ENDPOINT ) environment variables are correctly set.</p> <p>If you still encounter issues, see the AWS documentation for <a href="#">troubleshooting SSH connections and Session Manager</a>.</p>
Website isn't loading on localhost:3000	<p>Confirm that the terminal output indicates successful port forwarding, including the forwarding address.</p> <p>Ensure there are no conflicting processes using port 3000 on your local machine.</p> <p>Verify that the Green Boost application is properly configured and running on the expected port (3000).</p> <p>Check your web browser for any security extensions or settings that might block local connections.</p>
Error messages during local deployment (pnpm deploy:local )	<p>Review the error messages carefully to identify the cause of the issue.</p> <p>Verify that the necessary environment variables and configuration files are correctly set.</p>

## Related resources

- [AWS CDK documentation](#)
- [Green Boost documentation](#)
- [Next.js documentation](#)
- [Node.js documentation](#)
- [React documentation](#)

- [TypeScript documentation](#)

# Run unit tests for a Node.js application from GitHub by using AWS CodeBuild

Created by Thomas Scott (AWS) and Jean-Baptiste Guillois (AWS)

**Code repository:** [Node JS Tests Sample](#)

**Environment:** Production

**Technologies:** Web & mobile apps

**AWS services:** AWS CodeBuild

## Summary

This pattern provides sample source code and key unit test components for a Node.js game API. It also includes instructions for running these unit tests from a GitHub repository by using AWS CodeBuild, as part of your continuous integration and continuous delivery (CI/CD) workflow.

Unit testing is a software development process in which different parts of an application, called *units*, are individually and independently tested for correct operation. Tests validate the quality of the code and confirm that it functions as expected. Other developers can also easily gain familiarity with your code base by consulting the tests. Unit tests reduce future refactoring time, help engineers get up to speed on your code base more quickly, and provide confidence in the expected behavior.

Unit testing involves testing individual functions, including AWS Lambda functions. To create unit tests, you need a testing framework and a way of validating tests (assertions). The code examples in this pattern use the [Mocha](#) testing framework and the [Chai assertion library](#).

For more information about unit testing and examples of test components, see the [Additional information](#) section.

## Prerequisites and limitations

- An active AWS account with correct CodeBuild permissions
- A GitHub account (see [instructions for signing up](#))

- Git (see [installation instructions](#))
- A code editor to make changes and push your code to GitHub (for example, you can use [AWS Cloud9](#))

## Architecture

This pattern implements the architecture that is shown in the following diagram.

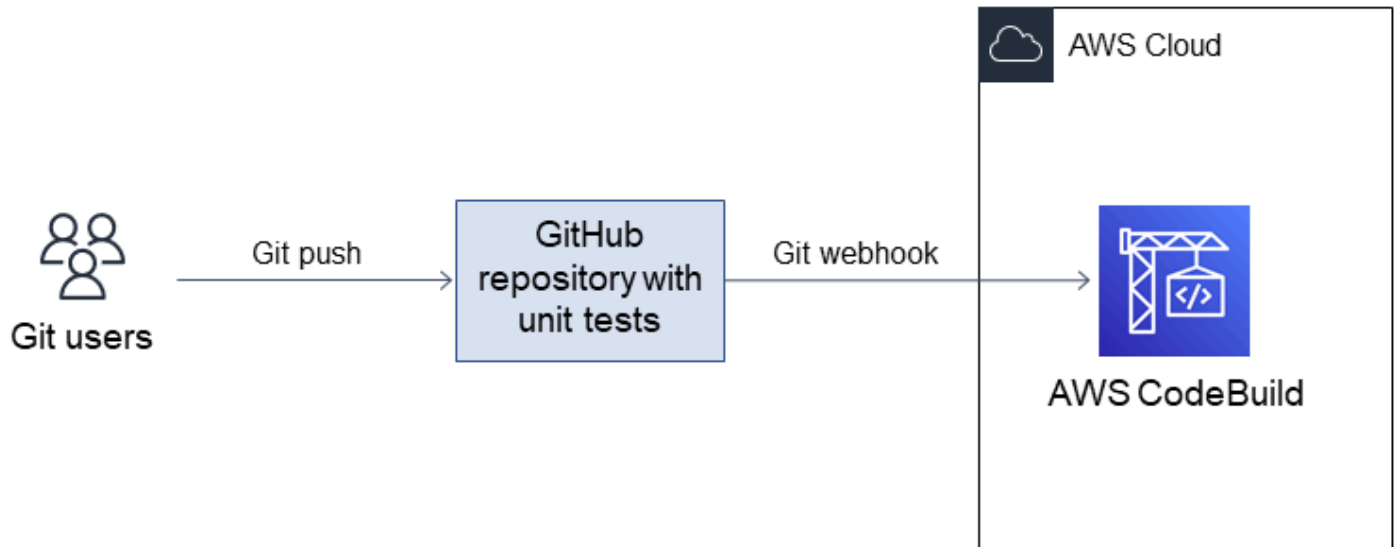

## Tools

### Tools

- [Git](#) – Git is a version control system that you can use for code development.
- [AWS Cloud9](#) – AWS Cloud9 is an integrated development environment (IDE) that offers a rich code-editing experience with support for several programming languages and runtime debuggers, and a built-in terminal. It contains a collection of tools that you use to code, build, run, test, and debug software, and helps you release software to the cloud. You access the AWS Cloud9 IDE through a web browser.
- [AWS CodeBuild](#) – AWS CodeBuild is a fully managed continuous integration service that compiles source code, runs tests, and produces software packages that are ready to deploy. With CodeBuild, you don't need to provision, manage, and scale your own build servers. CodeBuild scales continuously and processes multiple builds concurrently, so your builds are not left waiting in a queue. You can get started quickly by using prepackaged build environments, or you

can create custom build environments that use your own build tools. With CodeBuild, you are charged by the minute for the compute resources you use.

## Code

The source code for this pattern is available on GitHub, in the [Sample game unit test application](#) repository. You can create your own GitHub repository from this sample (option 1) or use the sample repository directly (option 2) for this pattern. Follow the instructions for each option in the next section. The option you follow will depend on your use case.

## Epics

### Option 1 - Run unit tests on your personal GitHub repository with CodeBuild

Task	Description	Skills required
Create your own GitHub repository based on the sample project.	<ol style="list-style-type: none"> <li>1. Log in to GitHub.</li> <li>2. Create a new repository. For instructions, see the <a href="#">GitHub documentation</a>.</li> <li>3. Clone and push the <a href="#">sample repository</a> into the new repository in your account.</li> </ol>	App developer, AWS administrator, AWS DevOps
Create a new CodeBuild project.	<ol style="list-style-type: none"> <li>1. Sign in to the AWS Management Console and open the CodeBuild console at <a href="https://console.aws.amazon.com/codesuite/codebuild/home">https://console.aws.amazon.com/codesuite/codebuild/home</a>.</li> <li>2. Choose <b>Create build project</b>.</li> <li>3. In the <b>Project configuration</b> section, for <b>Project name</b>, type <b>aws-tests-sample-node-js</b>.</li> </ol>	App developer, AWS administrator, AWS DevOps

Task	Description	Skills required
	<ol style="list-style-type: none"> <li>4. In the <b>Source</b> section, for <b>Source provider</b>, choose <b>GitHub</b>.</li> <li>5. For <b>Repository</b>, choose <b>Repository in my GitHub account</b>, and then paste the URL to your newly created GitHub repository.</li> <li>6. In the <b>Primary source webhook events</b> section, select <b>Rebuild every time a code change is pushed to this repository</b>.</li> <li>7. For event type, choose <b>PUSH</b>.</li> <li>8. In the <b>Environment</b> section, choose <b>Managed image</b>, Amazon Linux, and the latest image.</li> <li>9. Leave the default settings for all other options, and then choose <b>Create build project</b>.</li> </ol>	
Start the build.	On the <b>Review</b> page, choose <b>Start build</b> to run the build.	App developer, AWS administrator, AWS DevOps

## Option 2 - Run unit tests on a public repository with CodeBuild

Task	Description	Skills required
Create a new CodeBuild build project.	<ol style="list-style-type: none"><li>1. Sign in to the AWS Management Console and open the CodeBuild console at <a href="https://console.aws.amazon.com/codesuite/codebuild/home">https://console.aws.amazon.com/codesuite/codebuild/home</a>.</li><li>2. Choose <b>Create build project</b>.</li><li>3. In the <b>Project configuration</b> section, for <b>Project name</b>, type <b>aws-tests-sample-node-js</b>.</li><li>4. In the <b>Source</b> section, for <b>Source provider</b>, choose <b>GitHub</b>.</li><li>5. For <b>Repository</b>, choose <b>Public repository</b>, and then paste the URL: <a href="https://github.com/aws-samples/node-js-tests-sample">https://github.com/aws-samples/node-js-tests-sample</a>.</li><li>6. In the <b>Environment</b> section, choose <b>Managed image</b>, Amazon Linux, and the latest image.</li><li>7. Leave the default settings for all other options, and then choose <b>Create build project</b>.</li></ol>	App developer, AWS administrator, AWS DevOps

Task	Description	Skills required
Start the build.	On the <b>Review</b> page, choose <b>Start build</b> to run the build.	App developer, AWS administrator, AWS DevOps

## Analyze the unit tests

Task	Description	Skills required
View test results.	<p>In the CodeBuild console, review the unit test results from the CodeBuild job. They should match the results shown in the <a href="#">Additional information</a> section.</p> <p>These results validate the GitHub repository integration with CodeBuild.</p>	App developer, AWS administrator, AWS DevOps
Apply a webhook.	You can now apply a webhook, so you can automatically start a build whenever you push code changes to the main branch of your repository. For instructions, see the <a href="#">CodeBuild documentation</a> .	App developer, AWS administrator, AWS DevOps

## Related resources

- [Sample game unit test application](#) (GitHub repository with sample code)
- [AWS CodeBuild documentation](#)



- [GitHub webhook events](#) (CodeBuild documentation)
- [Creating a new repository](#) (GitHub documentation)

## Additional information

### Unit test results

In the CodeBuild console, you should see the following test results after the project builds successfully.

```
50
51 > node-game-unit-tests@1.0.0 test /codebuild/output/src813991724/src/github.com/aws-samples/node-js-tests-sample
52 > mocha
53
54
55
56 Game Function Group
57   Initialize Game
58     ✓ Check that the game ID is between 0 and 1000
59     ✓ Check that the play date is today
60   Start Game
61     ✓ Check that the game has two competitors
62     ✓ Check that the two competitors have different names
63   End Game
64     ✓ Check that there are no more competitors after the game ends
65   Game ID Stubs and Mocks
66     ✓ Check that an out of range game ID is returned with Stub
67     ✓ Using a mock check that the function was called and returns 9
68
69
70 7 passing (9ms)
71
```

### Example unit test components

This section describes the four types of test components that are used in unit testing: assertions, spies, stubs, and mocks. It includes a brief explanation and code example of each component.

#### Assertions

An assertion is used to verify an expected result. This is an important test component because it validates the expected response from a given function. The following sample assertion validates that the returned ID is between 0 and 1000 when initializing a new game.

```
const { expect } = require('chai');
const { Game } = require('../src/index');

describe('Game Function Group', () => {
  it('Check that the Game ID is between 0 and 1000', function() {
    const game = new Game();
    expect(game.id).is.above(0).but.below(1000)
  })
})
```

```
});  
});
```

## Spies

A spy is used to observe what is happening when a function is running. For example, you might want to validate that the function has been called correctly. The following example shows that start and stop methods are called on a **Game** class object.

```
const { expect } = require('chai');  
const { spy } = require('sinon');  
  
const { Game } = require('../src/index');  
  
describe('Game Function Group', () => {  
  it('should verify that the correct function is called', () => {  
    const spyStart = spy(Game.prototype, "start");  
    const spyStop = spy(Game.prototype, "stop");  
  
    const game = new Game();  
    game.start();  
    game.stop();  
  
    expect(spyStart.called).to.be.true  
    expect(spyStop.called).to.be.true  
  });  
});
```

## Stubs

A stub is used to override a function's default response. This is especially useful when the function makes an external request, because you want to avoid making external requests from unit tests. (External requests are better suited for integration tests, which can physically test requests between different components.) In the following example, a stub forces a return ID from the **getId** function.

```
const { expect } = require('chai');  
const { stub } = require('sinon');  
  
const { Game } = require('../src/index');  
  
describe('Game Function Group', () => {
```

```
it('Check that the Game ID is between 0 and 1000', function() {
  let generateIdStub = stub(Game.prototype, 'getId').returns(999999);

  const game = new Game();

  expect(game.getId).is.equal(999999);

  generateIdStub.restore();
});
});
```

## Mocks

A mock is a fake method that has a pre-programmed behavior for testing different scenarios. A mock can be considered an extended form of a stub and can carry out multiple tasks simultaneously. In the following example, a mock is used to validate three scenarios:

- Function is called
- Function is called with arguments
- Function returns the integer 9

```
const { expect } = require('chai');
const { mock } = require('sinon');

const { Game } = require('../src/index');

describe('Game Function Group', () => {
  it('Check that the Game ID is between 0 and 1000', function() {
    let mock = mock(Game.prototype).expects('getId').withArgs().returns(9);

    const game = new Game();
    const id = game.getId();

    mock.verify();
    expect(id).is.equal(9);
  });
});
```

## More patterns

- [Access AWS services from an ASP.NET Core app using Amazon Cognito identity pools](#)
- [Access container applications privately on Amazon ECS by using AWS Fargate, AWS PrivateLink, and a Network Load Balancer](#)
- [Access container applications privately on Amazon ECS by using AWS PrivateLink and a Network Load Balancer](#)
- [Automate migration strategy identification and planning using AppScore](#)
- [Build a loosely coupled architecture with microservices using DevOps practices and AWS Cloud9](#)
- [Build a serverless React Native mobile app by using AWS Amplify](#)
- [Build and test iOS apps with AWS CodeCommit, AWS CodePipeline, and AWS Device Farm](#)
- [Configure logging for .NET applications in Amazon CloudWatch Logs by using NLog](#)
- [Create a pipeline and AMI using CodePipeline and HashiCorp Packer](#)
- [Create a pipeline and deploy artifact updates to on-premises EC2 instances using CodePipeline](#)
- [Create an Amazon ECS task definition and mount a file system on EC2 instances using Amazon EFS](#)
- [Deploy a gRPC-based application on an Amazon EKS cluster and access it with an Application Load Balancer](#)
- [Deploy a ChatOps solution to manage SAST scan results by using AWS Chatbot custom actions and AWS CloudFormation](#)
- [Deploy CloudWatch Synthetics canaries by using Terraform](#)
- [Deploy Java microservices on Amazon ECS using Amazon ECR and AWS Fargate](#)
- [Deploy Java microservices on Amazon ECS using Amazon ECR and load balancing](#)
- [Deploy Java microservices on Amazon ECS using AWS Fargate](#)
- [Deploy resources in an AWS Wavelength Zone by using Terraform](#)
- [Migrate a messaging queue from Microsoft Azure Service Bus to Amazon SQS](#)
- [Migrate a .NET application from Microsoft Azure App Service to AWS Elastic Beanstalk](#)
- [Migrate an on-premises Go web application to AWS Elastic Beanstalk by using the binary method](#)
- [Migrate an on-premises SFTP server to AWS using AWS Transfer for SFTP](#)
- [Migrate from IBM WebSphere Application Server to Apache Tomcat on Amazon EC2](#)
- [Migrate from IBM WebSphere Application Server to Apache Tomcat on Amazon EC2 with Auto Scaling](#)

- [Migrate from Oracle GlassFish to AWS Elastic Beanstalk](#)
- [Migrate on-premises Java applications to AWS using AWS App2Container](#)
- [Migrate OpenText TeamSite workloads to the AWS Cloud](#)
- [Migrate Windows SSL certificates to an Application Load Balancer using ACM](#)
- [Modernize ASP.NET Web Forms applications on AWS](#)
- [Run an ASP.NET Core web API Docker container on an Amazon EC2 Linux instance](#)
- [Serve static content in an Amazon S3 bucket through a VPC by using Amazon CloudFront](#)
- [Set up a highly available PeopleSoft architecture on AWS](#)
- [Use Network Firewall to capture the DNS domain names from the Server Name Indication \(SNI\) for outbound traffic](#)
- [Visualize AI/ML model results using Flask and AWS Elastic Beanstalk](#)