



NetApp hybrid cloud data solutions - Spark and Hadoop based on customer use cases

NetApp Solutions

NetApp
July 31, 2024

Table of Contents

- NetApp hybrid cloud data solutions - Spark and Hadoop based on customer use cases 1
 - TR-4657: NetApp hybrid cloud data solutions - Spark and Hadoop based on customer use cases 1
 - Data fabric powered by NetApp for big data architecture 2
 - Hadoop data protection and NetApp 5
 - Overview of Hadoop data protection use cases 6
 - Use case 1: Backing up Hadoop data 7
 - Use case 2: Backup and disaster recovery from the cloud to on-premises 11
 - Use case 3: Enabling DevTest on existing Hadoop data 13
 - Use case 4: Data protection and multicloud connectivity 14
 - Use case 5: Accelerate analytic workloads 16
- Conclusion 17

NetApp hybrid cloud data solutions - Spark and Hadoop based on customer use cases

TR-4657: NetApp hybrid cloud data solutions - Spark and Hadoop based on customer use cases

Karthikeyan Nagalingam and Sathish Thyagarajan, NetApp

This document describes hybrid cloud data solutions using NetApp AFF and FAS storage systems, NetApp Cloud Volumes ONTAP, NetApp connected storage, and NetApp FlexClone technology for Spark and Hadoop. These solution architectures allow customers to choose an appropriate data protection solution for their environment. NetApp designed these solutions based on interaction with customers and their business use-cases. This document provides the following detailed information:

- Why we need data protection for Spark and Hadoop environments and customer challenges.
- The data fabric powered by NetApp vision and its building blocks and services.
- How these building blocks can be used to architect flexible data protection workflows.
- The pros and cons of several architectures based on real-world customer use cases. Each use case provides the following components:
 - Customer scenarios
 - Requirements and challenges
 - Solutions
 - Summary of the solutions

Why Hadoop data protection?

In a Hadoop and Spark environment, the following concerns must be addressed:

- **Software or human failures.** Human error in software updates while carrying out Hadoop data operations can lead to faulty behavior that can cause unexpected results from the job. In such case, we need to protect the data to avoid failures or unreasonable outcomes. For example, as the result of a poorly executed software update to a traffic signal analysis application, a new feature that fails to properly analyze traffic signal data in the form of plain text. The software still analyzes JSON and other non- text file formats, resulting in the real-time traffic control analytics system producing prediction results that are missing data points. This situation can cause faulty outputs that might lead to accidents at the traffic signals. Data protection can address this issue by providing the capability to quickly roll back to the previous working application version.
- **Size and scale.** The size of the analytics data grows day by day due to the ever-increasing numbers of data sources and volume. Social media, mobile apps, data analytics, and cloud computing platforms are the main sources of data in the current big data market, which is increasing very rapidly, and therefore the data needs to be protected to ensure accurate data operations.
- **Hadoop's native data protection.** Hadoop has a native command to protect the data, but this command does not provide consistency of data during backup. It only supports directory-level backup. The snapshots created by Hadoop are read-only and cannot be used to reuse the backup data directly.

Data protection challenges for Hadoop and Spark customers

A common challenge for Hadoop and Spark customers is to reduce the backup time and increase backup reliability without negatively affecting performance at the production cluster during data protection.

Customers also need to minimize recovery point objective (RPO) and recovery time objective (RTO) downtime and control their on-premises and cloud-based disaster recovery sites for optimal business continuity. This control typically comes from having enterprise-level management tools.

The Hadoop and Spark environments are complicated because not only is the data volume huge and growing, but the rate this data arrives is increasing. This scenario makes it difficult to rapidly create efficient, up-to-date DevTest and QA environments from the source data. NetApp recognizes these challenges and offers the solutions presented in this paper.

Data fabric powered by NetApp for big data architecture

The data fabric powered by NetApp simplifies and integrates data management across cloud and on-premises environments to accelerate digital transformation.

The data fabric powered by NetApp delivers consistent and integrated data management services and applications (building blocks) for data visibility and insights, data access and control, and data protection and security, as shown in the figure below.

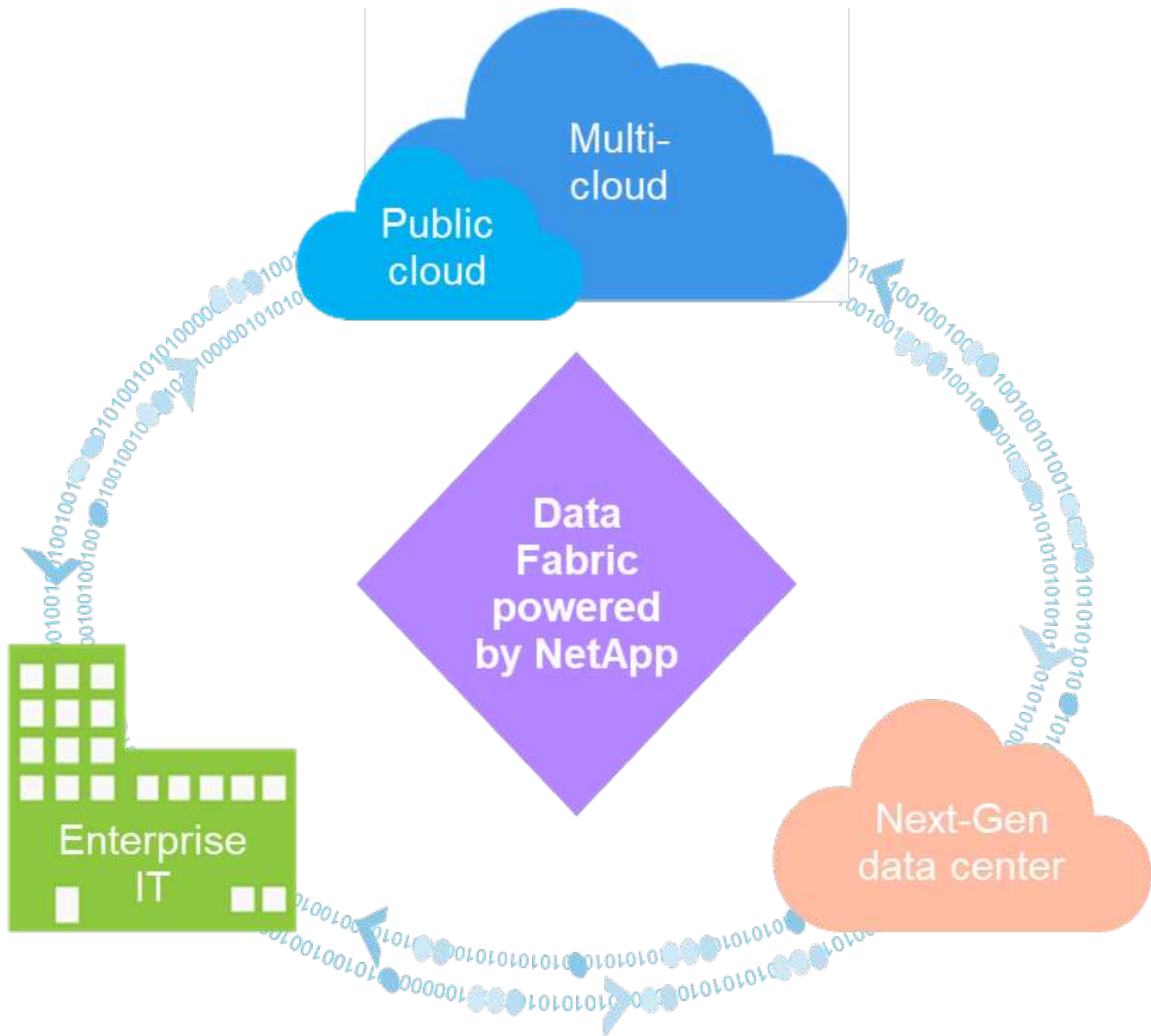

Proven data fabric customer use cases

The data fabric powered by NetApp provides the following nine proven use cases for customers:

- Accelerate analytics workloads
- Accelerate DevOps transformation
- Build cloud hosting infrastructure
- Integrate cloud data services
- Protect and secure data
- Optimize unstructured data
- Gain data center efficiencies
- Deliver data insights and control
- Simplify and automate

This document covers two of the nine use cases (along with their solutions):

- Accelerate analytics workloads
- Protect and secure data

NetApp NFS direct access

The NetApp NFS allows customers to run big data analytics jobs on their existing or new NFSv3 or NFSv4 data without moving or copying the data. It prevents multiple copies of data and eliminates the need to sync the data with a source. For example, in the financial sector, the movement of data from one place to another place must meet legal obligations, which is not an easy task. In this scenario, the NetApp NFS direct access analyzes the financial data from its original location. Another key benefit is that using the NetApp NFS direct access simplifies protecting Hadoop data by using native Hadoop commands and enables data protection workflows leveraging NetApp's rich data management portfolio.

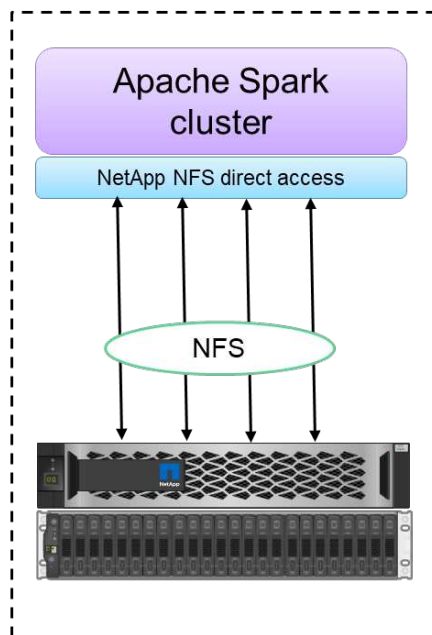

Configuration 1: NFS as primary storage

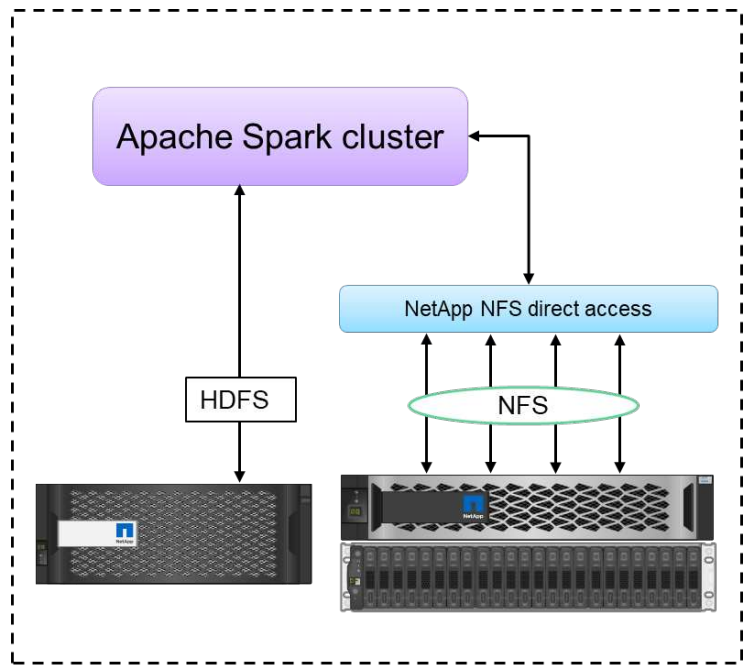

Configuration 2: HDFS and NFS in single Spark cluster

The NetApp NFS direct access provides two kinds of deployment options for Hadoop/Spark clusters:

- By default, the Hadoop/Spark clusters use Hadoop Distributed File System (HDFS) for data storage and the default file system. The NetApp NFS direct access can replace the default HDFS with NFS storage as the default file system, enabling direct analytics operations on NFS data.
- In another deployment option, the NetApp NFS direct access supports configuring NFS as additional storage along with HDFS in a single Hadoop/Spark cluster. In this case, the customer can share data through NFS exports and access it from the same cluster along with HDFS data.

The key benefits of using the NetApp NFS direct access include:

- Analyzes the data from its current location, which prevents the time- and performance-consuming task of moving analytics data to a Hadoop infrastructure such as HDFS.
- Reduces the number of replicas from three to one.
- Enables users to decouple the compute and storage to scale them independently.

- Provides enterprise data protection by leveraging the rich data management capabilities of ONTAP.
- Is certified with the Hortonworks data platform.
- Enables hybrid data analytics deployments.
- Reduces the backup time by leveraging dynamic multithread capability.

Building blocks for big data

The data fabric powered by NetApp integrates data management services and applications (building blocks) for data access, control, protection, and security, as shown in the figure below.

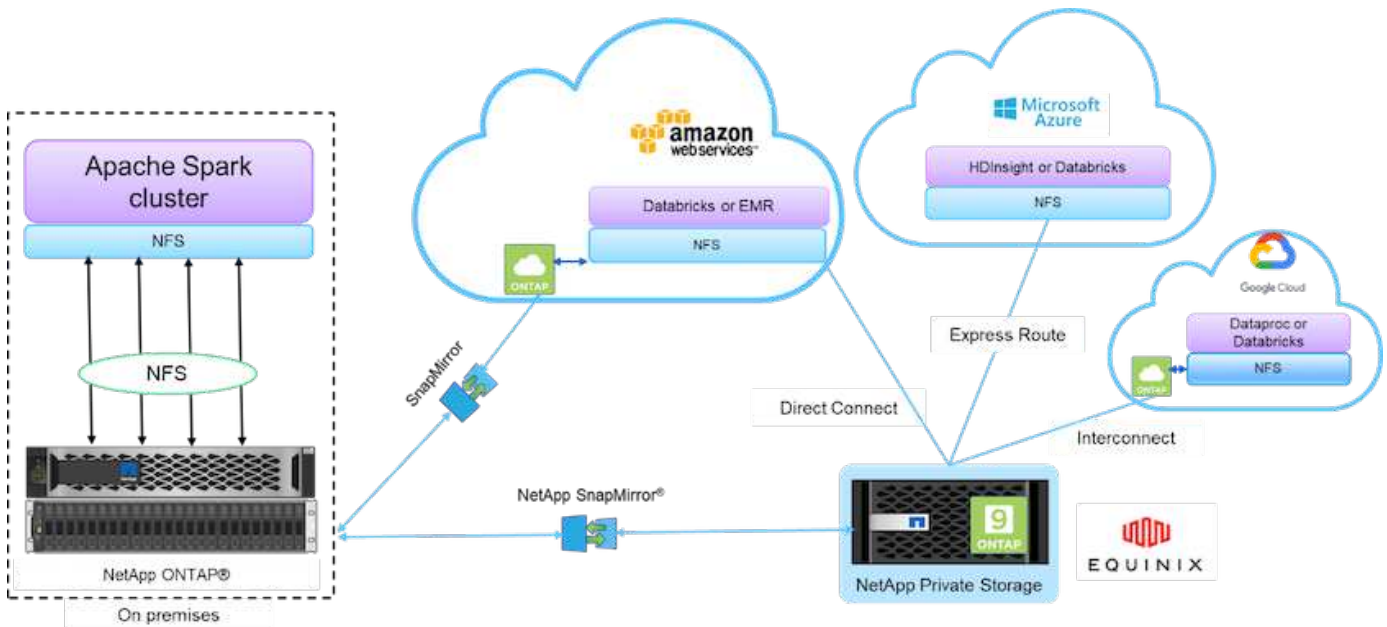

The building blocks in the figure above include:

- **NetApp NFS direct access.** Provides the latest Hadoop and Spark clusters with direct access to NetApp NFS volumes without additional software or driver requirements.
- **NetApp Cloud Volumes ONTAP and Cloud Volume Services.** Software-defined connected storage based on ONTAP running in Amazon Web Services (AWS) or Azure NetApp Files (ANF) in Microsoft Azure cloud services.
- **NetApp SnapMirror technology.** Provides data protection capabilities between on-premises and ONTAP Cloud or NPS instances.
- **Cloud service providers.** These providers include AWS, Microsoft Azure, Google Cloud, and IBM Cloud.
- **PaaS.** Cloud-based analytics services such as Amazon Elastic MapReduce (EMR) and Databricks in AWS as well as Microsoft Azure HDInsight and Azure Databricks.

Hadoop data protection and NetApp

Hadoop DistCp is a native tool used for large intercluster and intracluster copying. The Hadoop DistCp basic process shown in the figure below is a typical backup workflow using Hadoop native tools such as MapReduce to copy Hadoop data from an HDFS source to a corresponding target.

The NetApp NFS direct access enables customers to set NFS as the target destination for the Hadoop DistCp

tool to copy the data from HDFS source into an NFS share through MapReduce. The NetApp NFS direct access acts as an NFS driver for the DistCp tool.

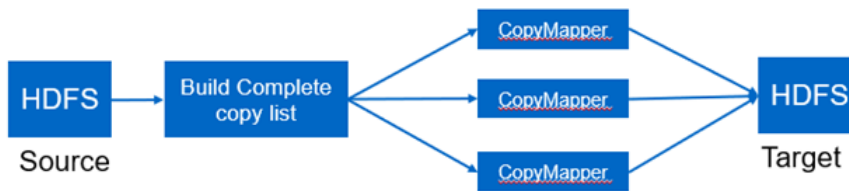

Hadoop DistCp Basic Process

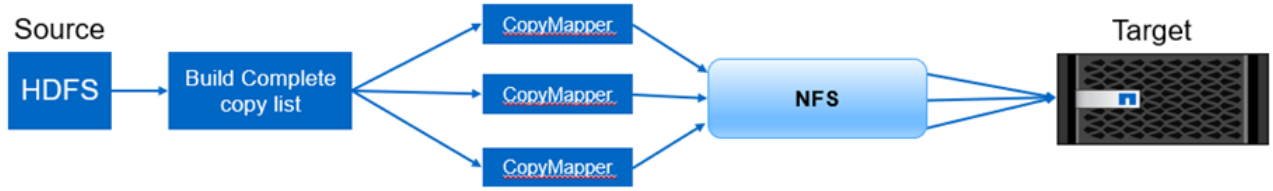

Hadoop DistCp and NetApp

Overview of Hadoop data protection use cases

This section provides a high-level description of the data protection use cases, which constitute the focus of this paper. The remaining sections provide more details for each use case, such as the customer problem (scenario), requirements and challenges, and solutions.

Use case 1: Backing up Hadoop data

For this use case, NetApp NFS volume helped a large financial institution reduce the long backup window time from more than 24 hours to just under a few hours.

Use case 2: Backup and disaster recovery from the cloud to on-premises

By using the data fabric powered by NetApp as building blocks, a large broadcasting company was able to fulfill its requirement of backing up cloud data into its on-premise data center depending on the different modes of data transfers, such as on demand, instantaneous, or based on the Hadoop/Spark cluster load.

Use case 3: Enabling DevTest on existing Hadoop data

NetApp solutions helped an online music distributor to rapidly build multiple space-efficient Hadoop clusters in different branches to create reports and run daily DevTest tasks by using scheduled policies.

Use case 4: Data protection and multicloud connectivity

A large service provider used the data fabric powered by NetApp to provide multicloud analytics to its customers from different cloud instances.

Use case 5: Accelerate analytic workloads

One of the largest financial services and investment banks used the NetApp network-attached storage solution to reduce I/O wait time and accelerate its quantitative financial analytics platform.

Use case 1: Backing up Hadoop data

In this scenario, the customer has a large on-premises Hadoop repository and wants to back it up for disaster recovery purposes. However, the customer's current backup solution is costly and is suffering from a long backup window of more than 24 hours.

Requirements and challenges

The main requirements and challenges for this use case include:

- Software backward compatibility:
 - The proposed alternative backup solution should be compatible with the current running software versions used in the production Hadoop cluster.
- To meet the committed SLAs, the proposed alternative solution should achieve very low RPOs and RTOs.
- The backup created by the NetApp backup solution can be used in the Hadoop cluster built locally in the data center as well as the Hadoop cluster running in the disaster recovery location at the remote site.
- The proposed solution must be cost effective.
- The proposed solution must reduce the performance effect on the currently running, in-production analytics jobs during the backup times.

Customer's existing backup solutionx

The figure below shows the original Hadoop native backup solution.

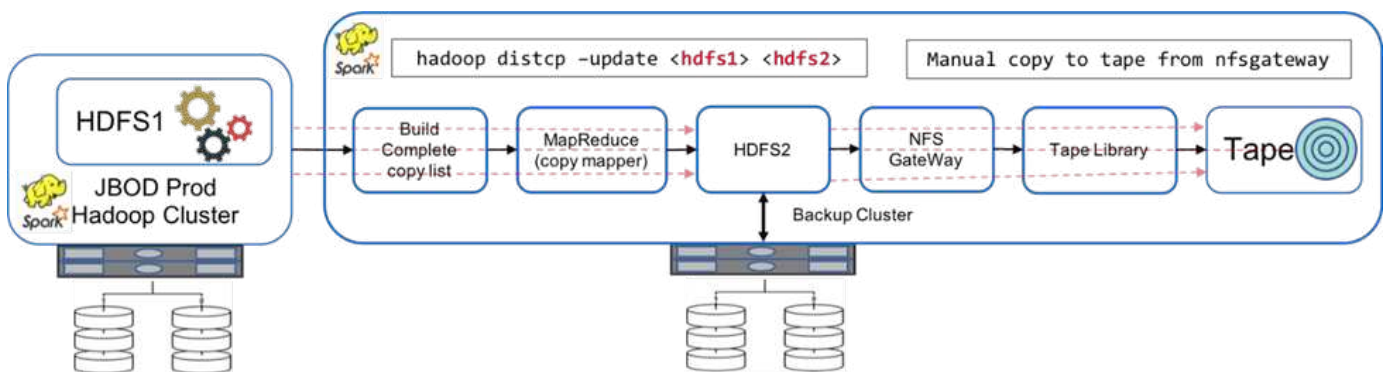

The production data is protected to tape through the intermediate backup cluster:

- HDFS1 data is copied to HDFS2 by running the `hadoop distcp -update <hdfs1> <hdfs2>` command.
- The backup cluster acts as an NFS gateway, and the data is manually copied to tape through the Linux `cp` command through the tape library.

The benefits of the original Hadoop native backup solution include:

- The solution is based on Hadoop native commands, which saves the user from having to learn new procedures.
- The solution leverages industry-standard architecture and hardware.

The disadvantages of the original Hadoop native backup solution include:

- The long backup window time exceeds 24 hours, which makes the production data vulnerable.
- Significant cluster performance degradation during backup times.
- Copying to tape is a manual process.
- The backup solution is expensive in terms of the hardware required and the human hours required for manual processes.

Backup solutions

Based on these challenges and requirements, and taking into consideration the existing backup system, three possible backup solutions were suggested. The following subsections describe each of these three different backup solutions, labeled solution A through solution C.

Solution A

In Solution A, the backup Hadoop cluster sends the secondary backups to NetApp NFS storage systems, eliminating the tape requirement, as shown in the figure below.

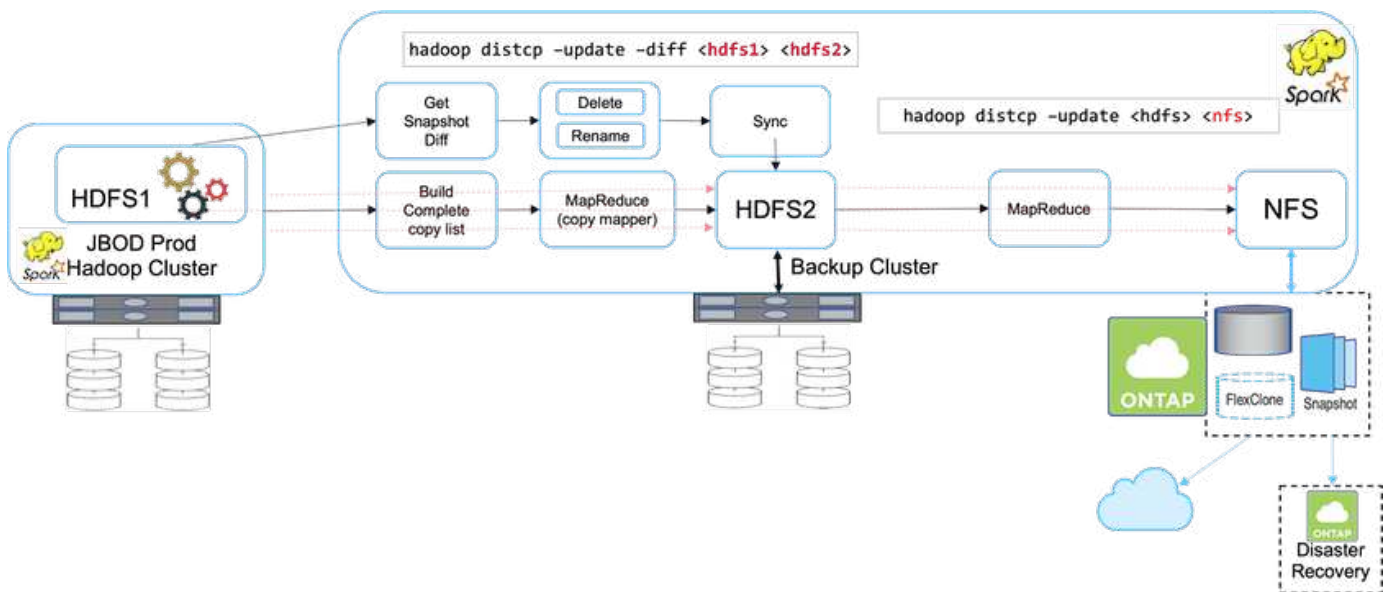

The detailed tasks for solution A include:

- The production Hadoop cluster has the customer's analytics data in the HDFS that requires protection.
- The backup Hadoop cluster with HDFS acts as an intermediate location for the data. Just a bunch of disks (JBOD) provides the storage for HDFS in both the production and backup Hadoop clusters.
- Protect the Hadoop production data is protected from the production cluster HDFS to the backup cluster HDFS by running the `Hadoop distcp -update -diff <hdfs1> <hdfs2>` command.



The Hadoop snapshot is used to protect the data from production to the backup Hadoop cluster.

- The NetApp ONTAP storage controller provides an NFS exported volume, which is provisioned to the backup Hadoop cluster.
- By running the `Hadoop distcp` command leveraging MapReduce and multiple mappers, the analytics data is protected from the backup Hadoop cluster to NFS.

After the data is stored in NFS on the NetApp storage system, NetApp Snapshot, SnapRestore, and FlexClone technologies are used to back up, restore, and duplicate the Hadoop data as needed.



Hadoop data can be protected to the cloud as well as disaster recovery locations by using SnapMirror technology.

The benefits of solution A include:

- Hadoop production data is protected from the backup cluster.
- HDFS data is protected through NFS enabling protection to cloud and disaster recovery locations.
- Improves performance by offloading backup operations to the backup cluster.
- Eliminates manual tape operations
- Allows for enterprise management functions through NetApp tools.
- Requires minimal changes to the existing environment.
- Is a cost-effective solution.

The disadvantage of this solution is that it requires a backup cluster and additional mappers to improve performance.

The customer recently deployed solution A due to its simplicity, cost, and overall performance.

In this solution, SAN disks from ONTAP can be used instead of JBOD. This option offloads the backup cluster storage load to ONTAP; however, the downside is that SAN fabric switches are required.

Solution B

Solution B adds NFS volume to the production Hadoop cluster, which eliminates the need for the backup Hadoop cluster, as shown in the figure below.

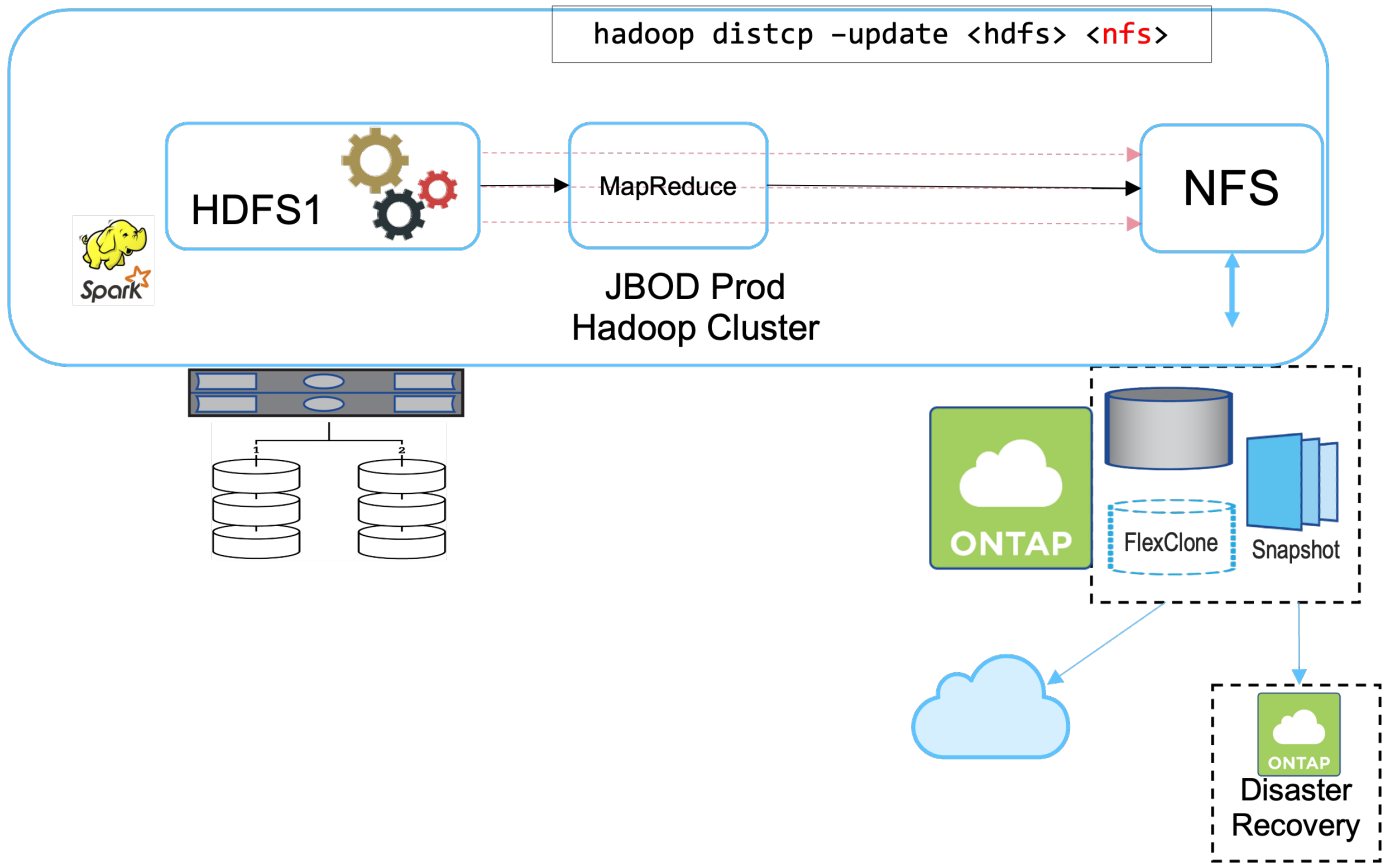

The detailed tasks for solution B include:

- The NetApp ONTAP storage controller provisions the NFS export to the production Hadoop cluster.

The Hadoop native `hadoop distcp` command protects the Hadoop data from the production cluster HDFS to NFS.

- After the data is stored in NFS on the NetApp storage system, Snapshot, SnapRestore, and FlexClone technologies are used to back up, restore, and duplicate the Hadoop data as needed.

The benefits of solution B include:

- The production cluster is slightly modified for the backup solution, which simplifies implementation and reduces additional infrastructure cost.
- A backup cluster for the backup operation is not required.
- HDFS production data is protected in the conversion to NFS data.
- The solution allows for enterprise management functions through NetApp tools.

The disadvantage of this solution is that it's implemented in the production cluster, which can add additional administrator tasks in the production cluster.

Solution C

In solution C, the NetApp SAN volumes are directly provisioned to the Hadoop production cluster for HDFS storage, as shown in the figure below.

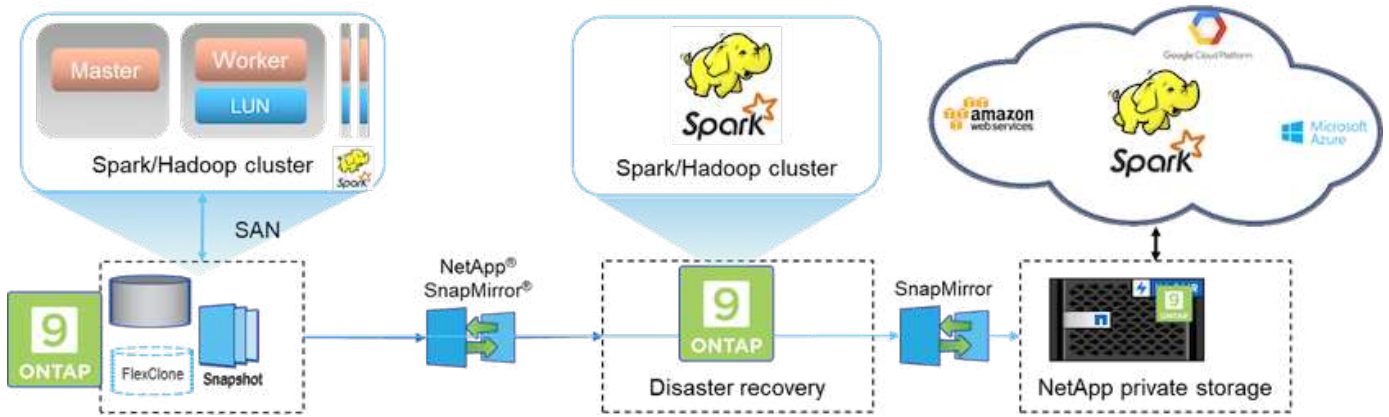

The detailed steps for solution C include:

- NetApp ONTAP SAN storage is provisioned at the production Hadoop cluster for HDFS data storage.
- NetApp Snapshot and SnapMirror technologies are used to back up the HDFS data from the production Hadoop cluster.
- There is no performance effect to production for the Hadoop/Spark cluster during the Snapshot copy backup process because the backup is at the storage layer.



Snapshot technology provides backups that complete in seconds regardless of the size of the data.

The benefits of solution C include:

- Space-efficient backup can be created by using Snapshot technology.
- Allows for enterprise management functions through NetApp tools.

Use case 2: Backup and disaster recovery from the cloud to on-premises

This use case is based on a broadcasting customer that needs to back up cloud-based analytics data to its on-premises data center, as illustrated in the figure below.

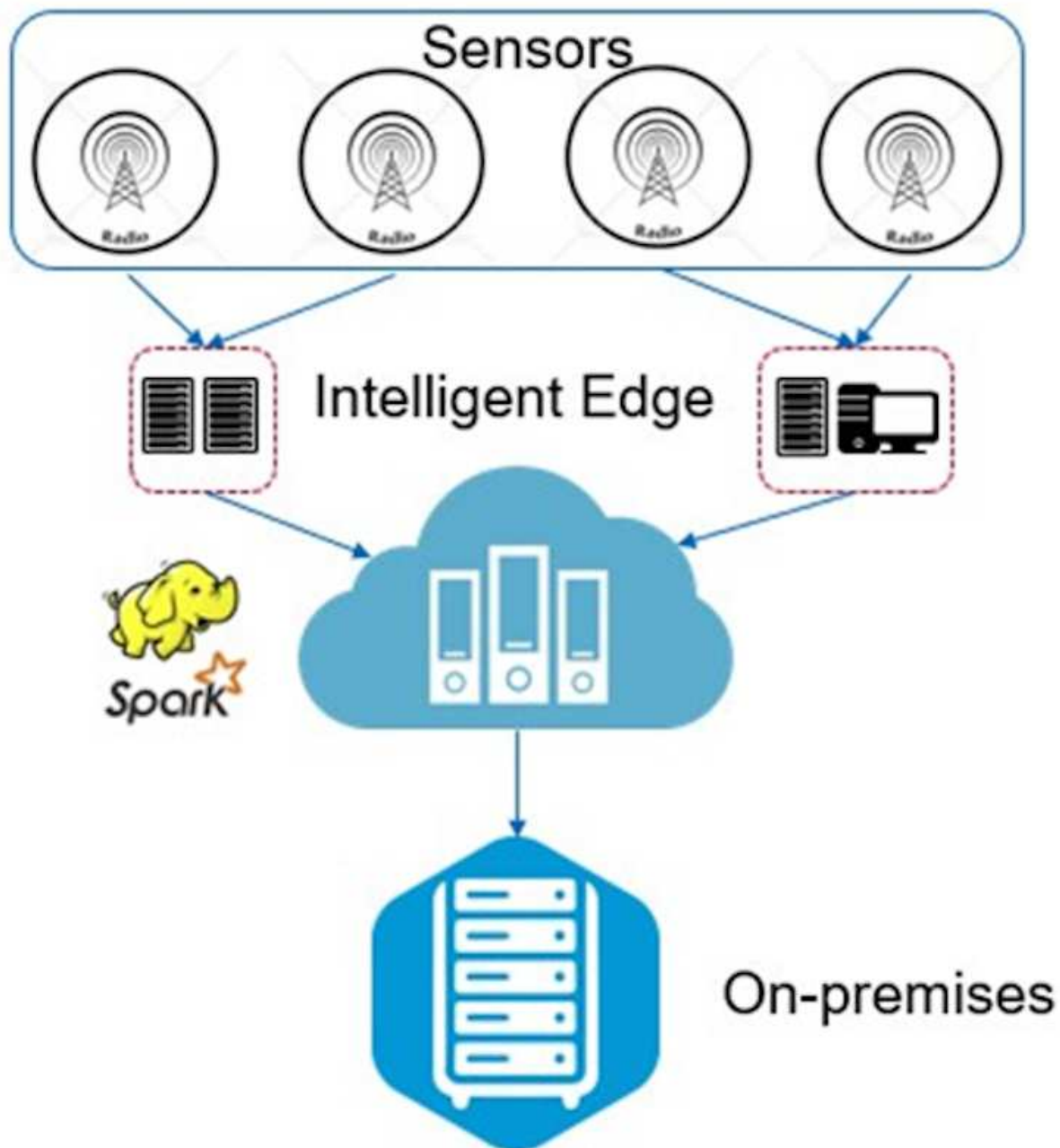

Scenario

In this scenario, the IoT sensor data is ingested into the cloud and analyzed by using an open source Apache Spark cluster within AWS. The requirement is to back up the processed data from the cloud to on-premises.

Requirements and challenges

The main requirements and challenges for this use case include:

- Enabling data protection should not cause any performance effect on the production Spark/Hadoop cluster in the cloud.
- Cloud sensor data needs to be moved and protected to on-premises in an efficient and secure way.
- Flexibility to transfer data from the cloud to on-premises under different conditions, such as on-demand, instantaneous, and during low-cluster load times.

Solution

The customer uses AWS Elastic Block Store (EBS) for its Spark cluster HDFS storage to receive and ingest data from remote sensors through Kafka. Consequently, the HDFS storage acts as the source for the backup data.

To fulfill these requirements, NetApp ONTAP Cloud is deployed in AWS, and an NFS share is created to act as the backup target for the Spark/Hadoop cluster.

After the NFS share is created, copy the data from the HDFS EBS storage into the ONTAP NFS share. After the data resides in NFS in ONTAP Cloud, SnapMirror technology can be used to mirror the data from the cloud into on-premises storage as needed in a secure and efficient way.

This image shows the backup and disaster recovery from cloud to on-premises solution.

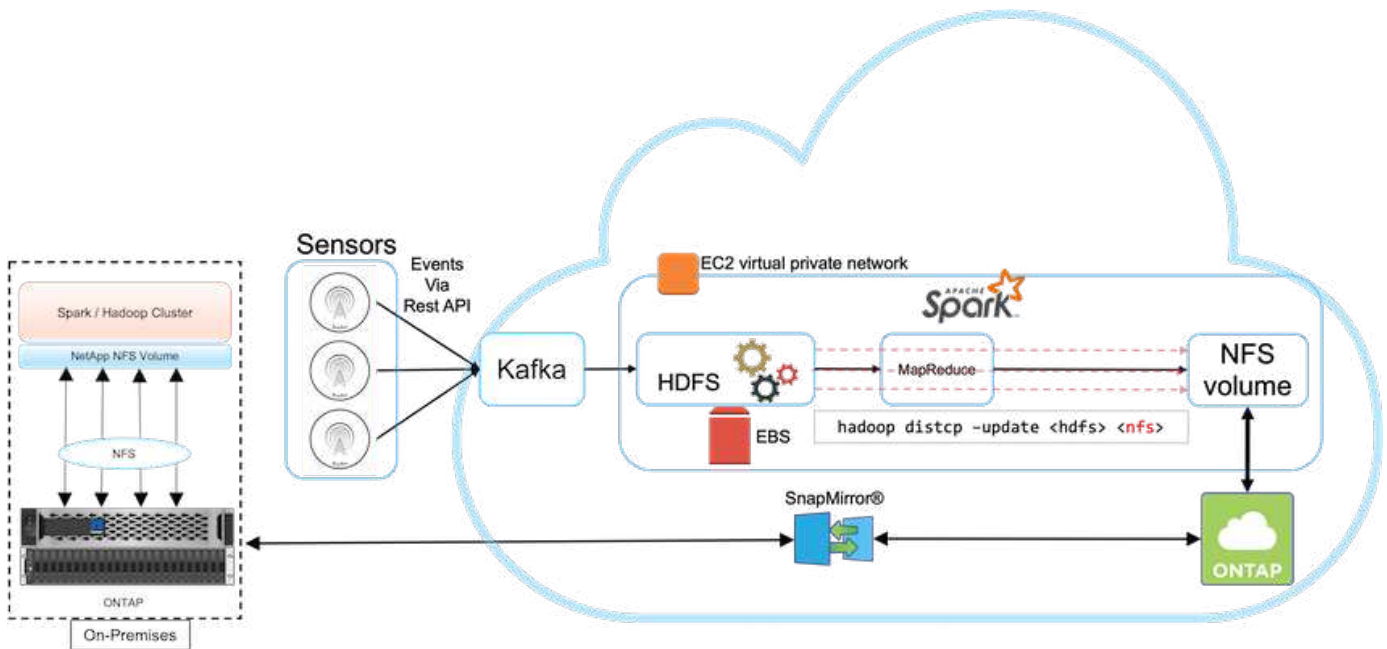

Use case 3: Enabling DevTest on existing Hadoop data

In this use case, the customer's requirement is to rapidly and efficiently build new Hadoop/Spark clusters based on an existing Hadoop cluster containing a large amount of analytics data for DevTest and reporting purposes in the same data center as well as remote locations.

Scenario

In this scenario, multiple Spark/Hadoop clusters are built from a large Hadoop data lake implementation on-premises as well as at disaster recovery locations.

Requirements and challenges

The main requirements and challenges for this use case include:

- Create multiple Hadoop clusters for DevTest, QA, or any other purpose that requires access to the same production data. The challenge here is to clone a very large Hadoop cluster multiple times instantaneously

and in a very space-efficient manner.

- Sync the Hadoop data to DevTest and reporting teams for operational efficiency.
- Distribute the Hadoop data by using the same credentials across production and new clusters.
- Use scheduled policies to efficiently create QA clusters without affecting the production cluster.

Solution

FlexClone technology is used to answer the requirements just described. FlexClone technology is the read/write copy of a Snapshot copy. It reads the data from parent Snapshot copy data and only consumes additional space for new/modified blocks. It is fast and space-efficient.

First, a Snapshot copy of the existing cluster was created by using a NetApp consistency group.

Snapshot copies within NetApp System Manager or the storage admin prompt. The consistency group Snapshot copies are application-consistent group Snapshot copies, and the FlexClone volume is created based on consistency group Snapshot copies. It is worth mentioning that a FlexClone volume inherits the parent volume's NFS export policy. After the Snapshot copy is created, a new Hadoop cluster must be installed for DevTest and reporting purposes, as shown in the figure below. The cloned NFS volume from the new Hadoop cluster access the the NFS data.

This image shows the Hadoop cluster for DevTest.

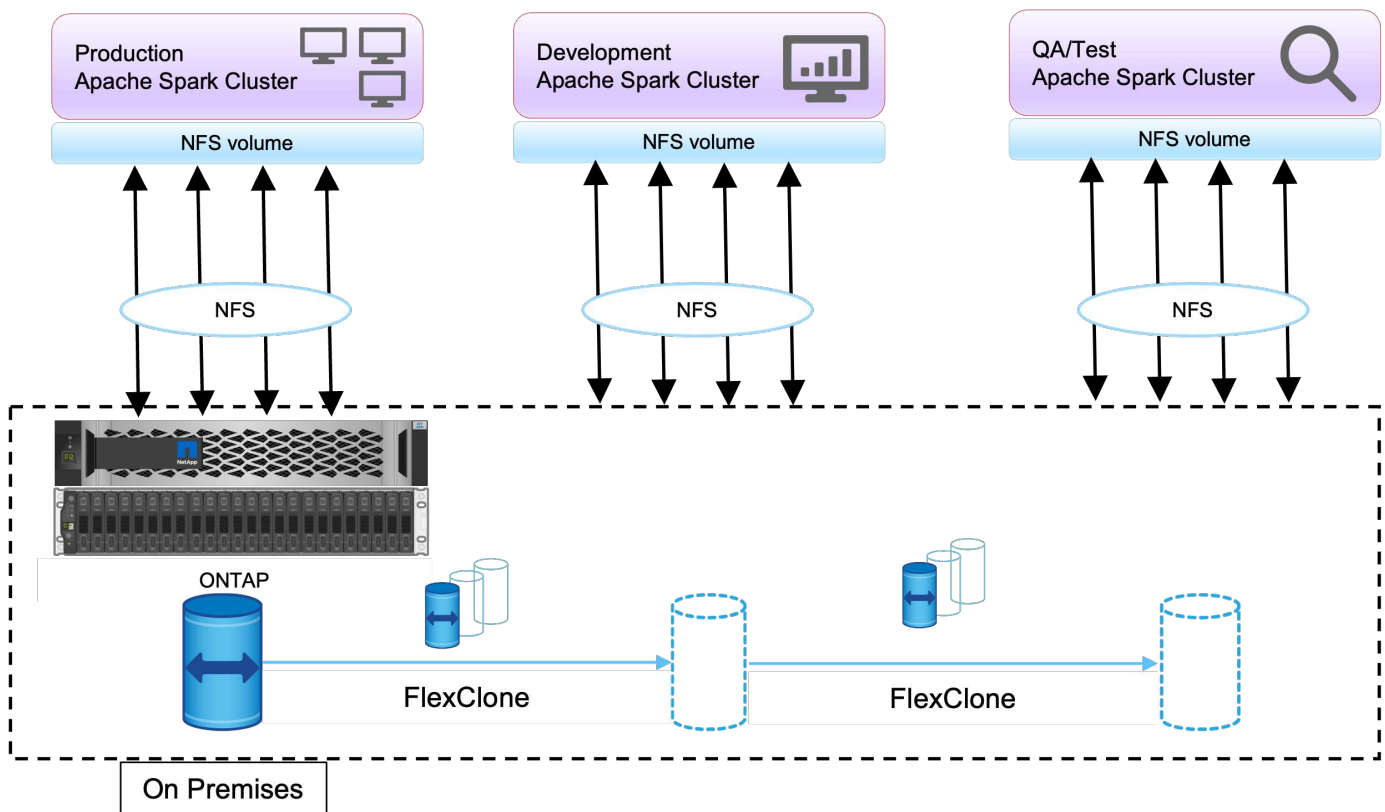

Use case 4: Data protection and multicloud connectivity

This use case is relevant for a cloud service partner tasked with providing multicloud connectivity for customers' big data analytics data.

Scenario

In this scenario, IoT data received in AWS from different sources is stored in a central location in NPS. The NPS storage is connected to Spark/Hadoop clusters located in AWS and Azure enabling big data analytics applications running in multiple clouds accessing the same data.

Requirements and challenges

The main requirements and challenges for this use case include:

- Customers want to run analytics jobs on the same data using multiple clouds.
- Data must be received from different sources such as on-premises and cloud through different sensors and hubs.
- The solution must be efficient and cost-effective.
- The main challenge is to build a cost-effective and efficient solution that delivers hybrid analytics services between on-premises and across different clouds.

Solution

This image illustrates the data protection and multicloud connectivity solution.

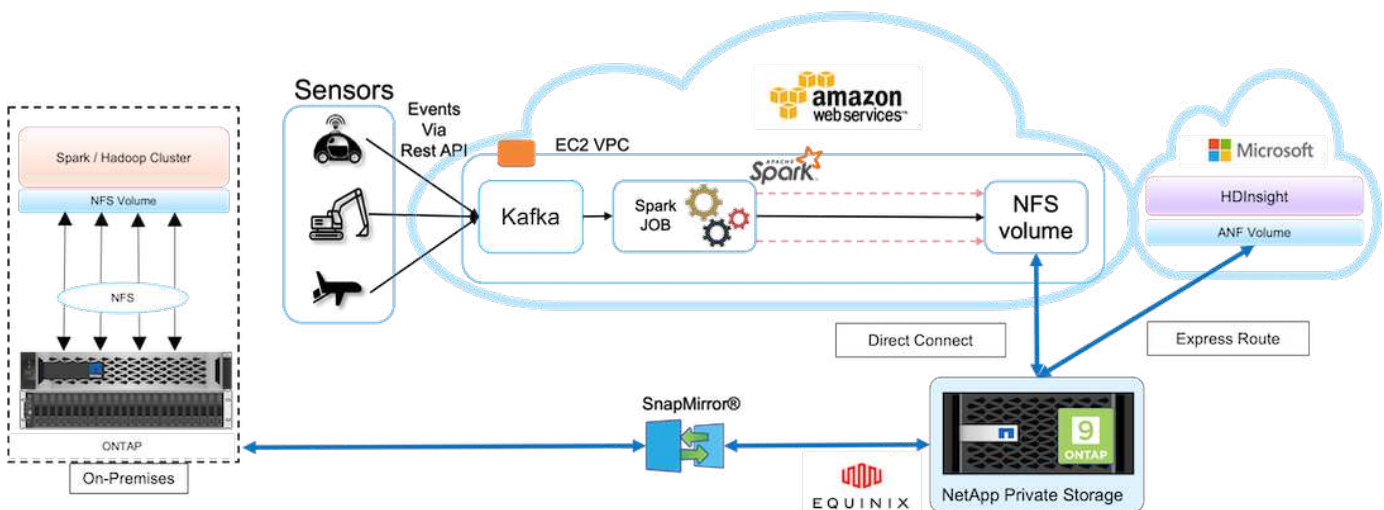

As shown in the figure above, data from sensors is streamed and ingested into the AWS Spark cluster through Kafka. The data is stored in an NFS share residing in NPS, which is located outside of the cloud provider within an Equinix data center. Because NetApp NPS is connected to Amazon AWS and Microsoft Azure through Direct Connect and Express Route connections, respectively, customers can access the NFS data from both Amazon and AWS analytics clusters. This approach solves having cloud analytics across multiple hyperscalers.

Consequently, because both on-premises and NPS storage runs ONTAP software, SnapMirror can mirror the NPS data into the on-premises cluster, providing hybrid cloud analytics across on-premises and multiple clouds.

For the best performance, NetApp typically recommends using multiple network interfaces and direct connection/express routes to access the data from cloud instances.

Use case 5: Accelerate analytic workloads

In this scenario, a large financial services and investment bank's analytics platform was modernized using the NetApp NFS storage solution to achieve significant improvement in analyzing investment risks and derivatives for its asset management and quantitative business unit.

Scenario

In the customer's existing environment, the Hadoop infrastructure used for the analytics platform leveraged internal storage from the Hadoop servers. Due to proprietary nature of JBOD environment, many internal customers within the organization were unable to take advantage of their Monte Carlo quantitative model, a simulation that relies on the recurring samples of real-time data. The suboptimal ability to understand the effects of uncertainty in market movements was serving unfavorably for the quantitative asset management business unit.

Requirements and challenges

The quantitative business unit at the bank wanted an efficient forecasting method to attain accurate and timely predictions. To do so, the team recognized the need to modernize the infrastructure, reduce existing I/O wait time and improve performance on the analytic applications such as Hadoop and Spark to efficiently simulate investment models, measure potential gains and analyze risks.

Solution

The customer had JBOD for their existing Spark solution. NetApp ONTAP, NetApp StorageGRID, and MinIO Gateway to NFS was then leveraged to reduce the I/O wait time for the bank's quantitative finance group that runs simulation and analysis on investment models that assess potential gains and risks. This image shows the Spark solution with NetApp storage.

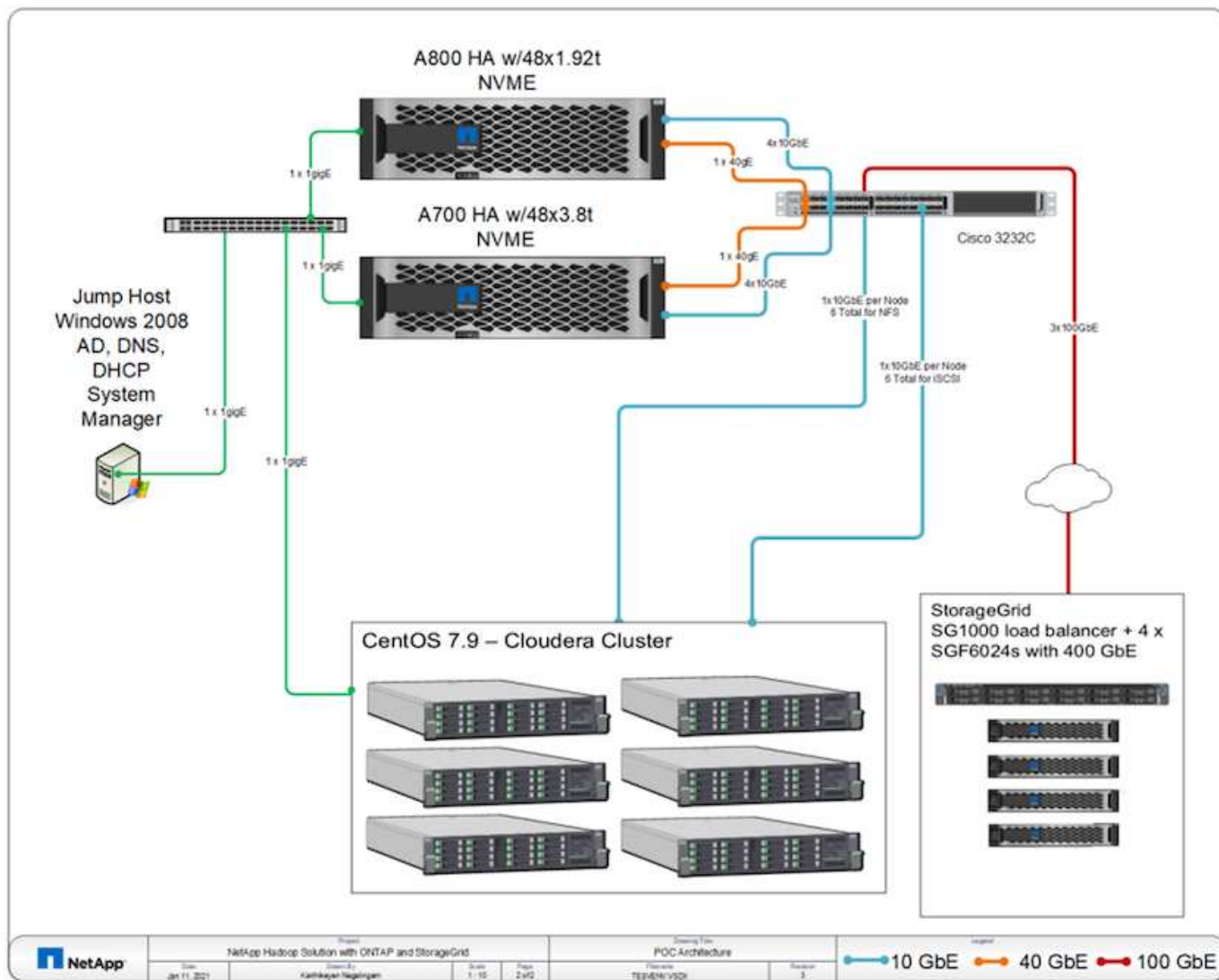

As shown in figure above, AFF A800, A700 systems, and StorageGRID were deployed to access parquet files through NFS and S3 protocols in a six-node Hadoop cluster with Spark, and YARN and Hive metadata services for data analytic operations.

A direct-attached storage (DAS) solution in the customer’s old environment had the disadvantage to scale compute and storage independently. With NetApp ONTAP solution for Spark, the bank’s financial analytics business unit was able to decouple storage from compute and seamlessly bring infrastructure resources more effectively as needed.

By using ONTAP with NFS, the compute server CPUs were almost fully utilized for Spark SQL jobs and the I/O wait time was reduced by nearly 70%, therefore providing better compute power and performance boost to Spark workloads. Subsequently, increasing CPU utilization also enabled the customer to leverage GPUs, such as GPUDirect, for further platform modernization. Additionally, StorageGRID provides a low-cost storage option for Spark workloads and MinIO Gateway provides secure access to NFS data through the S3 protocol. For data in the cloud, NetApp recommends Cloud Volumes ONTAP, Azure NetApp Files, and NetApp Cloud Volumes Service.

Conclusion

This section provides a summary of the use cases and solutions provided by NetApp to fulfill various Hadoop data protection requirements. By using the data fabric powered by

NetApp, customers can:

- Have the flexibility to choose the right data protection solutions by leveraging NetApp's rich data management capabilities and integration with Hadoop native workflows.
- Reduce their Hadoop cluster backup window time by almost 70%.
- Eliminate any performance effect resulting from Hadoop cluster backups.
- Provide multicloud data protection and data access from different cloud providers simultaneously to a single source of analytics data.
- Create fast and space-efficient Hadoop cluster copies by using FlexClone technology.

Where to find additional information

To learn more about the information described in this document, see the following documents and/or websites:

- NetApp Big Data Analytics Solutions

<https://www.netapp.com/us/solutions/applications/big-data-analytics/index.aspx>

- Apache Spark Workload with NetApp Storage

<https://www.netapp.com/pdf.html?item=/media/26877-nva-1157-deploy.pdf>

- NetApp Storage Solutions for Apache Spark

<https://www.netapp.com/media/16864-tr-4570.pdf>

- Apache Hadoop on data fabric enabled by NetApp

<https://www.netapp.com/media/16877-tr-4529.pdf>

Acknowledgements

- Paul Burland, Sales Rep, ANZ Victoria District Sales, NetApp
- Hoseb Dermanilian, Business Development Manager, NetApp
- Lee Dorrier, Director MPSG, NetApp
- David Thiessen, Systems Engineer, ANZ Victoria District SE, NetApp

Version history

Version	Date	Document version history
Version 1.0	January 2018	Initial release
Version 2.0	October 2021	Updated with use case #5: Accelerate analytic workload
Version 3.0	November 2023	Removed NIPAM details

Copyright information

Copyright © 2024 NetApp, Inc. All Rights Reserved. Printed in the U.S. No part of this document covered by copyright may be reproduced in any form or by any means—graphic, electronic, or mechanical, including photocopying, recording, taping, or storage in an electronic retrieval system—without prior written permission of the copyright owner.

Software derived from copyrighted NetApp material is subject to the following license and disclaimer:

THIS SOFTWARE IS PROVIDED BY NETAPP "AS IS" AND WITHOUT ANY EXPRESS OR IMPLIED WARRANTIES, INCLUDING, BUT NOT LIMITED TO, THE IMPLIED WARRANTIES OF MERCHANTABILITY AND FITNESS FOR A PARTICULAR PURPOSE, WHICH ARE HEREBY DISCLAIMED. IN NO EVENT SHALL NETAPP BE LIABLE FOR ANY DIRECT, INDIRECT, INCIDENTAL, SPECIAL, EXEMPLARY, OR CONSEQUENTIAL DAMAGES (INCLUDING, BUT NOT LIMITED TO, PROCUREMENT OF SUBSTITUTE GOODS OR SERVICES; LOSS OF USE, DATA, OR PROFITS; OR BUSINESS INTERRUPTION) HOWEVER CAUSED AND ON ANY THEORY OF LIABILITY, WHETHER IN CONTRACT, STRICT LIABILITY, OR TORT (INCLUDING NEGLIGENCE OR OTHERWISE) ARISING IN ANY WAY OUT OF THE USE OF THIS SOFTWARE, EVEN IF ADVISED OF THE POSSIBILITY OF SUCH DAMAGE.

NetApp reserves the right to change any products described herein at any time, and without notice. NetApp assumes no responsibility or liability arising from the use of products described herein, except as expressly agreed to in writing by NetApp. The use or purchase of this product does not convey a license under any patent rights, trademark rights, or any other intellectual property rights of NetApp.

The product described in this manual may be protected by one or more U.S. patents, foreign patents, or pending applications.

LIMITED RIGHTS LEGEND: Use, duplication, or disclosure by the government is subject to restrictions as set forth in subparagraph (b)(3) of the Rights in Technical Data -Noncommercial Items at DFARS 252.227-7013 (FEB 2014) and FAR 52.227-19 (DEC 2007).

Data contained herein pertains to a commercial product and/or commercial service (as defined in FAR 2.101) and is proprietary to NetApp, Inc. All NetApp technical data and computer software provided under this Agreement is commercial in nature and developed solely at private expense. The U.S. Government has a non-exclusive, non-transferrable, nonsublicensable, worldwide, limited irrevocable license to use the Data only in connection with and in support of the U.S. Government contract under which the Data was delivered. Except as provided herein, the Data may not be used, disclosed, reproduced, modified, performed, or displayed without the prior written approval of NetApp, Inc. United States Government license rights for the Department of Defense are limited to those rights identified in DFARS clause 252.227-7015(b) (FEB 2014).

Trademark information

NETAPP, the NETAPP logo, and the marks listed at <http://www.netapp.com/TM> are trademarks of NetApp, Inc. Other company and product names may be trademarks of their respective owners.